

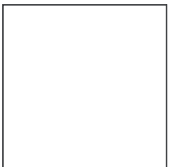

Booklet available in English on
Heft in deutscher Sprache erhältlich auf
Livret disponible en français sur
Libretto disponibile in italiano su
Folleto en español disponible en
如需中文版手册, 请访问





FR

**DONNEZ
OU
RECYCLEZ**



ASSOCIATION
OU



MAGASIN
OU



DÉCHÈTERIE

Adresses sur quefairedemesdechets.fr



LEGO.com/sustainable-packaging

LEGO® VIP

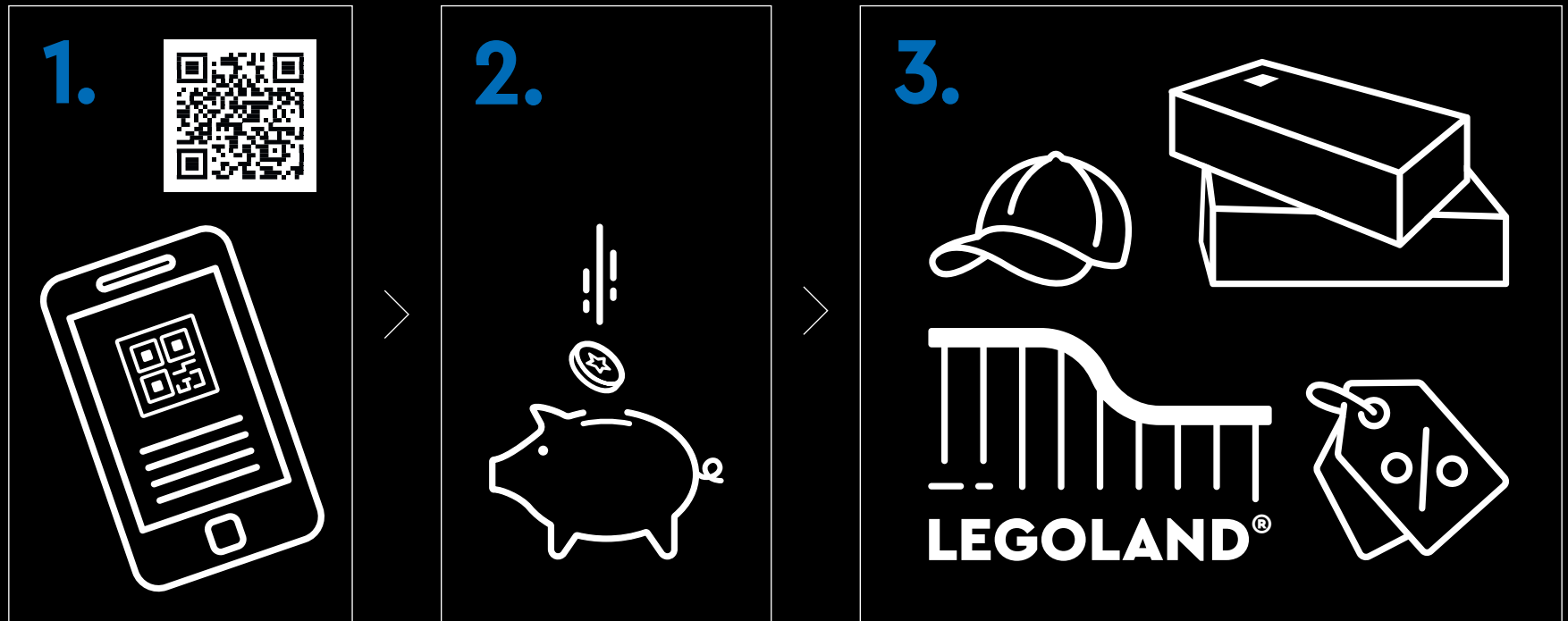

1. Sign up **2.** Earn points for purchases **3.** Redeem points for rewards, experiences, discounts & more | **1.** Melde dich an **2.** Sammle Punkte bei jedem Kauf **3.** Löse die Punkte für Belohnungen, Erlebnisse, Rabatte und Ähnliches ein | **1.** Inscrivez-vous **2.** Gagnez des points lors de vos achats **3.** Échangez vos points contre des récompenses, des expériences, des remises et bien plus encore | **1.** Iscriviti **2.** Guadagna punti con i tuoi acquisti **3.** Riscatta punti per premi, esperienze, sconti e altro ancora | **1.** Regístrate **2.** Gana puntos por tus compras **3.** Canjea puntos por recompensas, experiencias, descuentos y mucho más | **1.** Registe-se **2.** Ganhe pontos em compras **3.** Troque os pontos para prémios, experiências, descontos e muito mais | **1.** 注册 **2.** 购物赚积分 **3.** 用积分兑换奖励、体验、折扣等 | **1.** Zarejestruj się **2.** Zdobywaj punkty za zakupy **3.** Wymieniaj punkty na rabaty, przygody i inne nagrody | **1.** Zaregistrujte se **2.** Sbírejte body za nákupy **3.** Vyměňujte body za odměny, zážitky, slevy a spoustu dalšího | **1.** Zaregistrujte se **2.** Získavajte body za nákupy **3.** Uplatnite si body a získajte odmeny, rôzne zážitky, zľavy a ešte viac | **1.** Regisztrálj **2.** Szerez pontokat minden vásárlással **3.** Váltsd be pontjaidat jutalmakra, élményekre, kedvezményekre és egyebekre | **1.** Înscrite-te **2.** Câștigă puncte pentru achiziții **3.** Valorifică puncte pentru recompense, experiențe, reduceri și multe altele | **1.** Регистрируйте се **2.** Получайте точки за покупки **3.** Используйте точки за награды, услуги, отстъпки и т.н. | **1.** Reģistrējies **2.** Pelni punktus par pirkumiem **3.** Izmanto punktus, lai saņemtu balvas, izklaides iespējas, atlaides un daudz ko citu | **1.** Registreeru **2.** Teeni ostude eest punkte **3.** Lunasta punktide eest preemiad, elamused, allahindlused ja muu | **1.** Užsiregistruokite **2.** Pelnykite taškus už pirkinius **3.** Panaudokite taškus atlygiui, funkcijoms, nuolaidoms ir ne tik





TO THE FIRST AVENGER

Fighting dictators and Hydra villains on earth and in space may have defined Steve Rogers as Captain America but he embodied the title all along. From the skinny boy with a big heart to the first Avenger in the Infinity Saga, Rogers' journey, from humble roots in WWII-era Brooklyn, New York to saving the universe (actually, several) from Thanos decades later, would have looked dramatically different without his sturdy shield.

'I can do this all day.' – Steve Rogers (Captain America)



A STARK INVENTION

'Vibranium. It's stronger than steel and a third of the weight. It's completely vibration absorbent.' Howard Stark's one-of-a-kind shield prototype catches Rogers' attention during a walkthrough of Stark's combat equipment facilities. After an impromptu test involving Agent Peggy Carter, Rogers sees its potential. Forged from the rarest metal on earth, the shield is virtually indestructible. Its inherent strength and flexibility double as a forceful source of protection and a versatile combat weapon. For *Captain America: The First Avenger*, three model variants were created for various uses in the film. A stunt version made of synthetic rubber, a costume version made of aluminium and fibreglass, and an aluminium version for close-up shots.

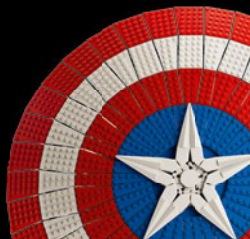

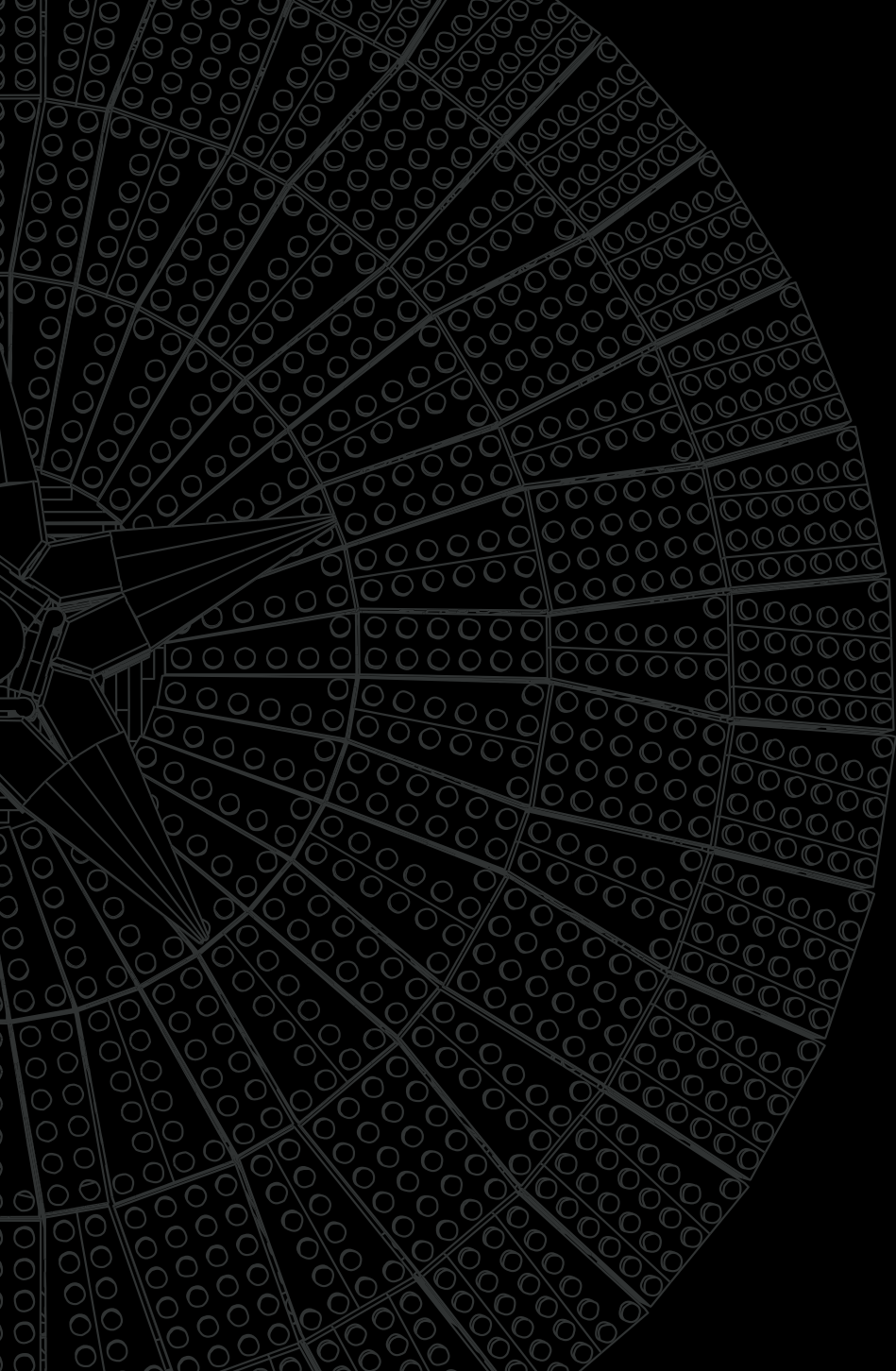

PUSHING THE LEGO® LIMITS

'Captain America's shield has been on our LEGO® Marvel wish list for a long time. Testing our skills, exploring new possibilities and pushing the limits of what we can do, within the LEGO System, fits so well with the Captain America character. For a Marvel fan, it's like building the Holy Grail – you really want to get it right, but it just seemed like an impossible task. Previous sketch models came close but still fell a bit short of what we wanted to achieve. Well, "Cap" has never let "impossible" stop him, so in that spirit, I started listing and drawing all the solutions I could imagine.'

BEING CREATIVE WITH WHAT'S AVAILABLE

It took some unconventional thinking and techniques to turn mostly square and angled LEGO® bricks into a clean, round and curved design. The underlying structure had to be rigid yet lightweight and the building experience intuitive and interesting. And we only wanted to use elements that already existed in the LEGO System, so fans can enjoy the feeling that they could have designed this, too.



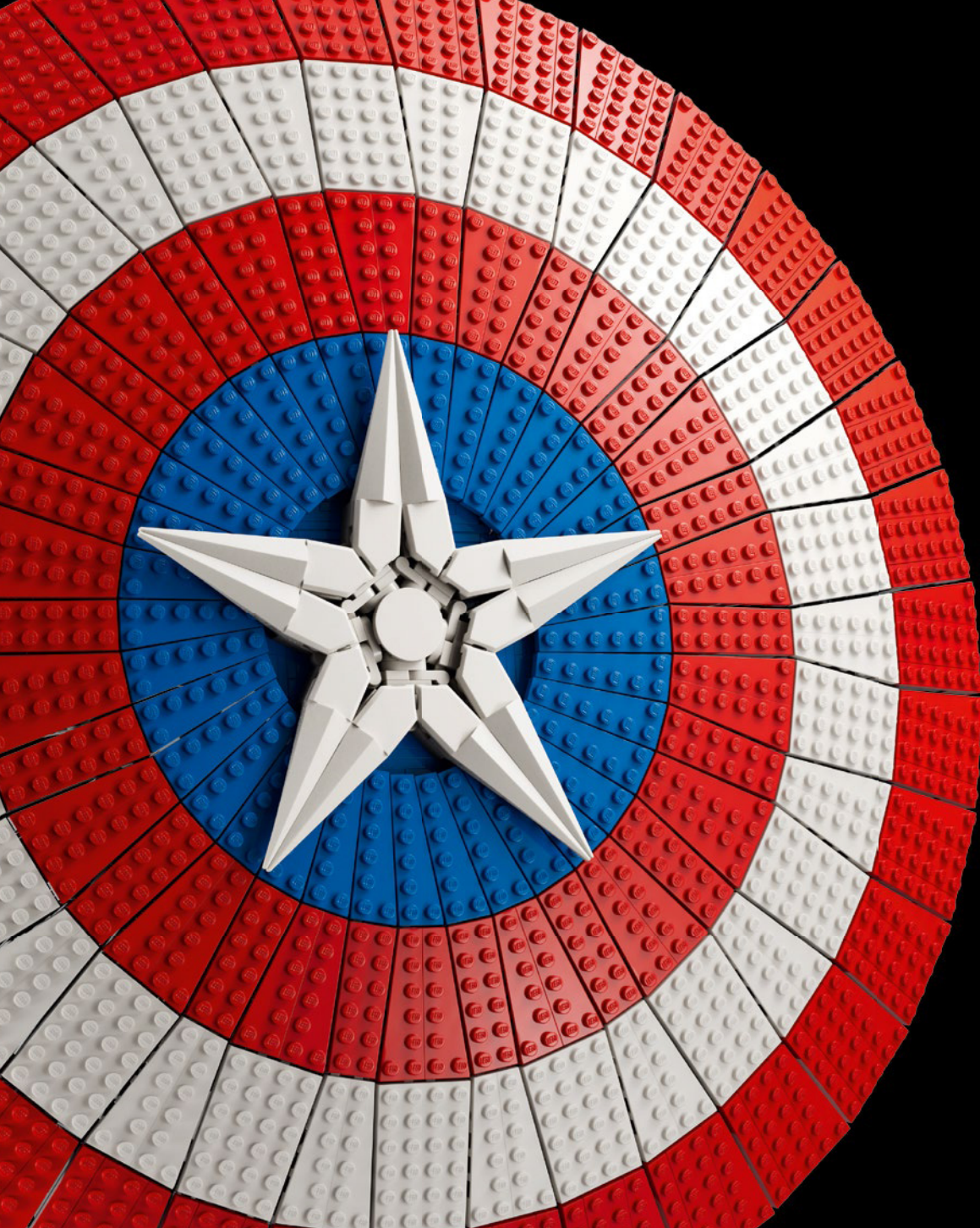

BUILDING OUTSIDE THE GRID

To explore the capabilities of the LEGO® system, we used engineering principles to calculate how the different parts could fit together legally. Odd angles or stretched compositions can stress the elements, so everything must fit the way the system is meant to be used to create a solid and durable design. The top cover plates must line up perfectly next to each other with the exact same gap in between the plates all the way around to obtain the iconic shape of the shield. The solution we ended up using ticks all those boxes and fits the tolerance of the elements.



'I'M... CAPTAIN AMERICA.'

'The star in the centre completes the design inspired by the American flag. The star aligns with the border of the blue area in the middle, and we must have tested hundreds of combinations to get it right! Everything needs to play together to match the proportions and iconic feel of the shield. So, whichever Captain America you aspire to be, we hope you'll enjoy the experience.'

- Mathias Julin, LEGO® Model Designer

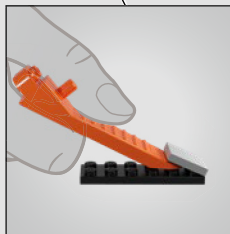
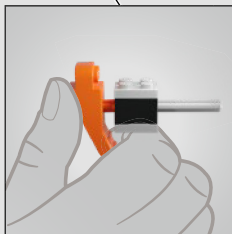
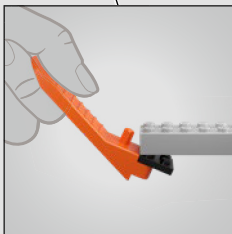
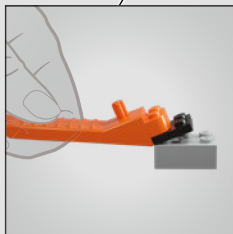
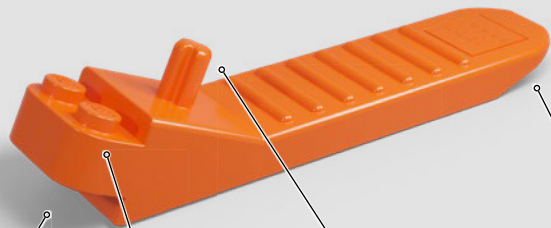

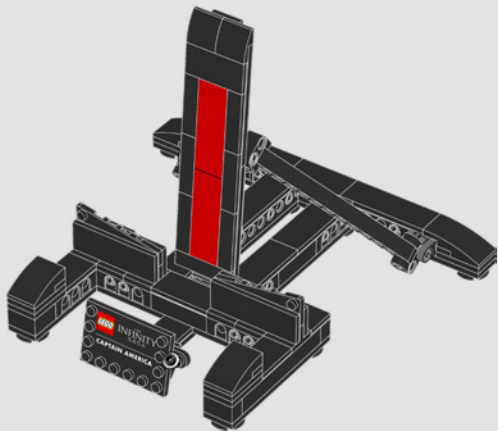
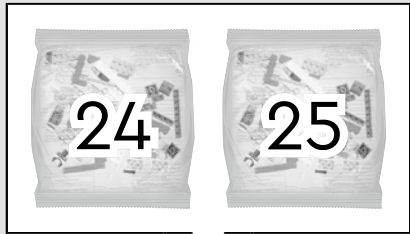
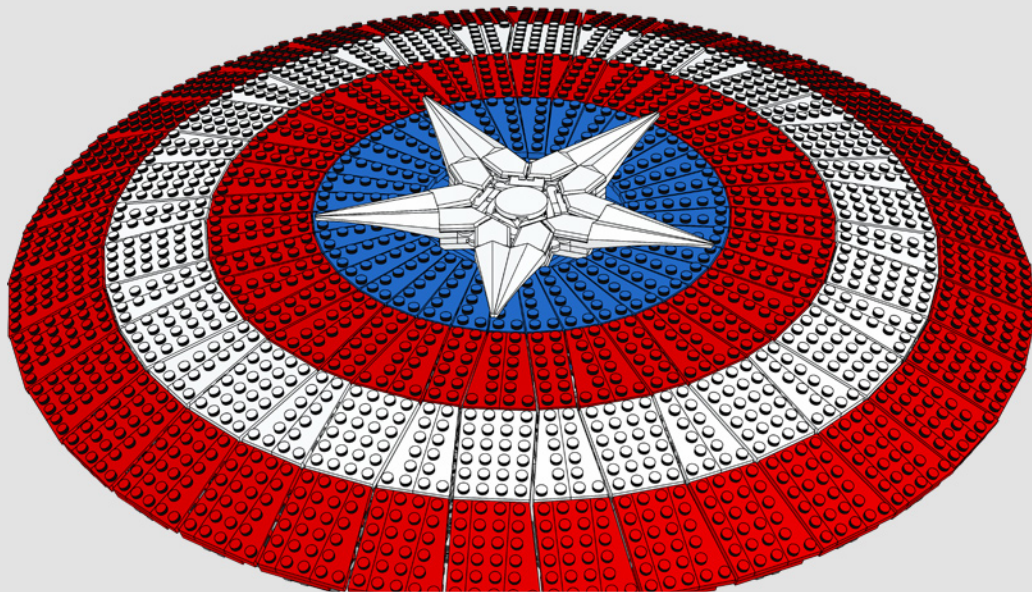
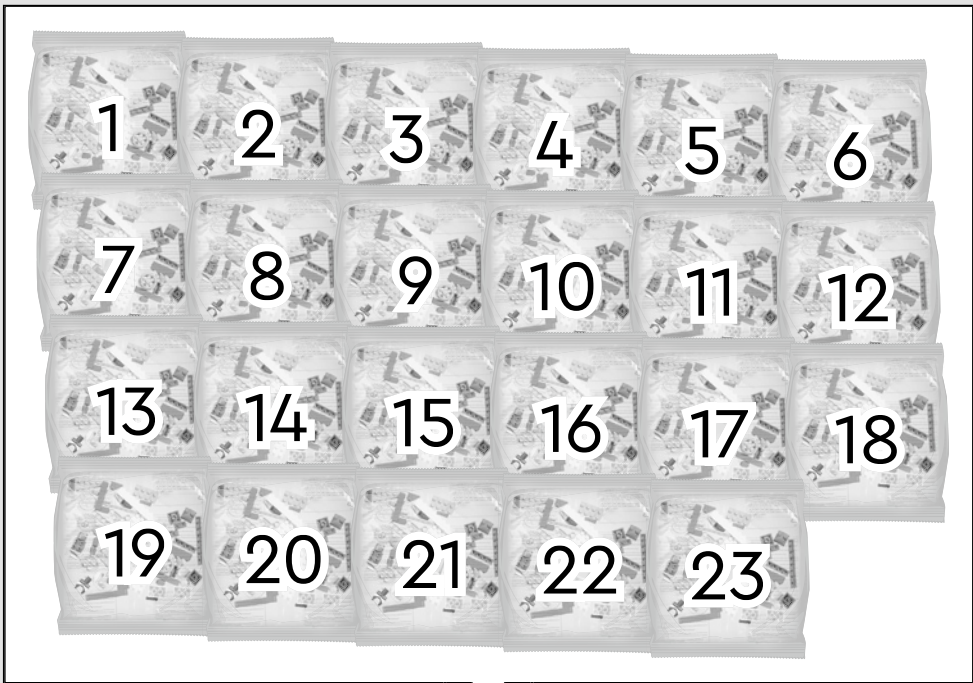

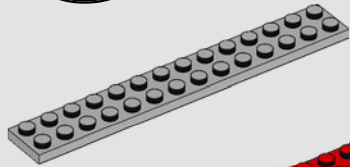
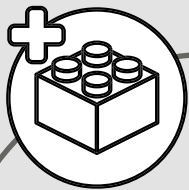

35x

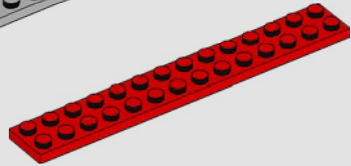

1x

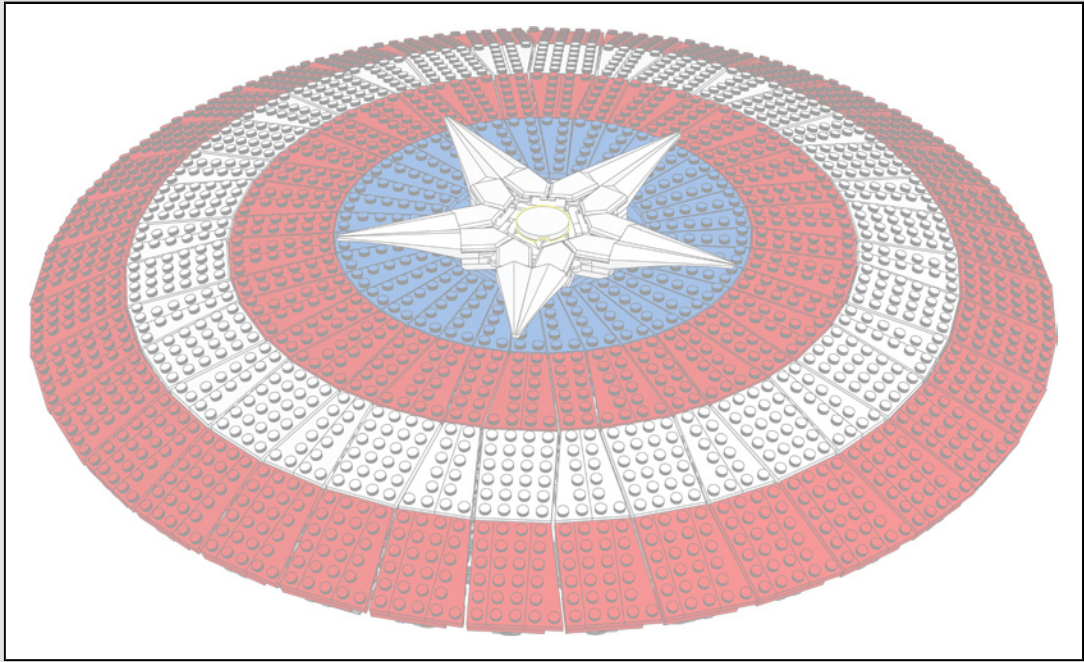
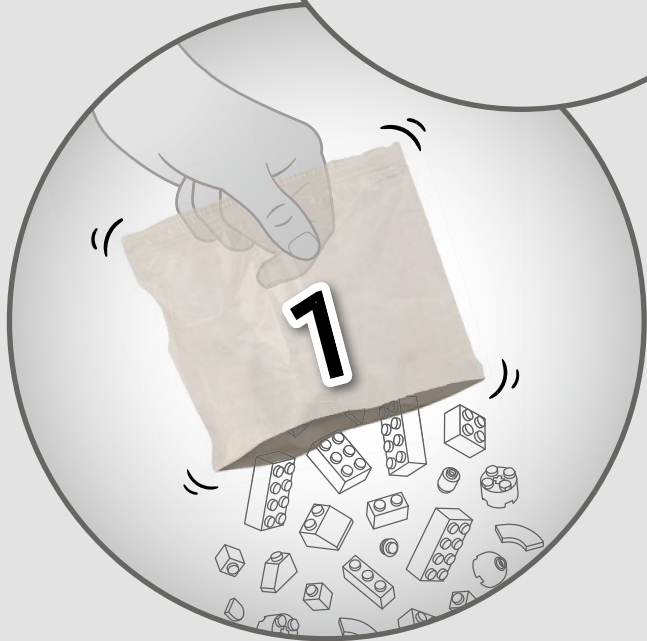

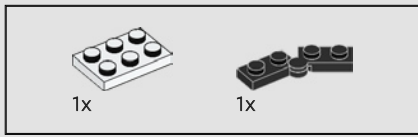

1

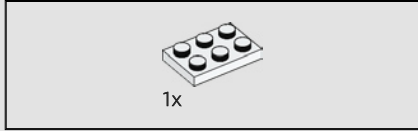
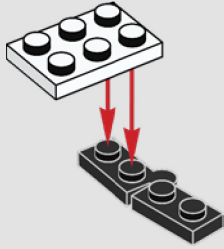

2

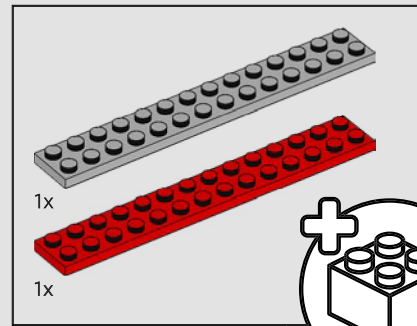
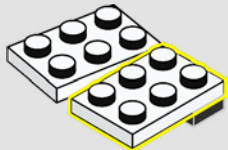

3

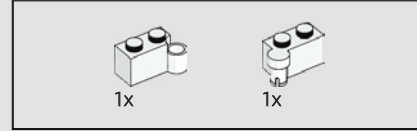
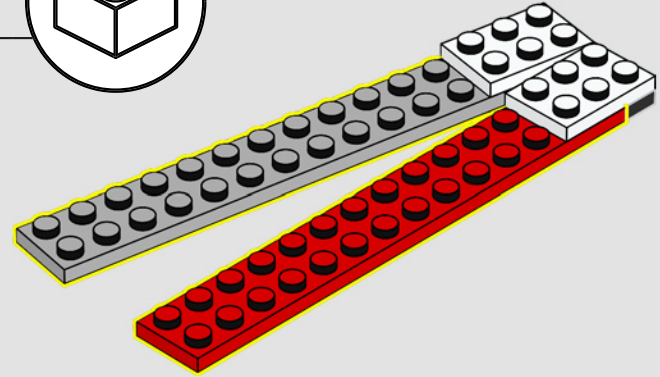
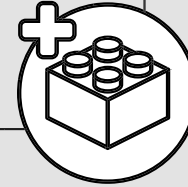

4

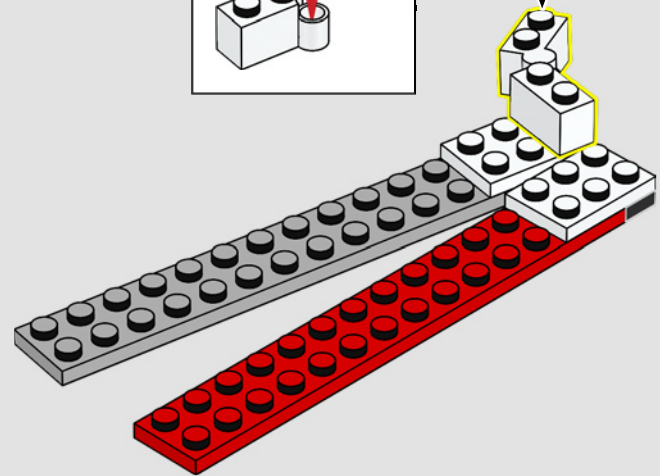
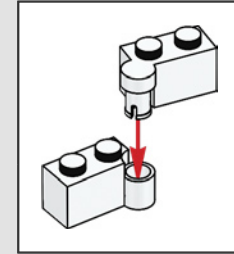

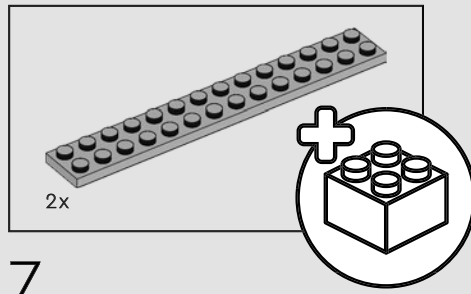
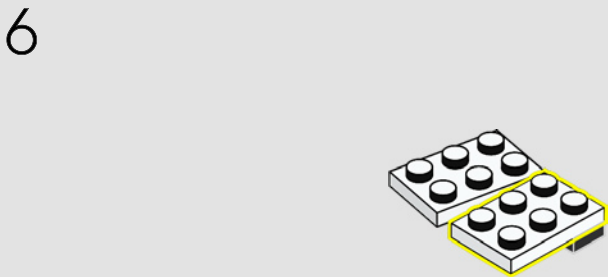
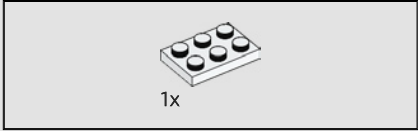
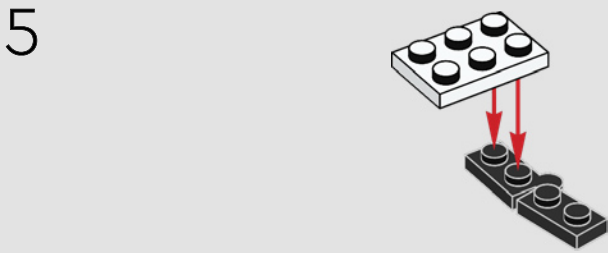
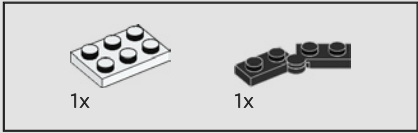
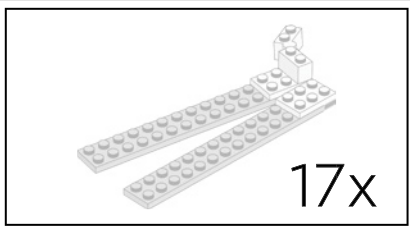

7

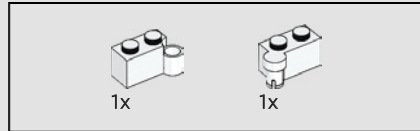
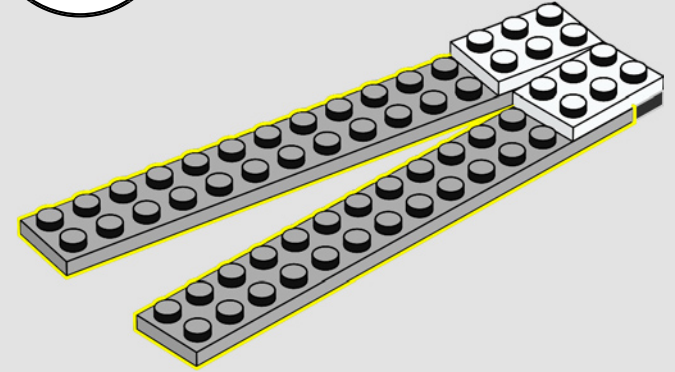

8

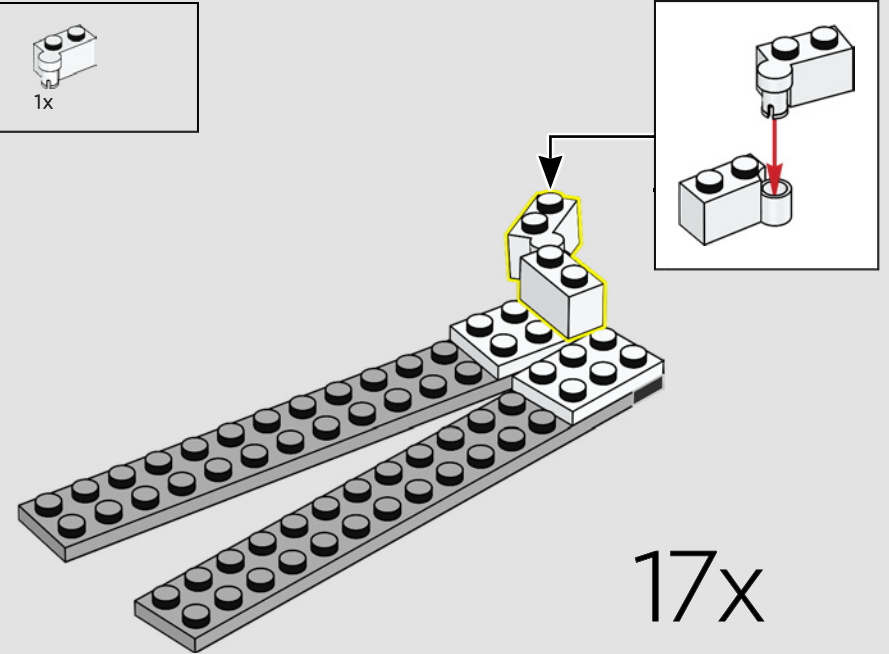

17x



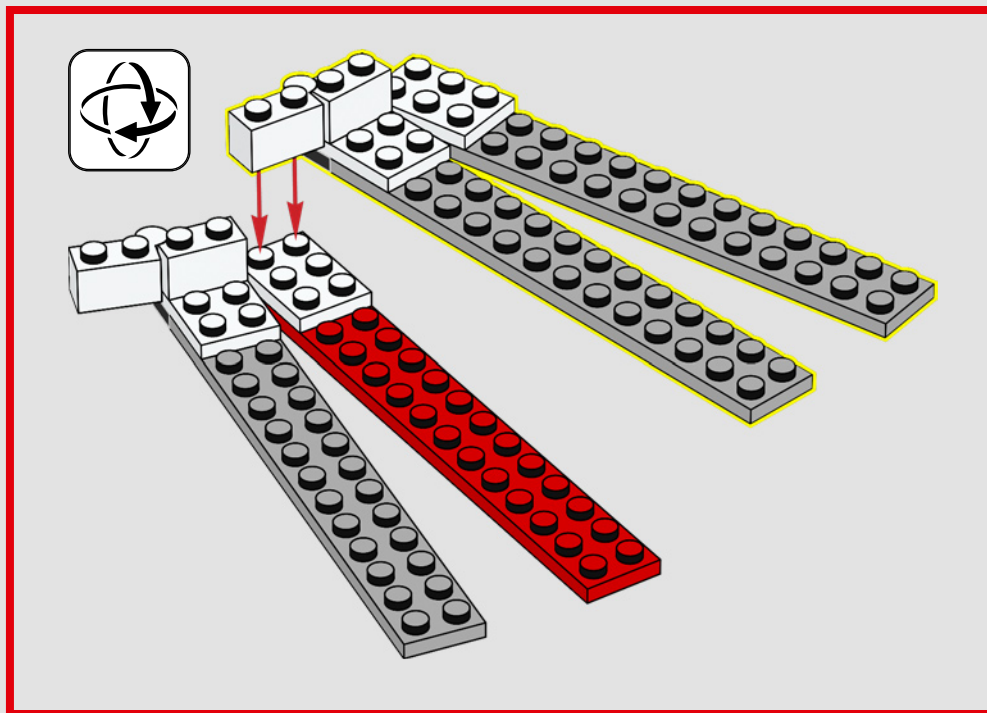

9

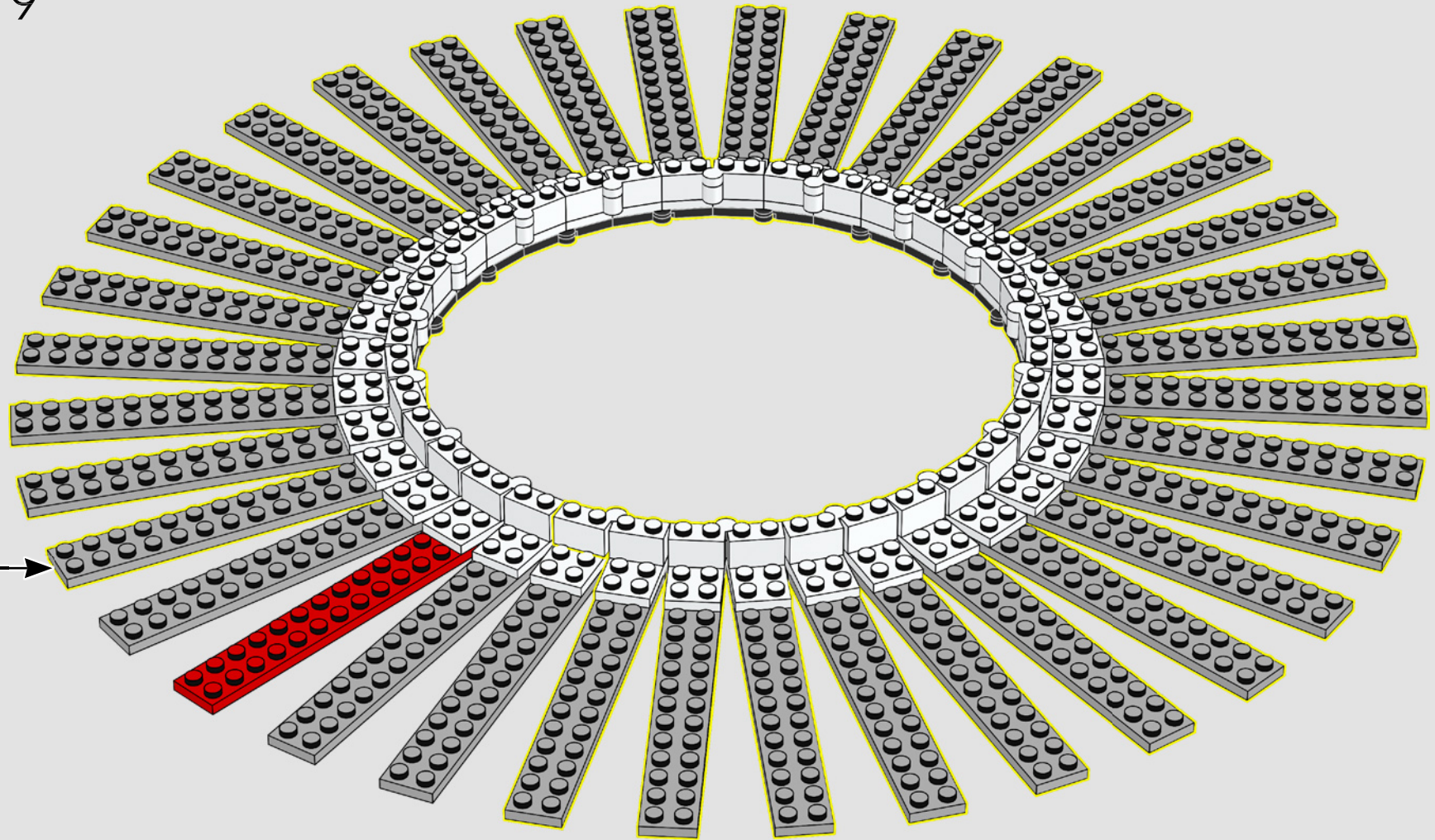

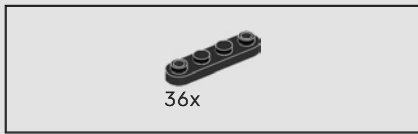

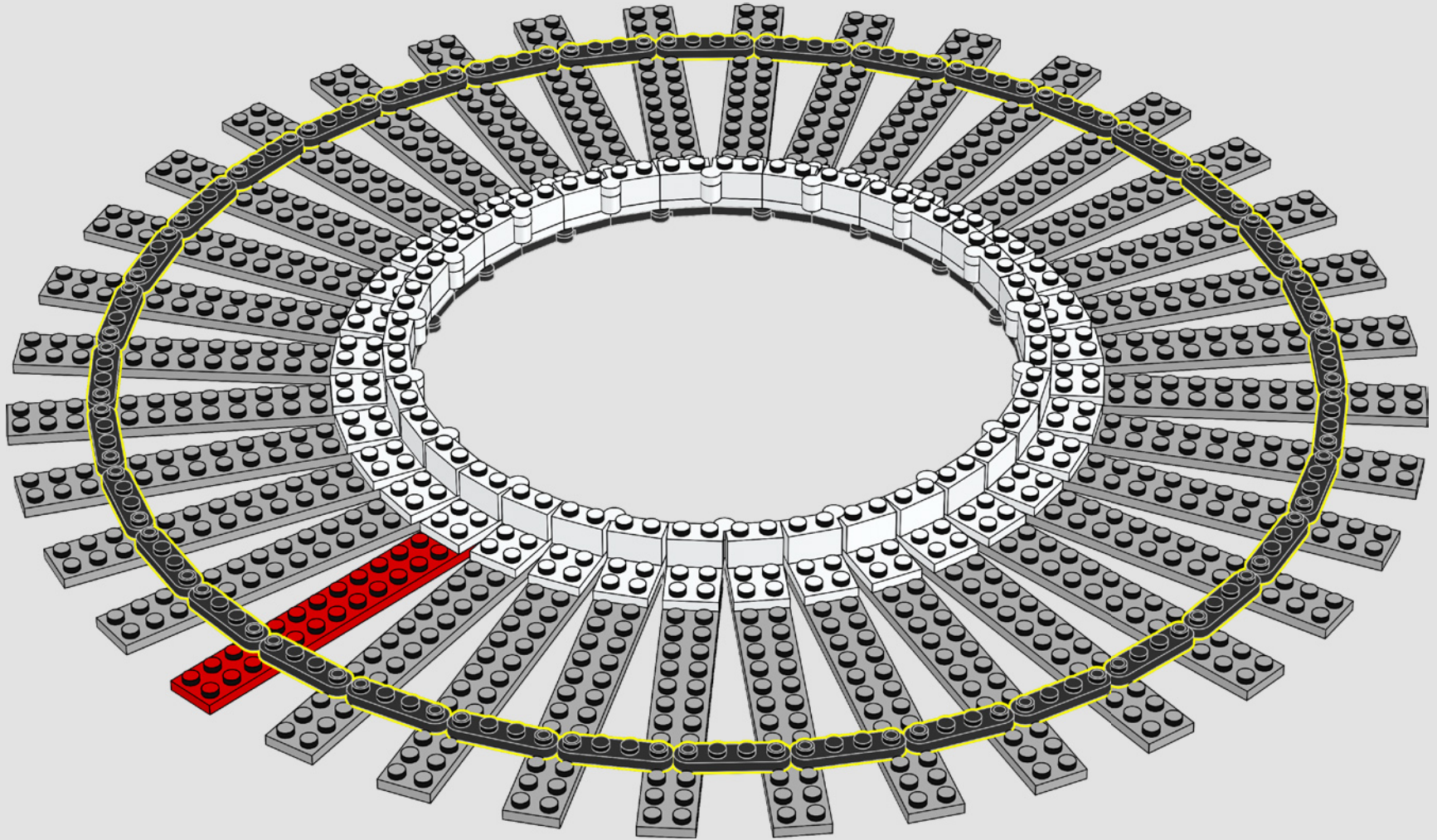

10





 36x

 36x  72x

11



36x



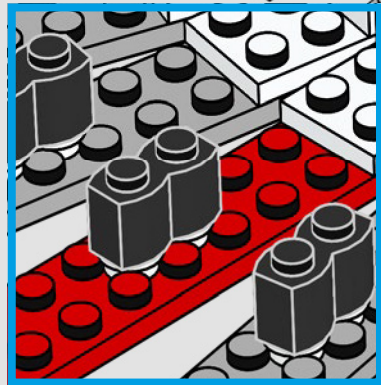
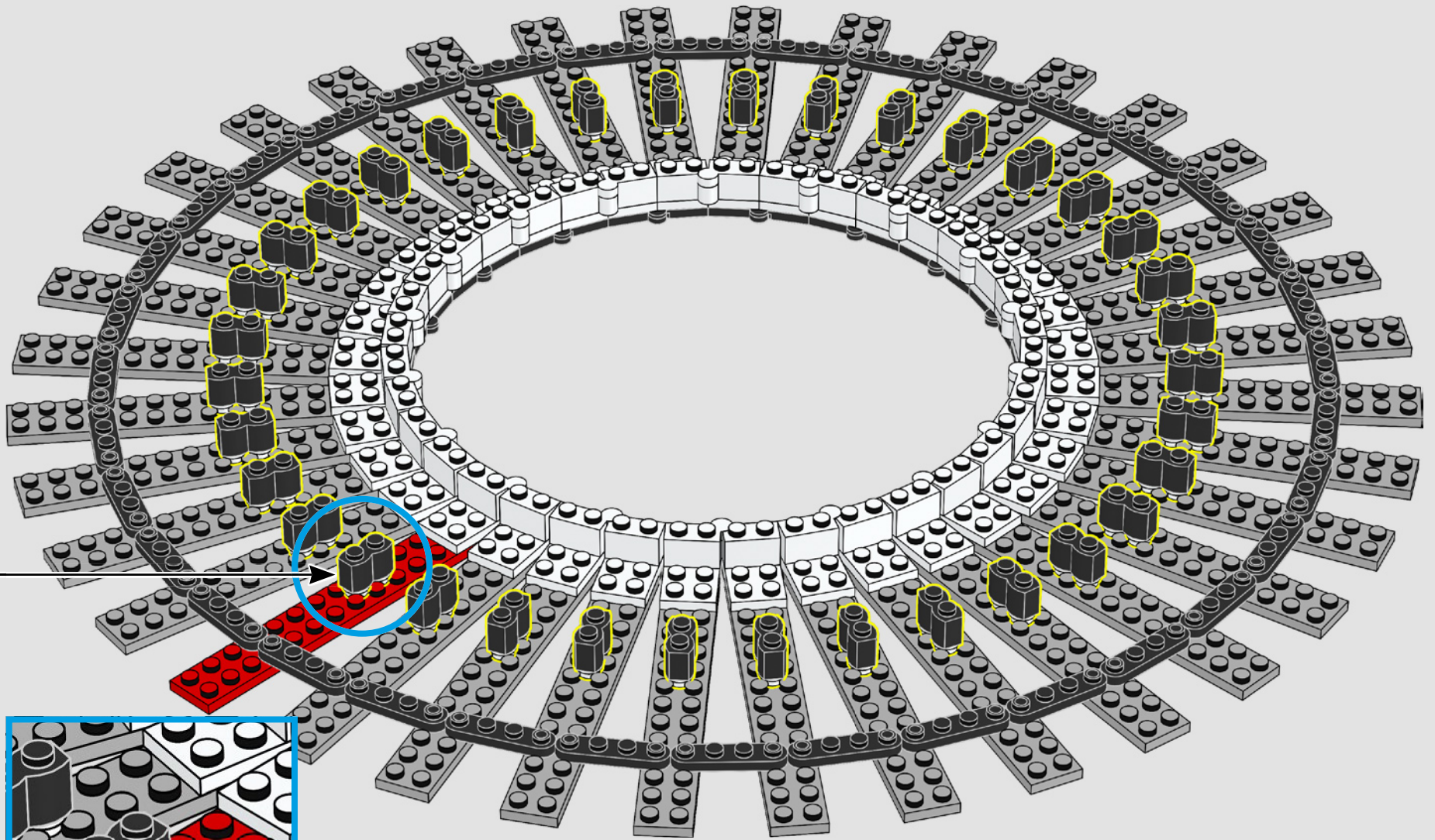







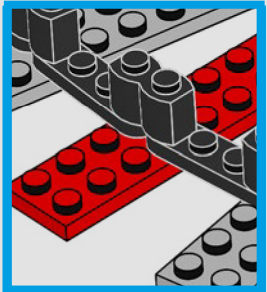
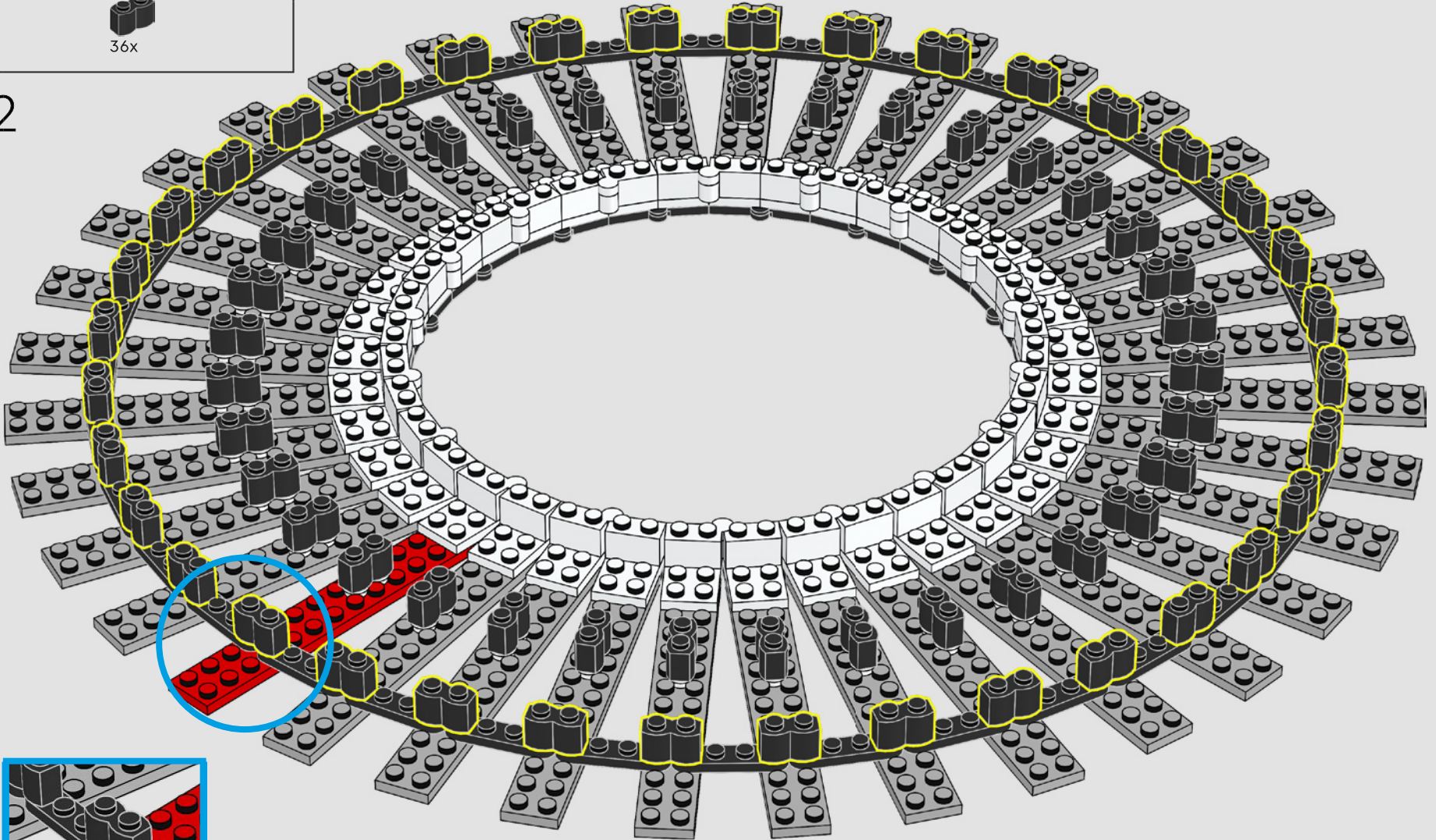

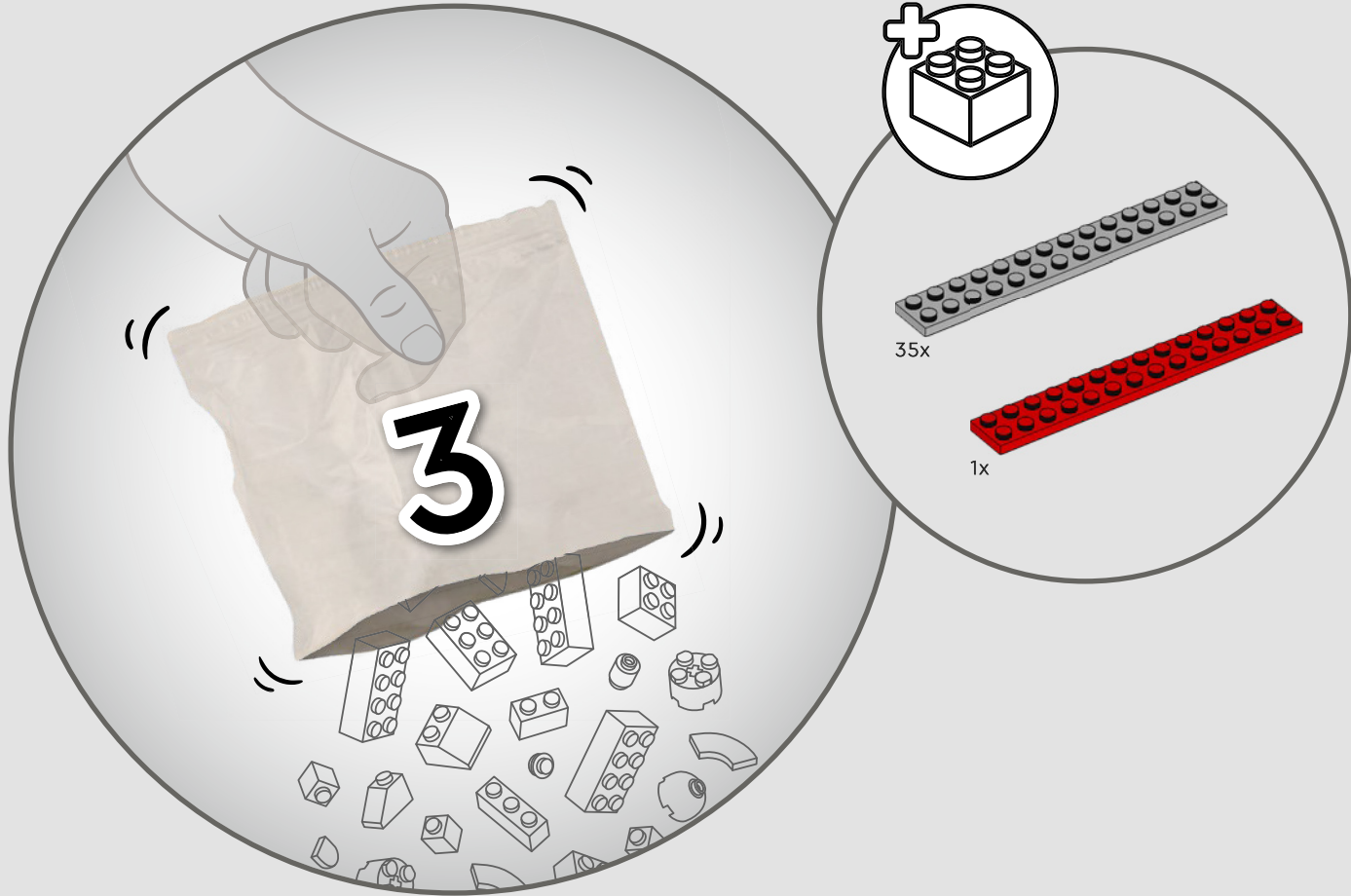
36x

12





 36x

 36x  36x  72x
 36x  36x

13

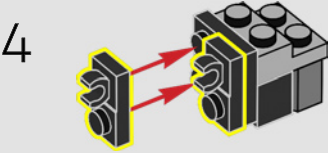
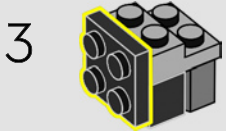
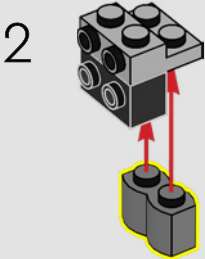
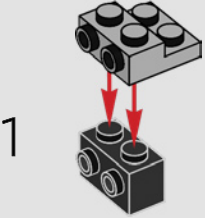

36x



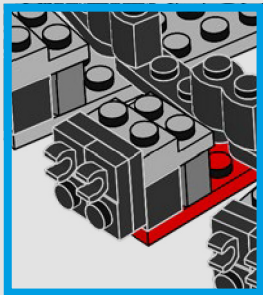
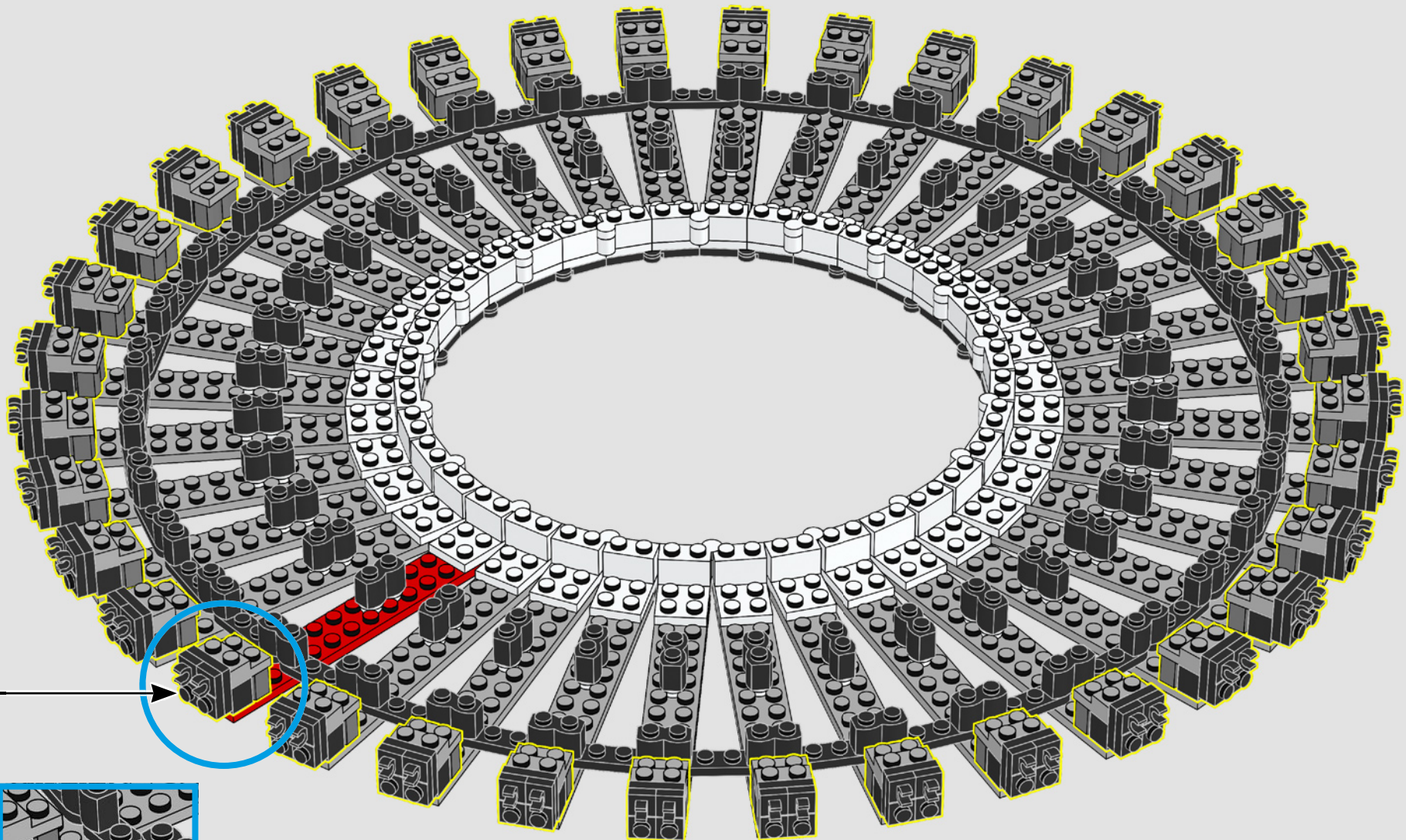

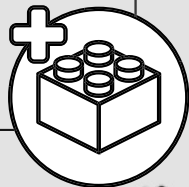
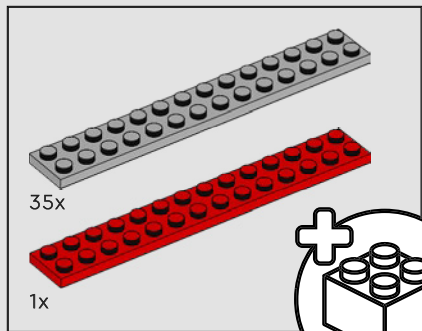

14

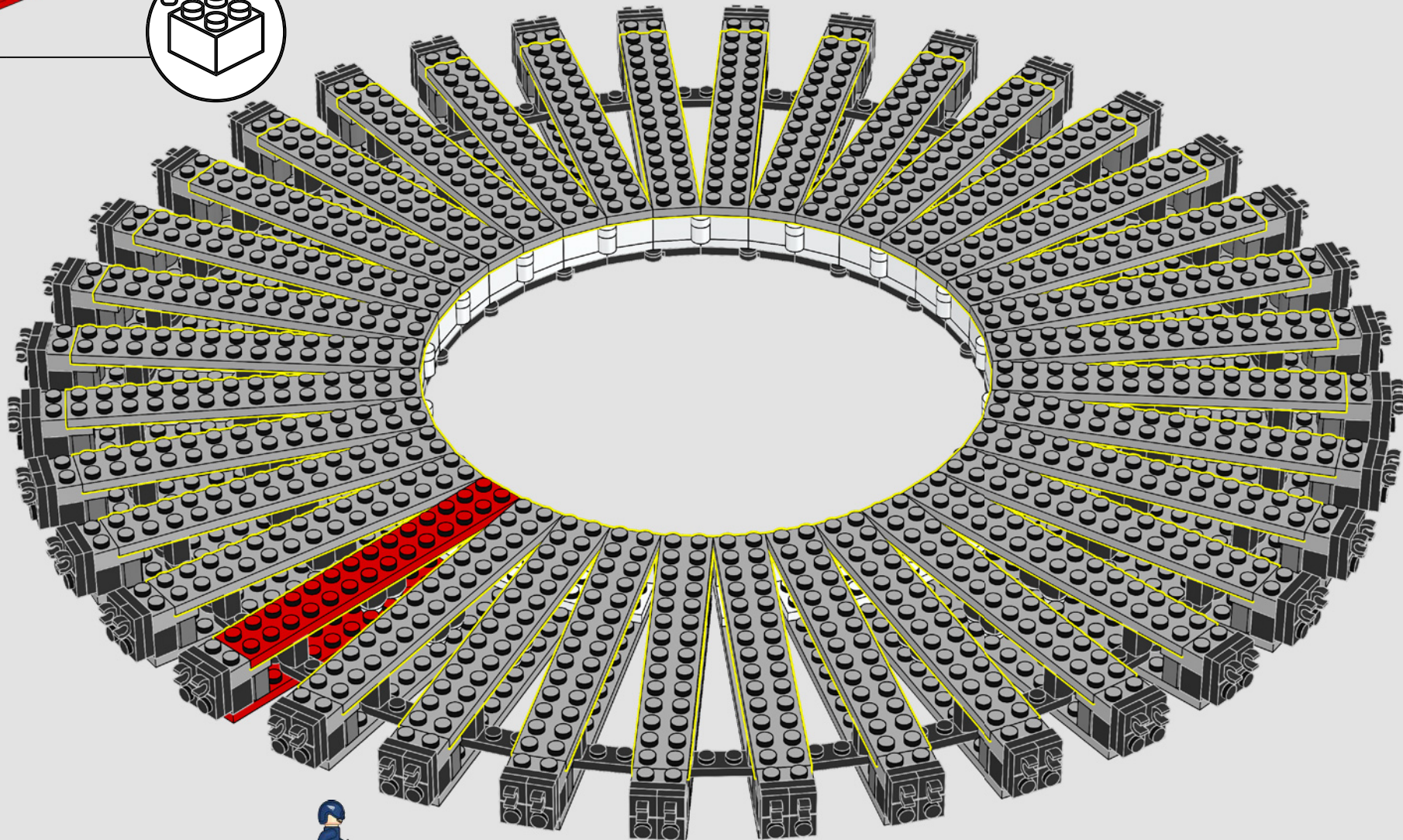



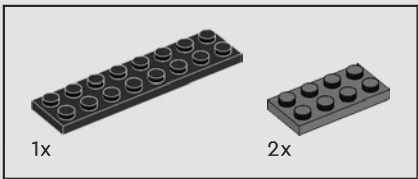

15

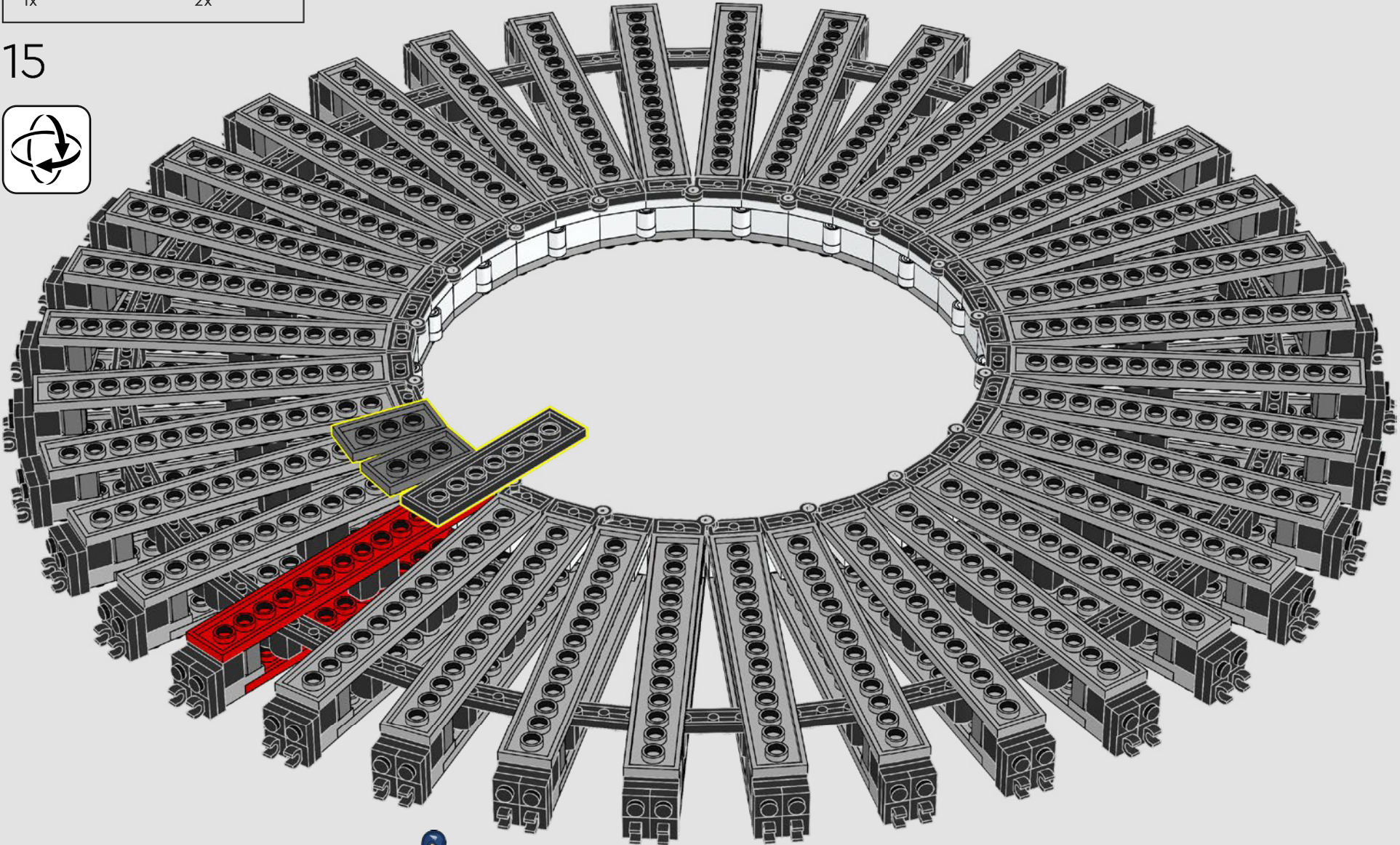

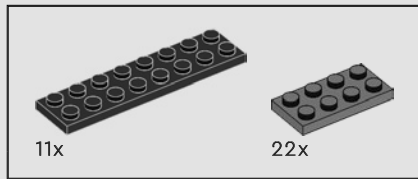

16

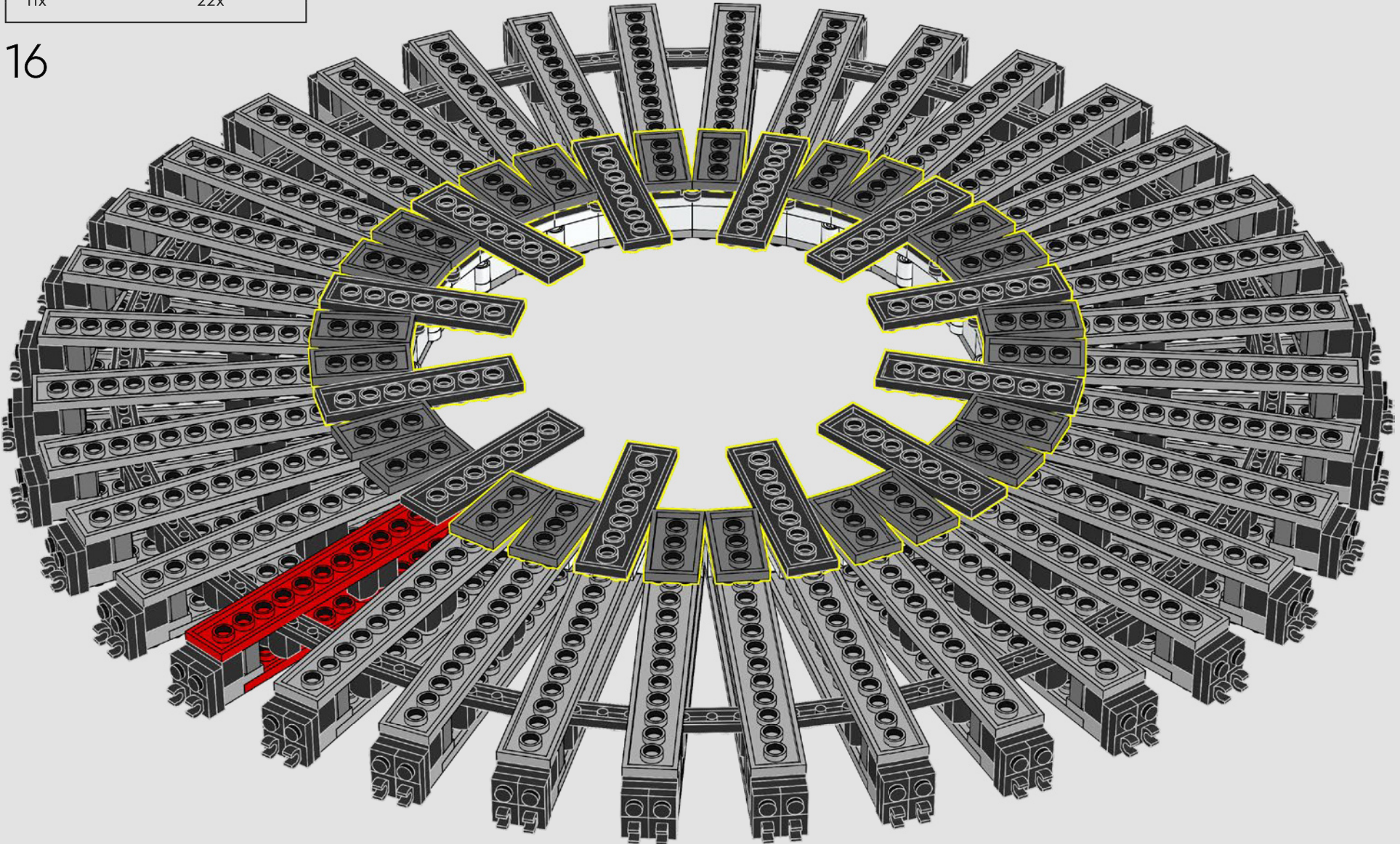

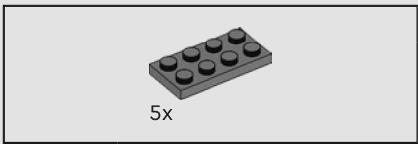

17

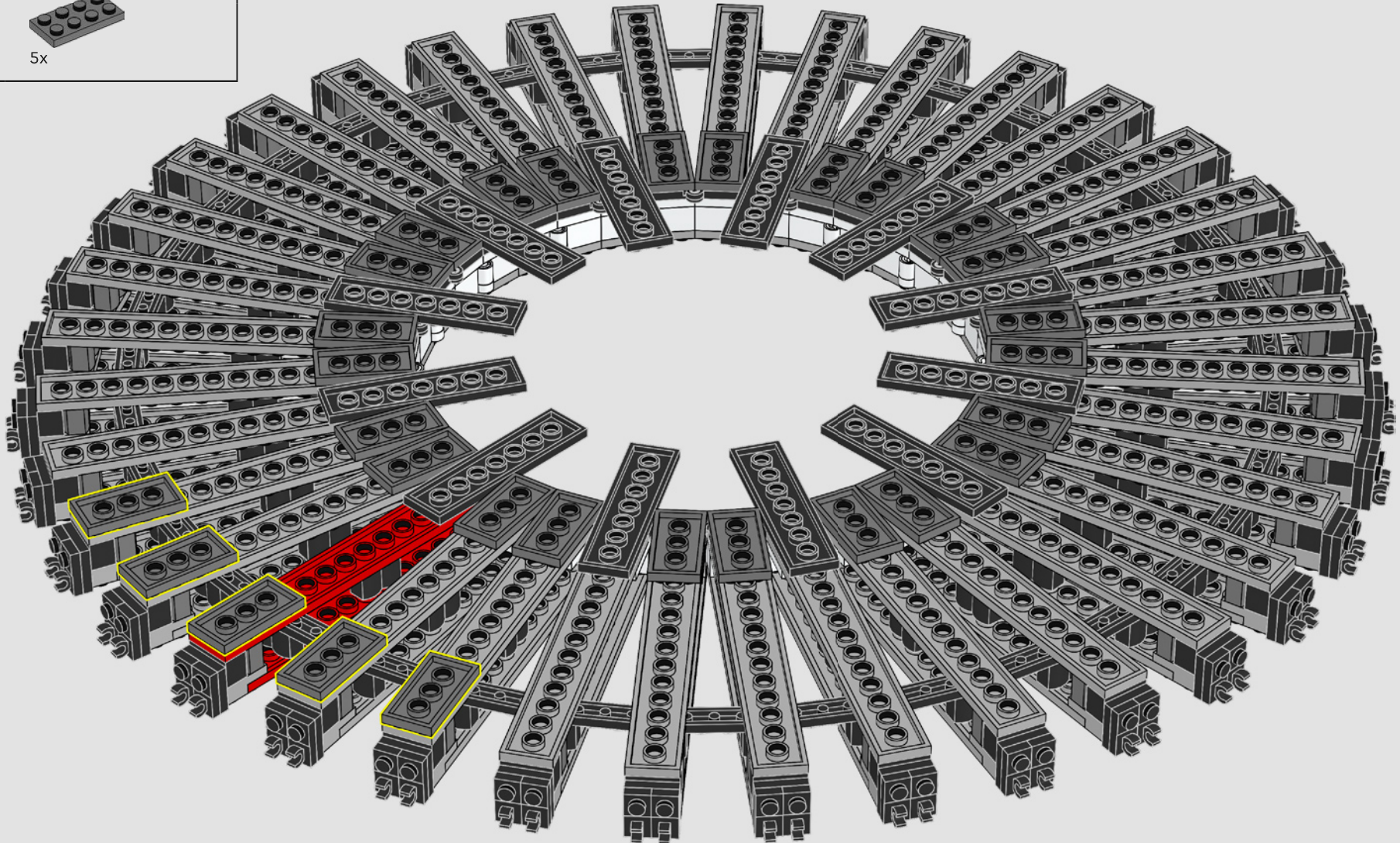

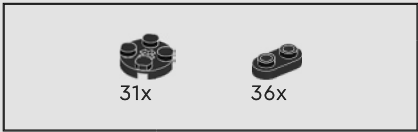

18

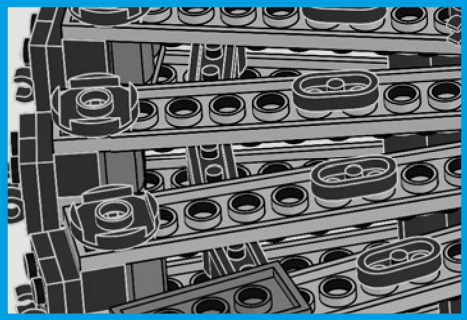
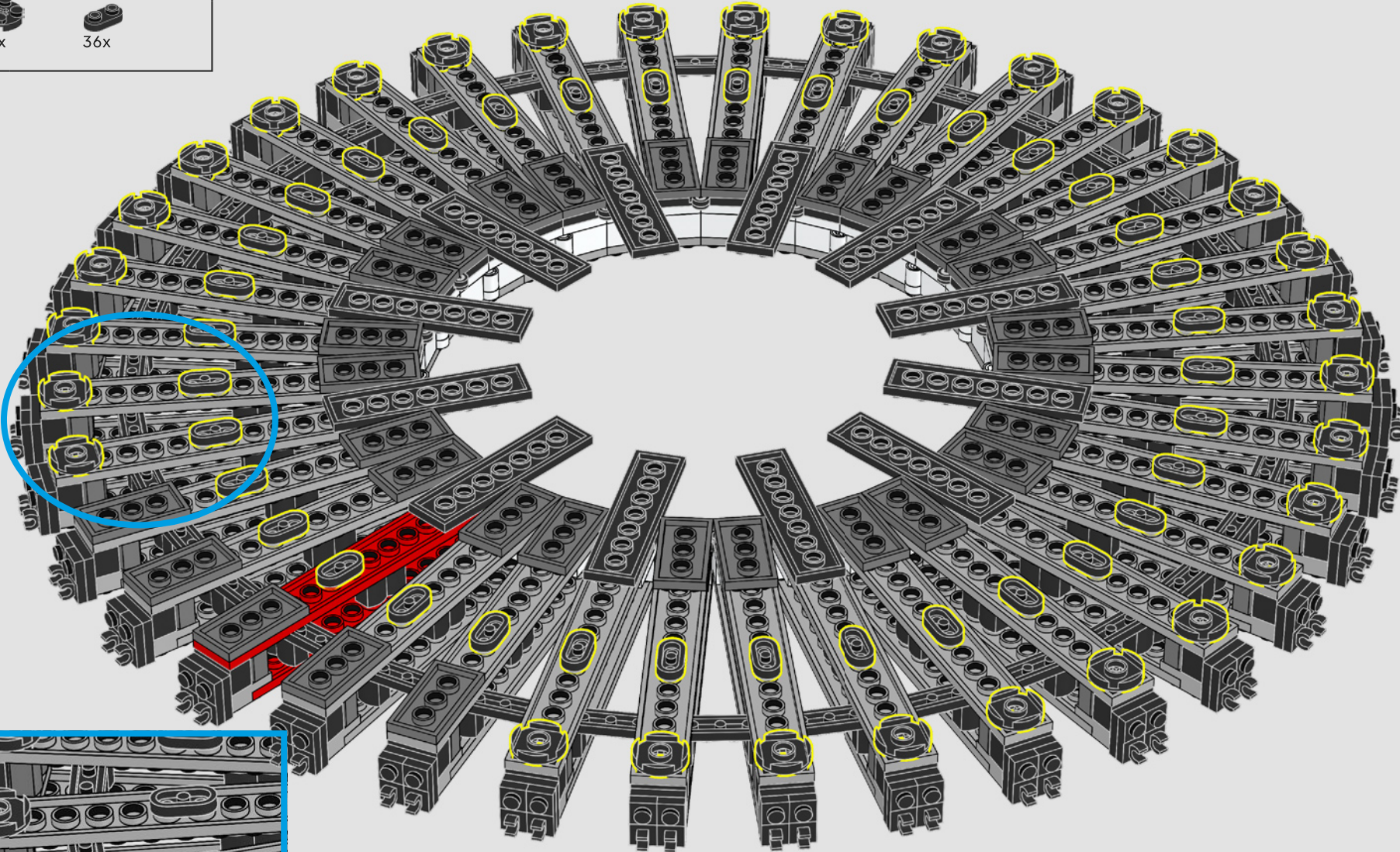



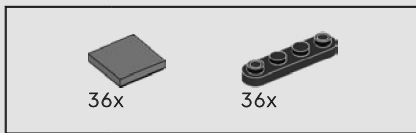

19

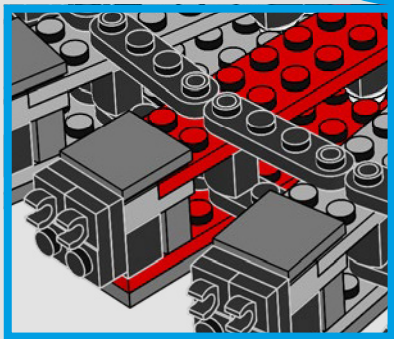
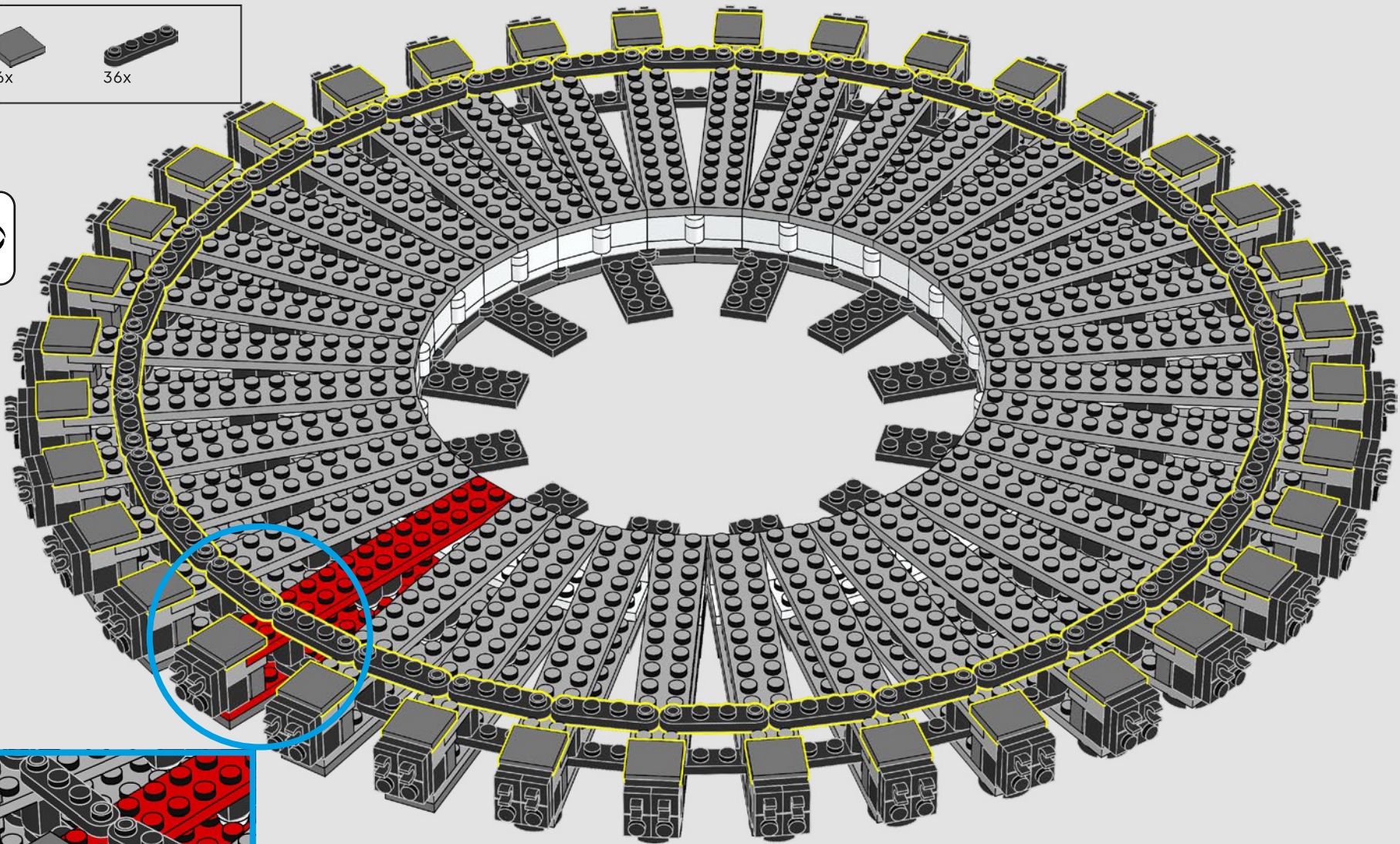



20

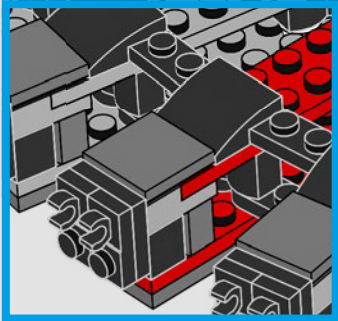
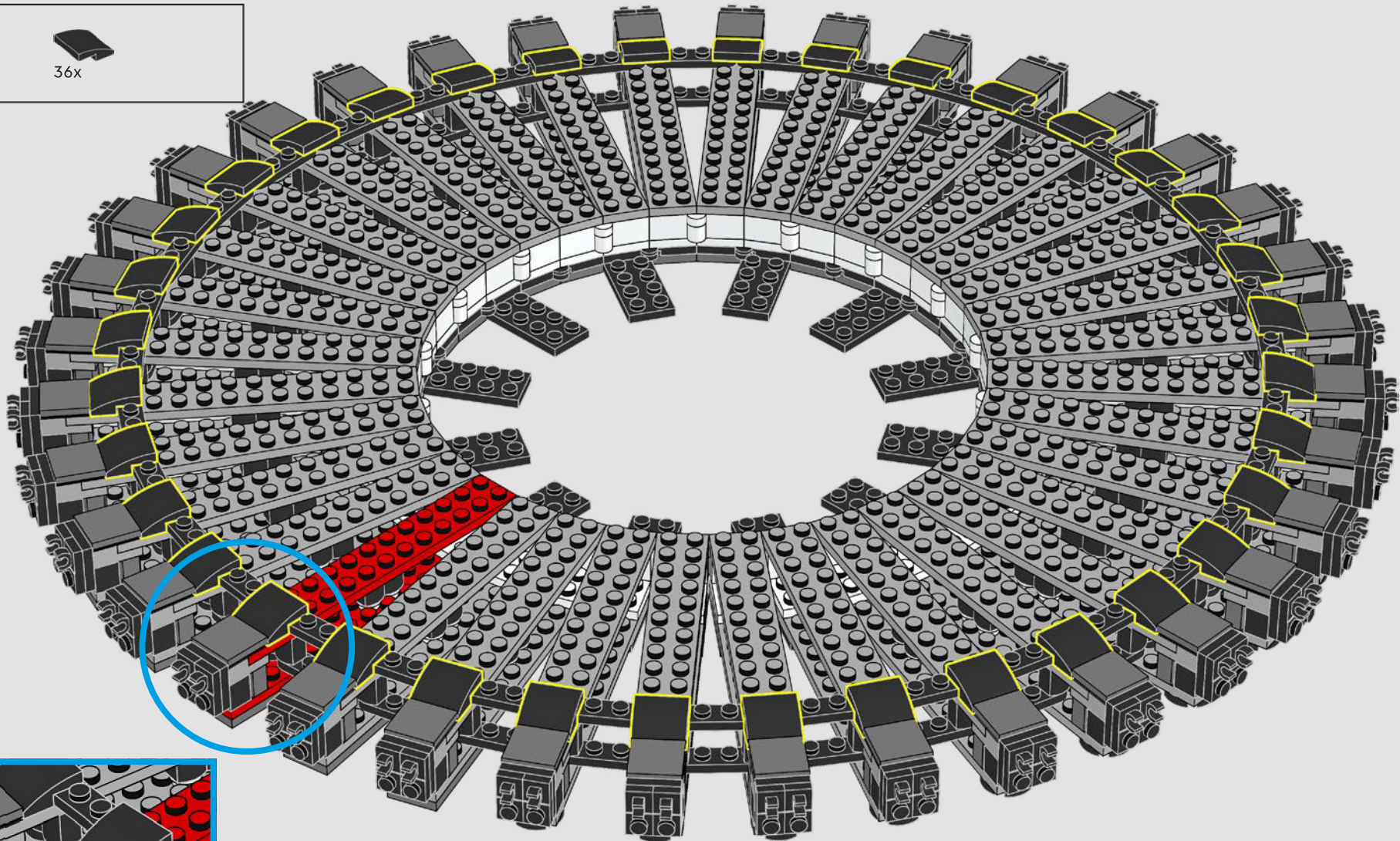

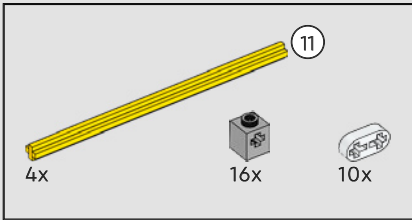
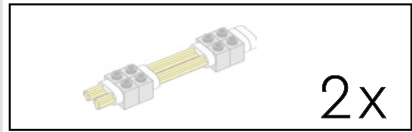
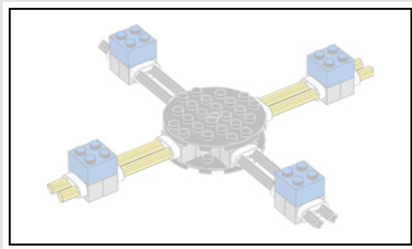

21

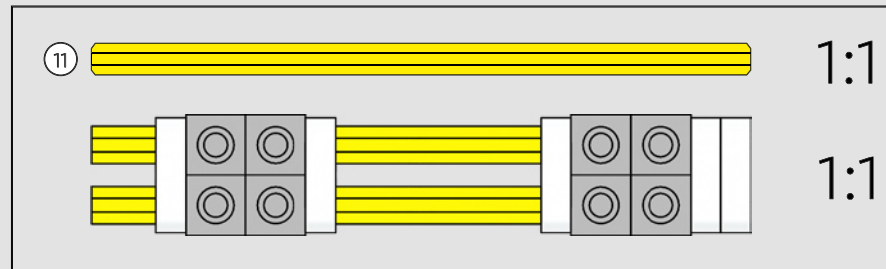
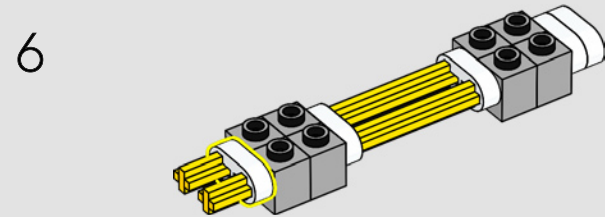
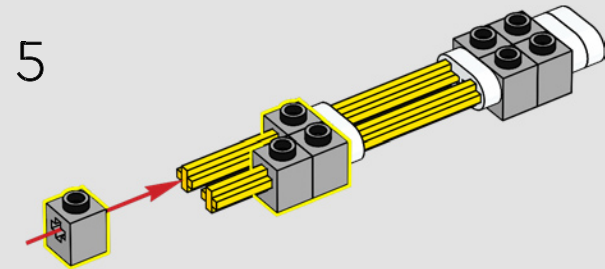
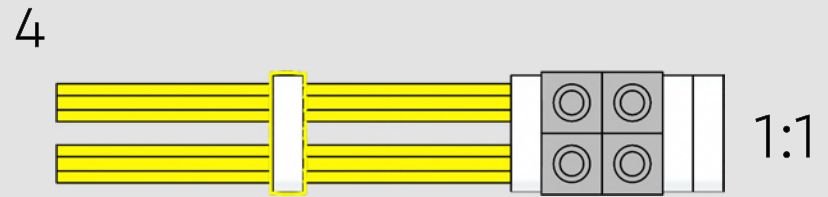
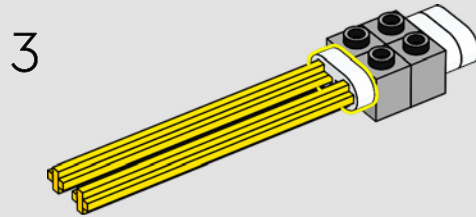
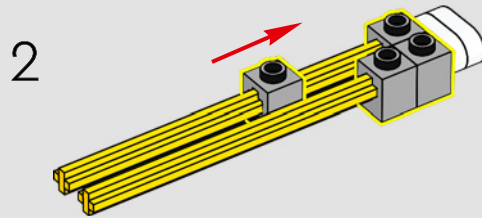
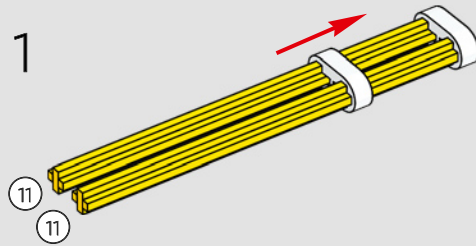

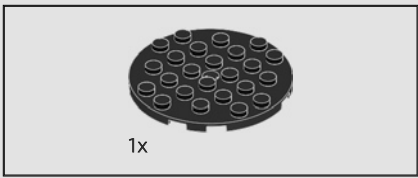

22

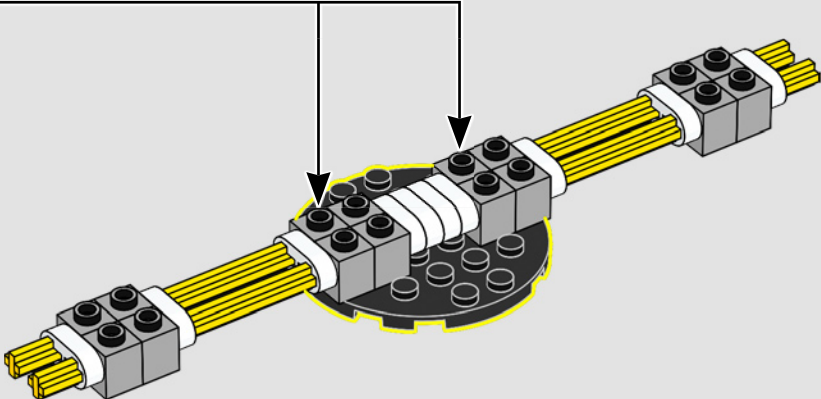

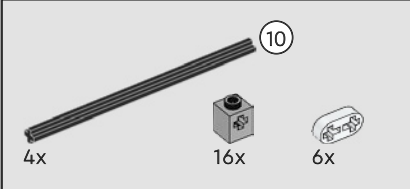
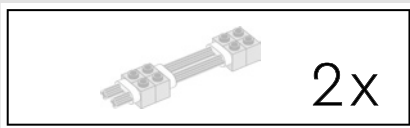

23

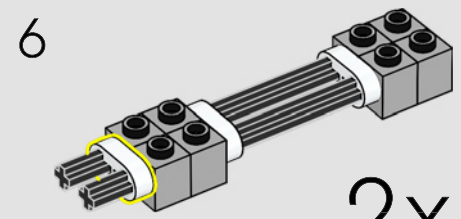
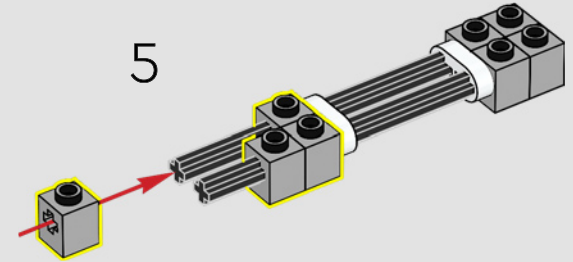
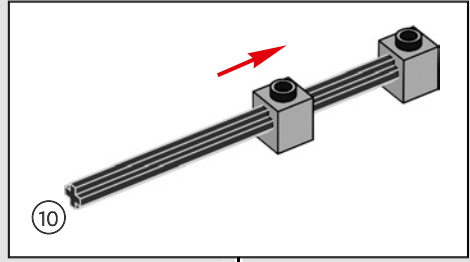
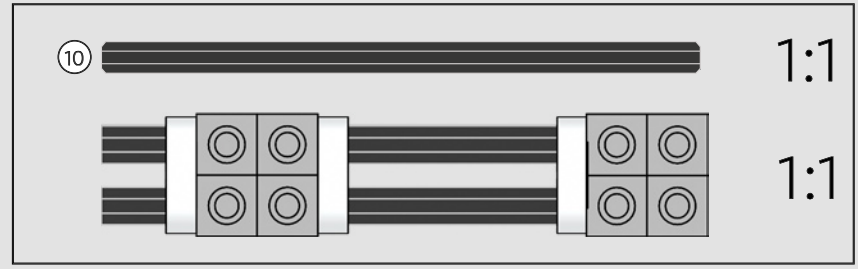
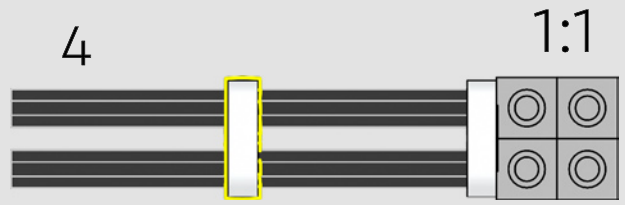
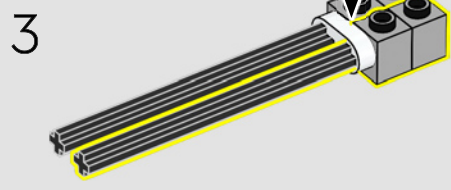
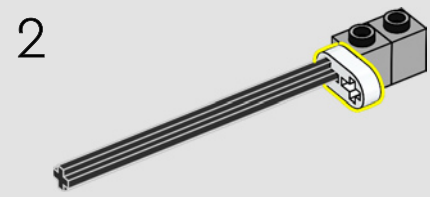
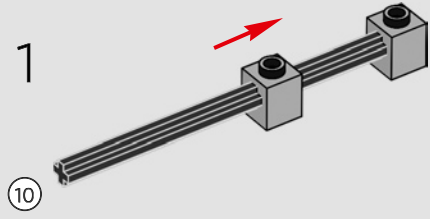

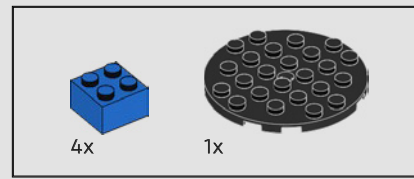

24

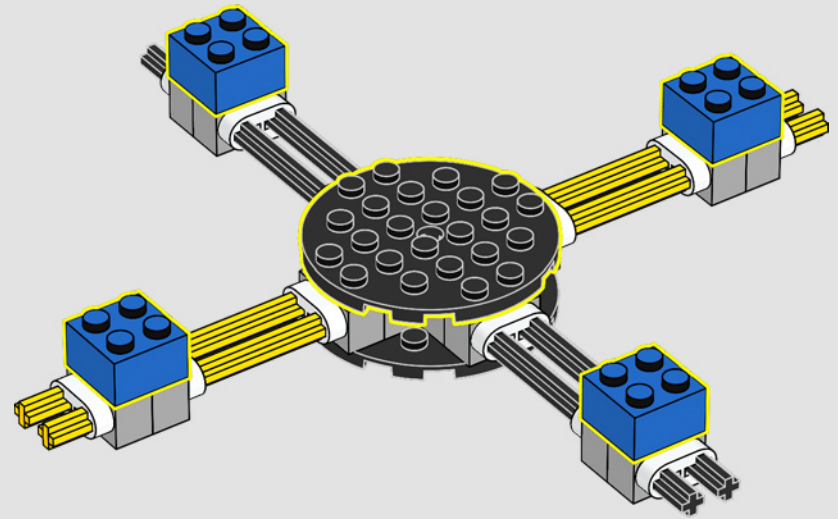
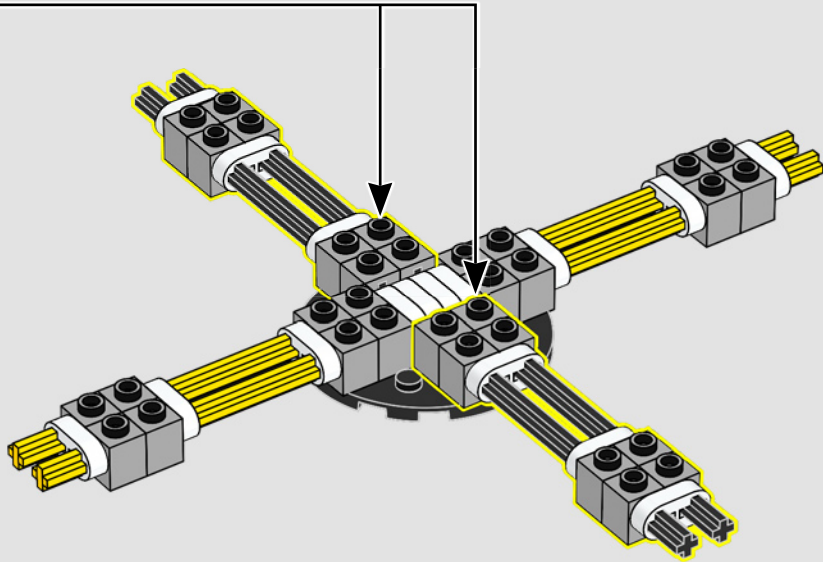

25

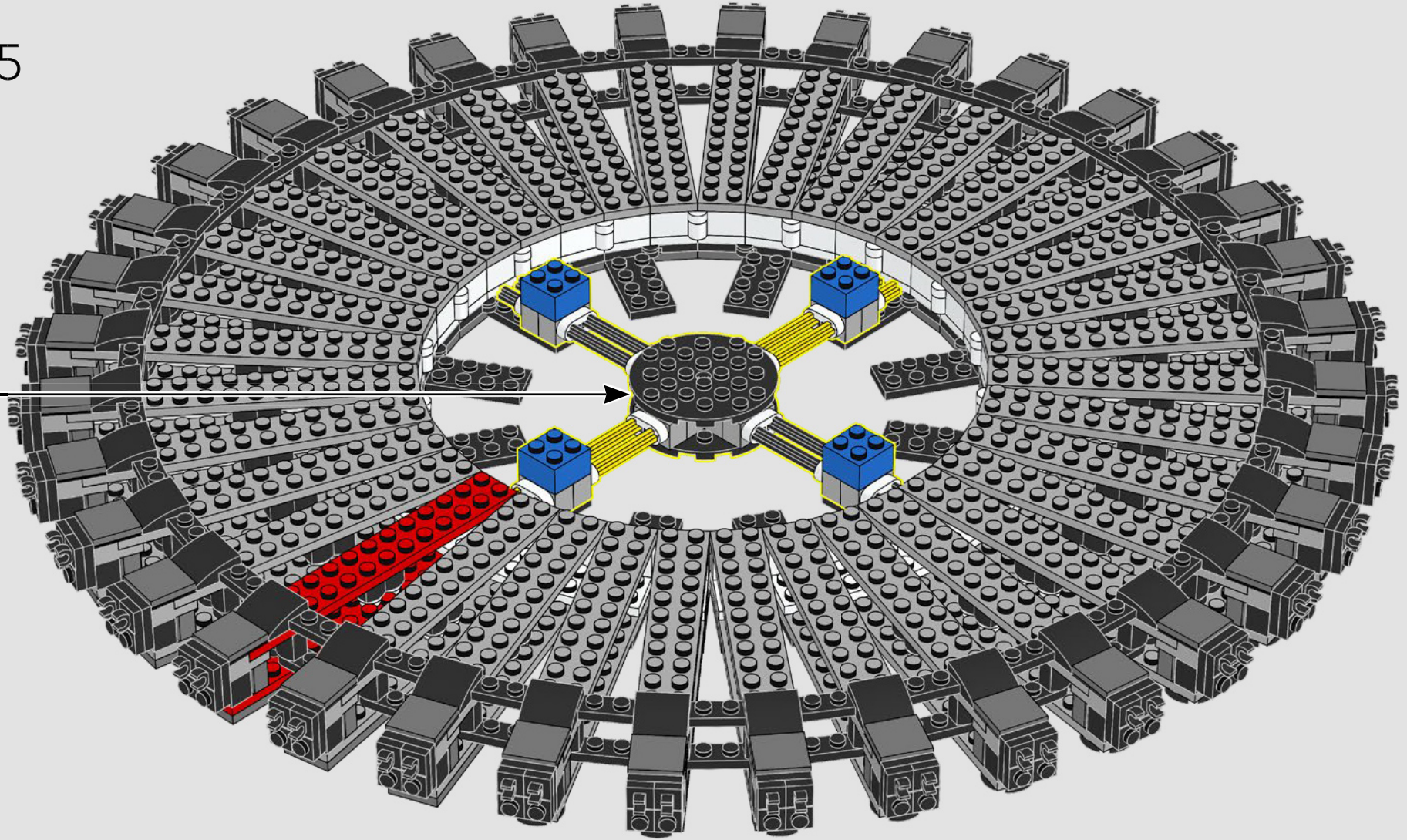

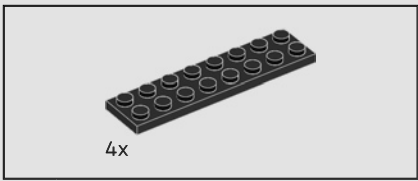

26

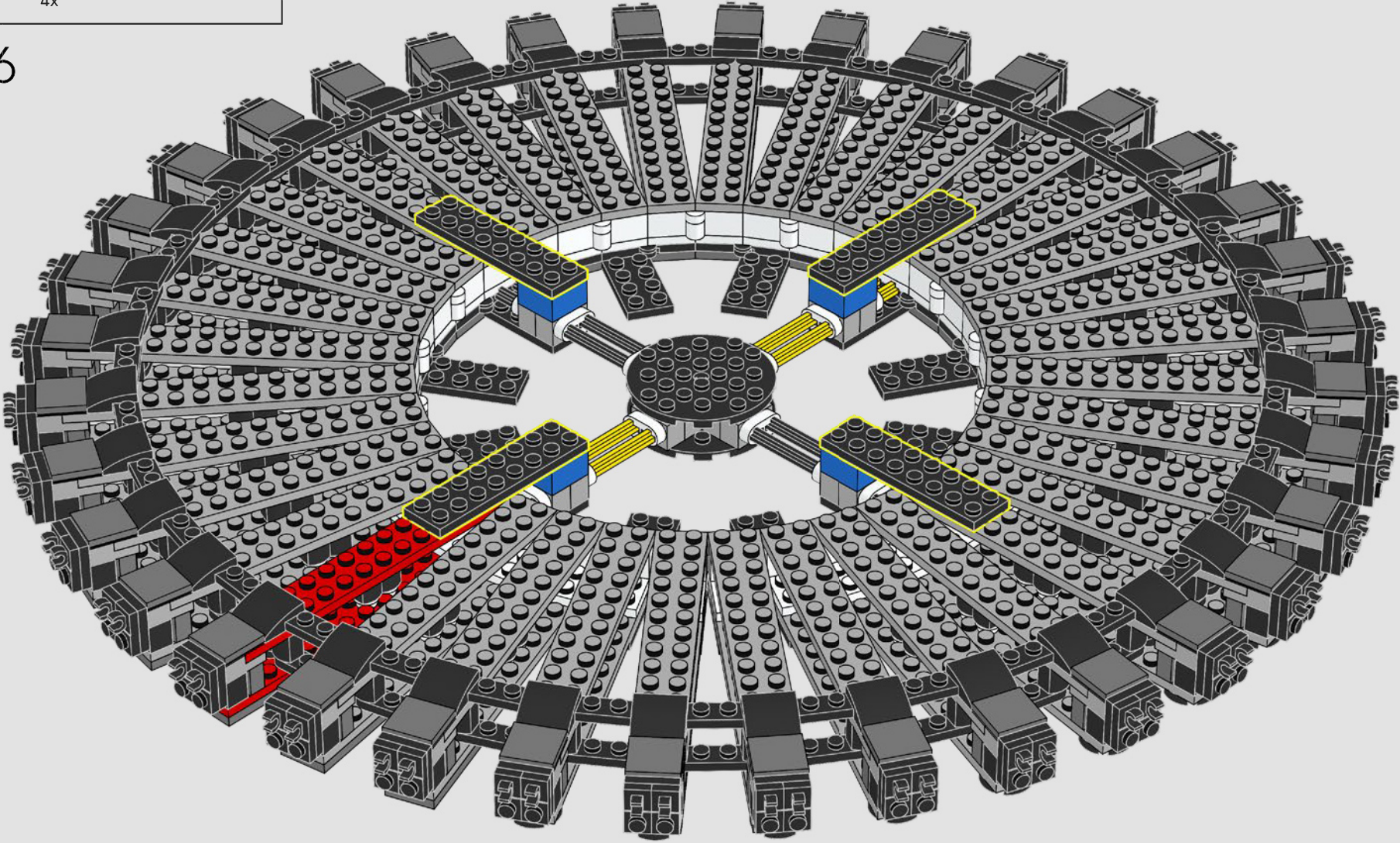



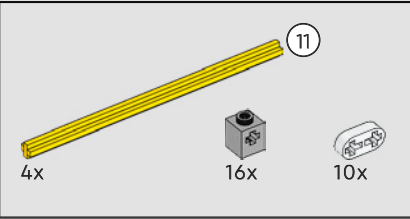
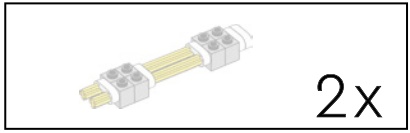
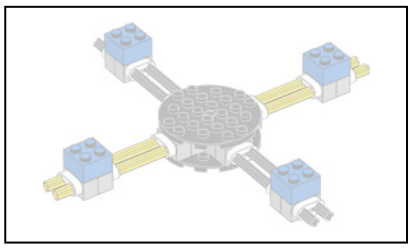

27

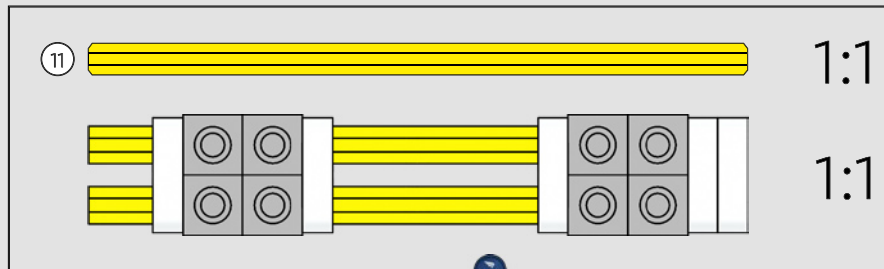
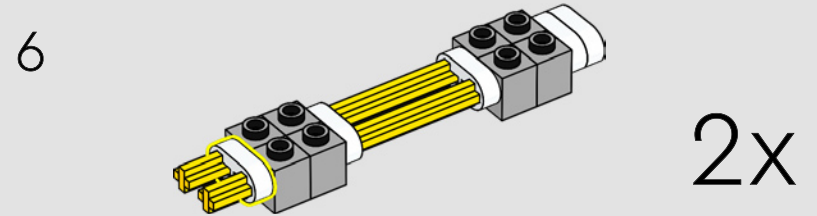
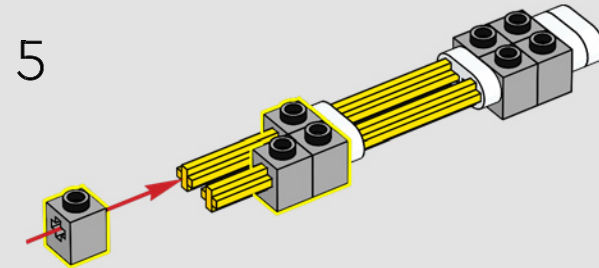
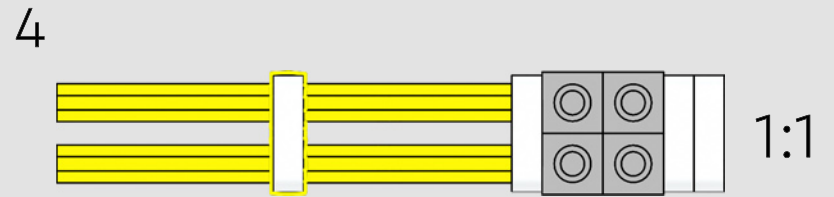
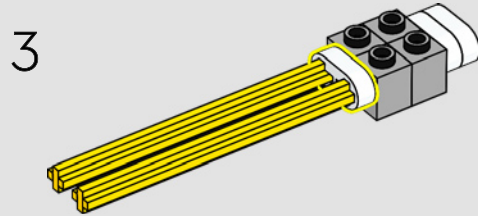
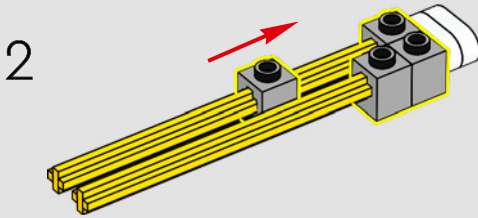
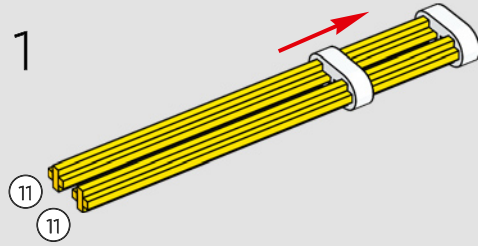

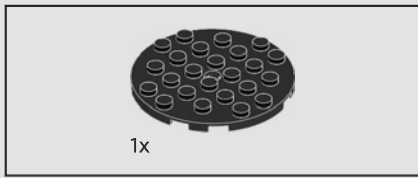

28

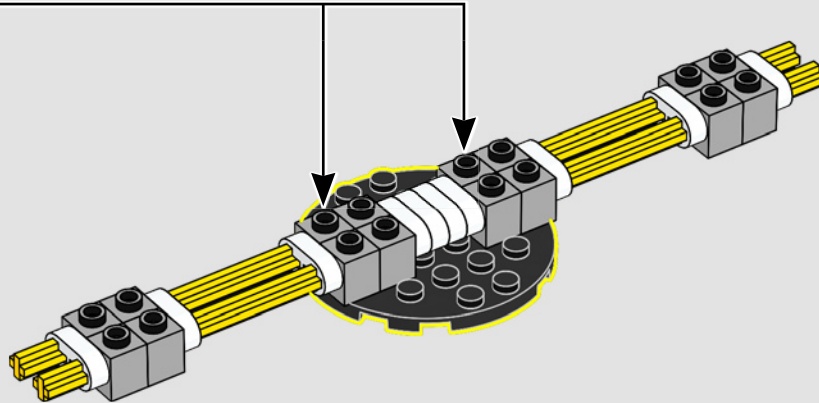

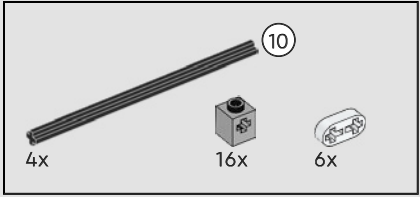
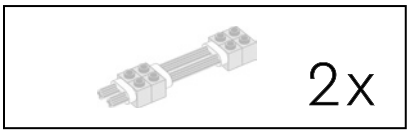

29

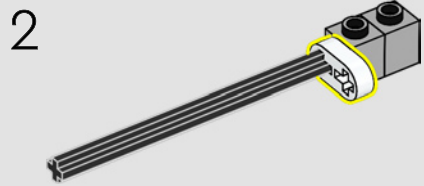
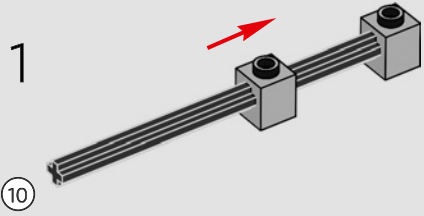

3

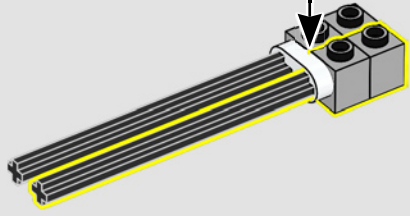

4

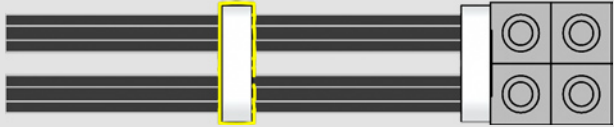

1:1

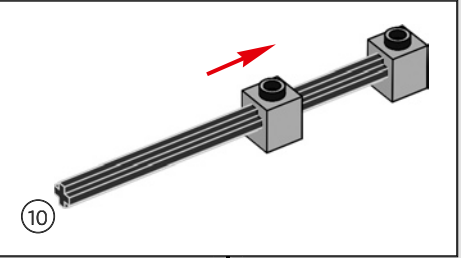
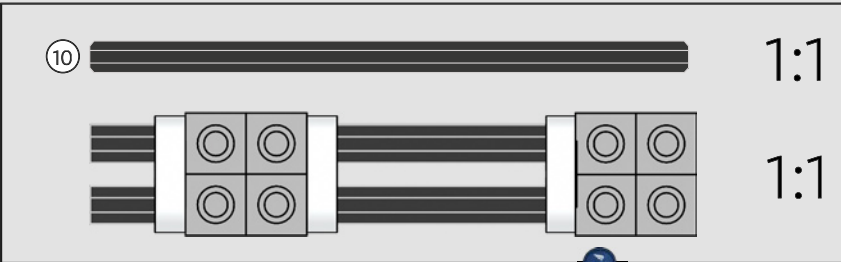

5

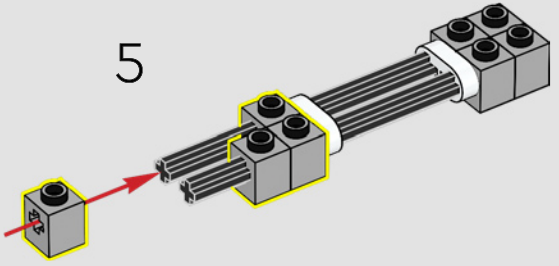

6

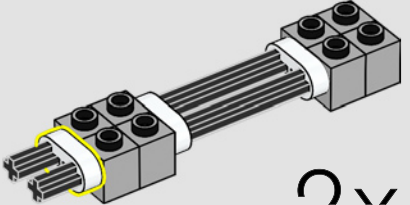

2x



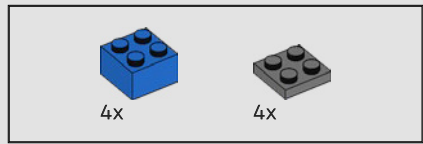
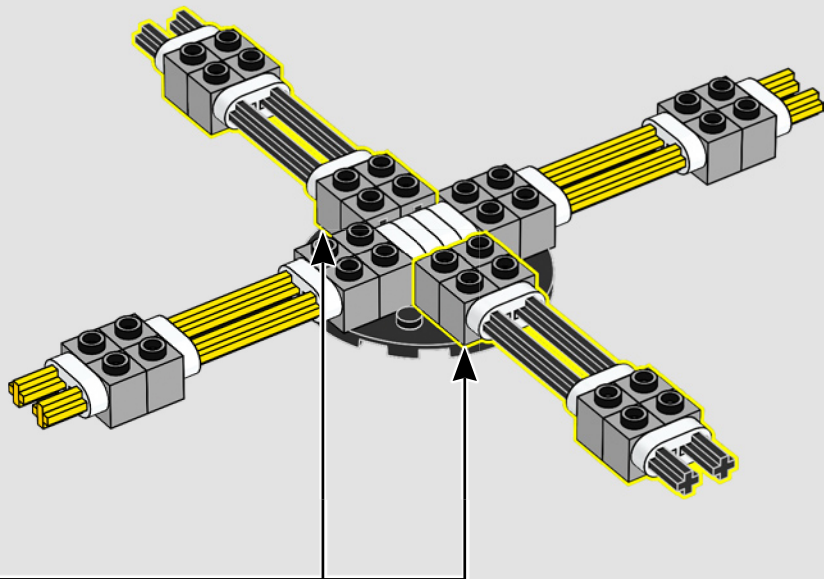

30

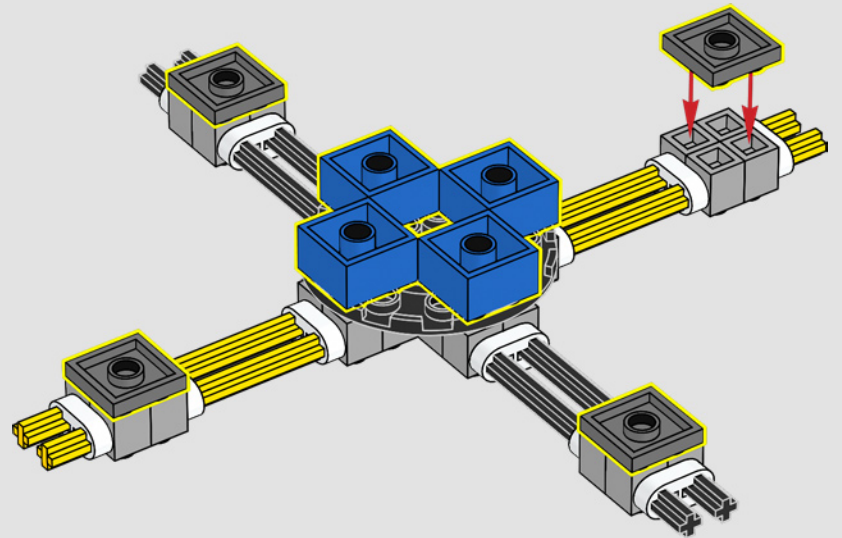
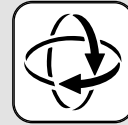

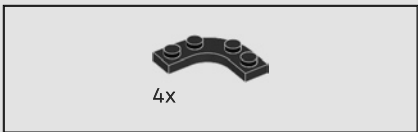

31

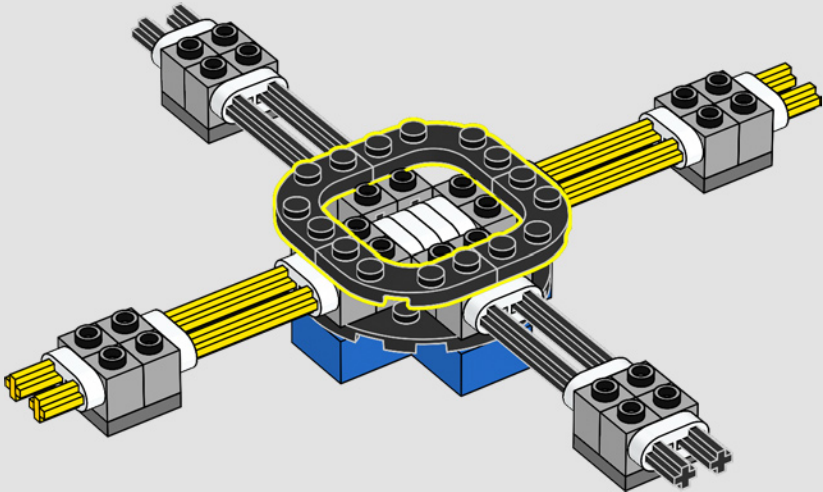

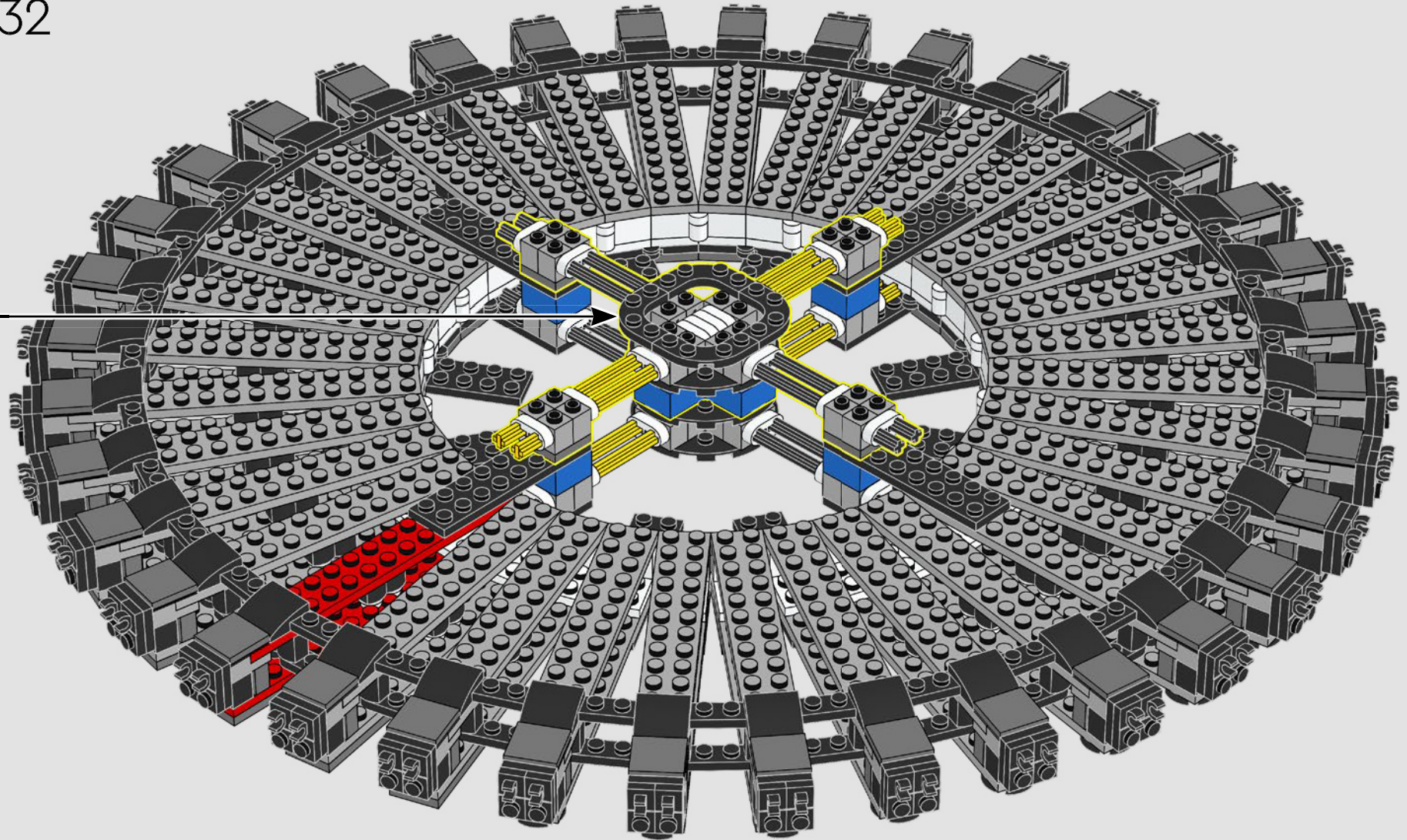

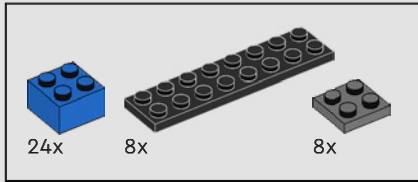
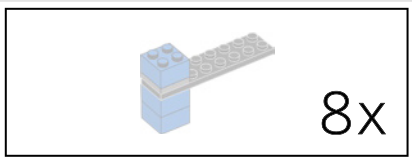

33

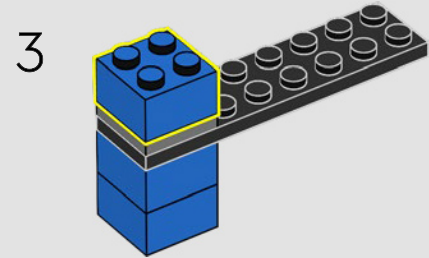
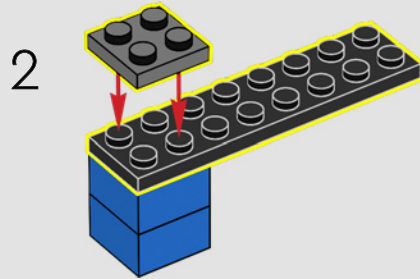
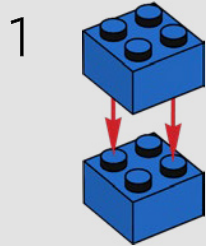

8x



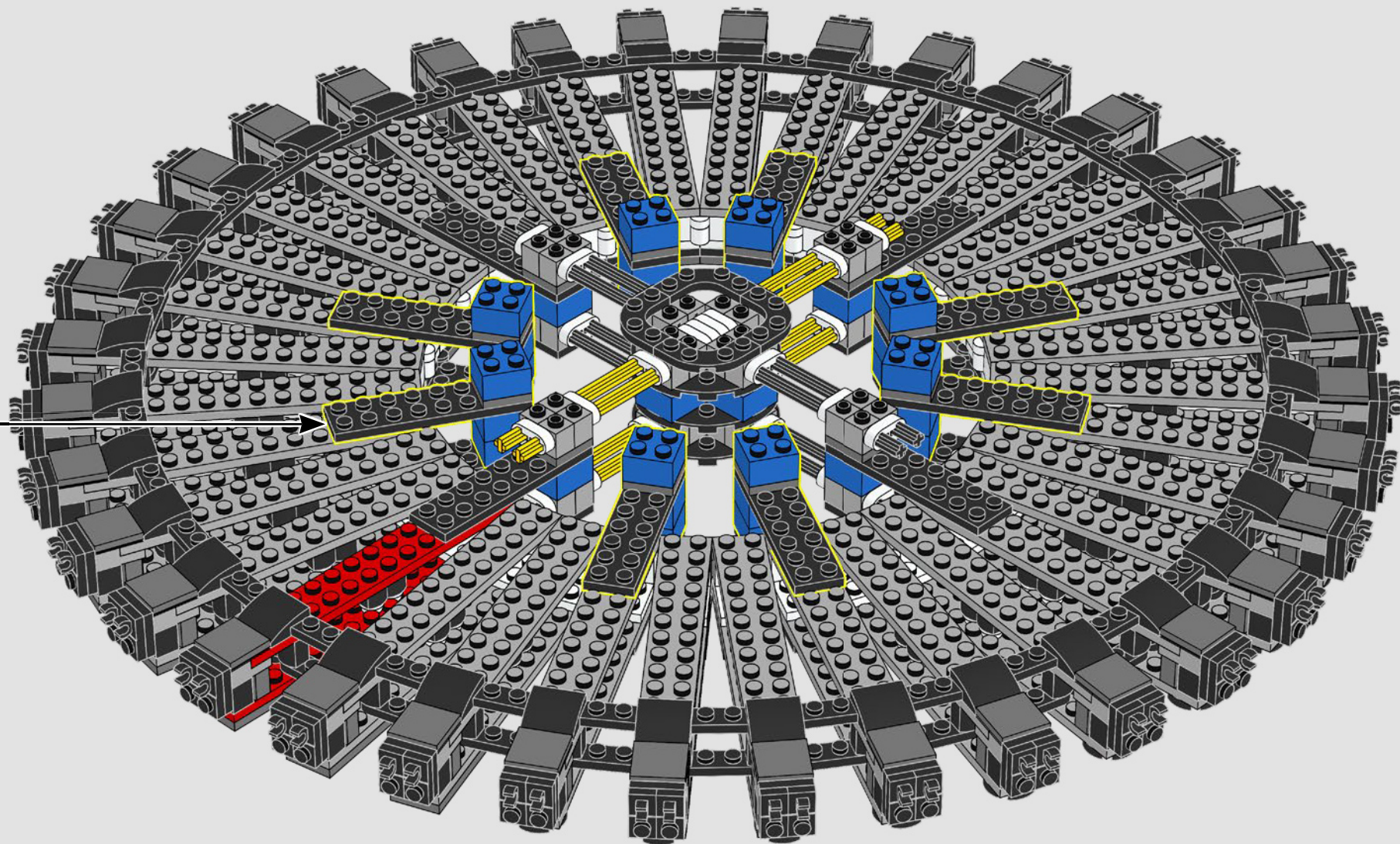

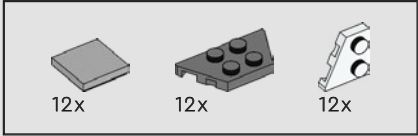
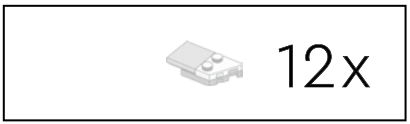

34

1

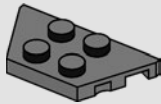

2

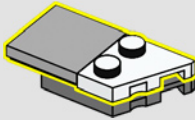

12x



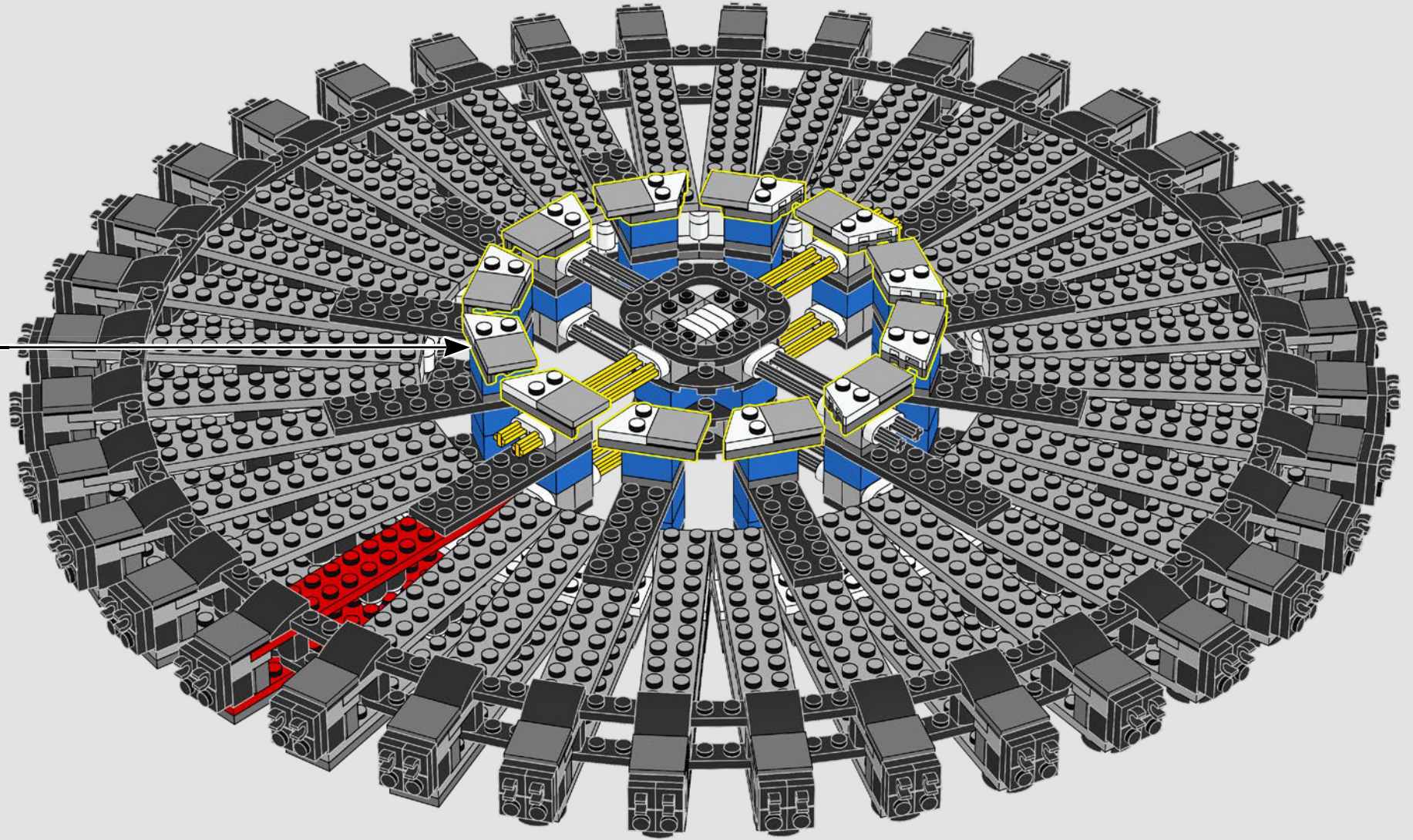

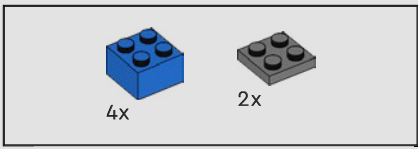

35

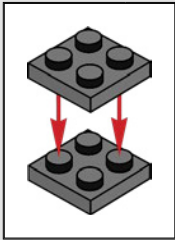
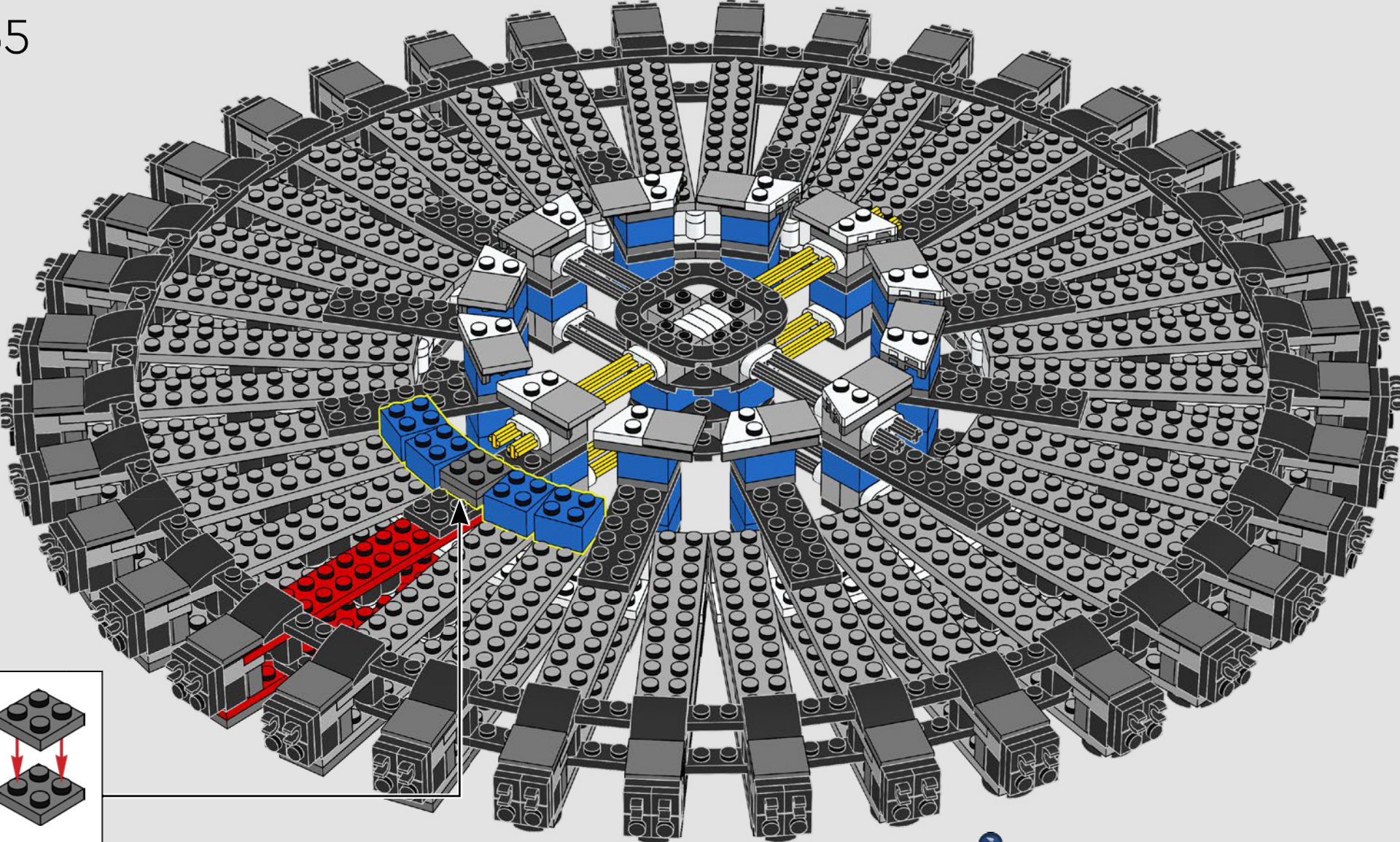



22x

36

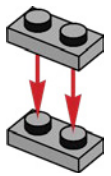
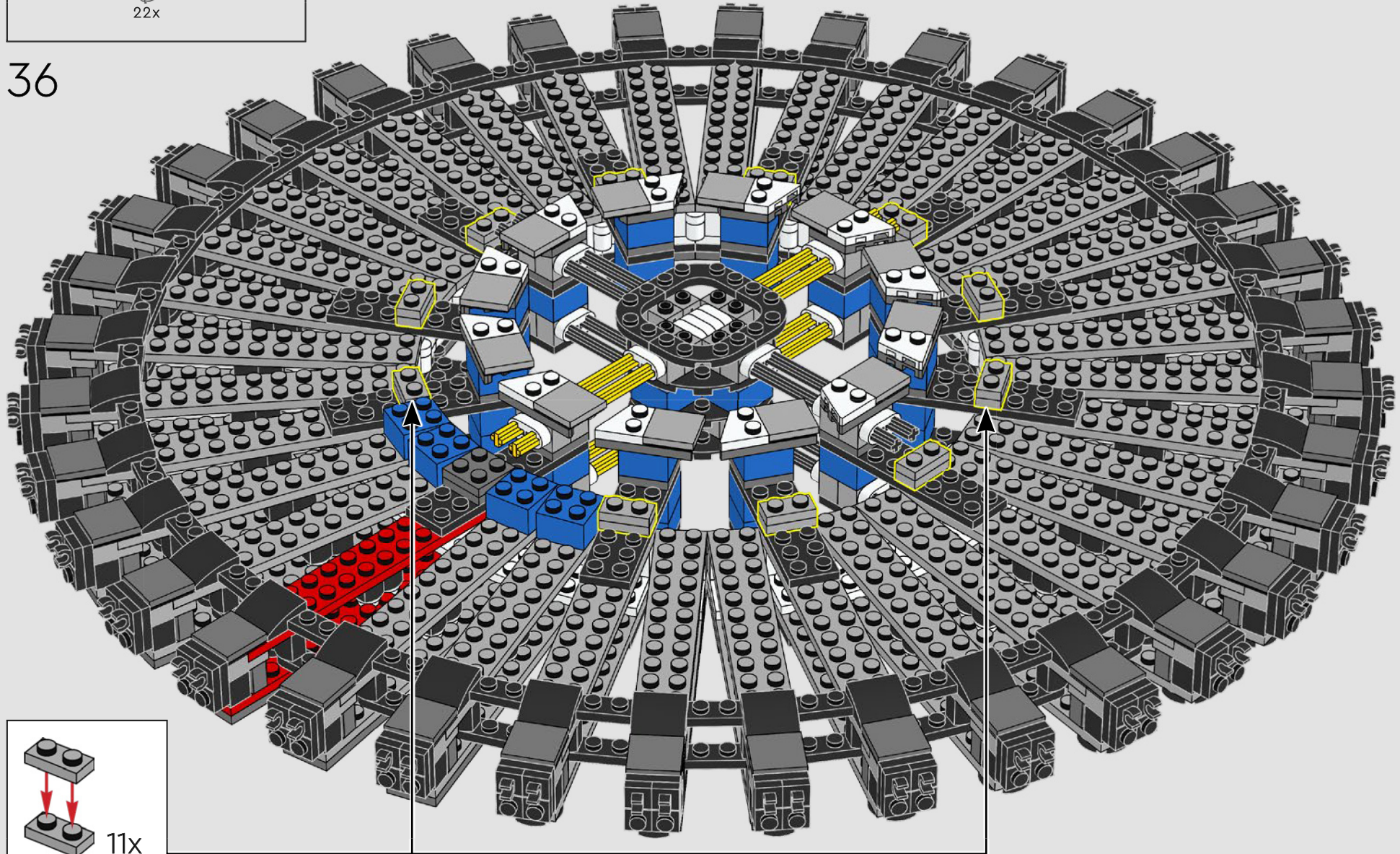

11x



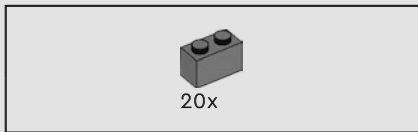

37

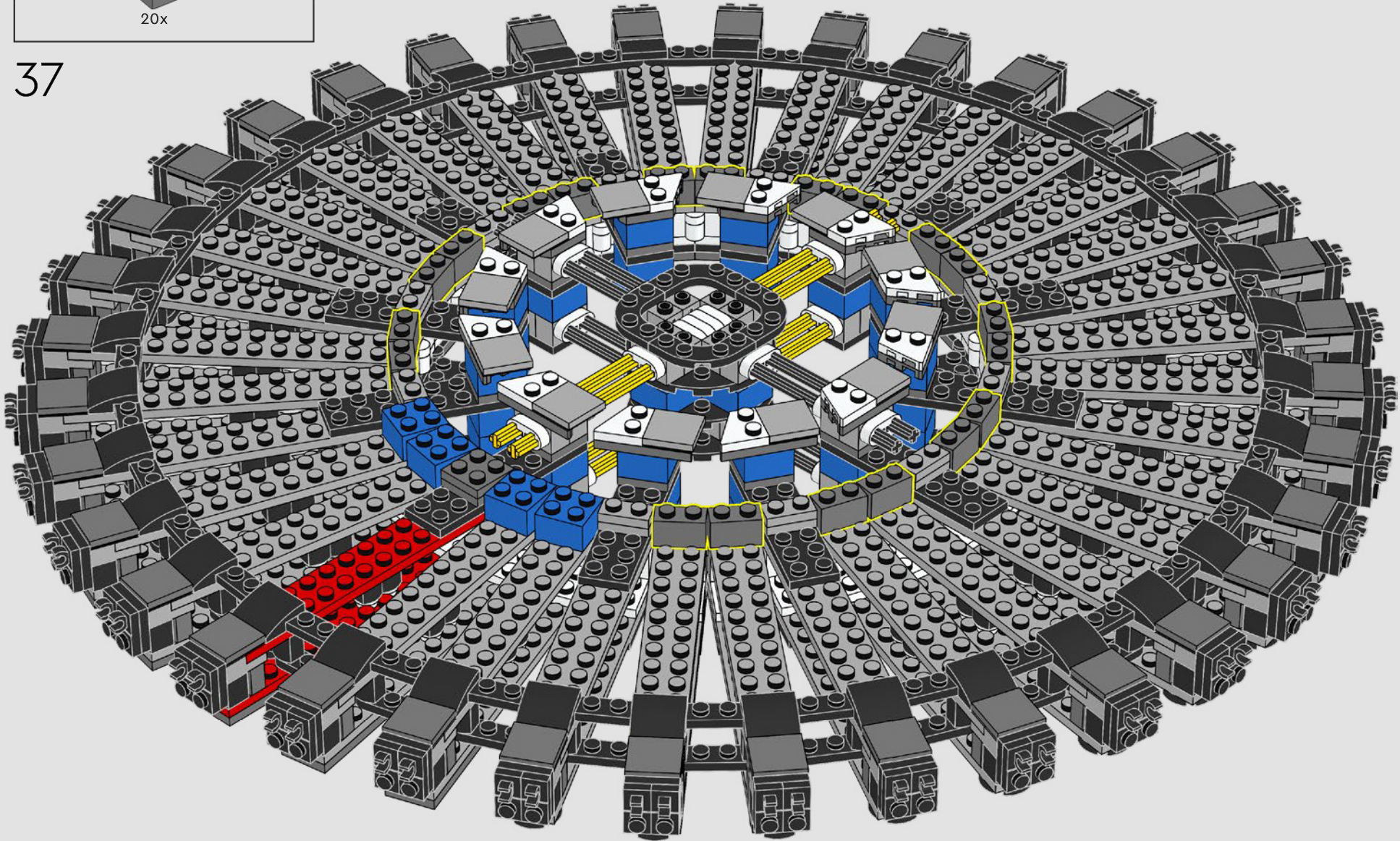

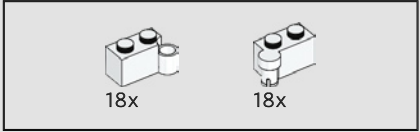
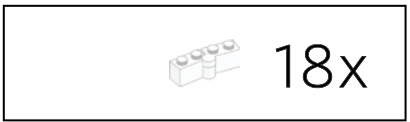

38

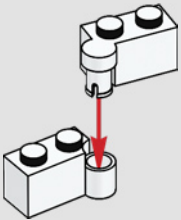

18x

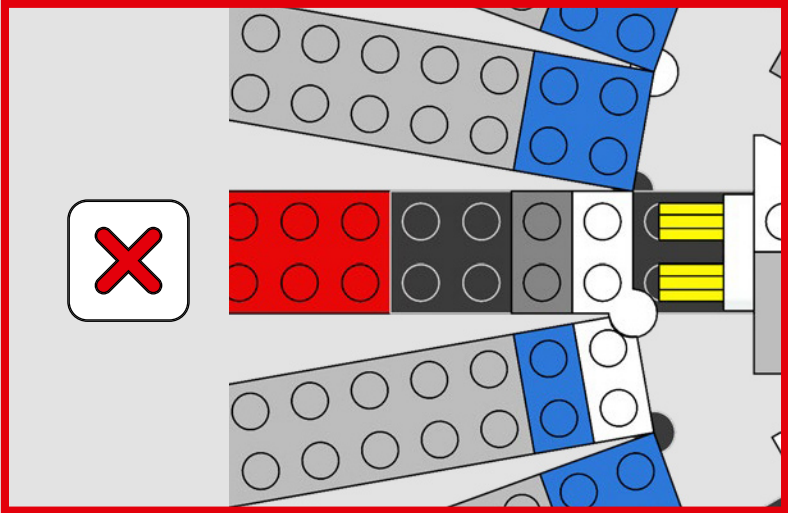
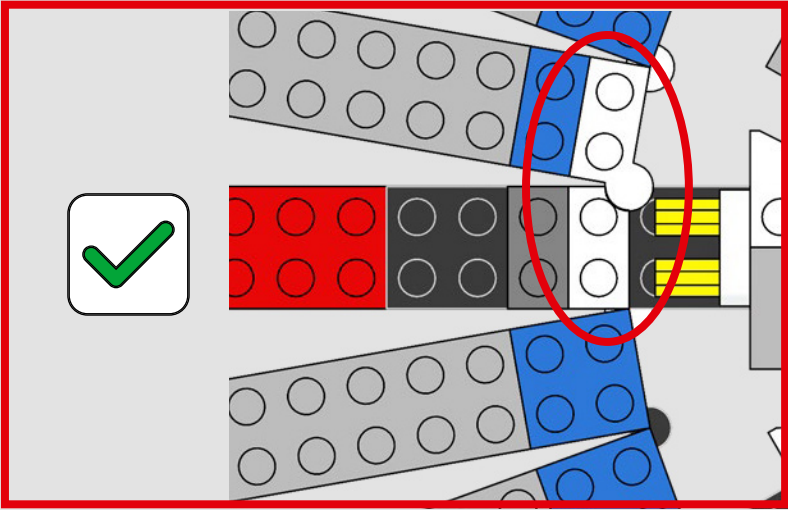

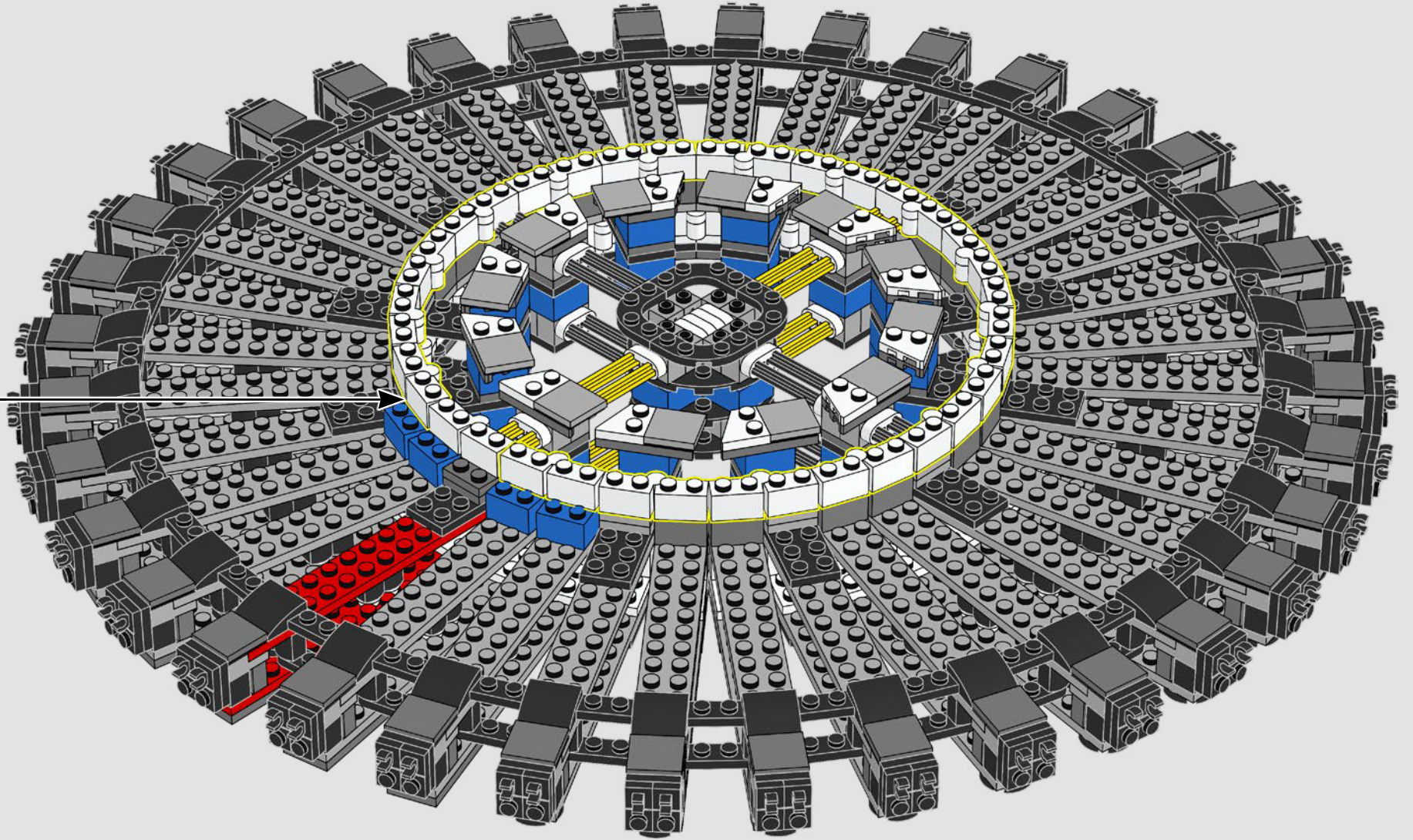

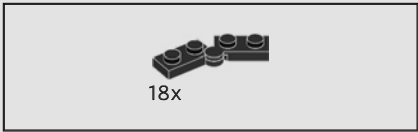

39

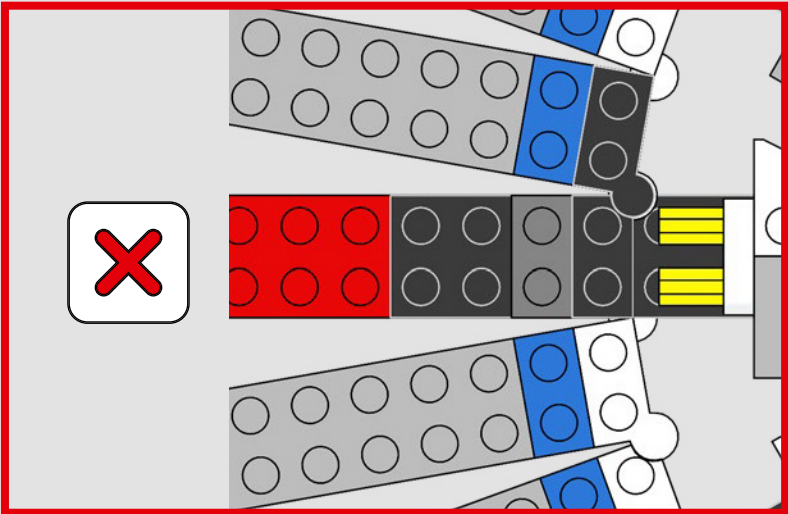
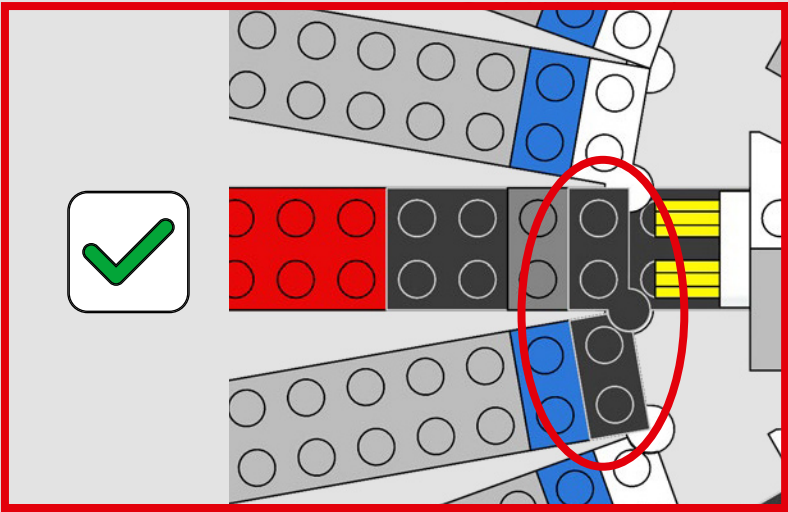

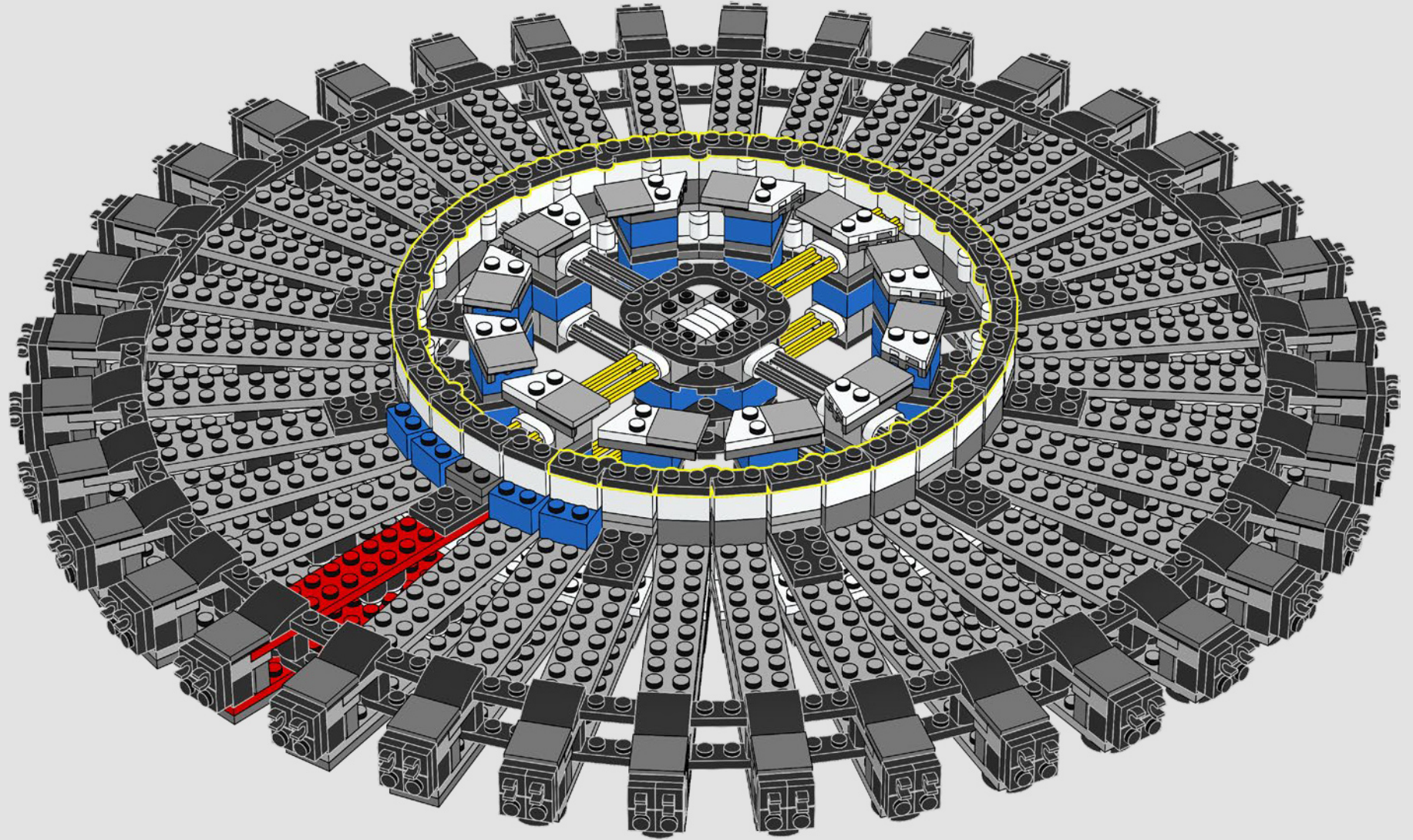



5x



5x



5 x

40

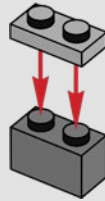

5x



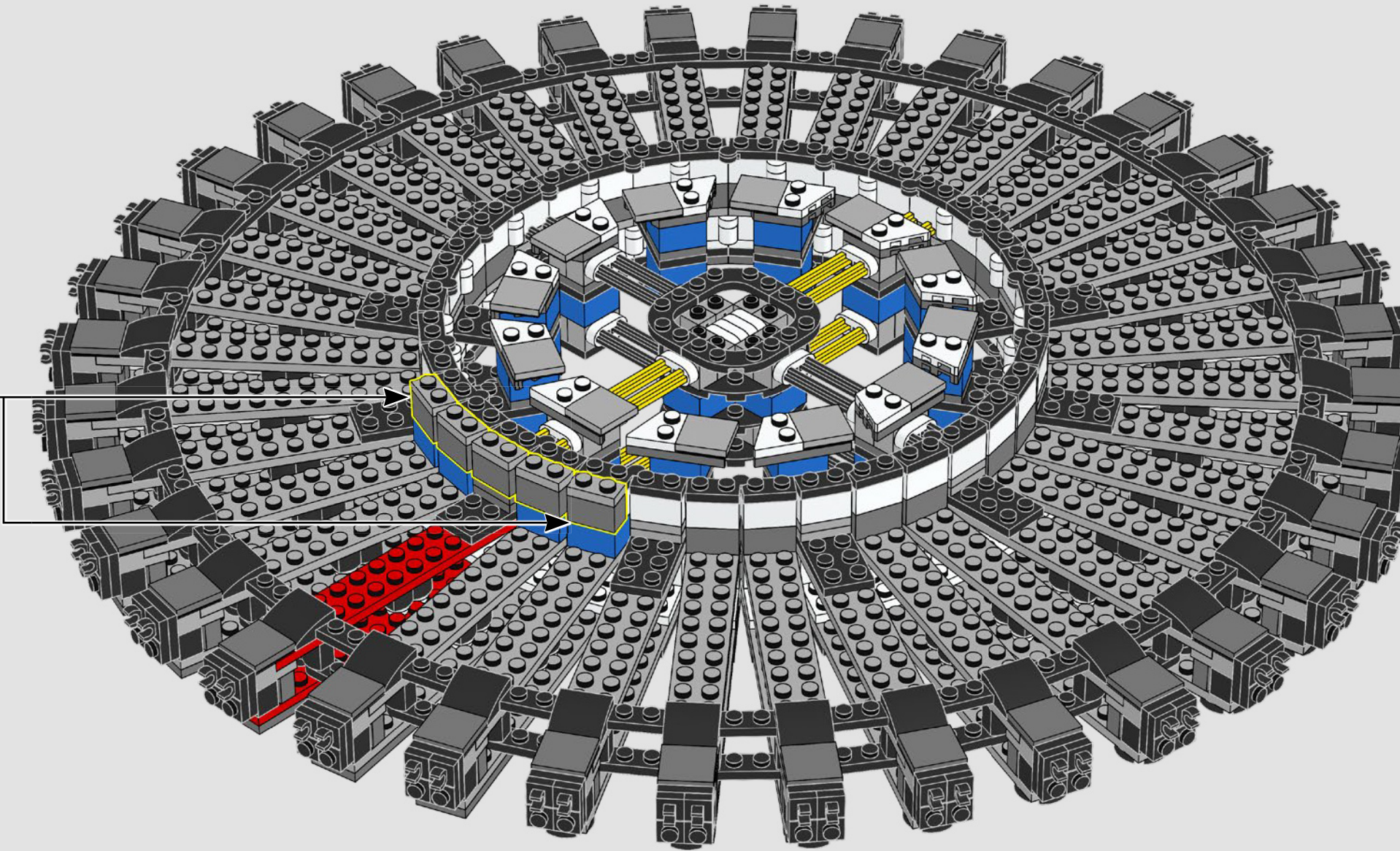



18x



18x



36x



18x

41

1

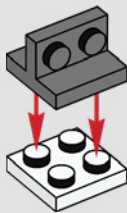

2

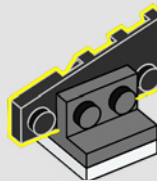

3

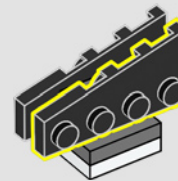

18x



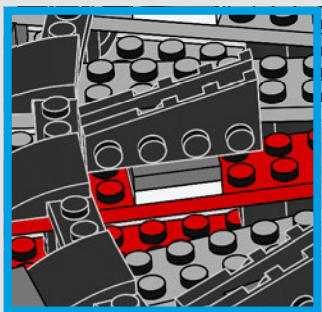
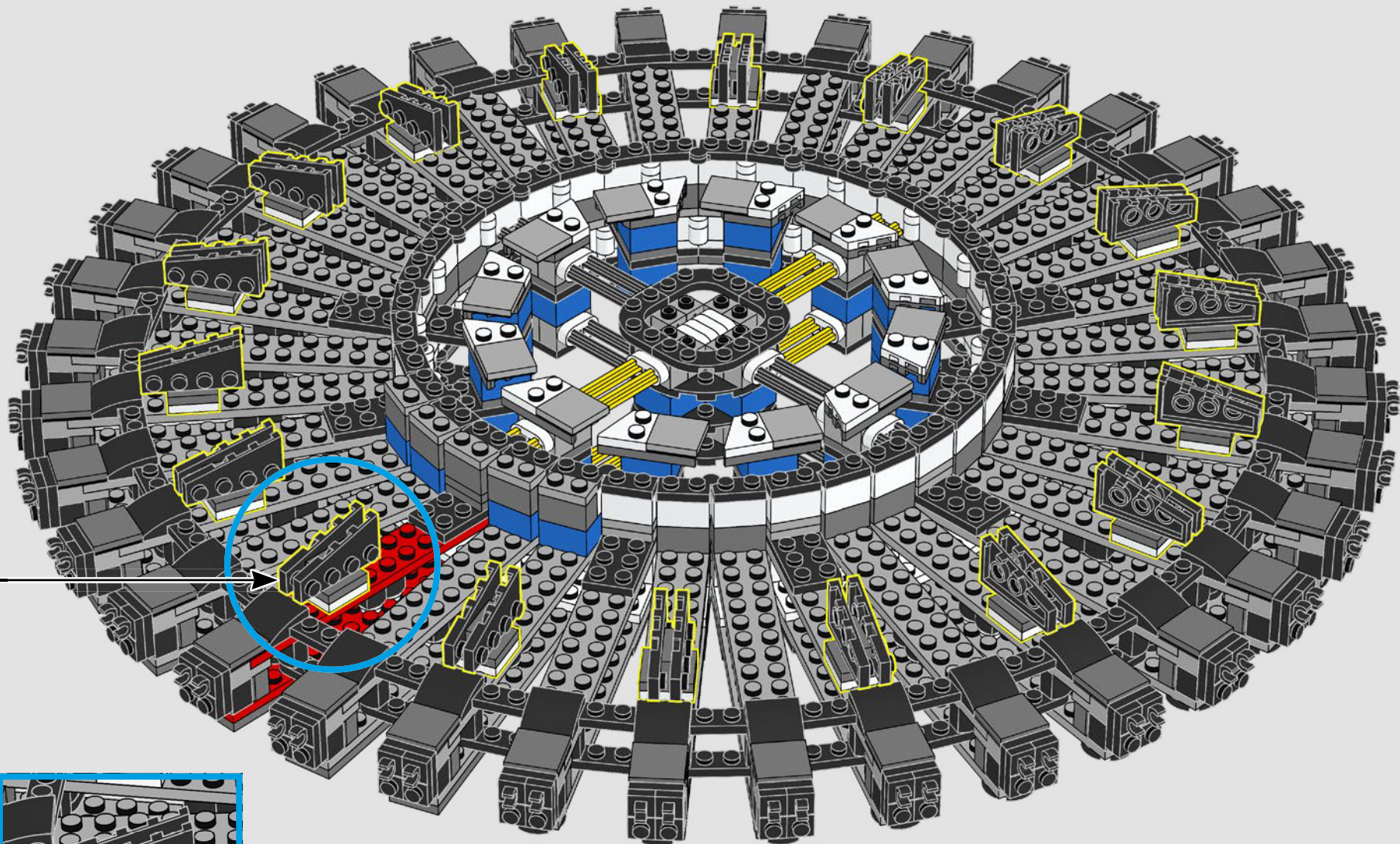

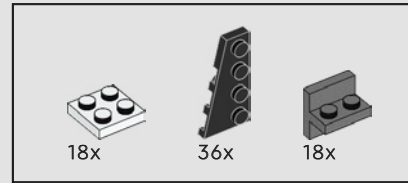
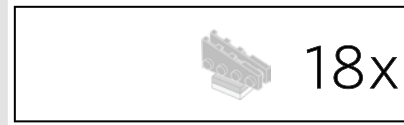

42

1

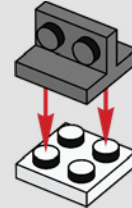

2

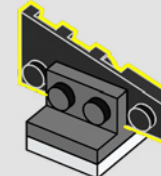

3

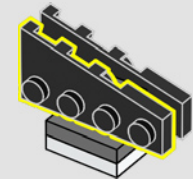

18x



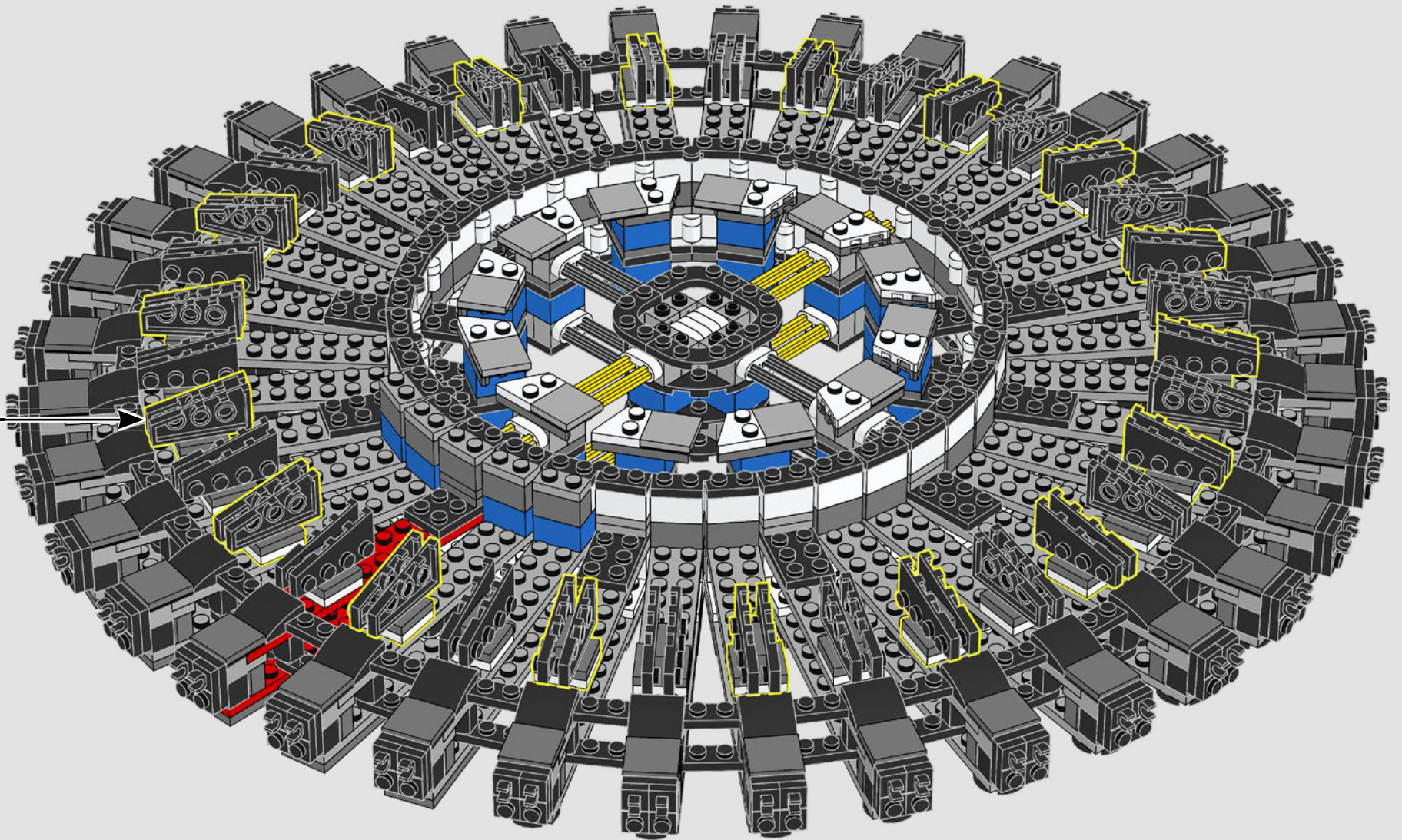



36x

43

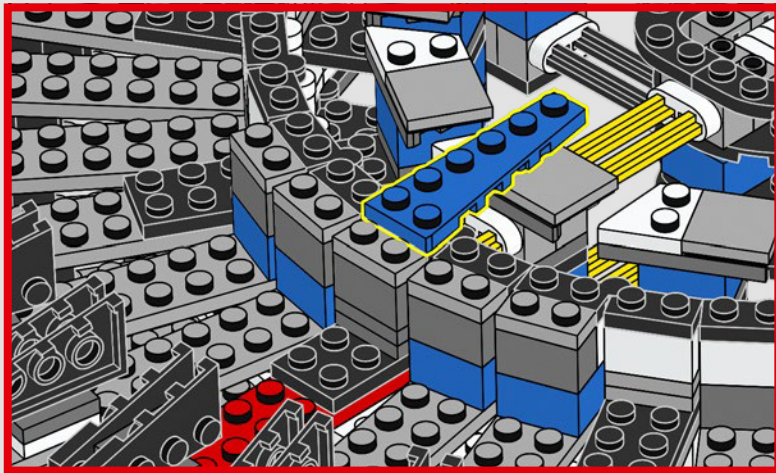

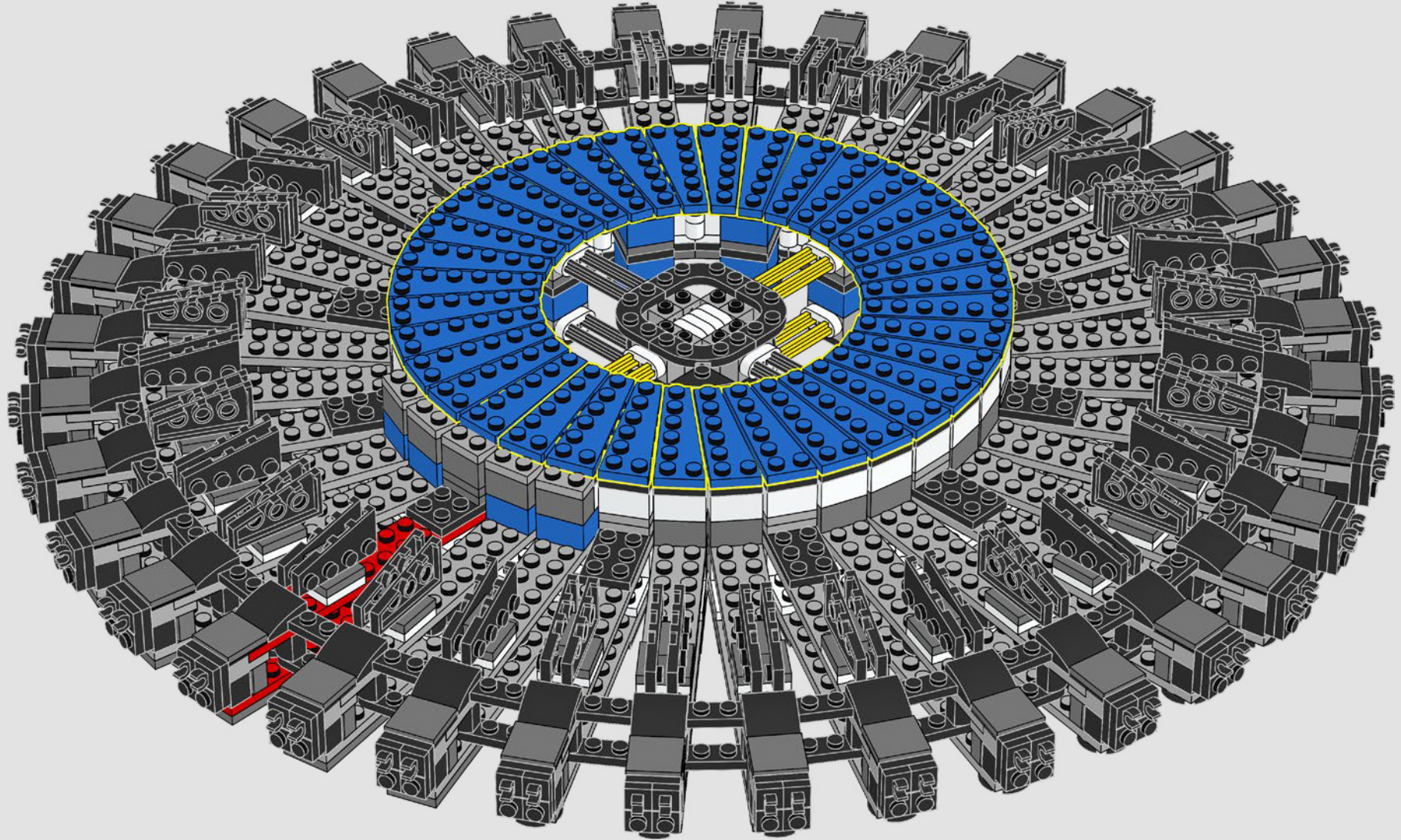

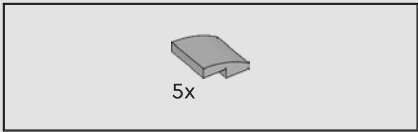

44

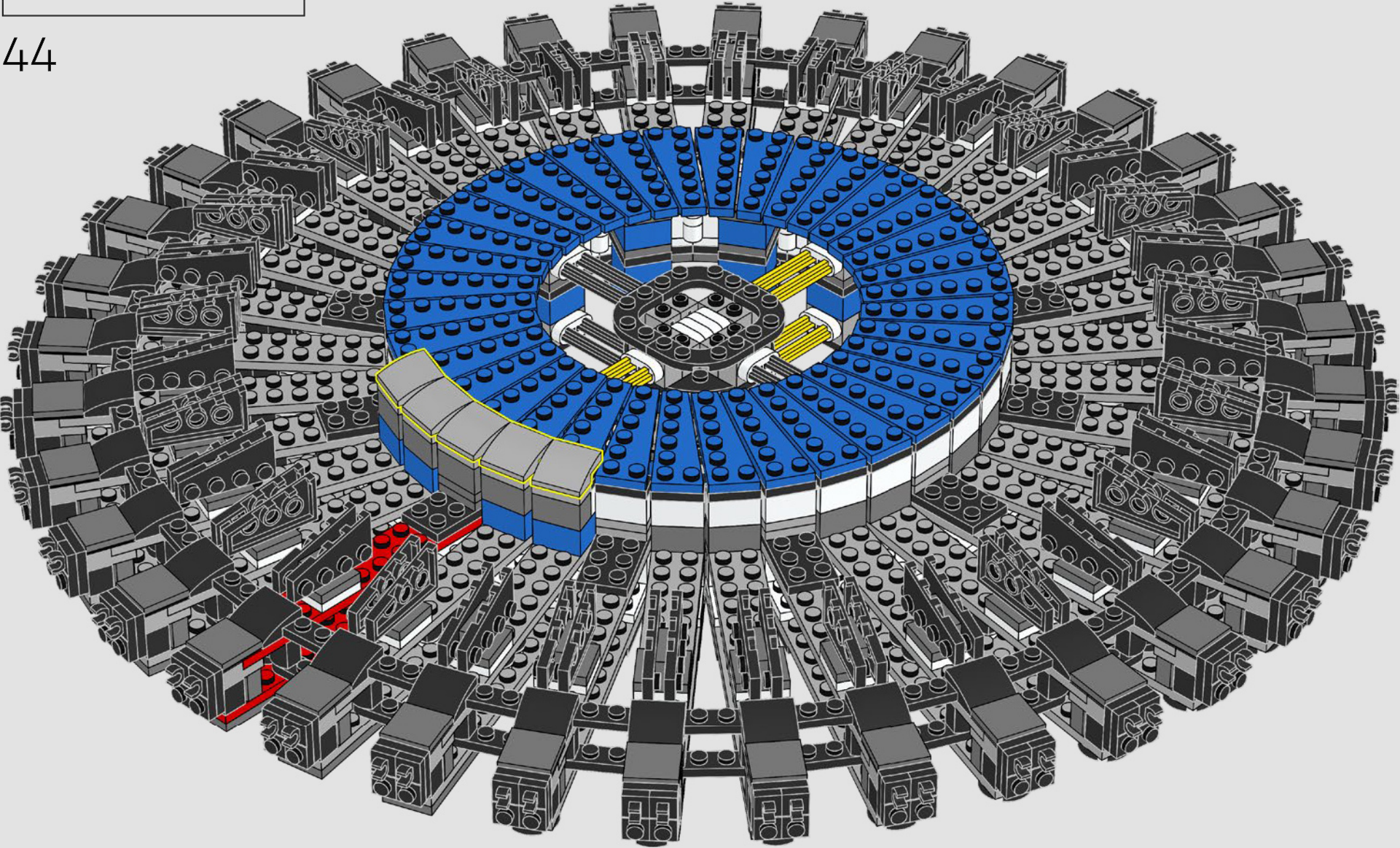



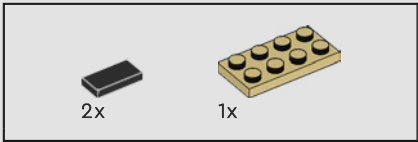

45

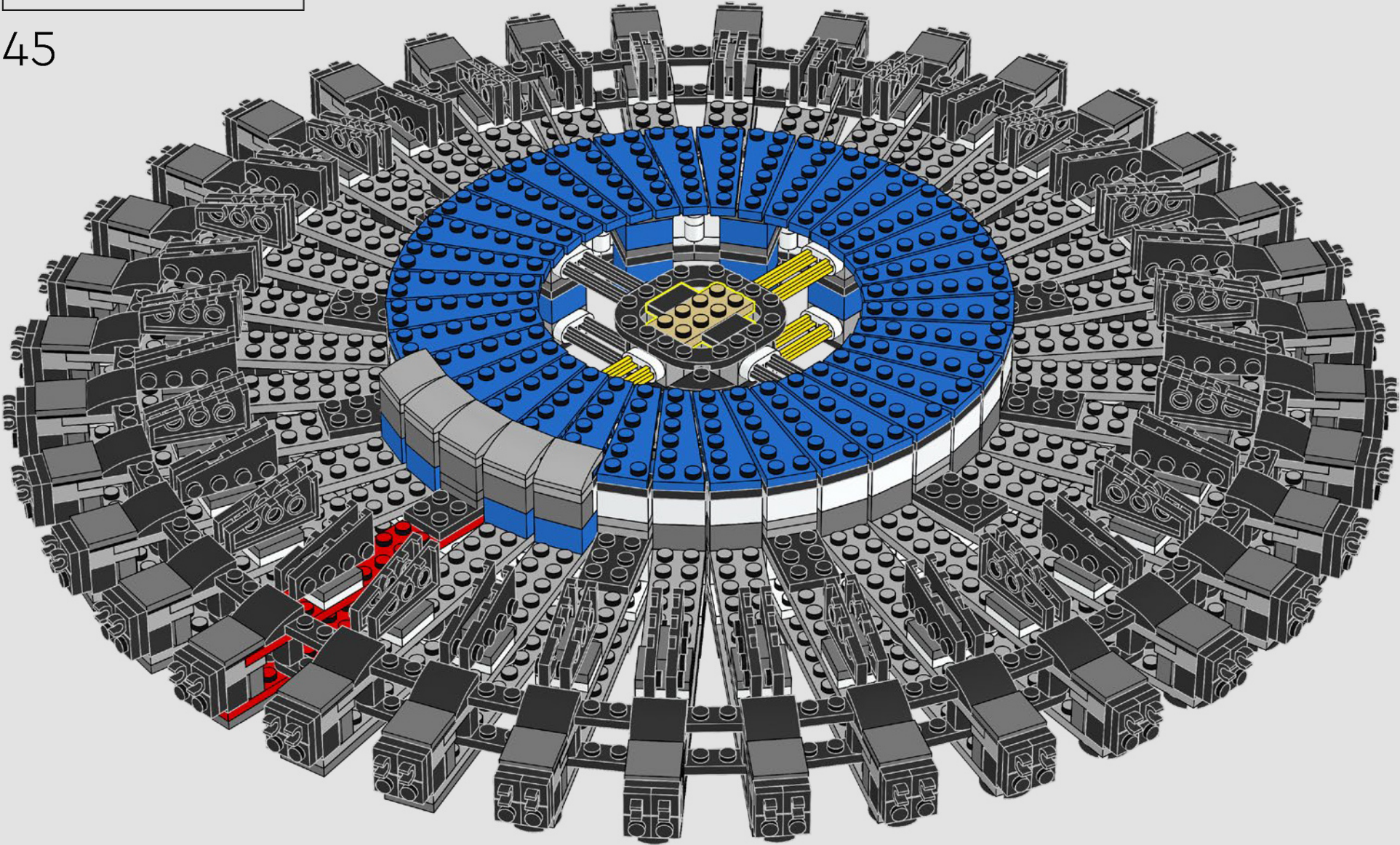

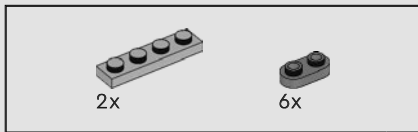

46

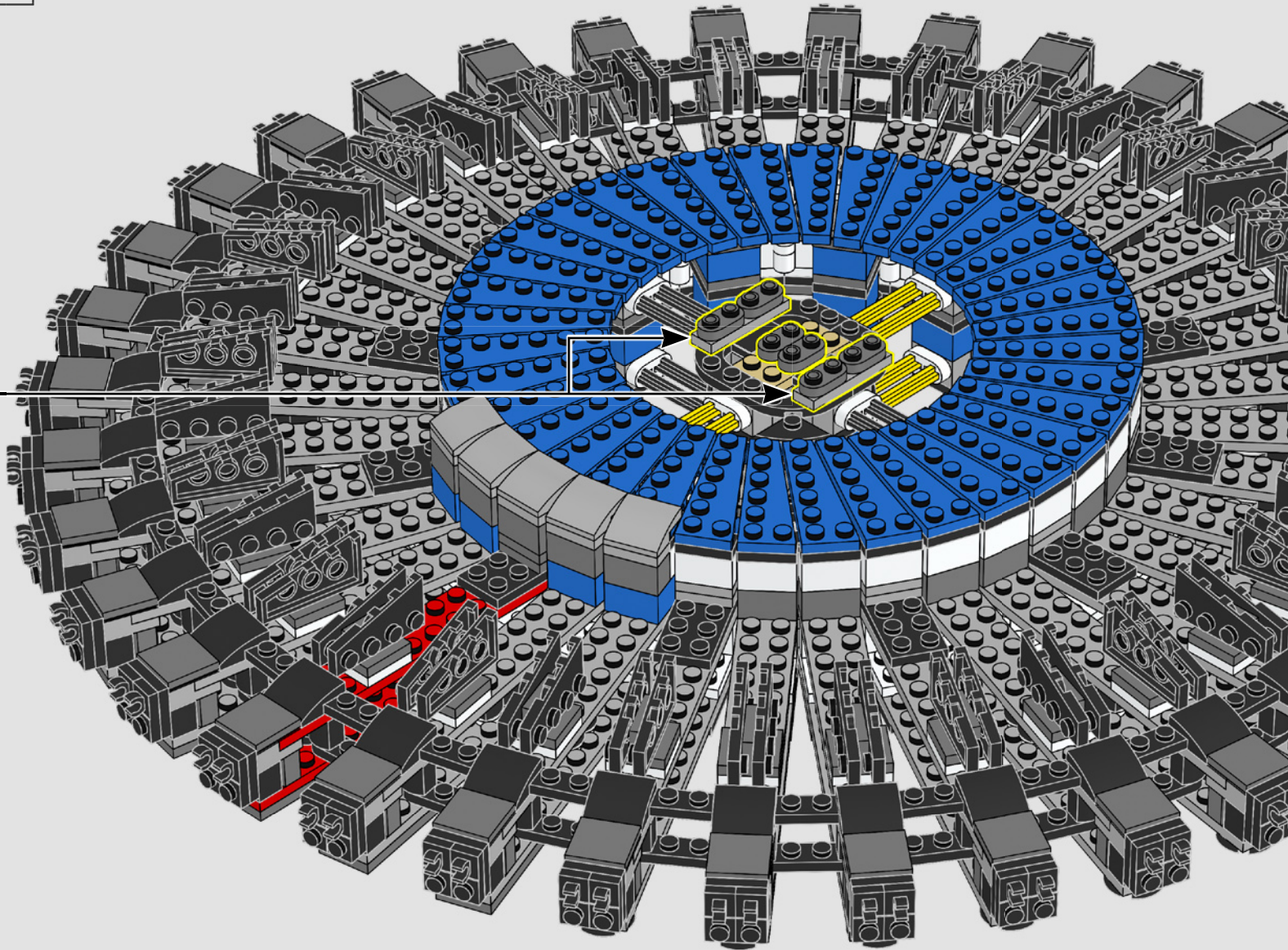
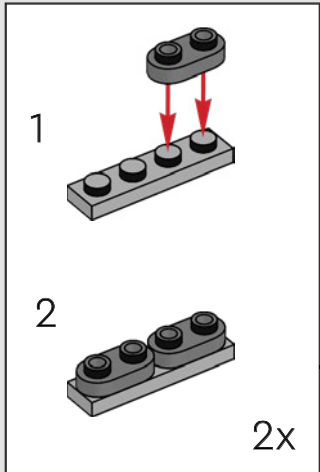

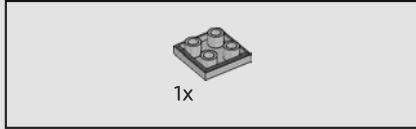
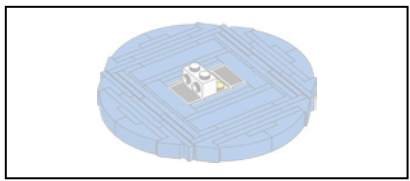

47

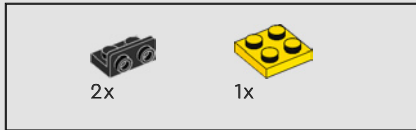

48

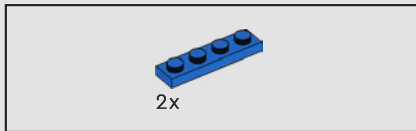

49

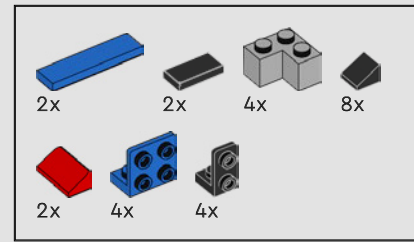
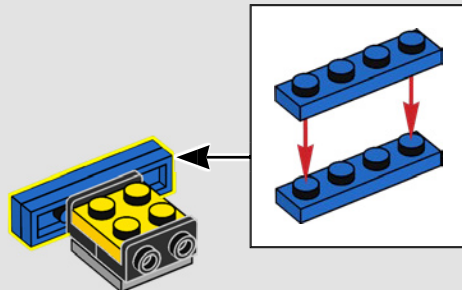
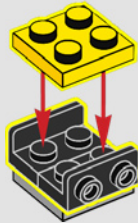
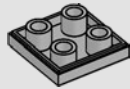

50

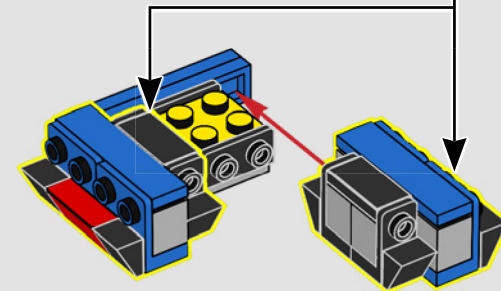
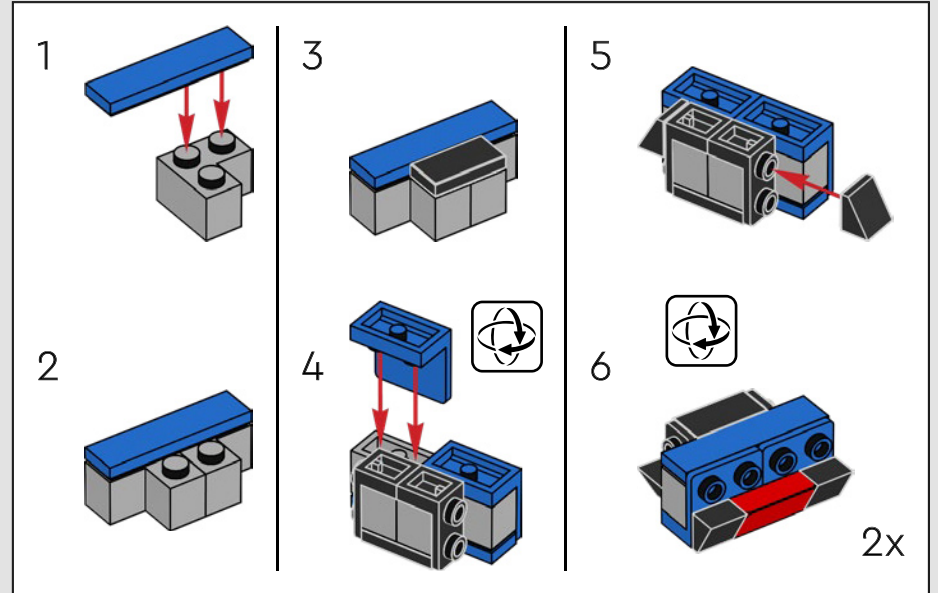

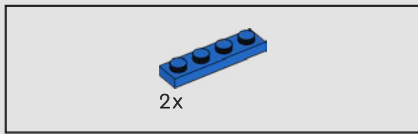

51

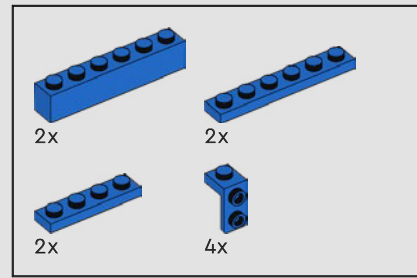
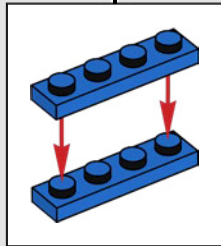
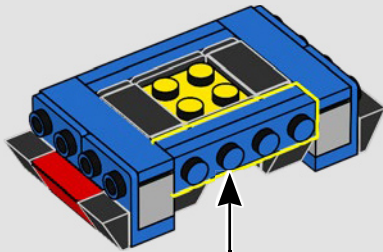

52

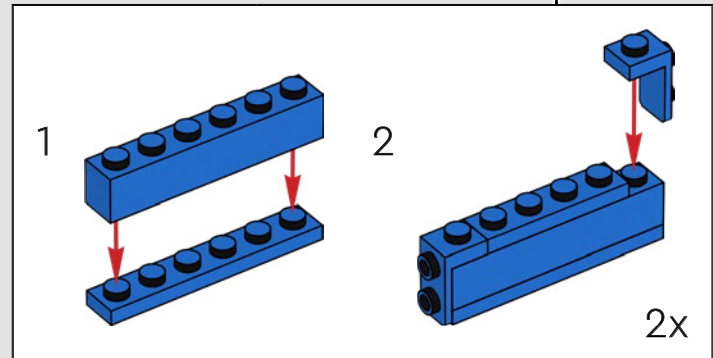
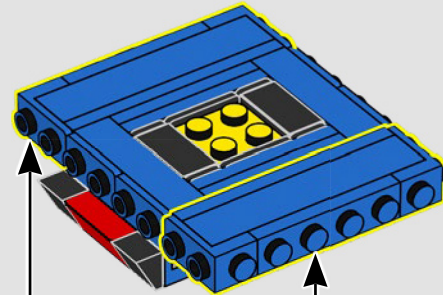

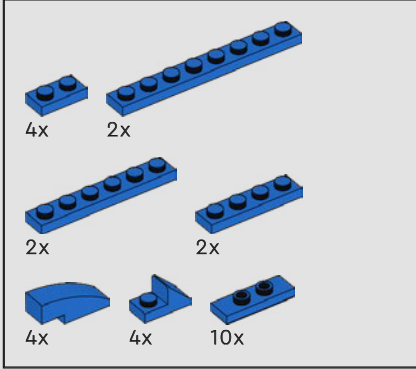
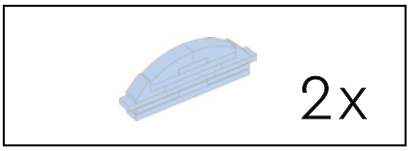

53

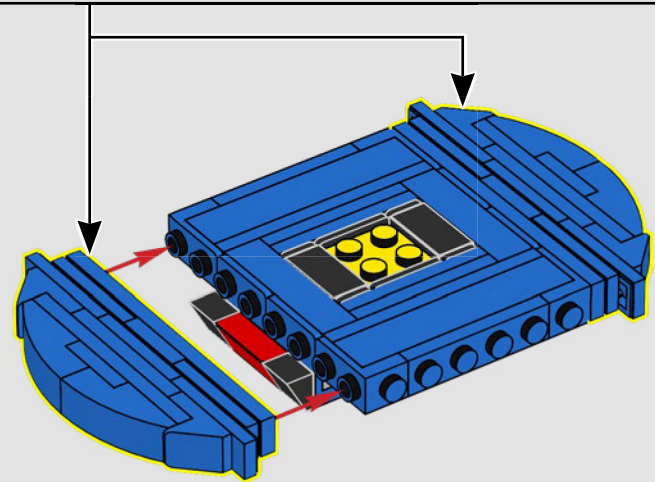
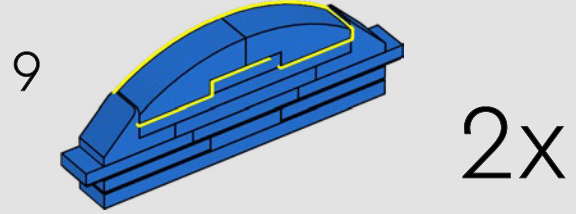
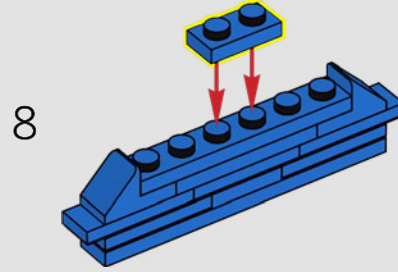
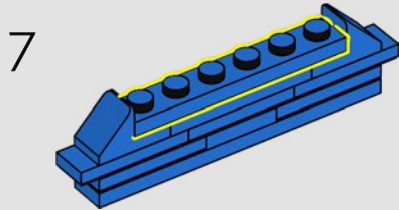
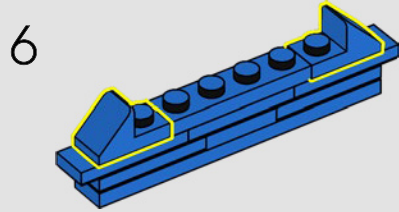
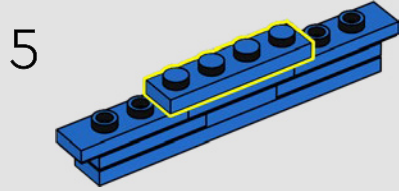
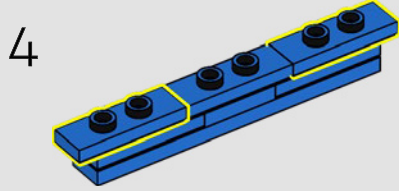
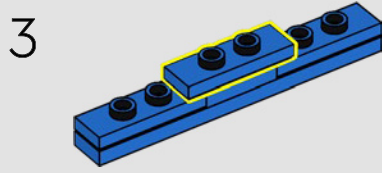
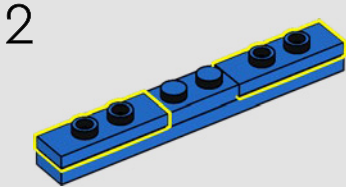
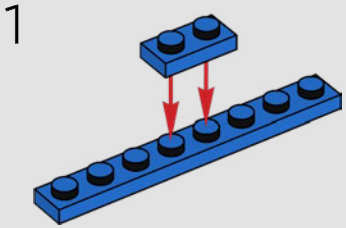

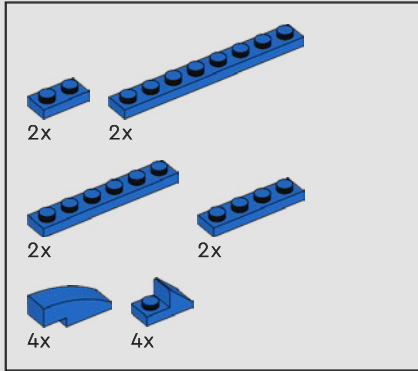
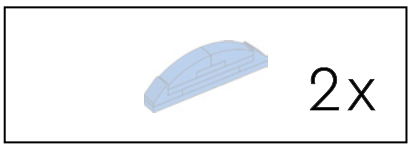

54

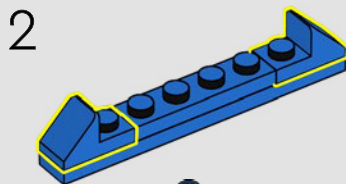
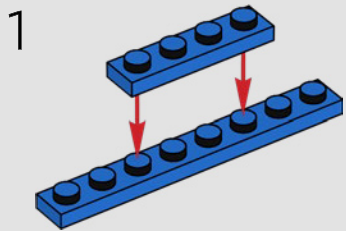

3

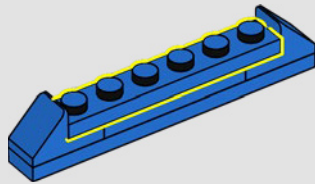

4

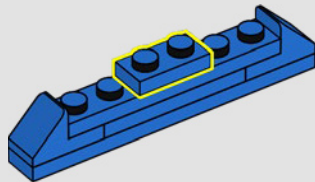

5

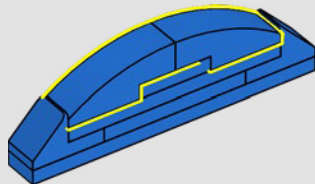

2x

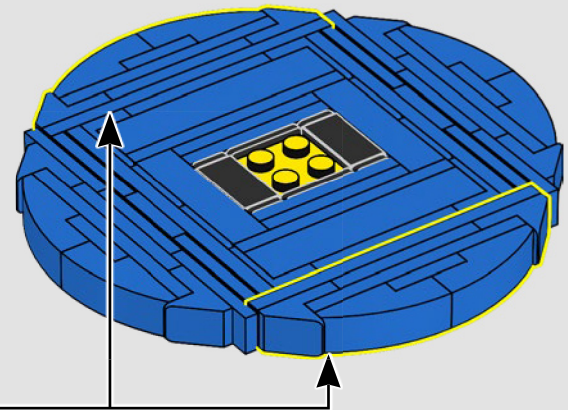



1x

55

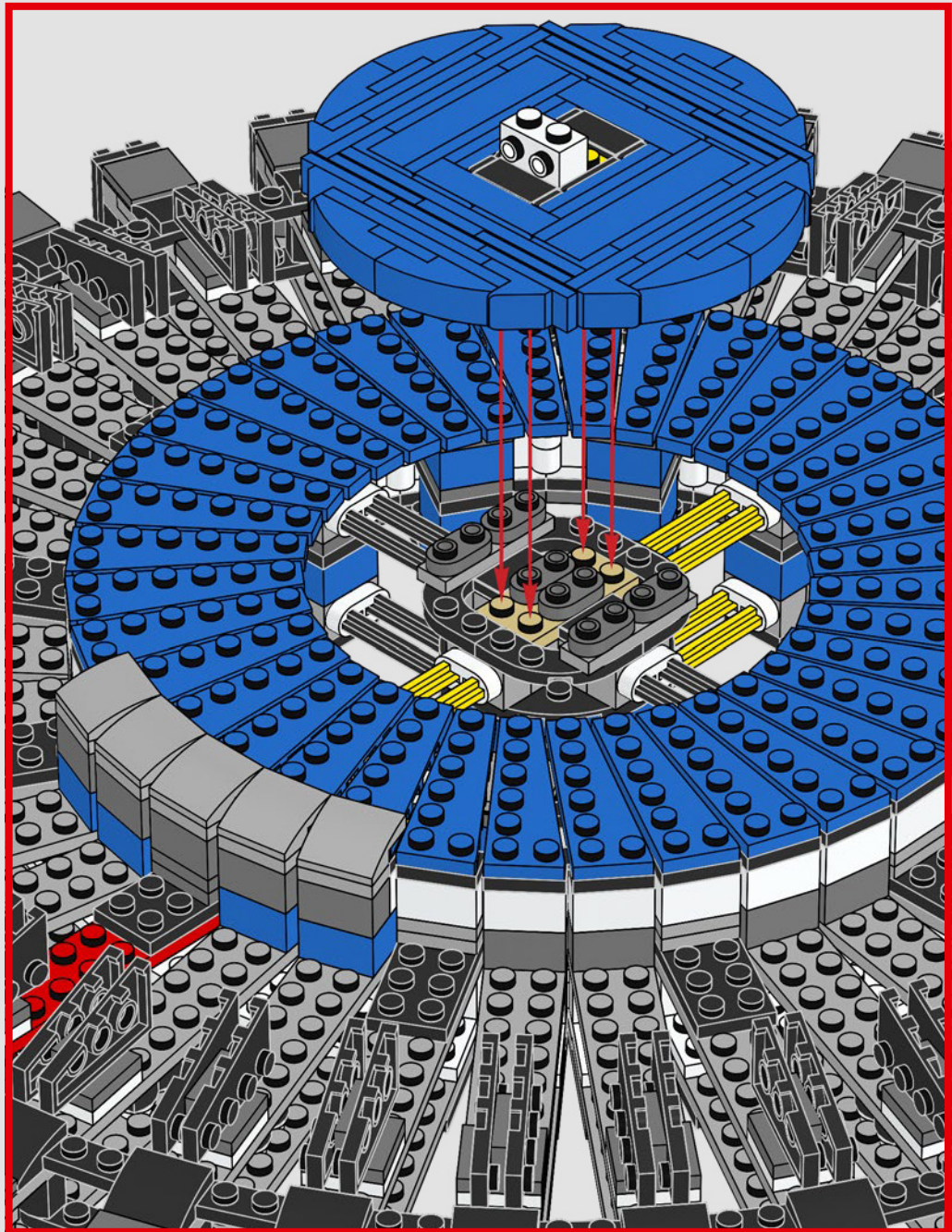
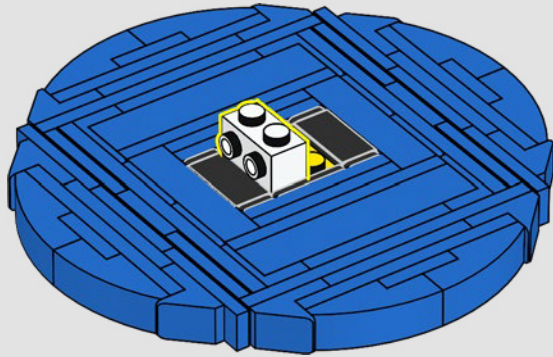

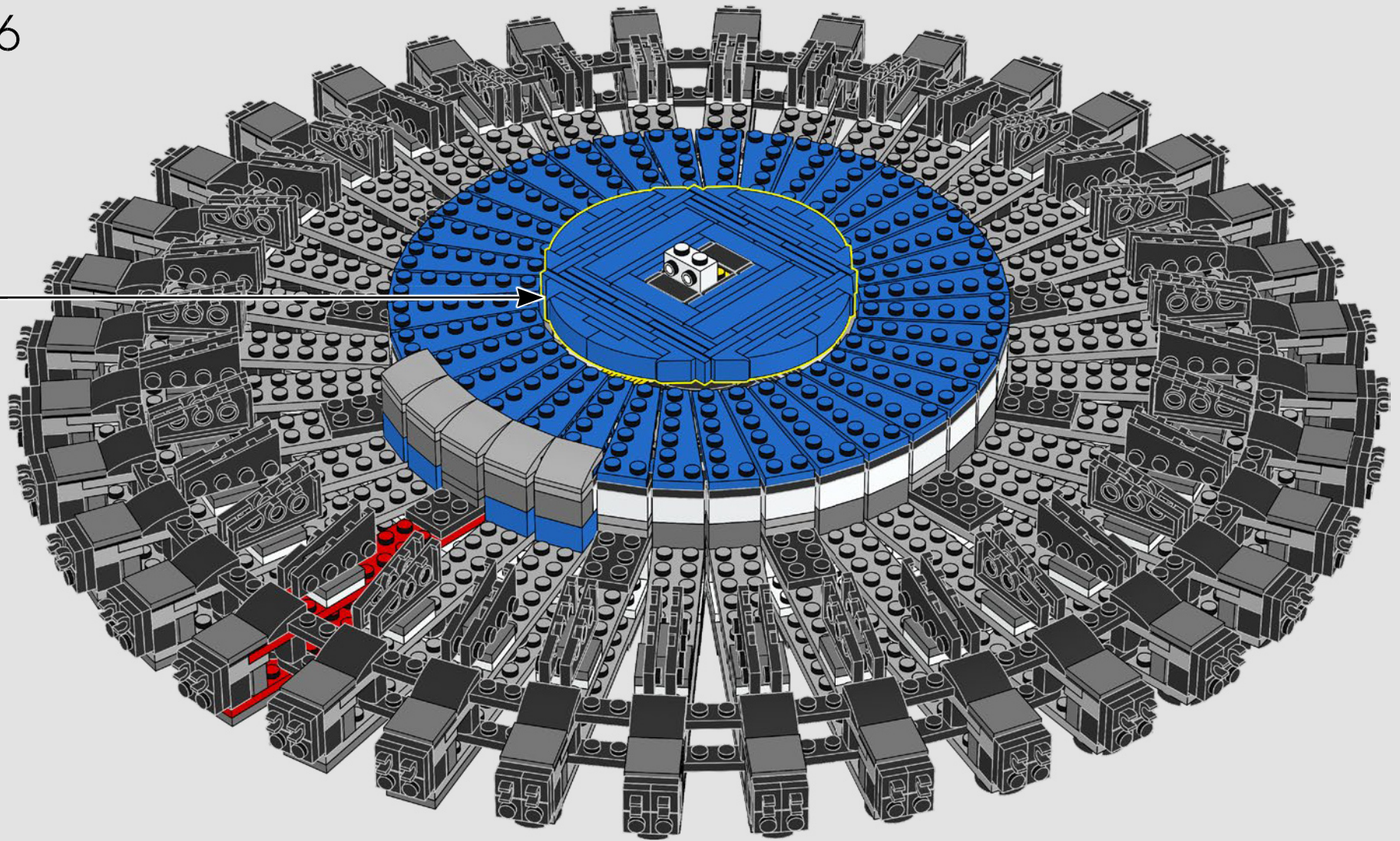

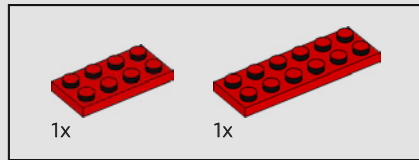
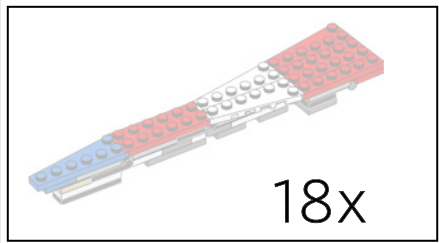

57

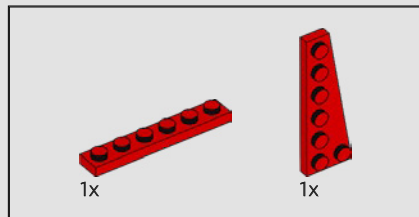
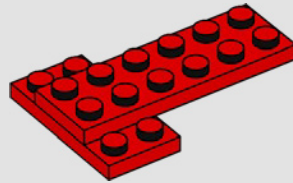

58

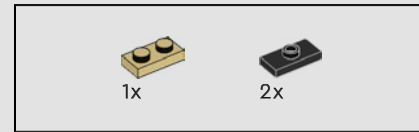
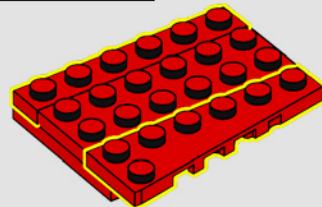

59

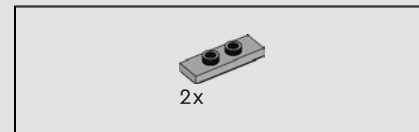
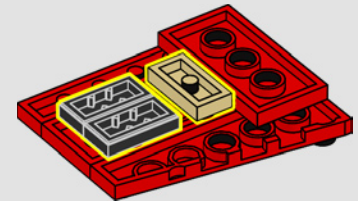
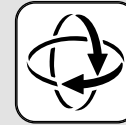

60

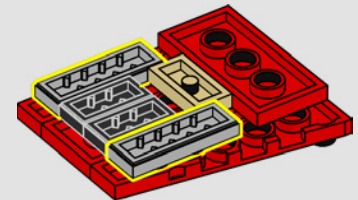

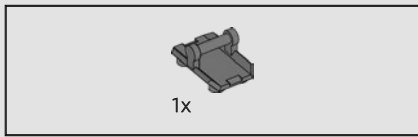

61

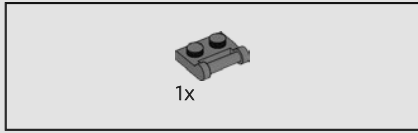
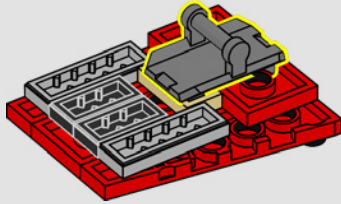

62

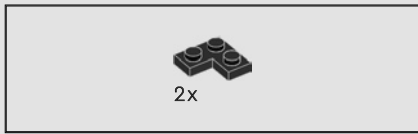
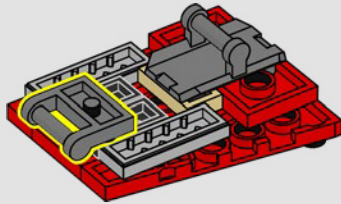

63

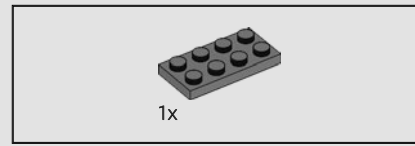
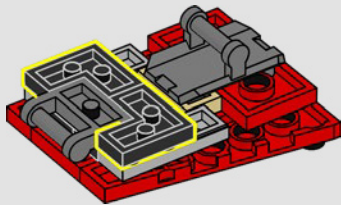

64

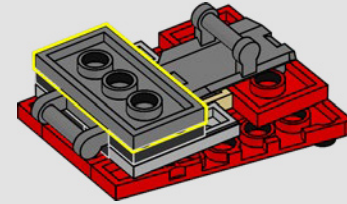

65

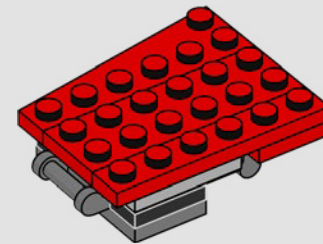
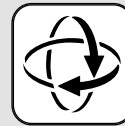

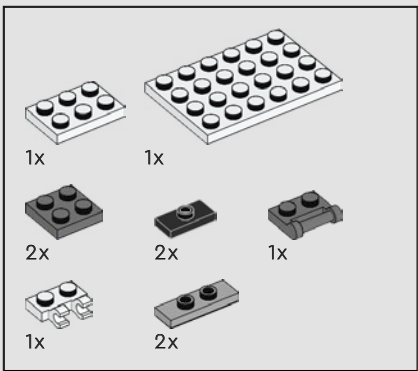

66

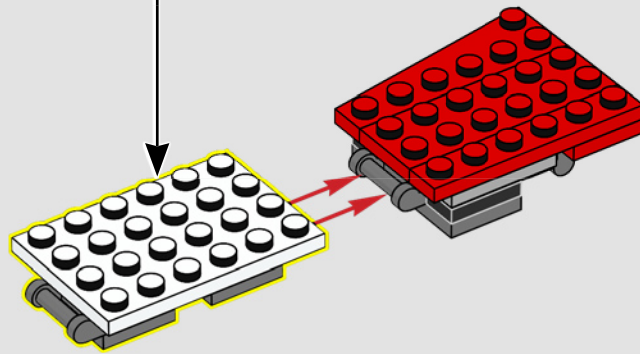
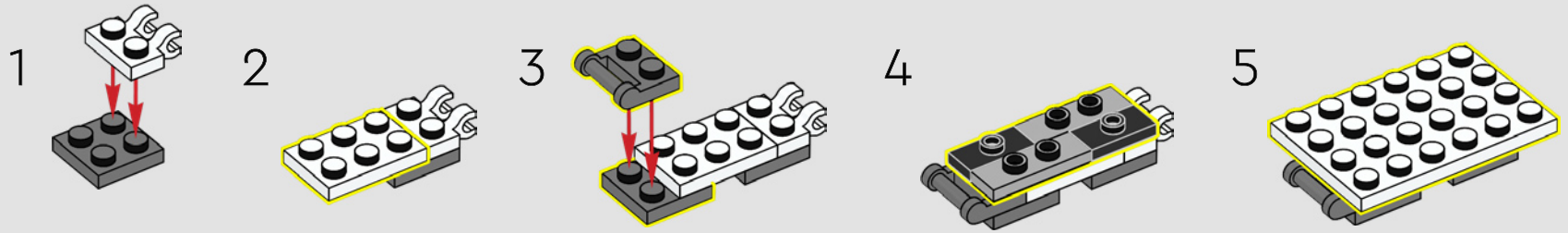

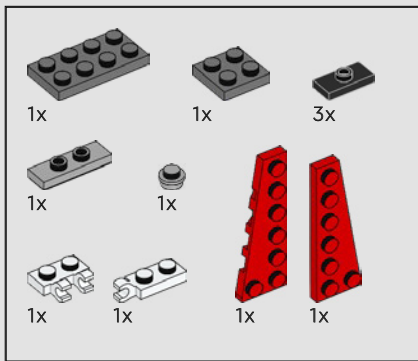

67

1

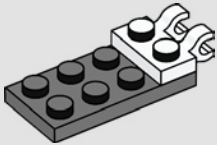

2

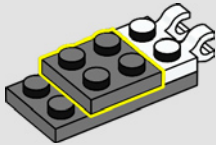

3

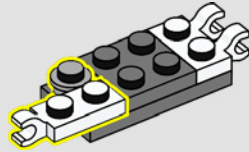

4

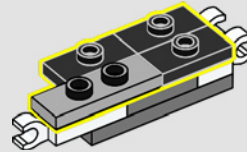

5

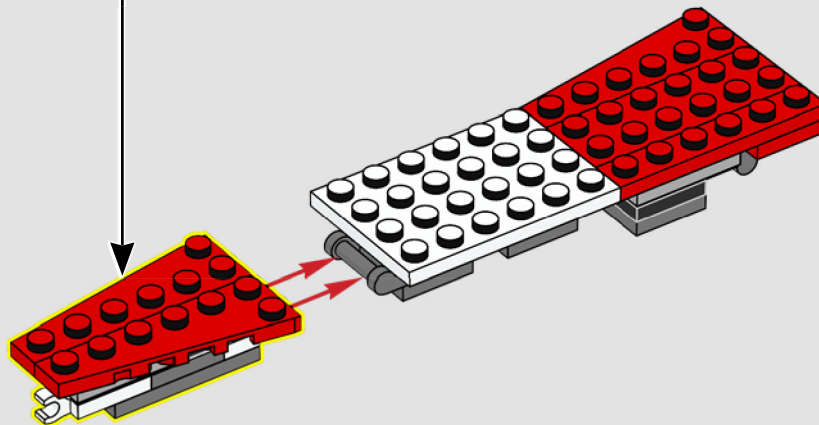
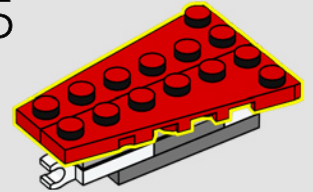

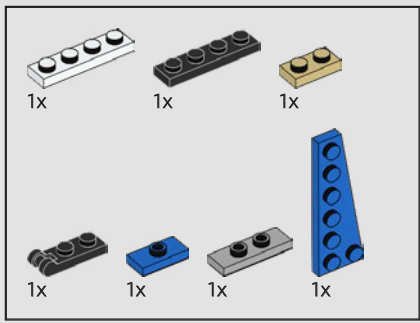

68

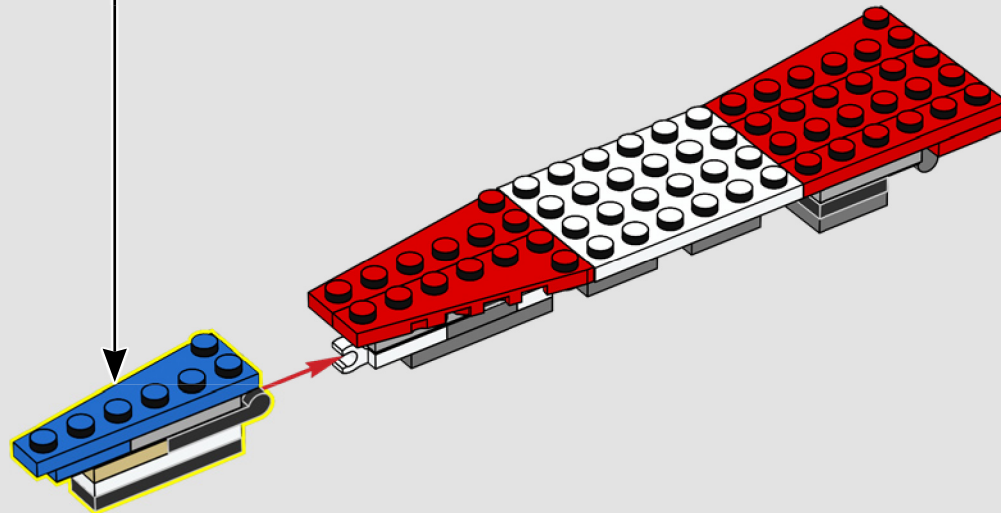
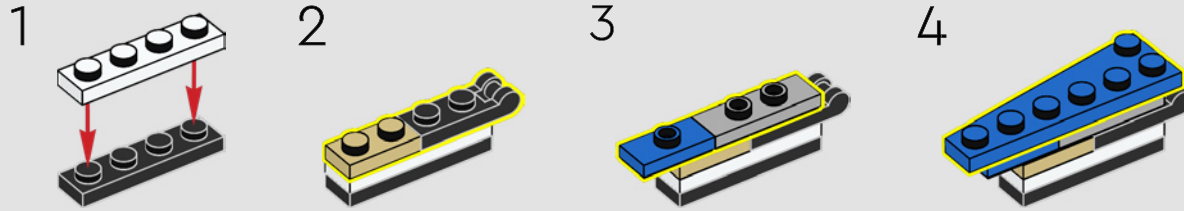

18x

69

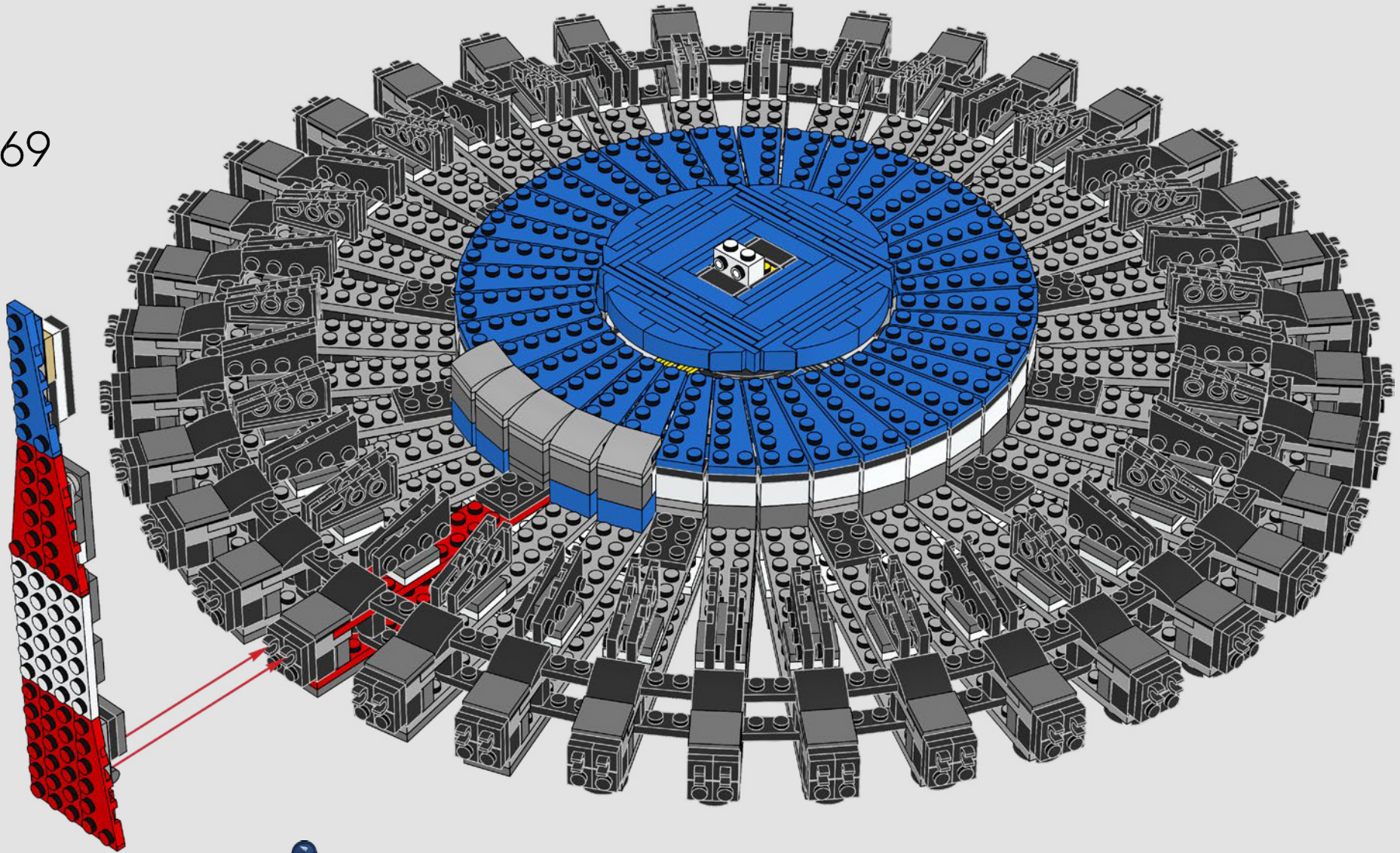

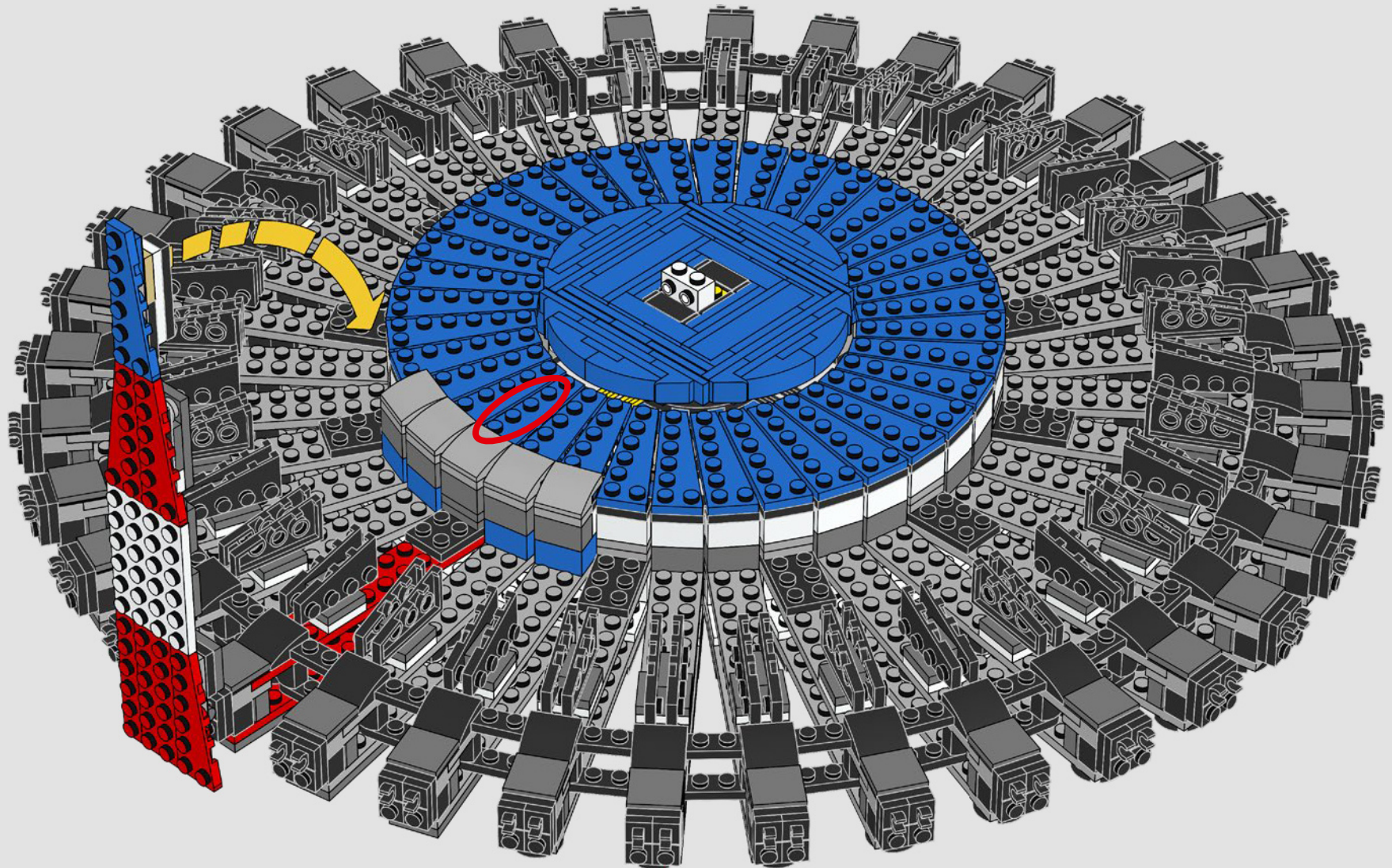

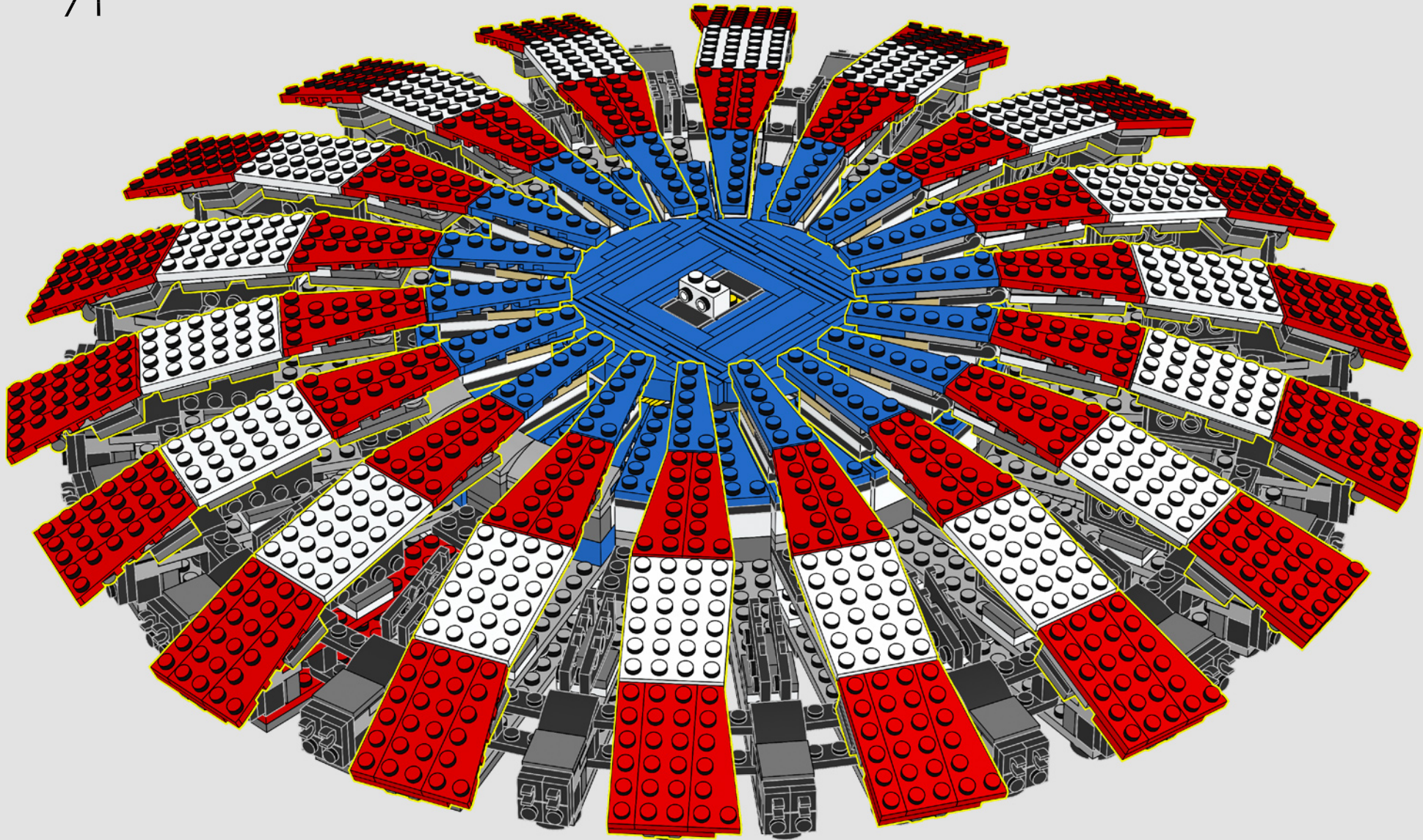

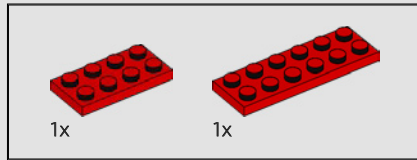
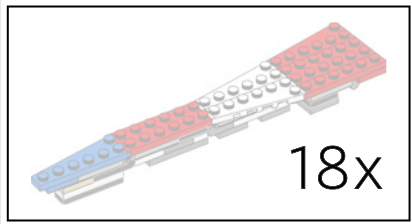
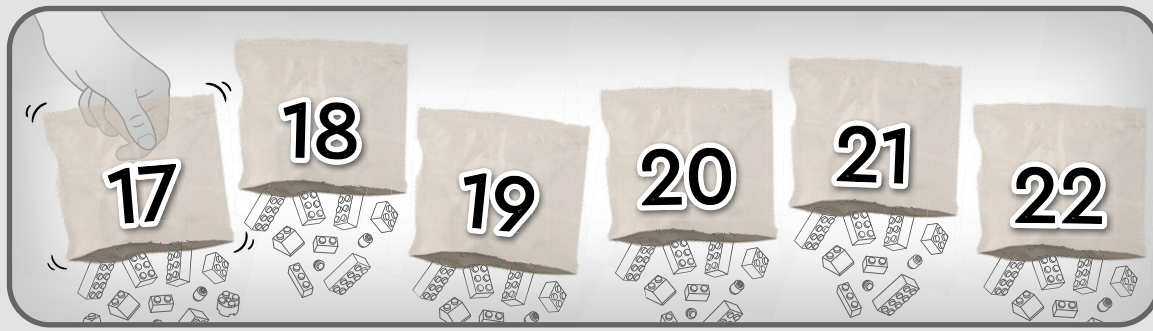

72

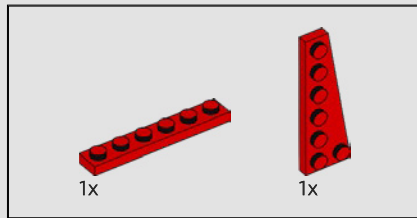
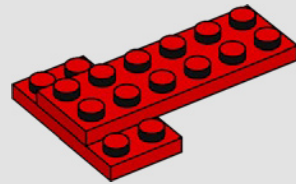

73

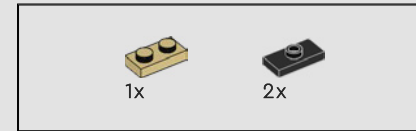
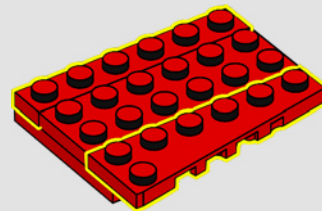

74

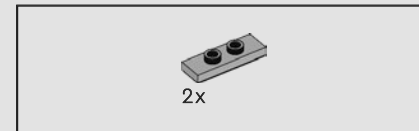
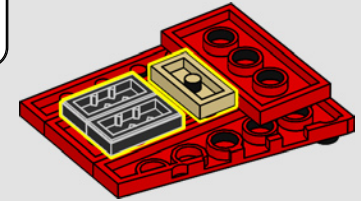
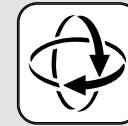

75

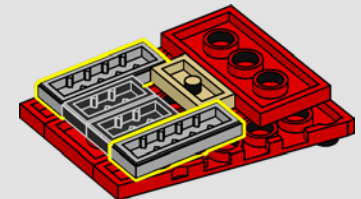

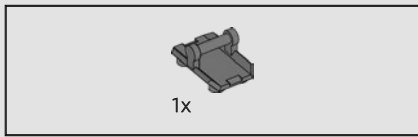

76

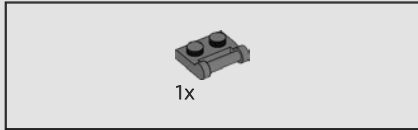
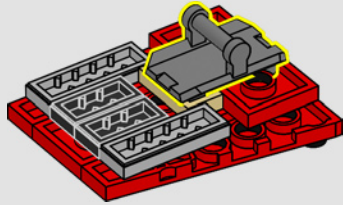

77

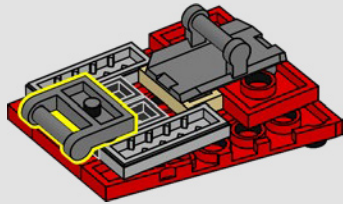

78

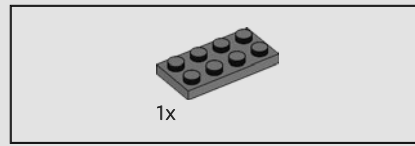
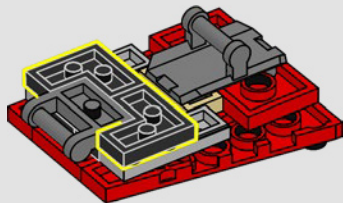

79

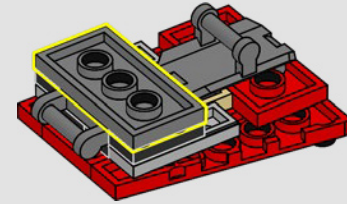

80

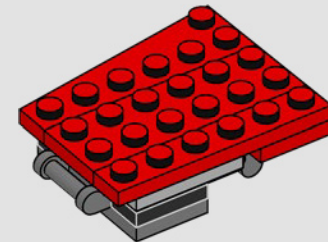
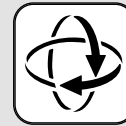

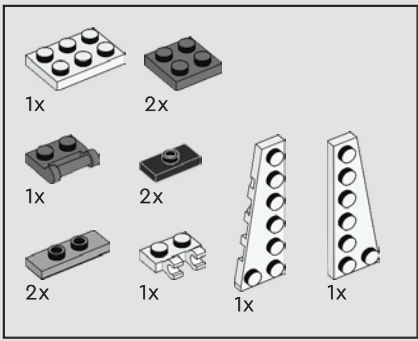

81

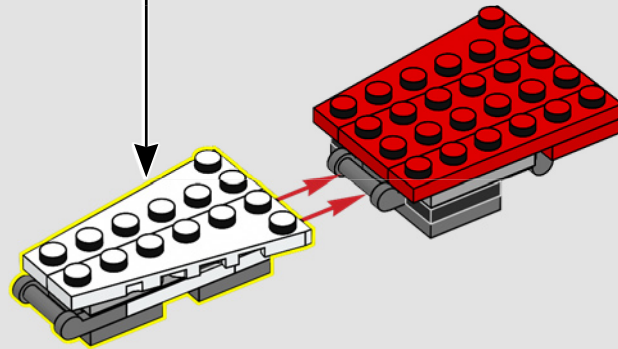
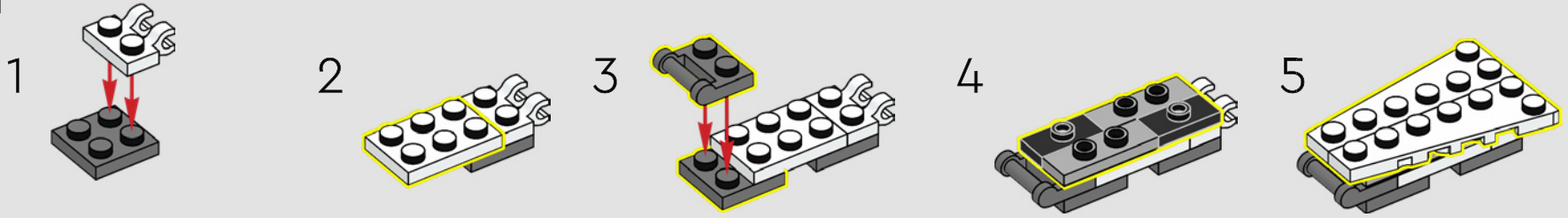

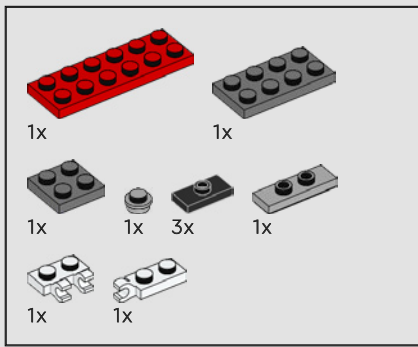

82

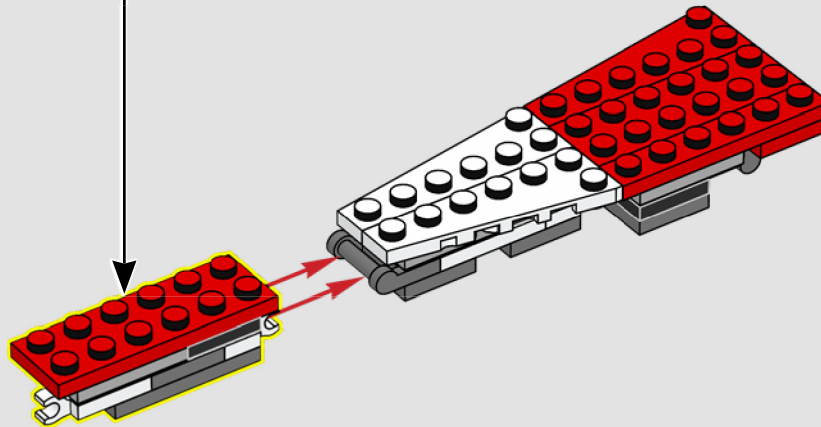
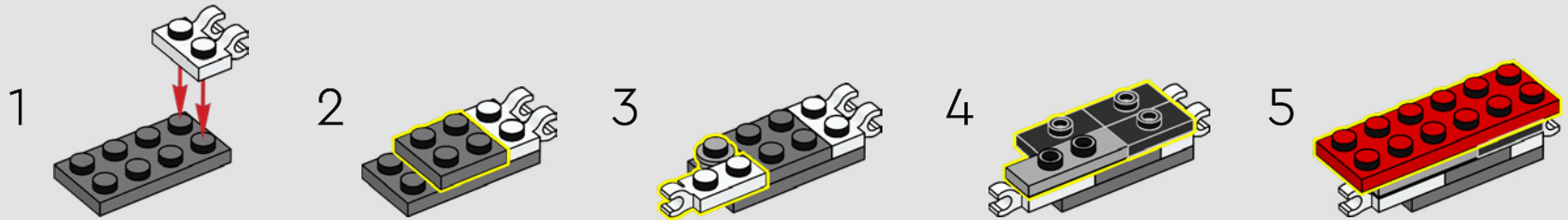

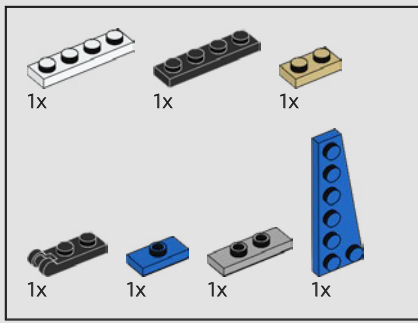

83

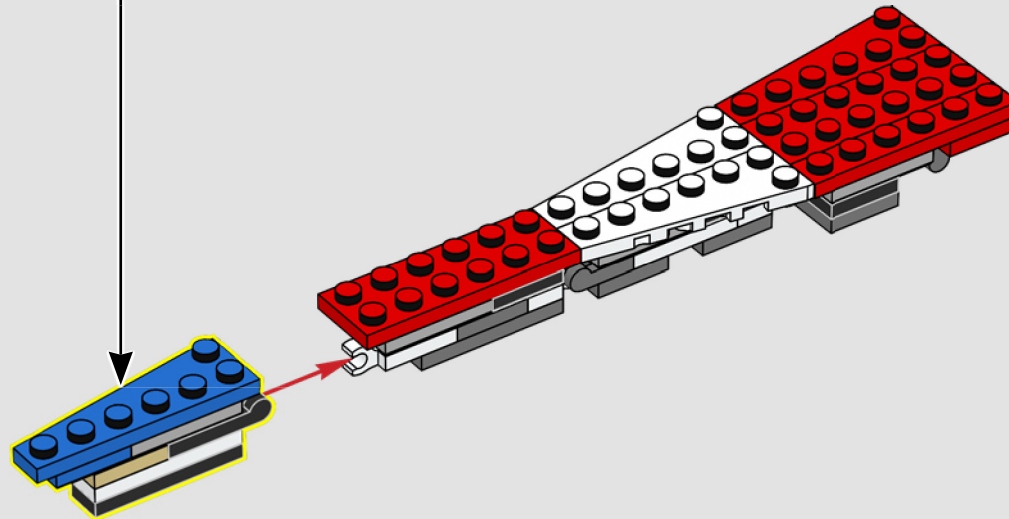
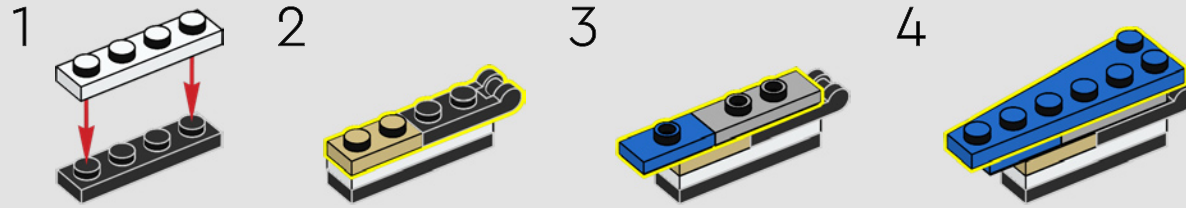

84

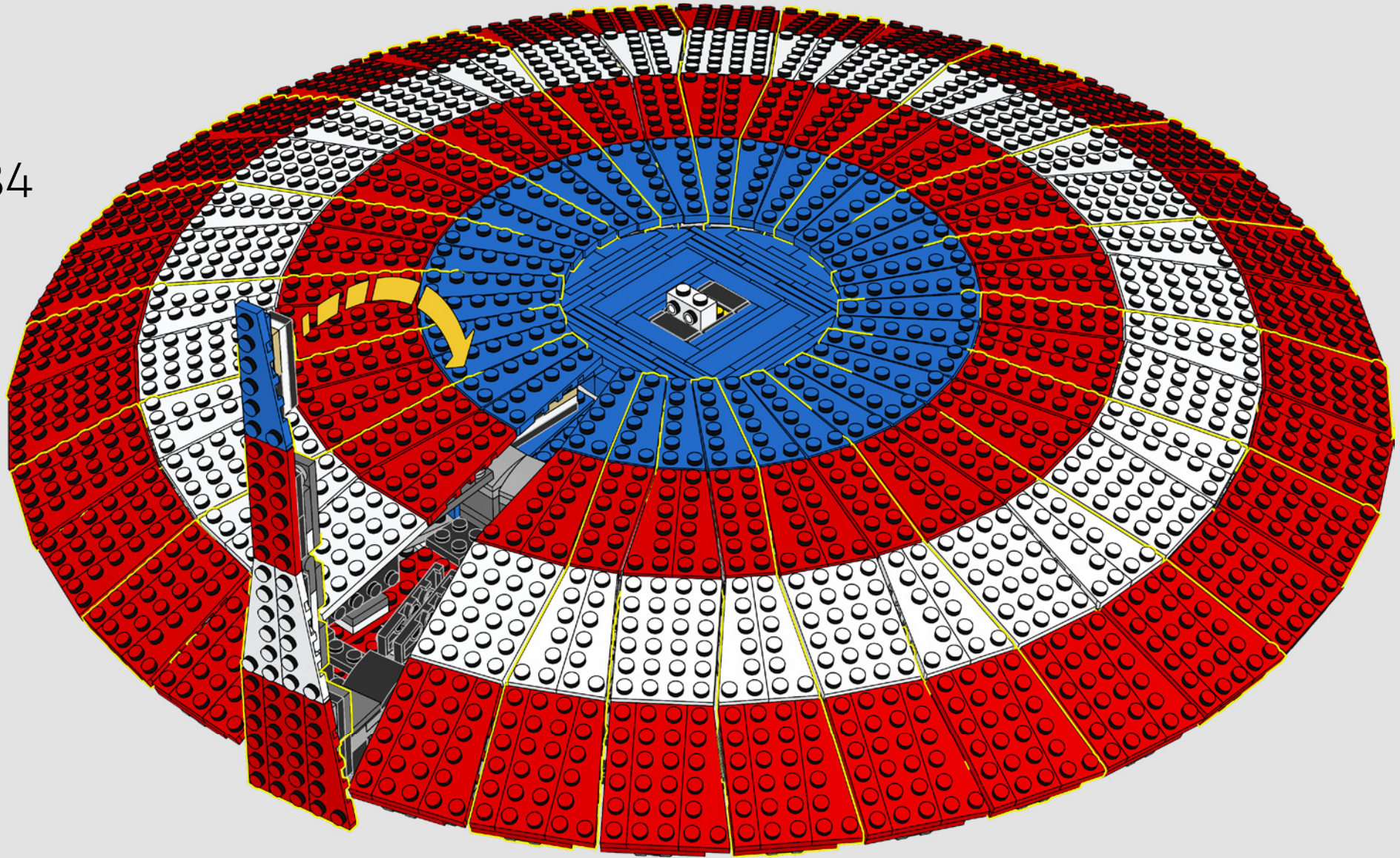

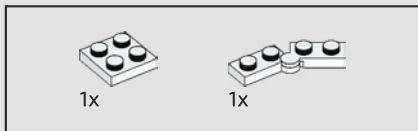
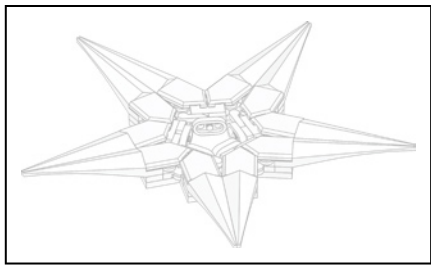

85

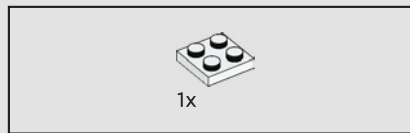
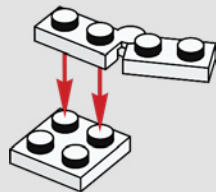

86

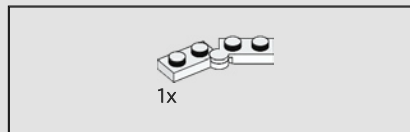
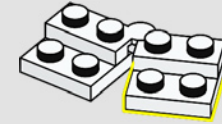

87

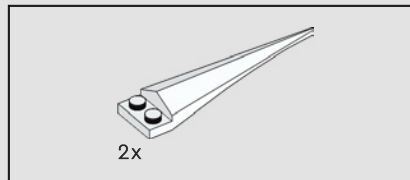
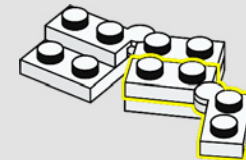

88

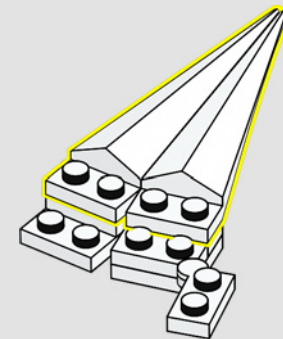

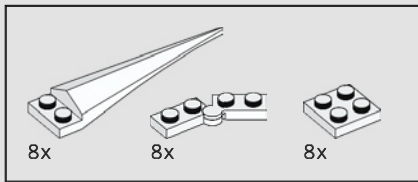

89

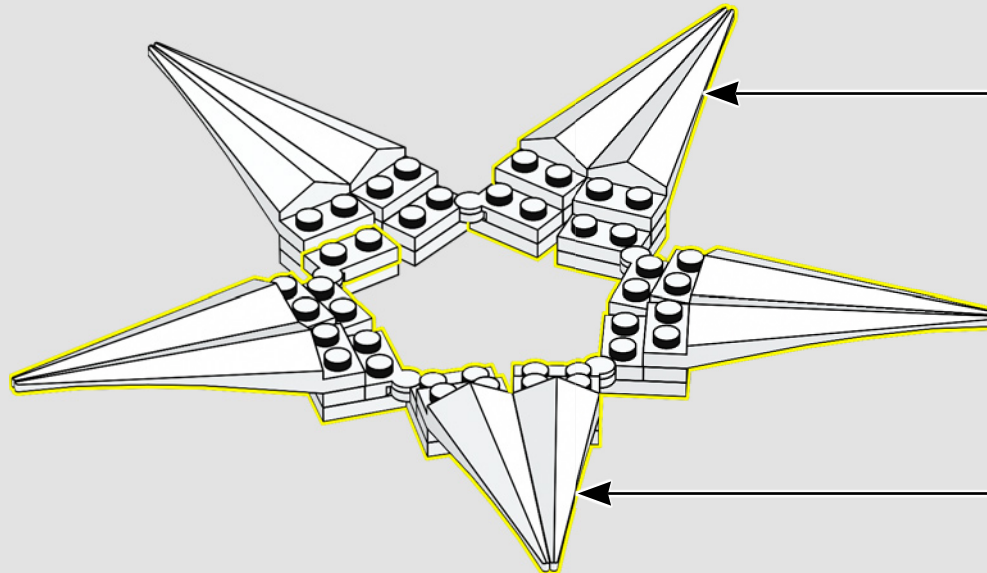
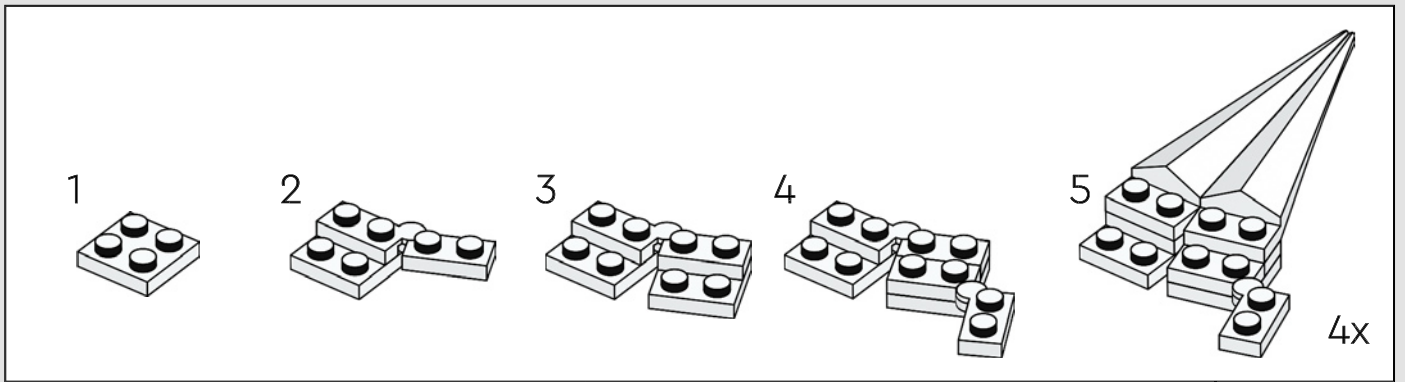

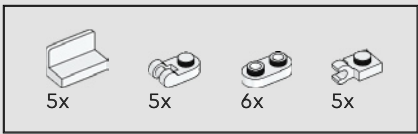

90

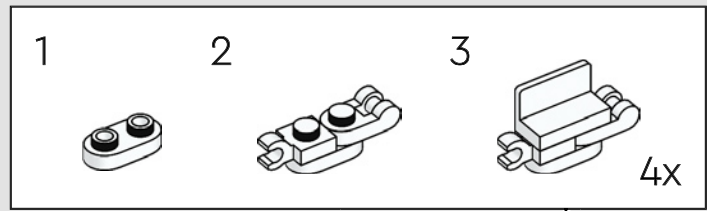

1



2

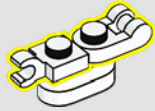

3

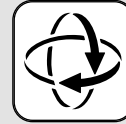

4

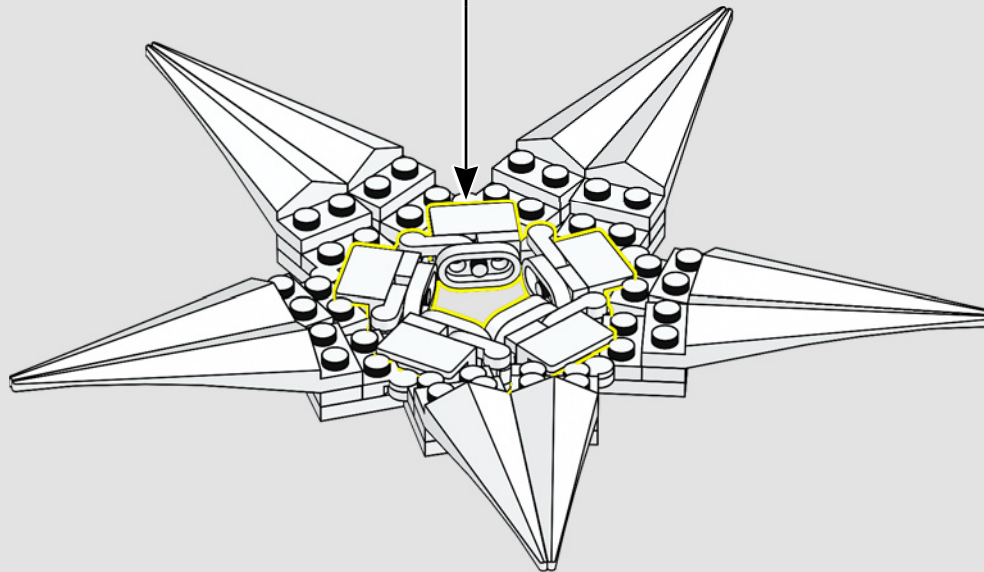
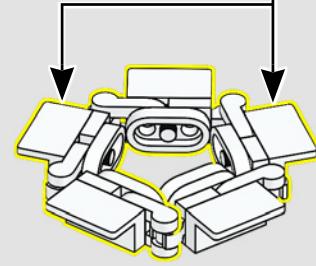



91

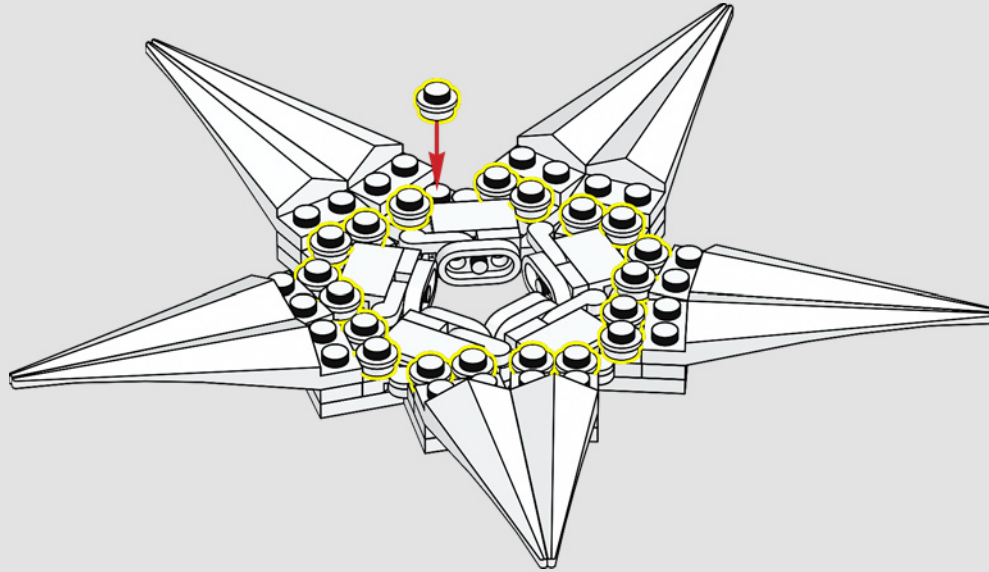

92

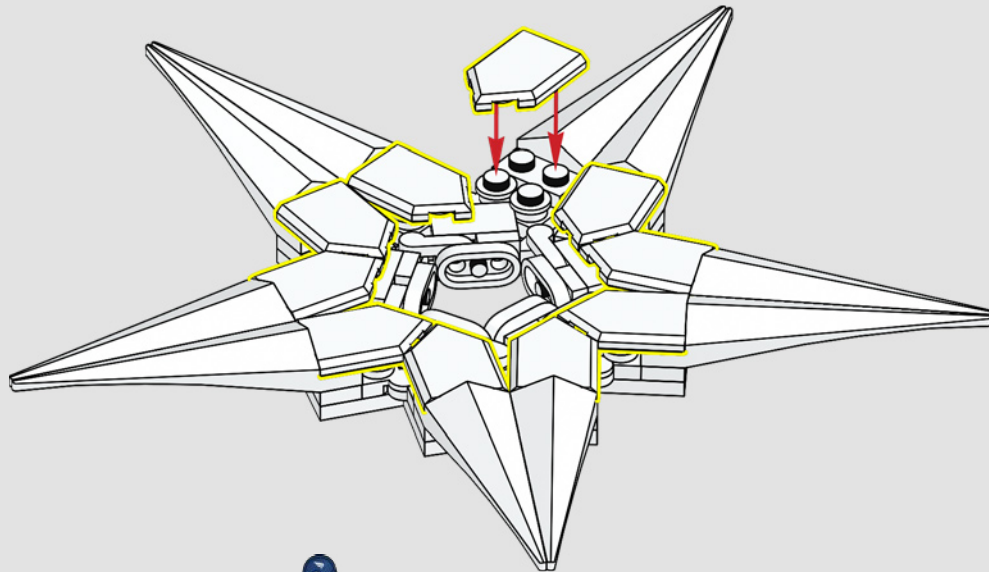

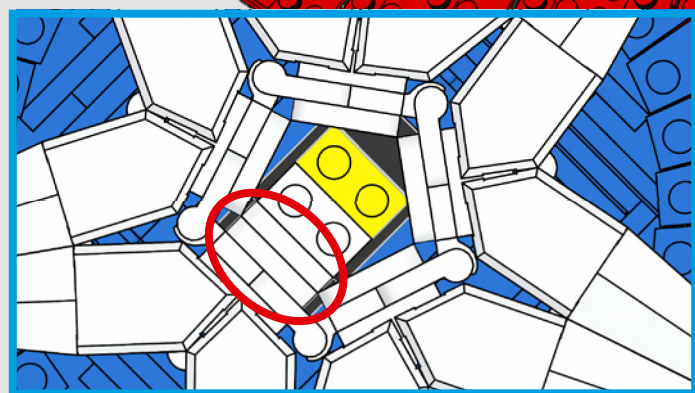
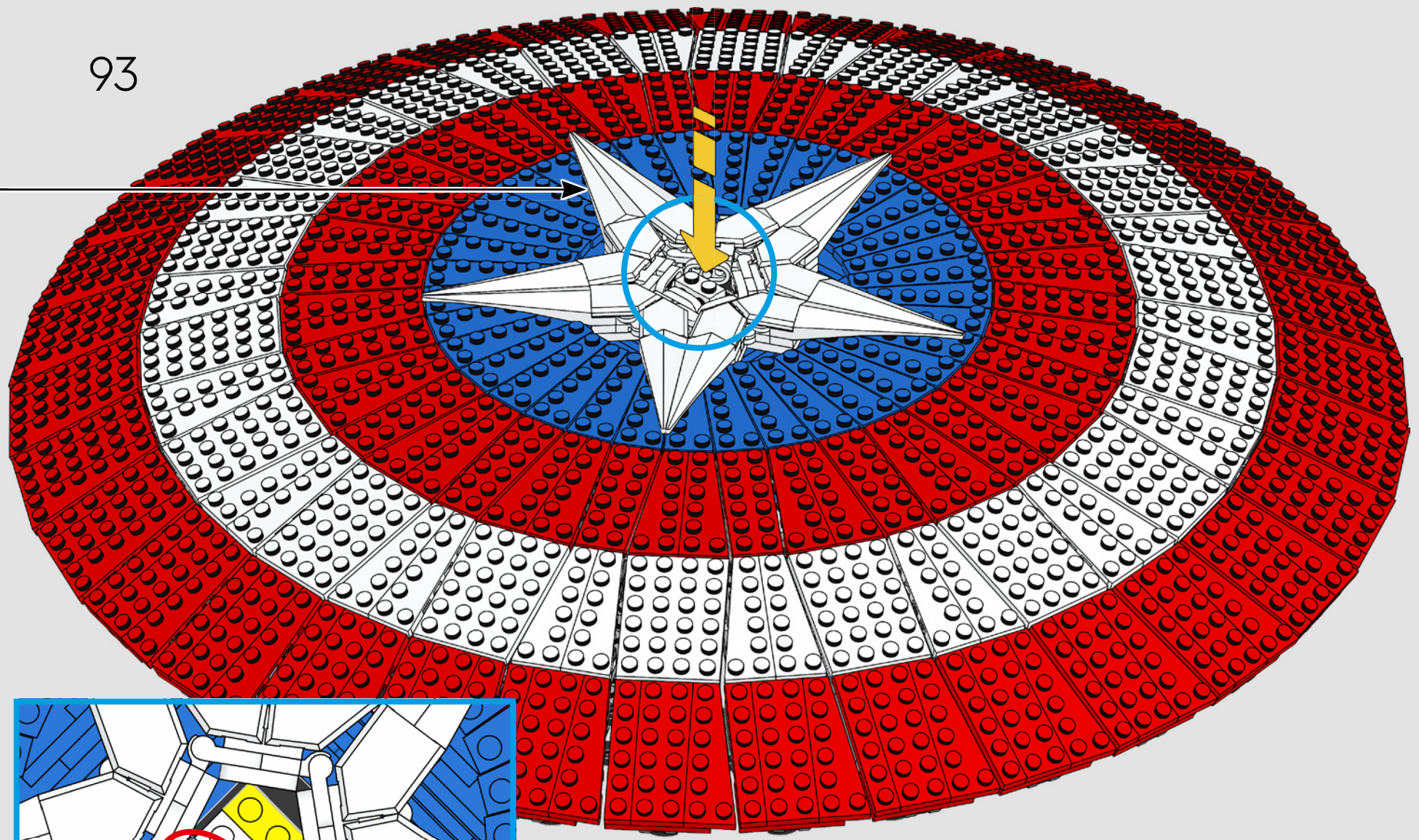

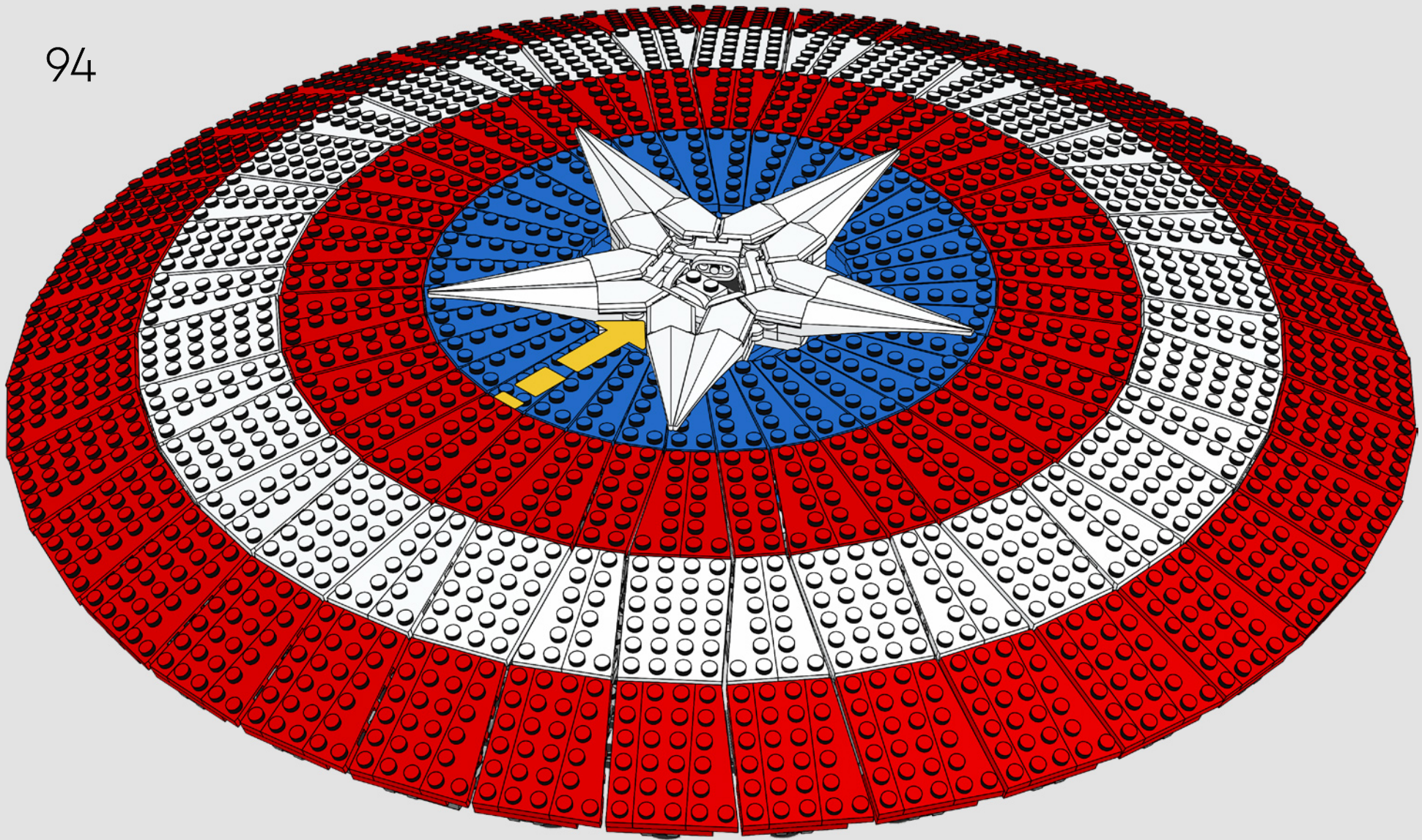



1x

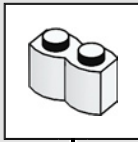

95

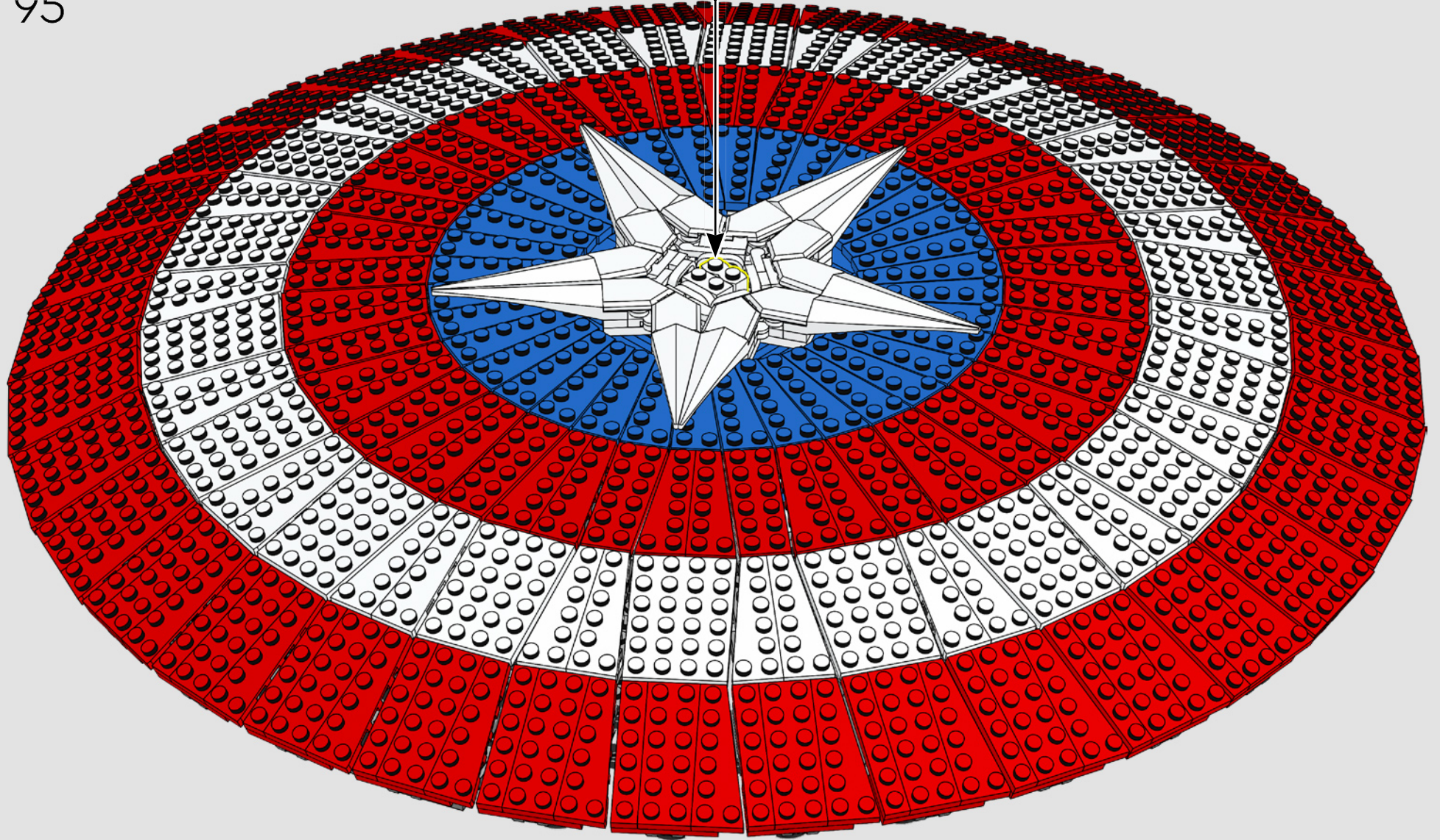

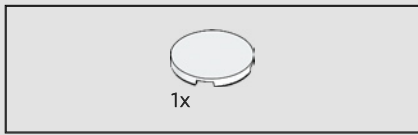

96

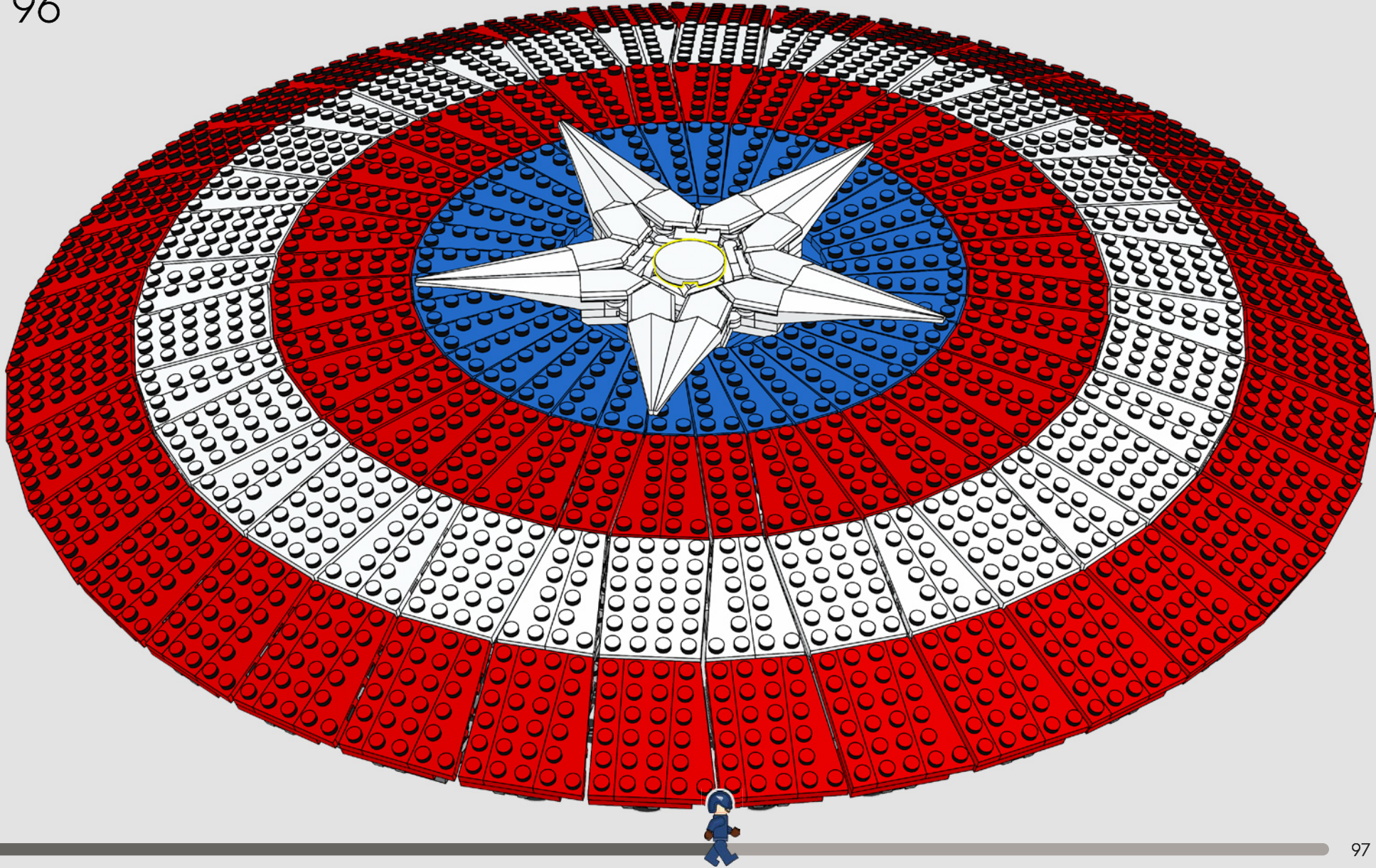

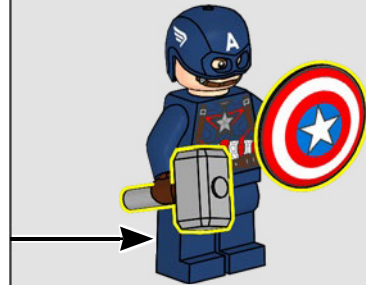
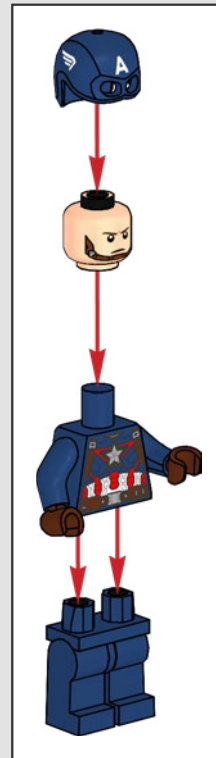
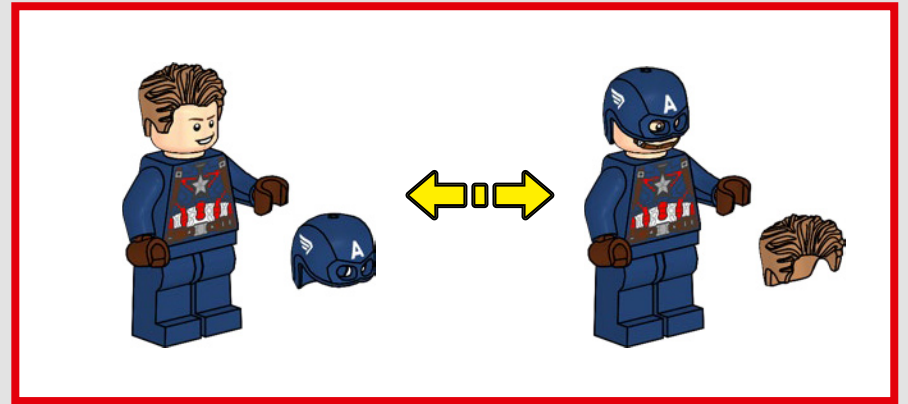

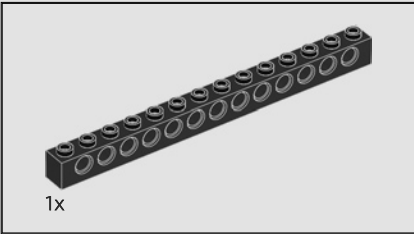
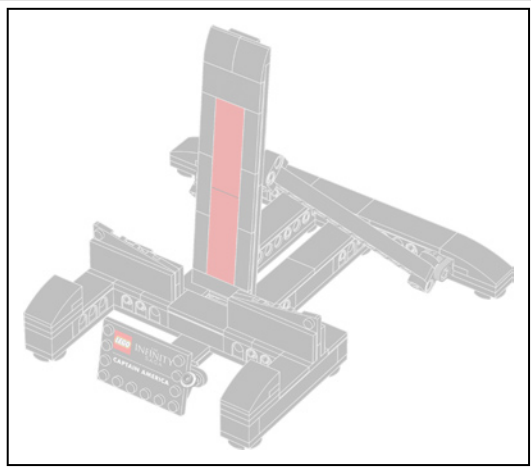

97

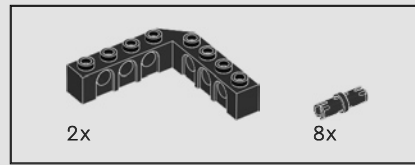
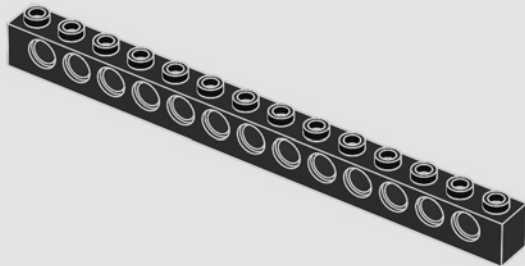

98

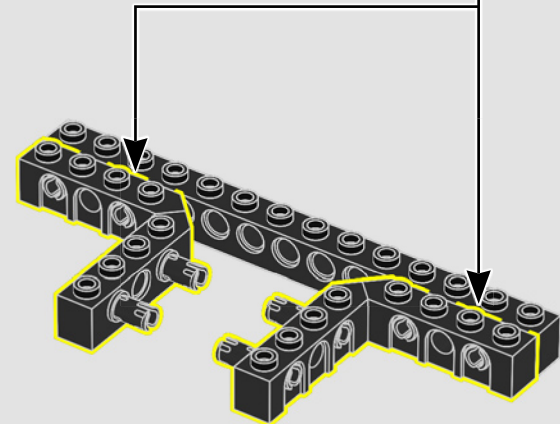
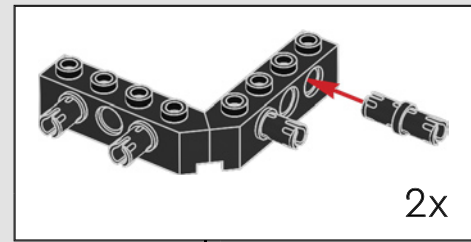

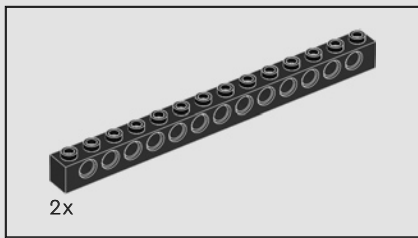

99

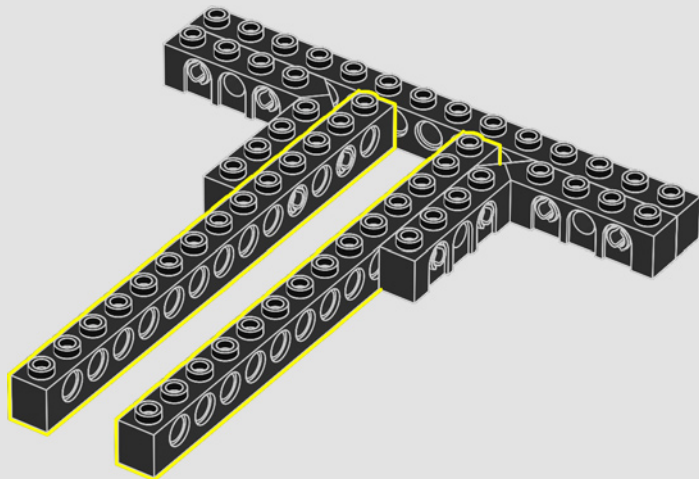

100

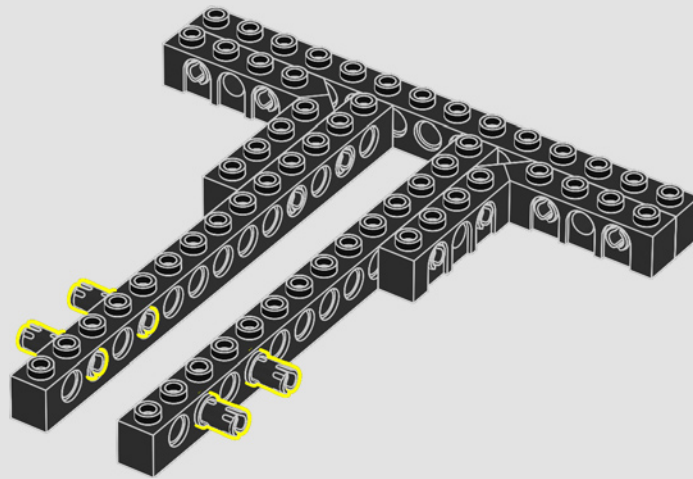

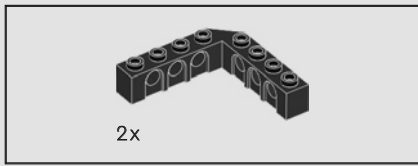

101

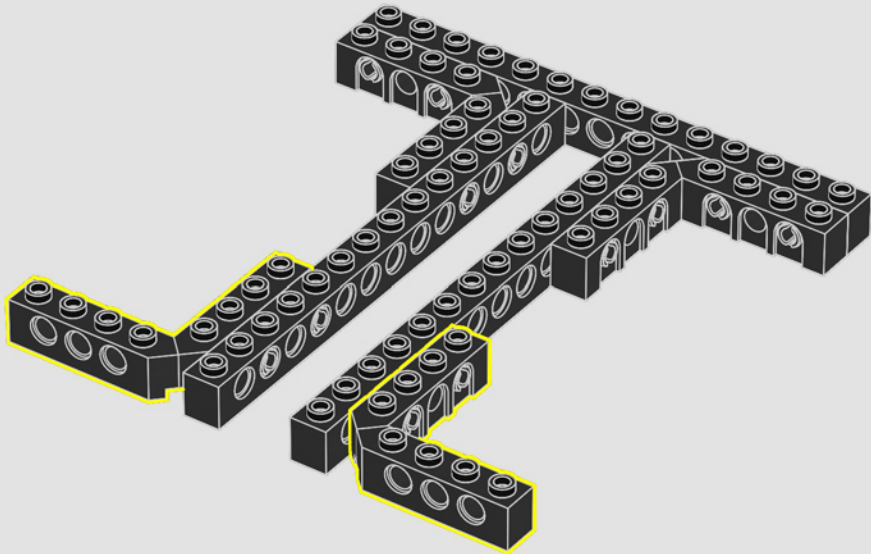

102

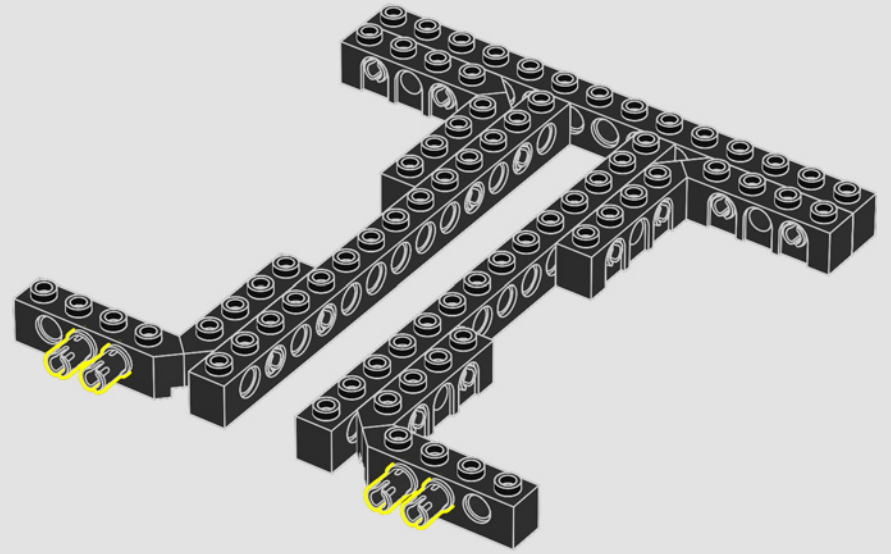

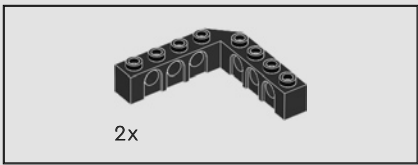

103

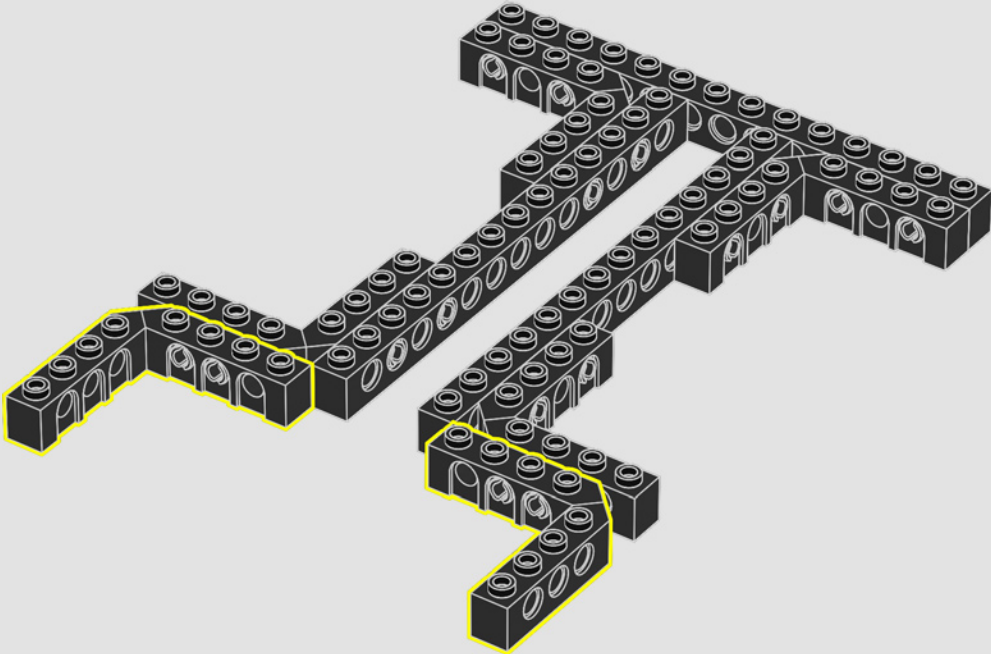

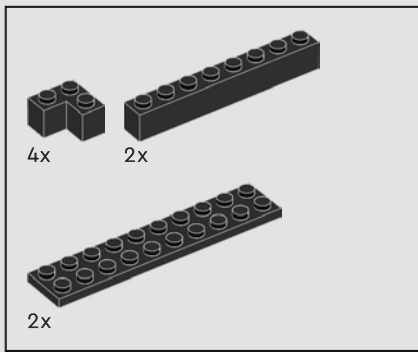

104

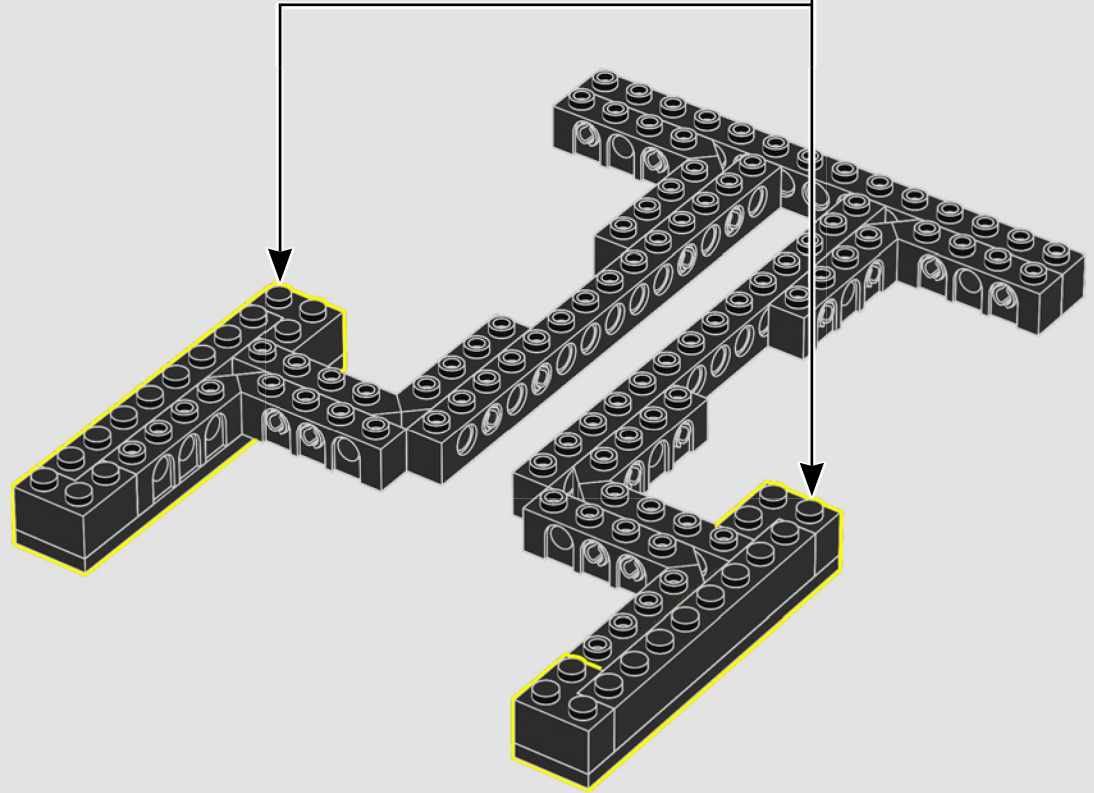
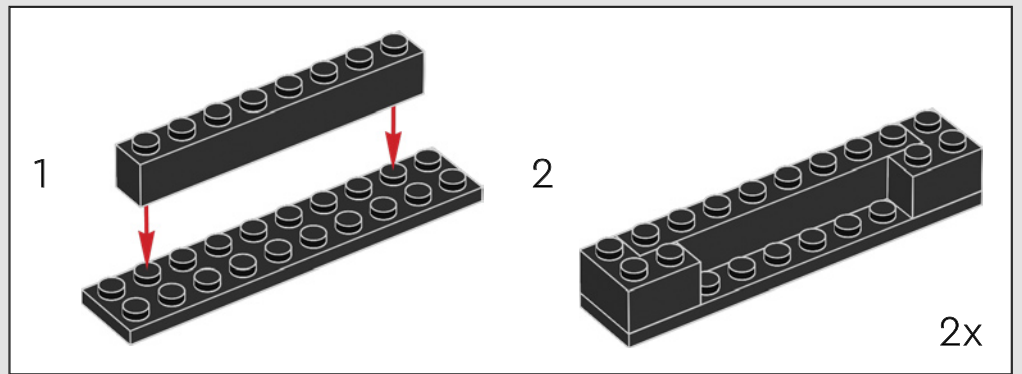
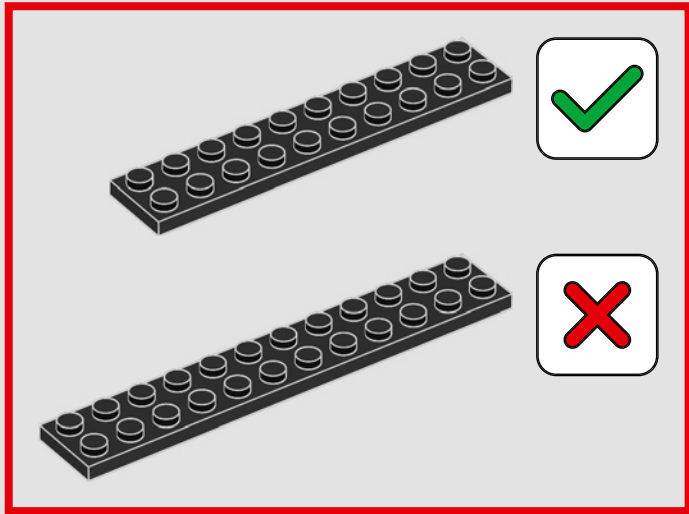

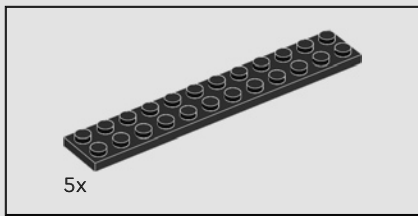

105

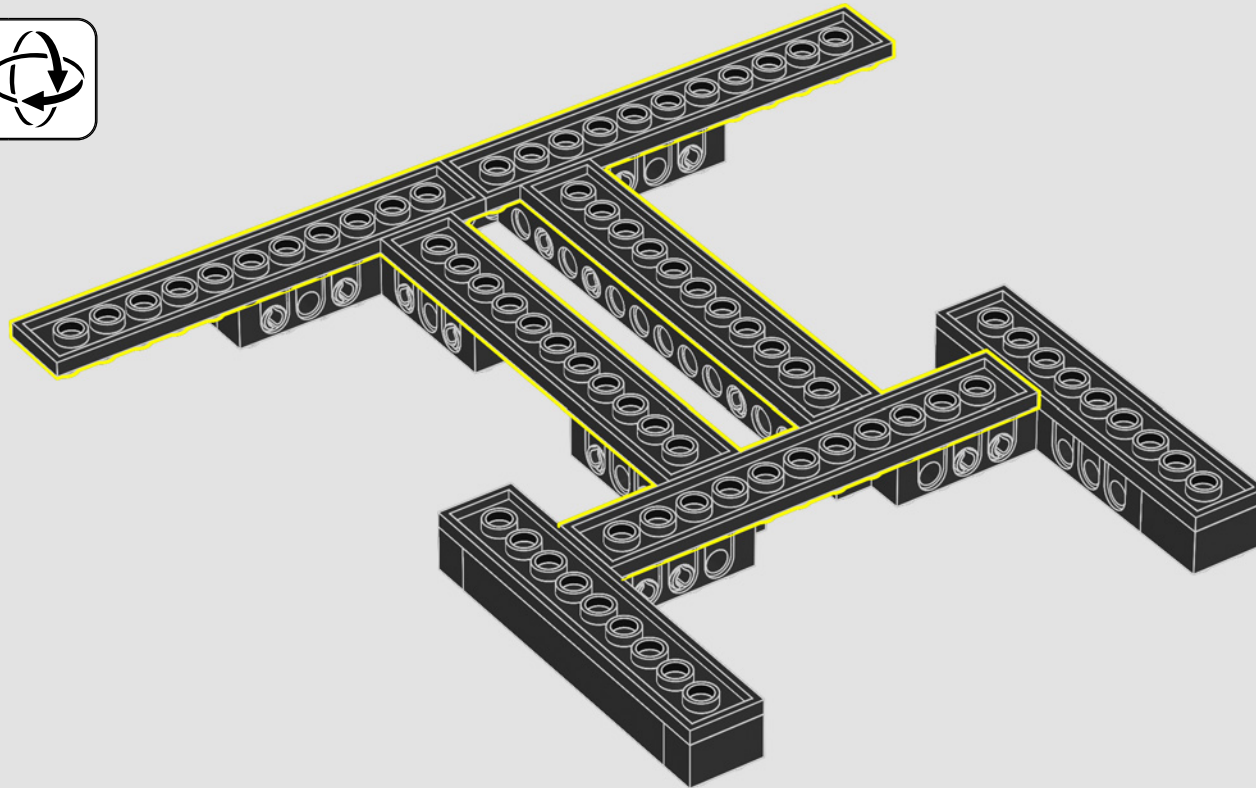

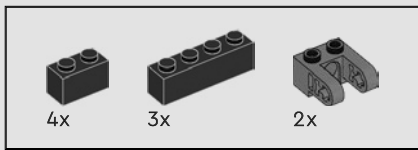

106

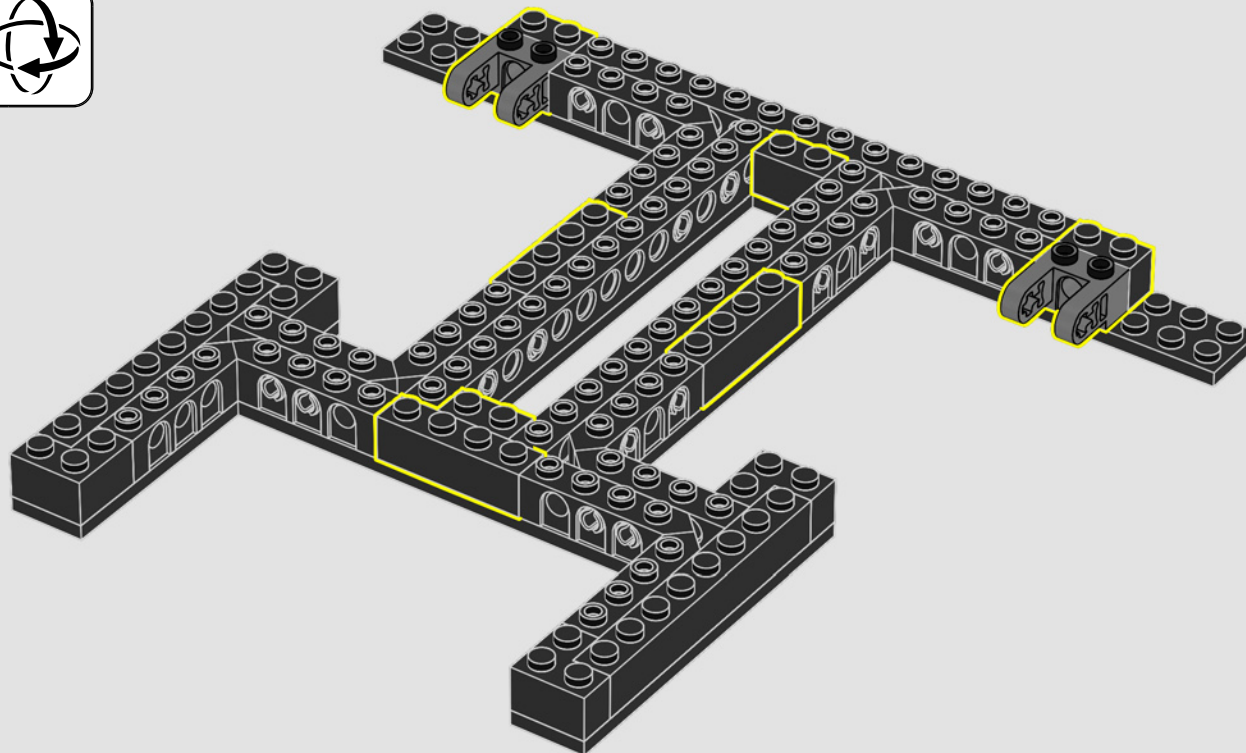

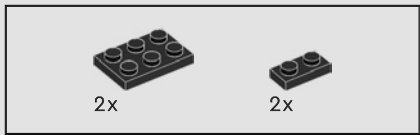

107

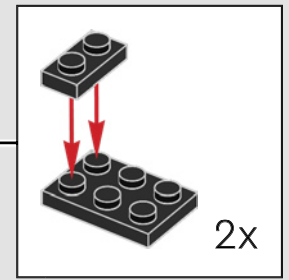
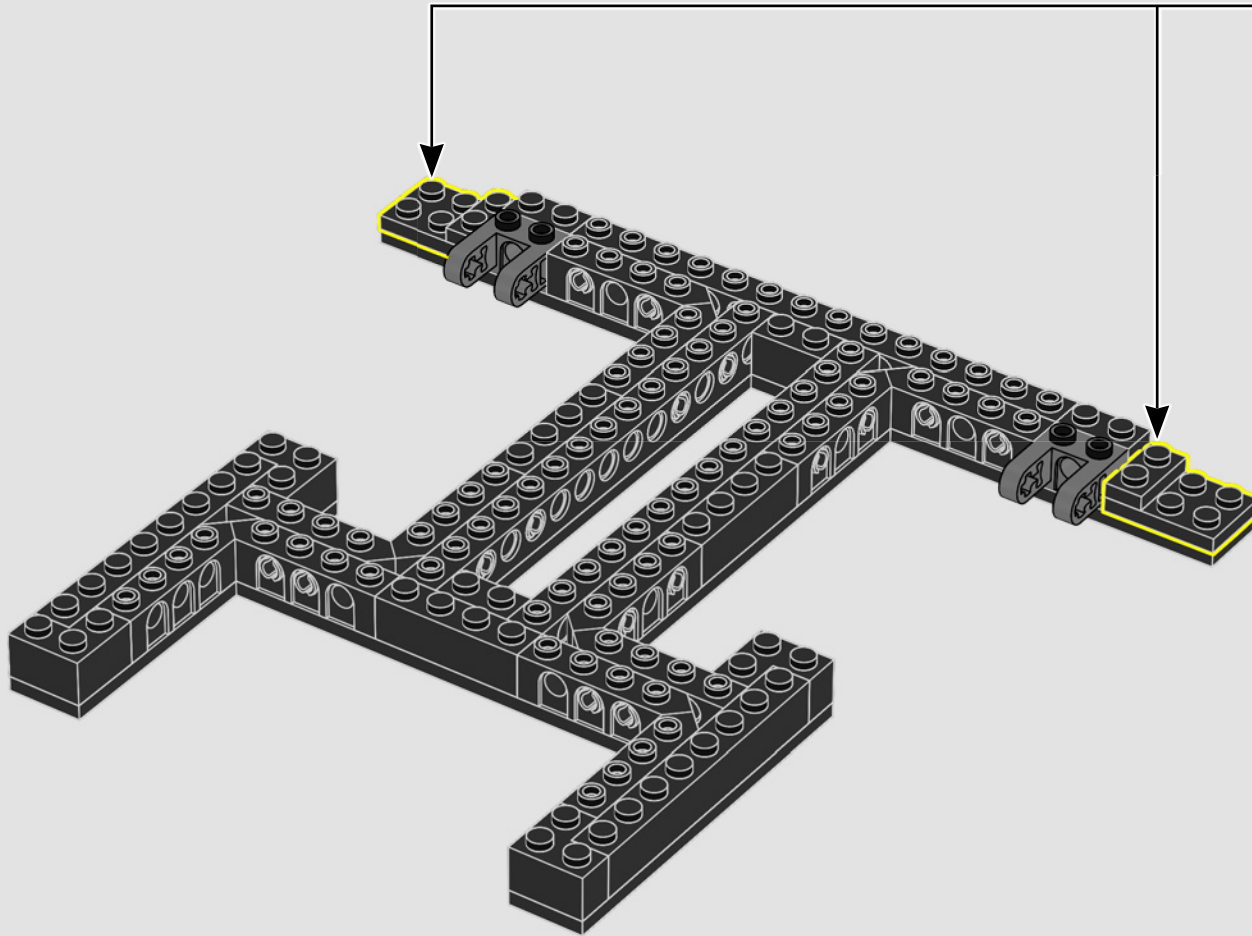



108

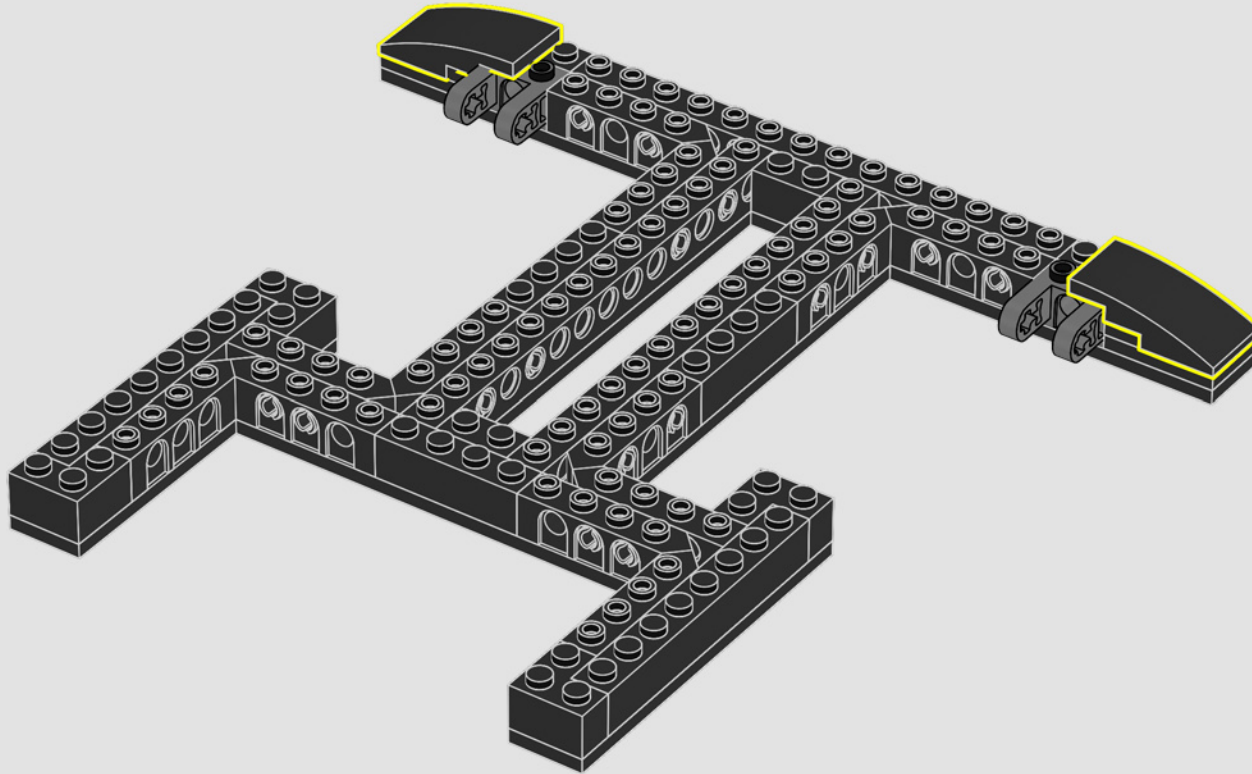

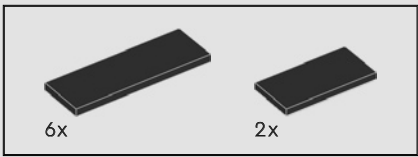

109

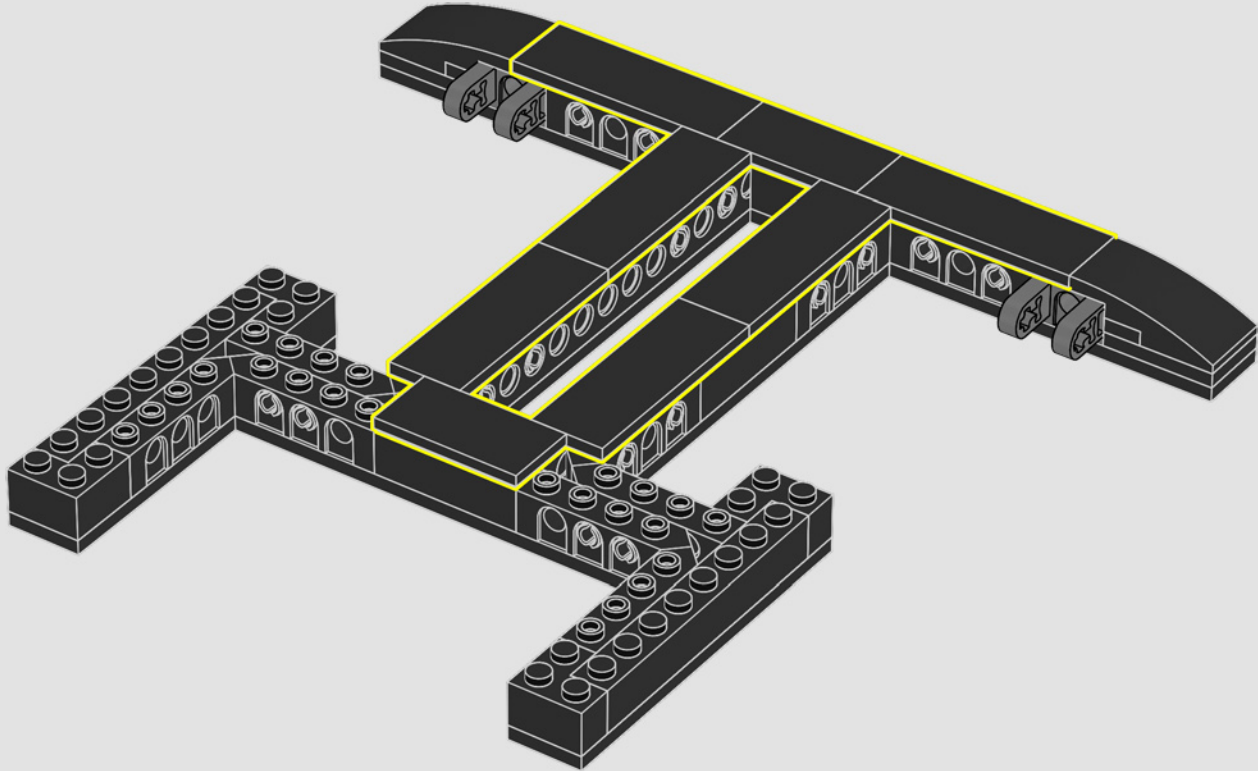

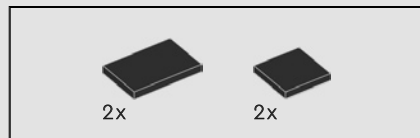

110

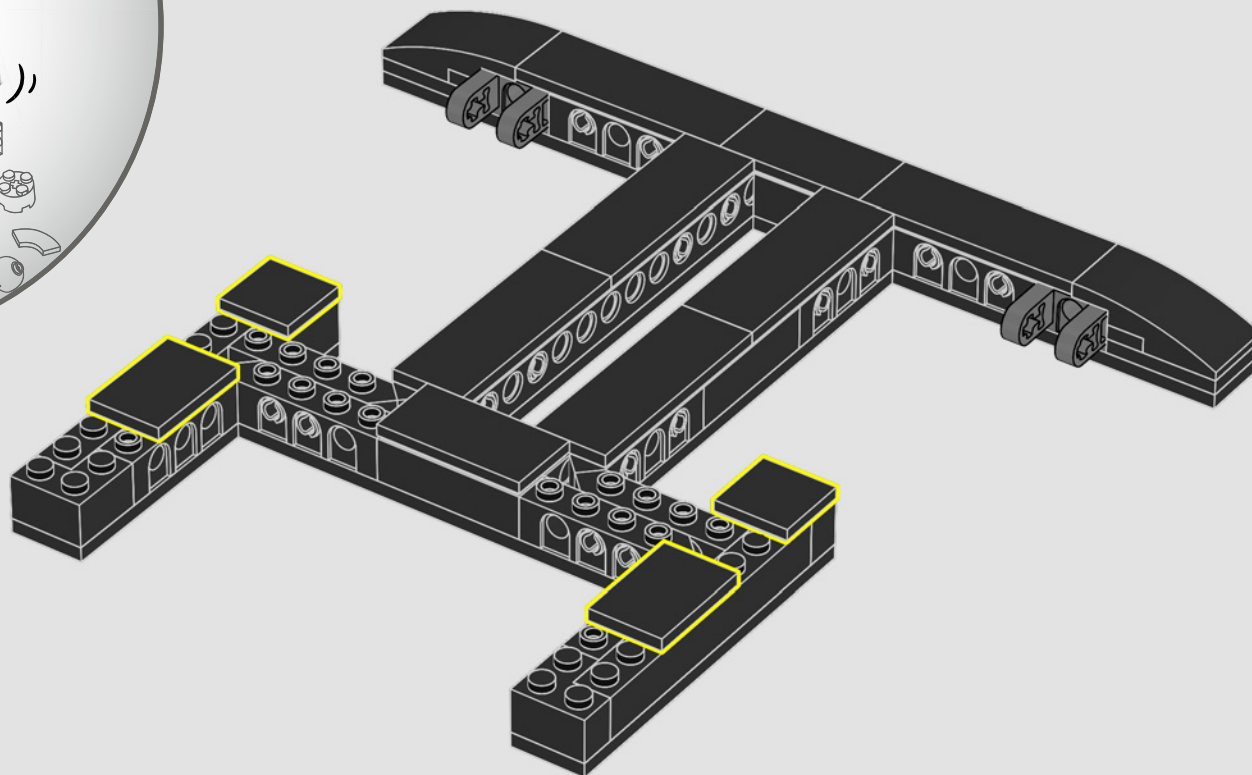



10x

111

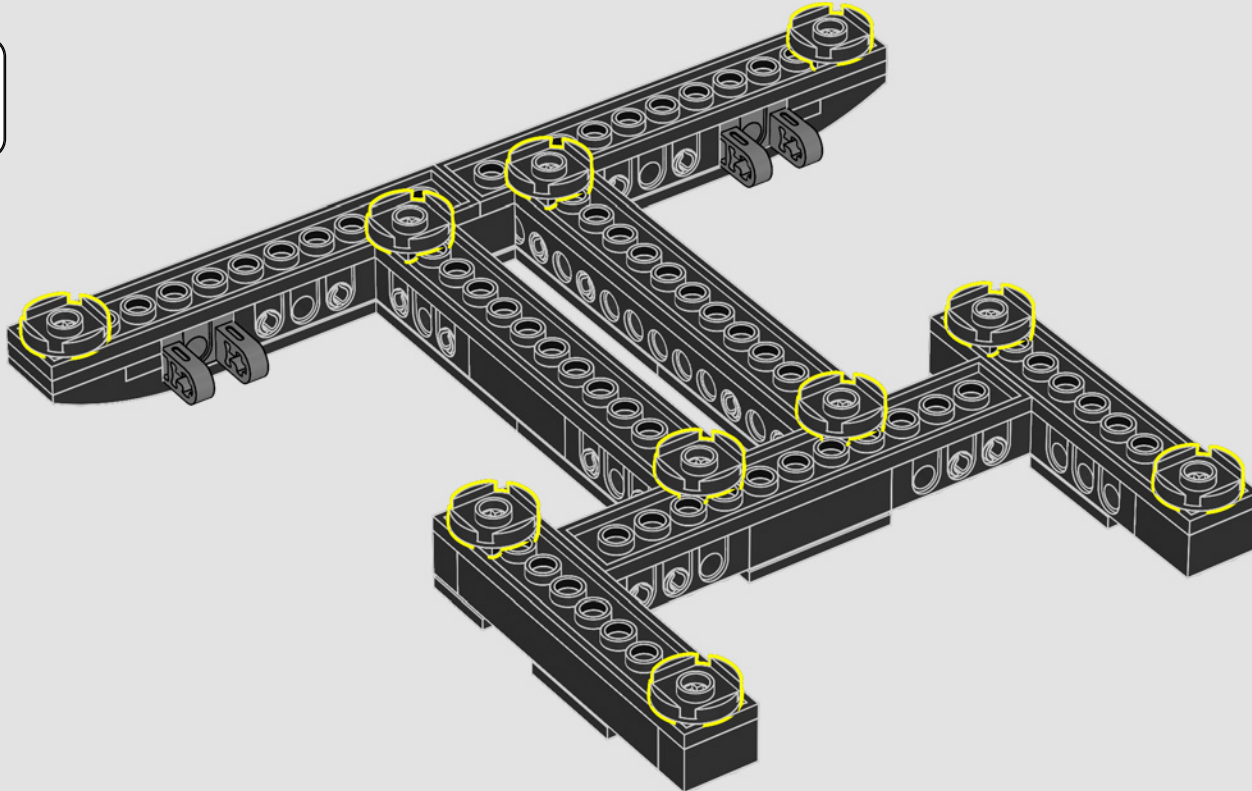

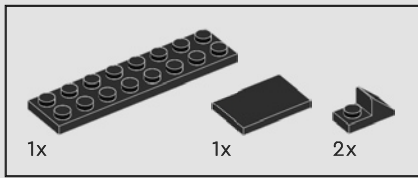

112

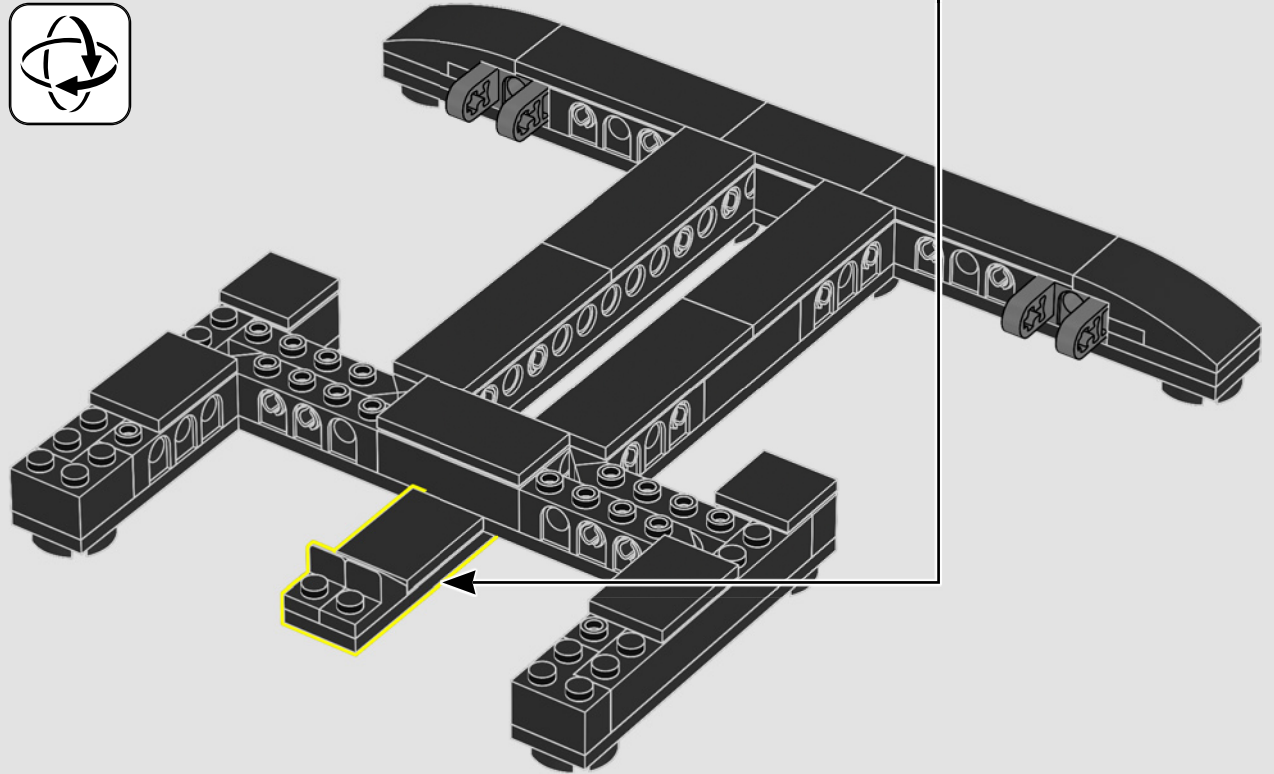
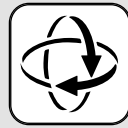
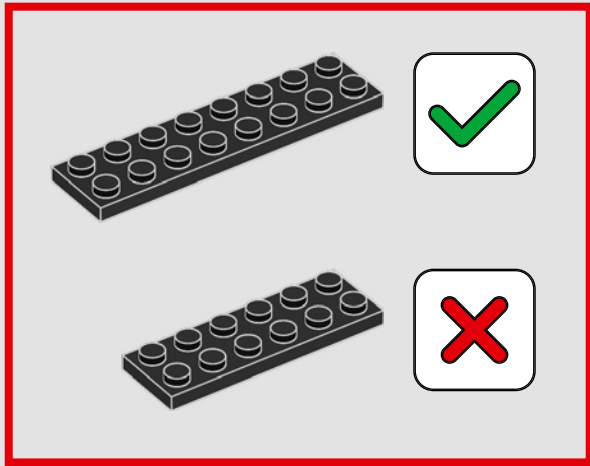
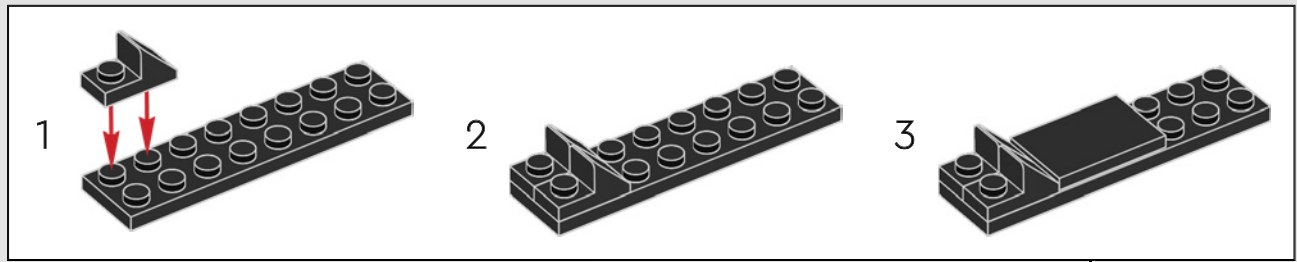

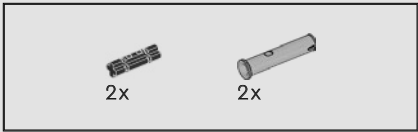

113

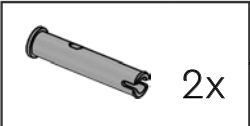
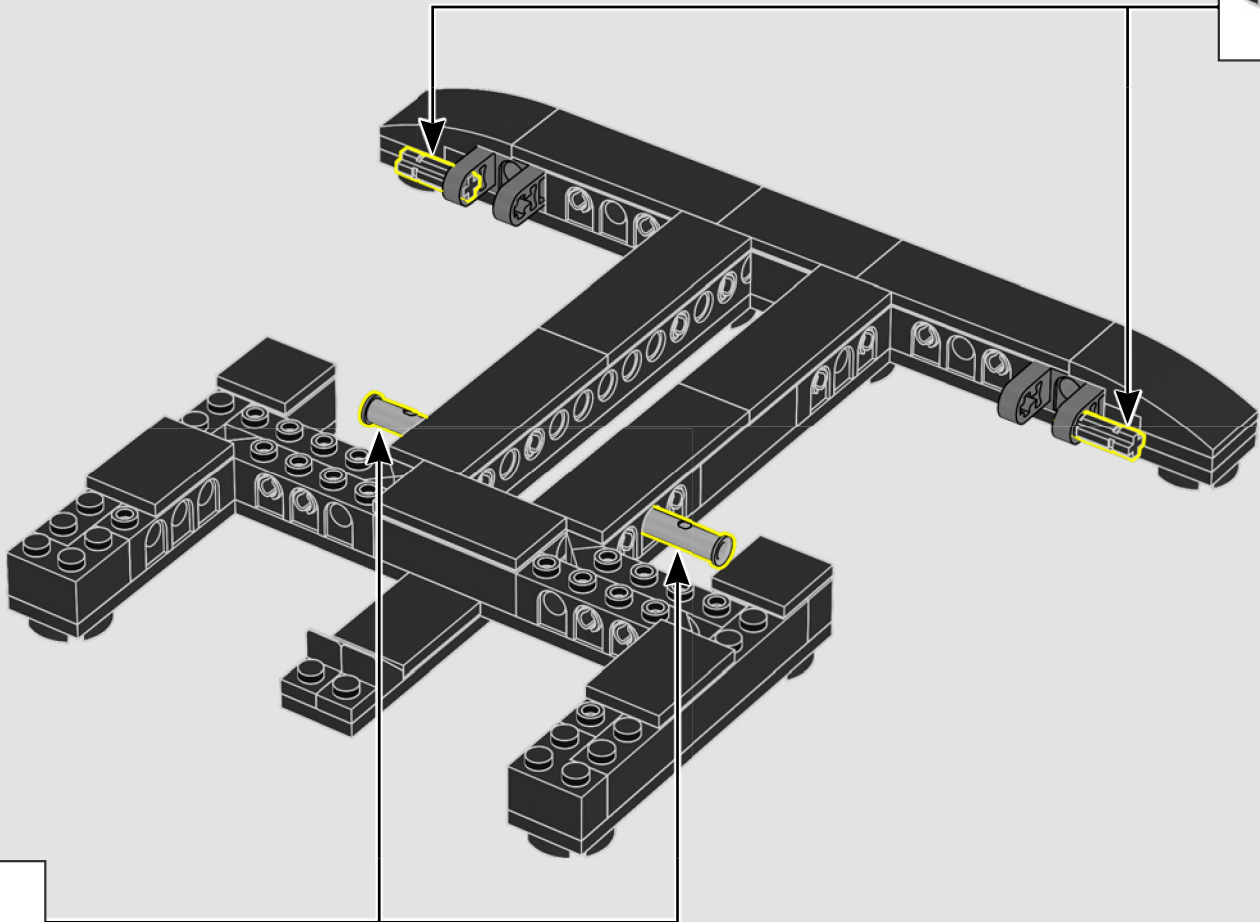

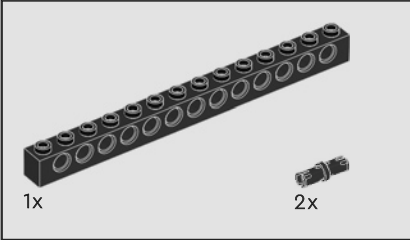
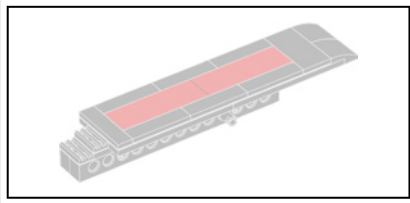

114

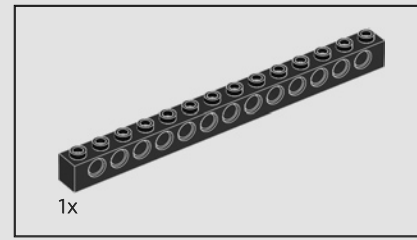
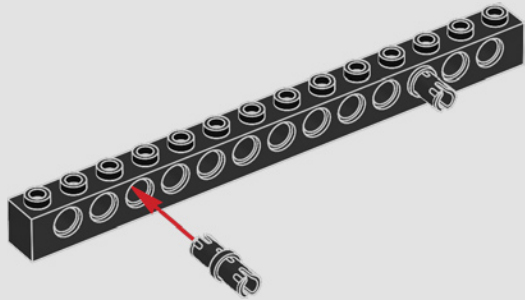

115

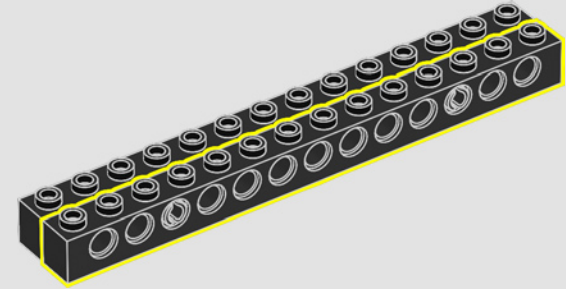

116

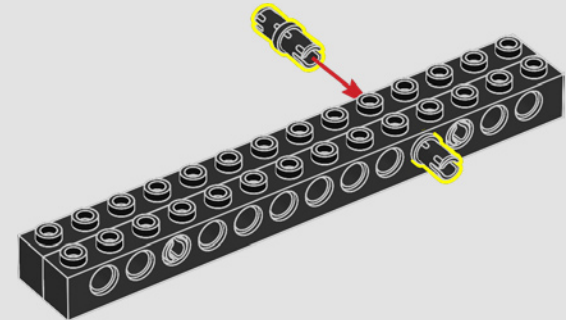



1x

117

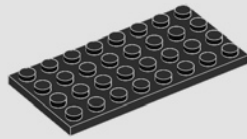
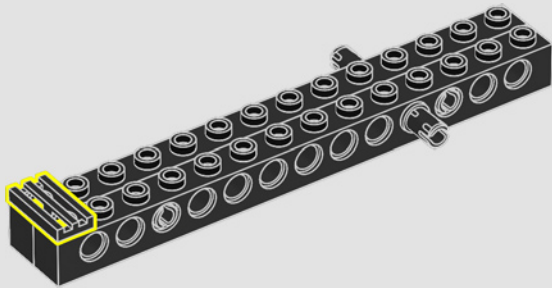

2x

119

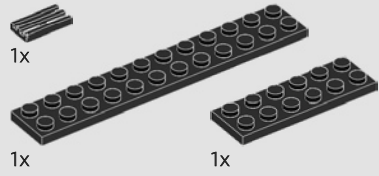
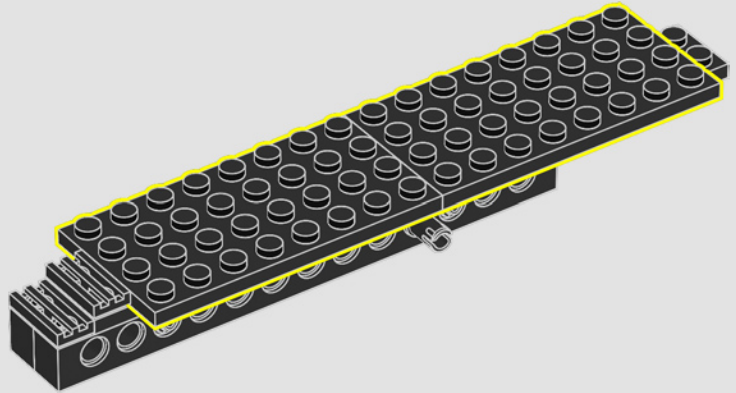

118

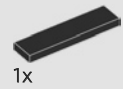
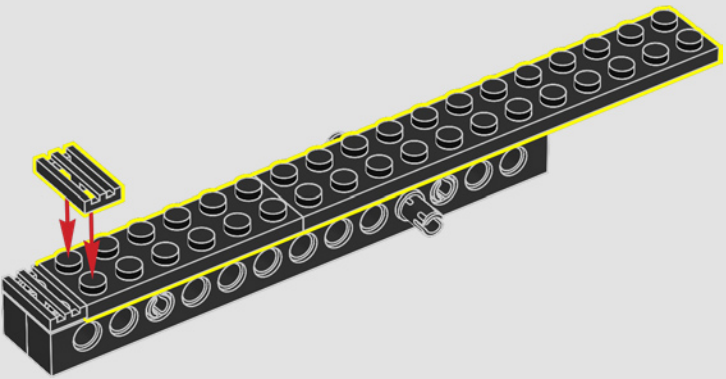

1x

120

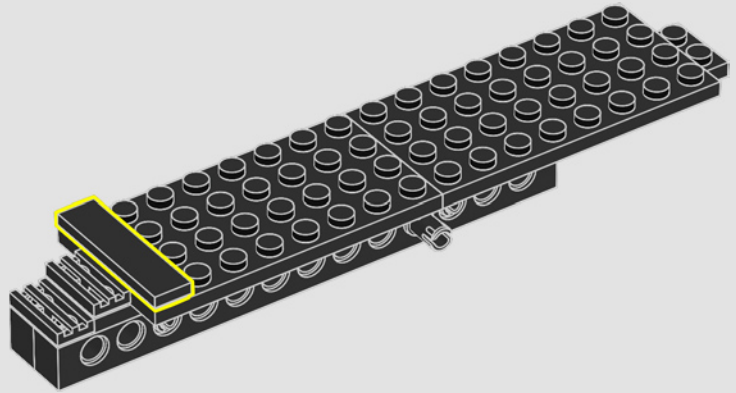

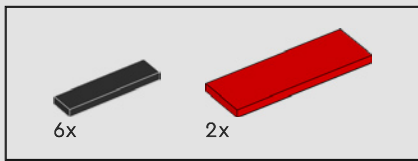

121

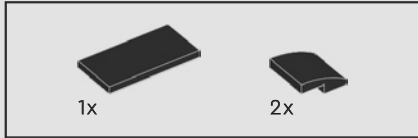
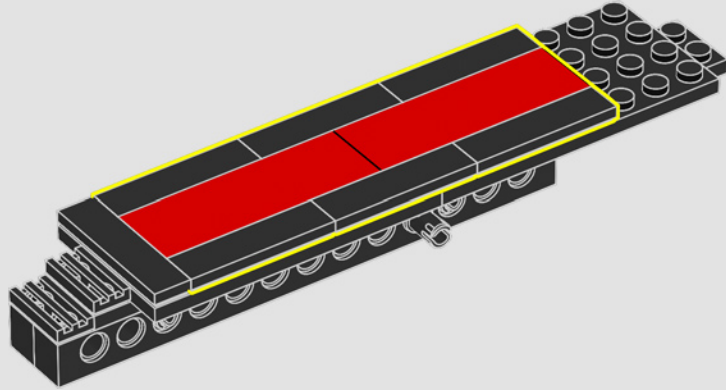

122

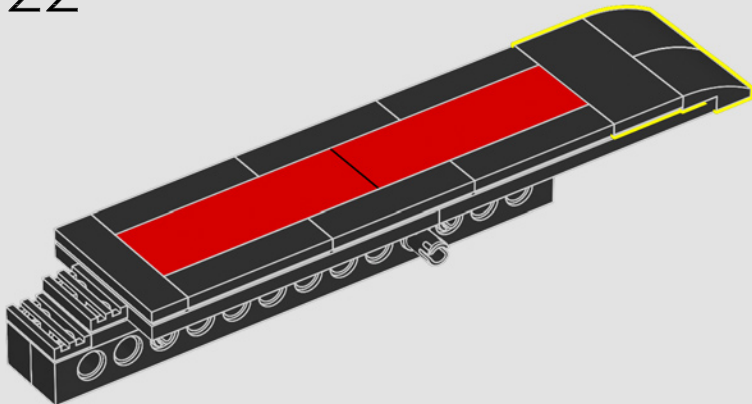

123

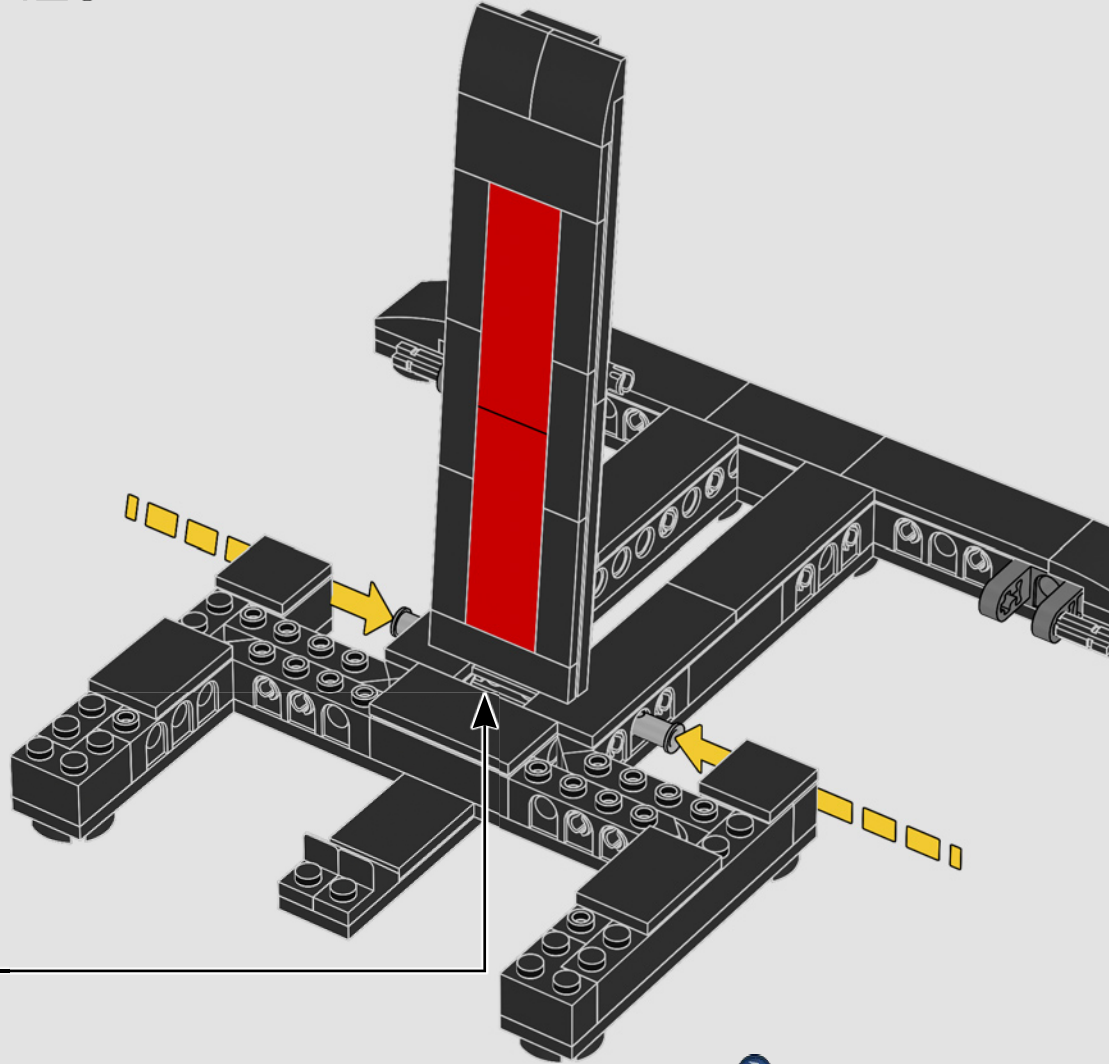

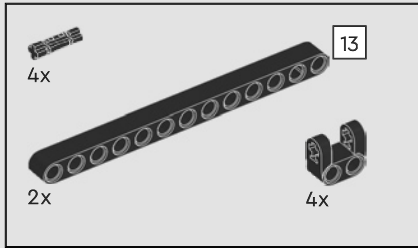
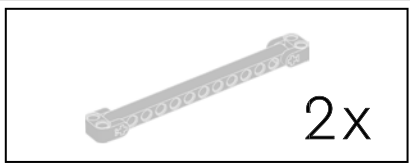

124

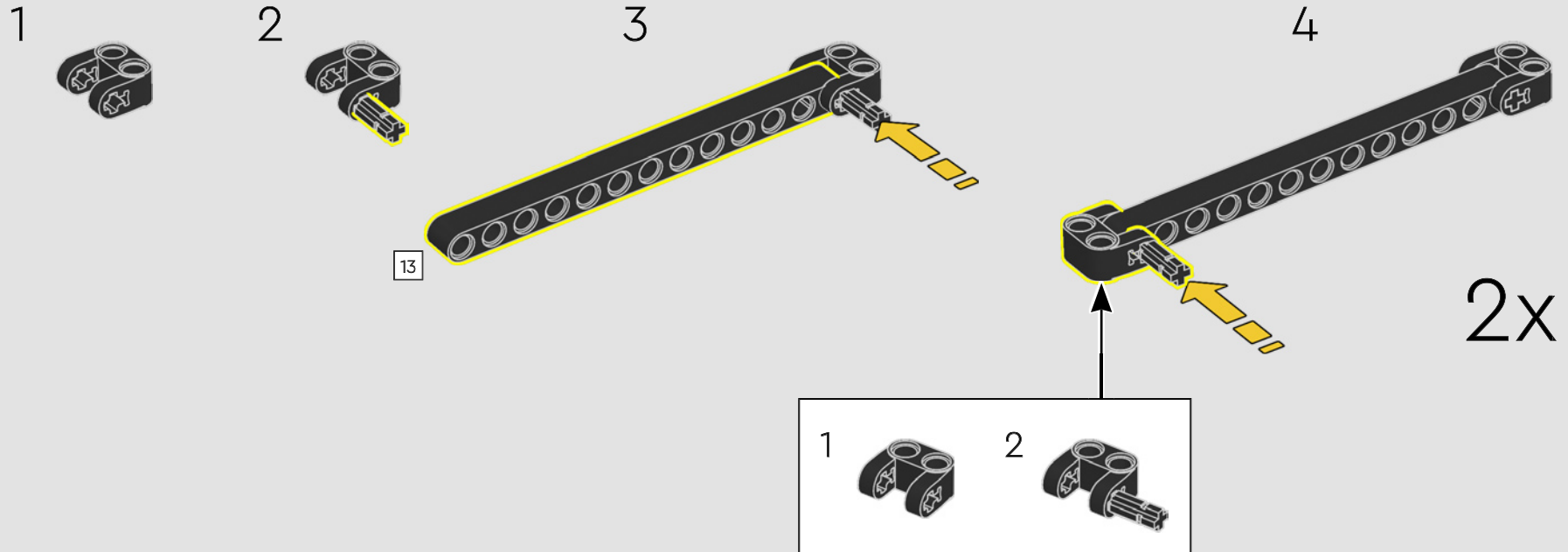

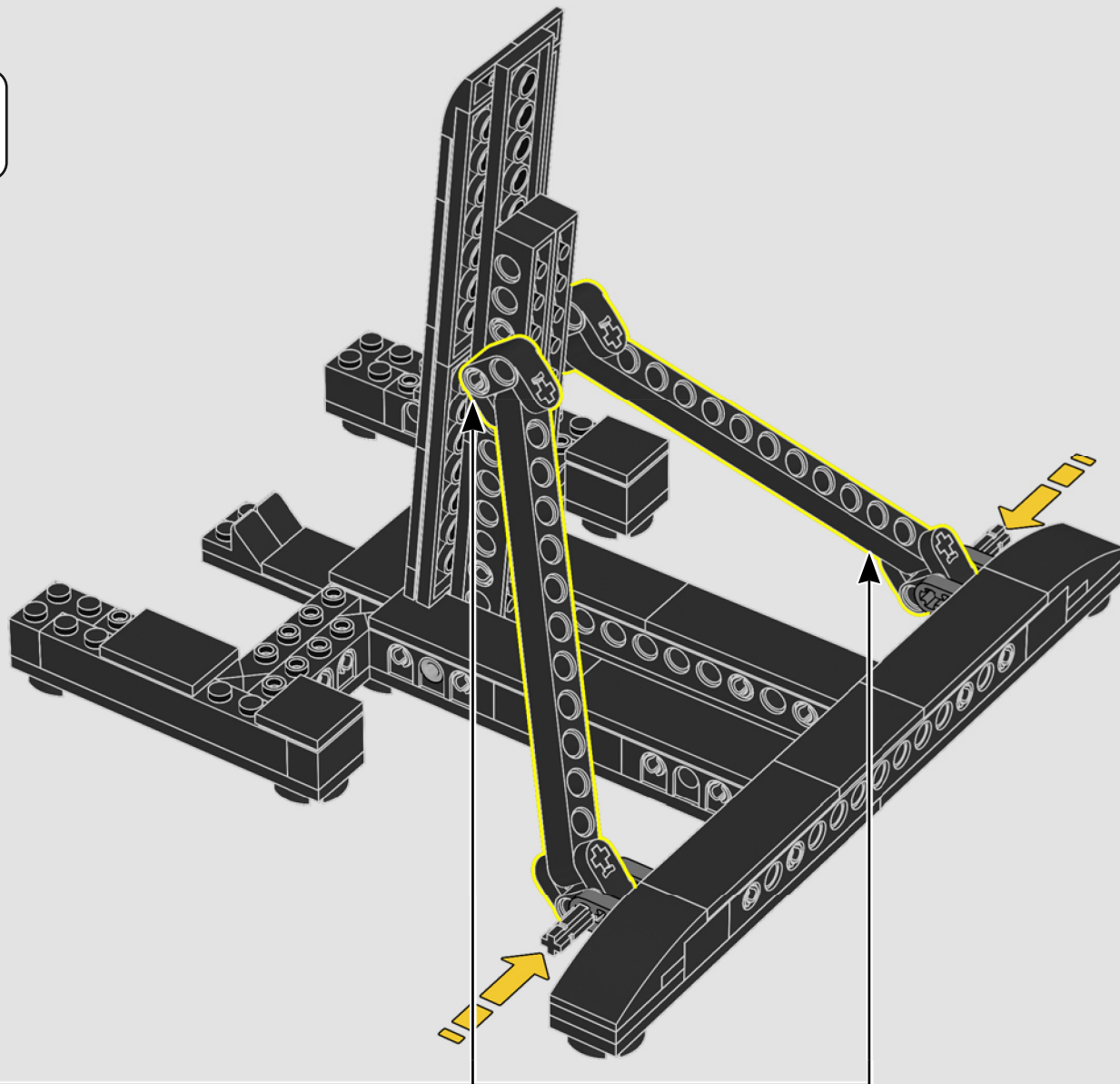

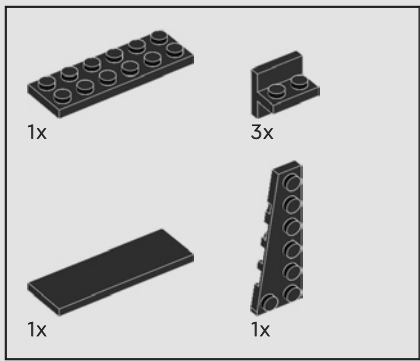

125

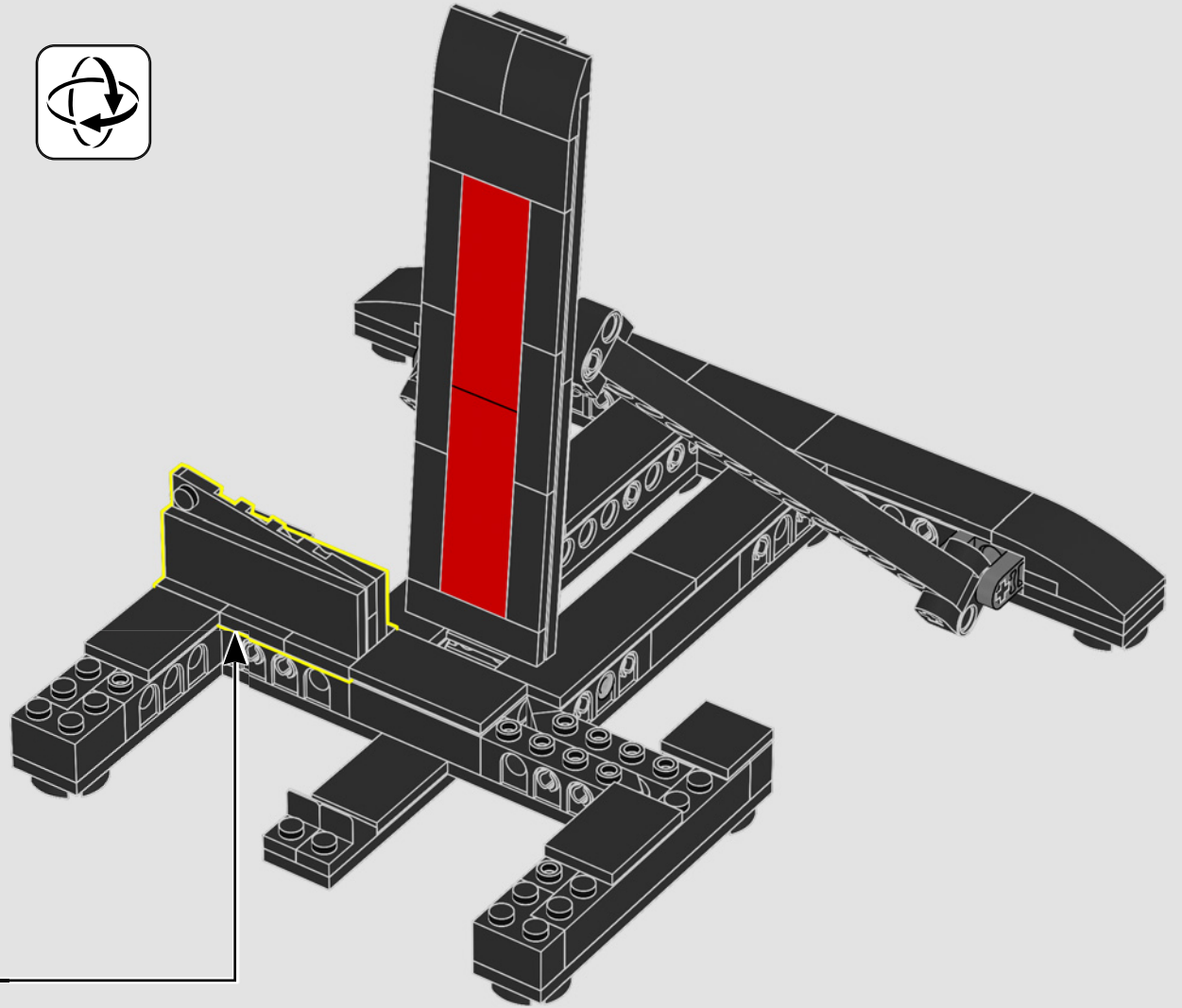
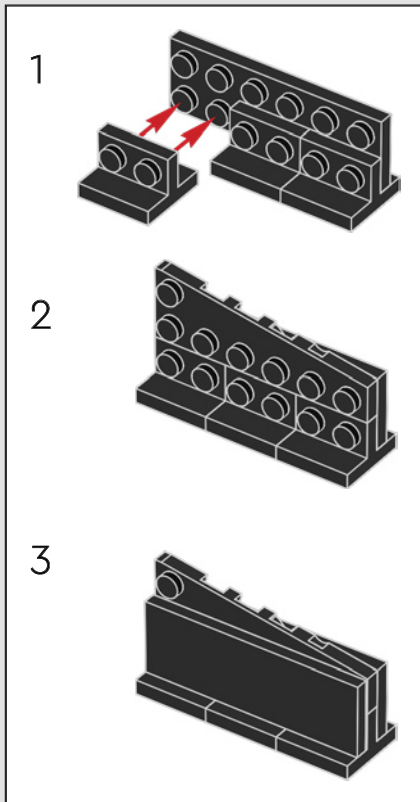

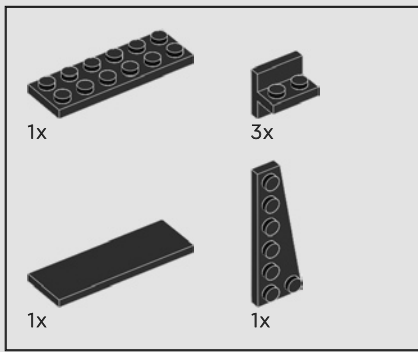

126

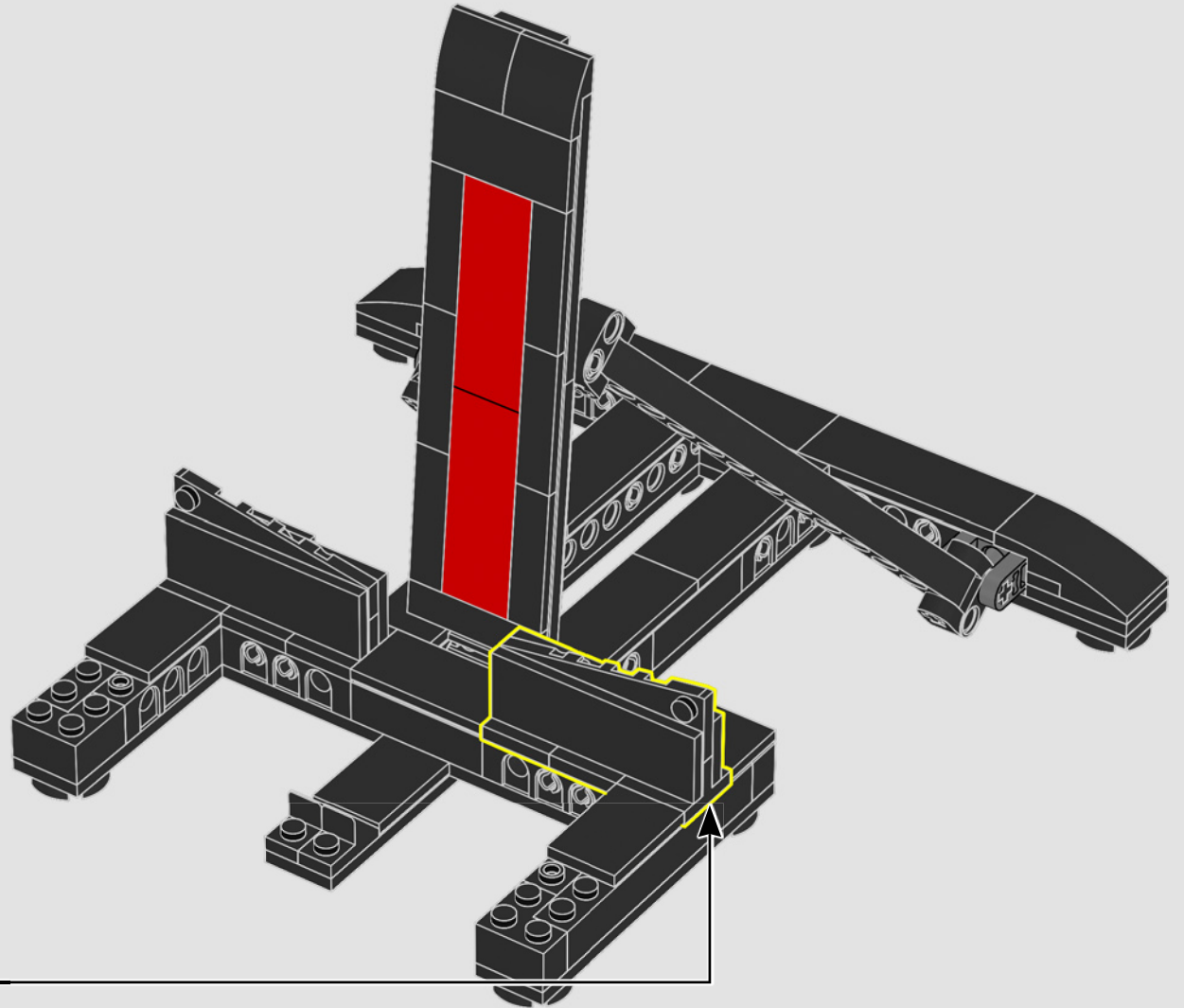
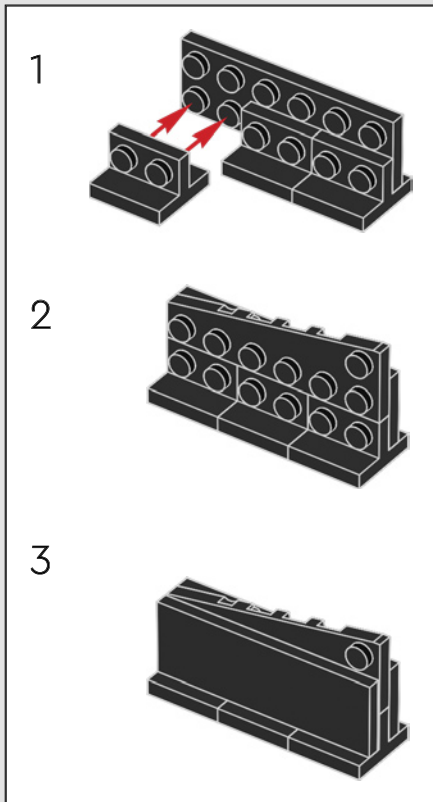

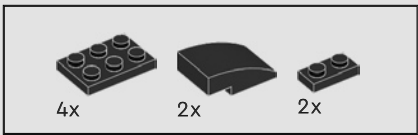

127

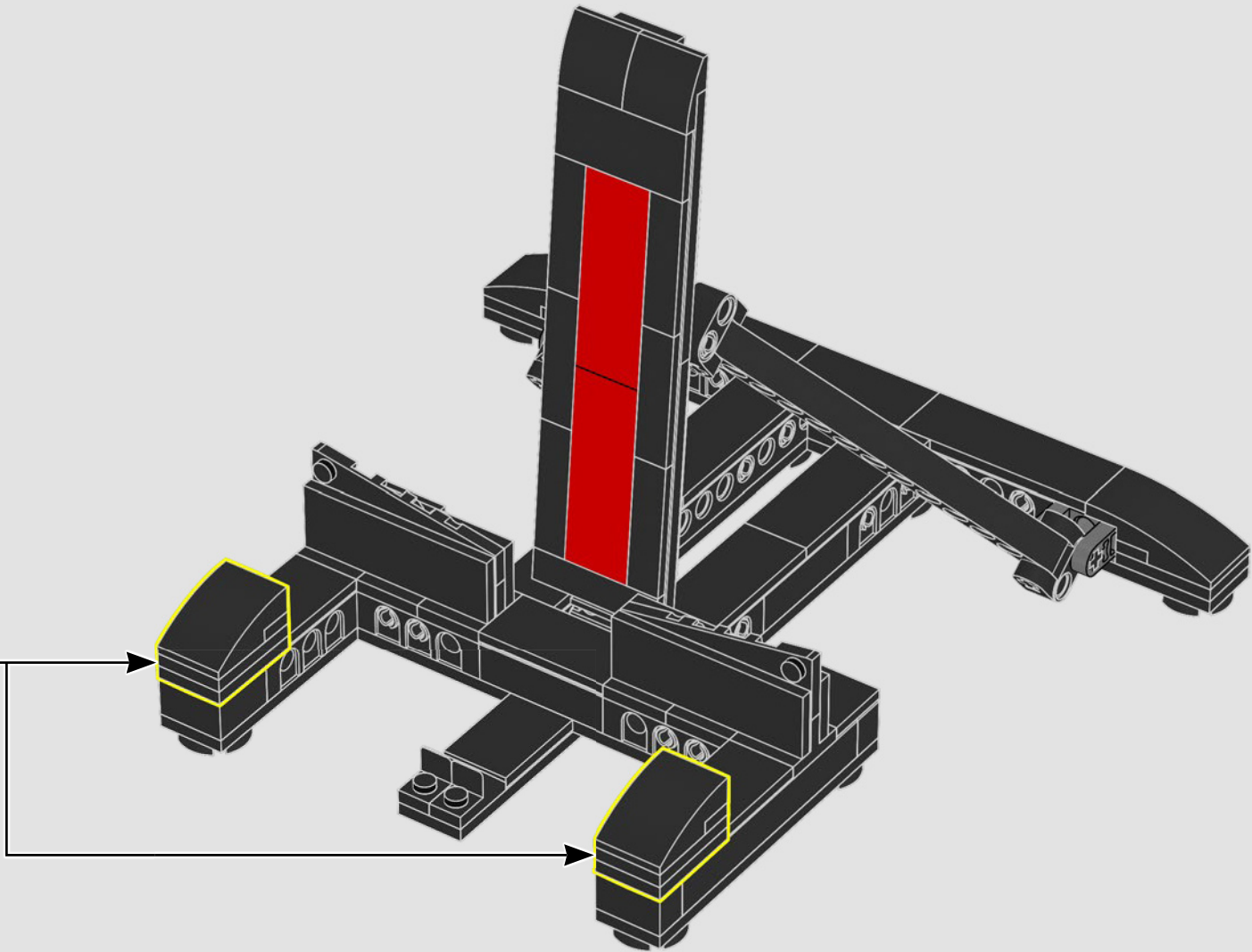
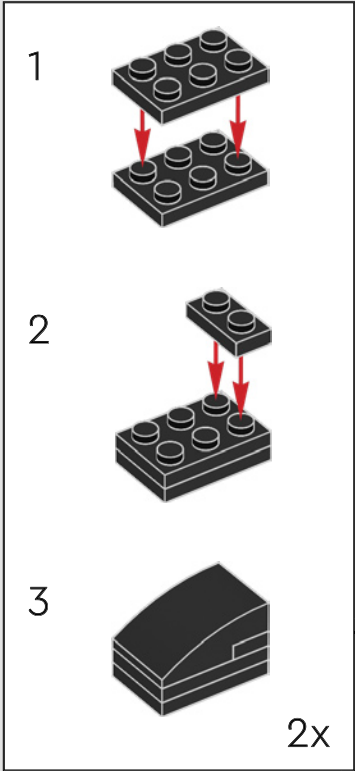

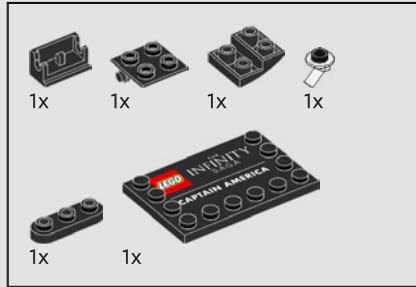

128

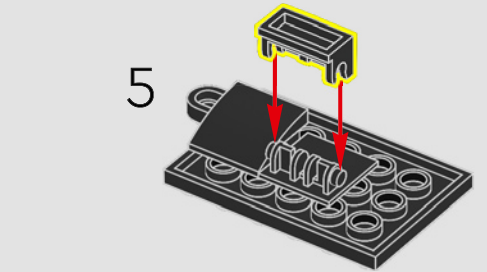
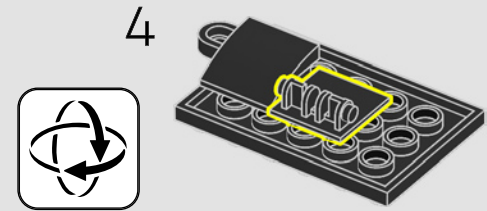
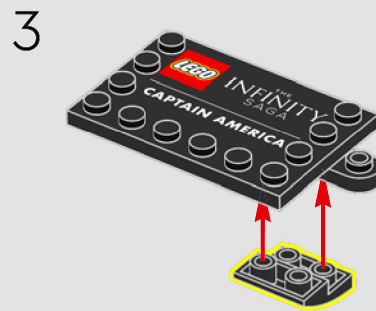
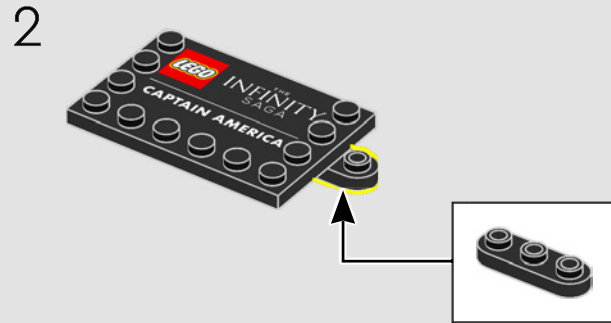

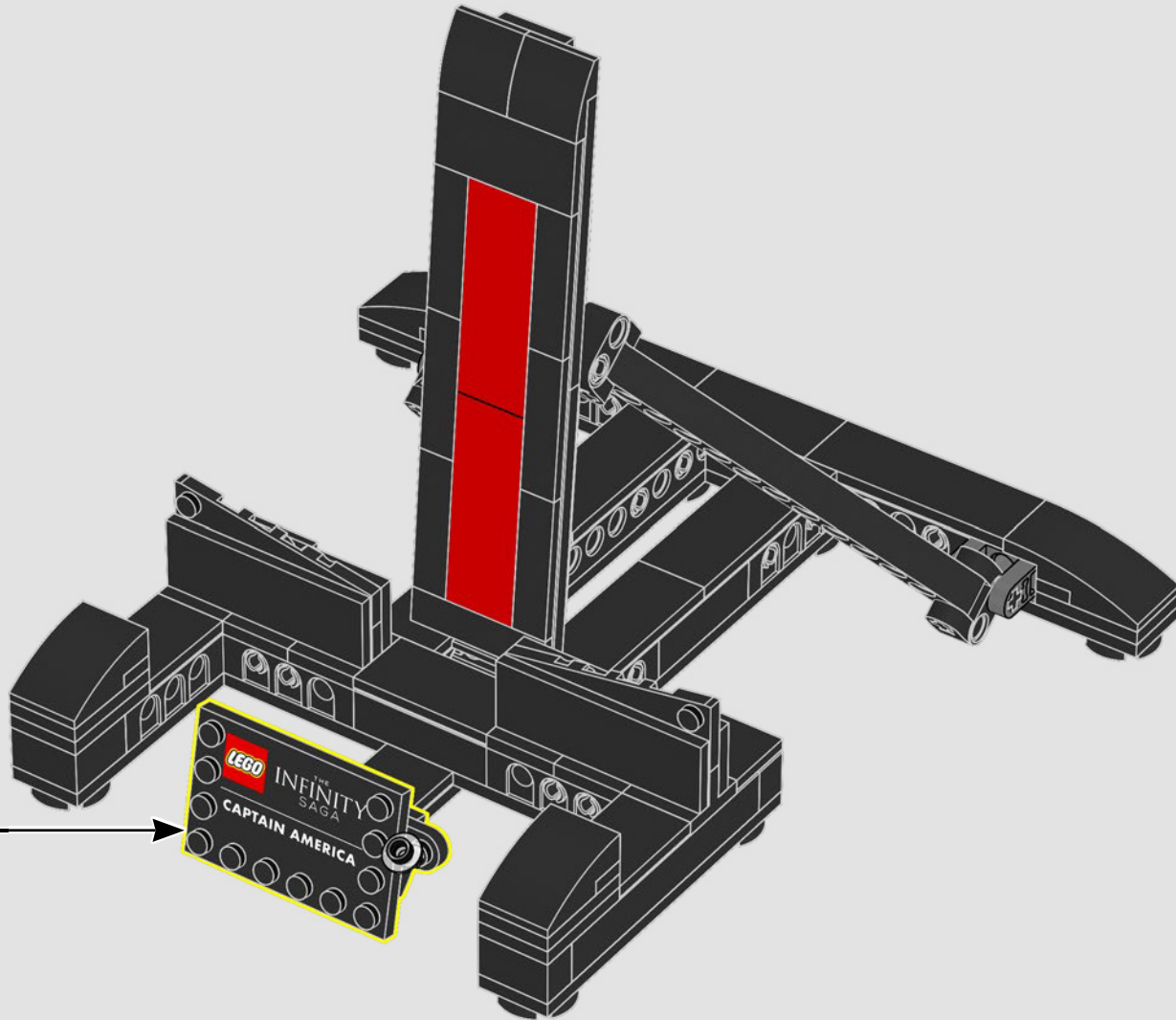

129

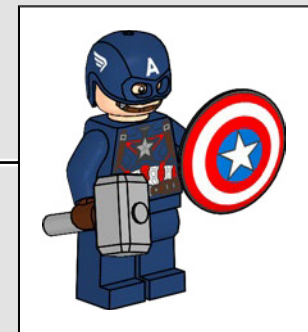
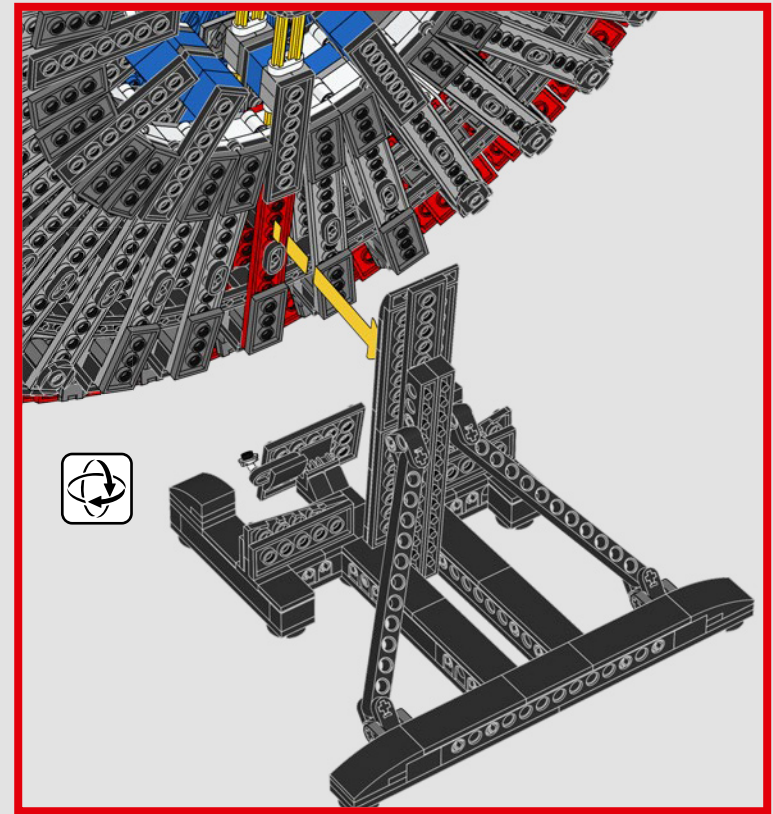
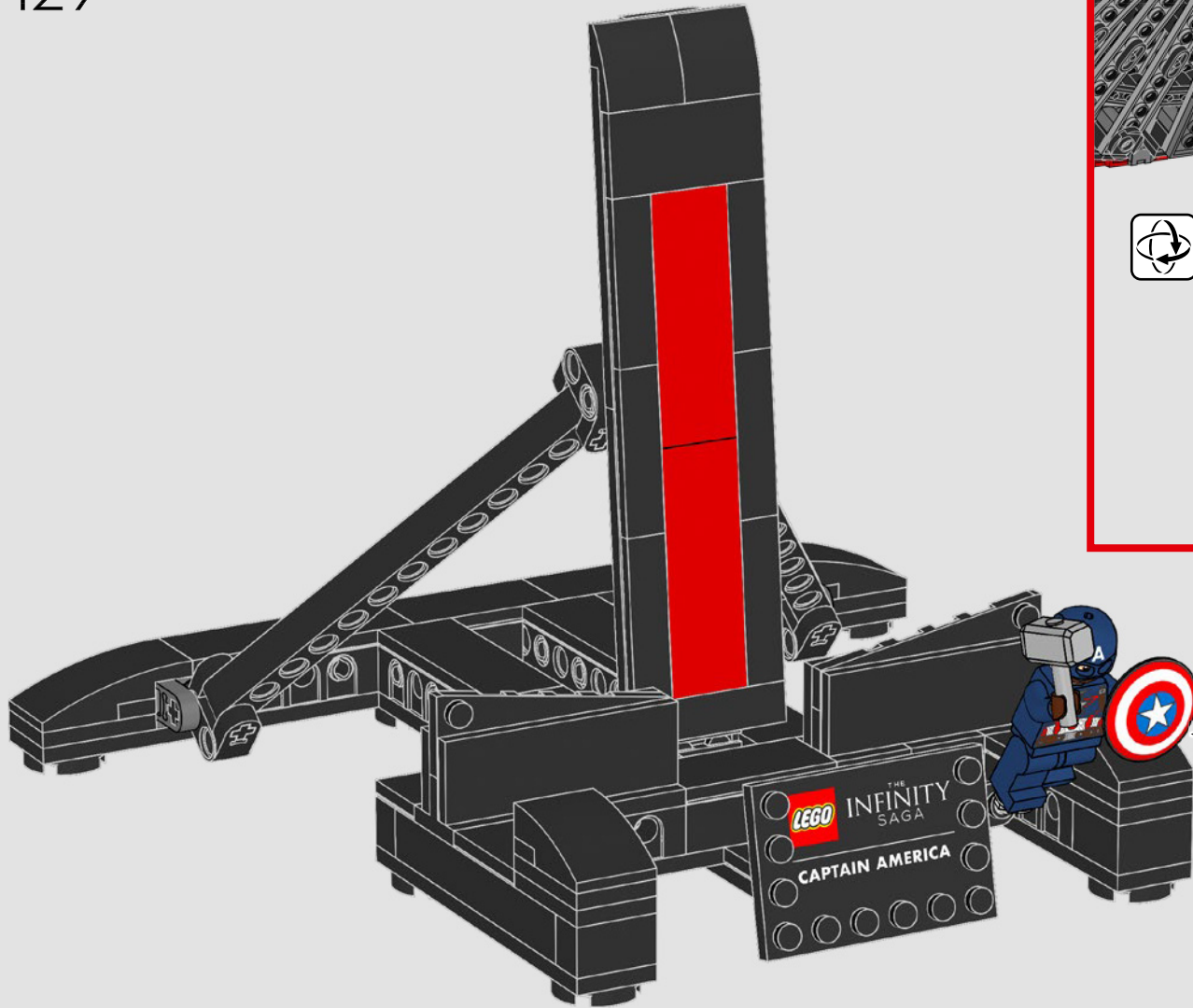

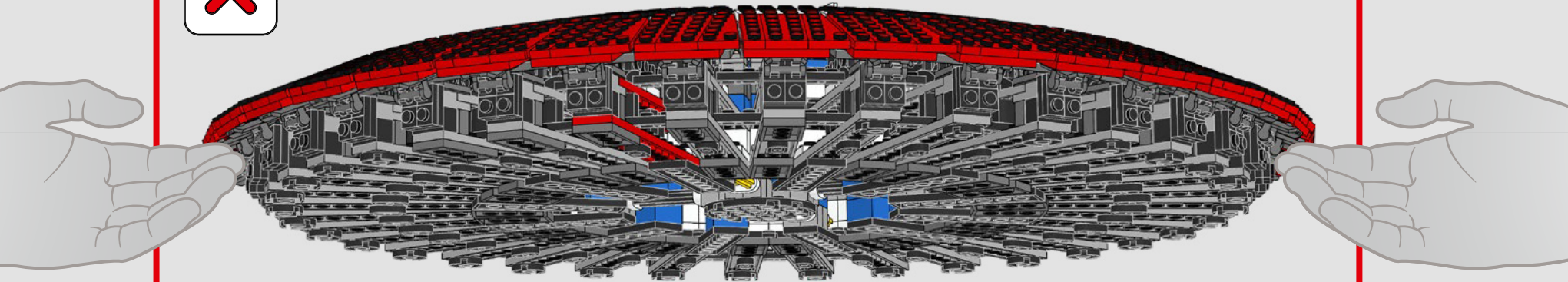
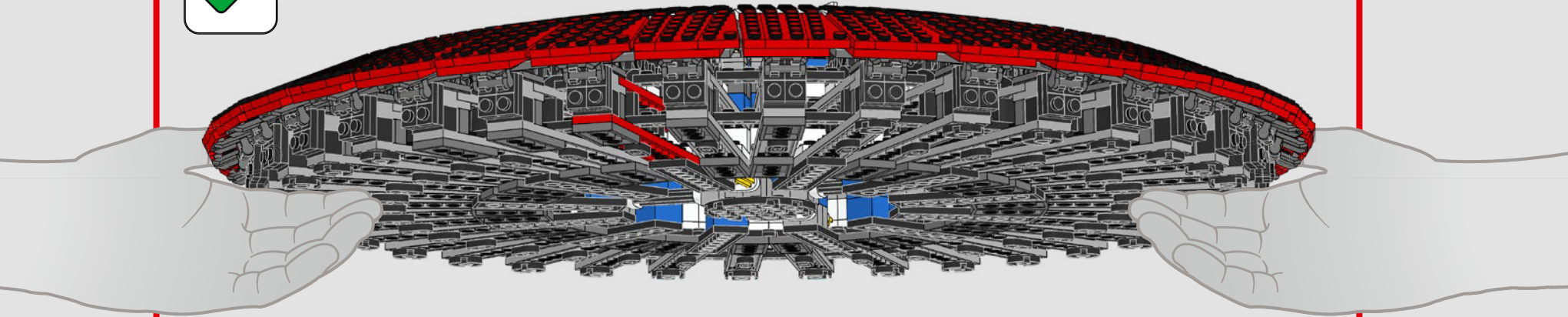

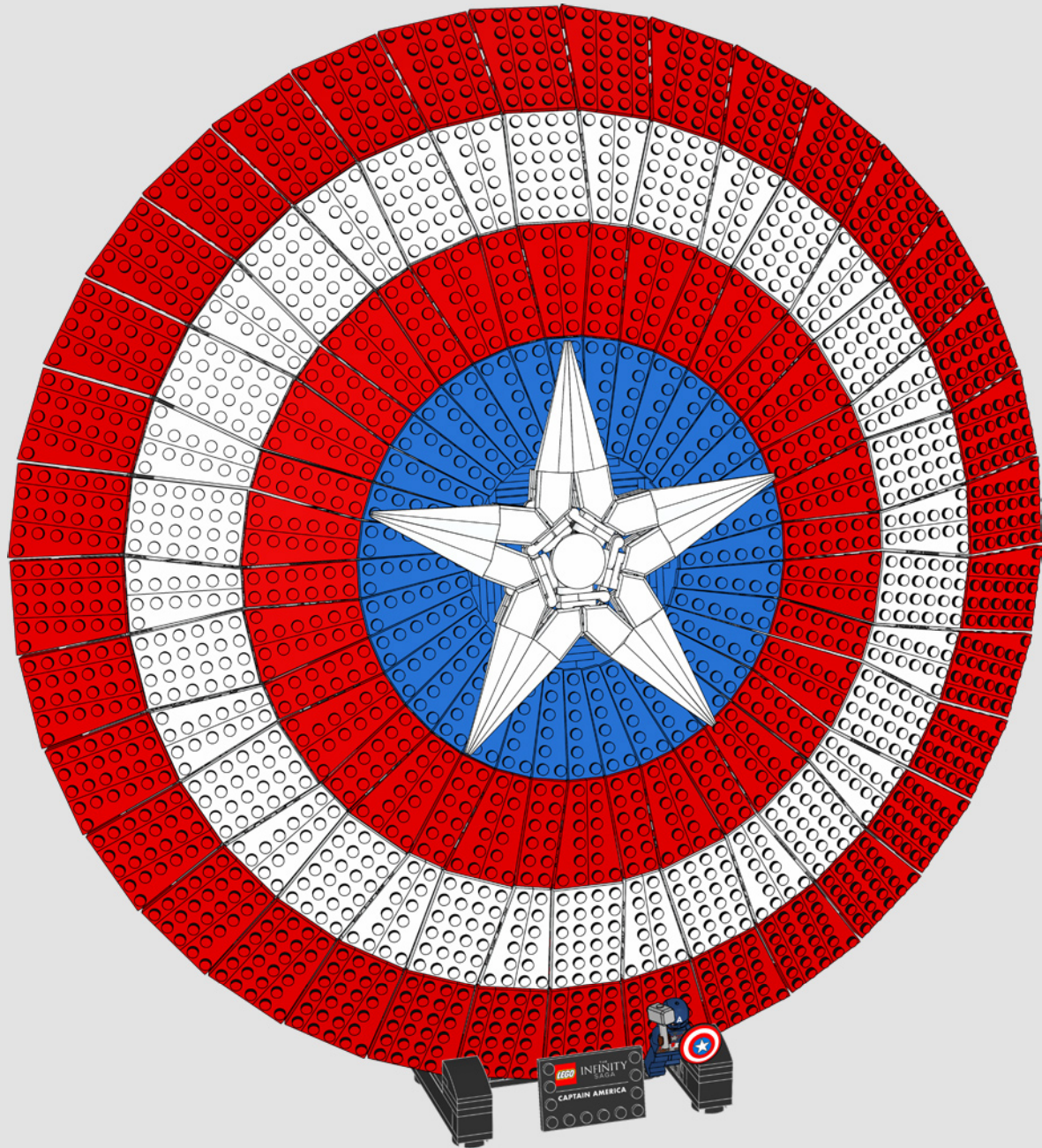

- 1x 6059185
- 1x 6058177
- 46x 302201
- 72x 302101
- 36x 371001
- 18x 303201
- 5x 6347293
- 5x 6174937
- 72x 6347287
- 36x 6361170
- 92x 614101
- 6x 6210272
- 12x 6132203
- 18x 6392747
- 18x 6392746
- 1x 6300017
- 32x 6371416
- 5x 6146215
- 10x 6245249
- 36x 6327411
- 36x 383101
- 10x 6416527
- 72x 4113917
- 1x 4114309
- 2x 4651524
- 36x 302021
- 36x 366621
- 2x 6335578
- 54x 379521
- 2x 6308885
- 10x 6231513
- 2x 243123
- 10x 371023
- 6x 366623
- 6x 6210272
- 12x 6132203
- 18x 6392747
- 18x 6392746
- 1x 6300017
- 32x 6371416
- 5x 6146215
- 10x 6245249
- 36x 6327411
- 36x 383101
- 10x 6416527
- 72x 4113917
- 1x 4114309
- 2x 4651524
- 36x 302021
- 36x 366621
- 2x 6335578
- 54x 379521
- 2x 6308885
- 10x 6231513
- 2x 243123
- 10x 371023
- 6x 366623
- 4x 346023
- 4x 6455374
- 4x 6133720
- 72x 6440000
- 1x 302224
- 8x 6130012
- 72x 4644456
- 4x 300426
- 4x 235726
- 3x 301026
- 2x 300826
- 36x 6138173
- 6x 6170702
- 4x 346023
- 4x 6455374
- 4x 6133720
- 72x 6440000
- 1x 302224
- 8x 6130012
- 72x 4644456
- 4x 300426
- 4x 235726
- 3x 301026
- 2x 300826
- 36x 6138173
- 6x 6170702
- 5x 4107558
- 8x 4504382
- 2x 6069000
- 38x 6053077
- 1x 6211476
- 2x 6147790
- 2x 4647286
- 2x 4522933
- 252x 6092585
- 4x 306926
- 6x 302126
- 7x 243126
- 36x 371026
- 3x 4560182
- 2x 241226
- 4x 302326
- 72x 242026
- 36x 302226
- 2x 306826
- 3x 6162892
- 3x 379526
- 8x 6318582
- 1x 6448813
- 25x 303426
- 2x 303526
- 2x 383226
- 2x 244526
- 4x 6335317
- 72x 6347310
- 2x 6020193
- 6x 6250020
- 36x 4515368
- 36x 6210270
- 1x 6344427
- 1x 6344428
- 3x 6187587
- 8x 373726
- 1x 4124096
- 36x 6416444
- 1x 6285587
- 1x 6240515
- 1x 4162916
- 1x 6357647
- 1x 6315642
- 4x 4211349
- 64x 6336539
- 5x 6102357
- 27x 4211398
- 12x 4211413
- 216x 6211969
- 2x 4211445
- 70x 4662161
- 1x 6132886
- 36x 6469440
- 36x 4211525
- 1x 6004729
- 2x 6338962
- 36x 4211095
- 25x 4211088
- 2x 6324639
- 122x 4211094
- 36x 4211055
- 101x 4211065
- 101x 4211065
- 36x 6250018
- 72x 6146321
- 6x 6221607
- 12x 4527082
- 1x 6261471
- 36x 6258991
- 36x 6258991
- 10x 6438921
- 1x 6288611
- 1x 6145528

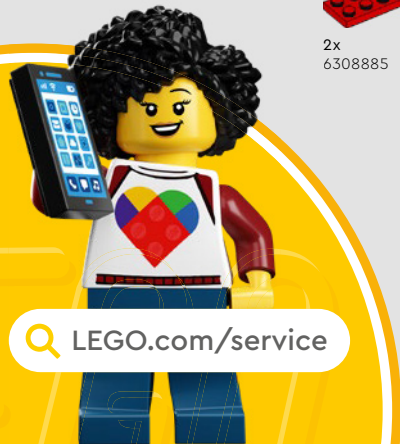

 [LEGO.com/service](https://www.LEGO.com/service)

11

13

10



YOU COULD WIN



YOU COULD WIN

Your feedback will help shape the future development of this product series.

Visit:

DU KÖNNTEST GEWINNEN

Dein Feedback trägt zur Weiterentwicklung dieser Produktreihe bei.

Geh auf:

VOUS POURRIEZ GAGNER

Vos commentaires nous aideront à concevoir les futurs produits de cette gamme.

Visitez :

POTRESTI VINCERE TU

La tua opinione ci aiuterà a migliorare la creazione futura di questa linea di prodotti.

Visita:

PUEDES GANAR

Tu opinión contribuirá al futuro de esta serie de productos.

Visita:

轻松获奖

您的反馈将有助于我们在今后改进本产品系列。

请访问:

LEGO.com/productfeedback

You also have the chance to win a LEGO® set.

Terms and conditions apply.*

Außerdem hast du die Chance, ein LEGO® Set zu gewinnen.

Es gelten die Teilnahmebedingungen.*

Vous pourriez également gagner un ensemble LEGO®.

Des conditions s'appliquent.*

Hai anche la possibilità di vincere un set LEGO®.

Termini e condizioni sono applicabili.*

También tienes la oportunidad de ganar un set LEGO®.

Aplican términos y condiciones.*

您还有机会赢取乐高®套装。

条款和条件适用。*

*LEGO.com/productfeedback-terms

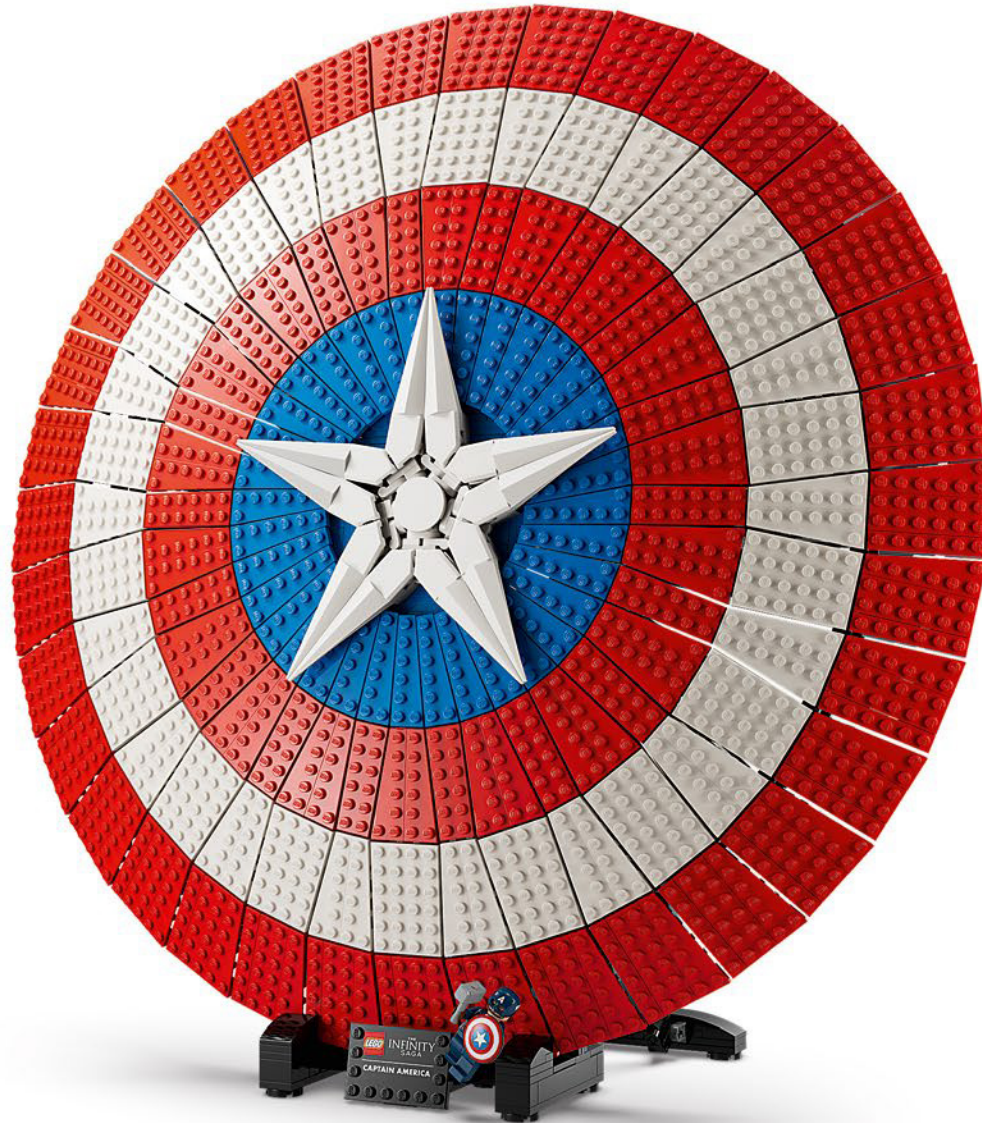

LEGO and the LEGO logo are trademarks of the LEGO Group. ©2023 The LEGO Group.
© 2023 MARVEL