

4030

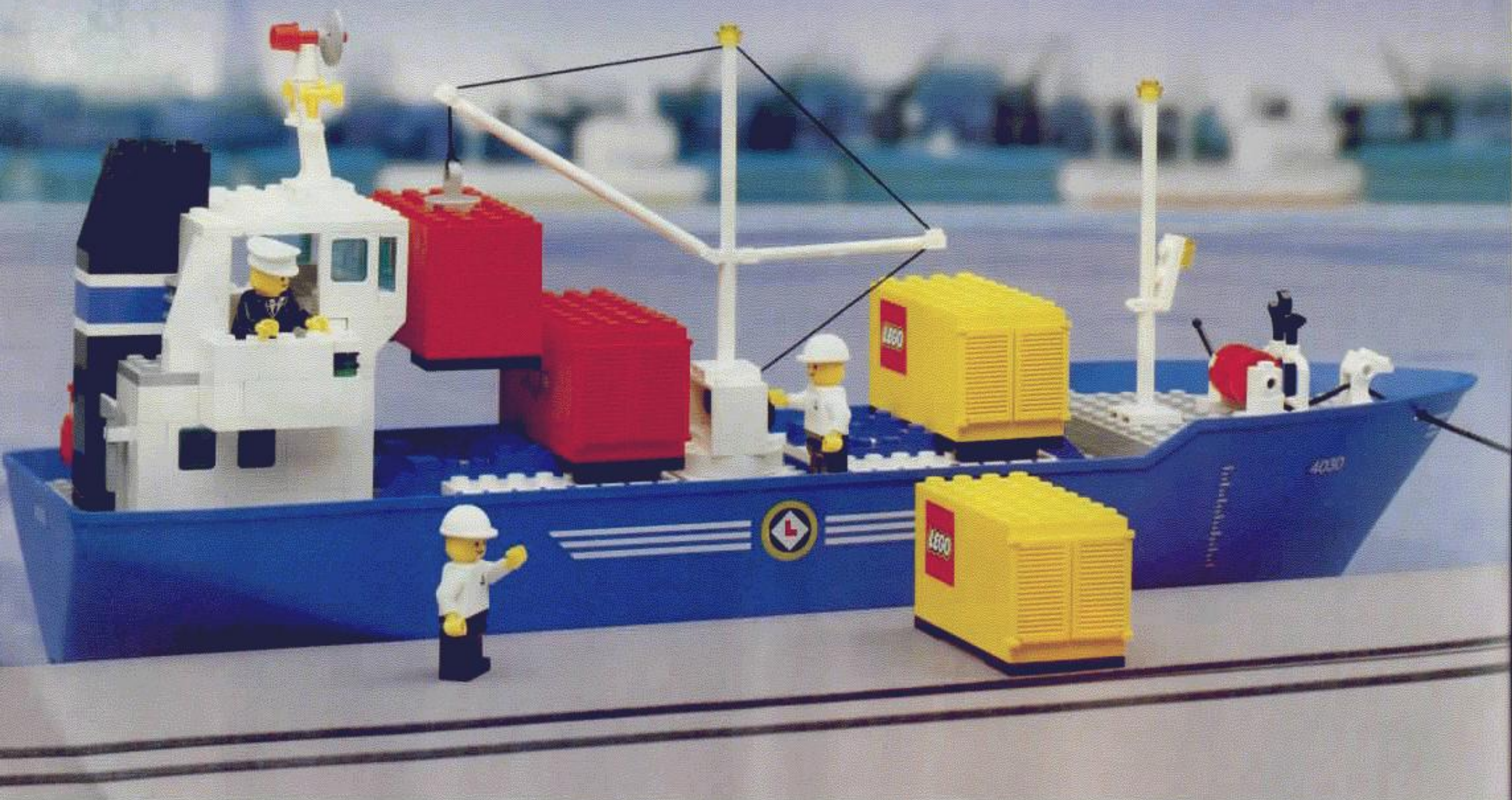

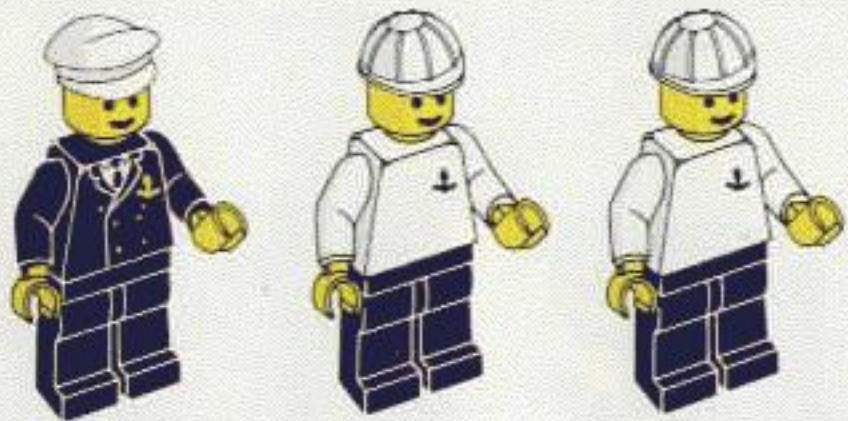

1

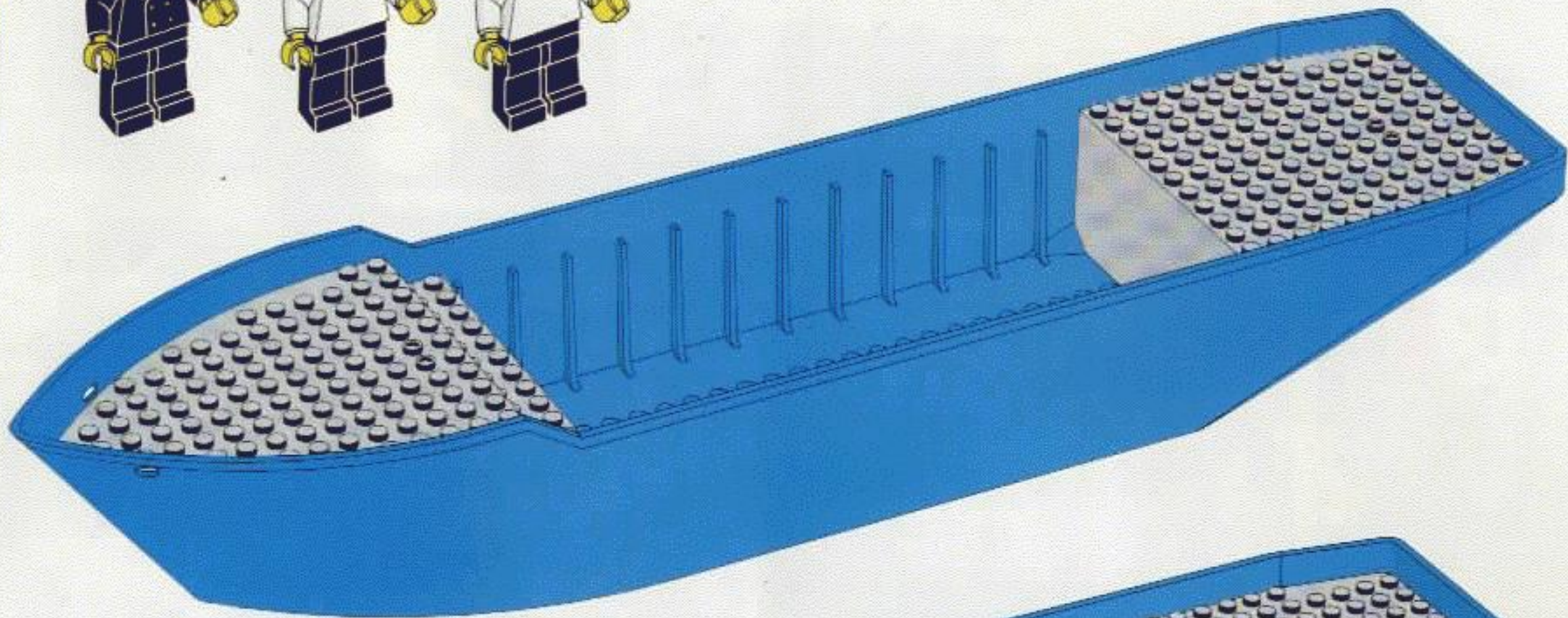

2

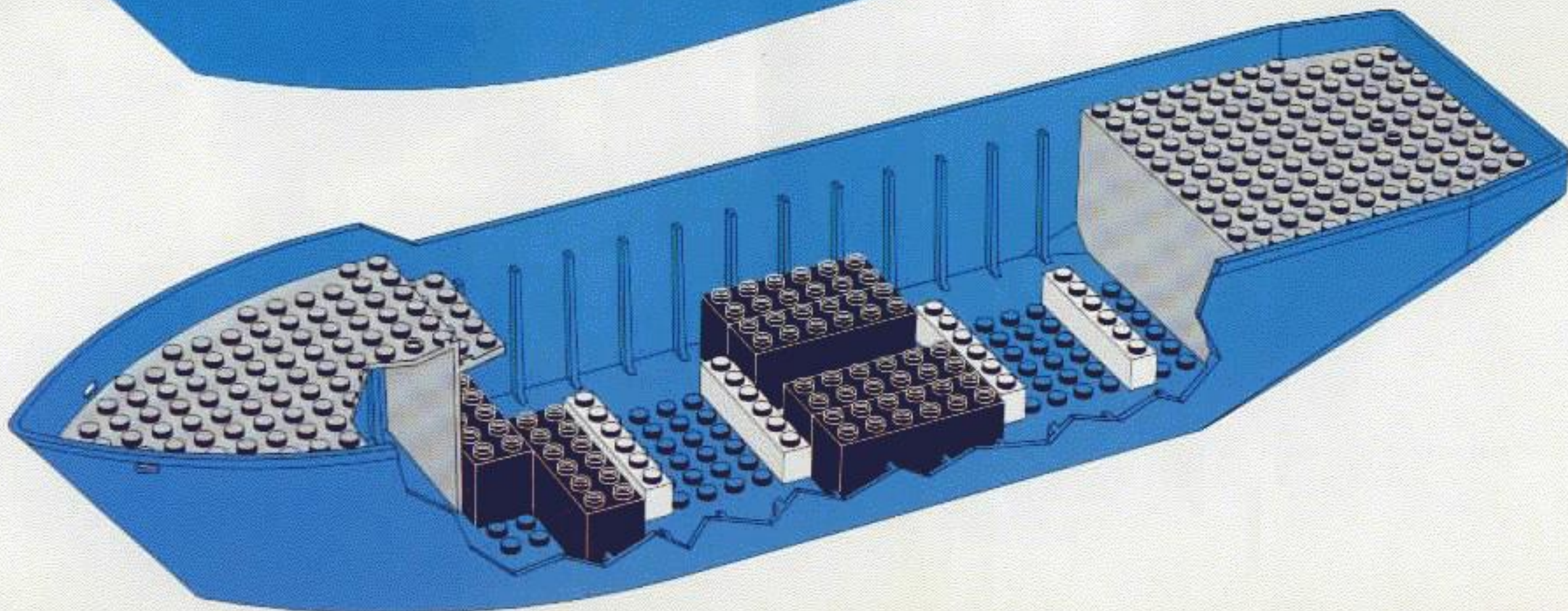

4030

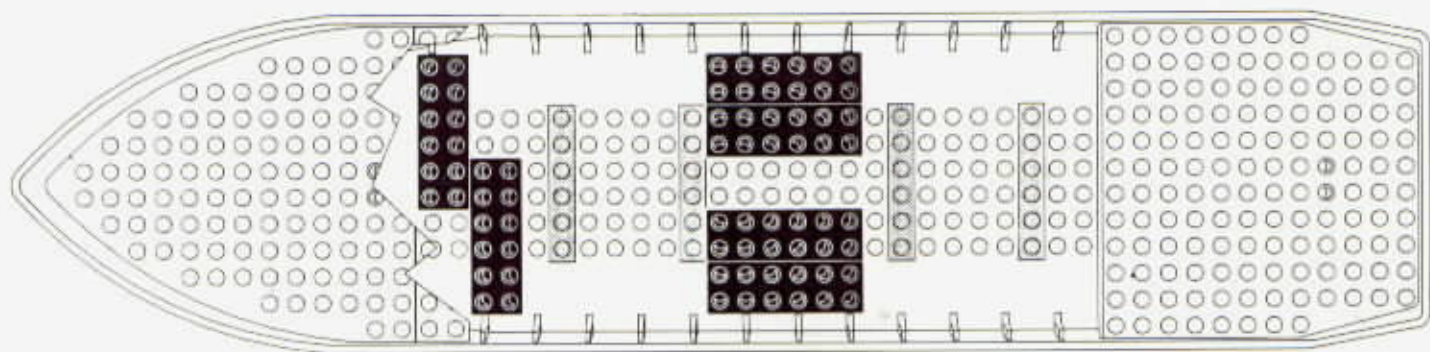

3

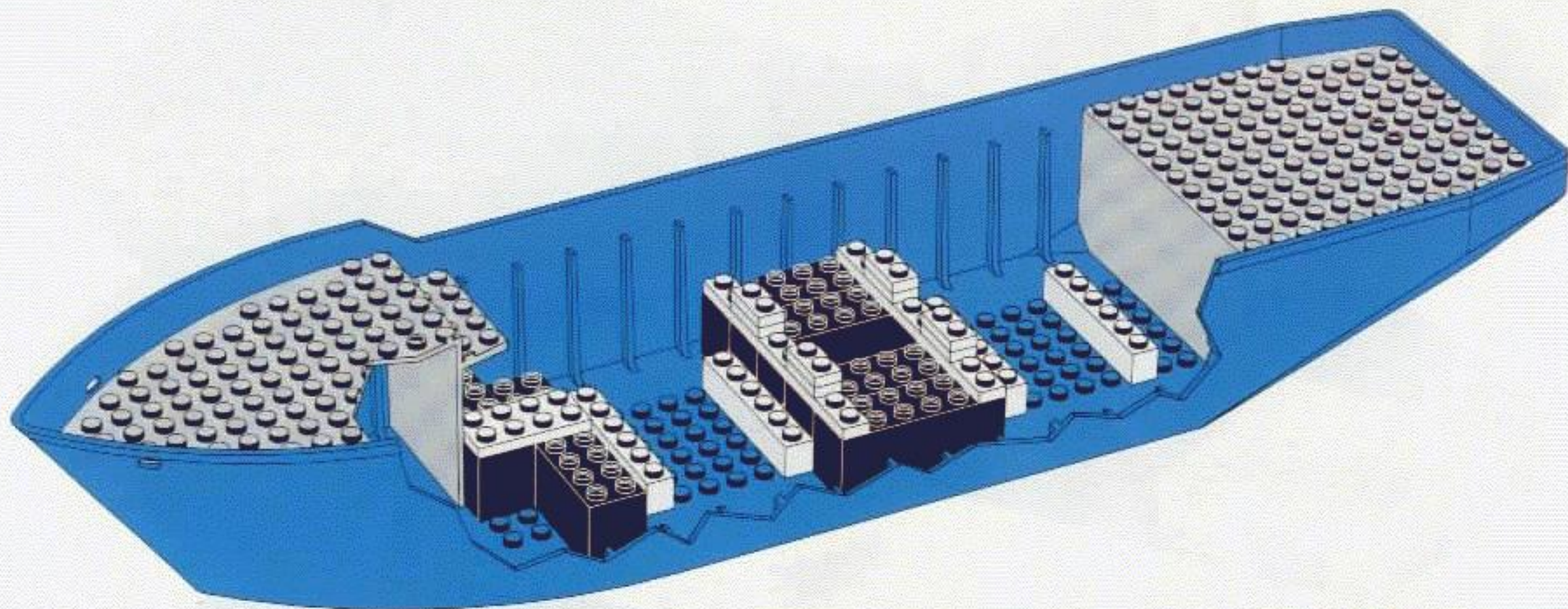

4

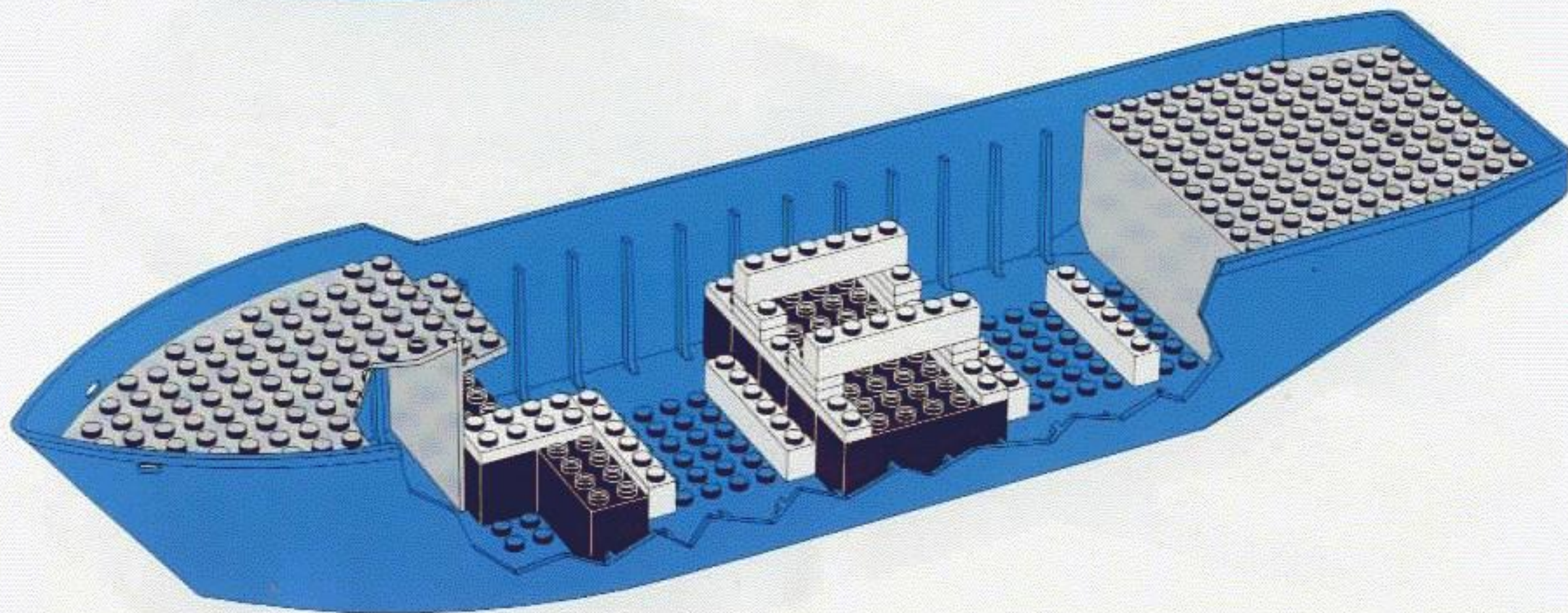

5

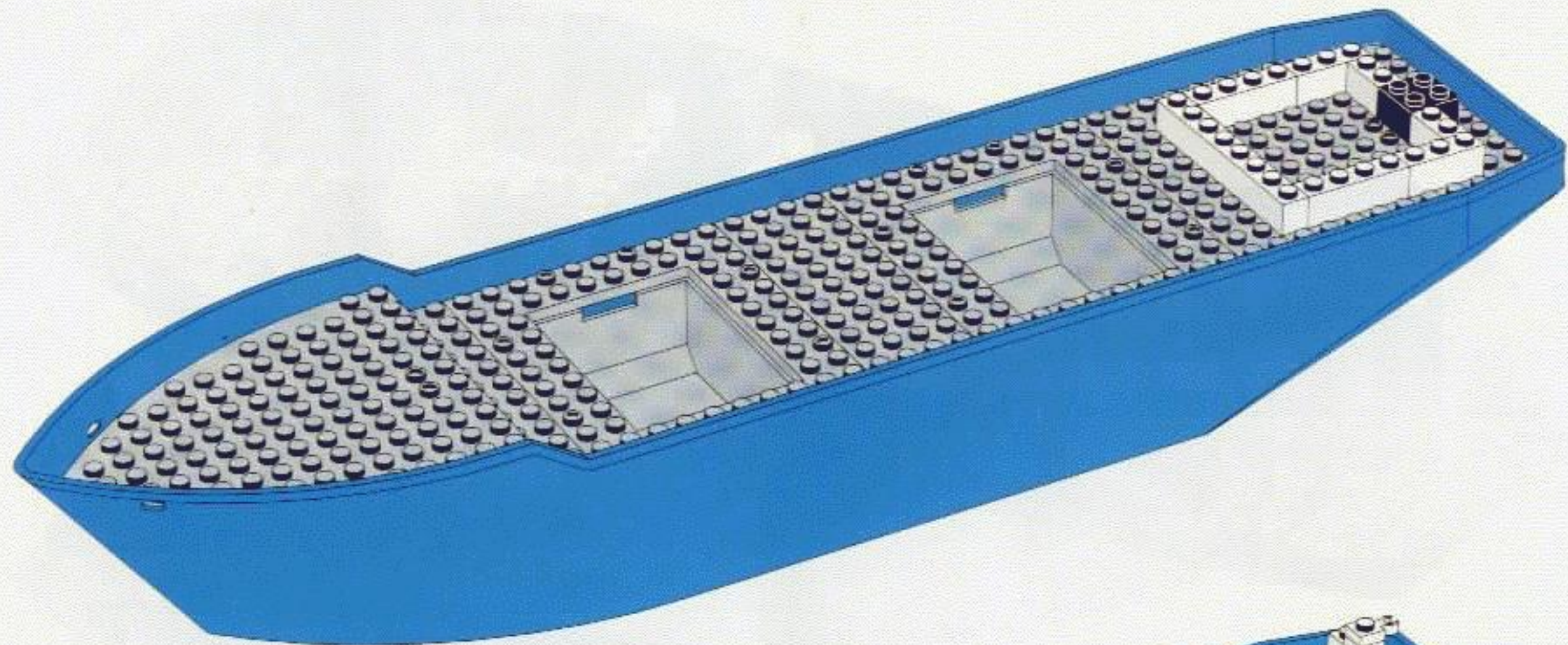

6

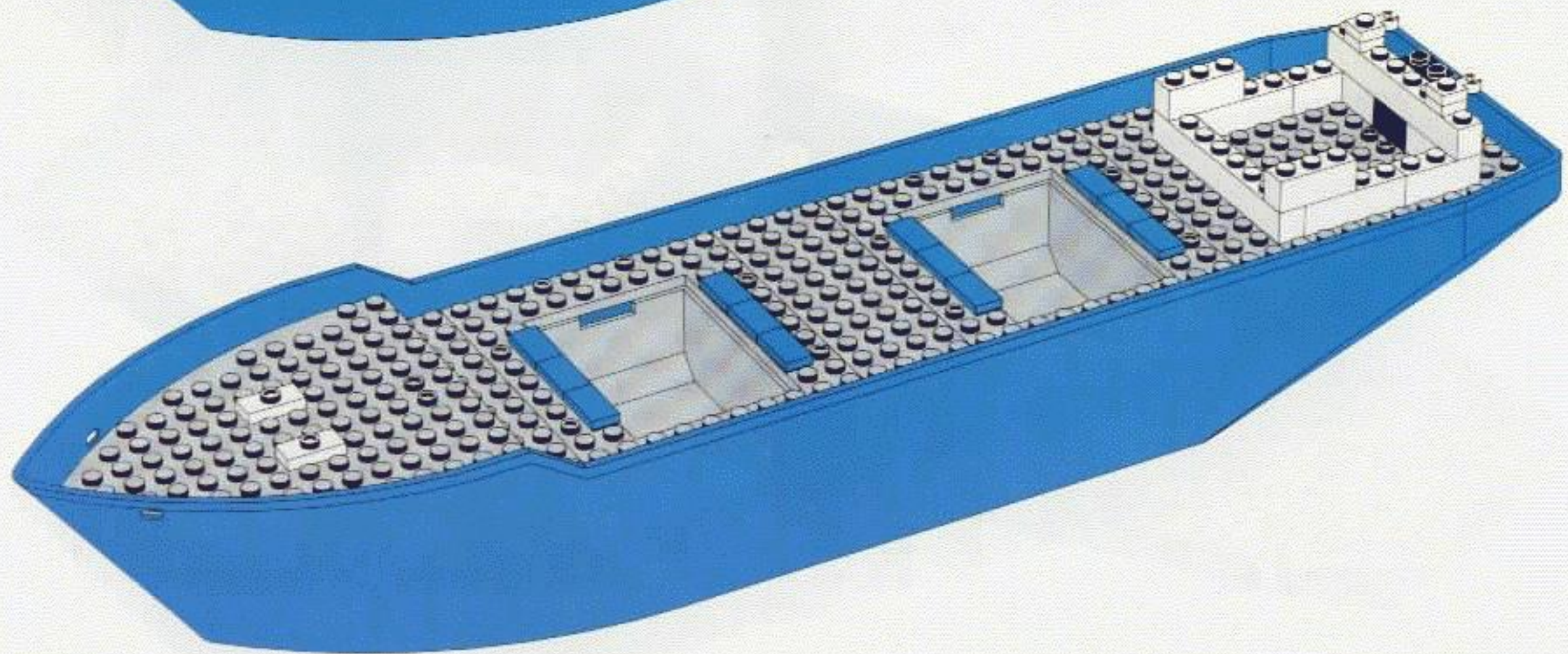

7

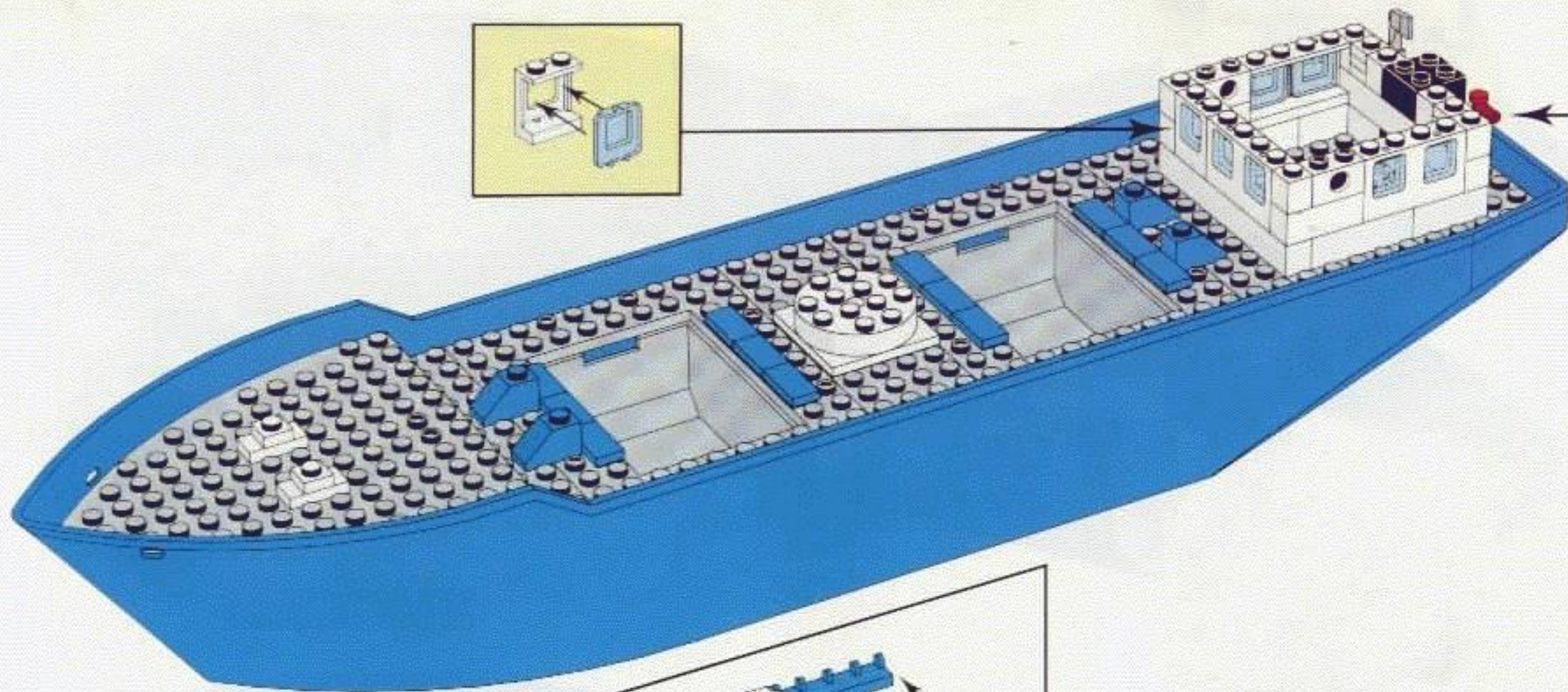

8

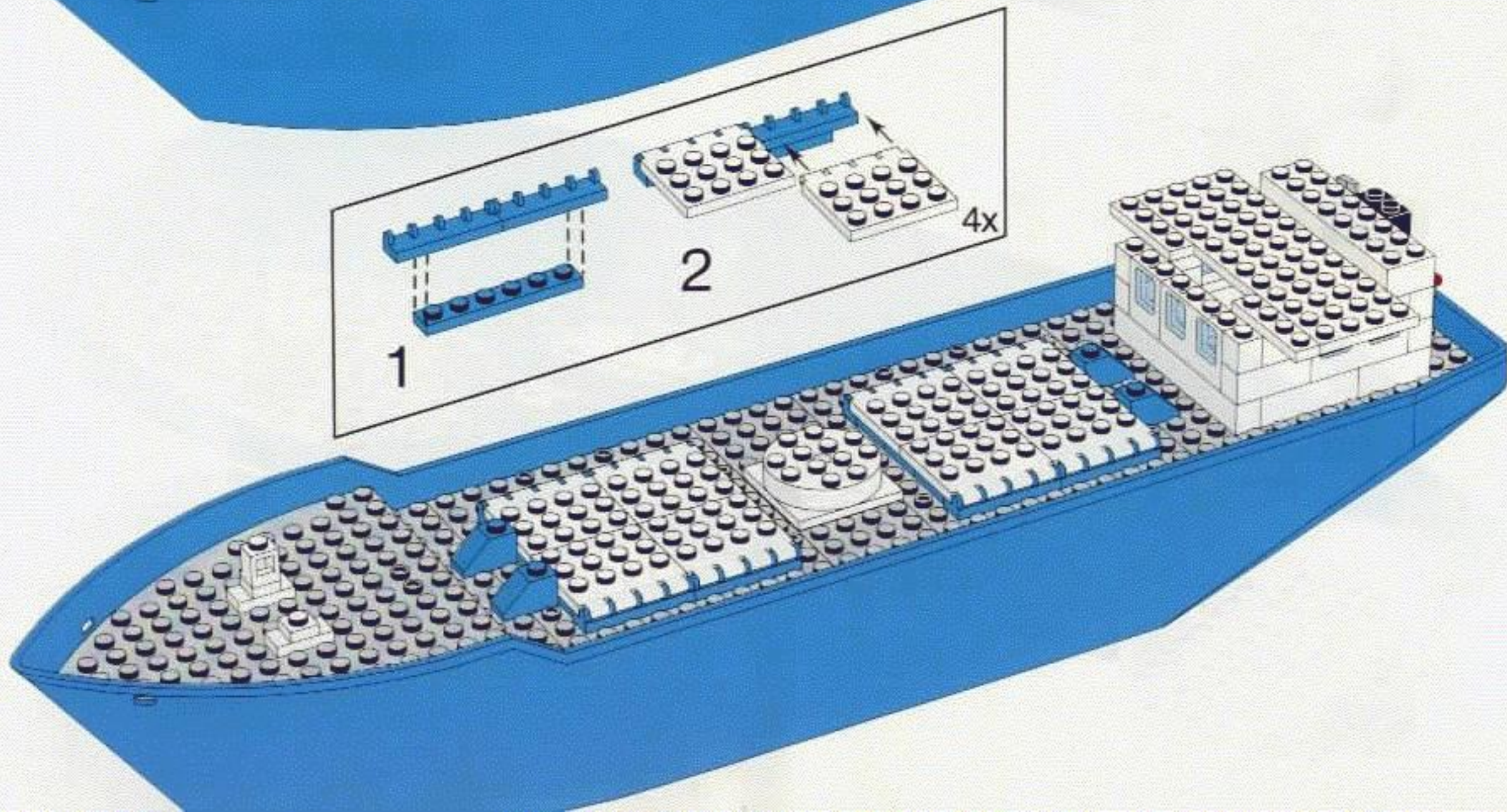

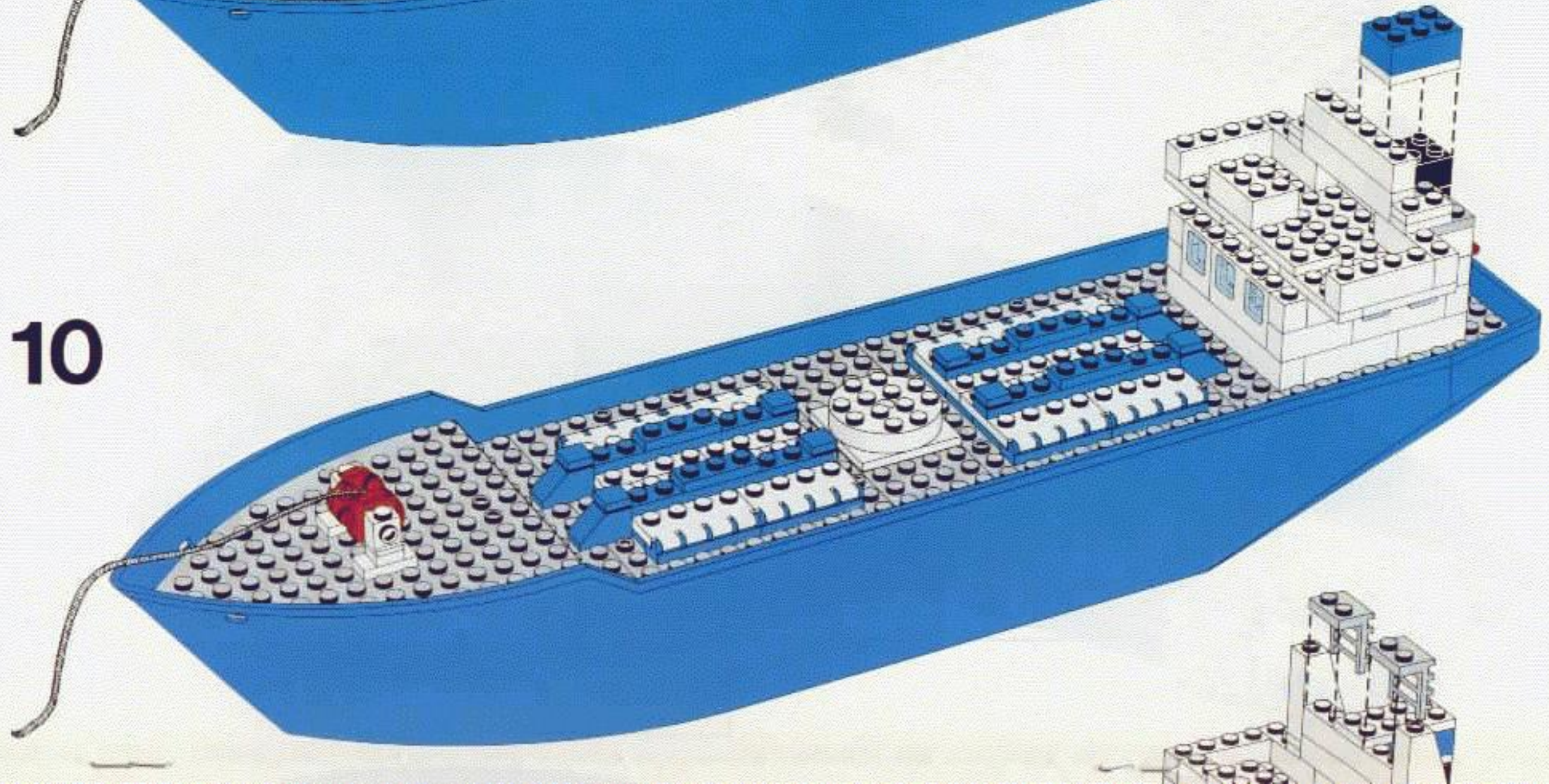
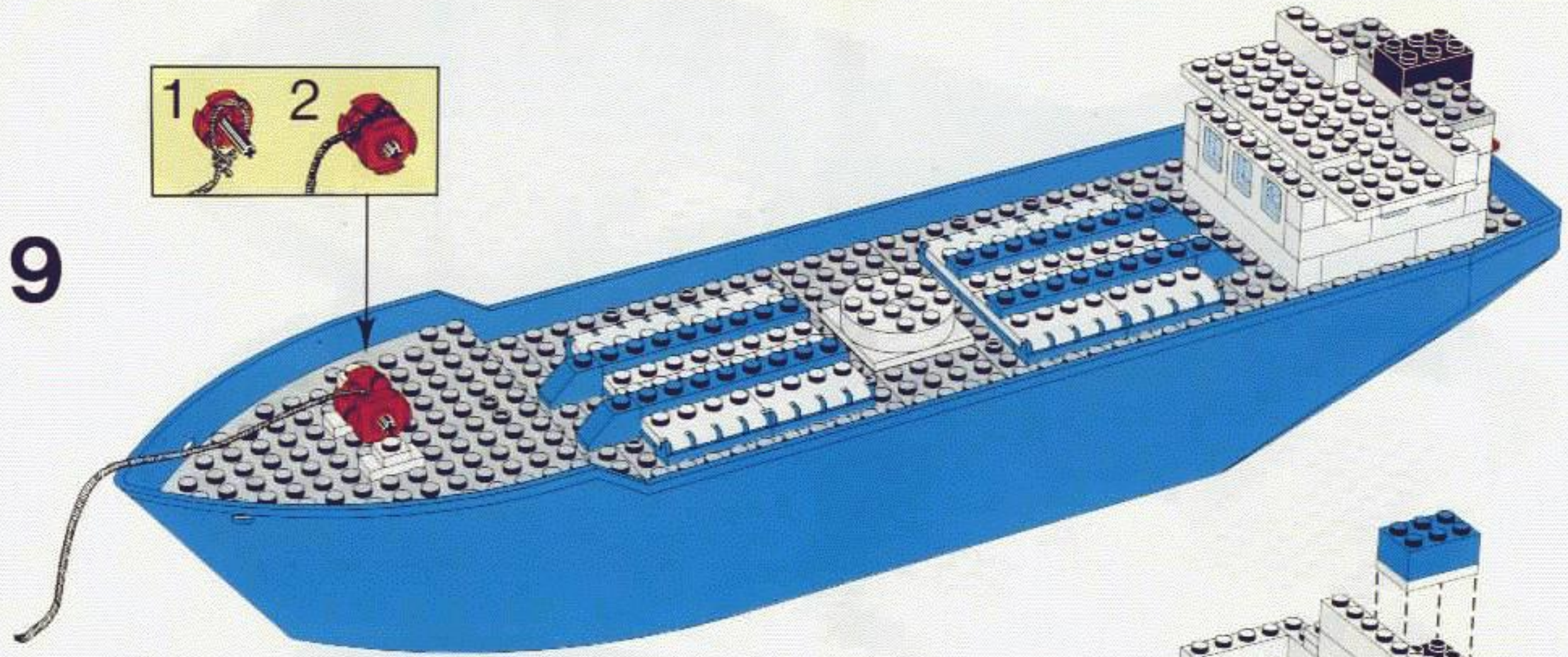

11

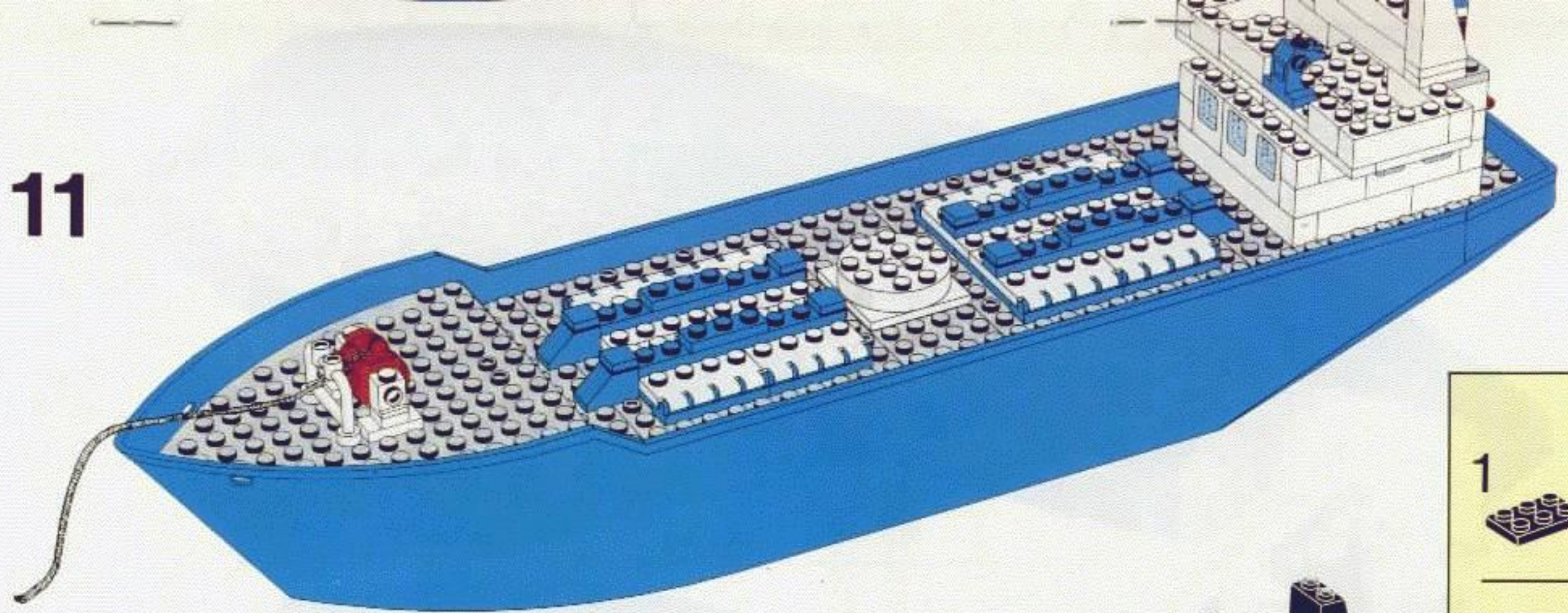

12

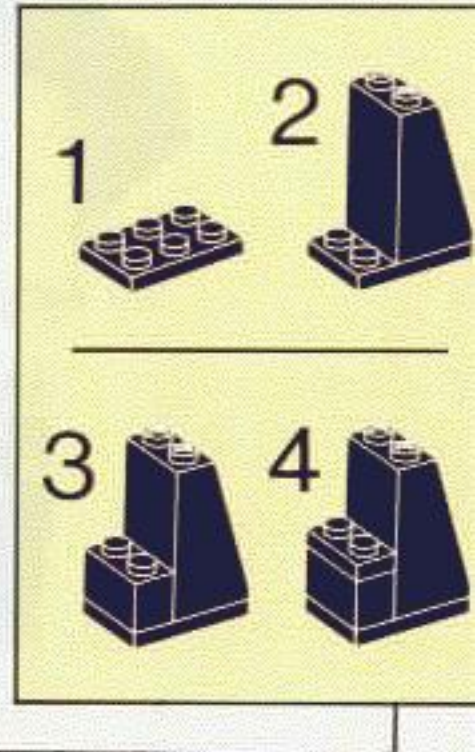
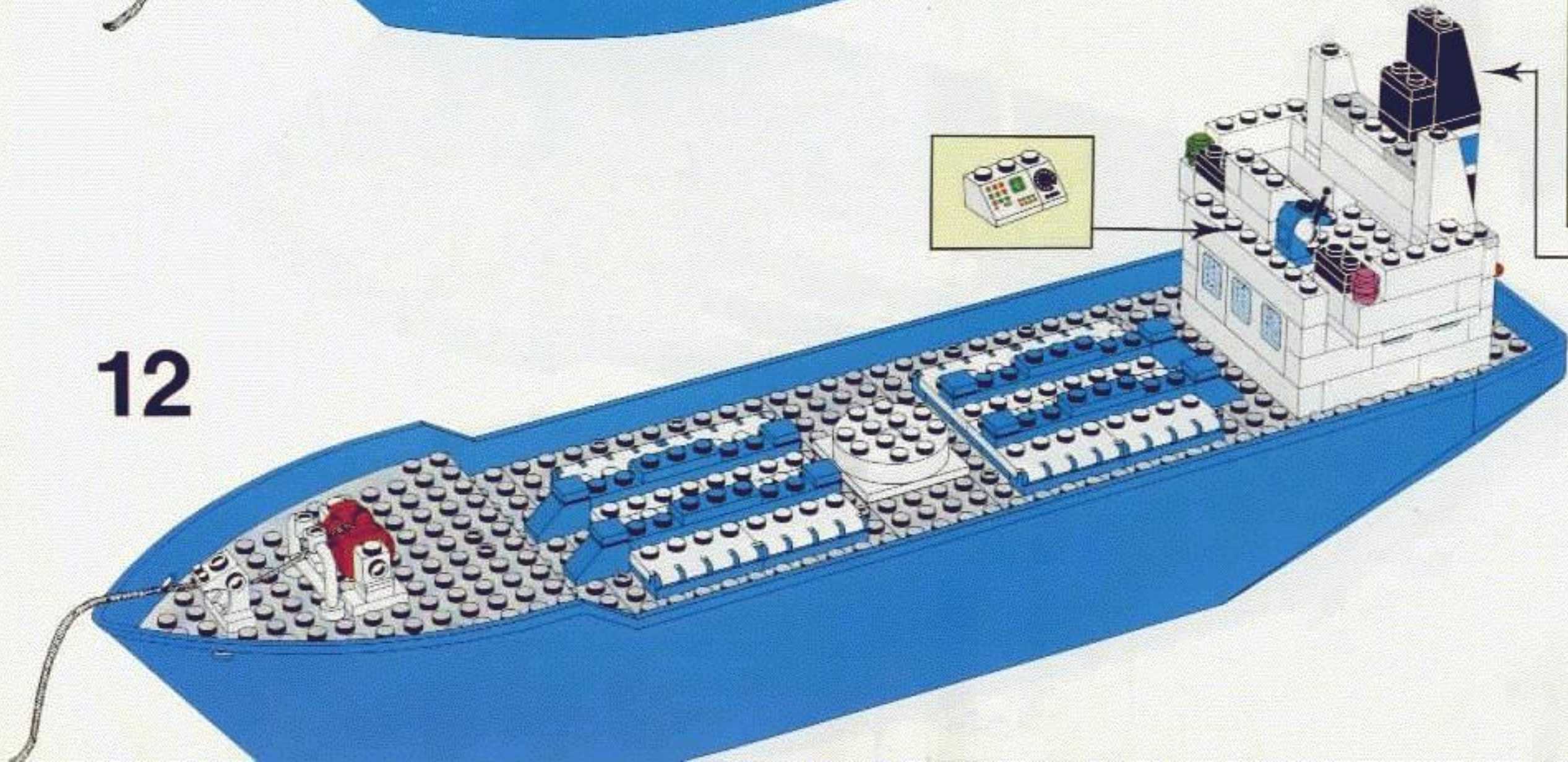

13

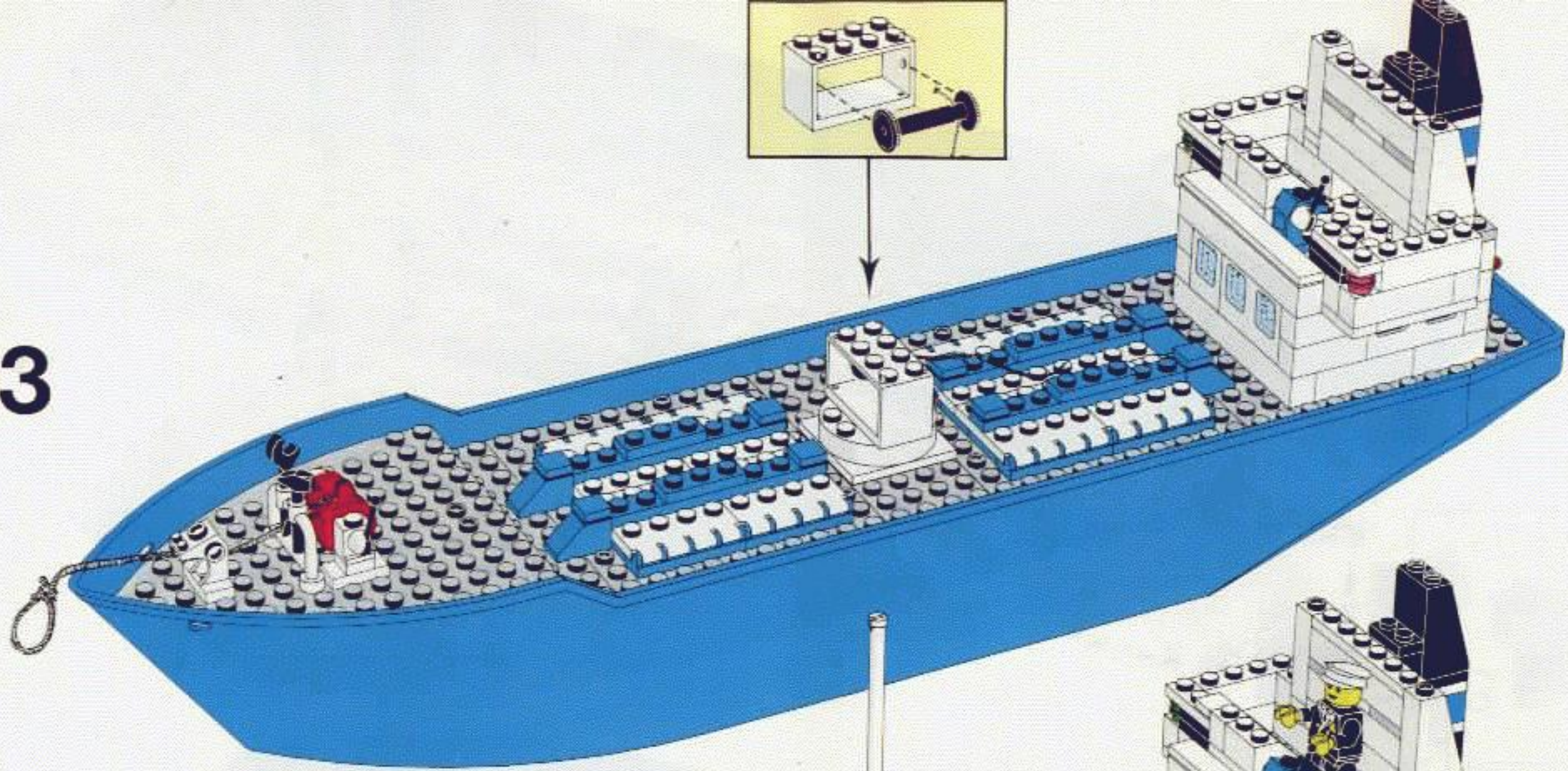

14

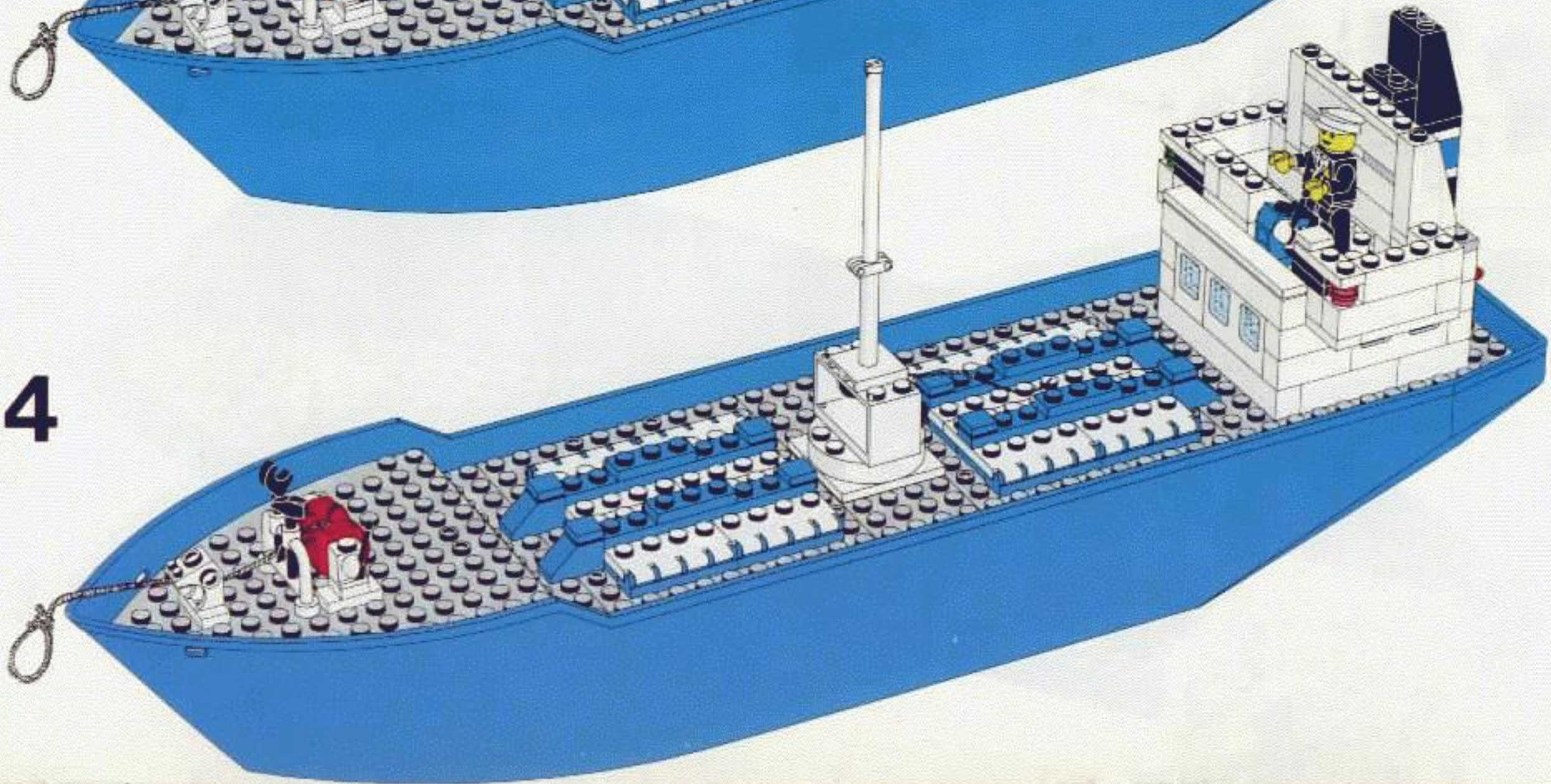

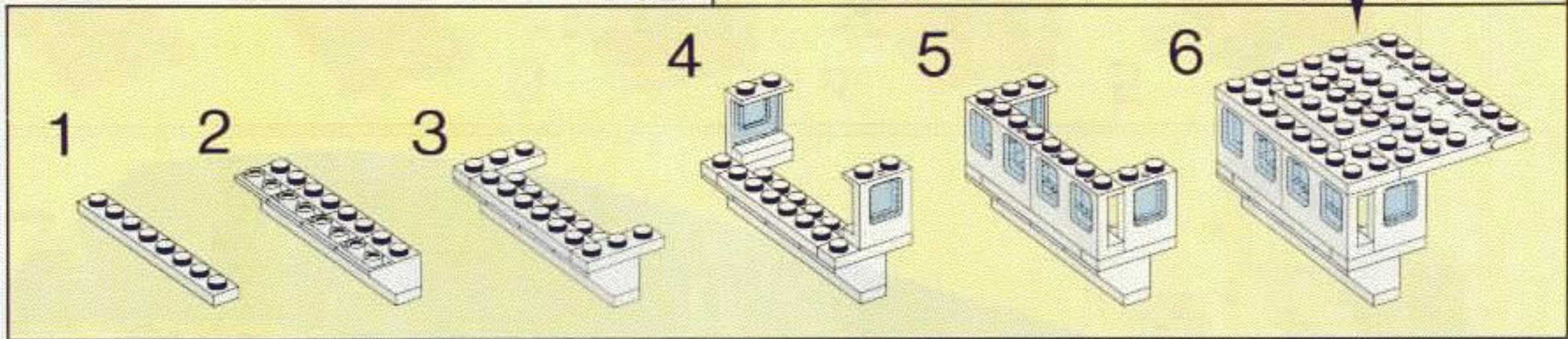
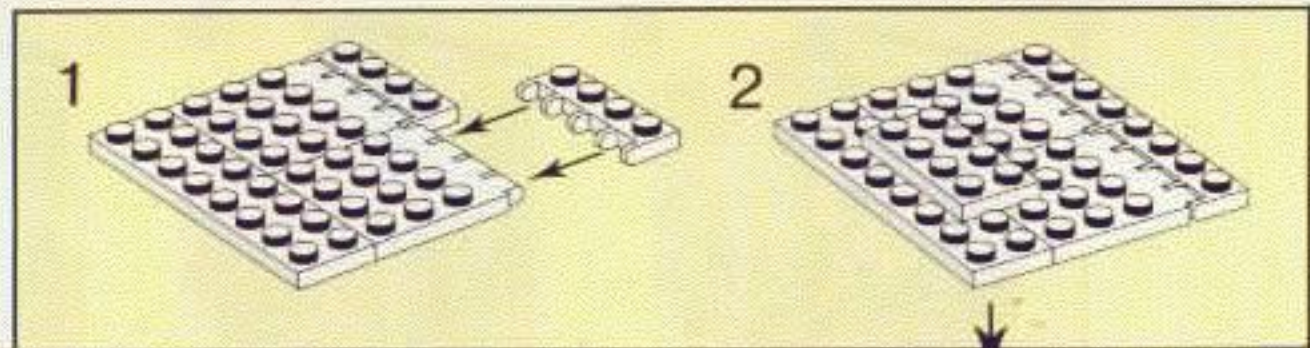

15

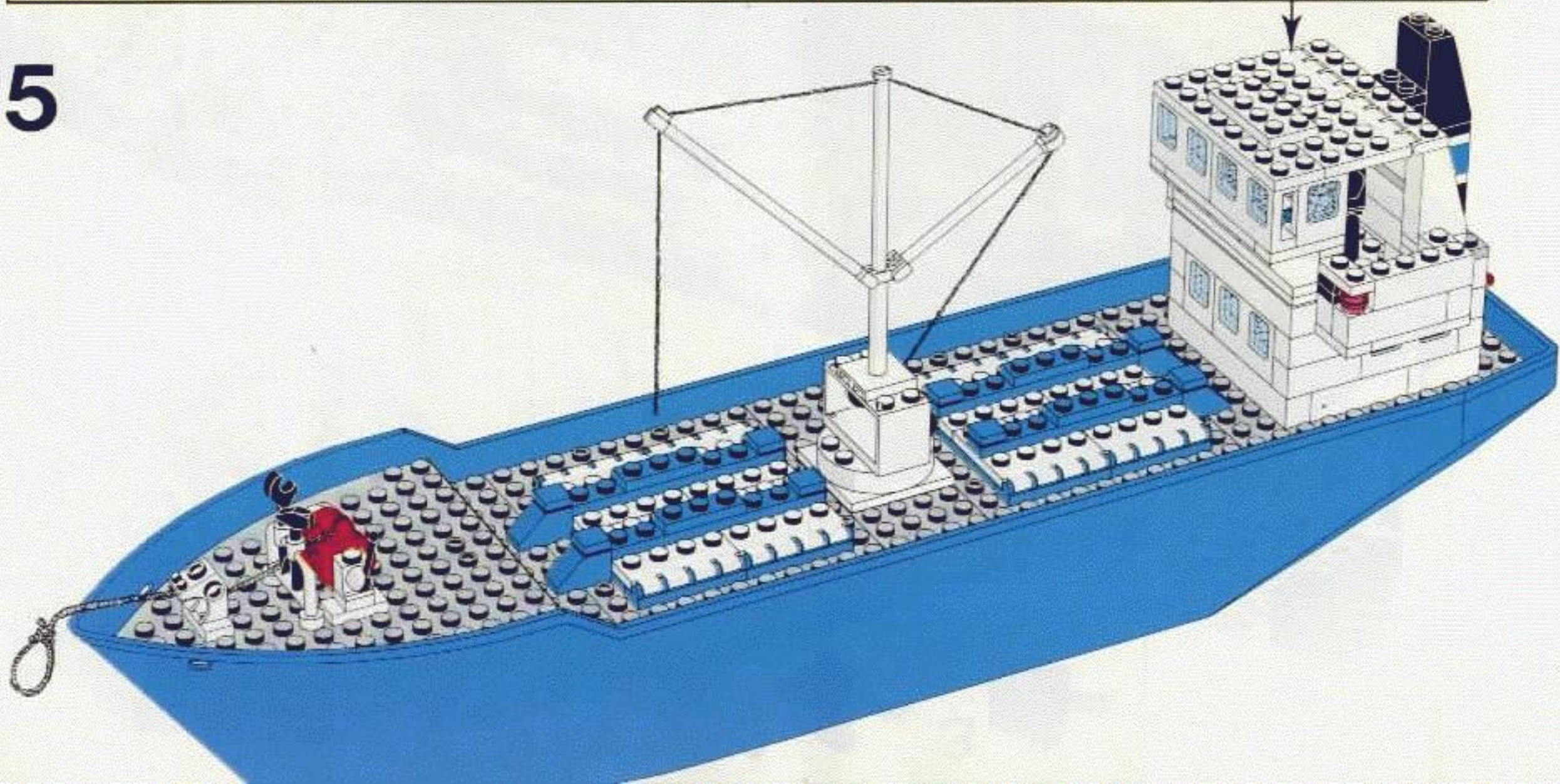

16

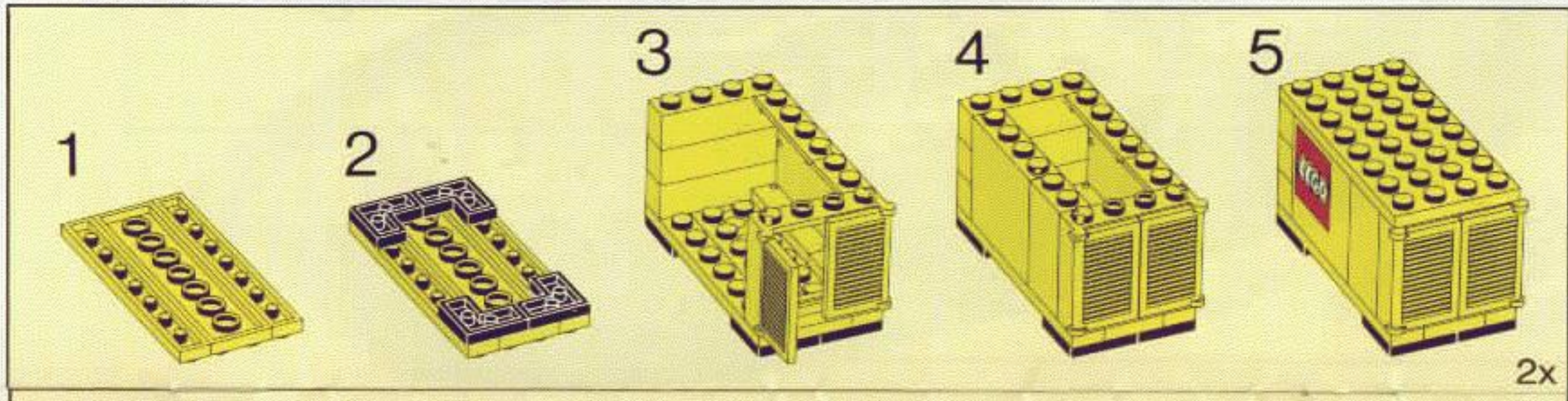
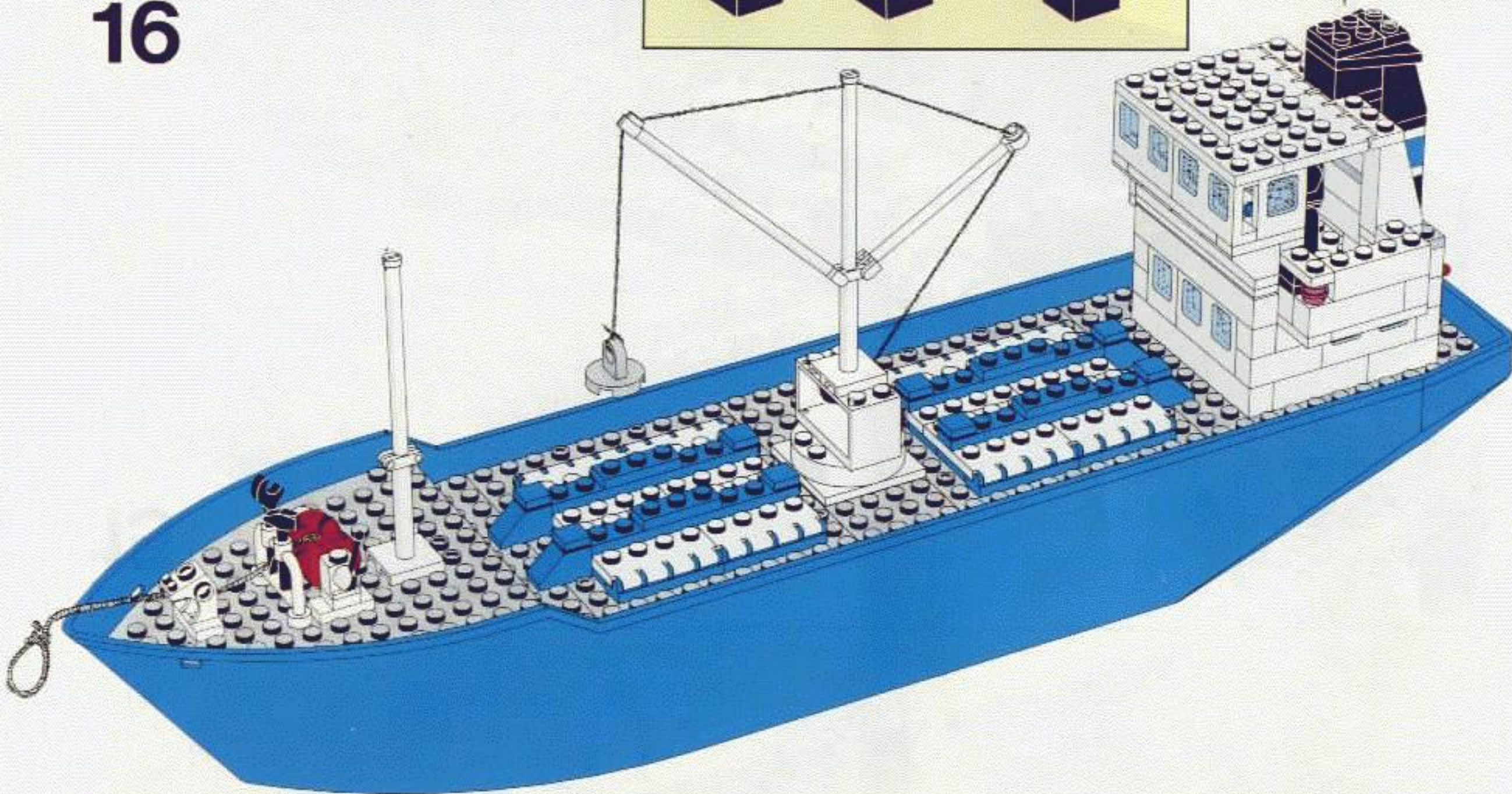

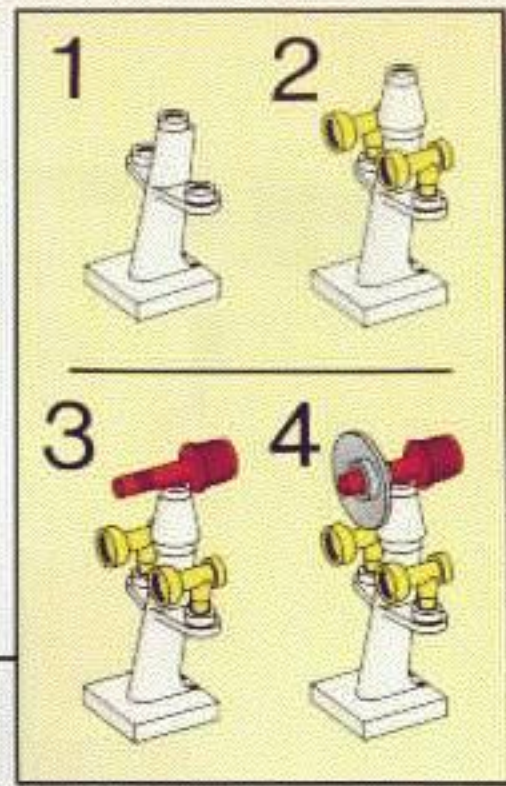
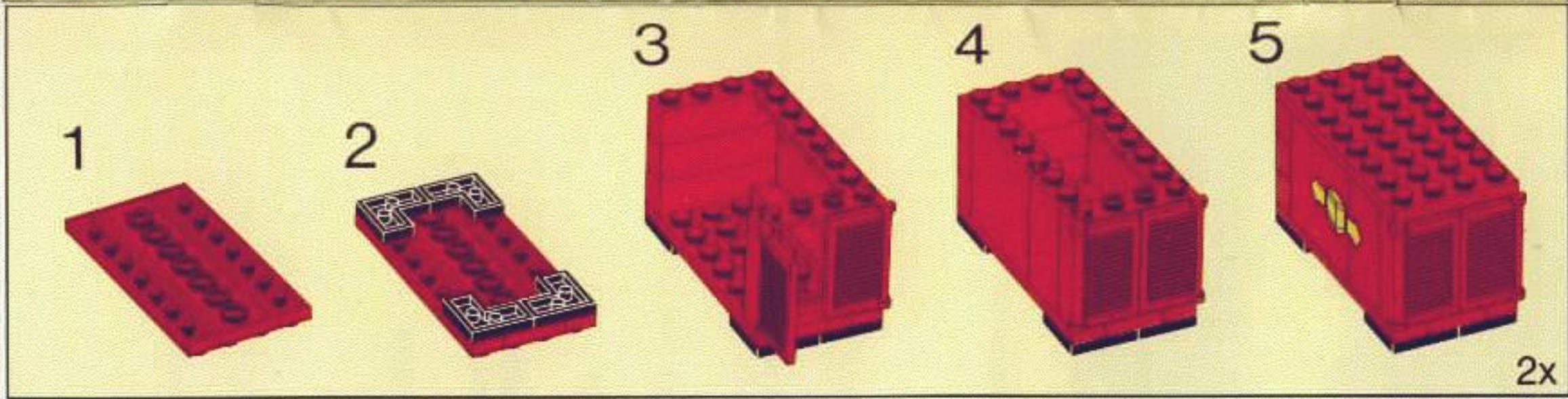

17

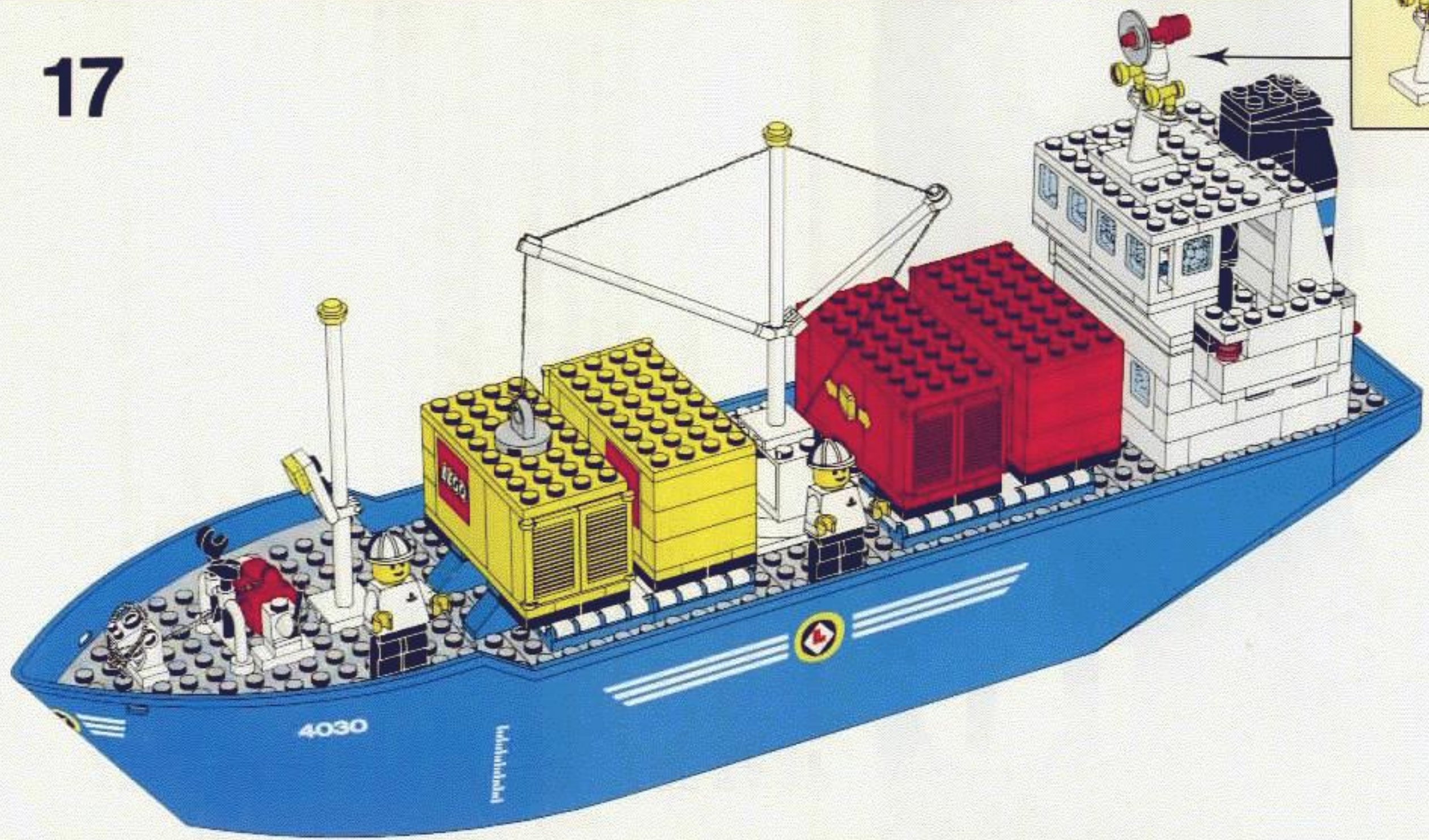

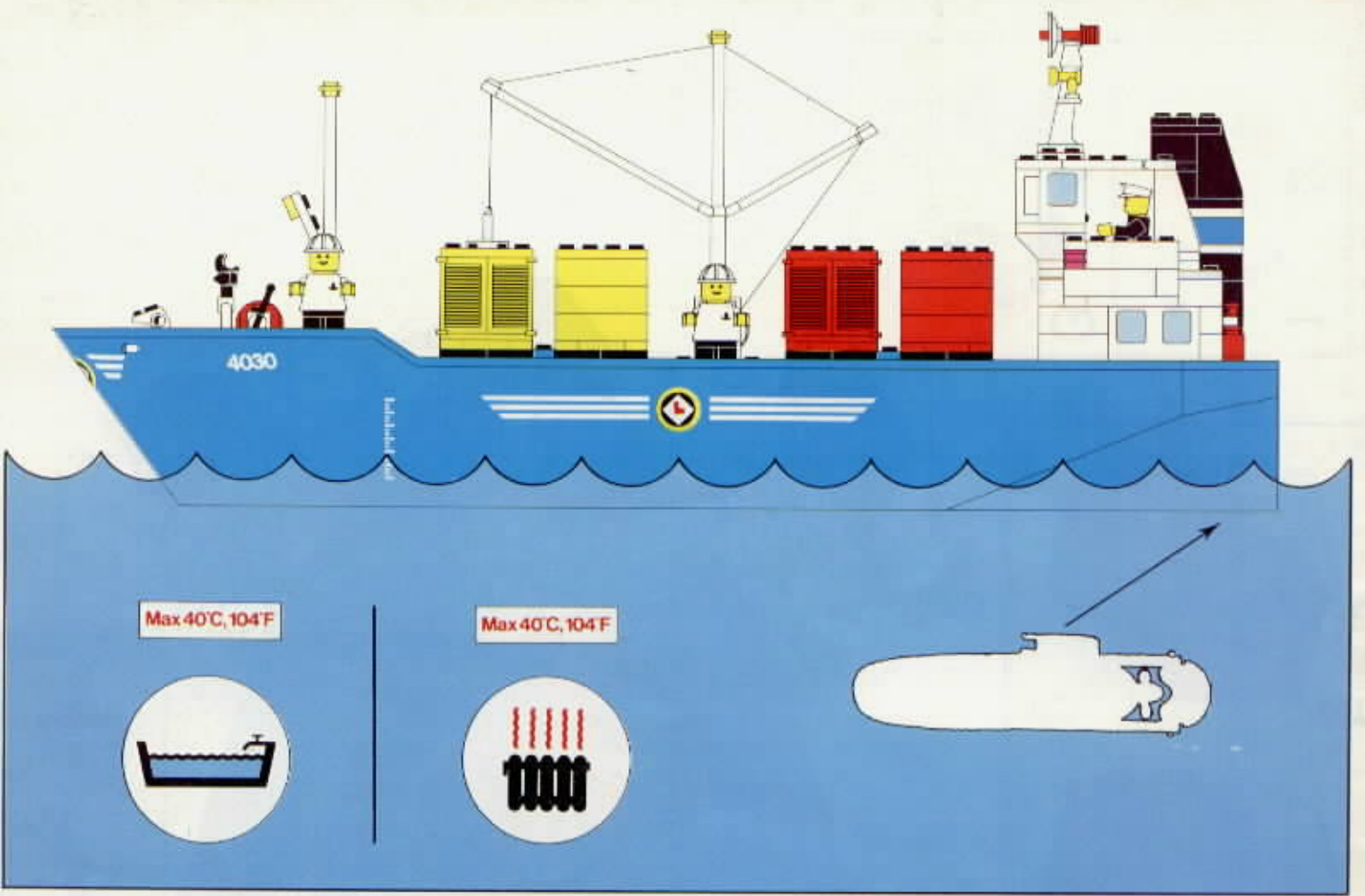

Der Rand auf dem Boden des Schiffes ist für die Anbringung verschiedener Motoren (nicht von LEGO®) vorgesehen.

Alla base dello scafo è possibile collegare diversi tipi di motore (non prodotti dalla LEGO®).

La glissière sous la coque permet d'attacher différentes sortes de moteurs (pas de marque LEGO®).

Voor mechanische voortstuwing van deze boot verkopen meerdere winkels een speciaal batterij-motortje (geen LEGO® product) dat eenvoudig in de gleuf geschoven kan worden aan de achterzijde van de romp-bodem.

Puedes enganchar distintos modelos de motores (no LEGO®) por el borde del casco.

Tappen på kølen muliggør montering af forskellige motorer på skibet. (Disse motorer produceres ikke af LEGO Gruppen).

In some countries propellor motors (not made by LEGO®) are available from model shops. The notch in the bottom of the hull allows these motors to be attached.

Rungon pohjassa olevan tapin ansiosta laivaan voidaan asentaa erilaisia moottoreita. (Ei LEGO® valikoimassa).

Tappen i botten på skrovet gör det möjligt att montera olika motorer (ej från LEGO Gruppen).

O rebordo no fundo do casco permite-lhe a ligação de diferentes tipos de motores (não da LEGO®).

Στην εσοχή στο βάθος του σκάφους, μπορείτε να τοποθετήσετε διάφορα μοτέρ (όχι της LEGO®).

船体の底には水中モーター(他社製品)が取り付けられます。

تتيح الحافة الموجودة بأسفل هيكل السفينة توصيل أنواع مختلفة من المحركات بها (المحركات ليست من صنع ليغو).