



STAR WARS™

4489

MINI BUILDING SET



AT-AT™

MINI

A promotional image for LEGO Star Wars. The background features a large, close-up portrait of Yoda's face, looking slightly to the right. The image is set against a blue sky with white clouds. Scattered across the scene are various LEGO Star Wars sets, including a large AT-AT walker on the left, a Millennium Falcon in the center, a Rebel X-wing fighter on the right, and several smaller vehicles and figures. At the bottom, the LEGO logo is on the left and the Star Wars logo is on the right.

LEGO

**STAR
WARS™**

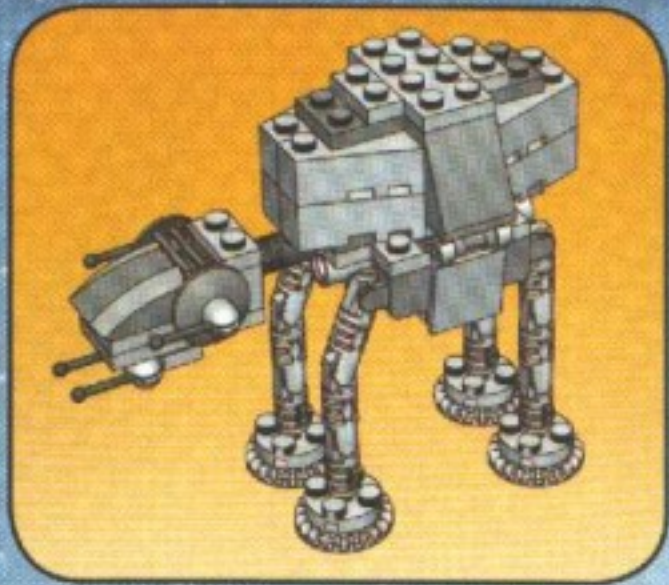

1

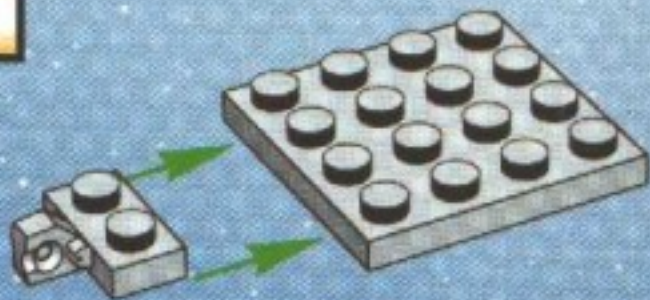

2

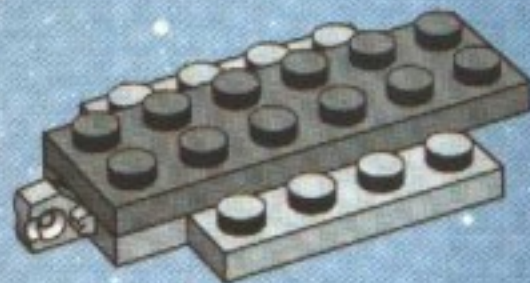

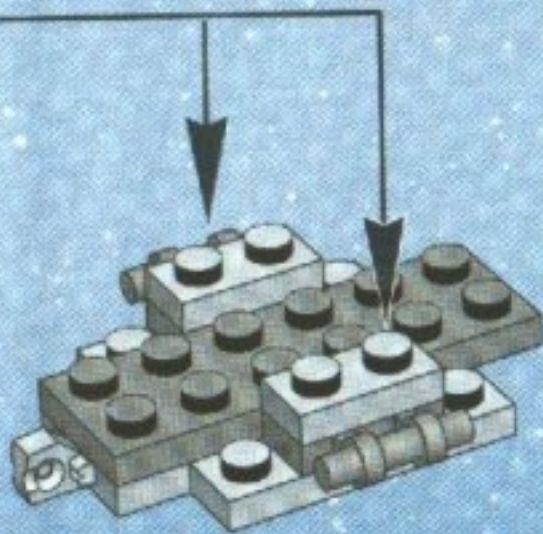
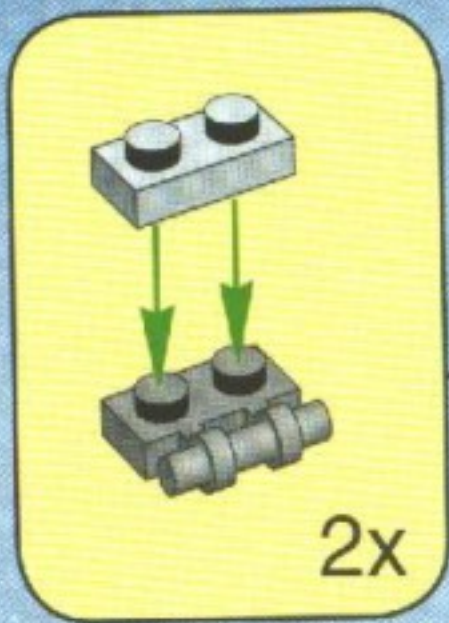

4

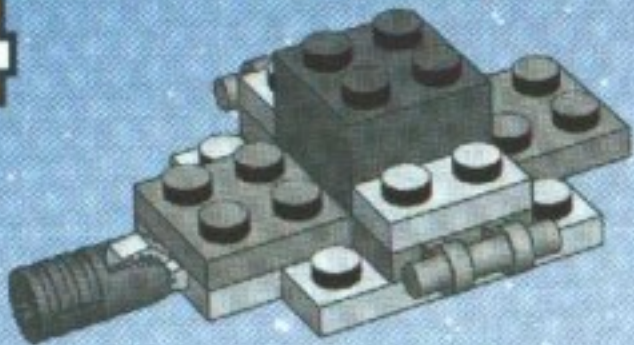

5

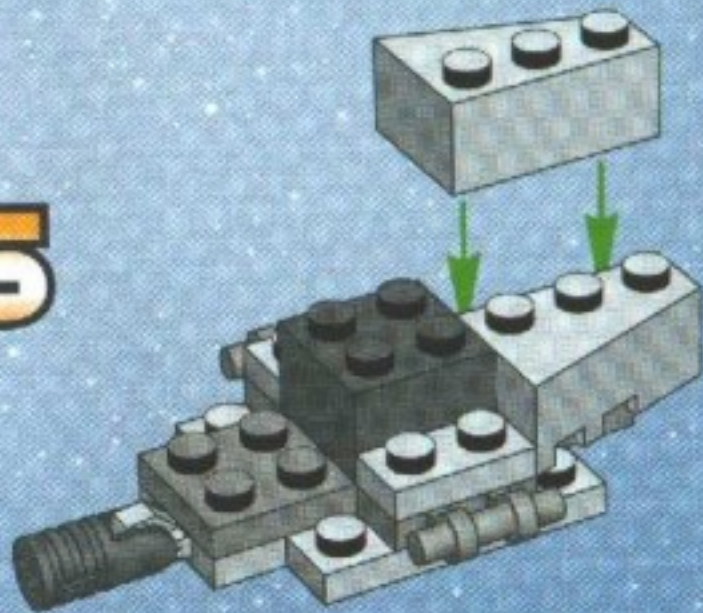

6

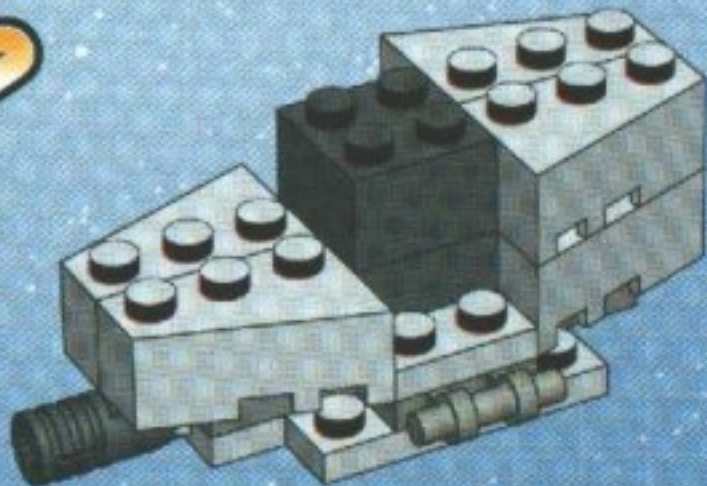
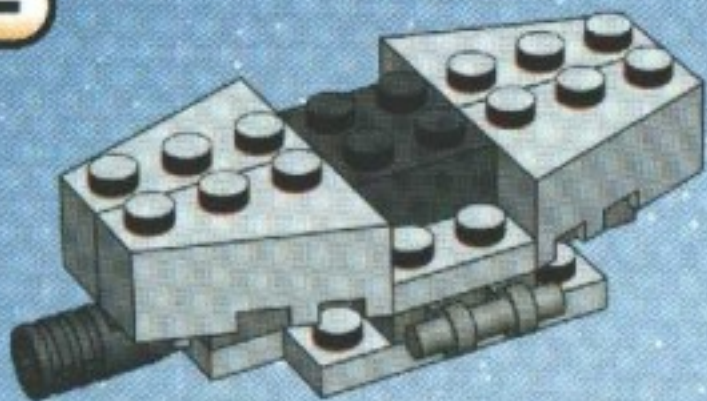

8

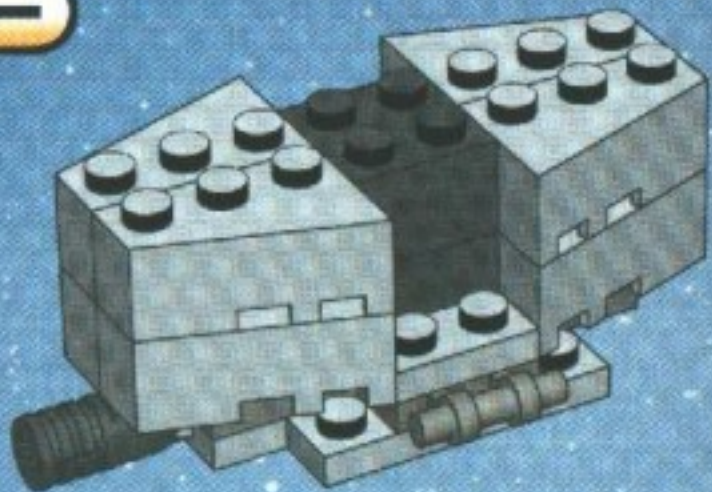

9

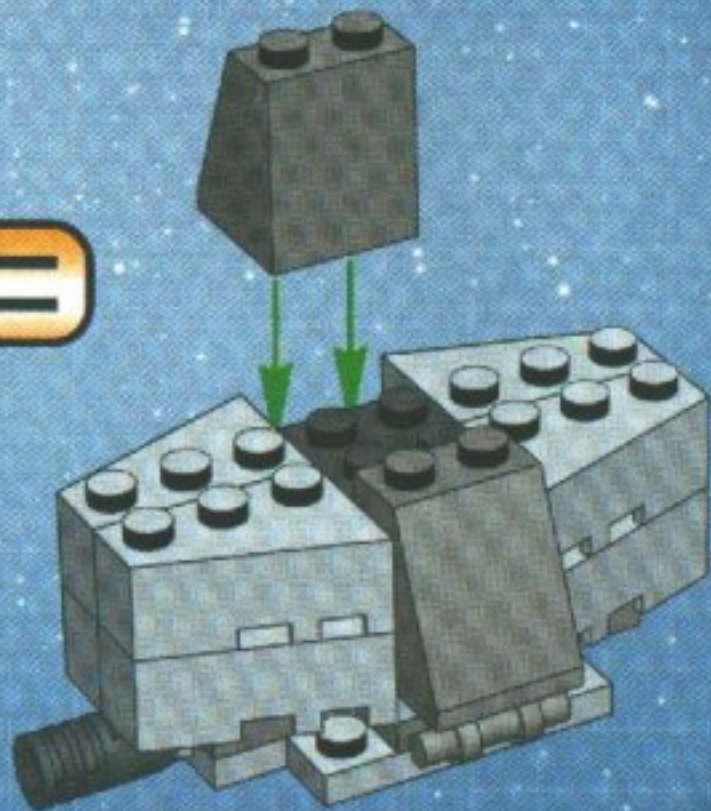

10

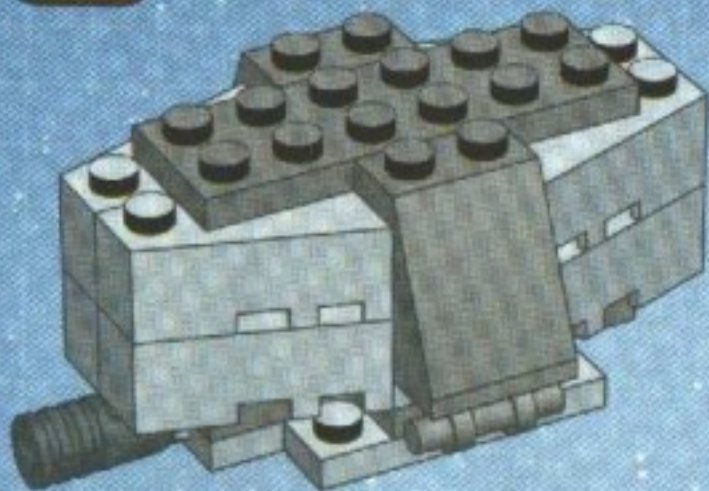

11

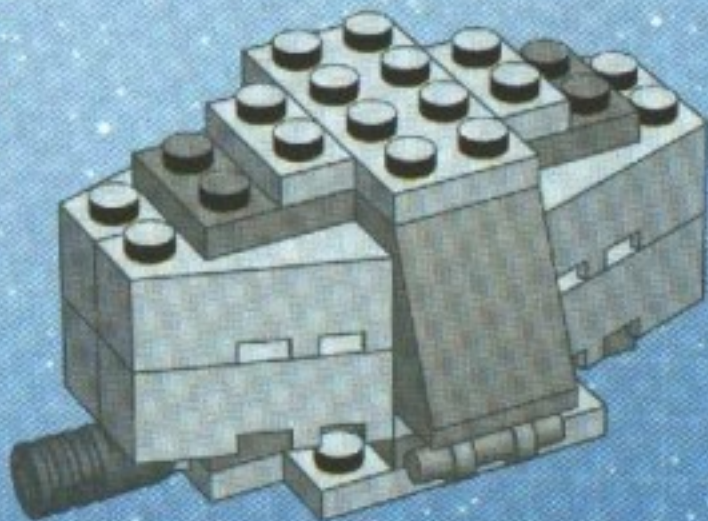

12

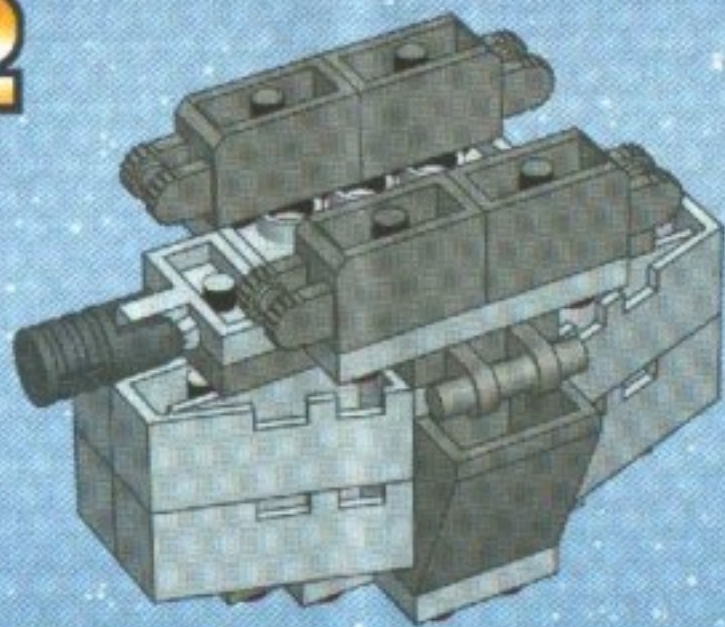

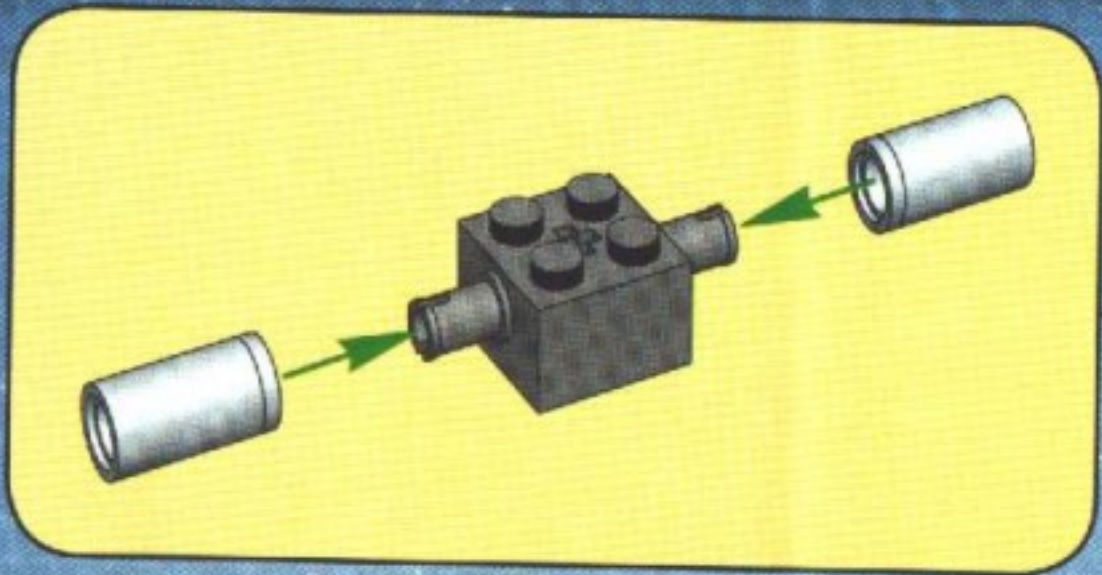

13

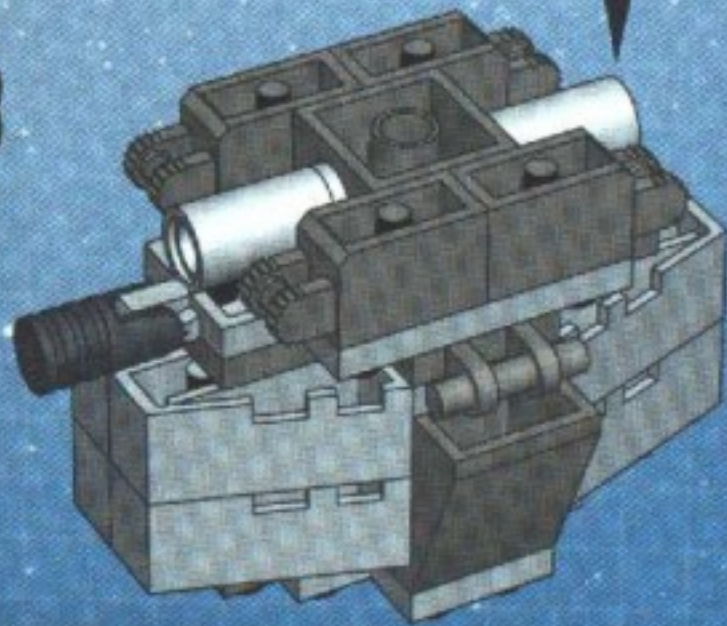

14

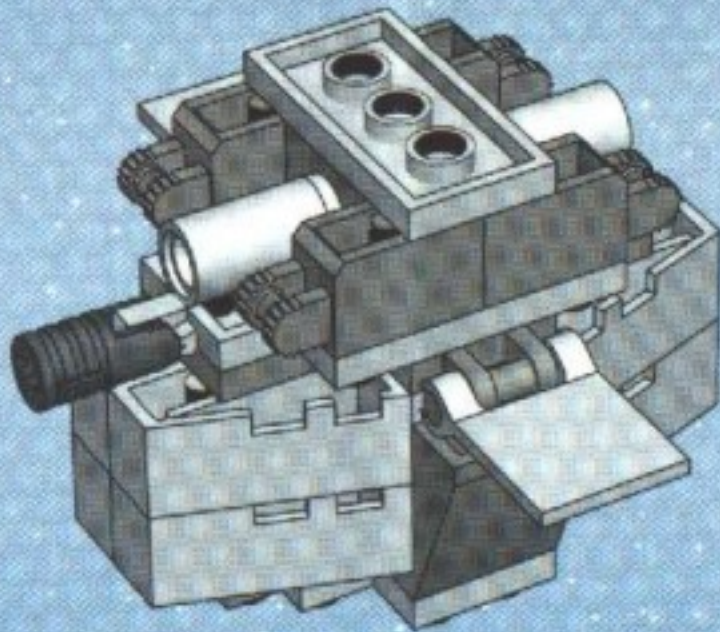

1



2



3



4



5



4x

15





1



2

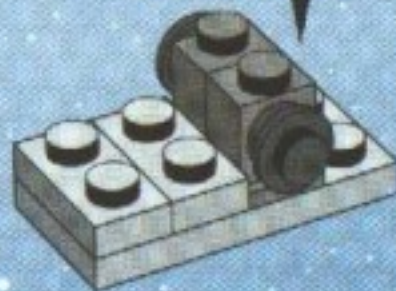
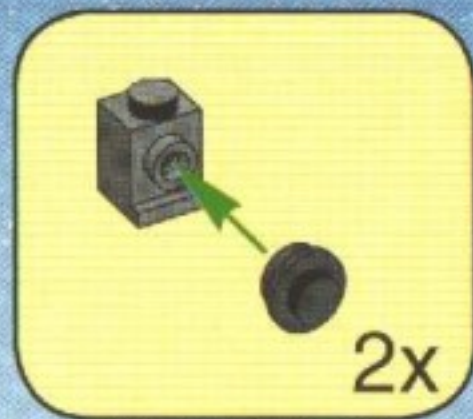

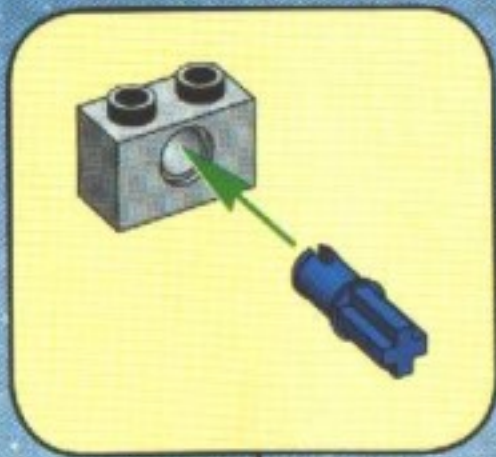

3

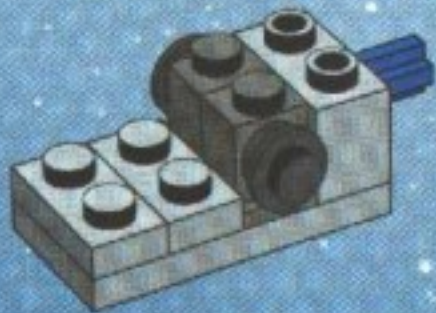

4

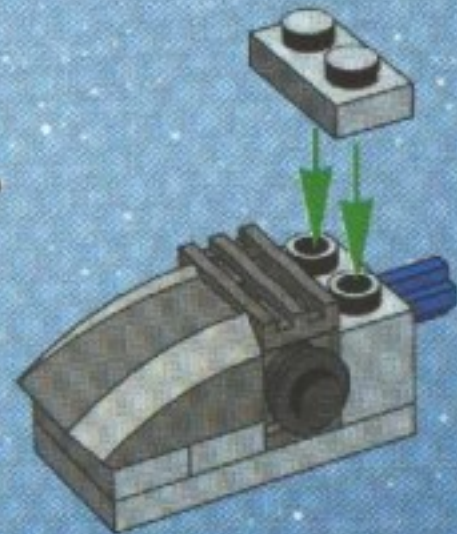



5

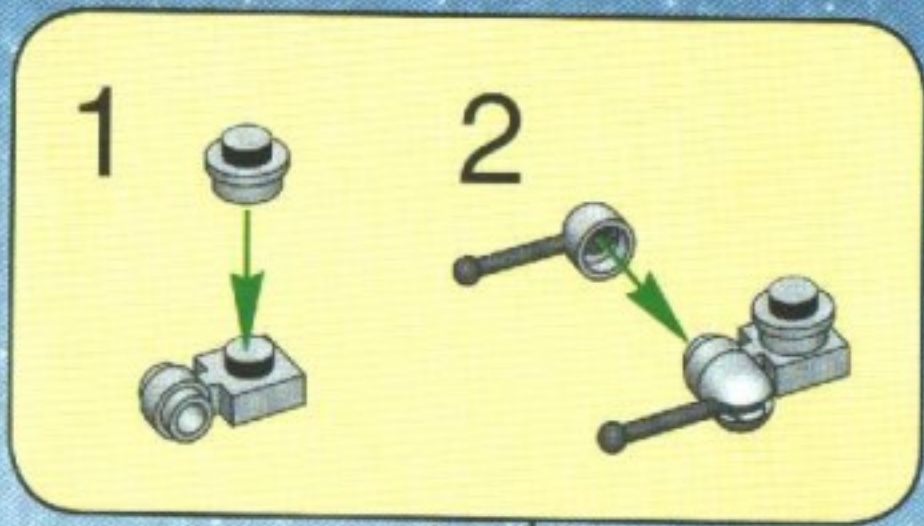
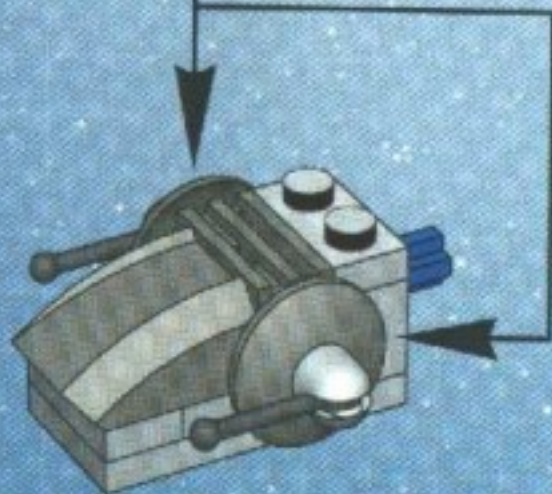

6



16





STAR WARS



+



+



+



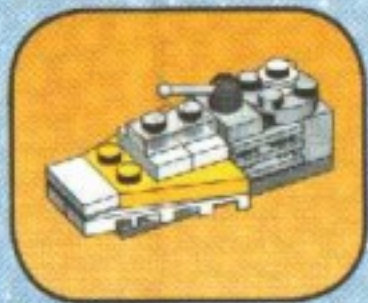

1

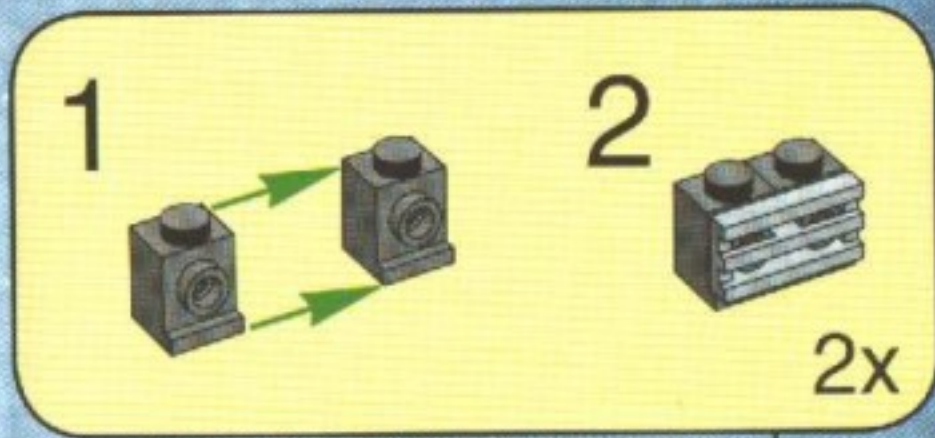
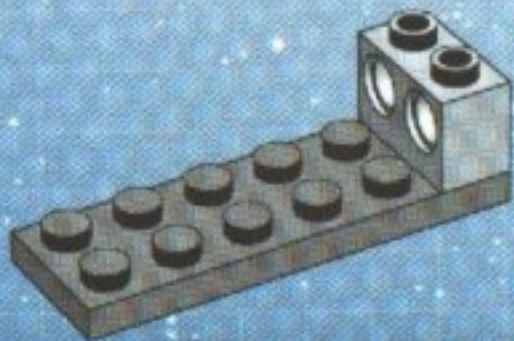

2

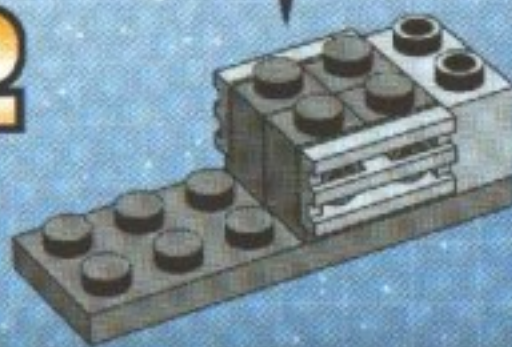

B

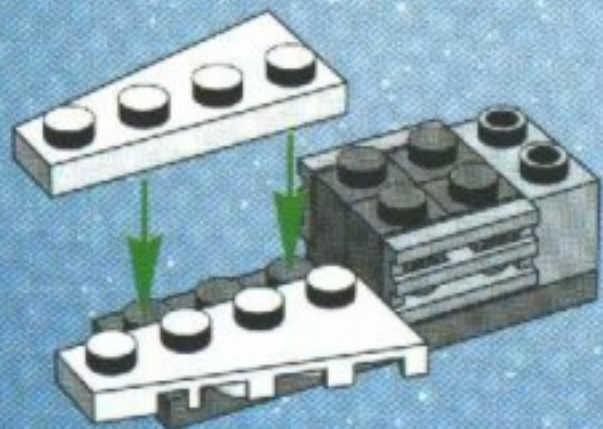

4

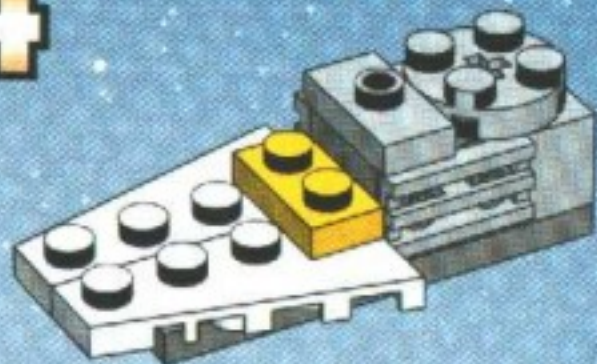

5

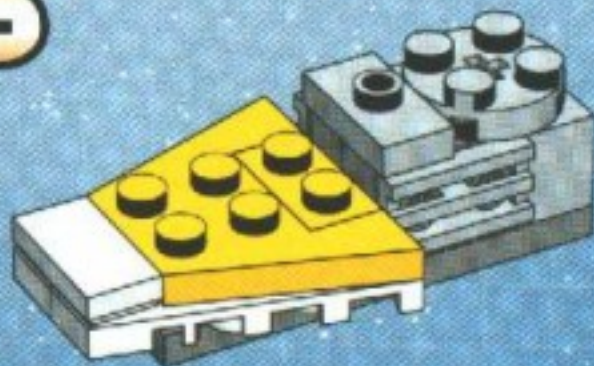

6





1

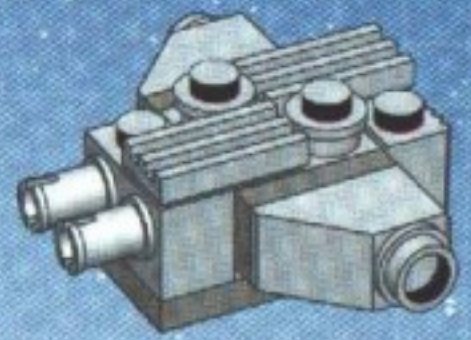

2

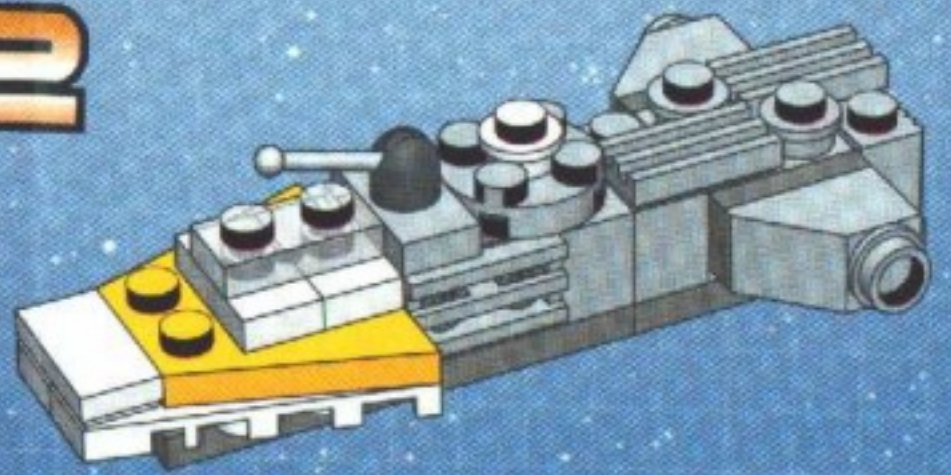

3

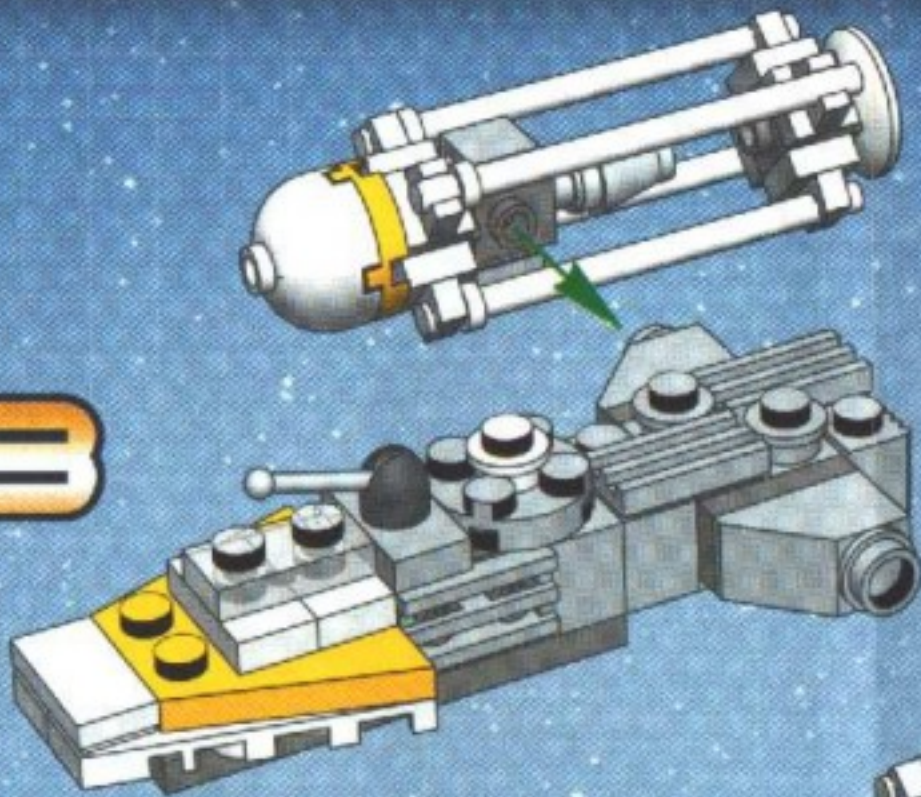

4

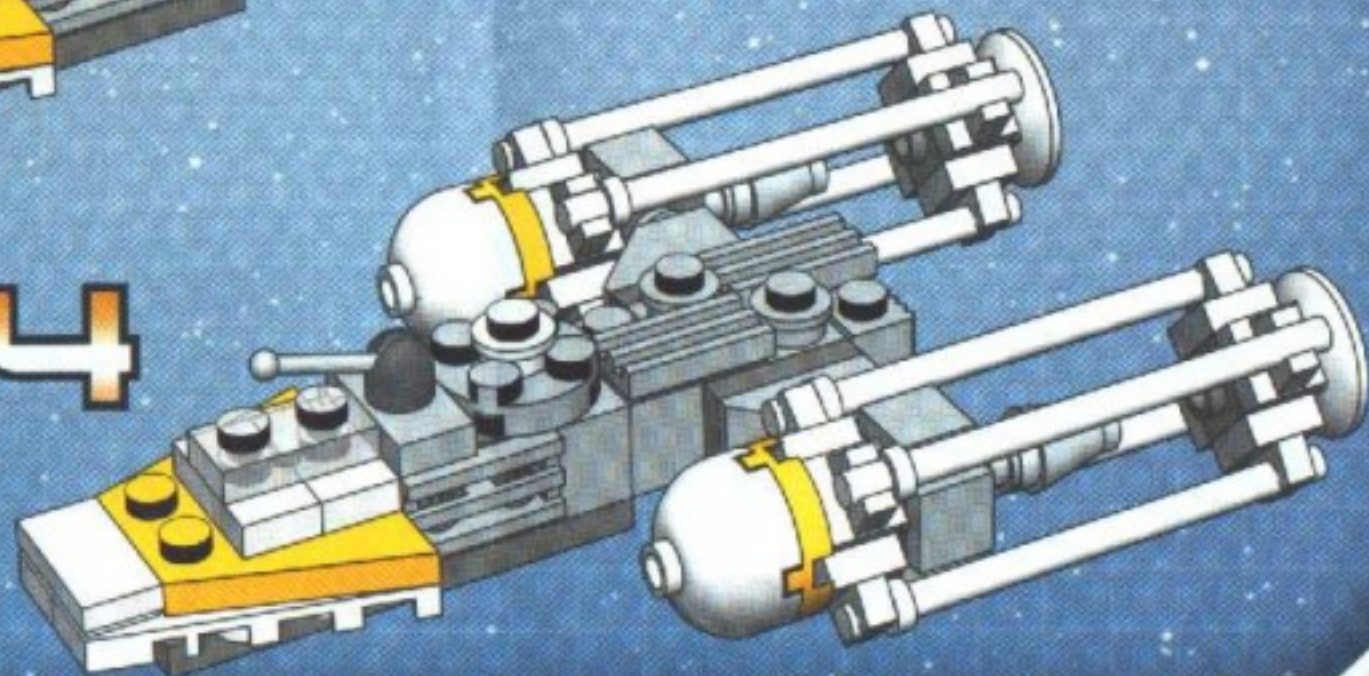

4476

4480

4475





4477

4477

4477

4478

4478

7163

4478

4482

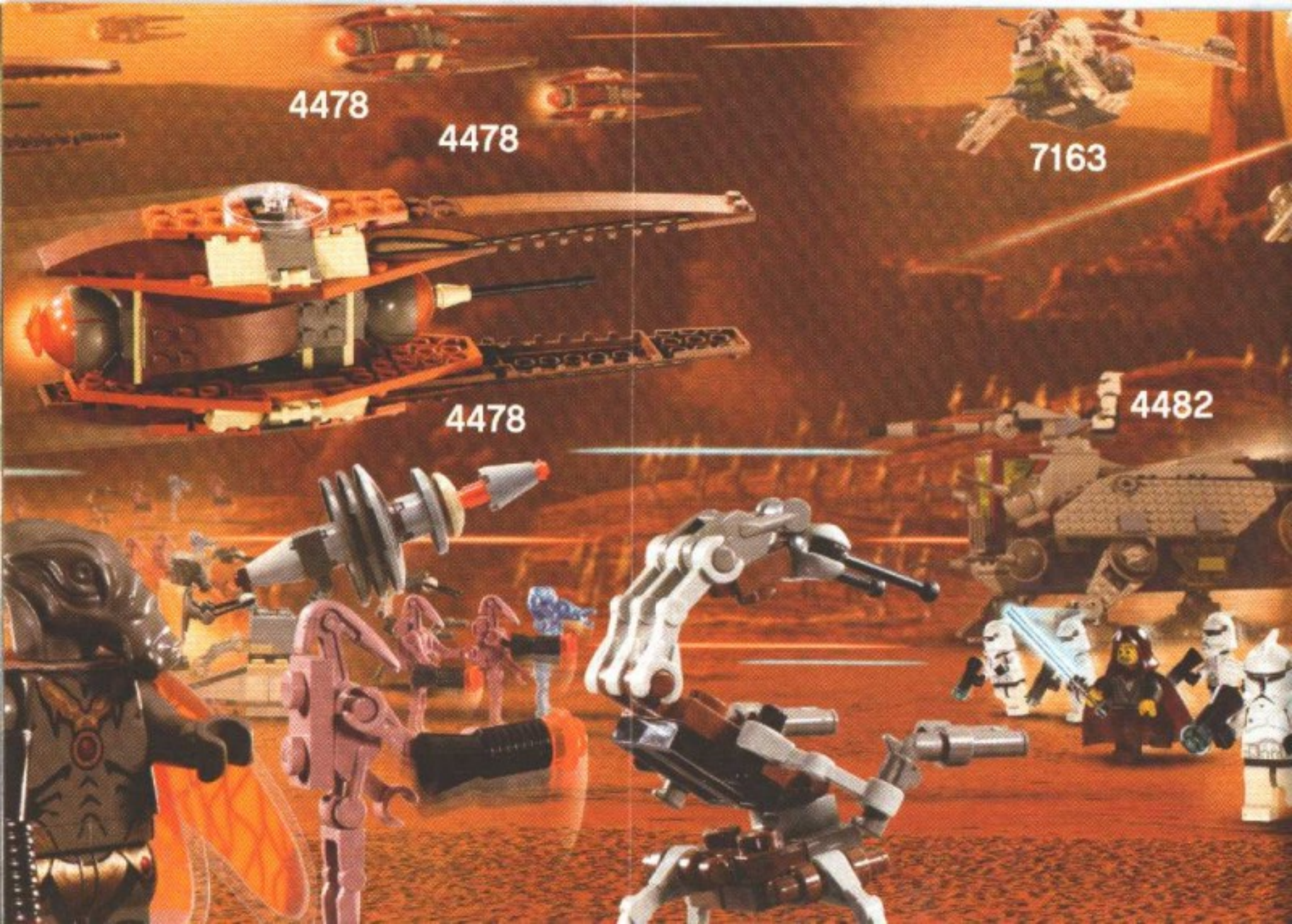

7163

7163

4482

4482

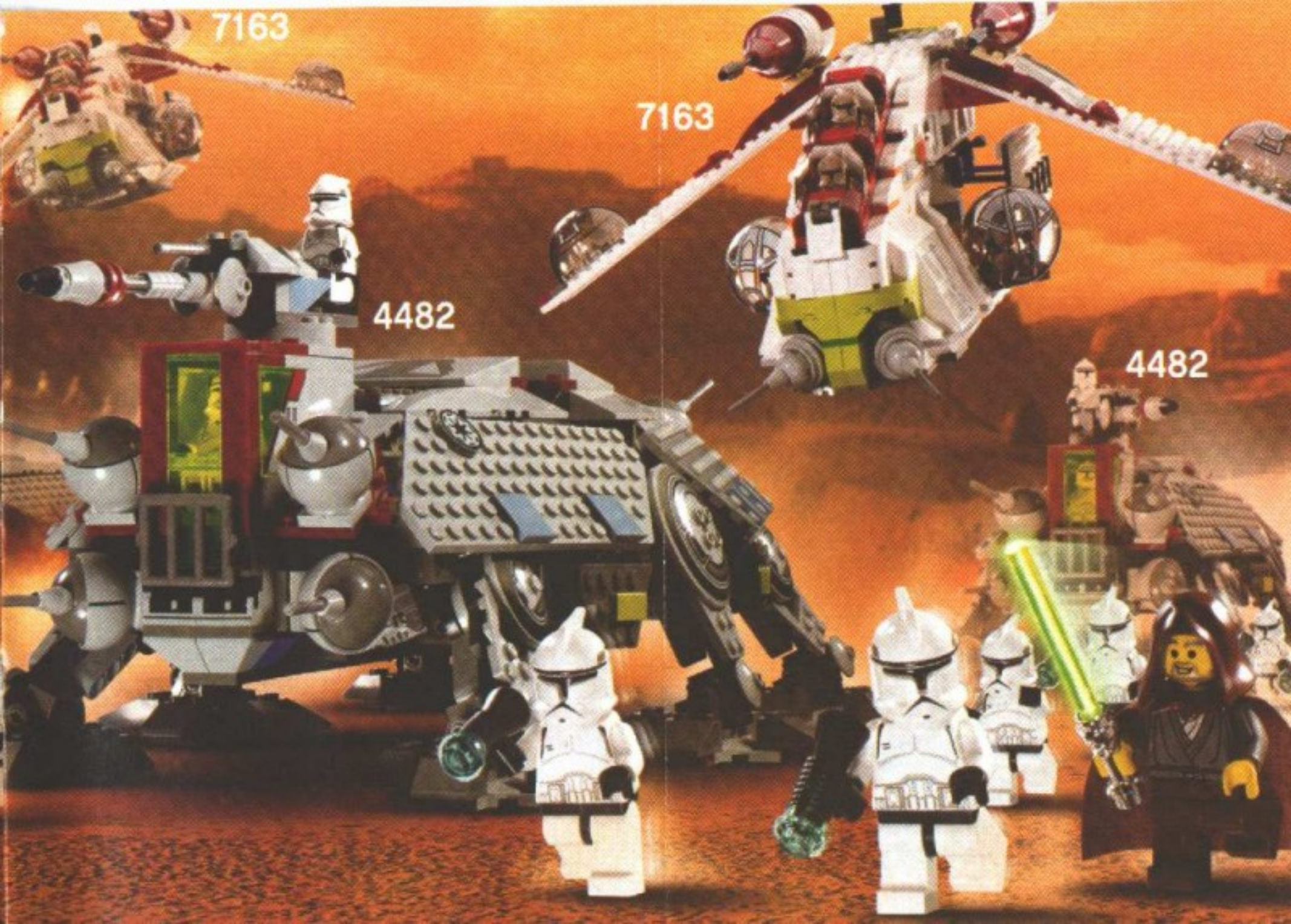

STAR WARS
WWW.STARWARS.COM



www.LEGO.com

LEGO, the LEGO logo and the minifigure are trademarks of the LEGO Group.
©2003 The LEGO Group.

© 2003 Lucasfilm Ltd. & TM/MC. All rights reserved. Used under authorization.

