

7727

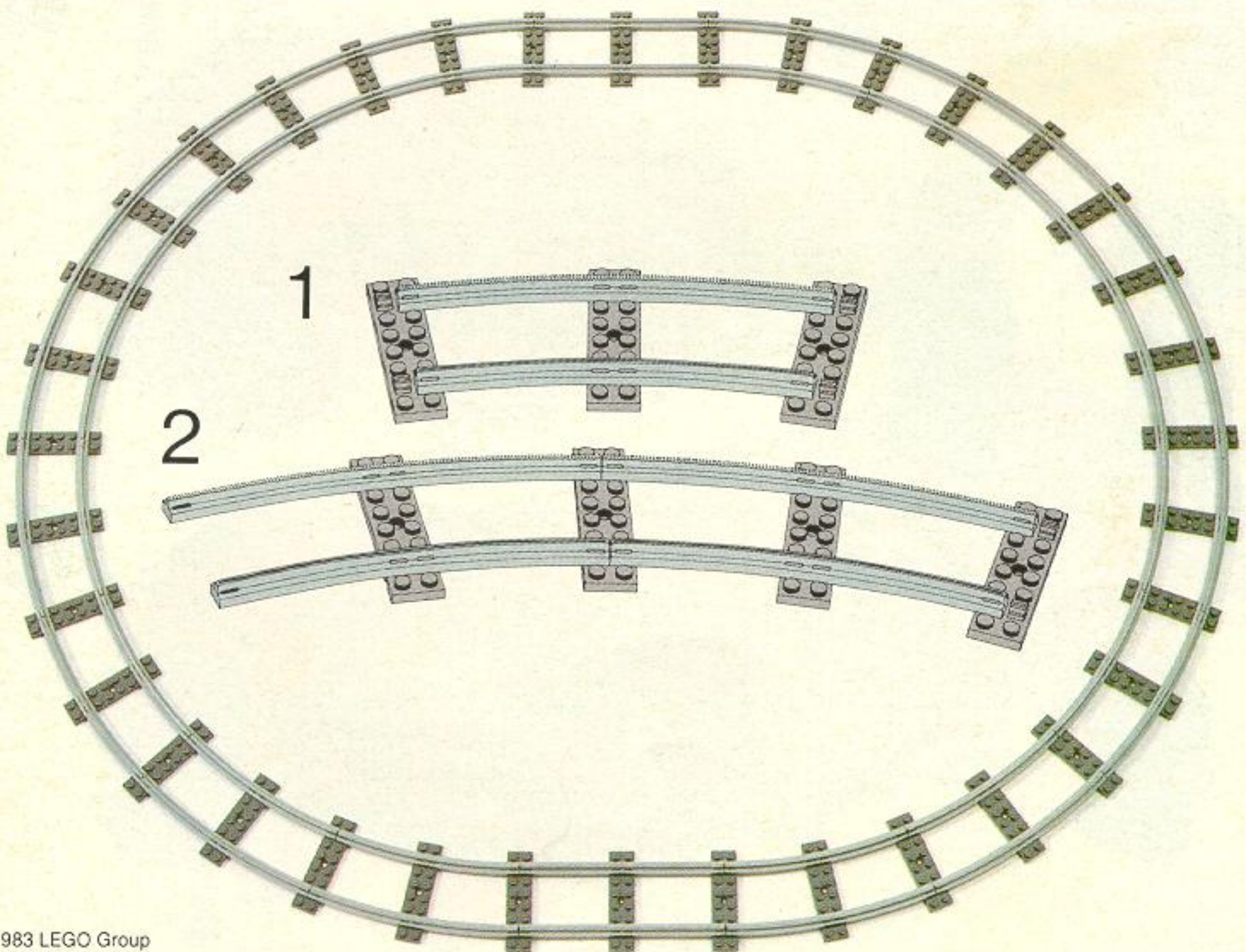

120282

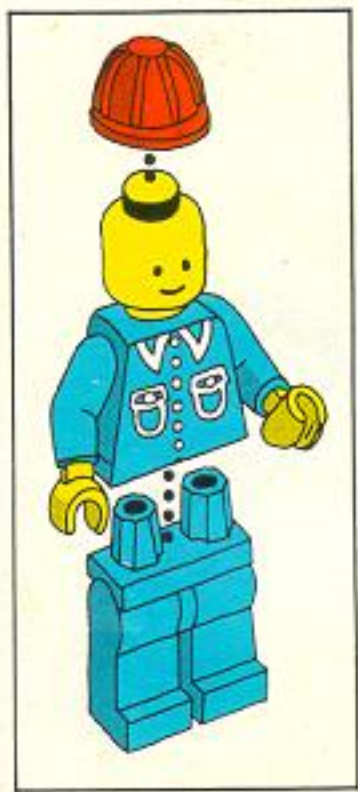

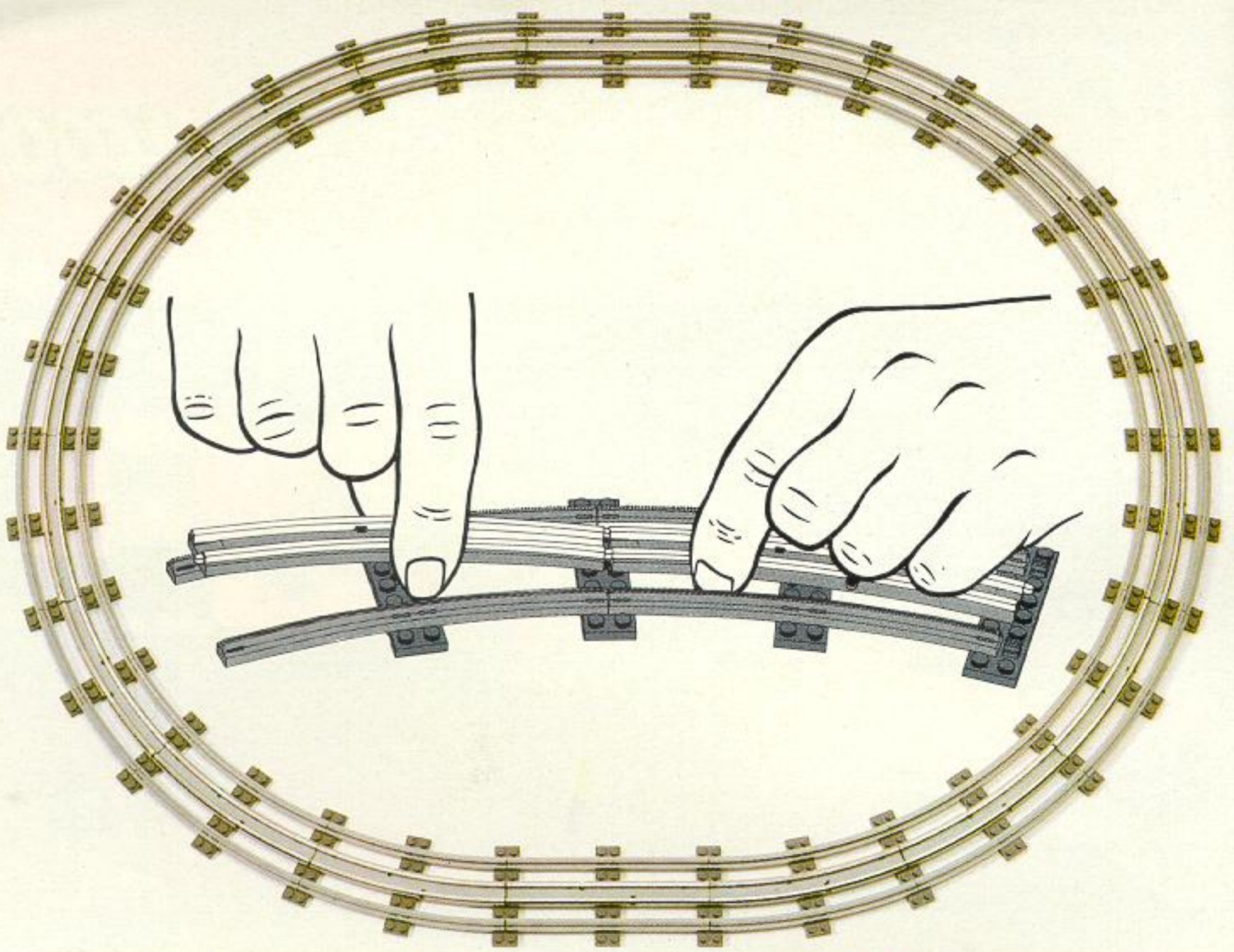

1

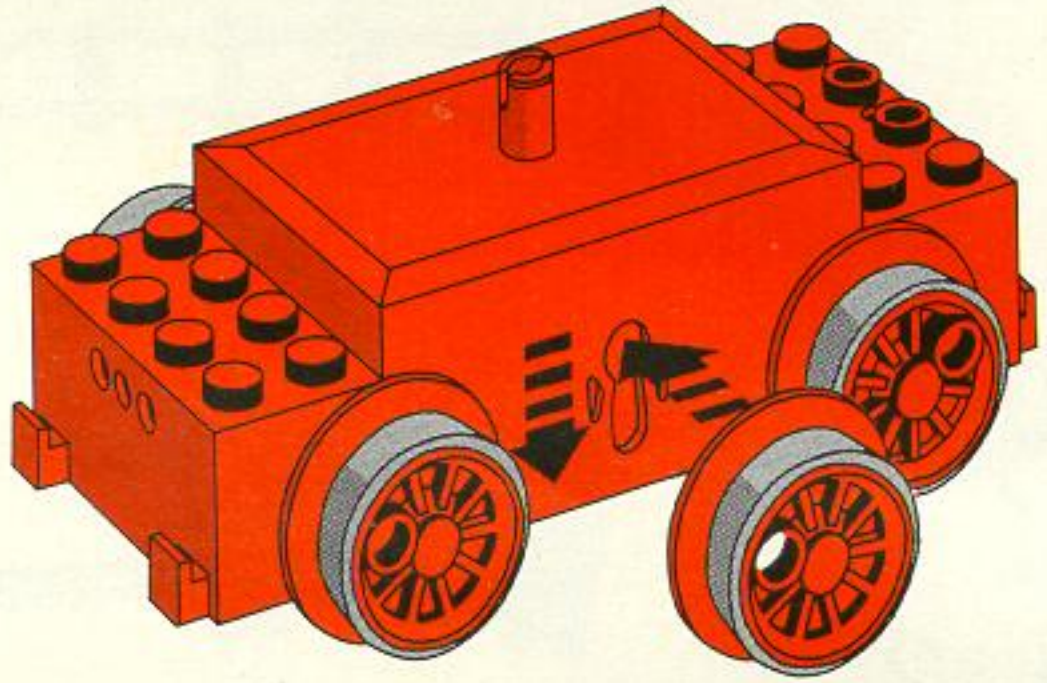

2

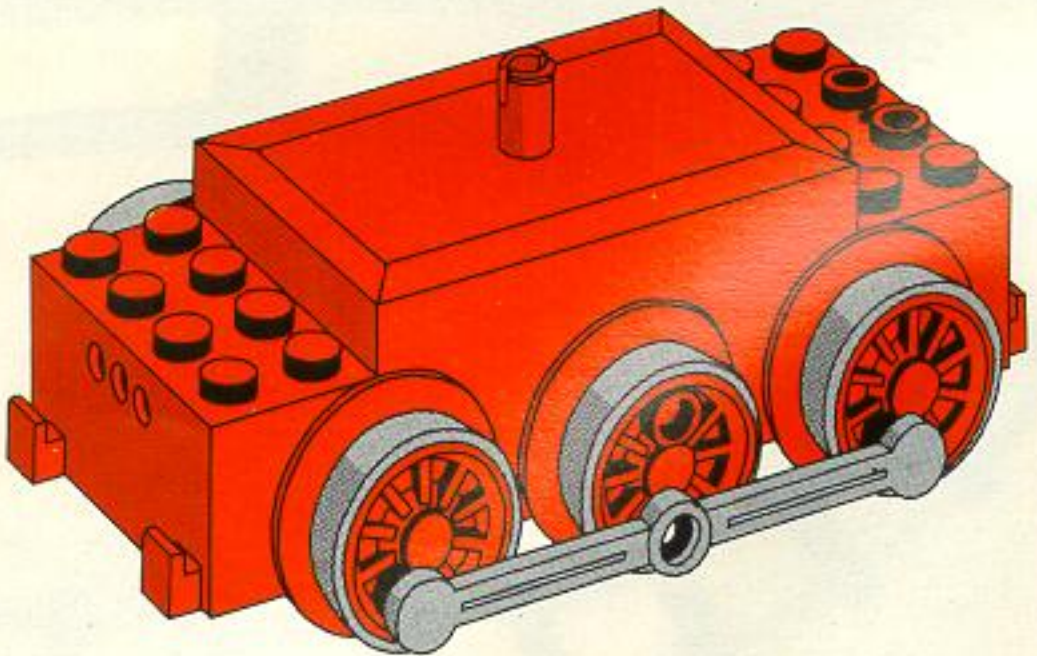

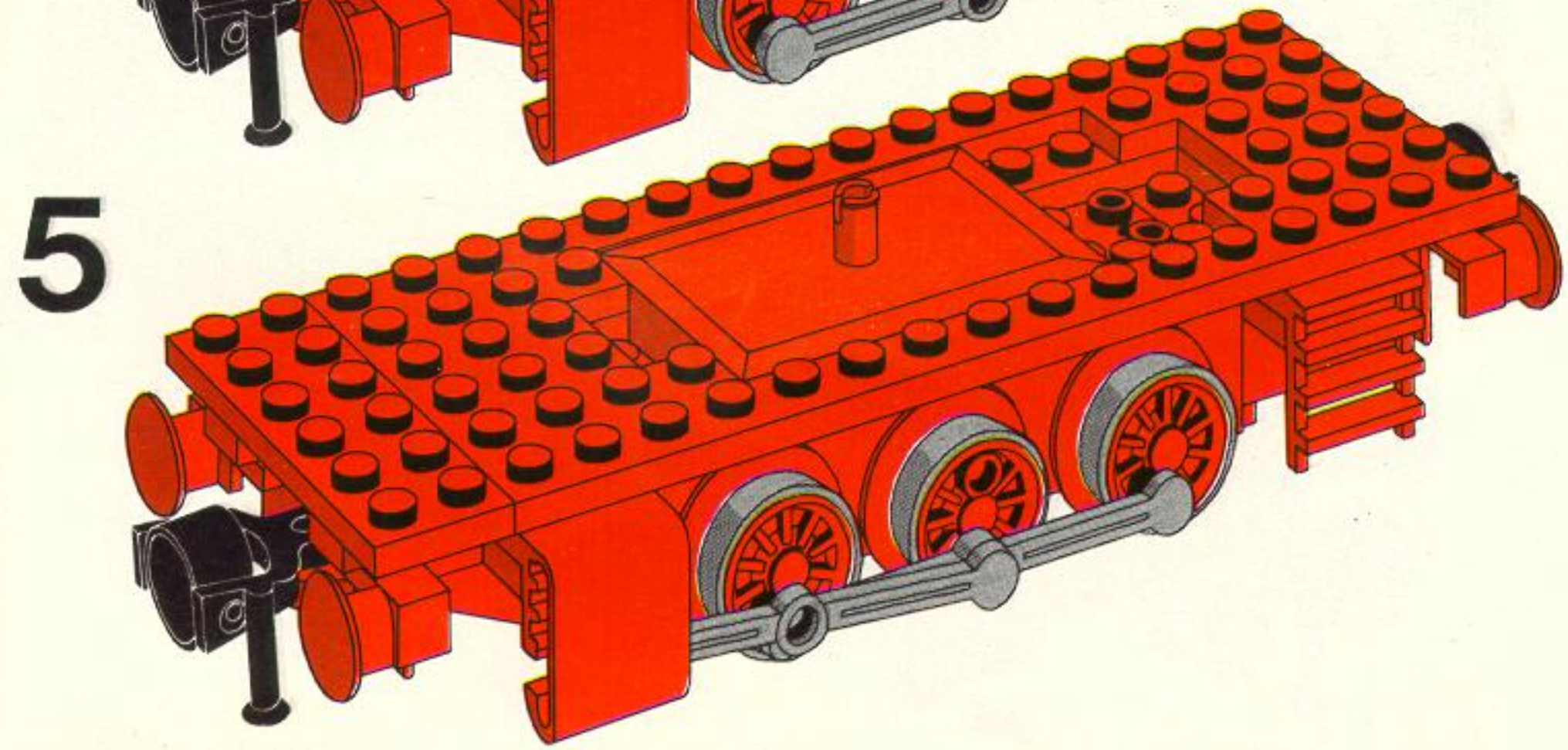
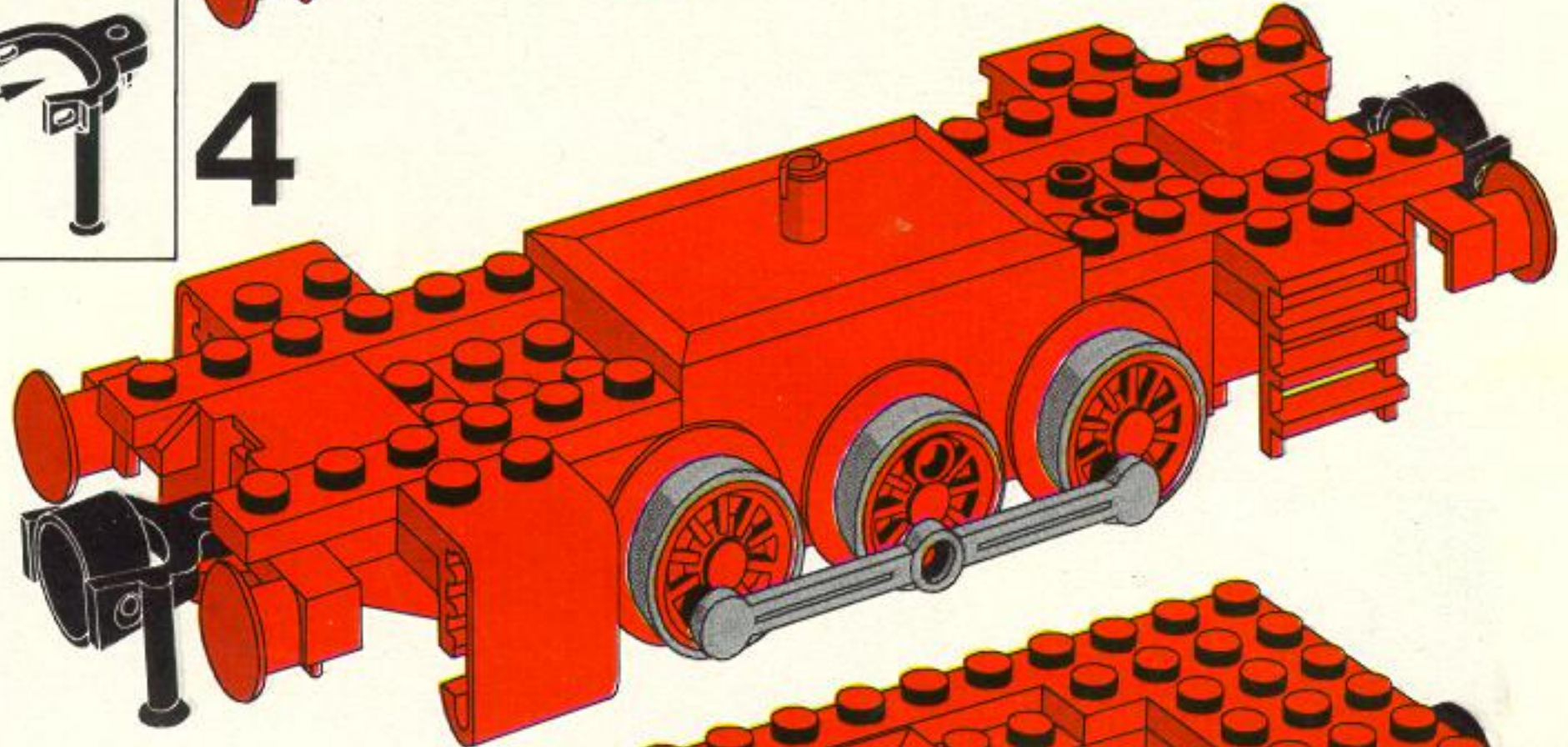
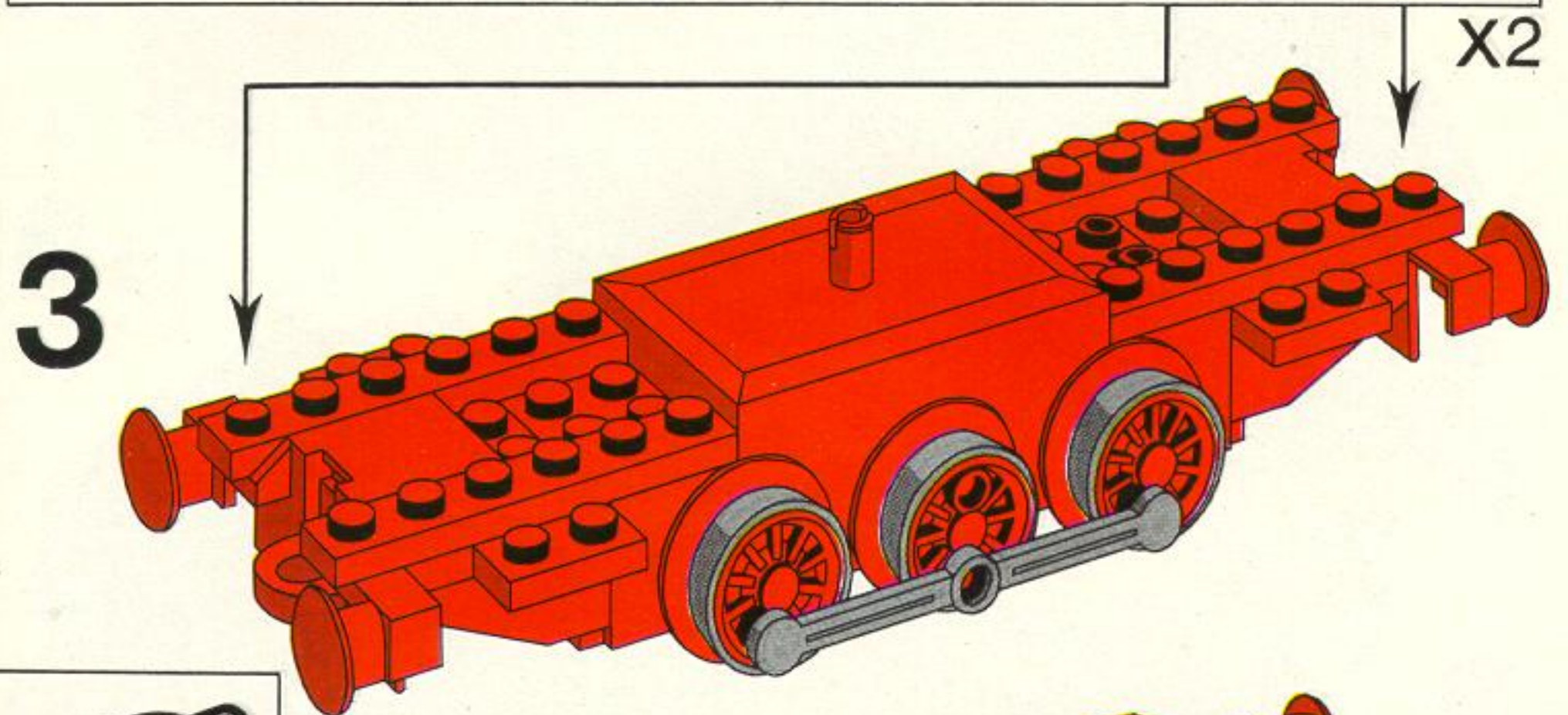
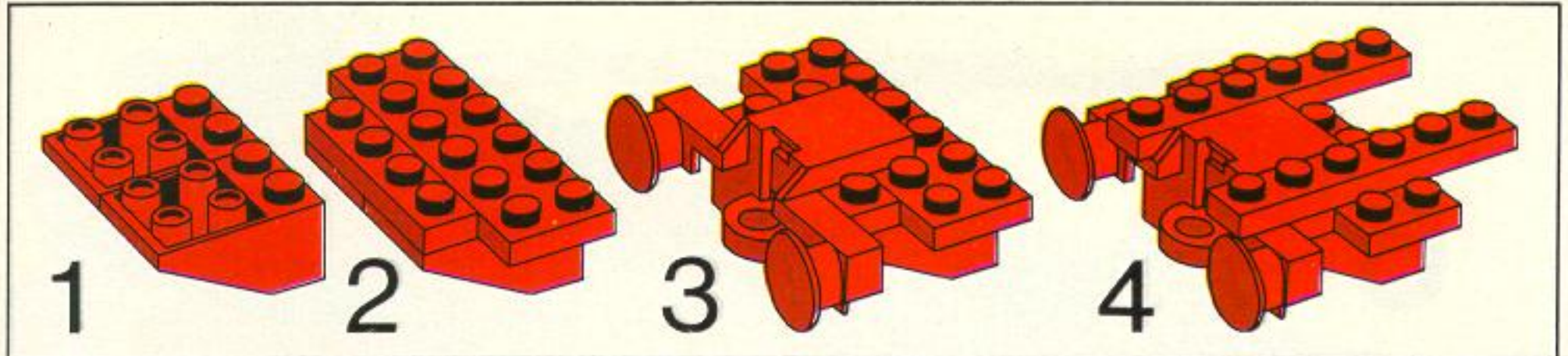

6

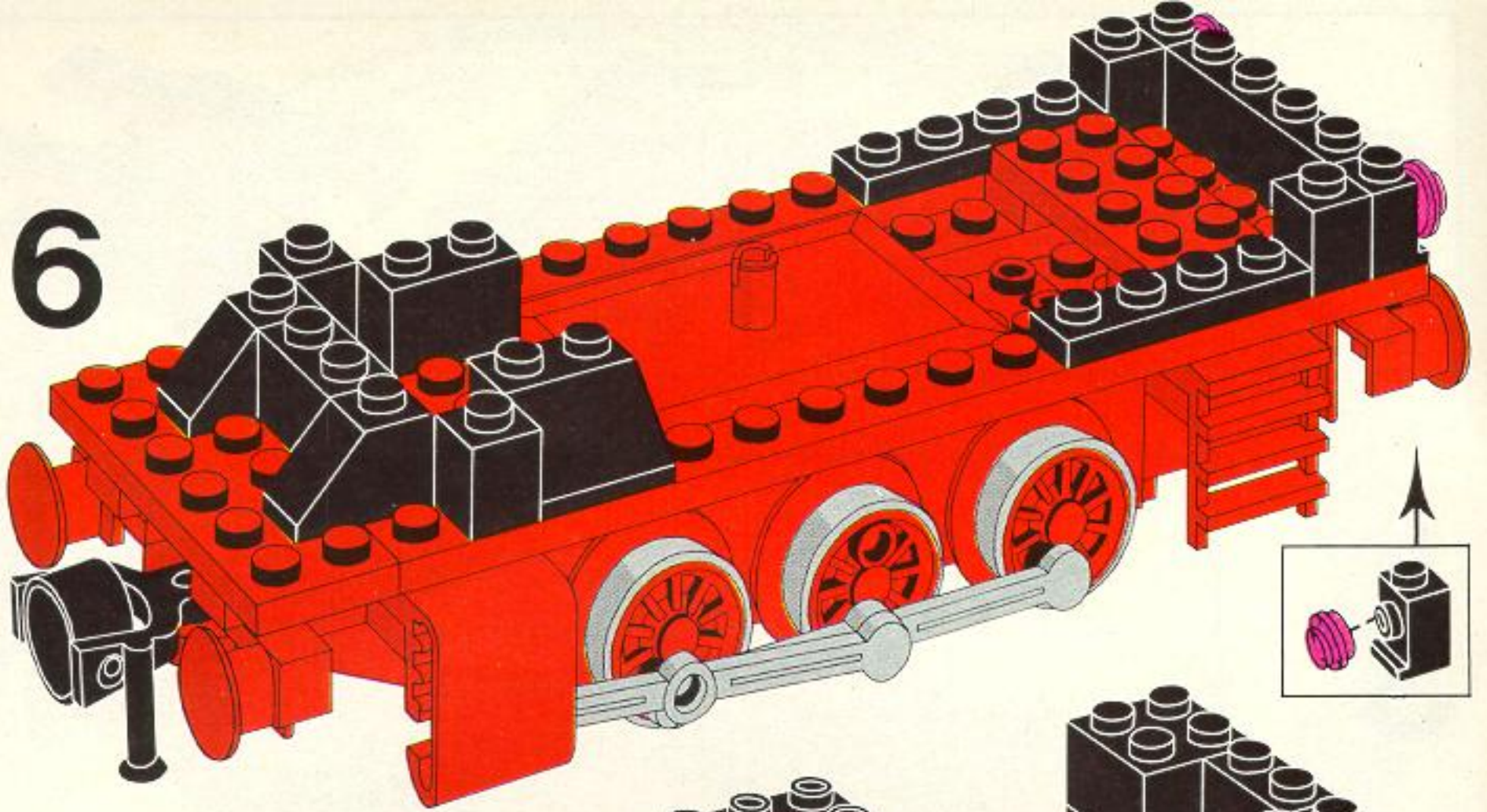

7

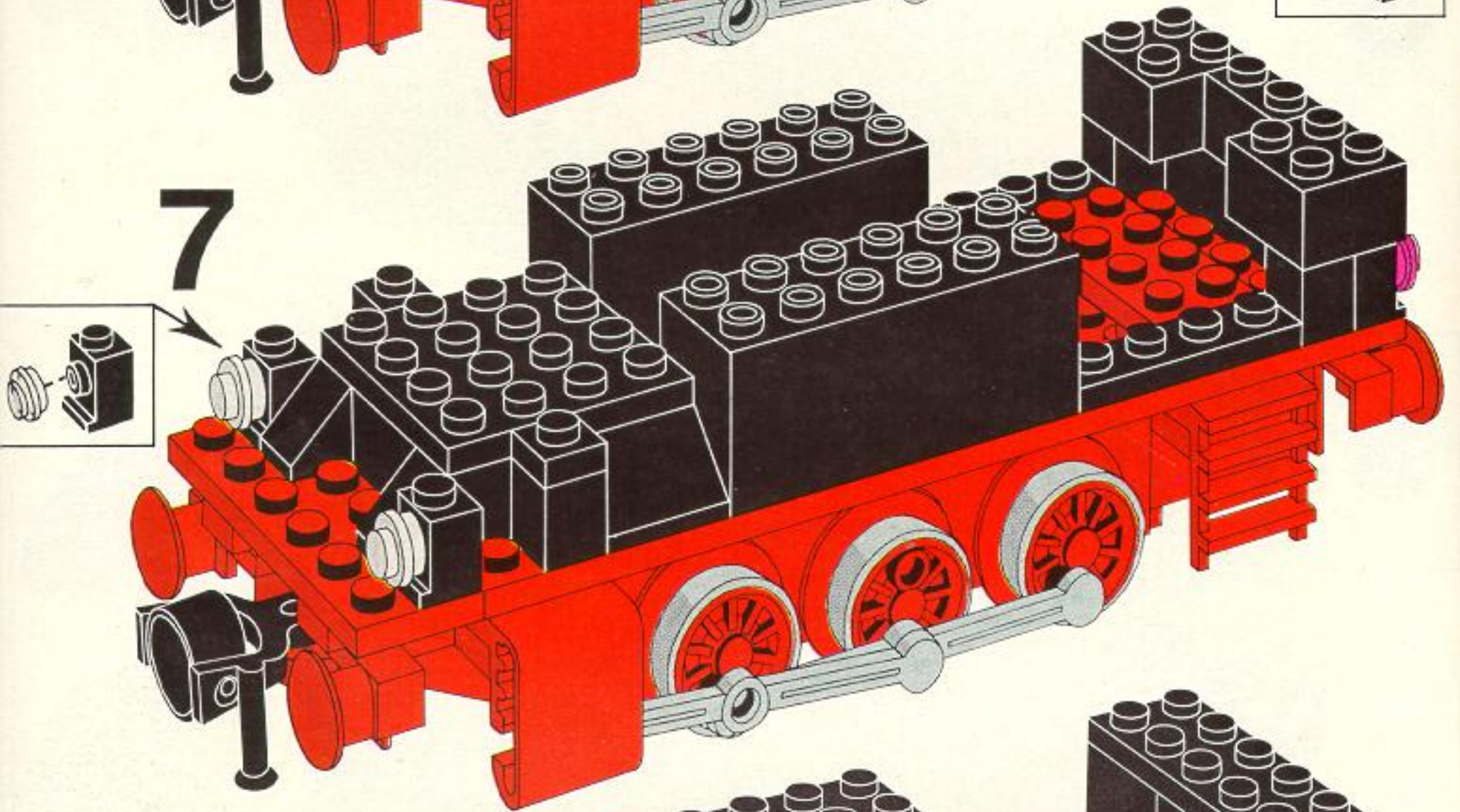

8

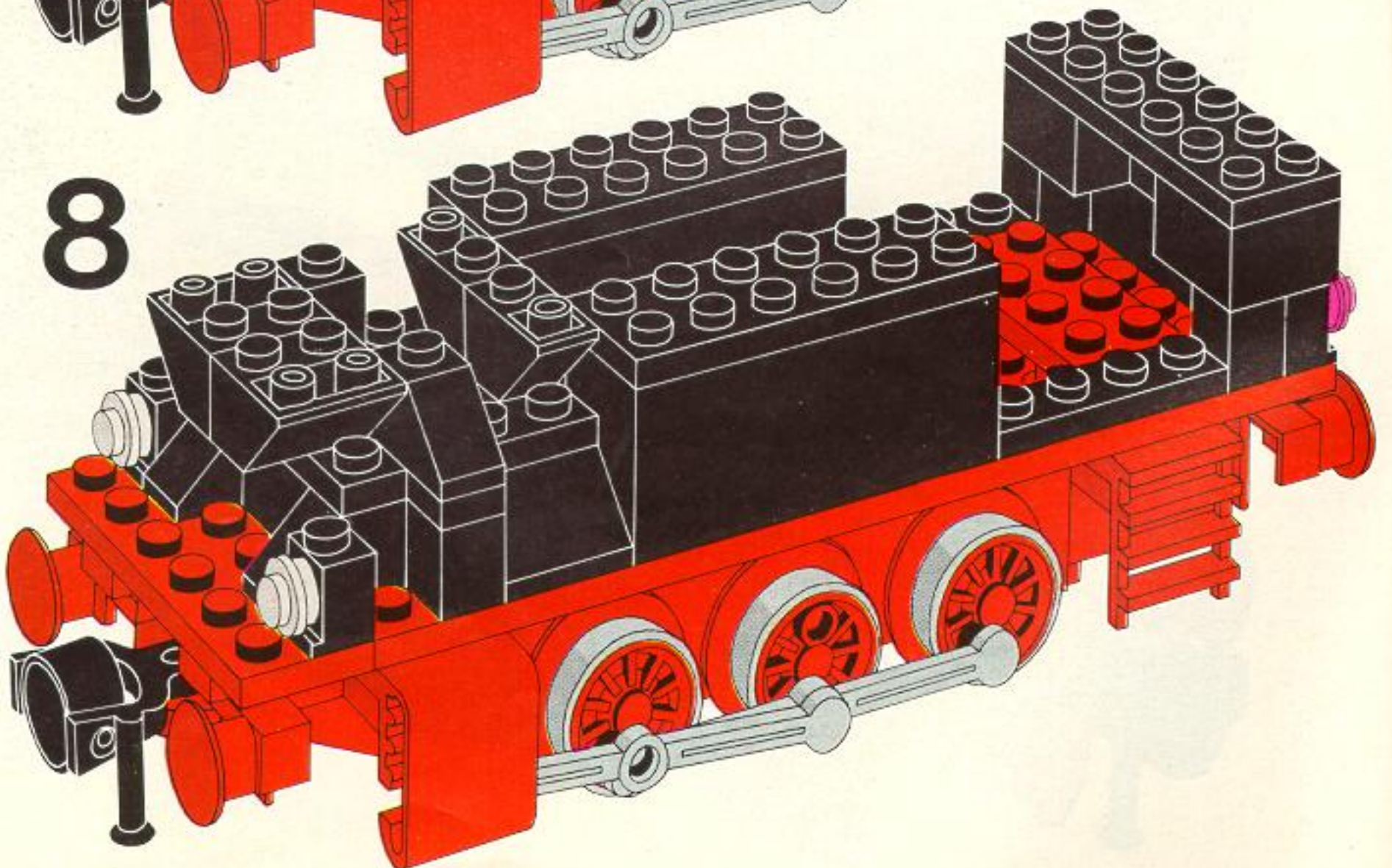

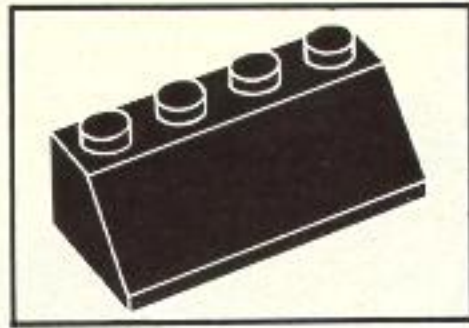
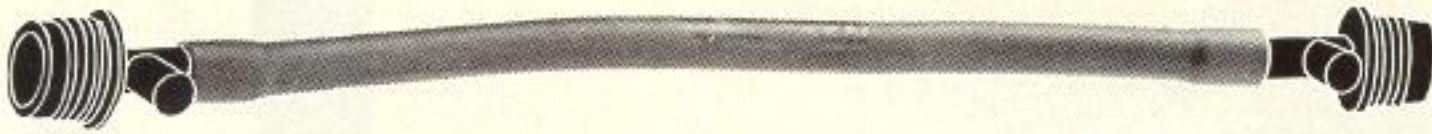

9

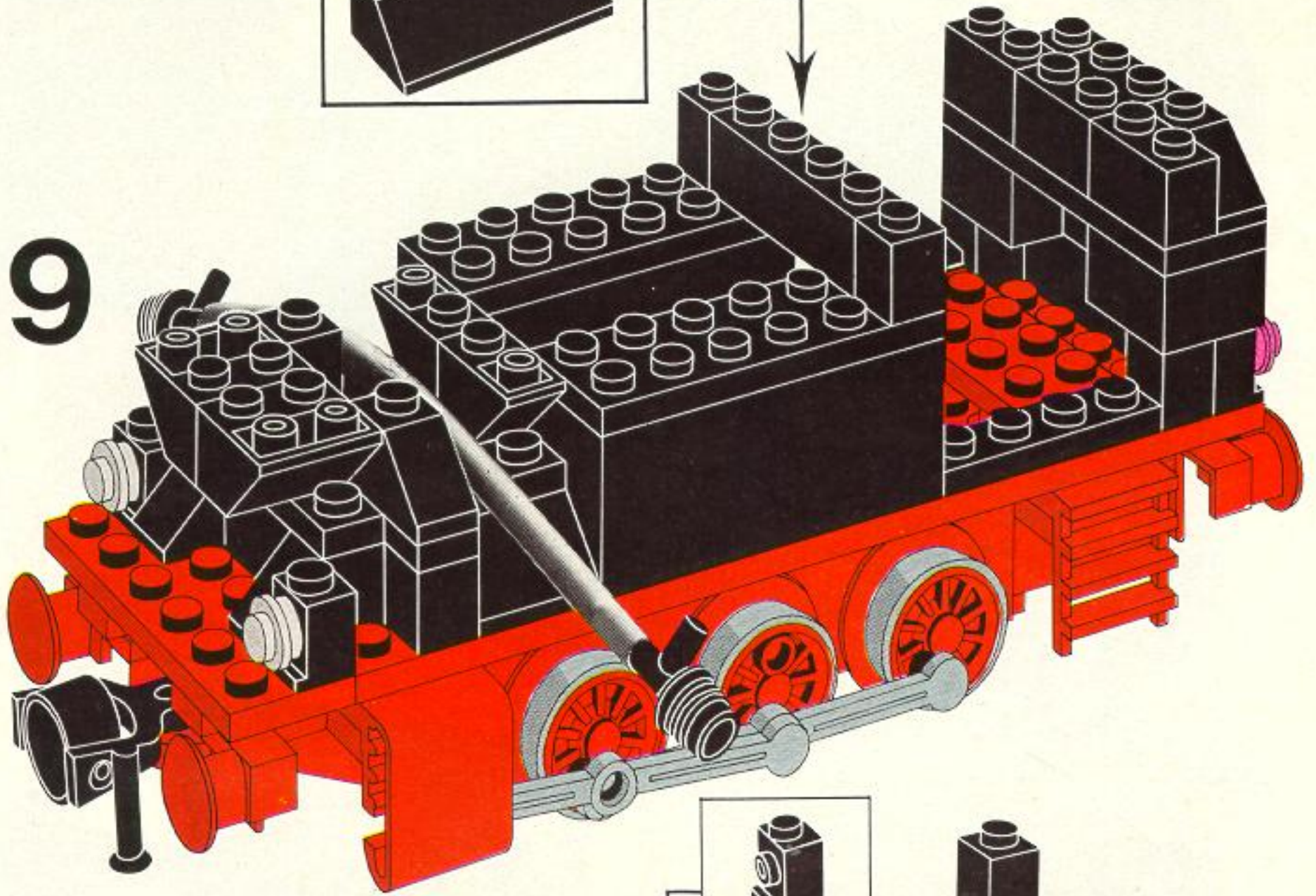

10

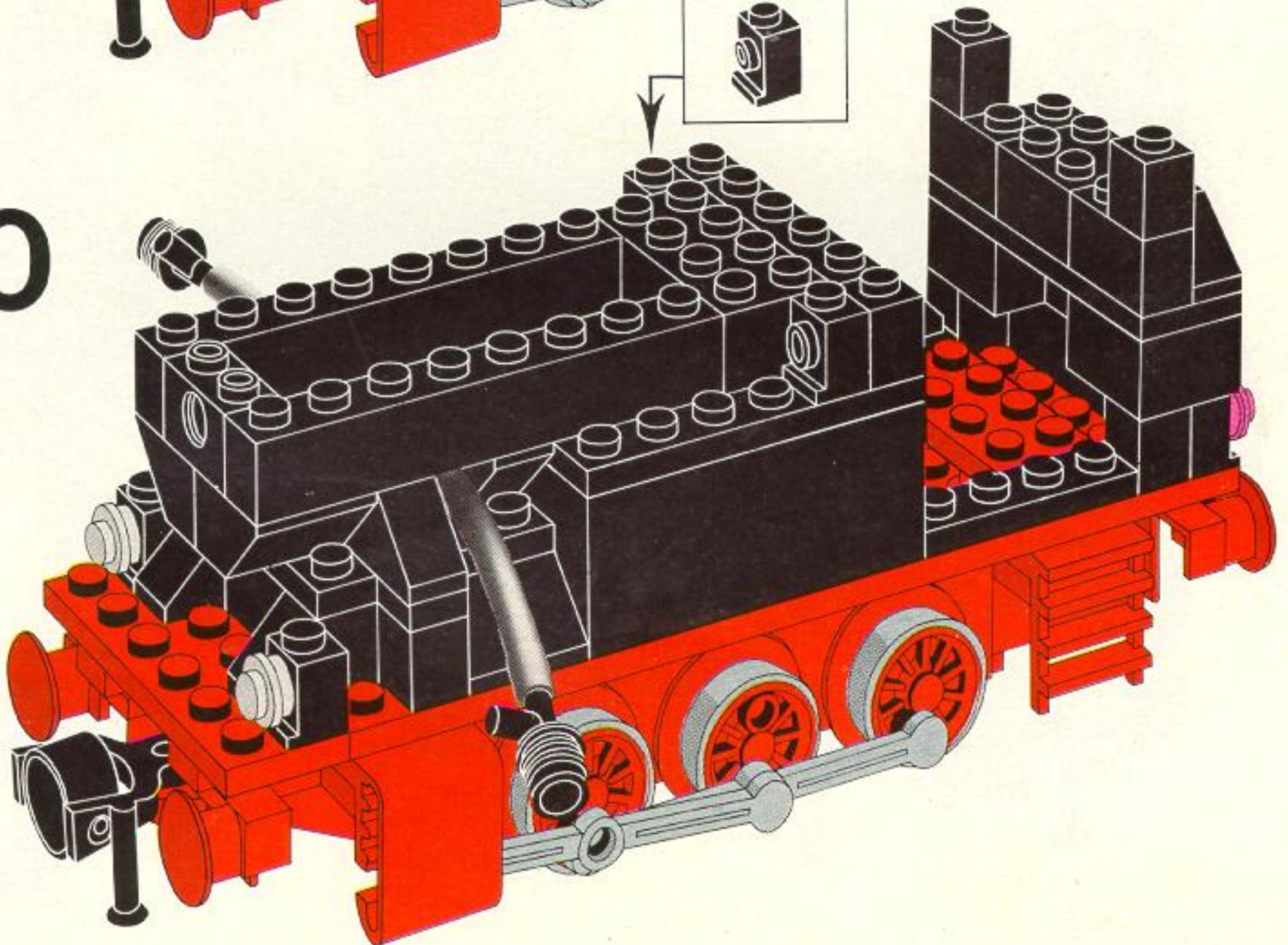

11

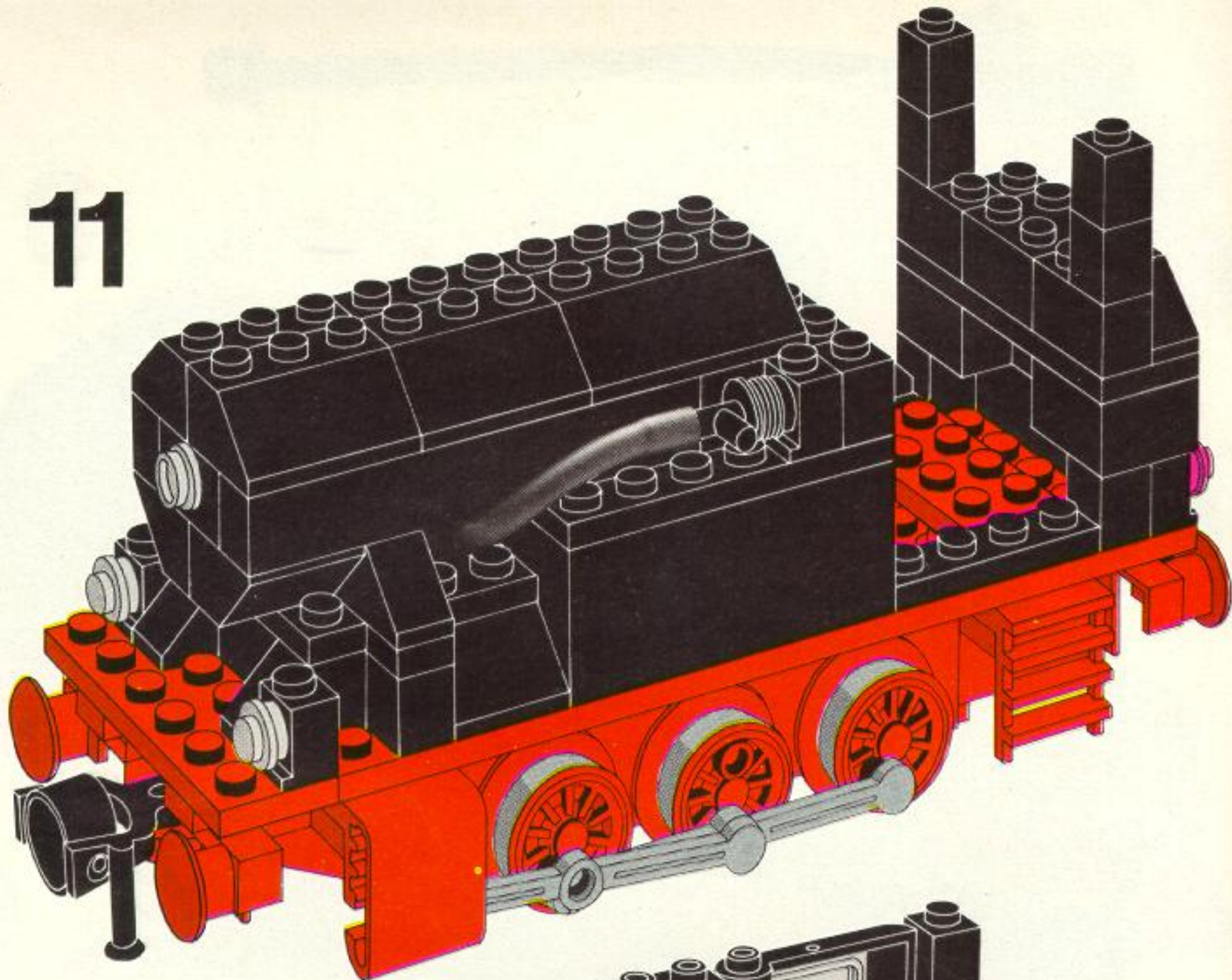

12

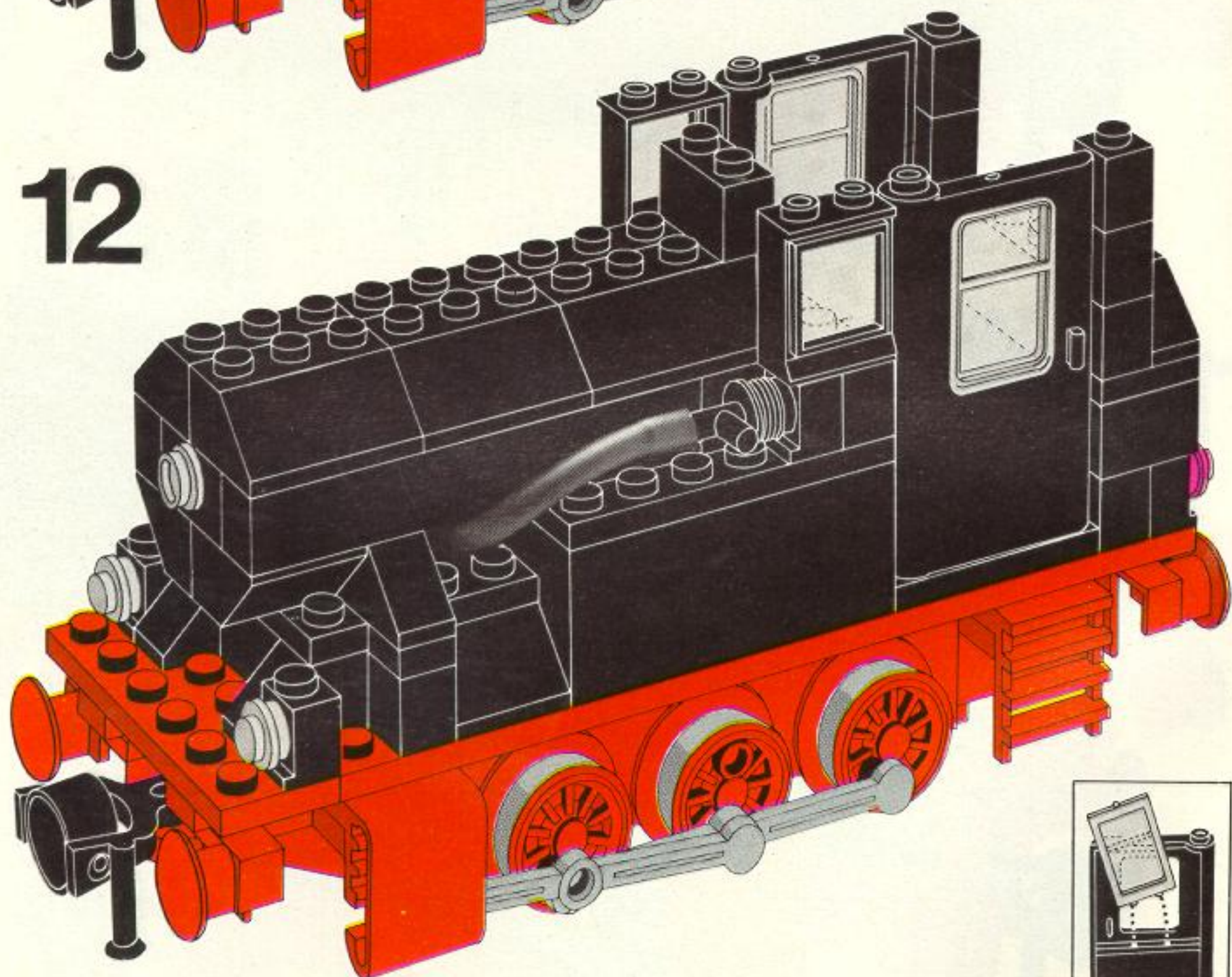

13

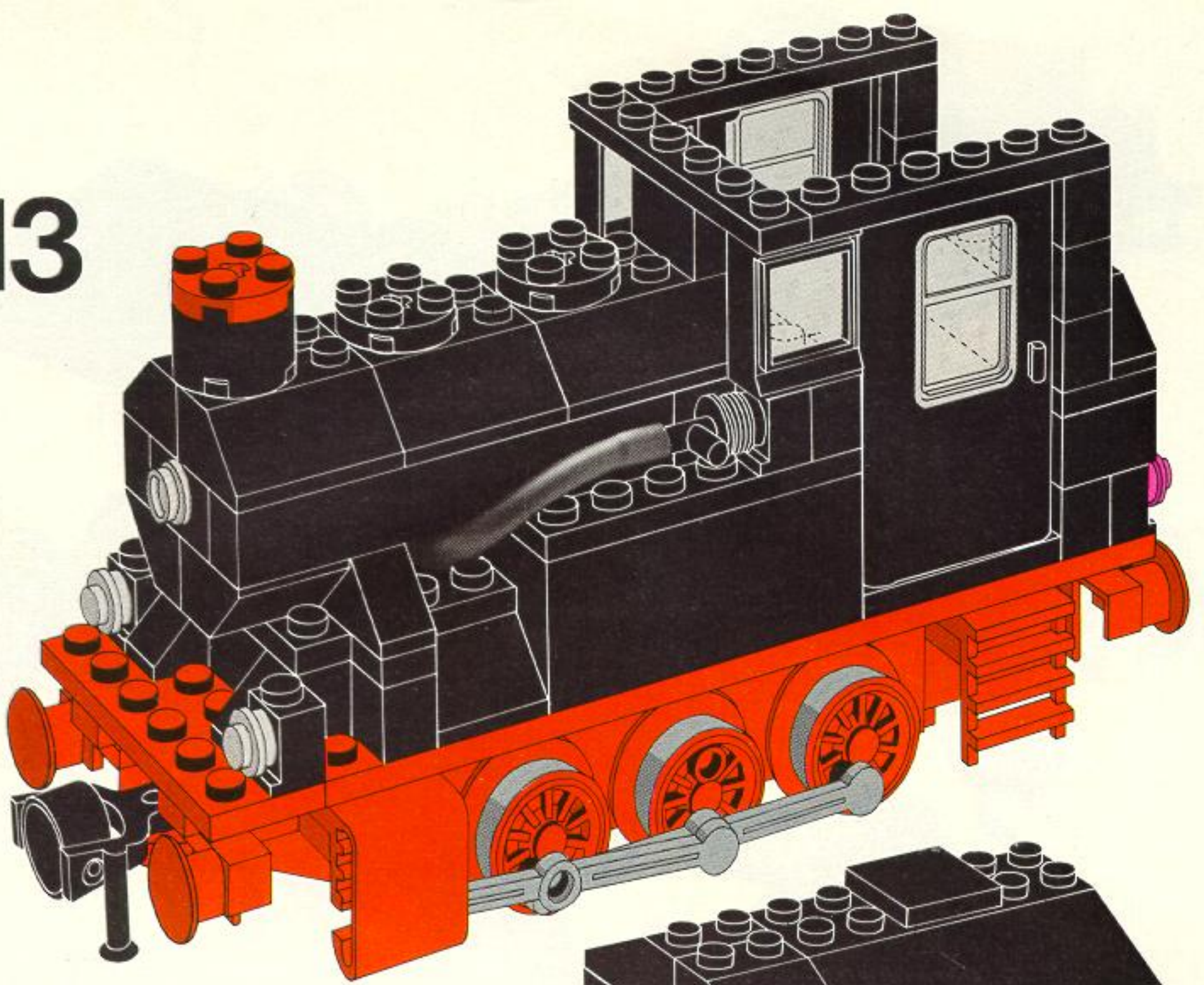

14

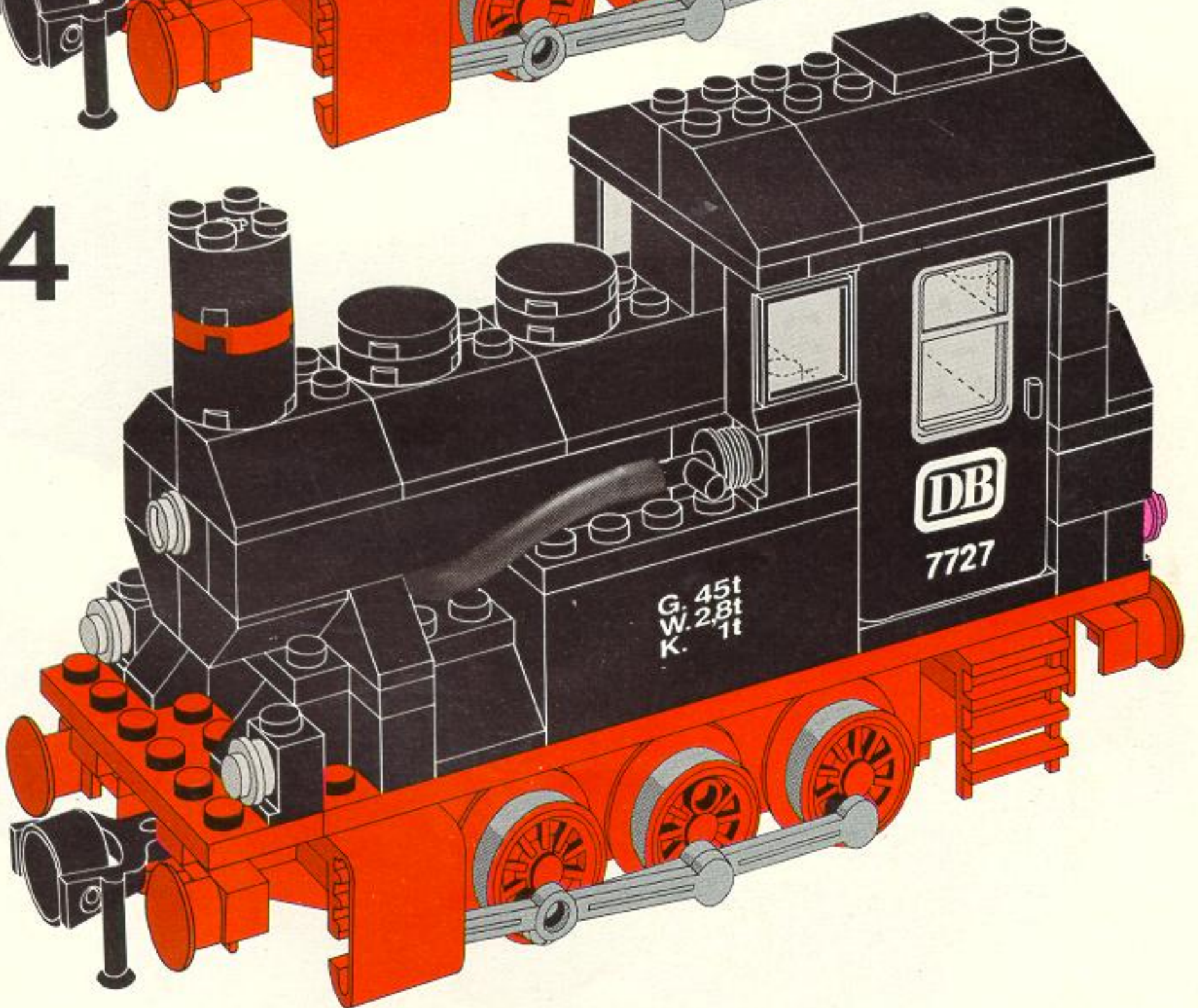

5

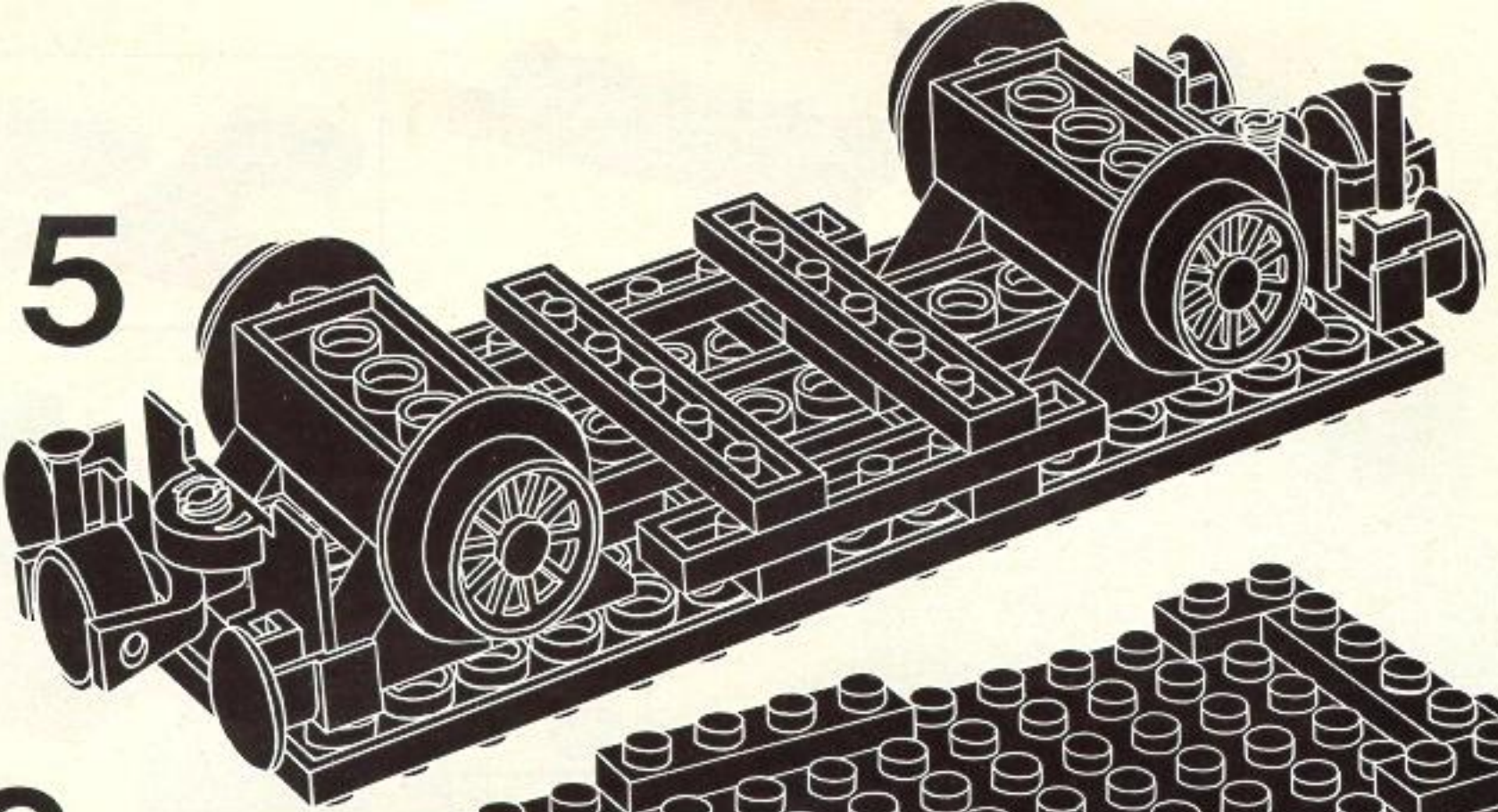

6

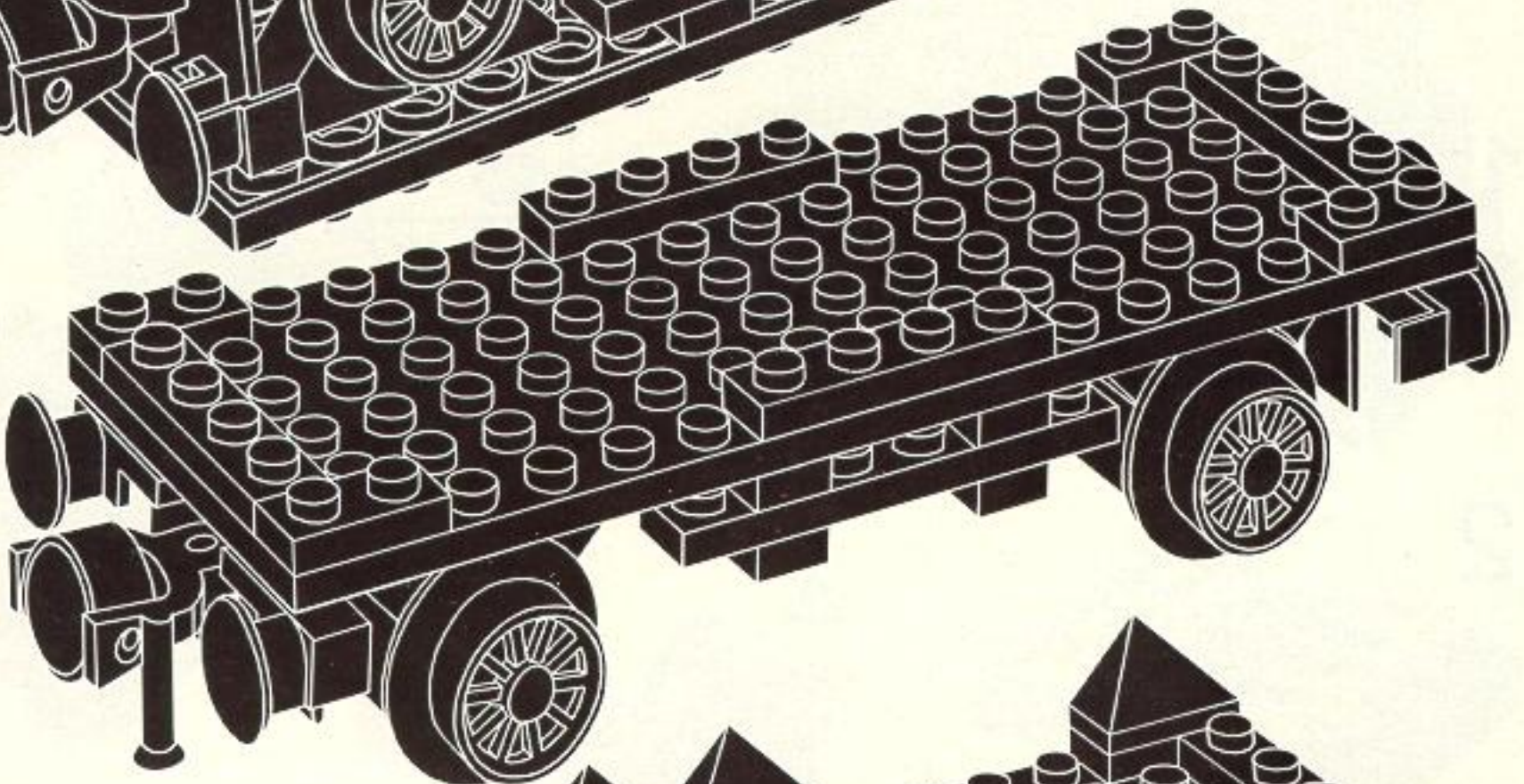

7

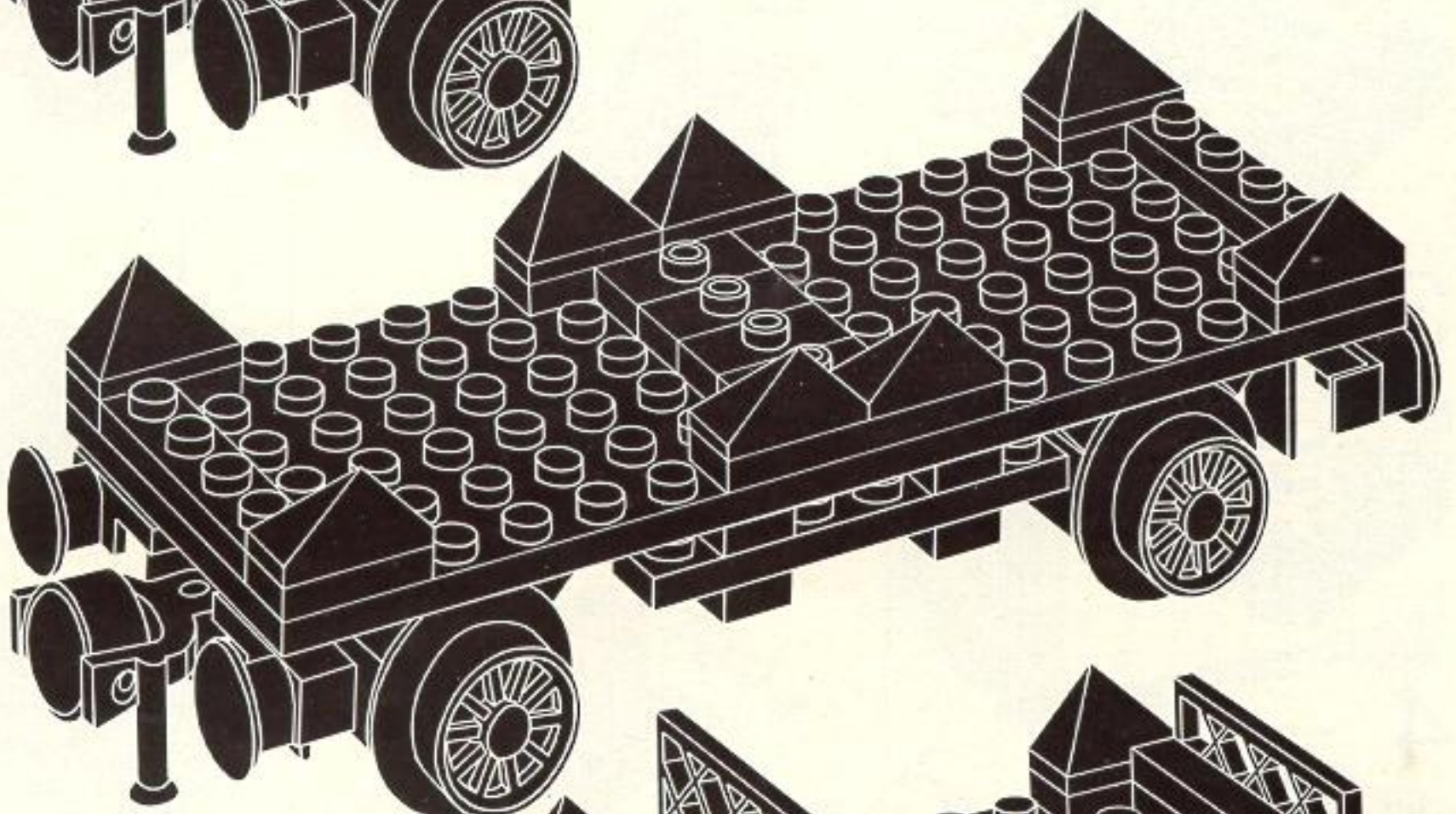

8

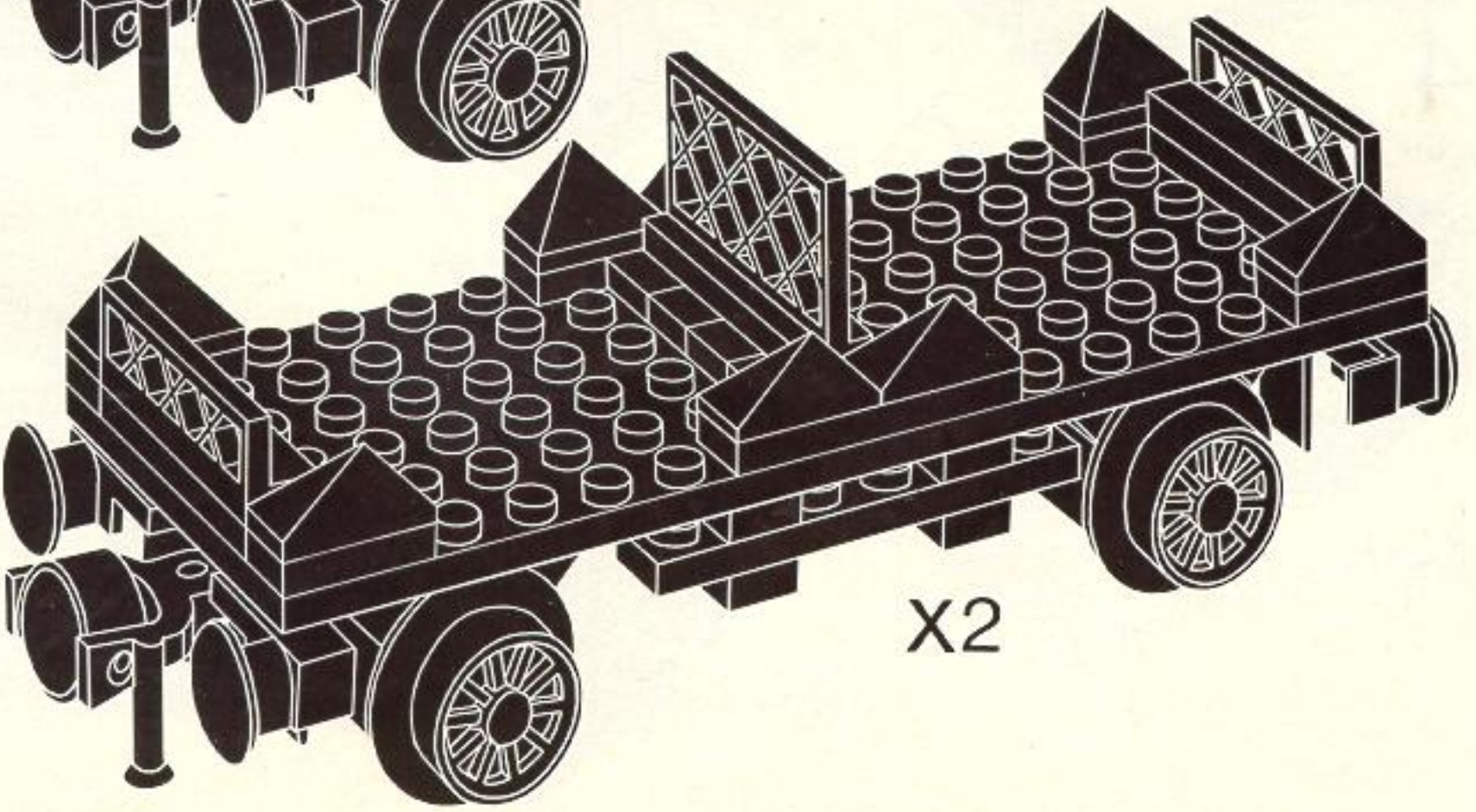

X2

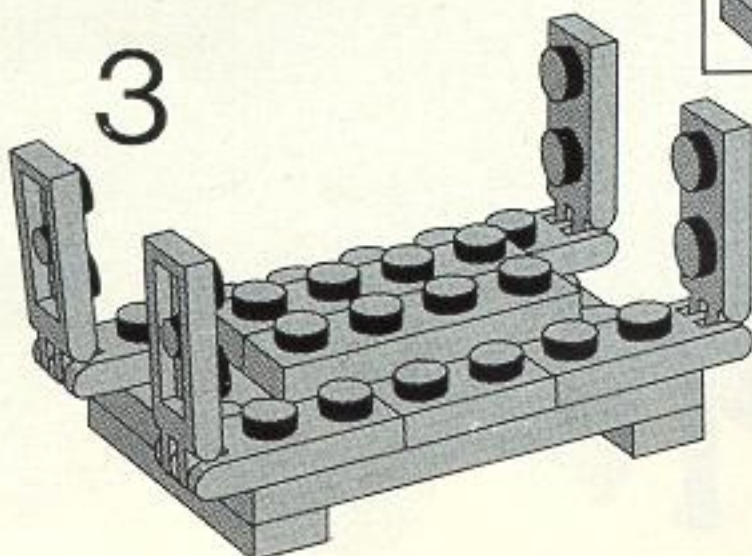
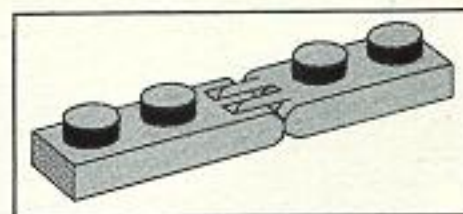
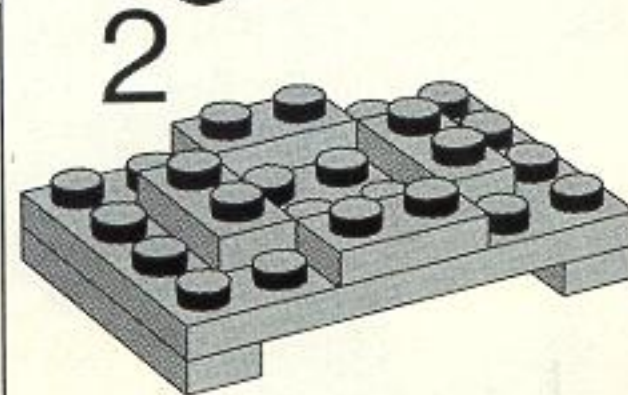
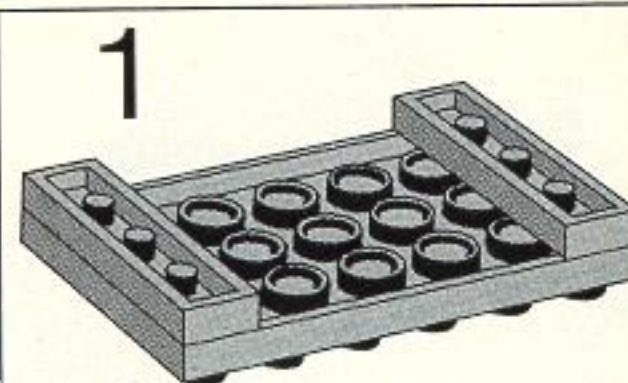
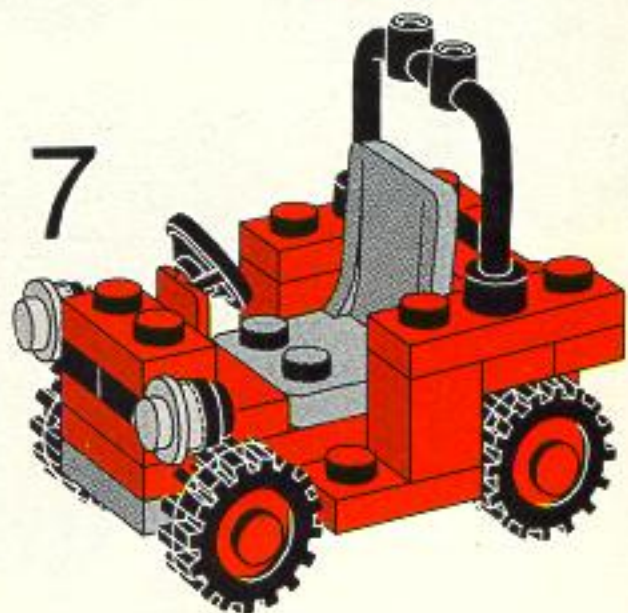
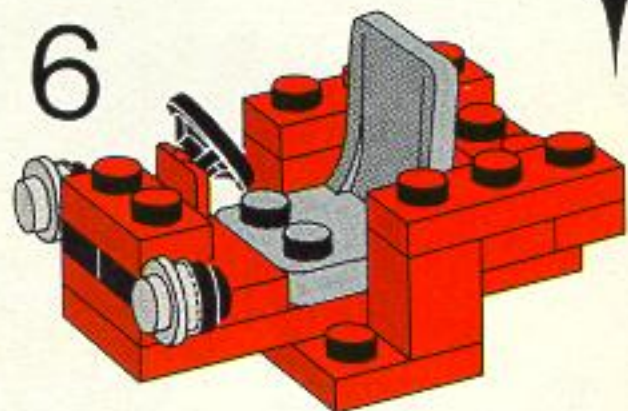
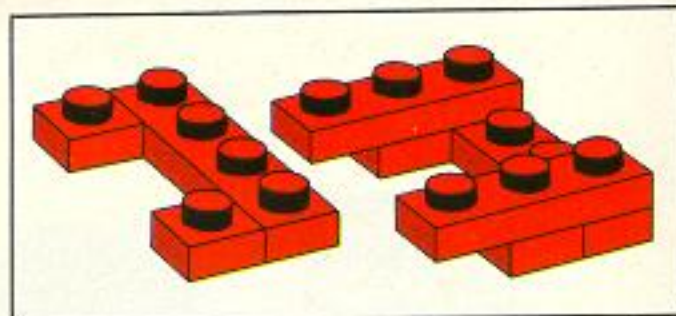
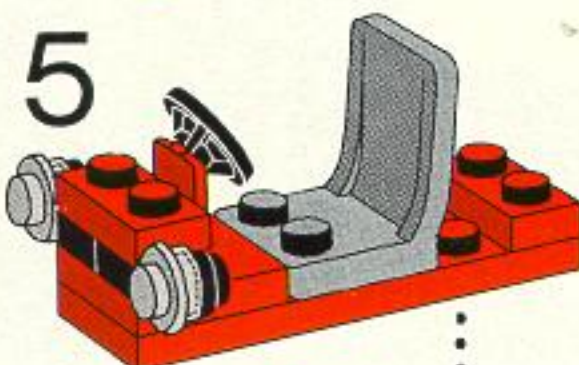
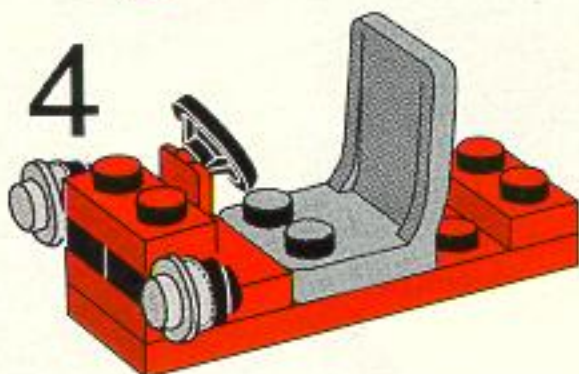
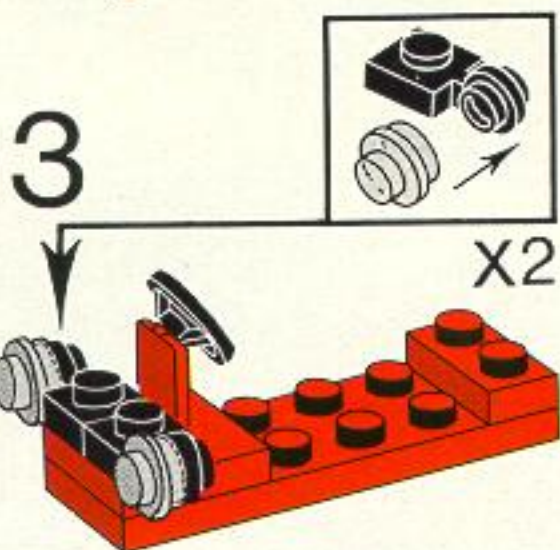
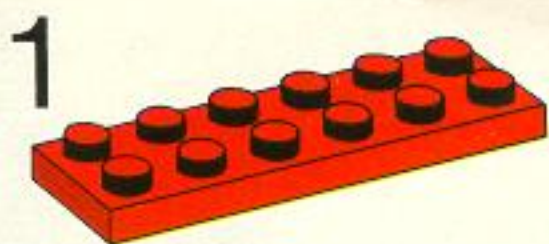
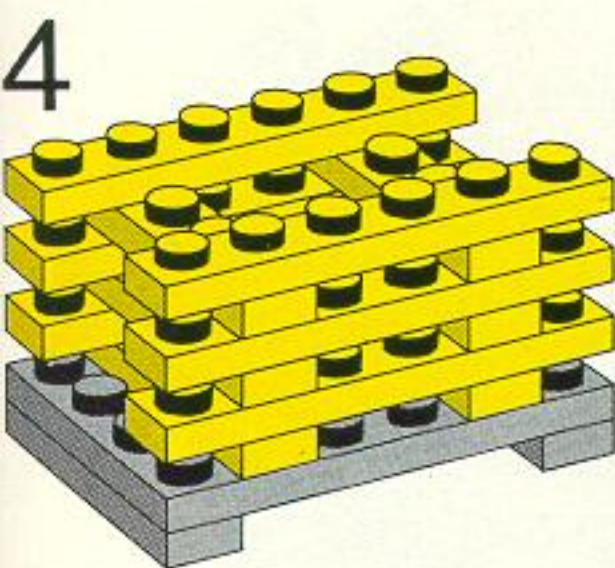
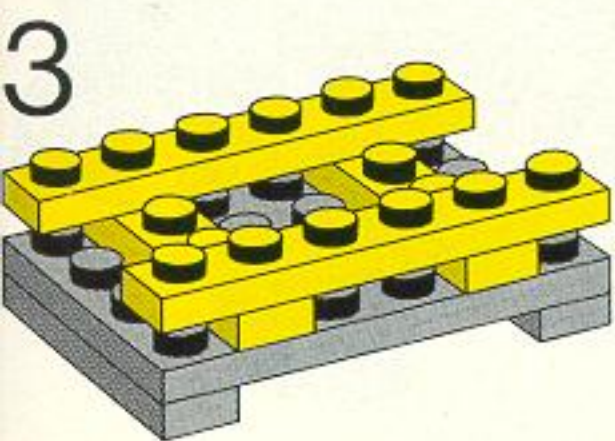
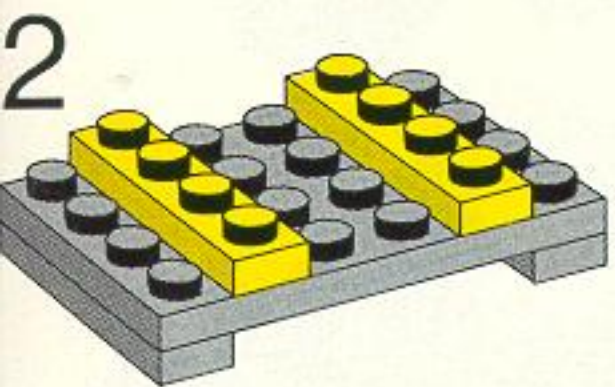
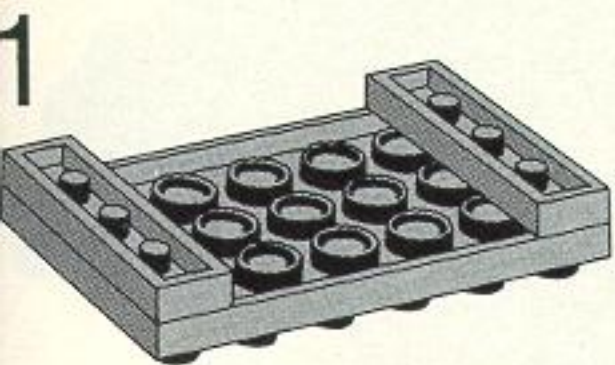

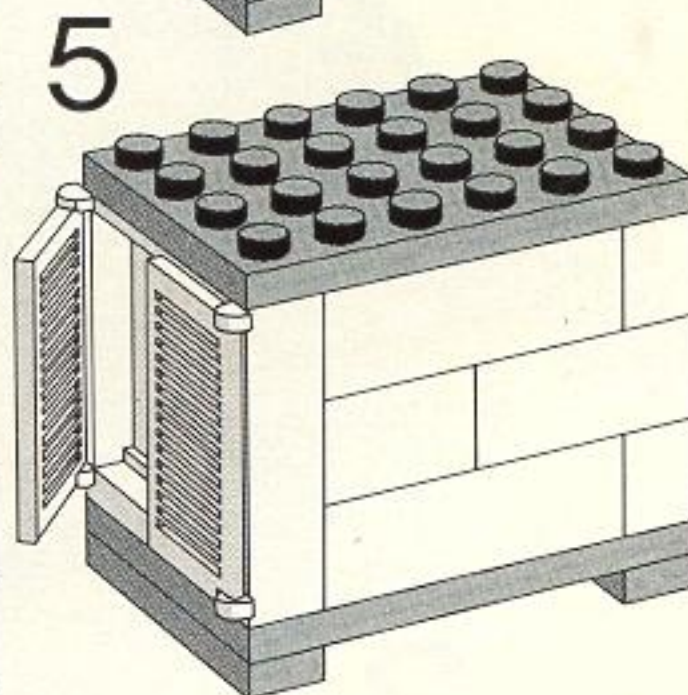
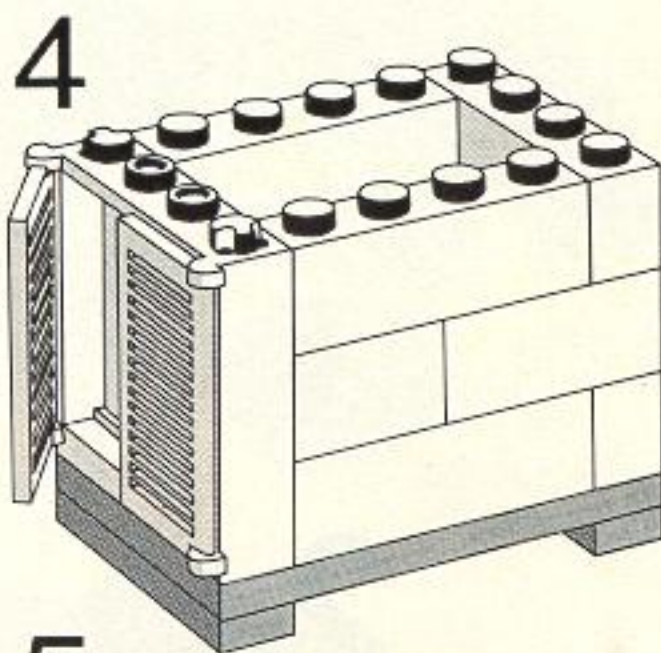
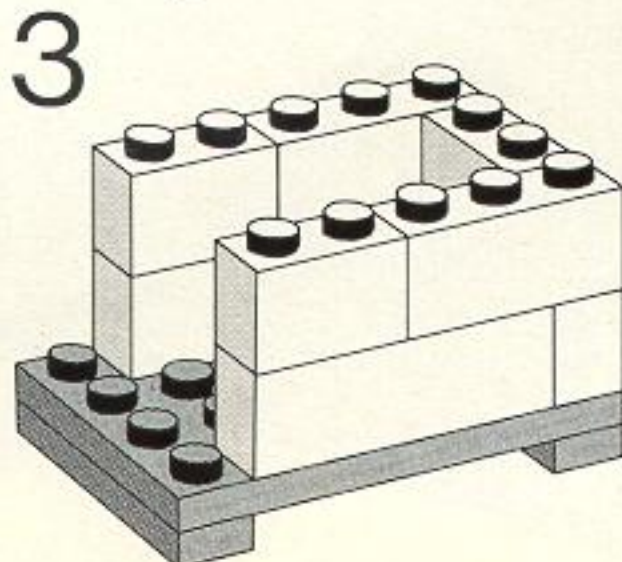
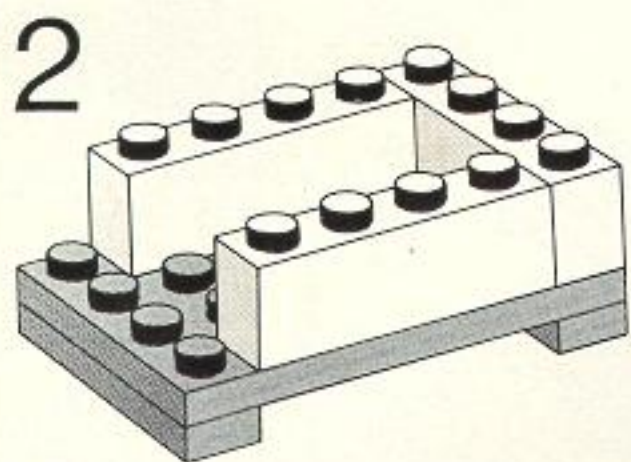
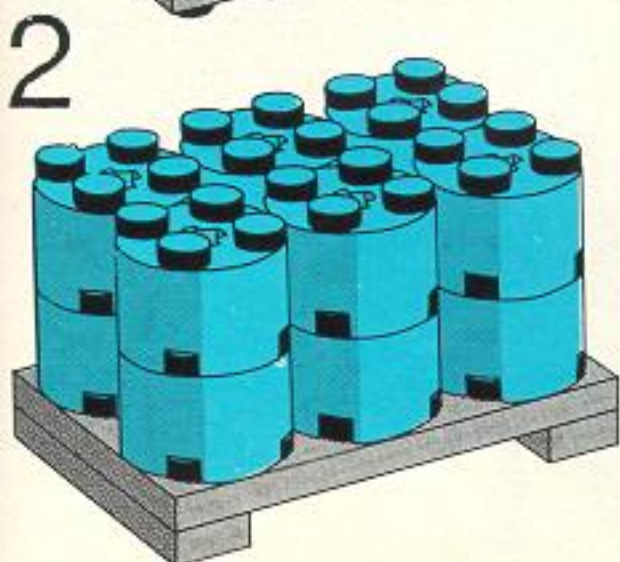
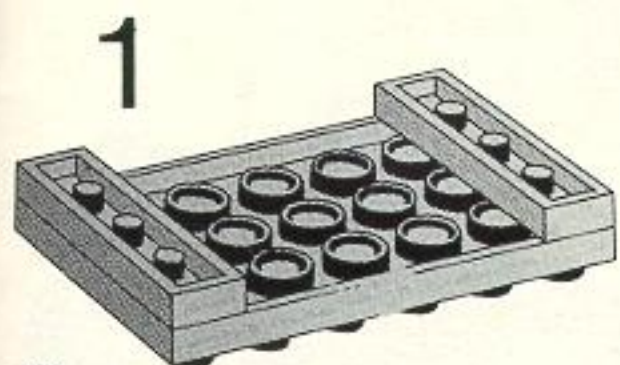
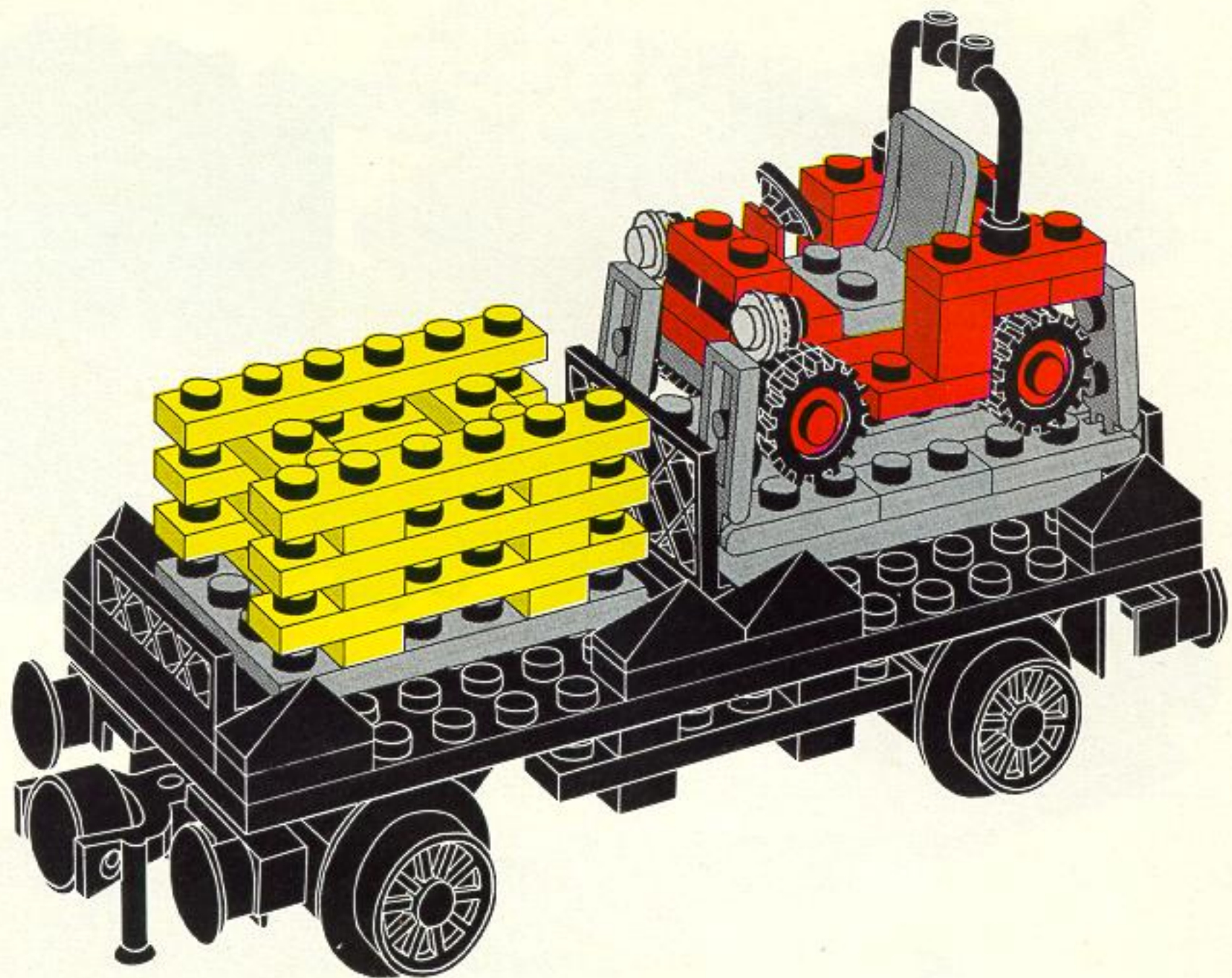

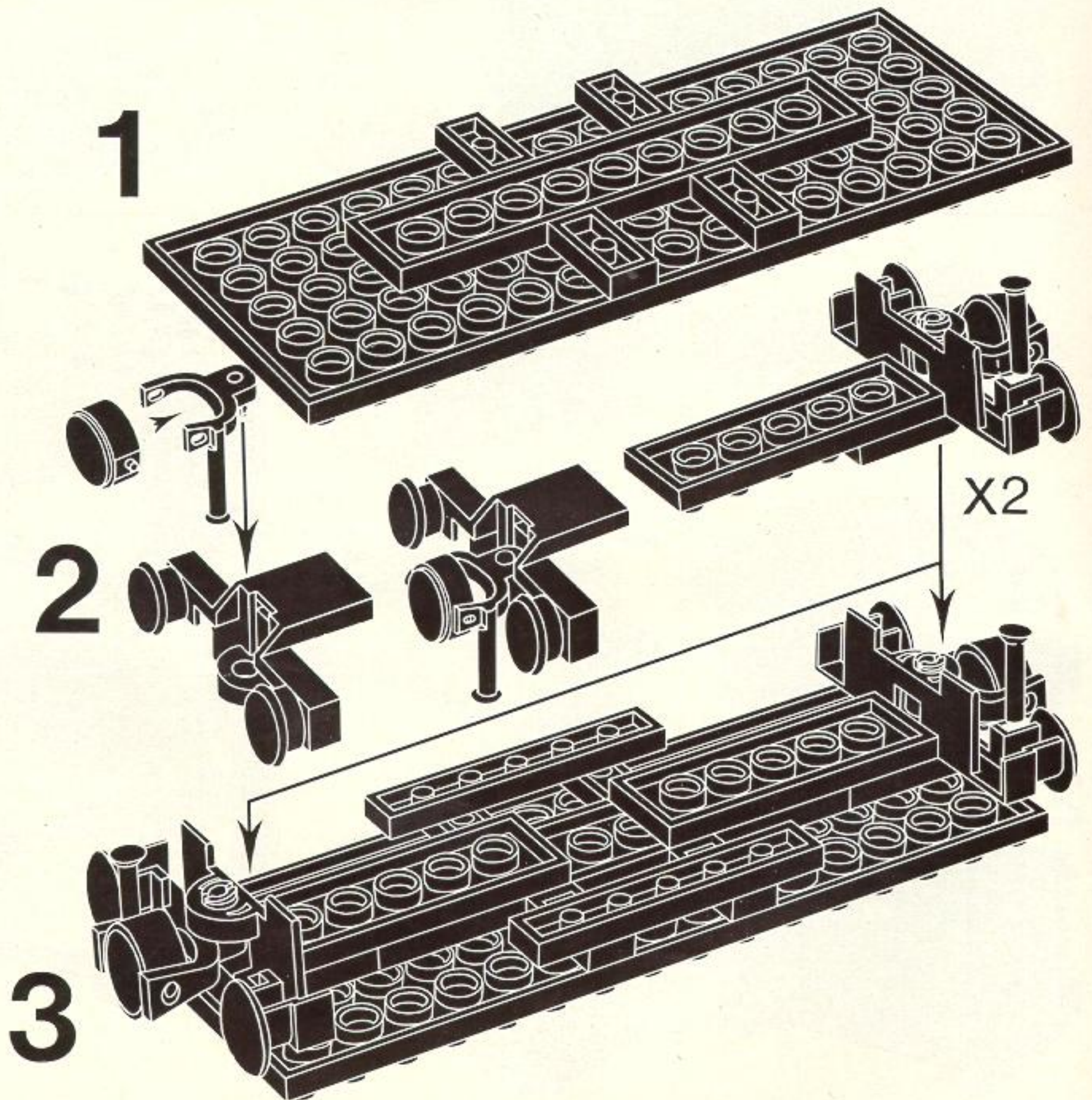
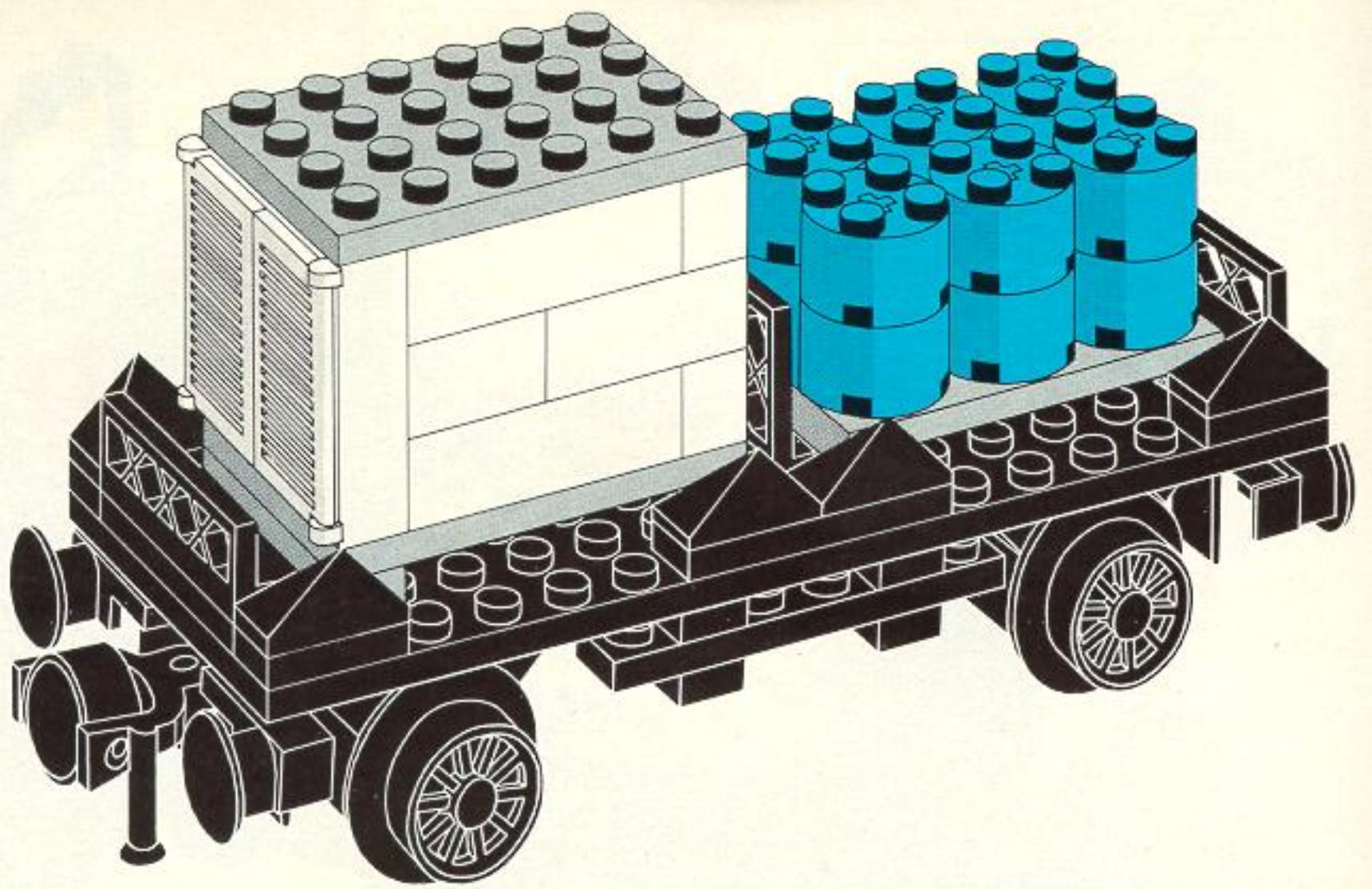

4

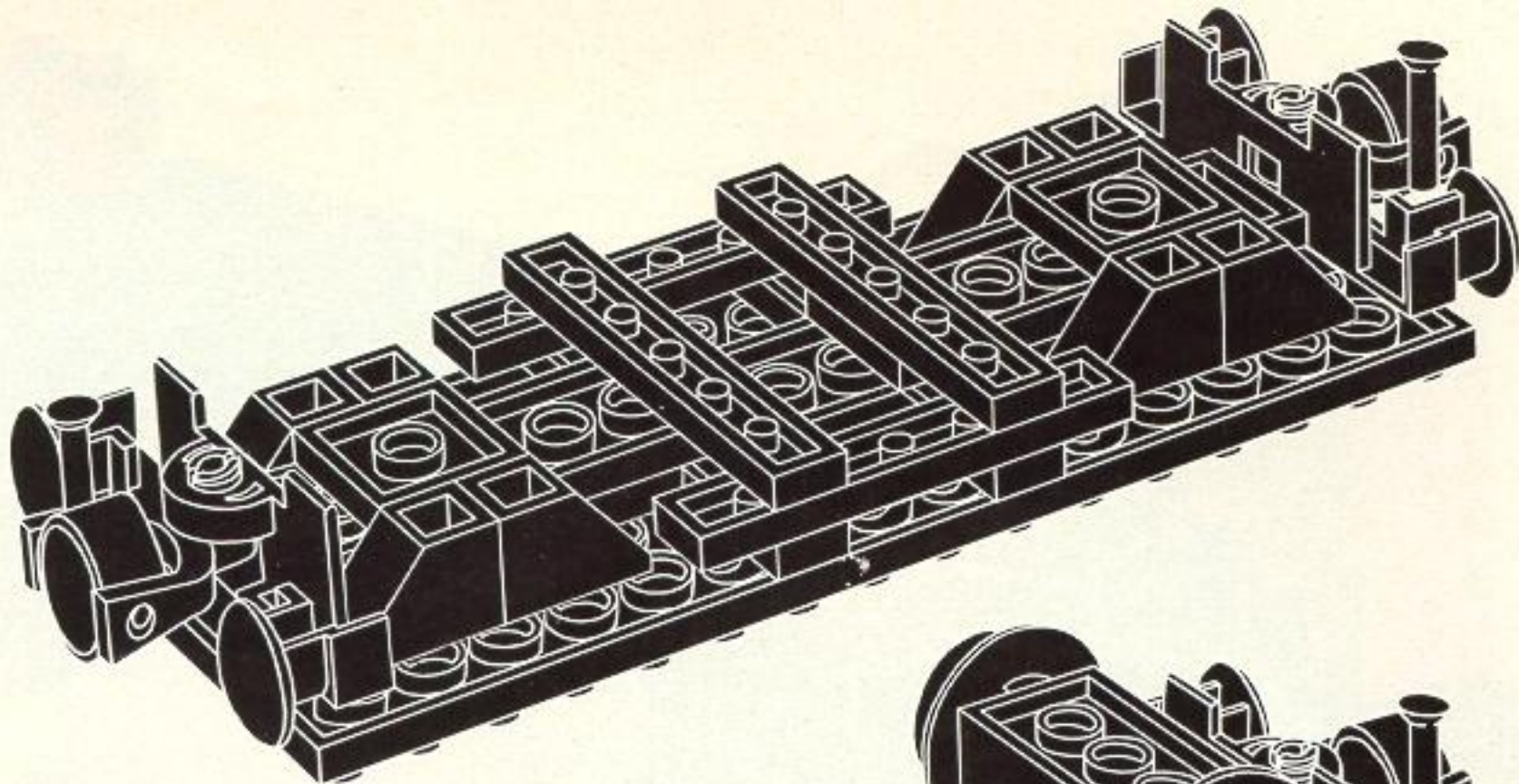

5

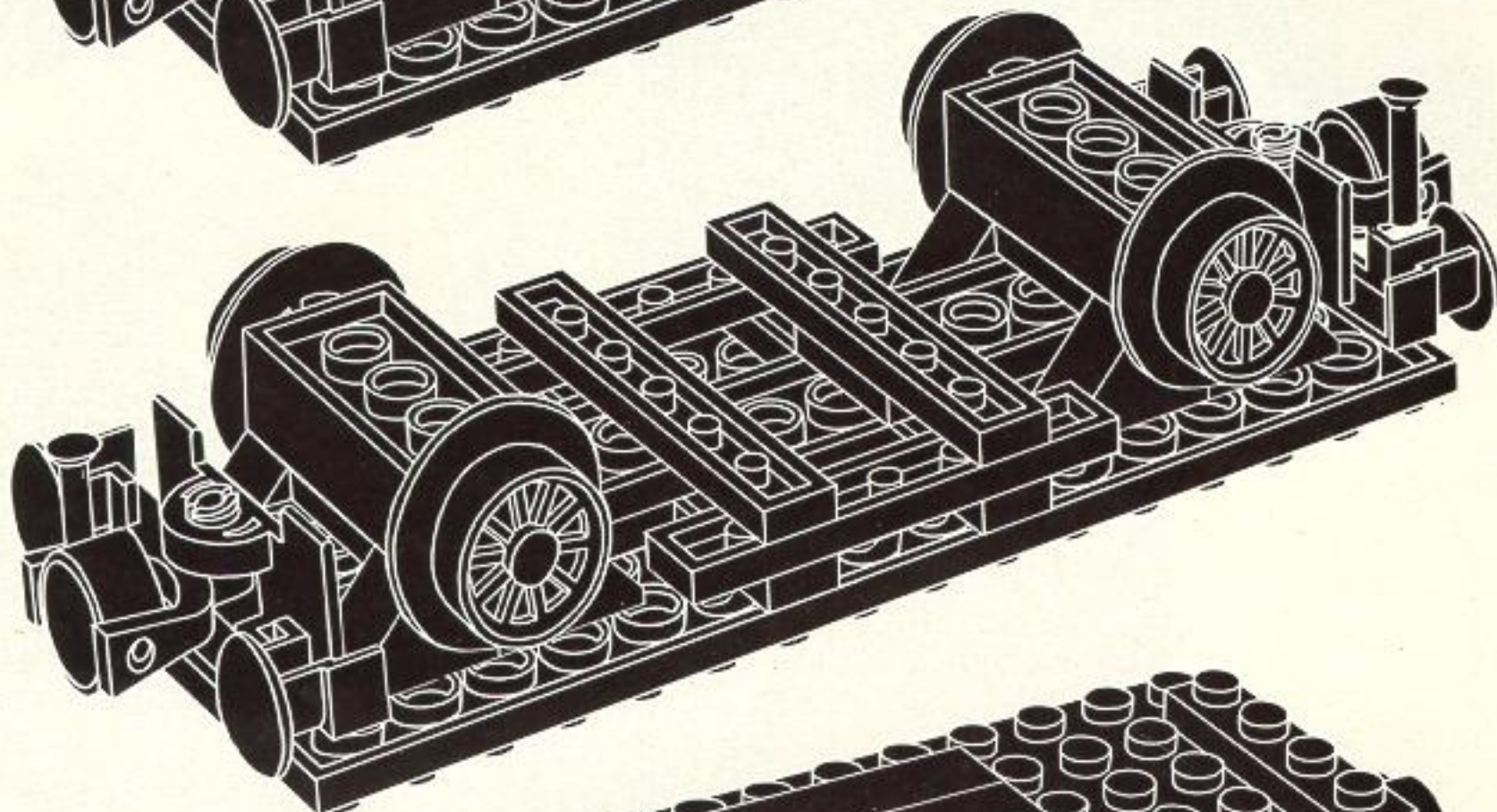

6

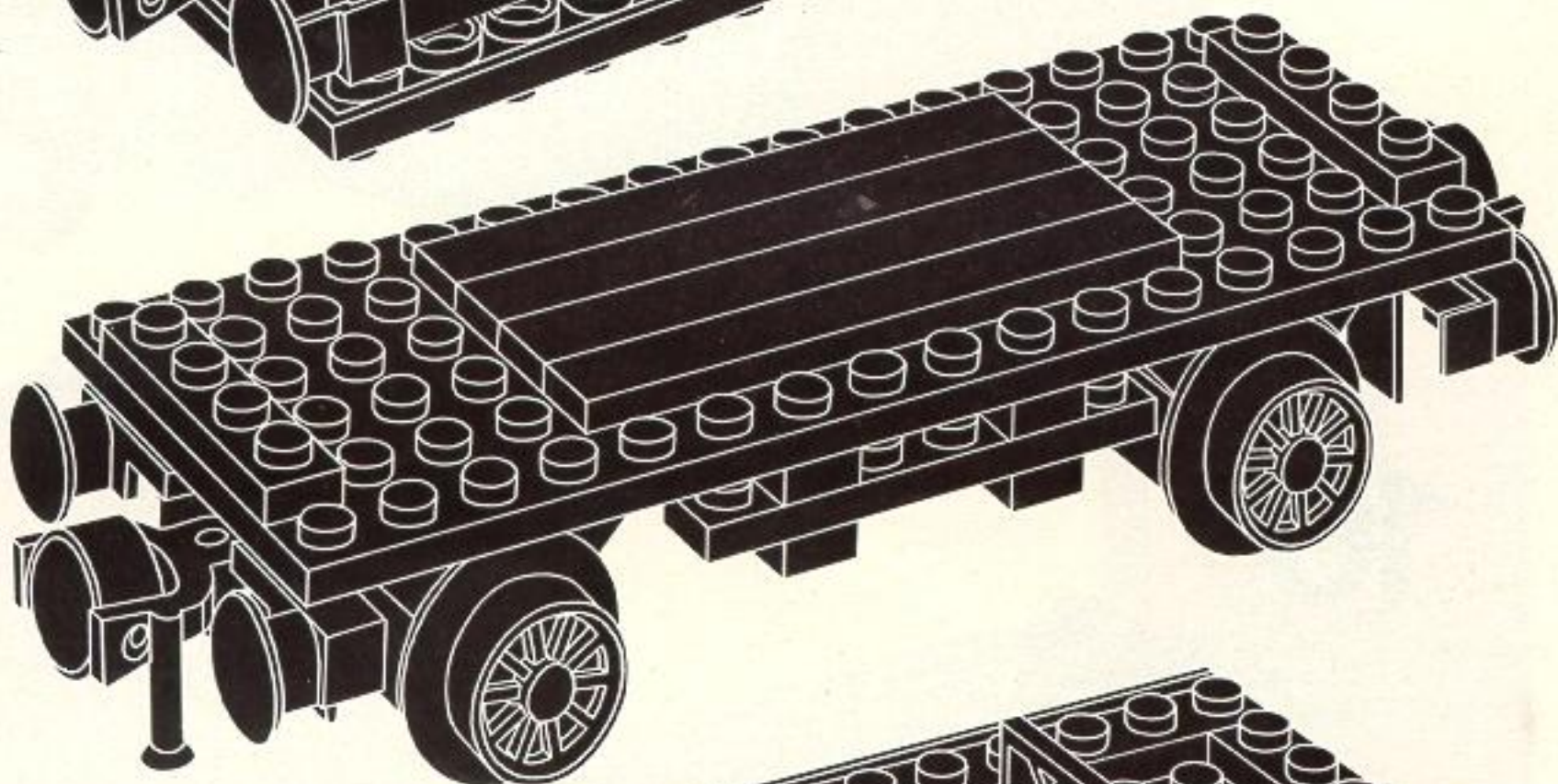

7

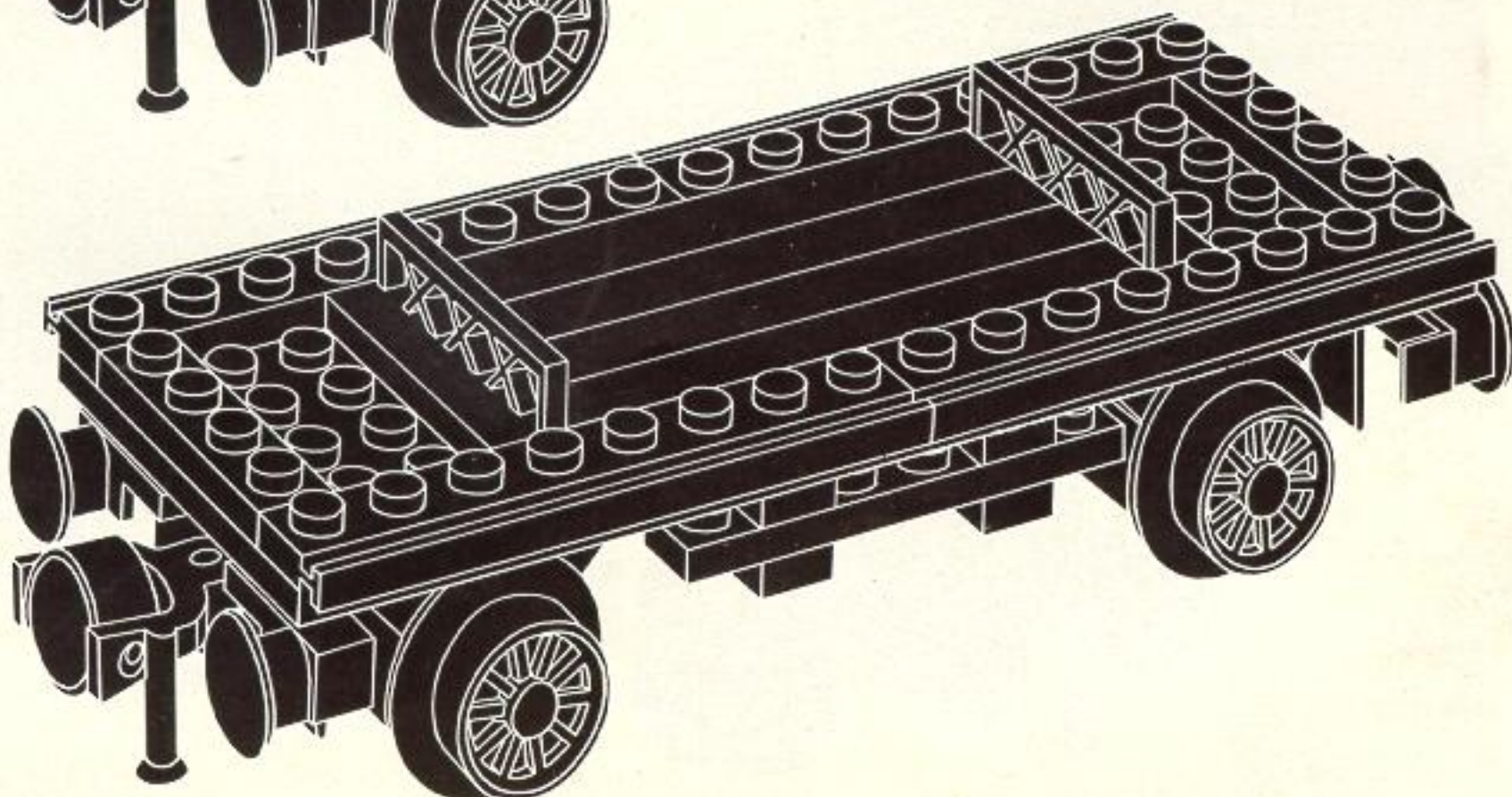

8

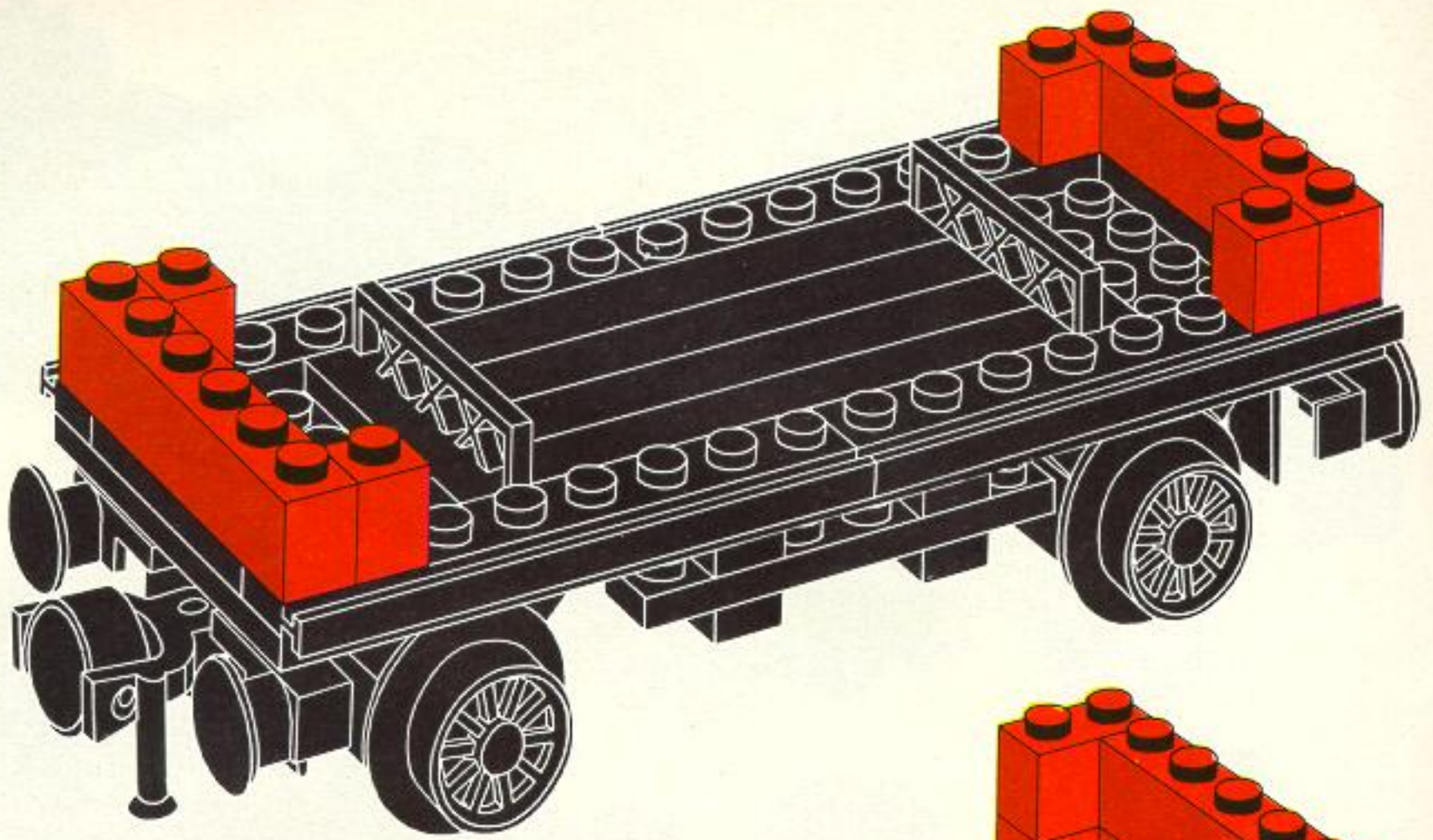

9

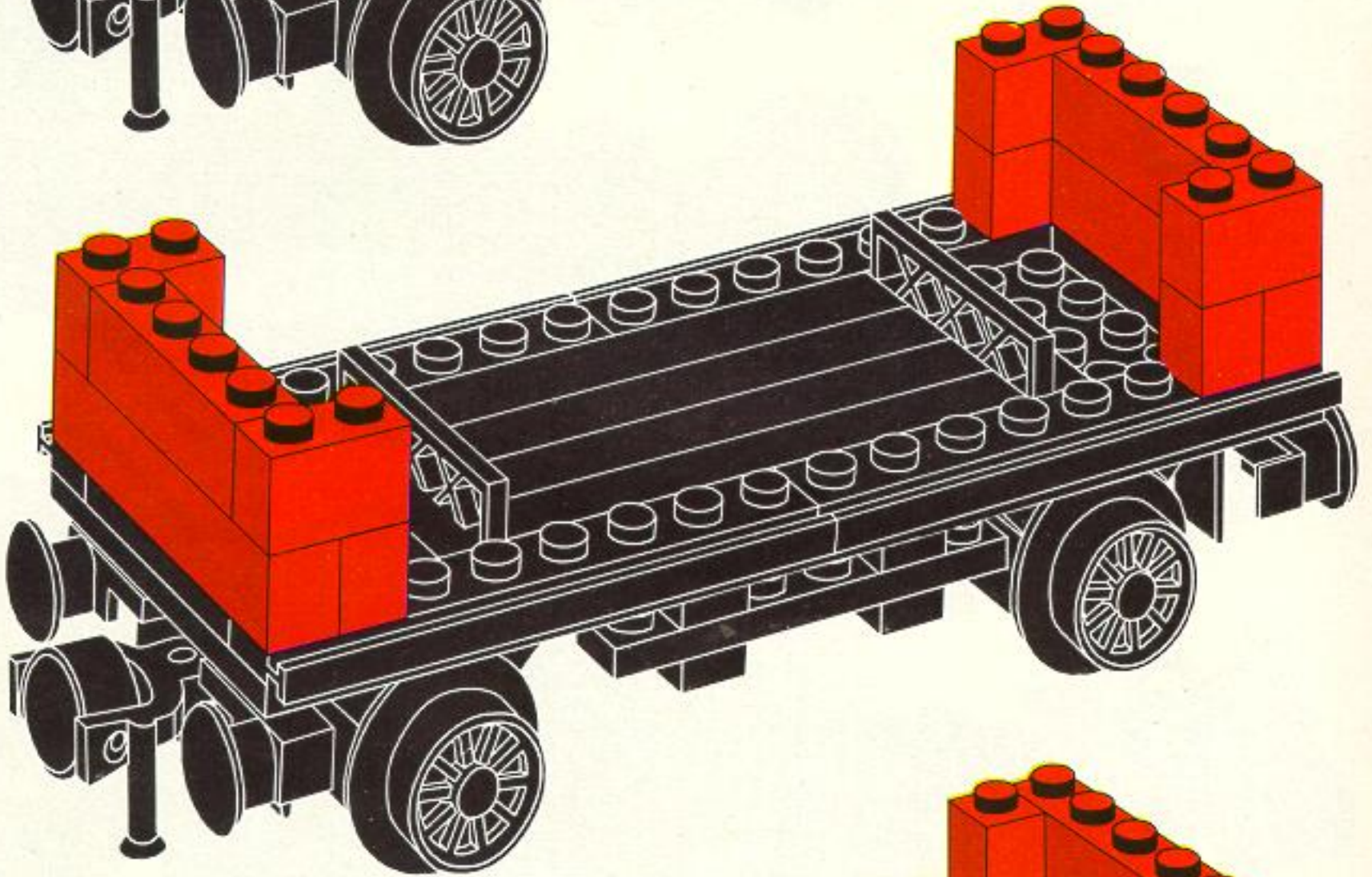

10

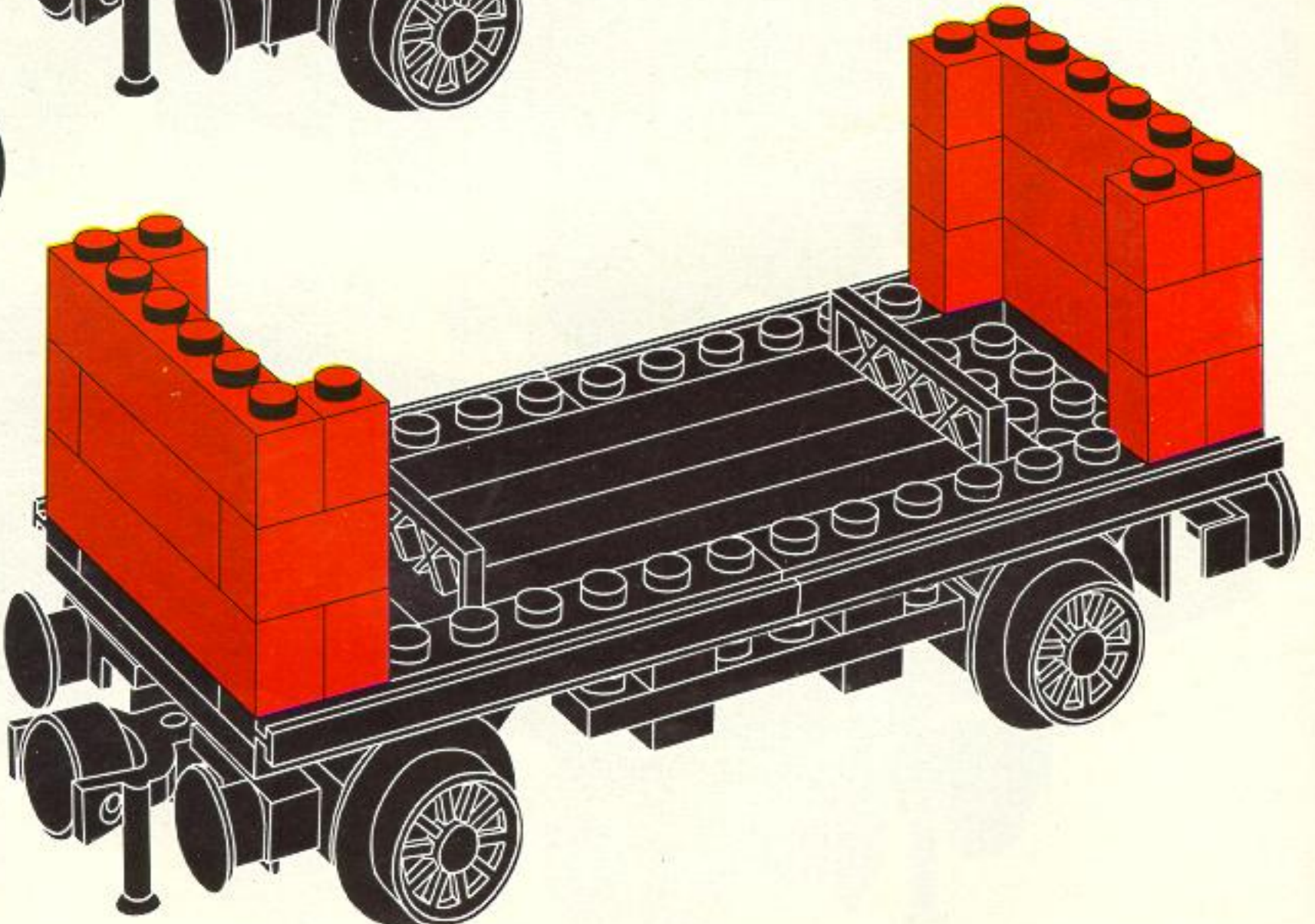

11

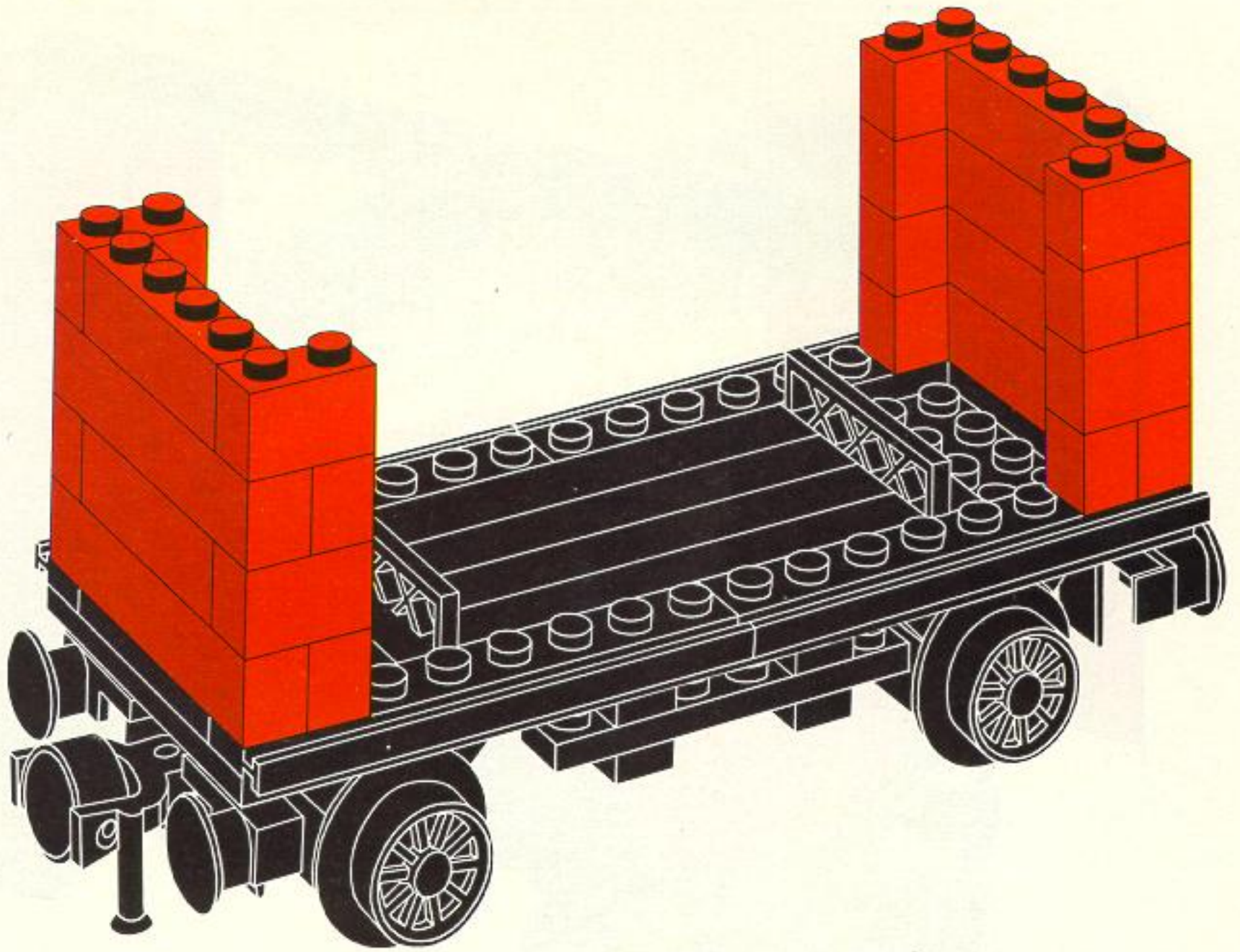

12

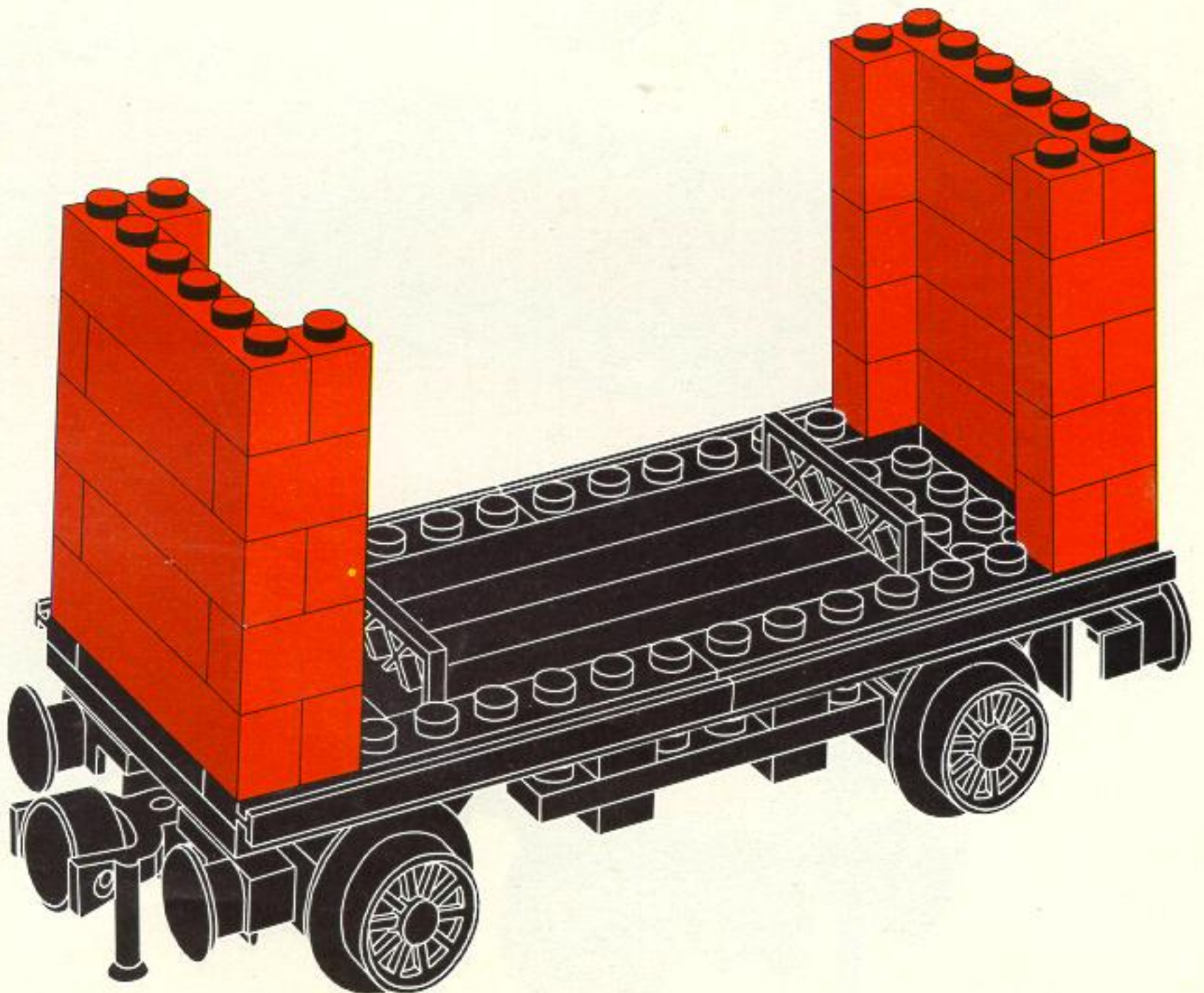

13

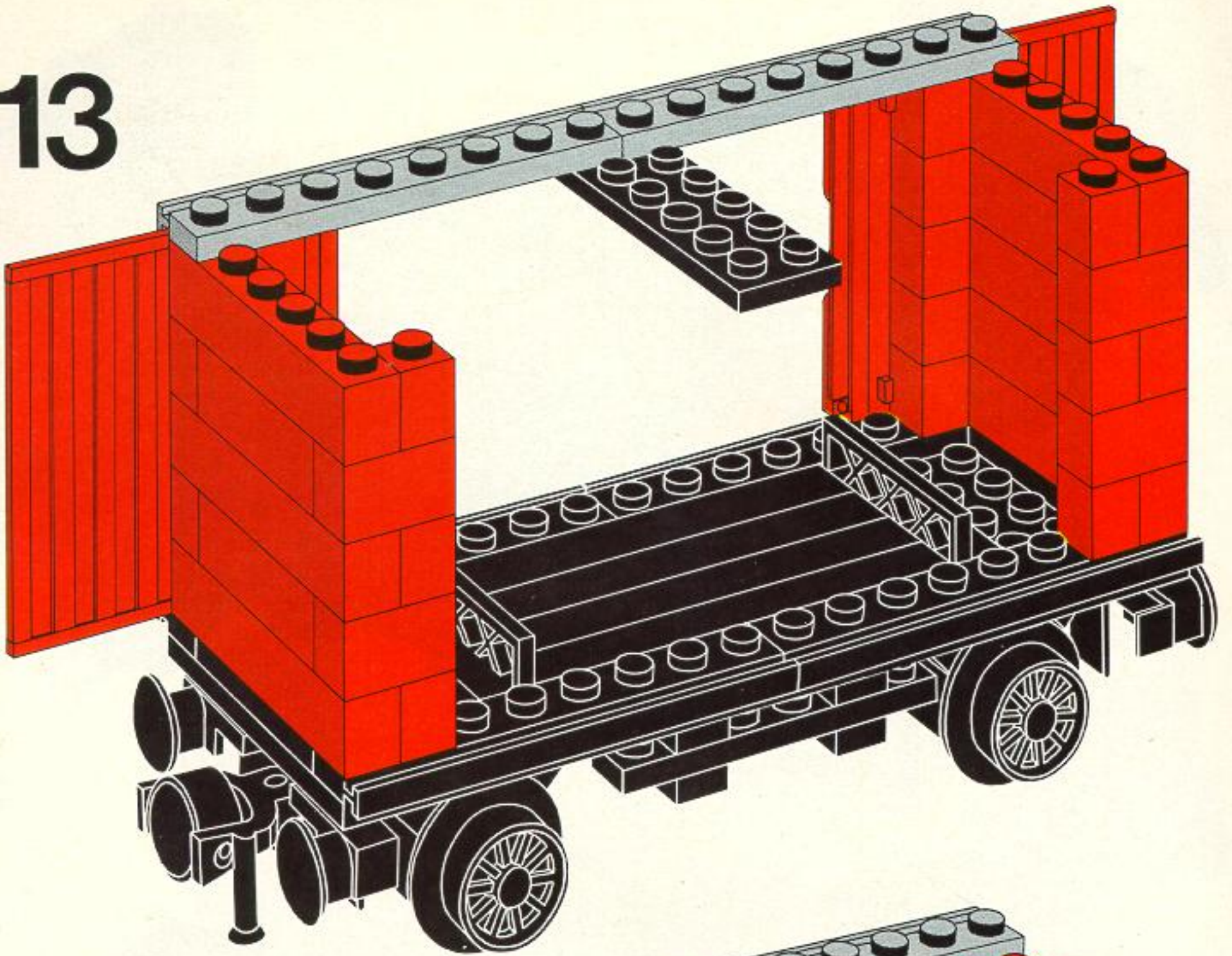

14

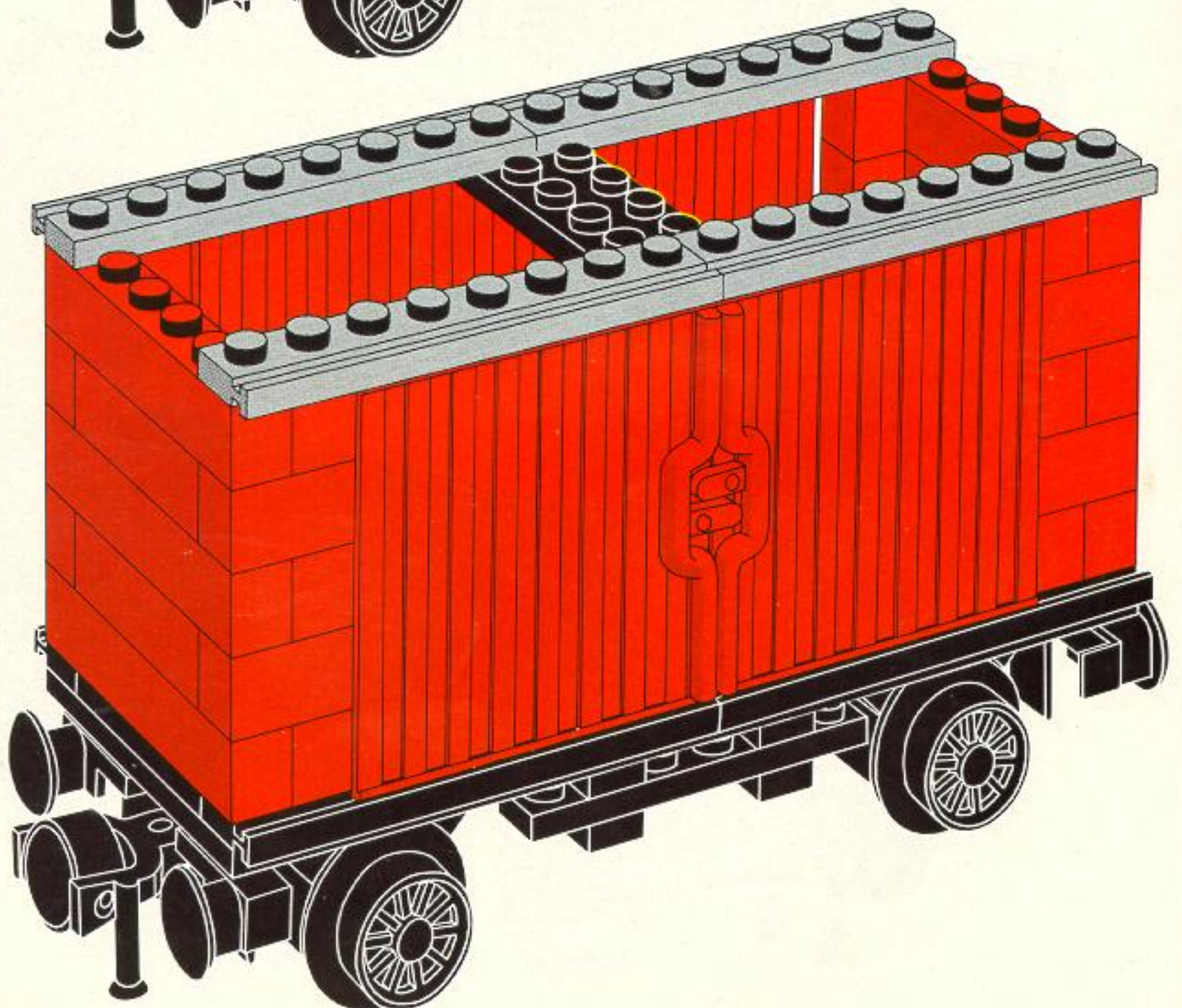

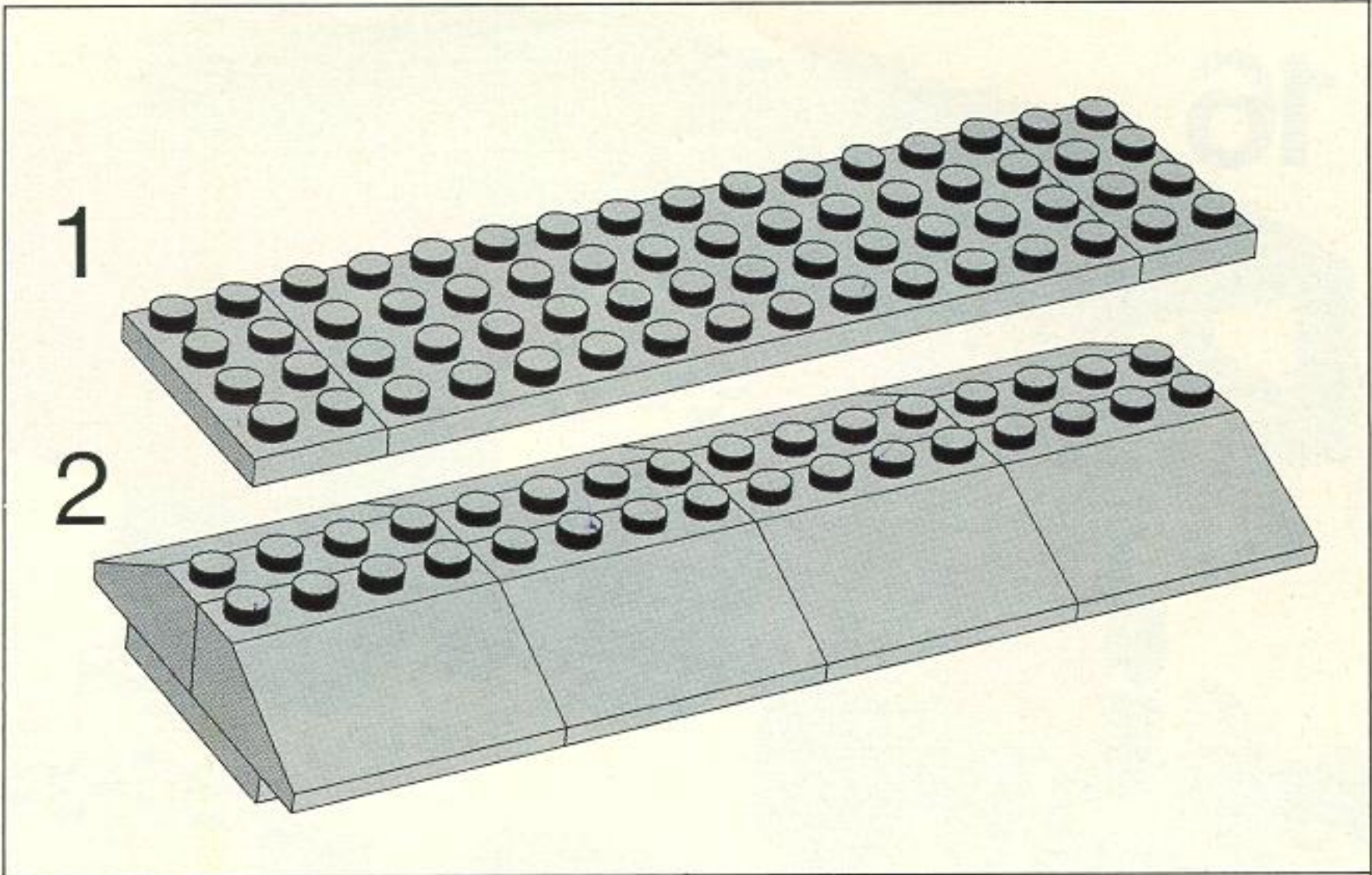

15

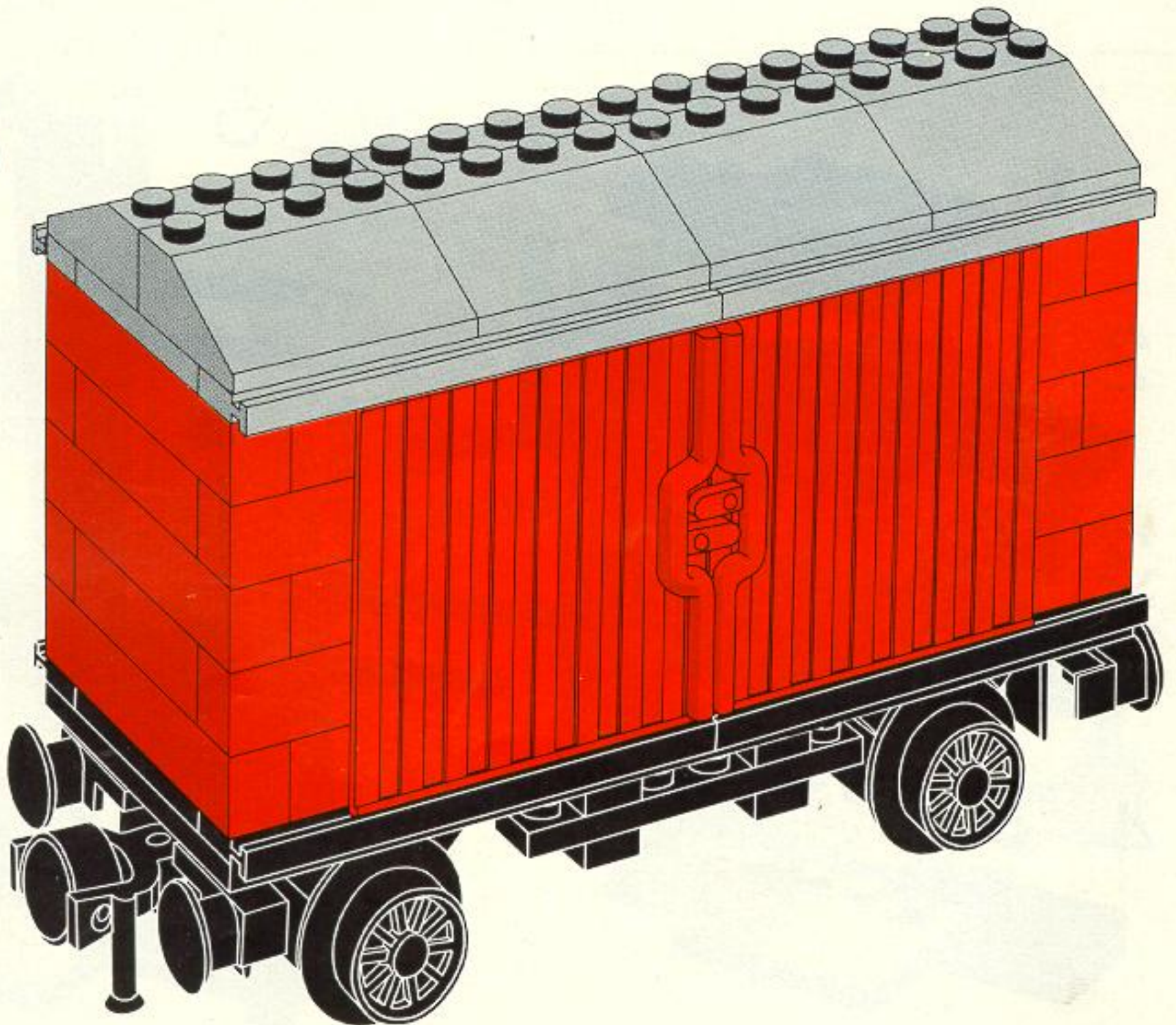

16

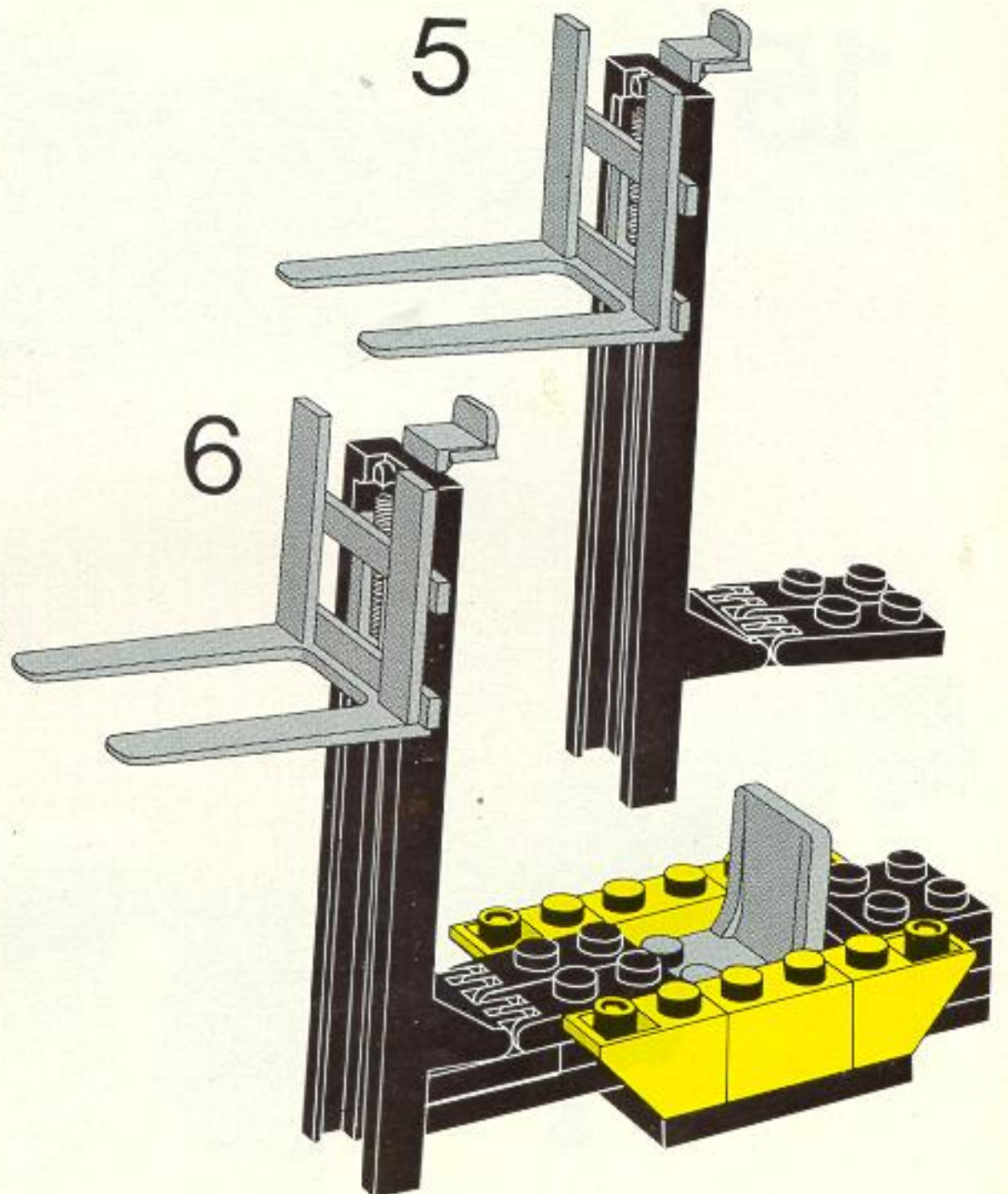
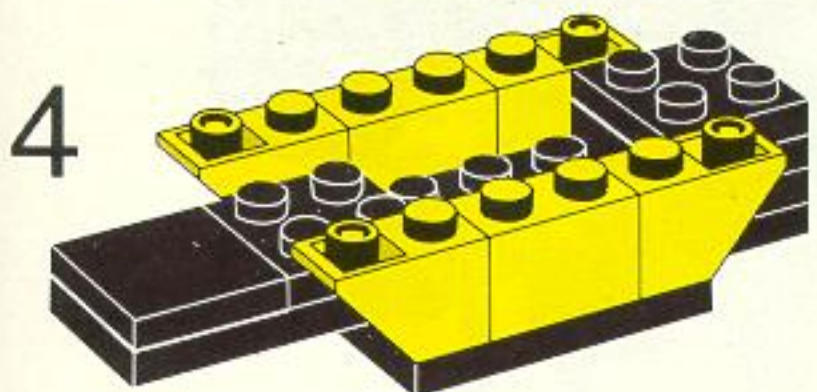
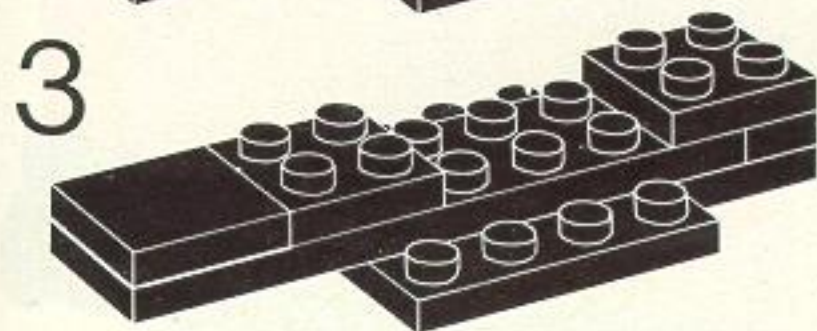
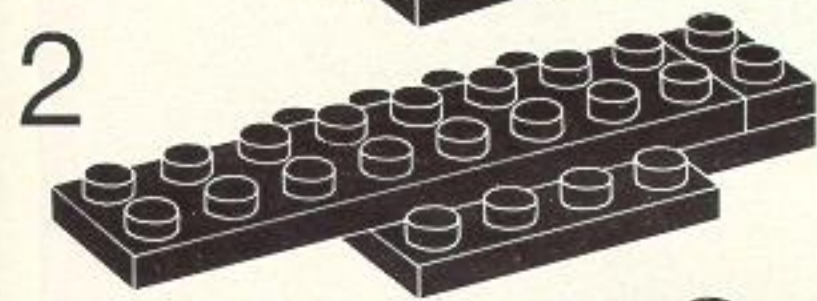
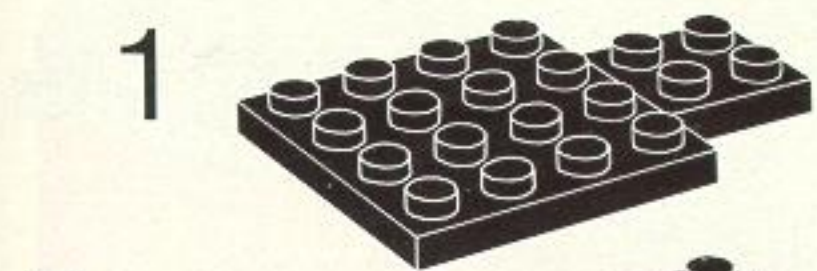
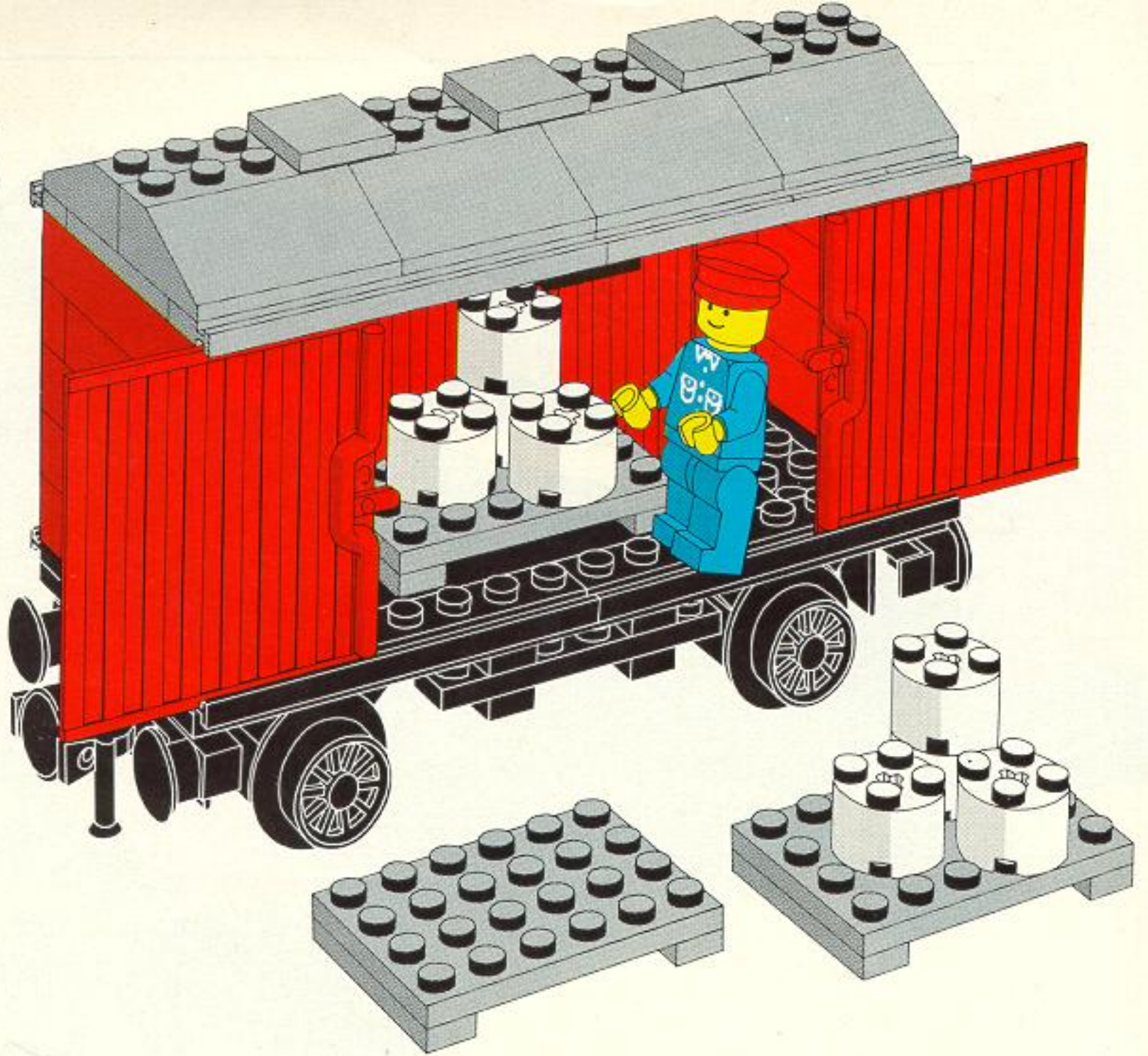

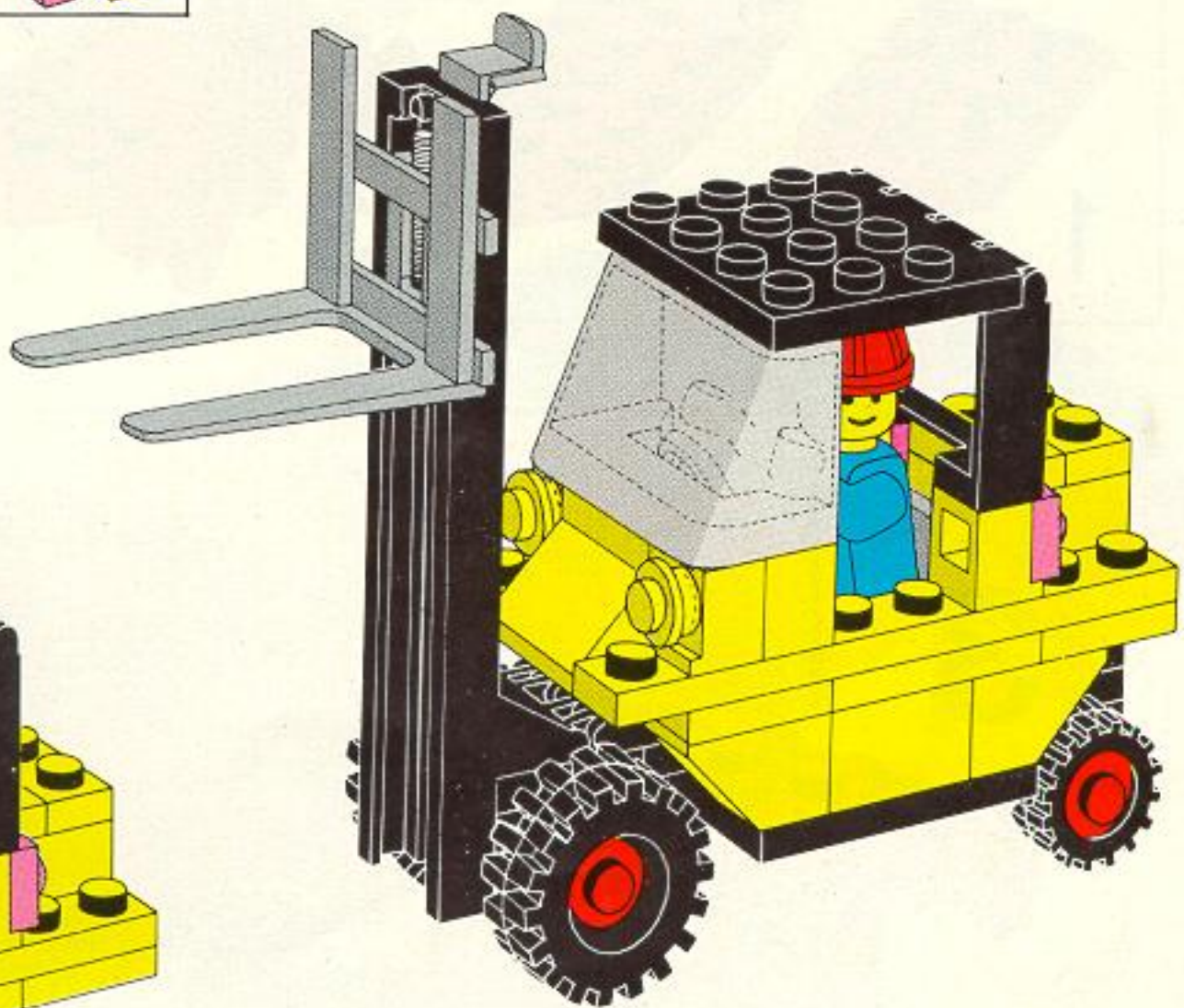
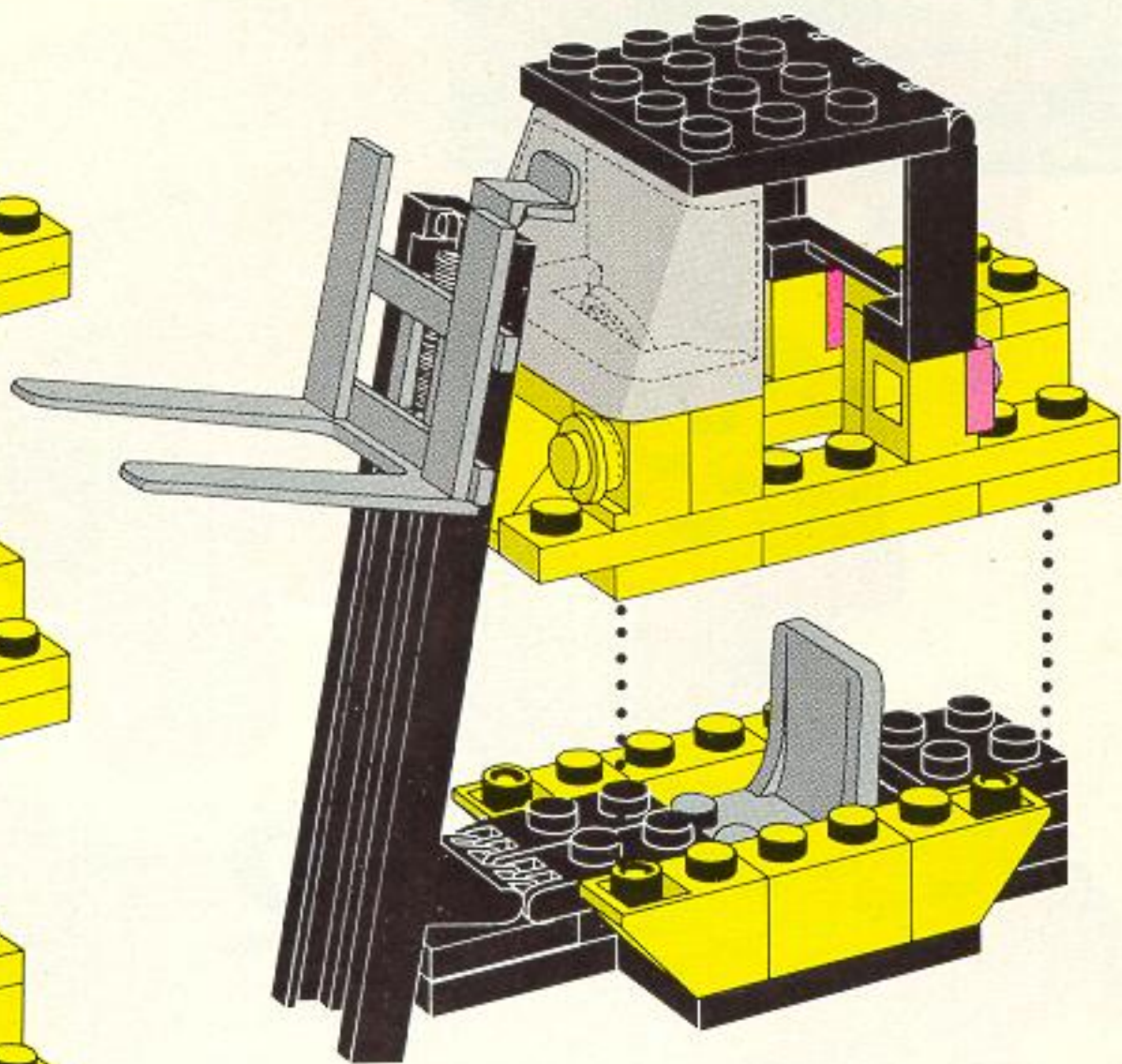
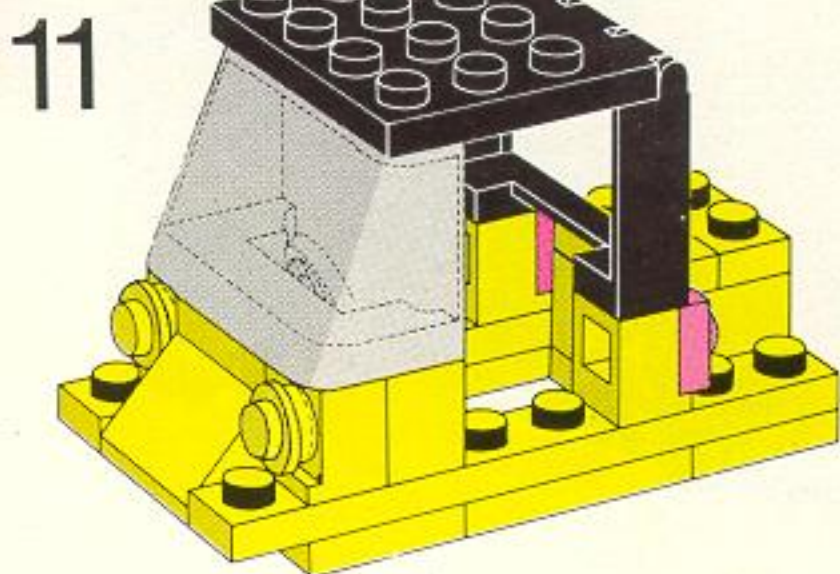
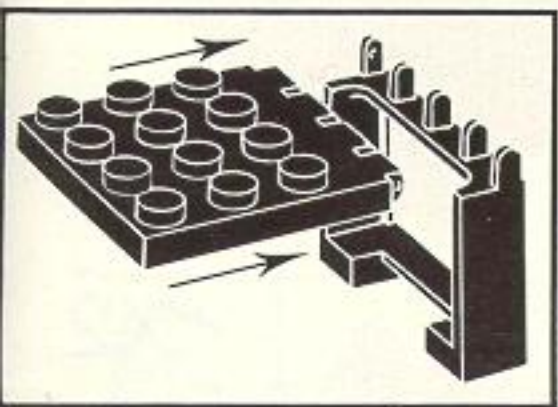
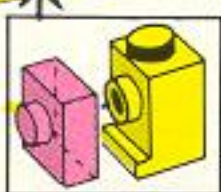
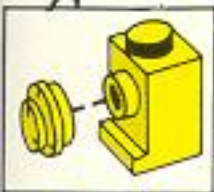
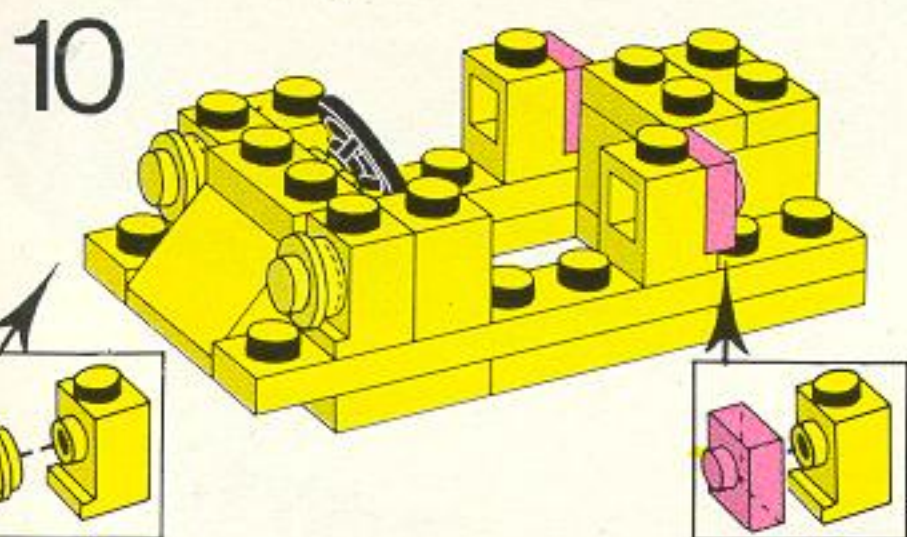
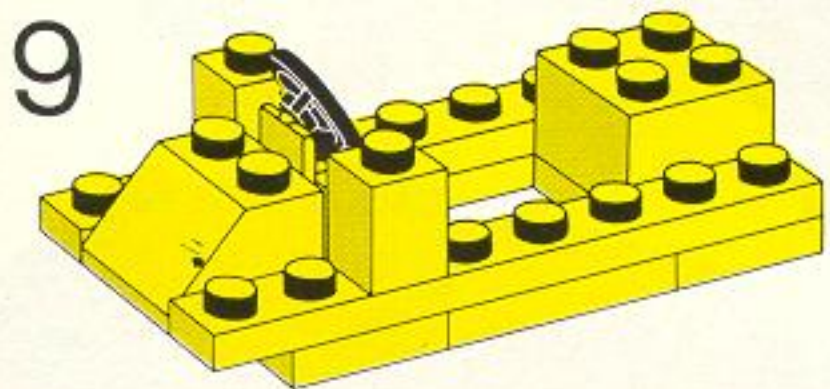
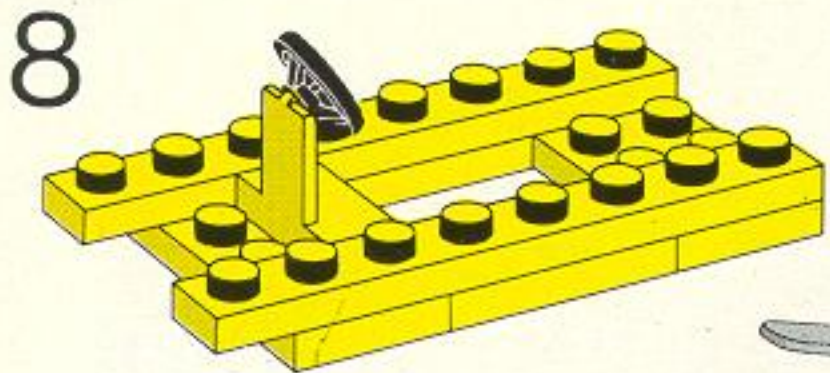
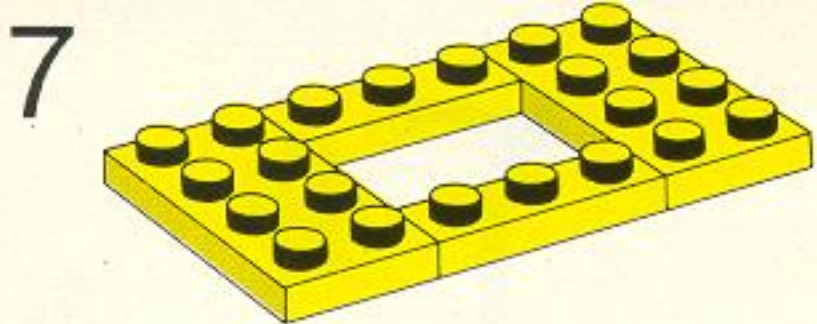



1

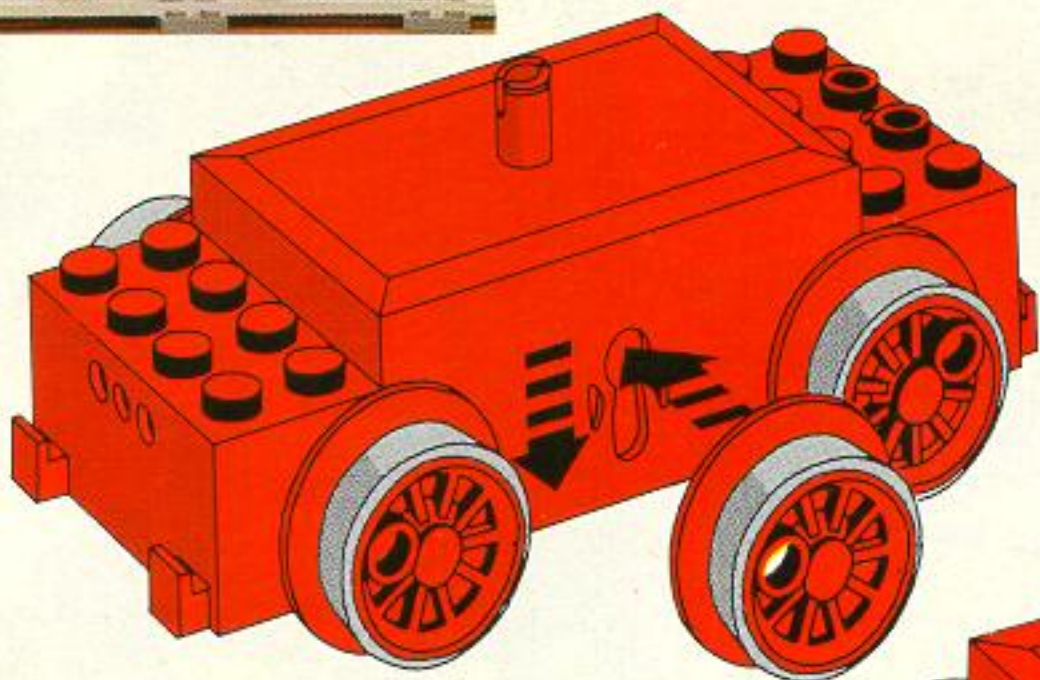

2

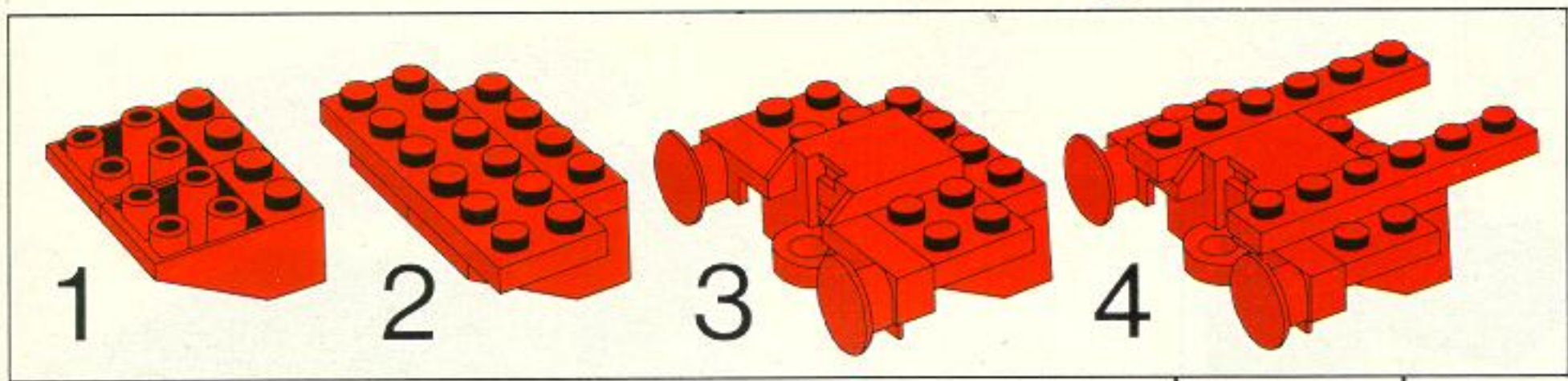
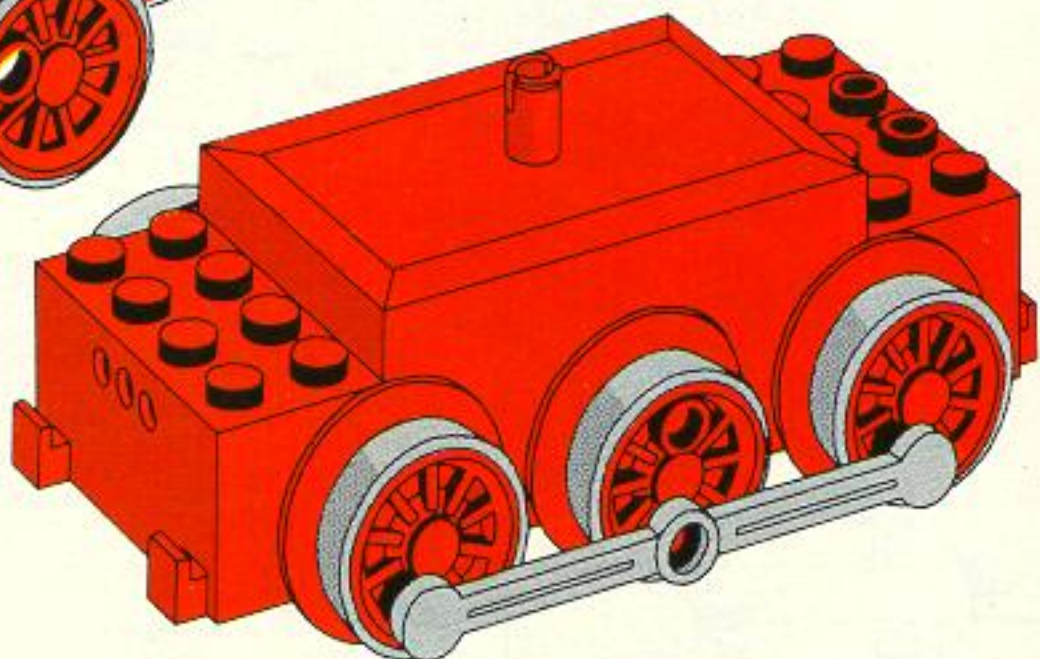

X2

3

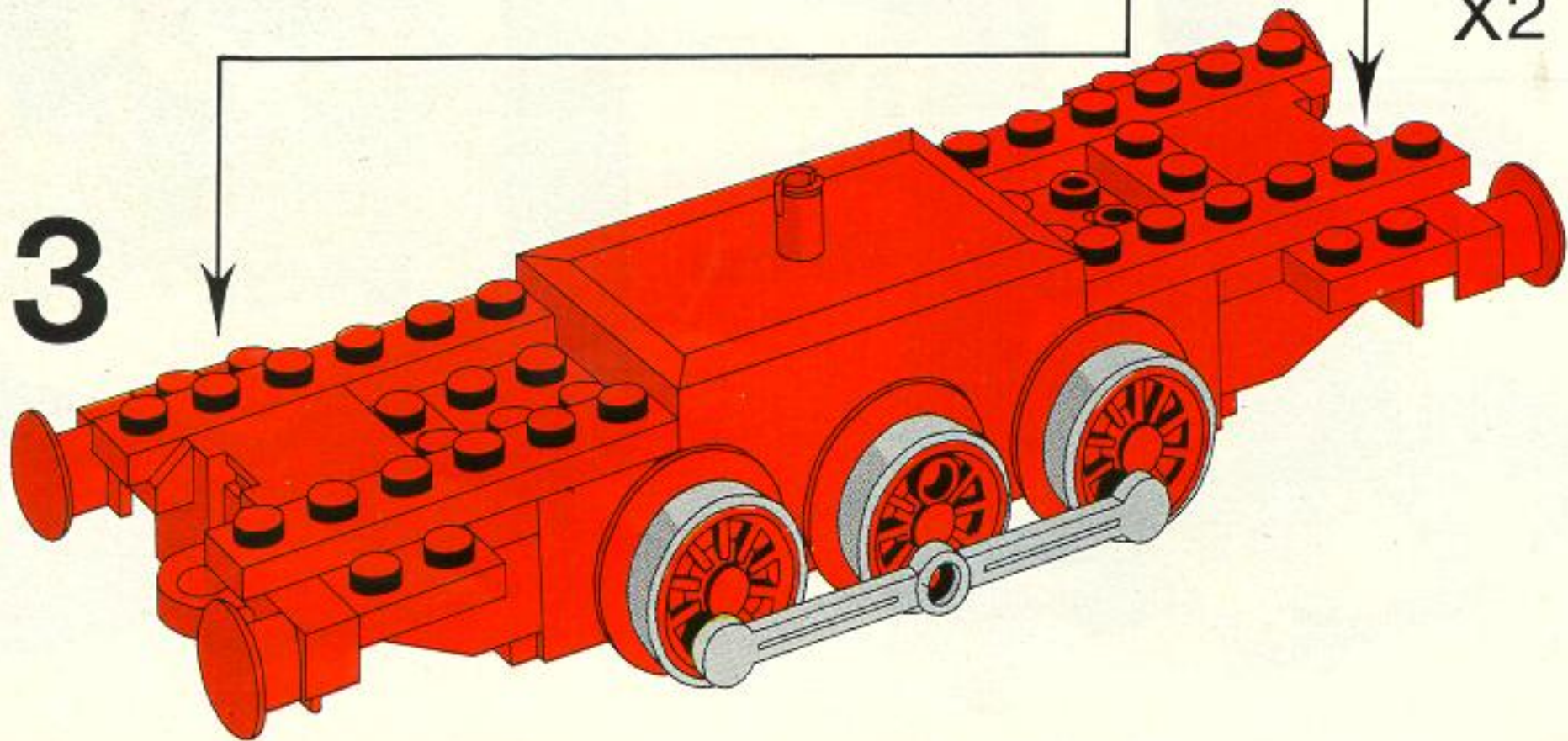

4

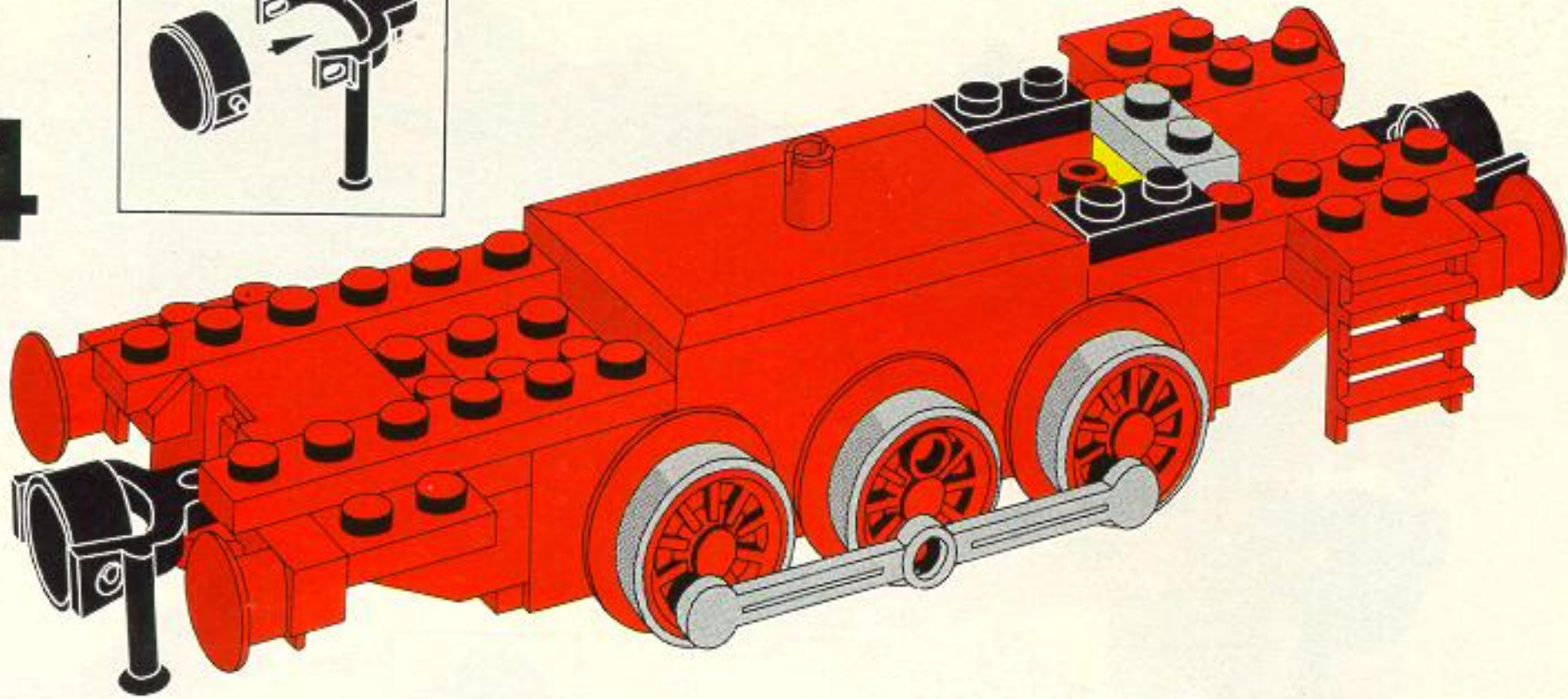
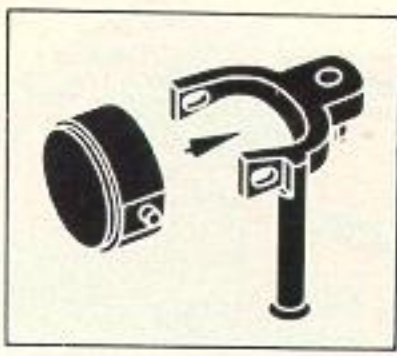

5

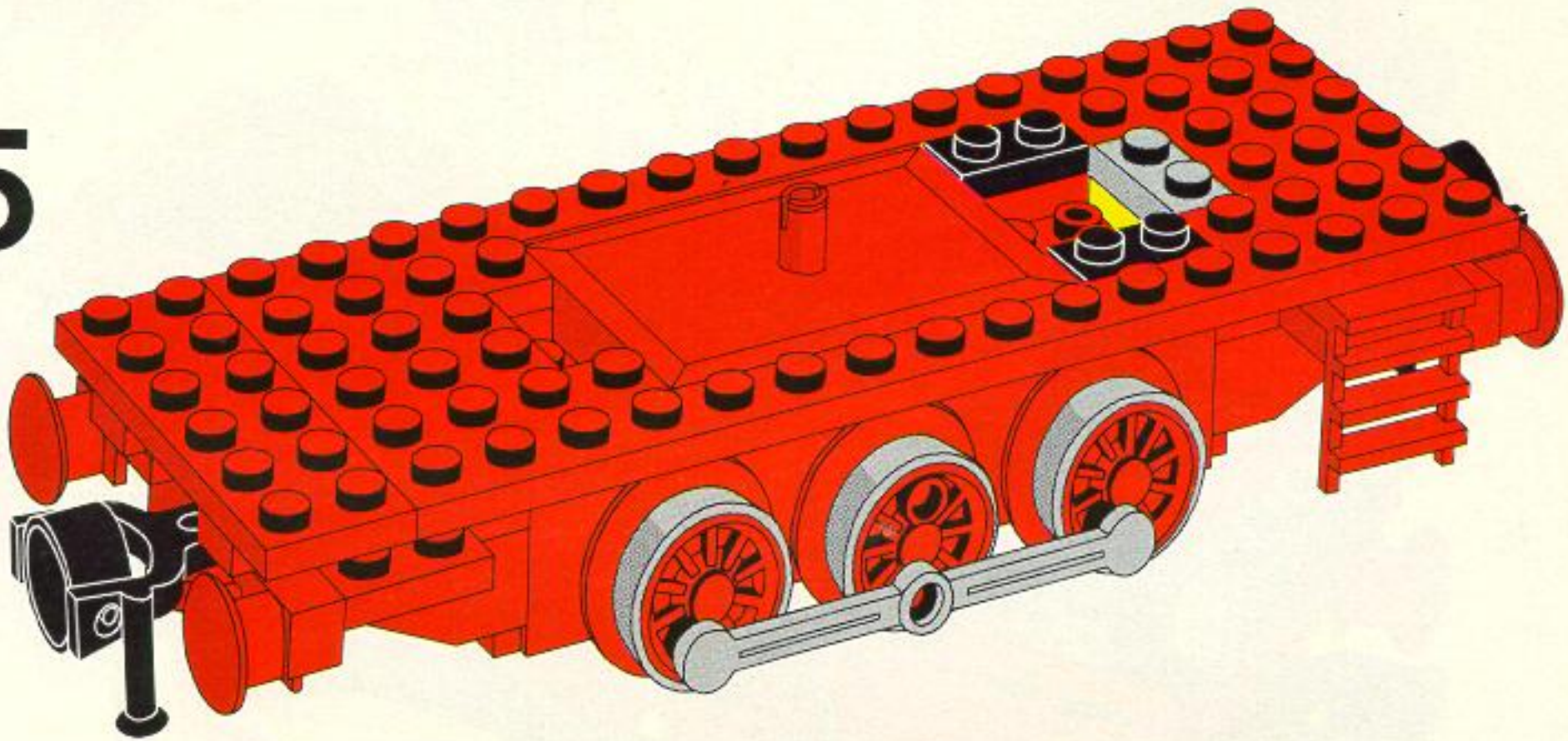

6

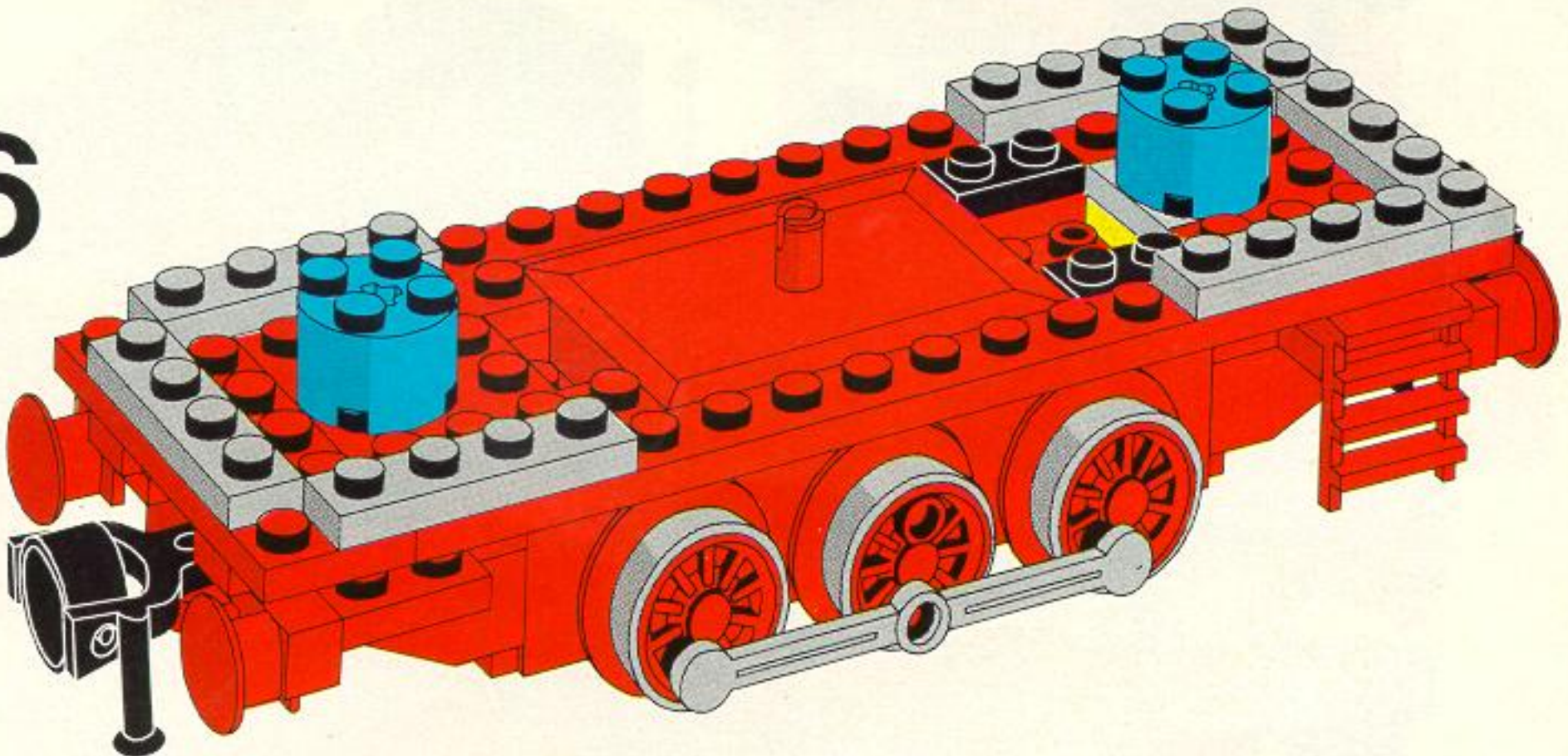

7

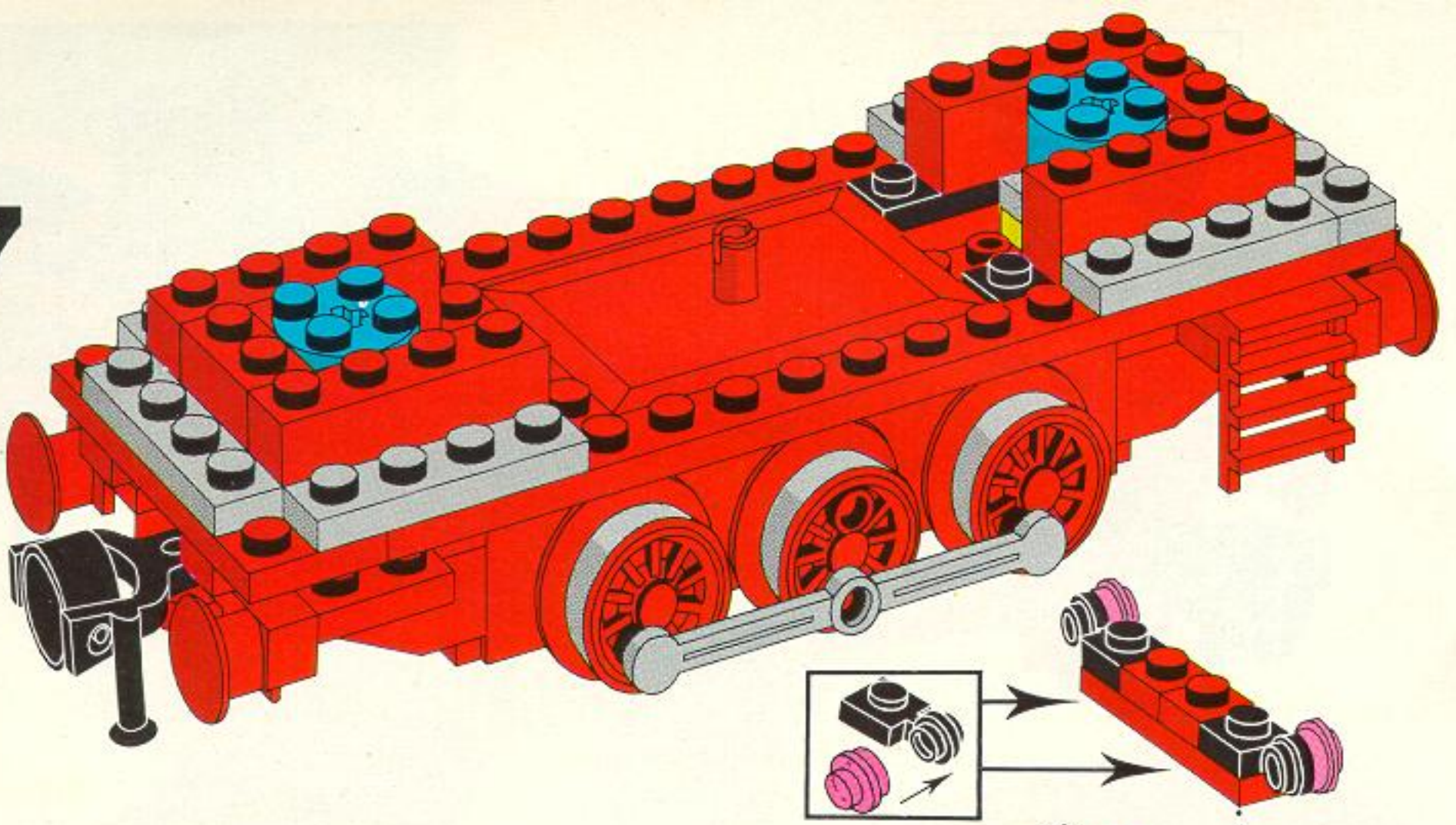

8

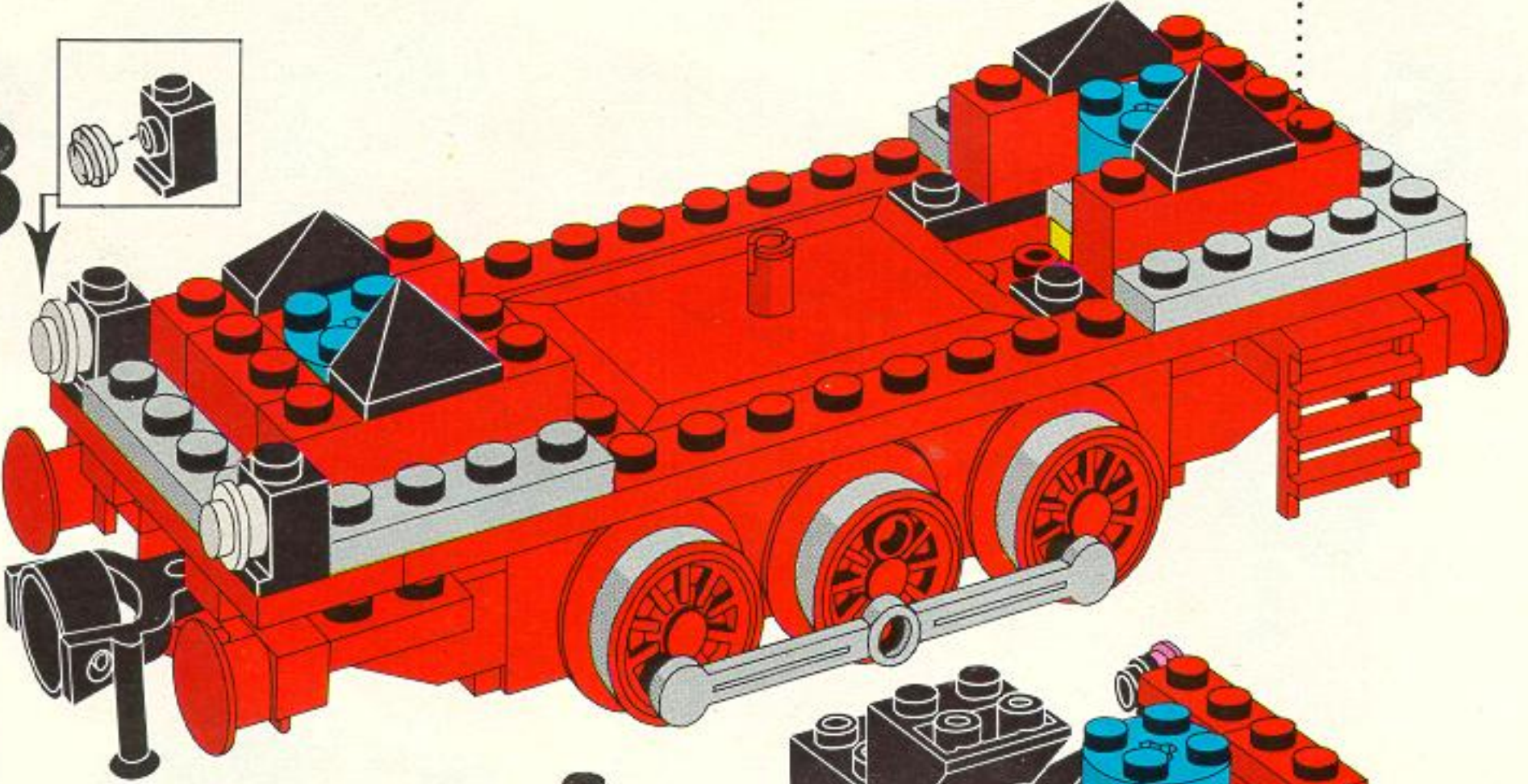

9

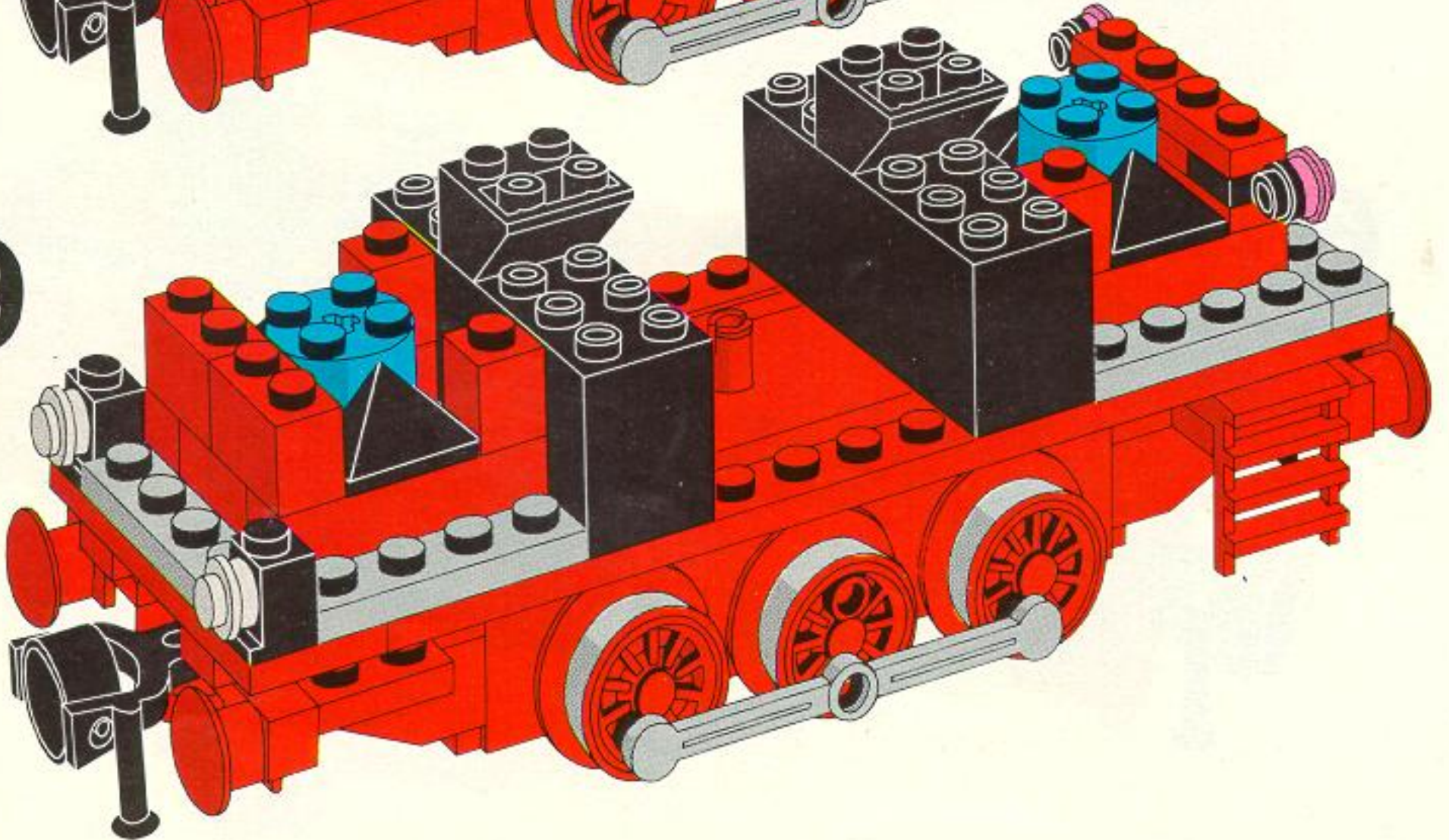

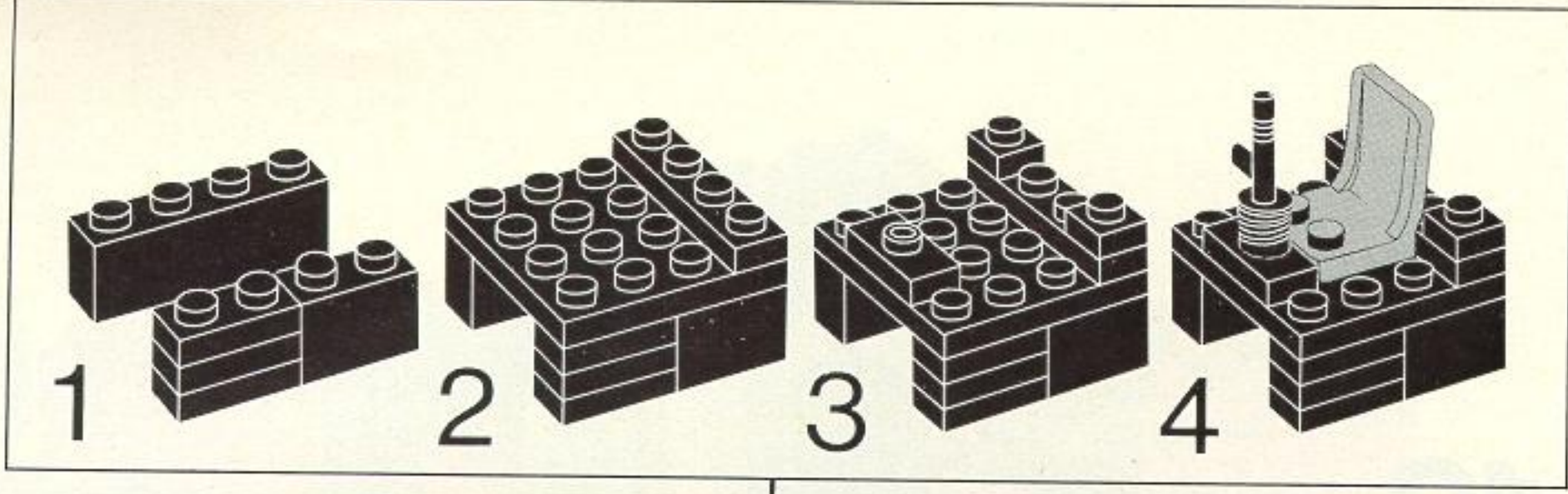

10

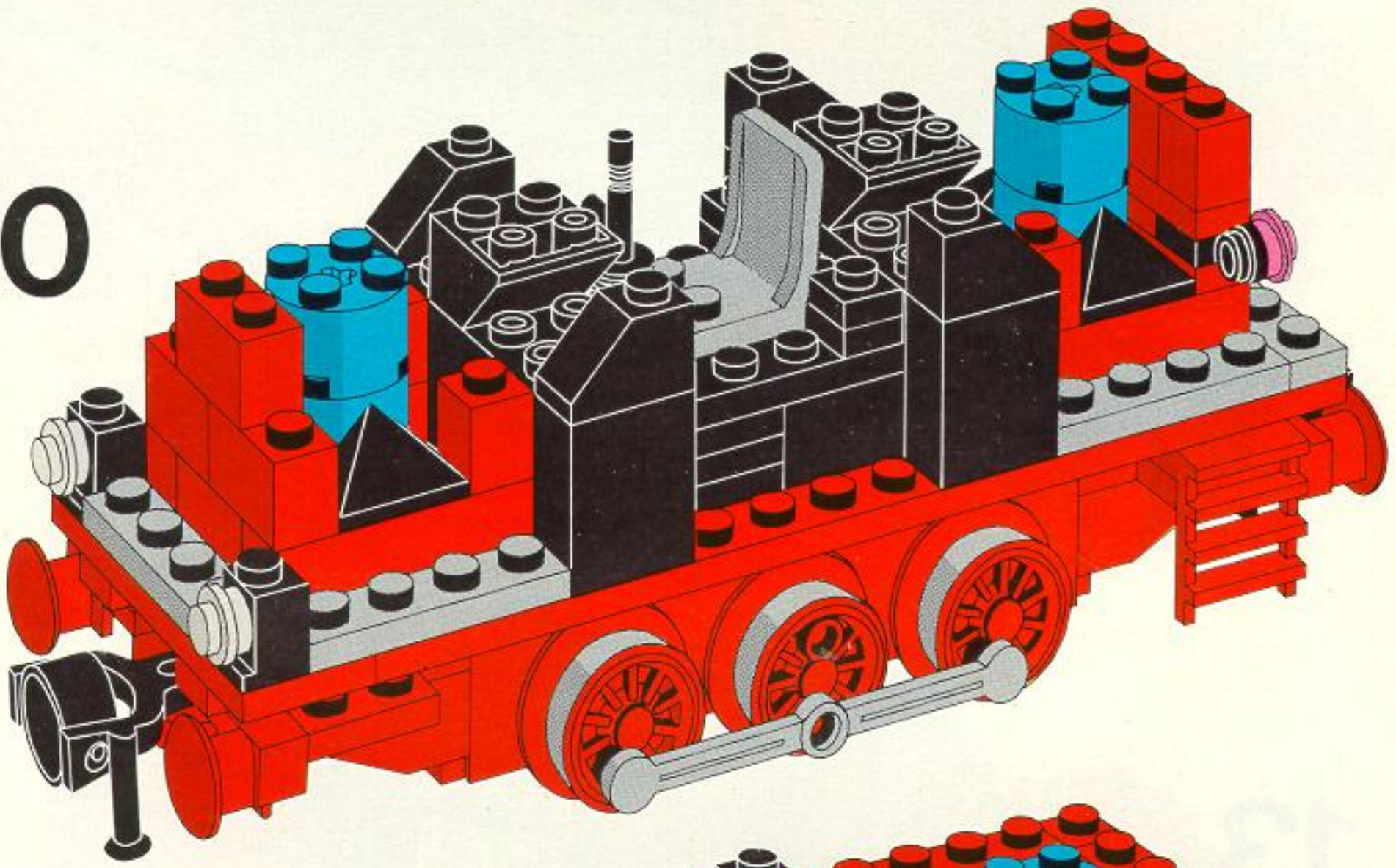

11

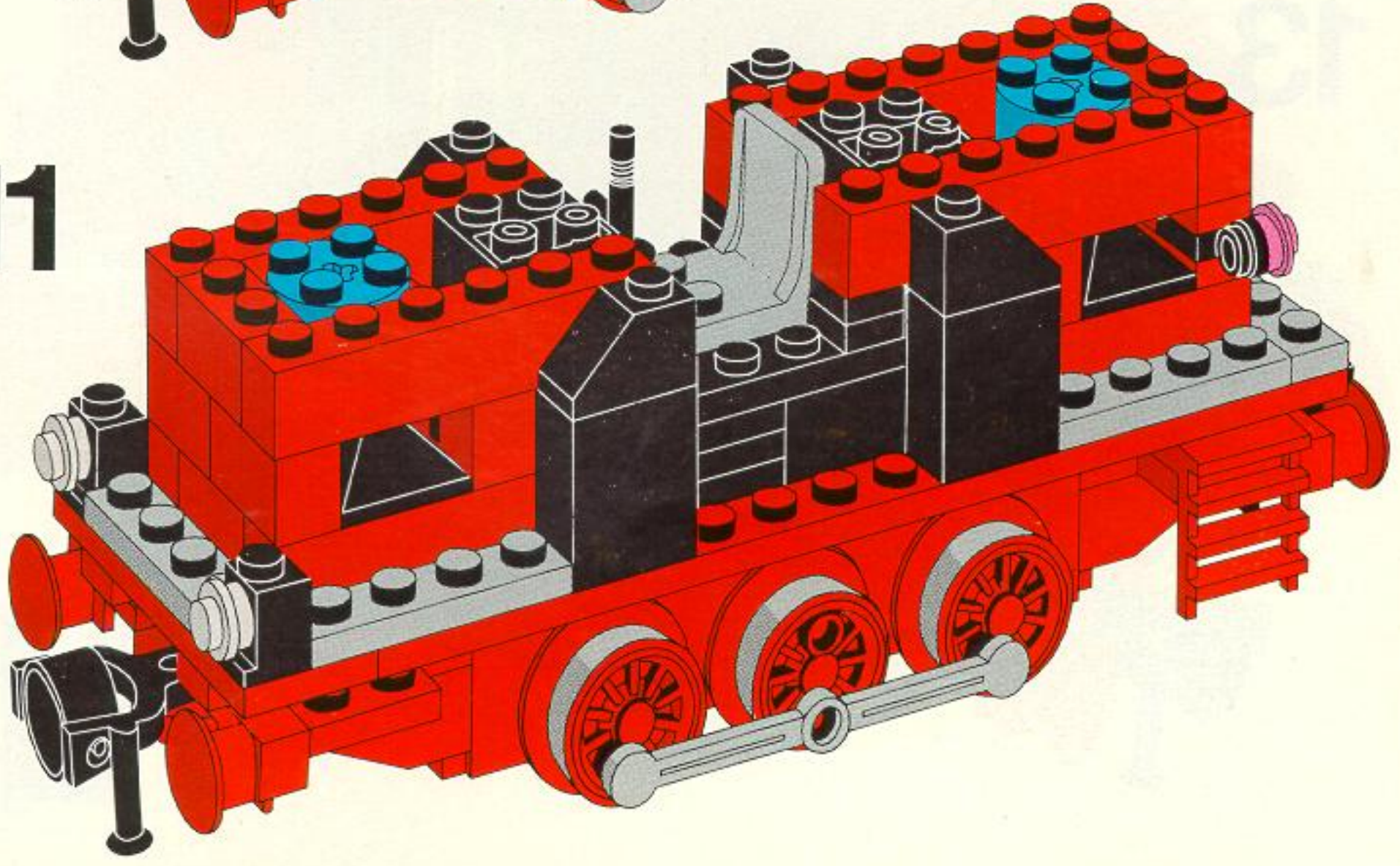

12

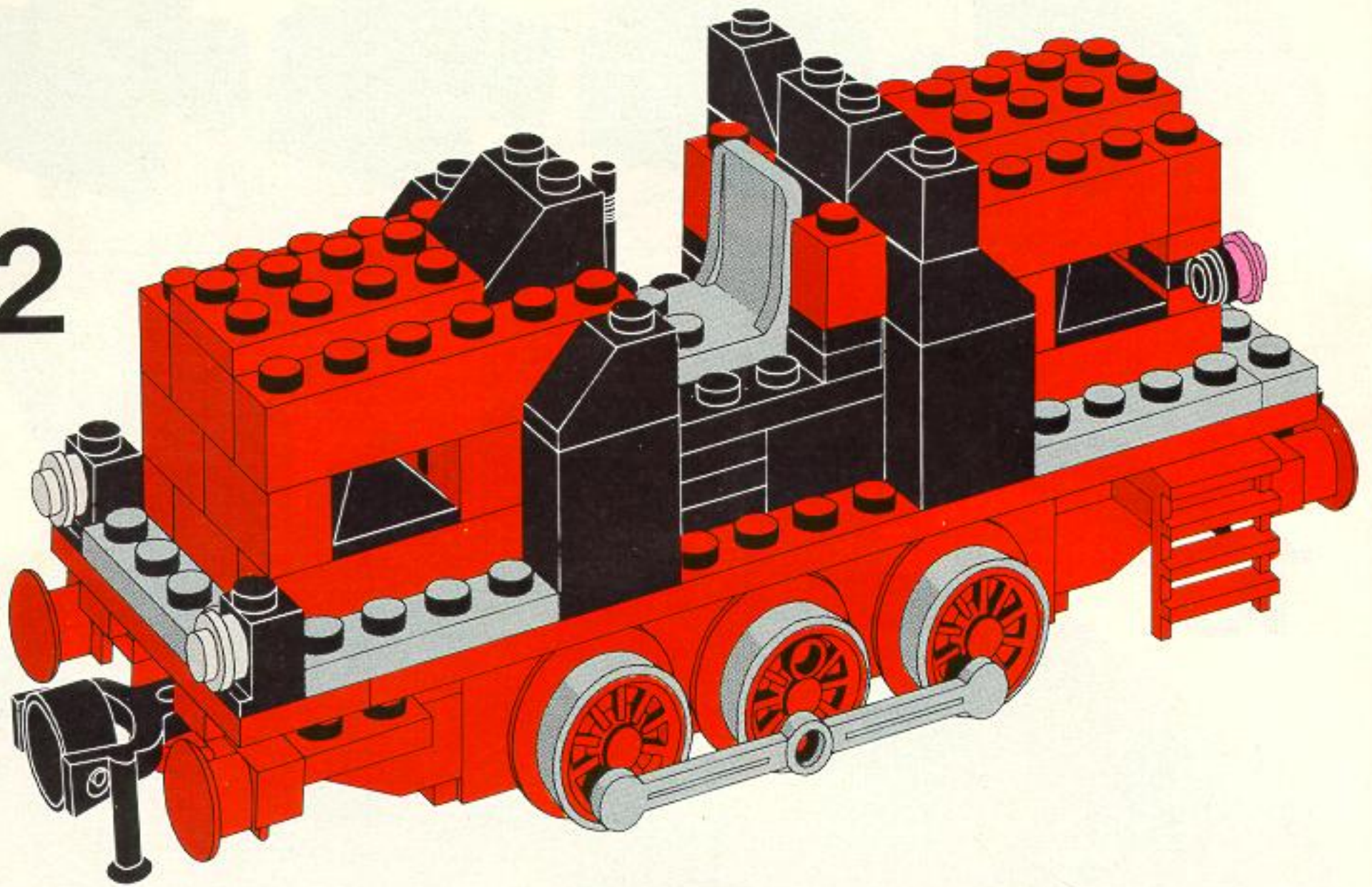

13

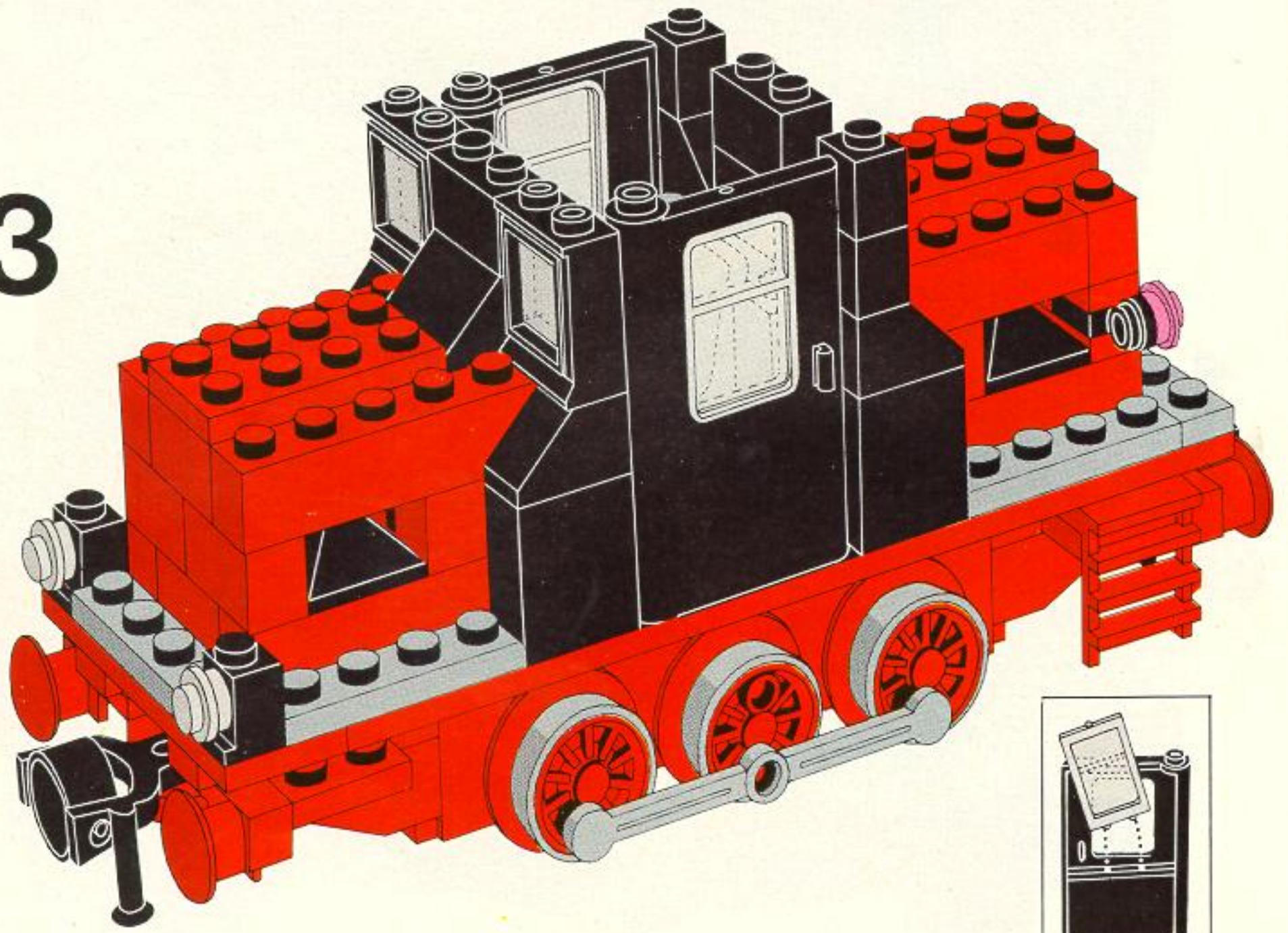

14

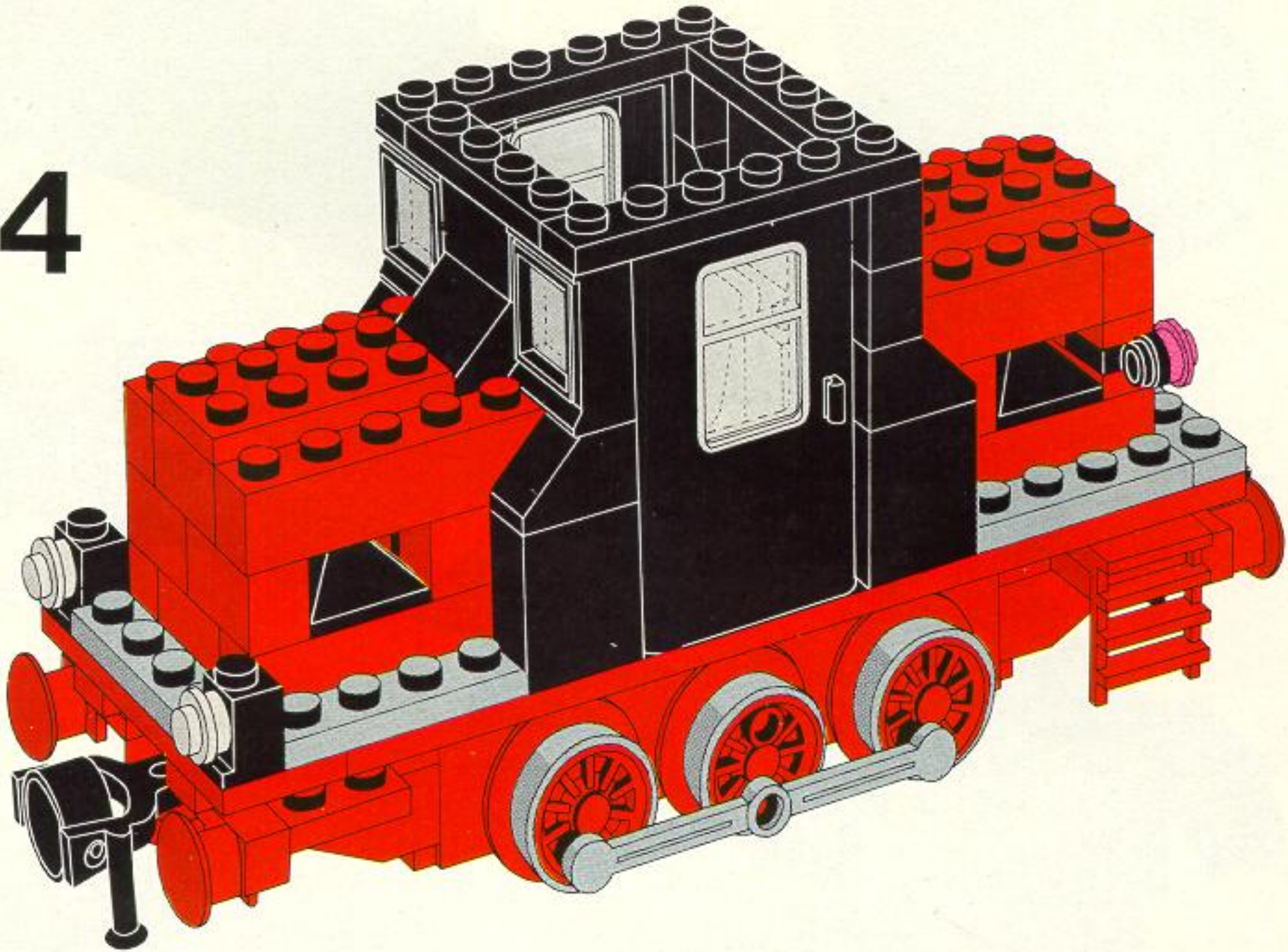

15

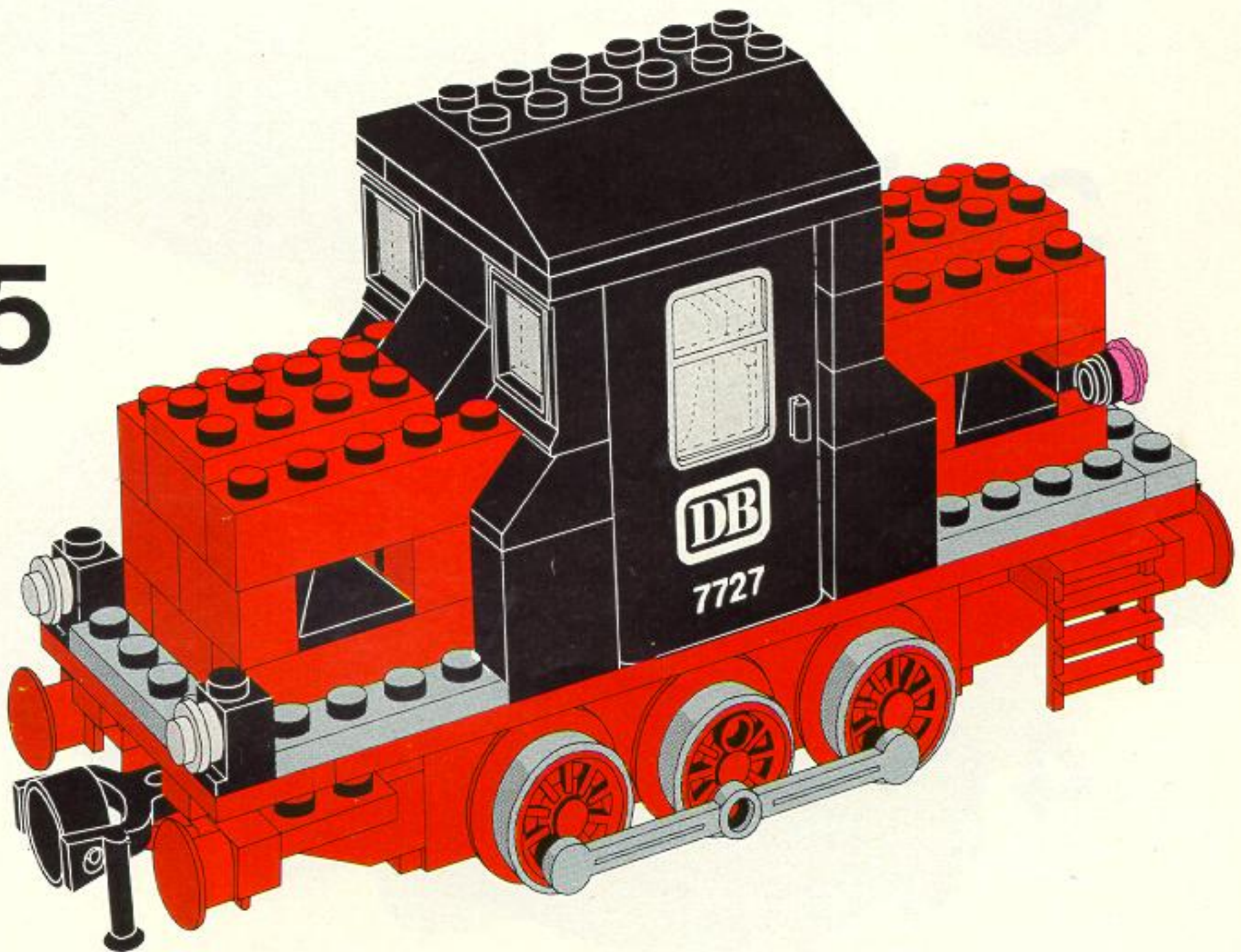

1

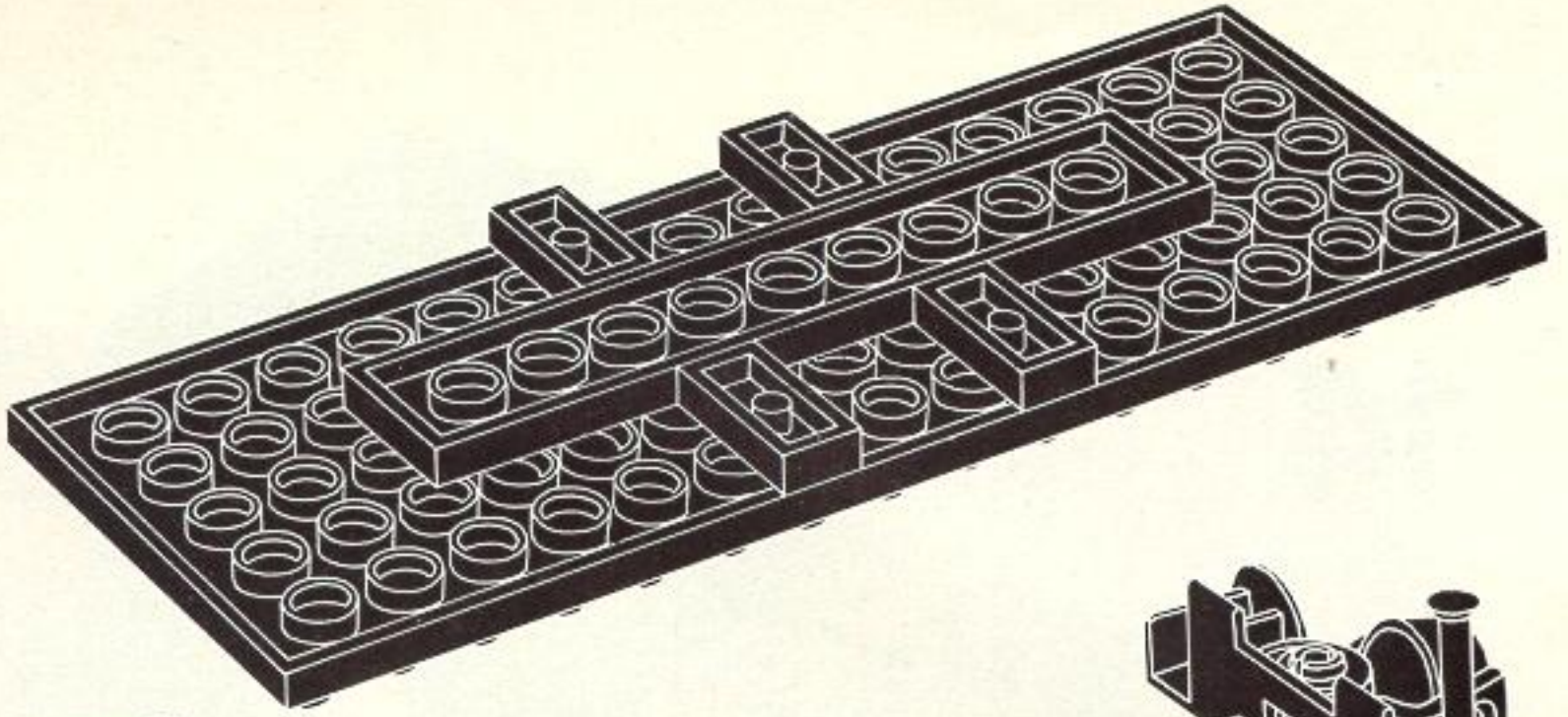

2

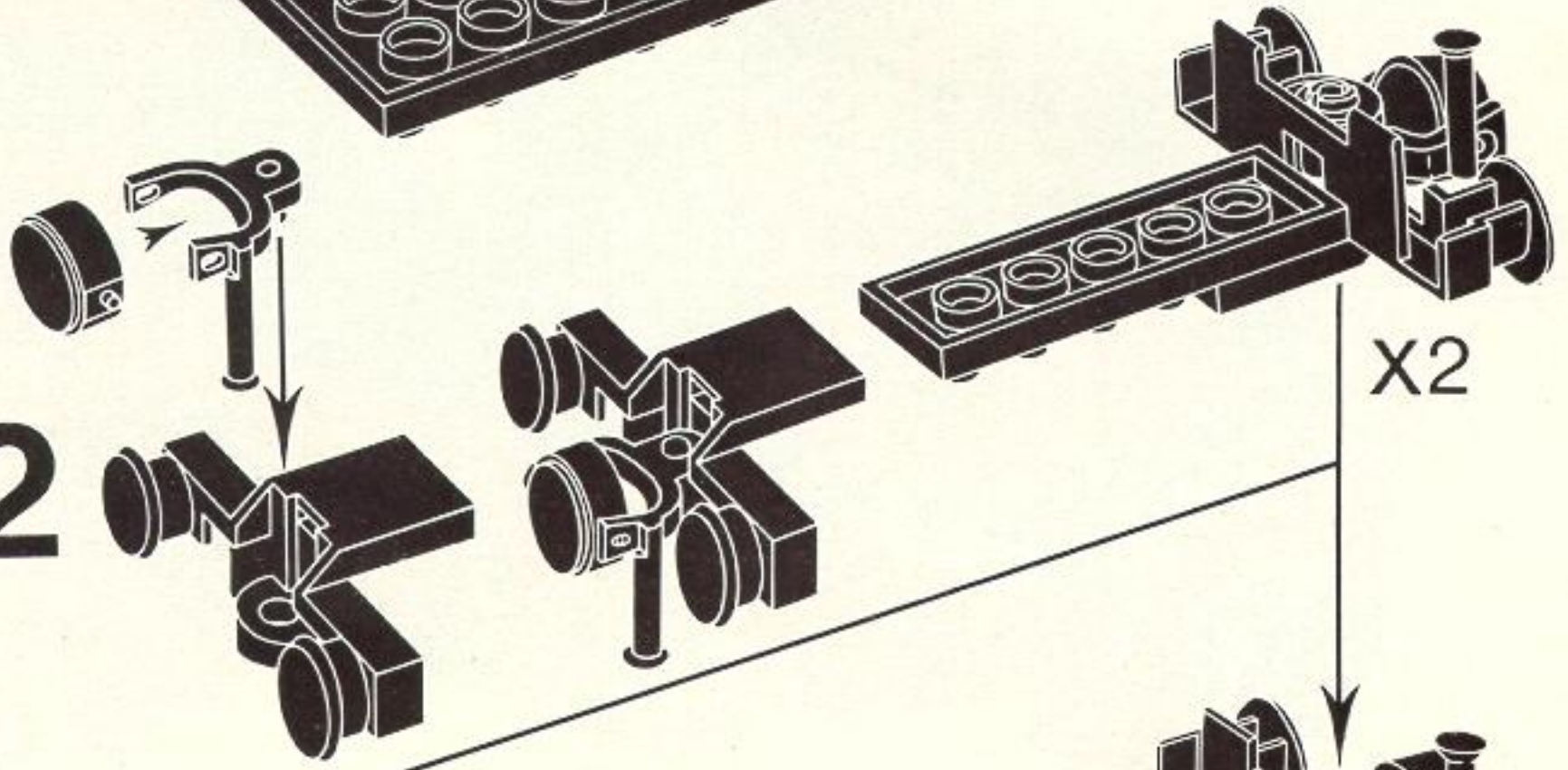

3

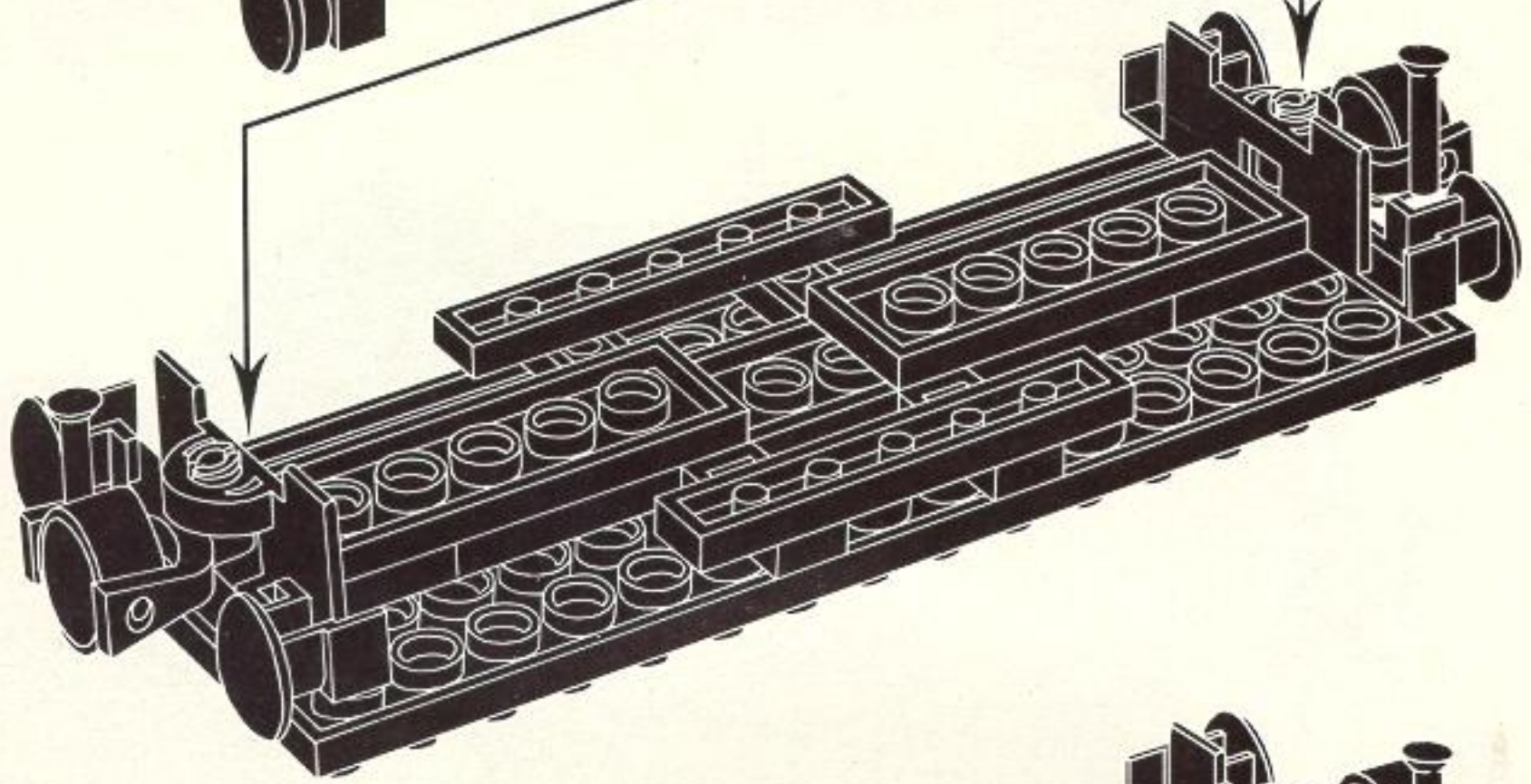

4

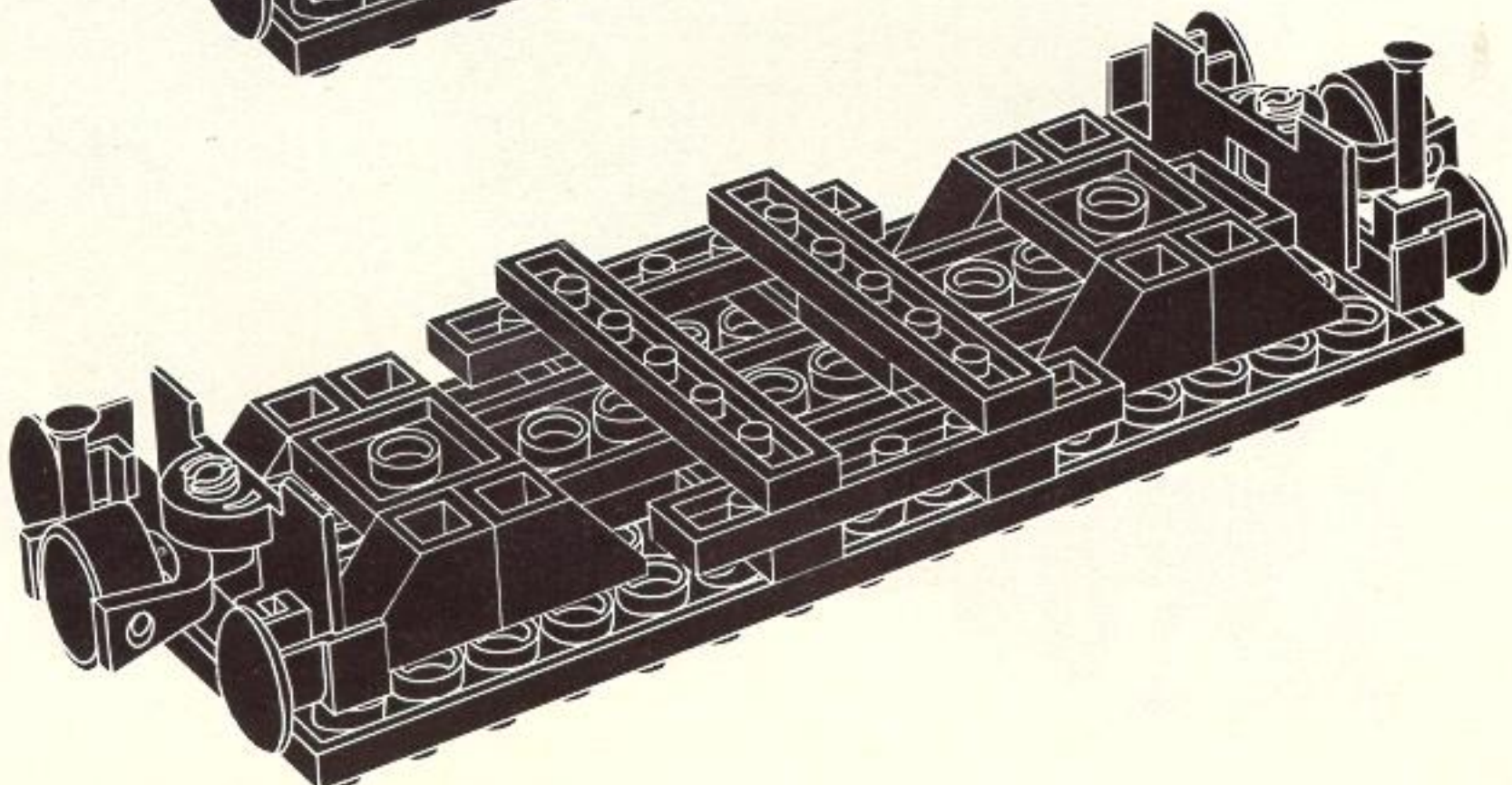

5

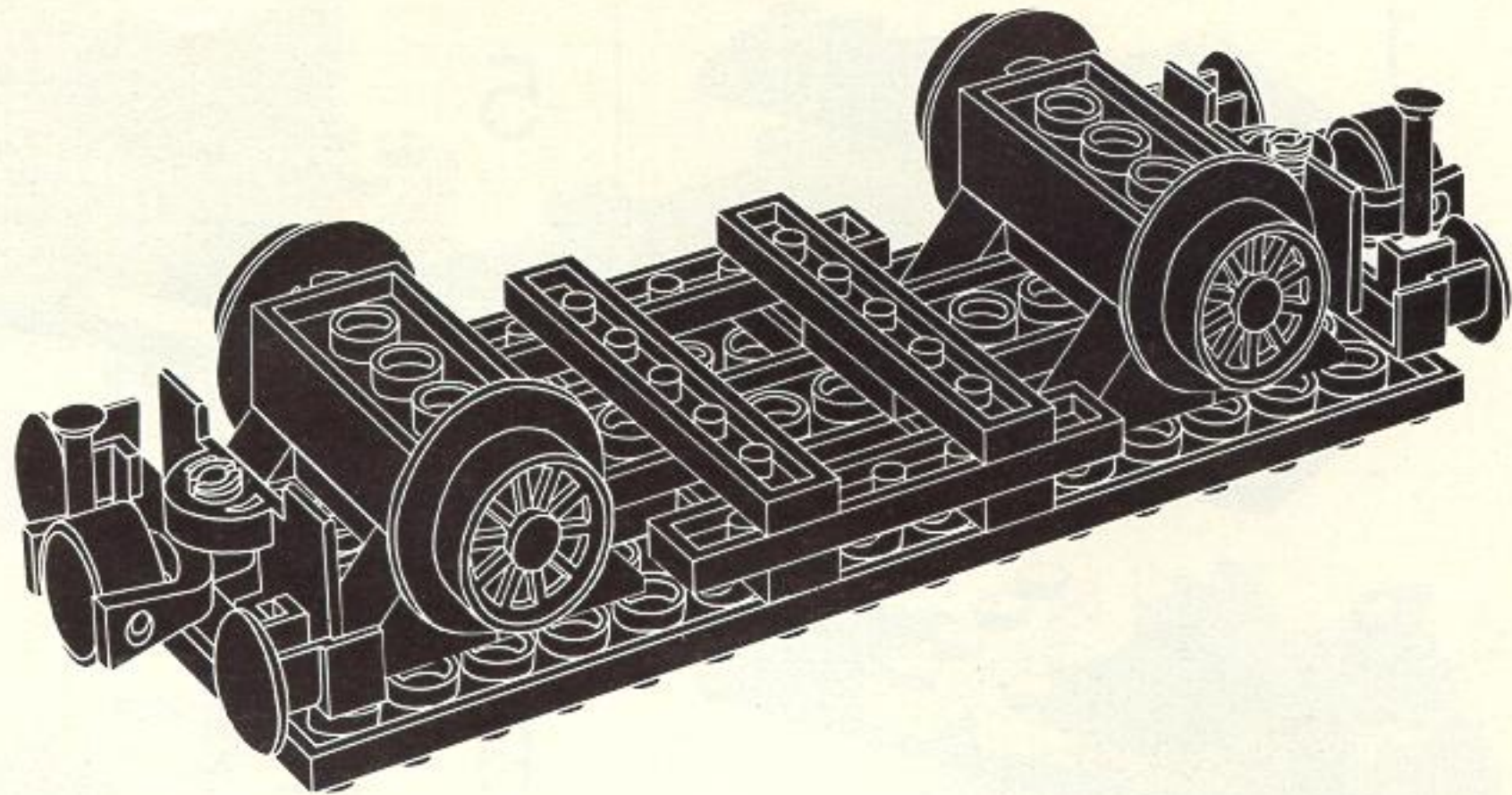

6

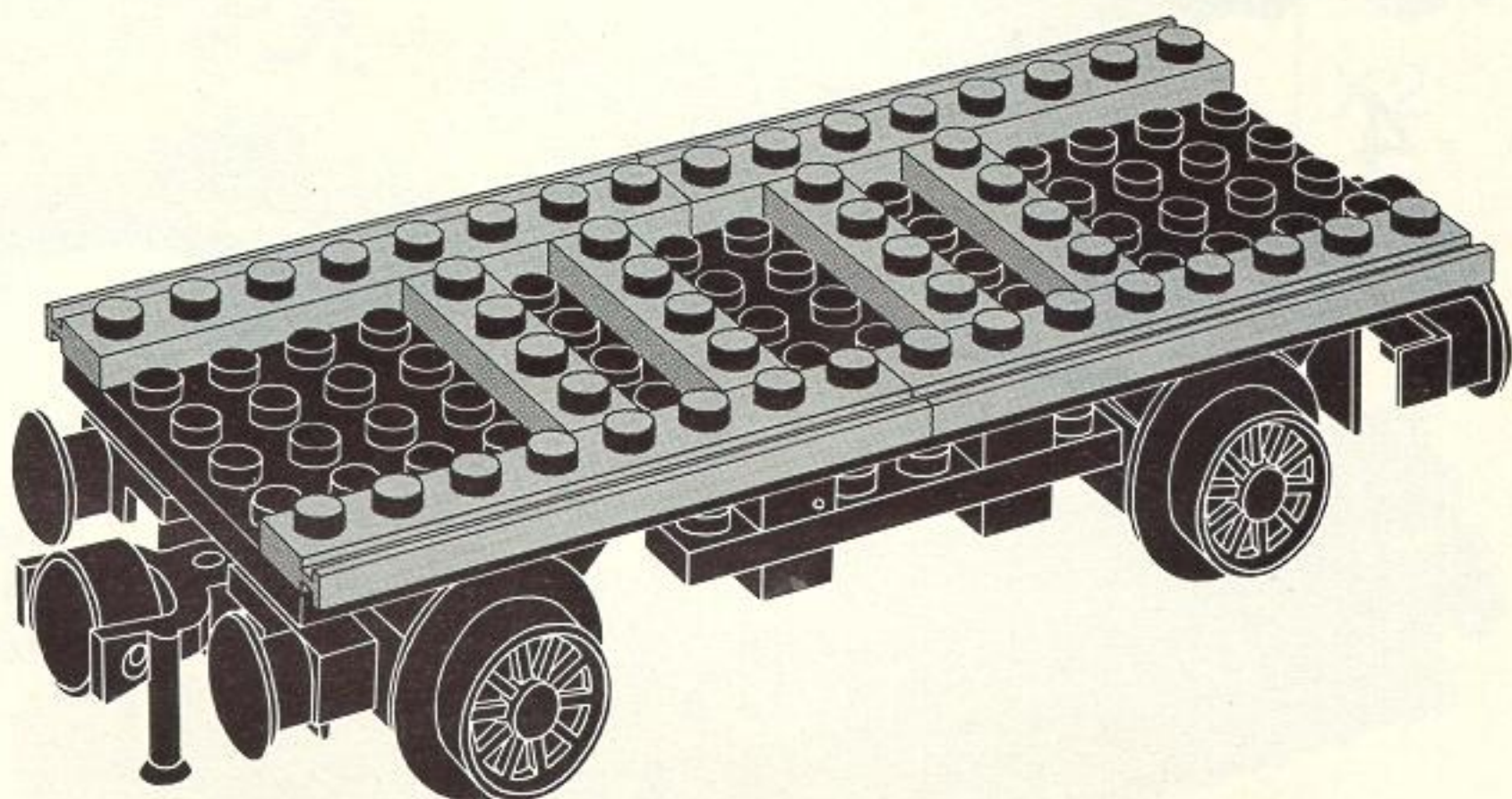

7

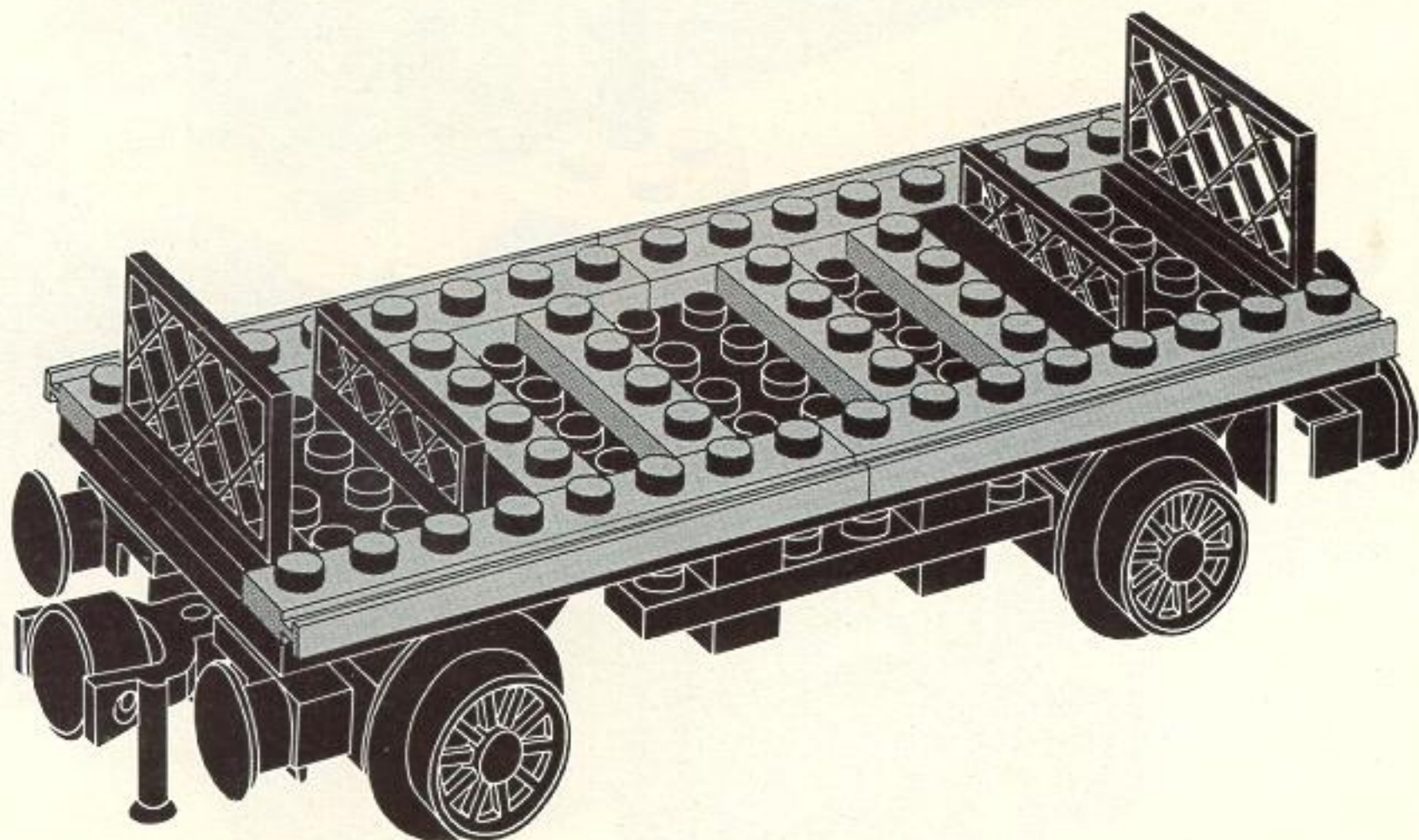

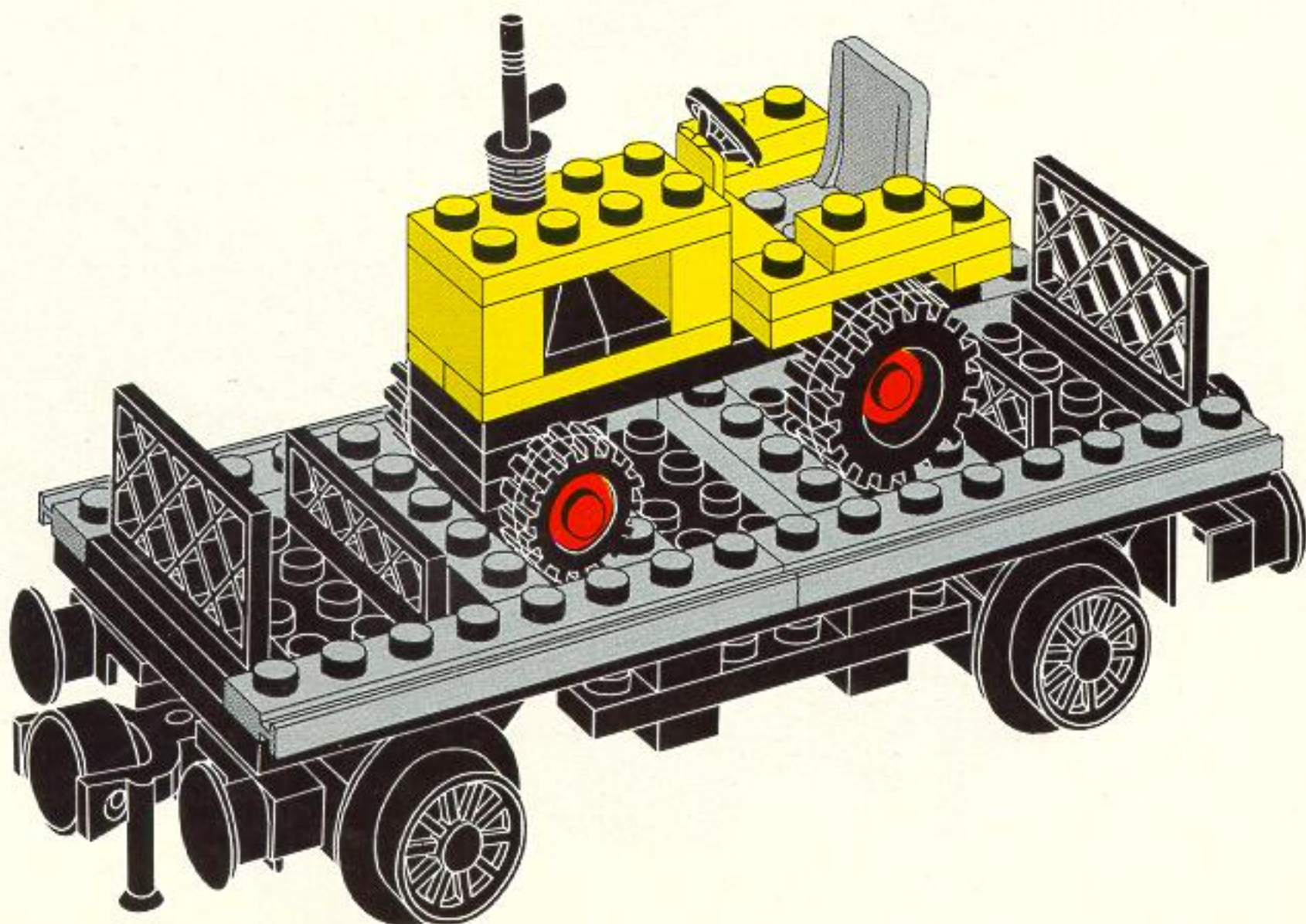
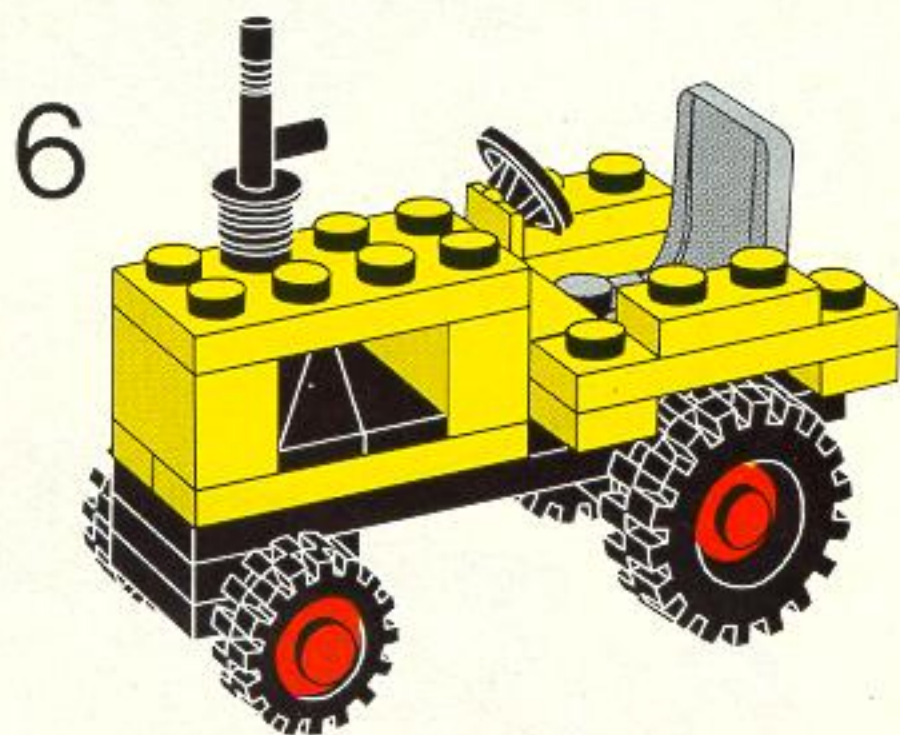
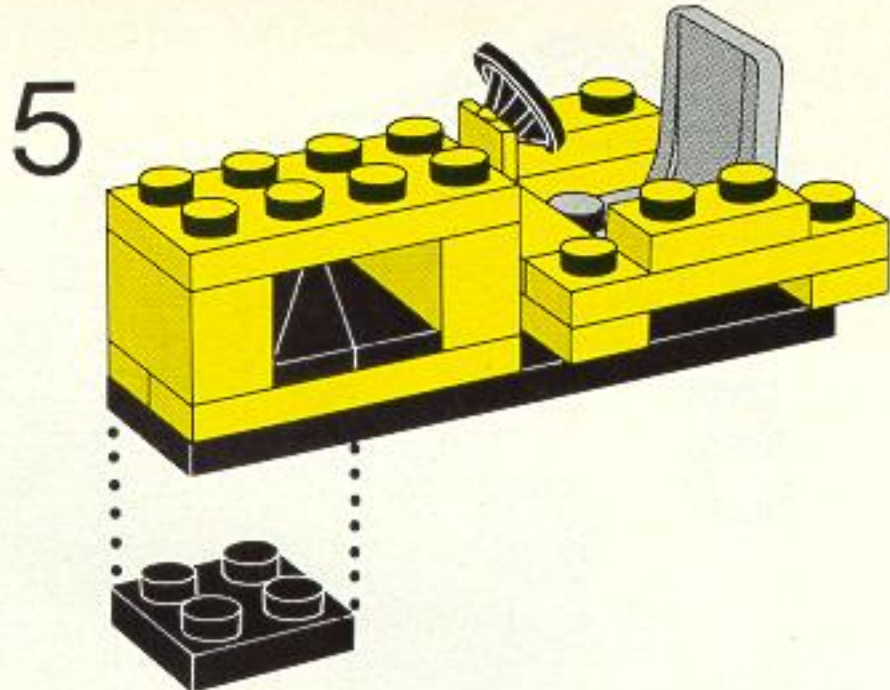
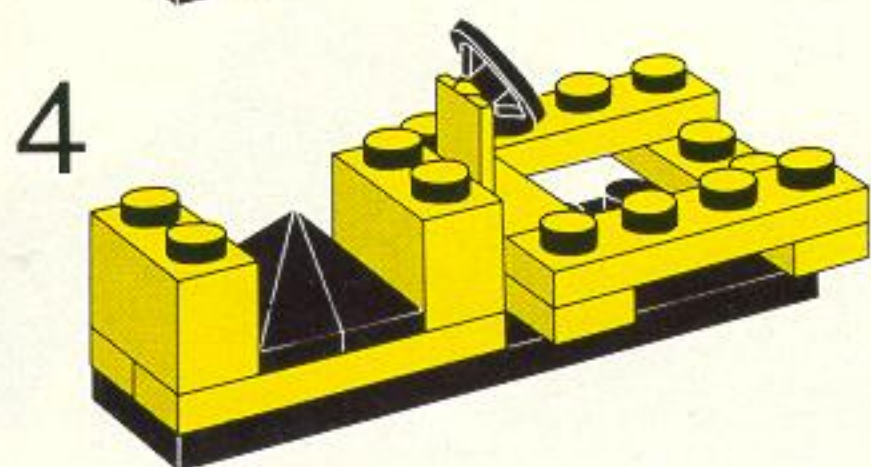
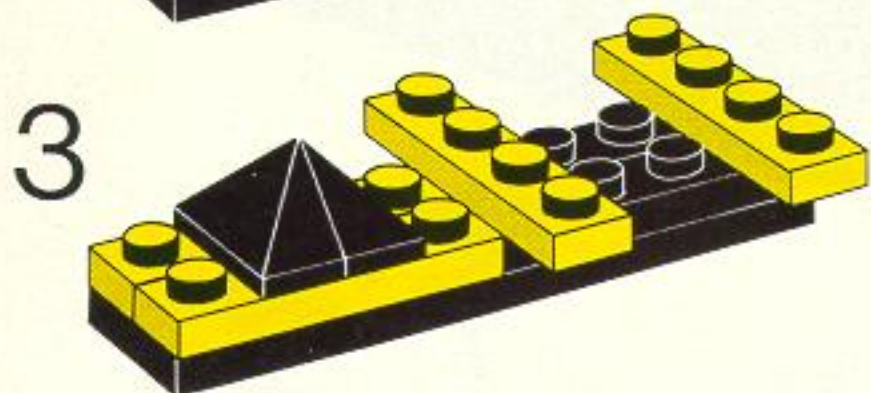
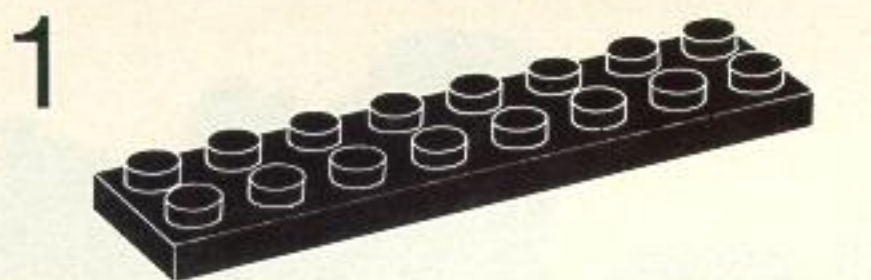

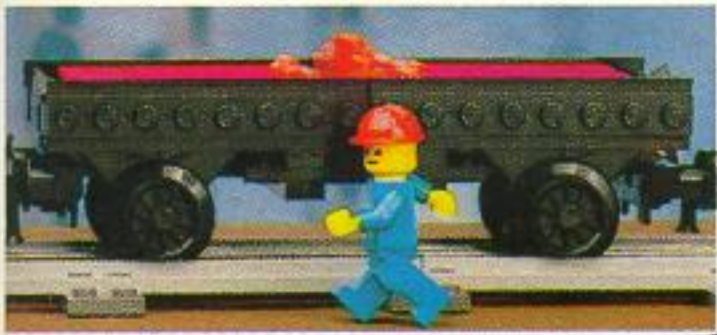

1

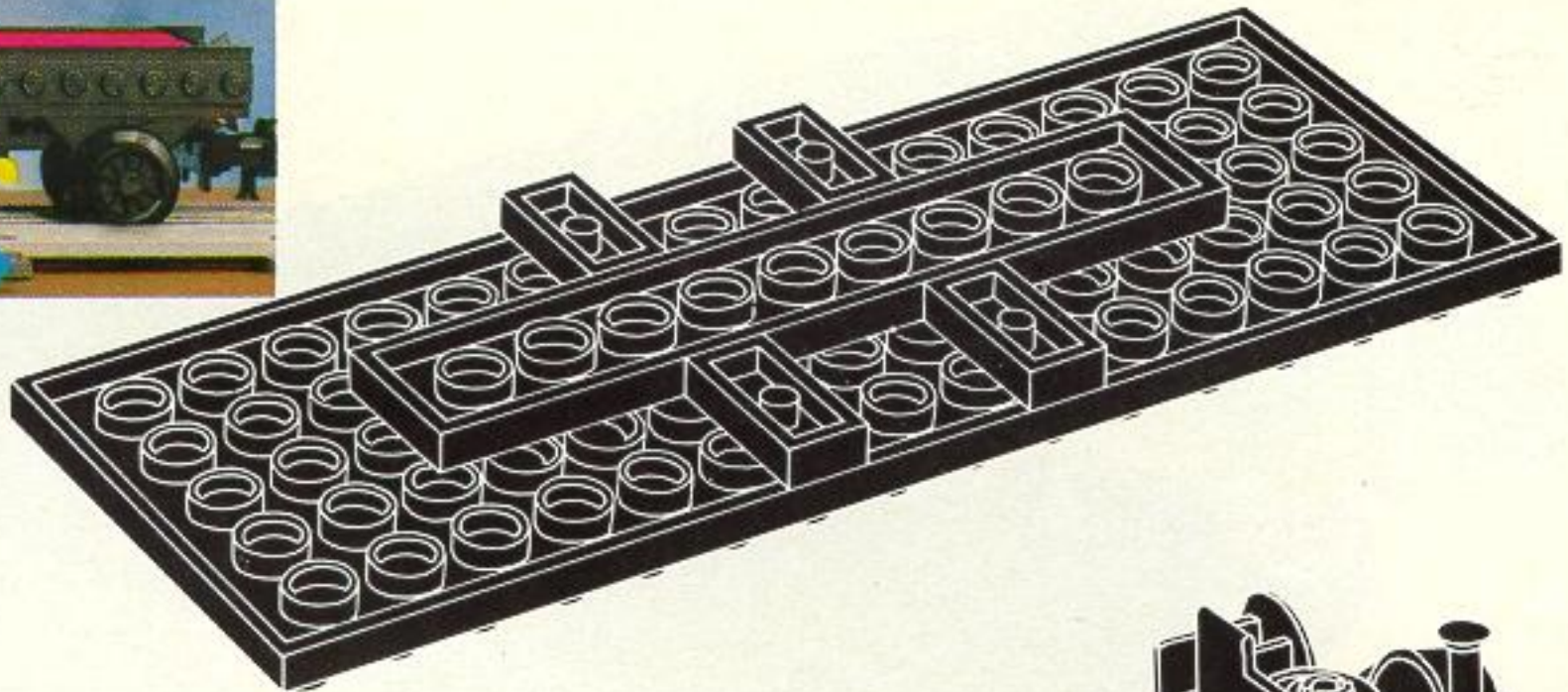

2

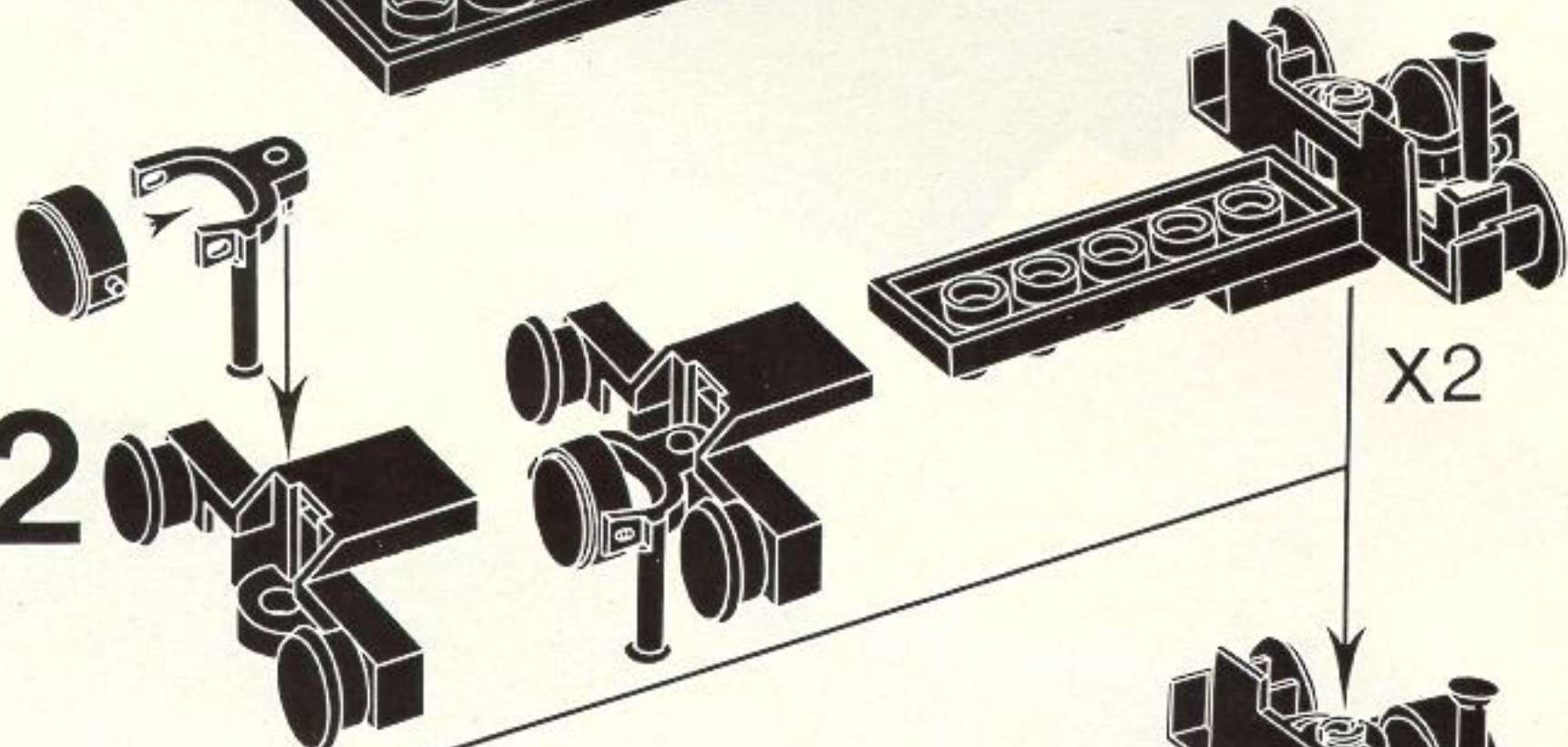

3

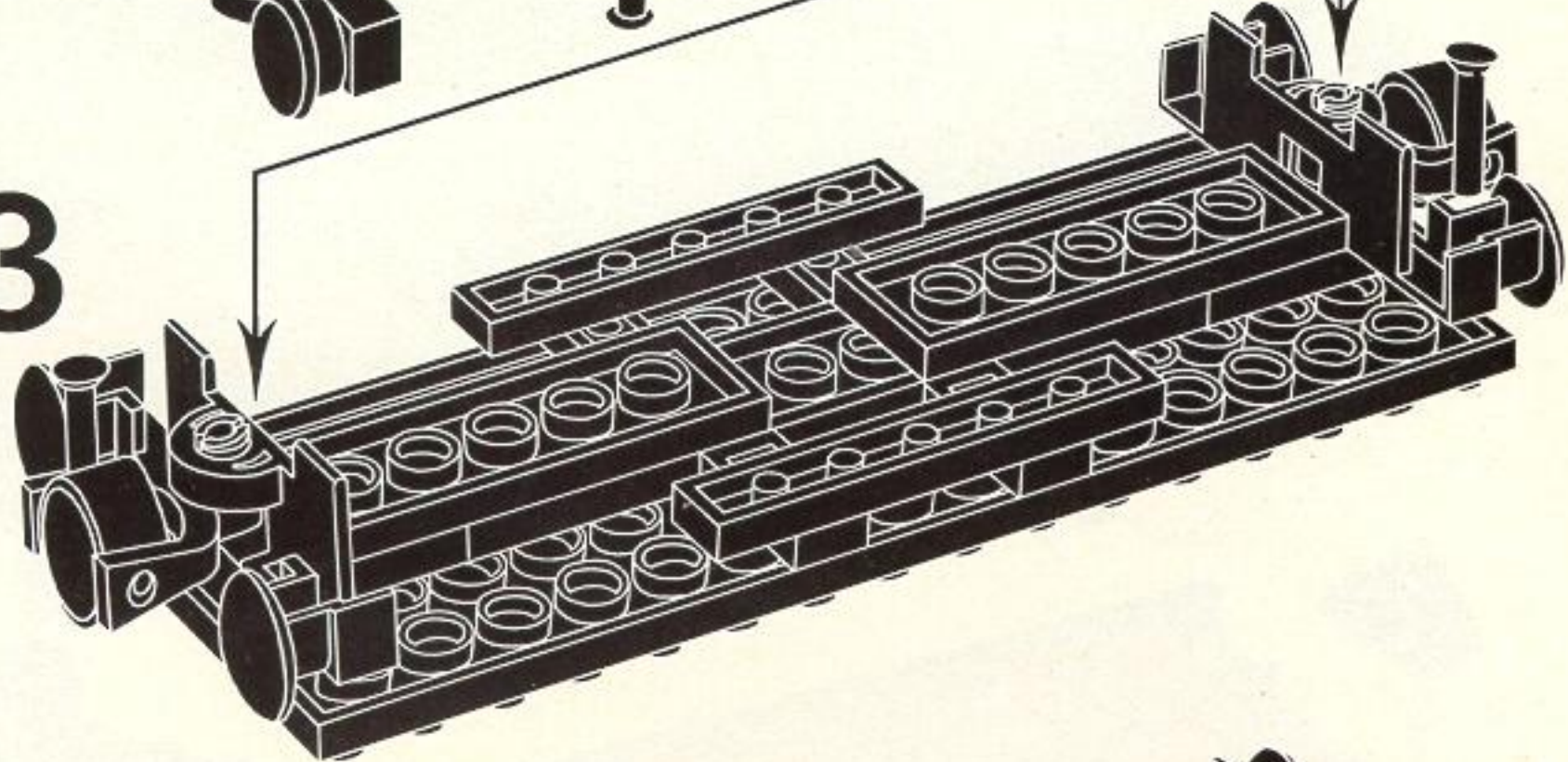

4

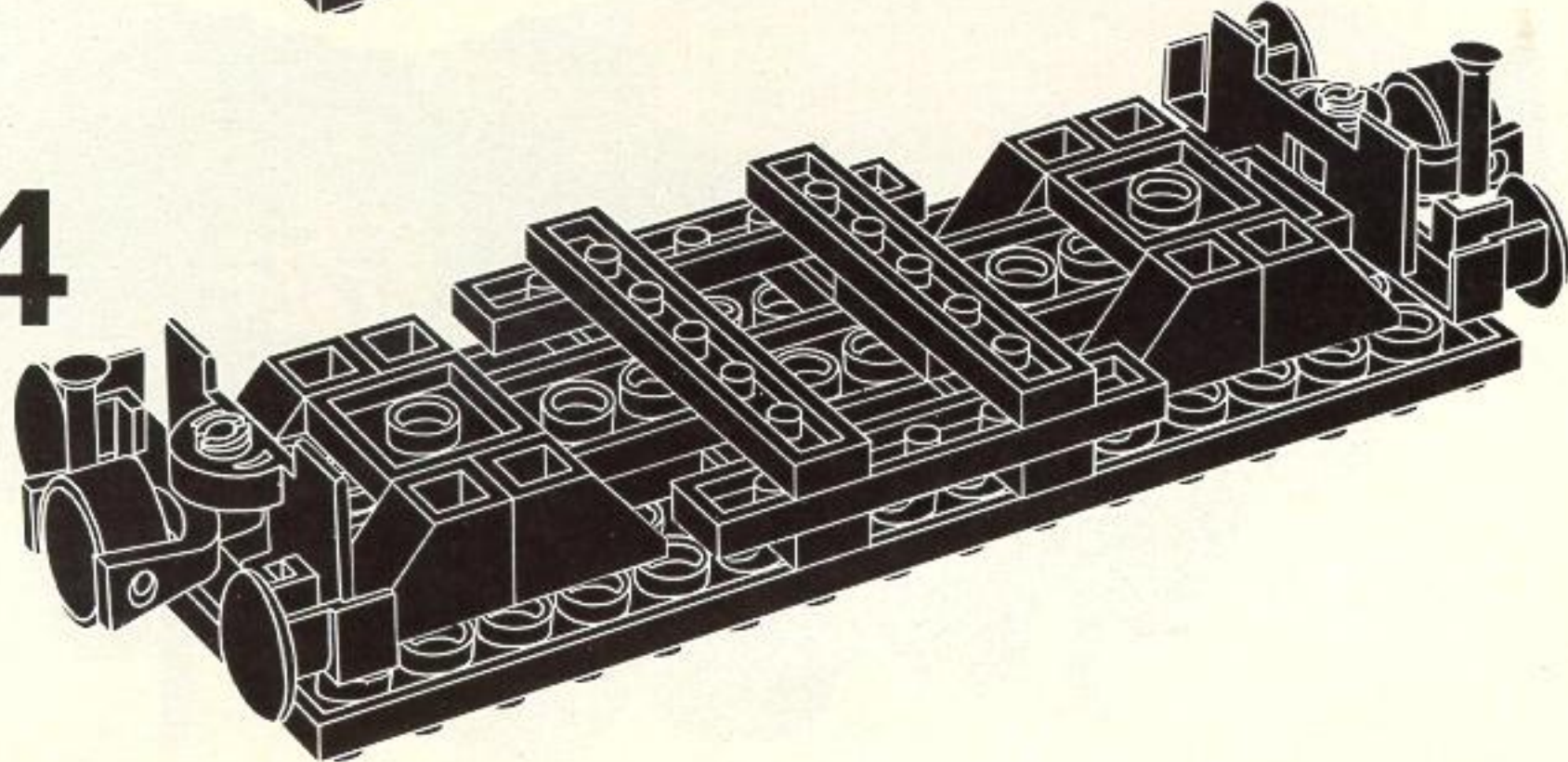

5

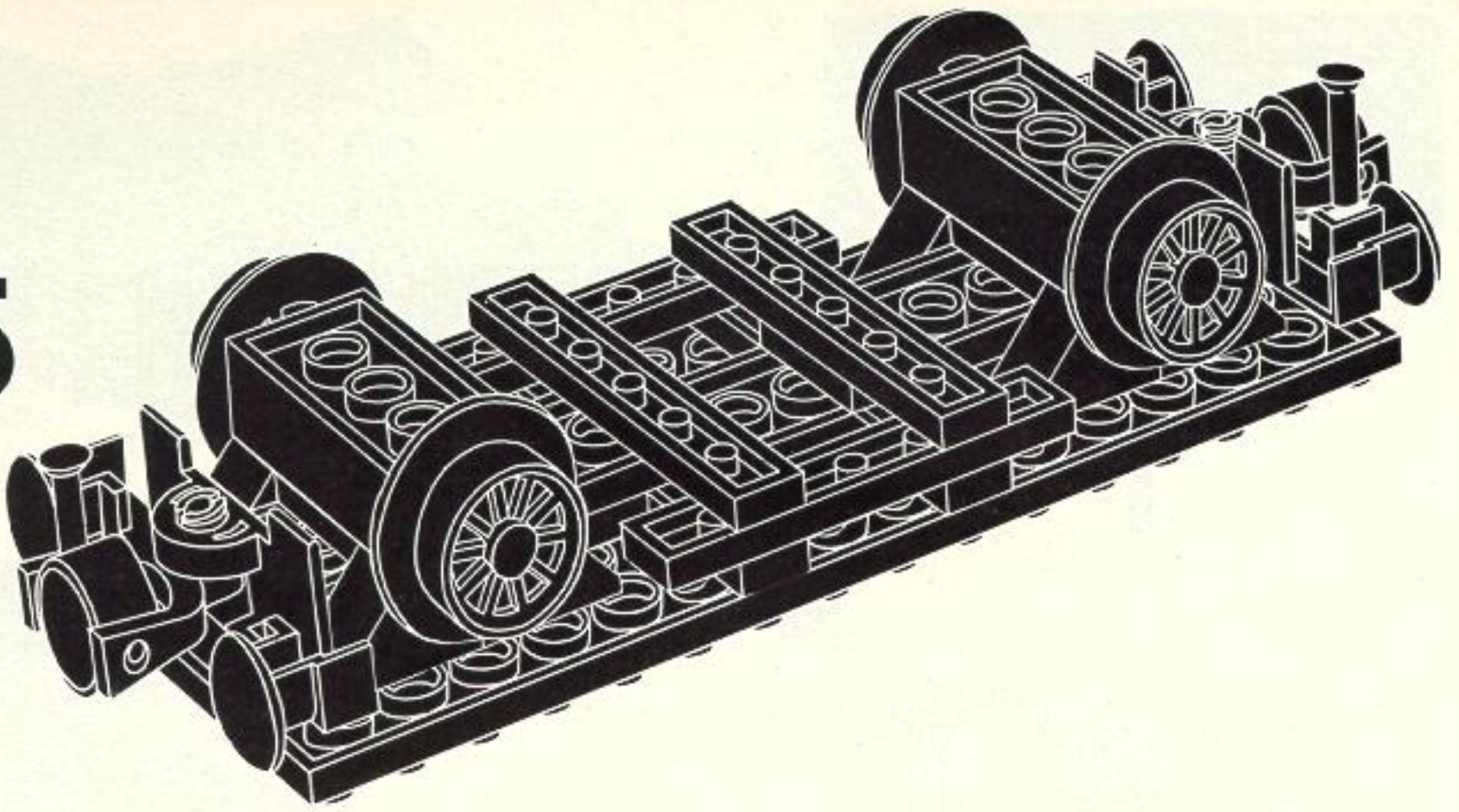

6

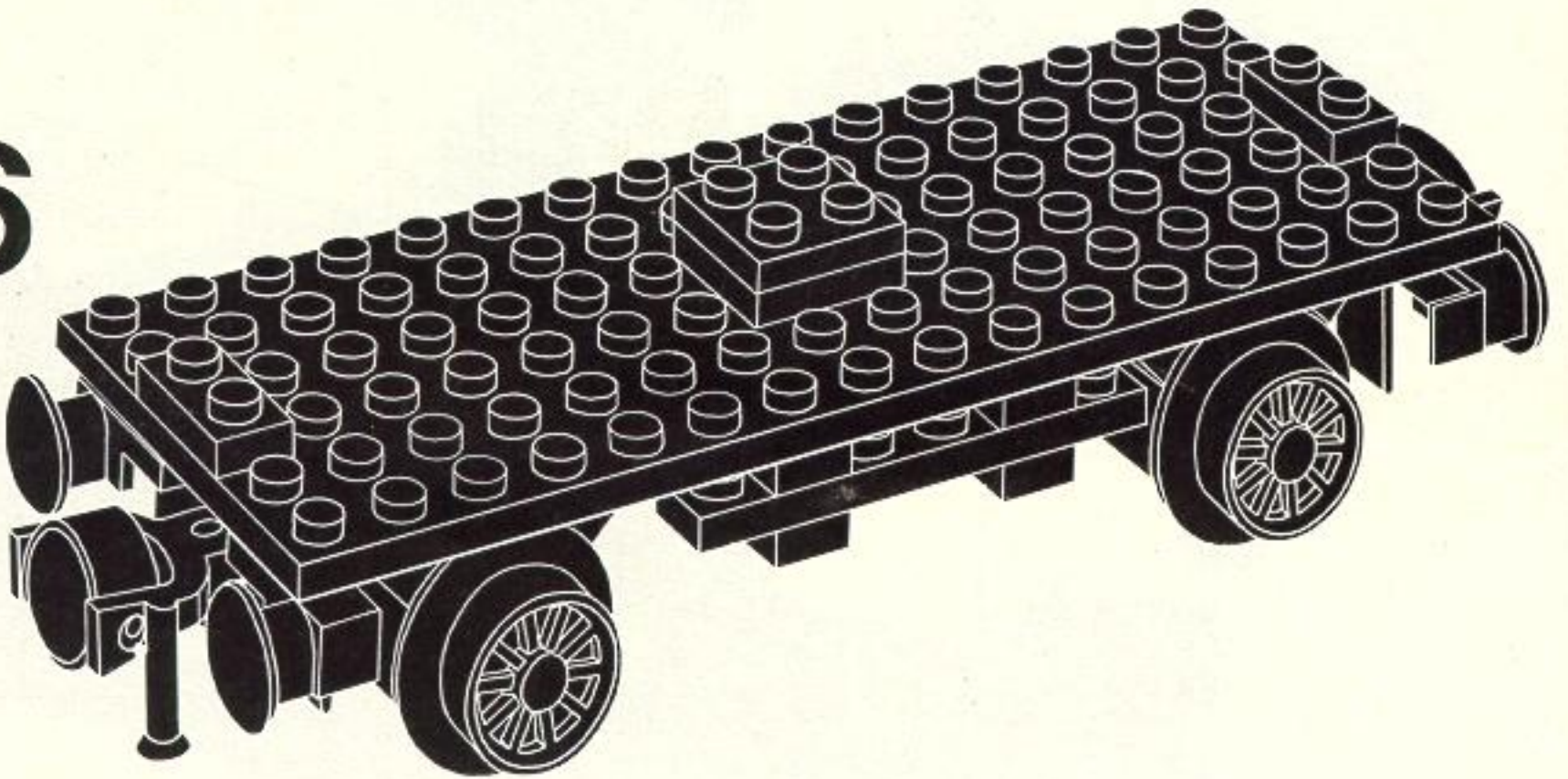

7

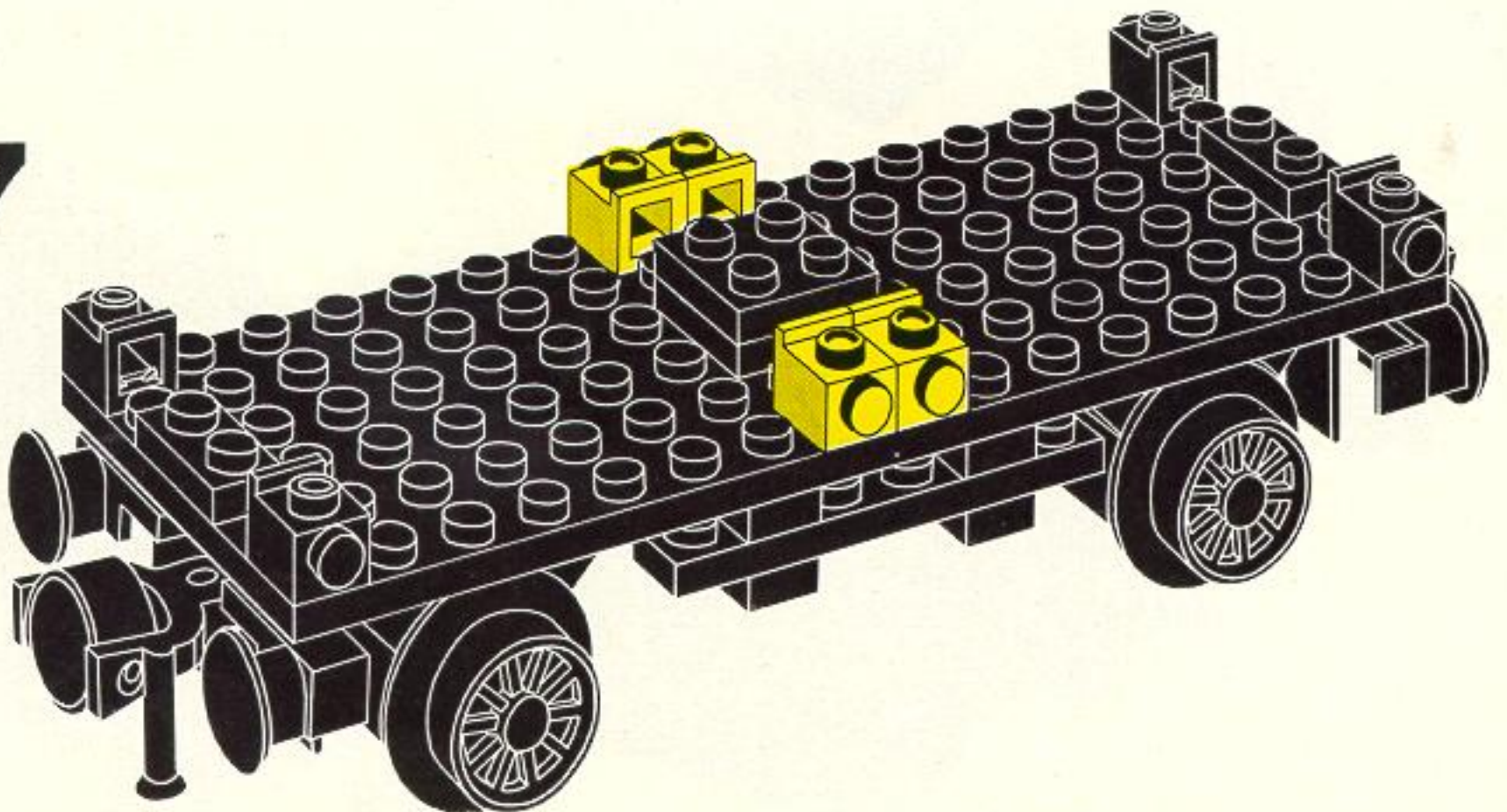

8

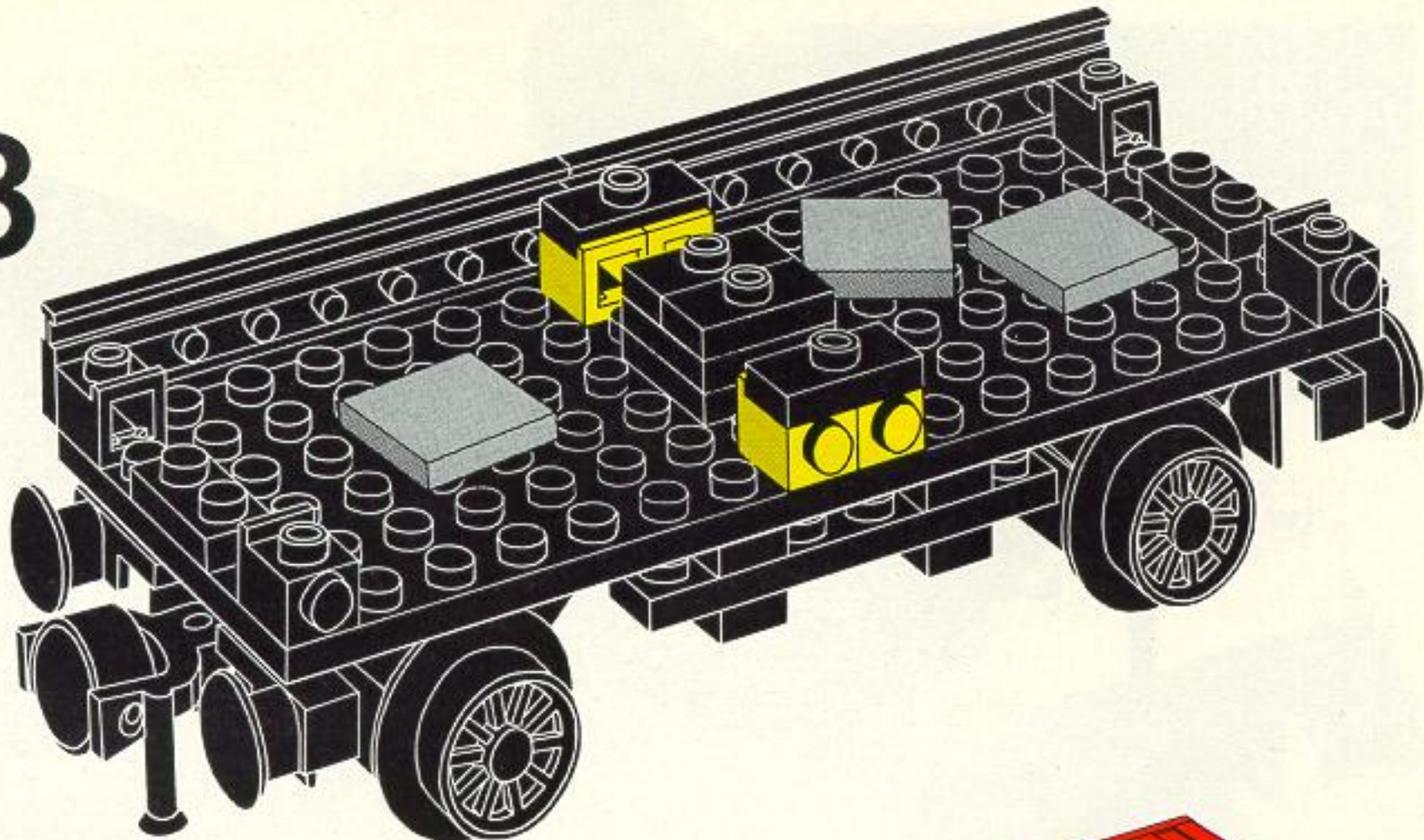

9

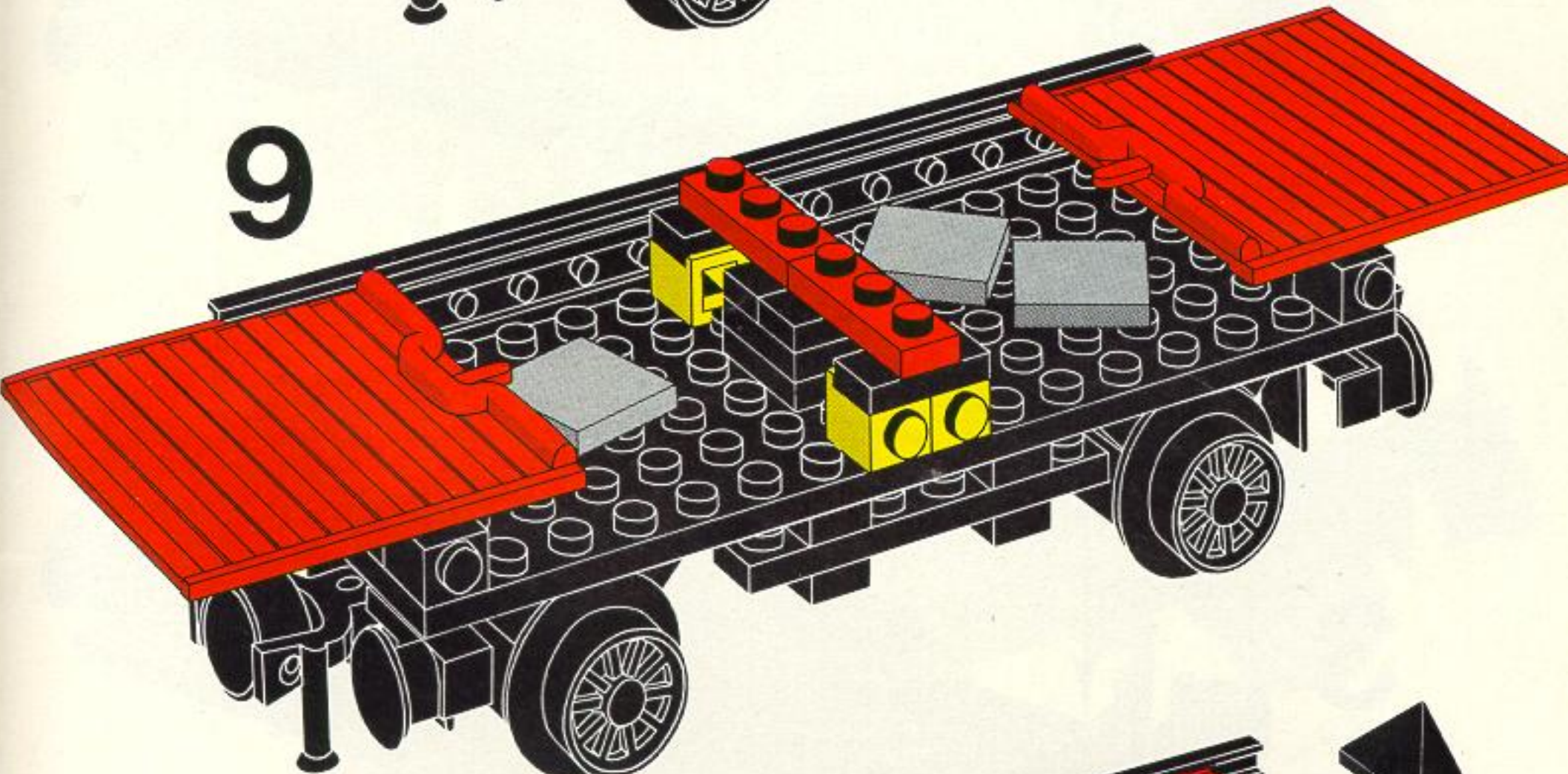

10

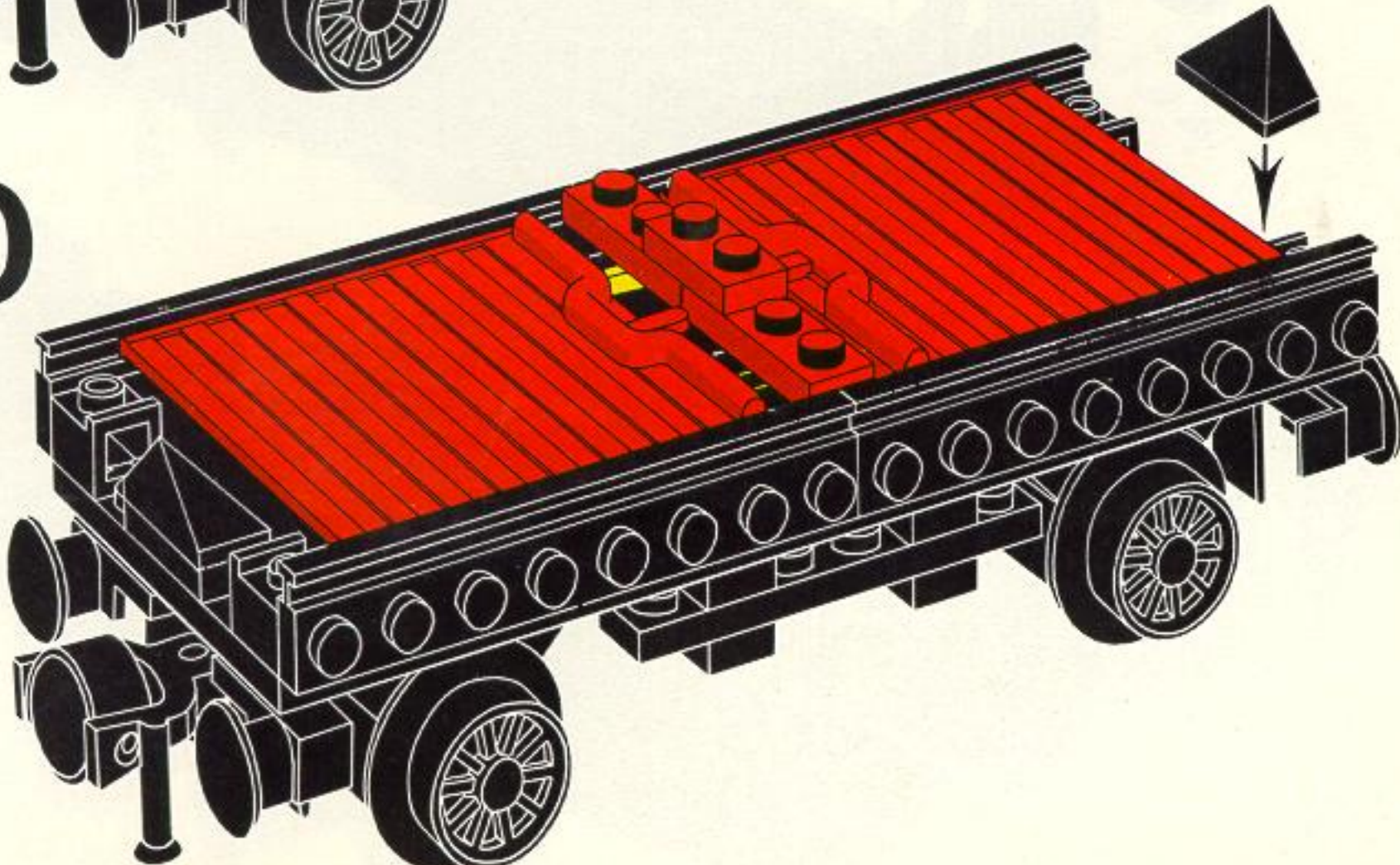

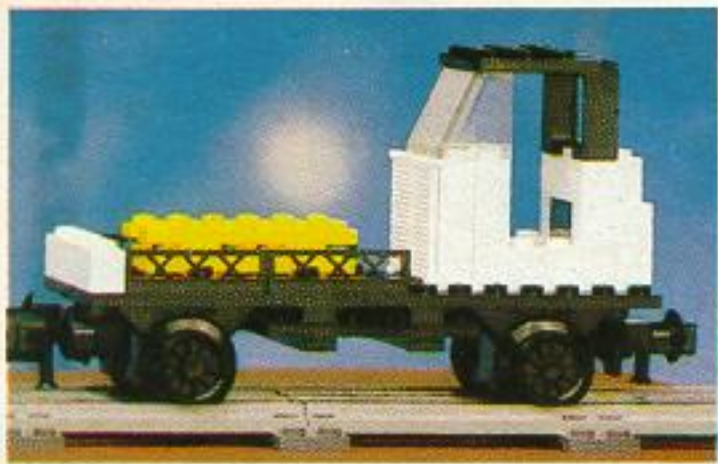

1

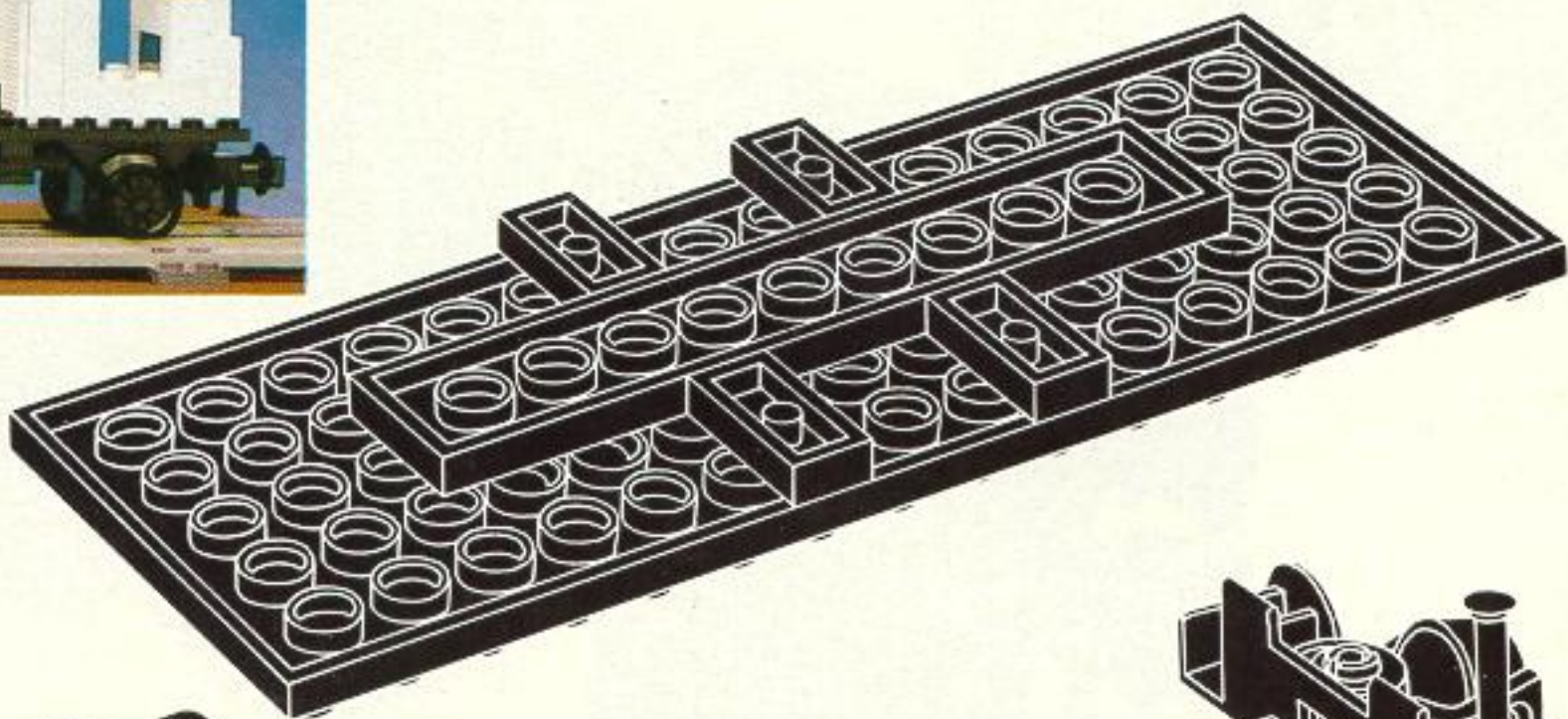

2

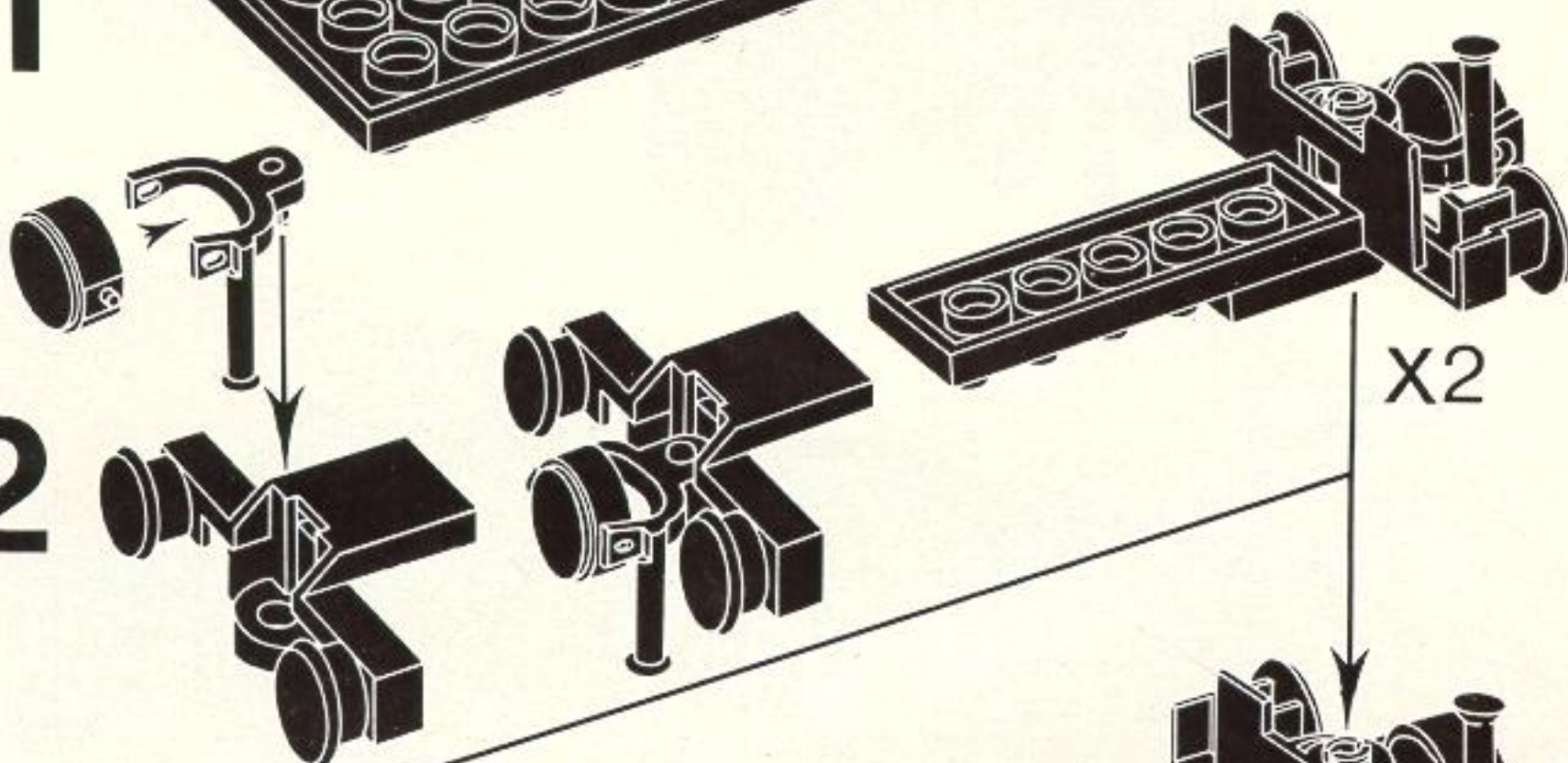

3

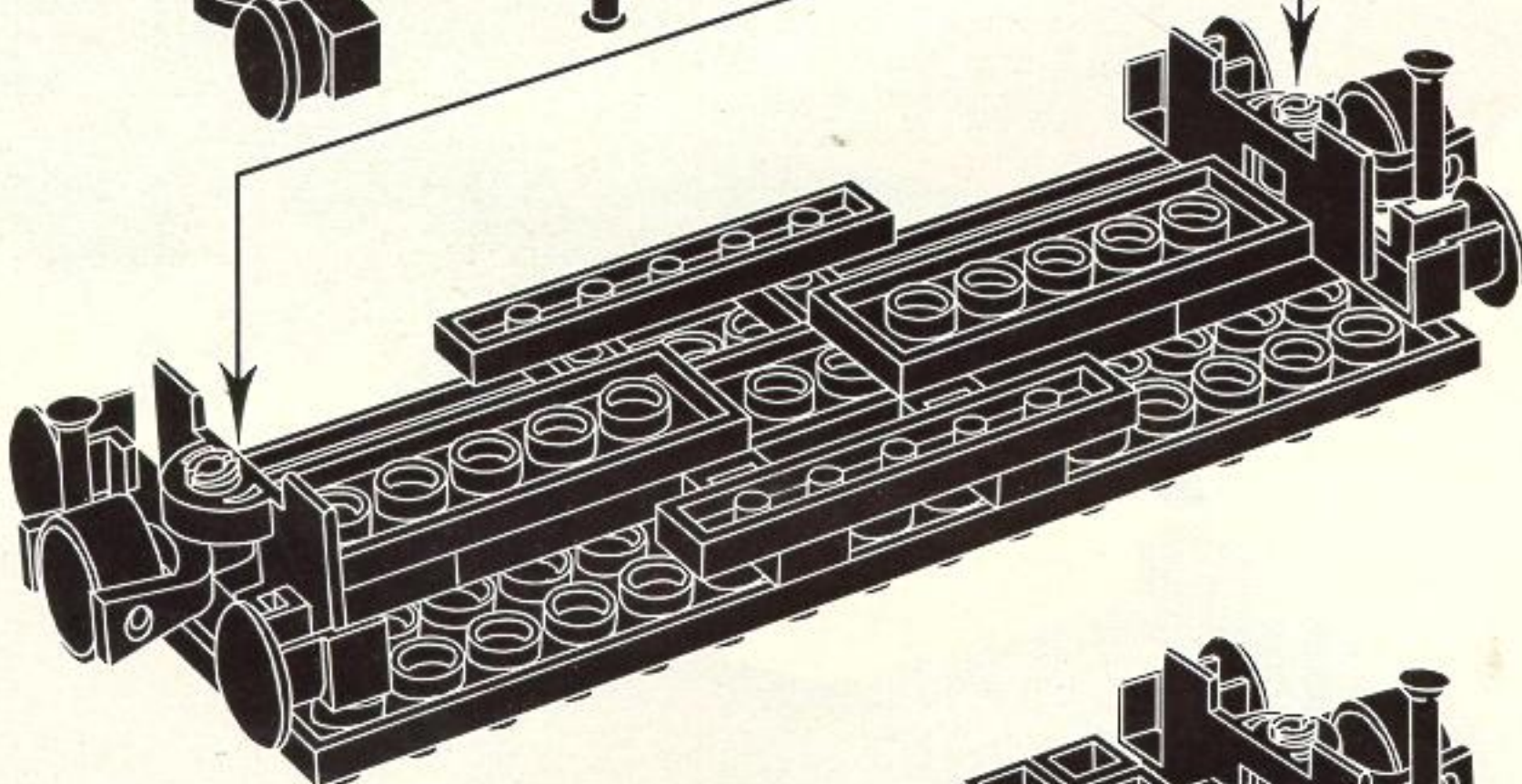

4

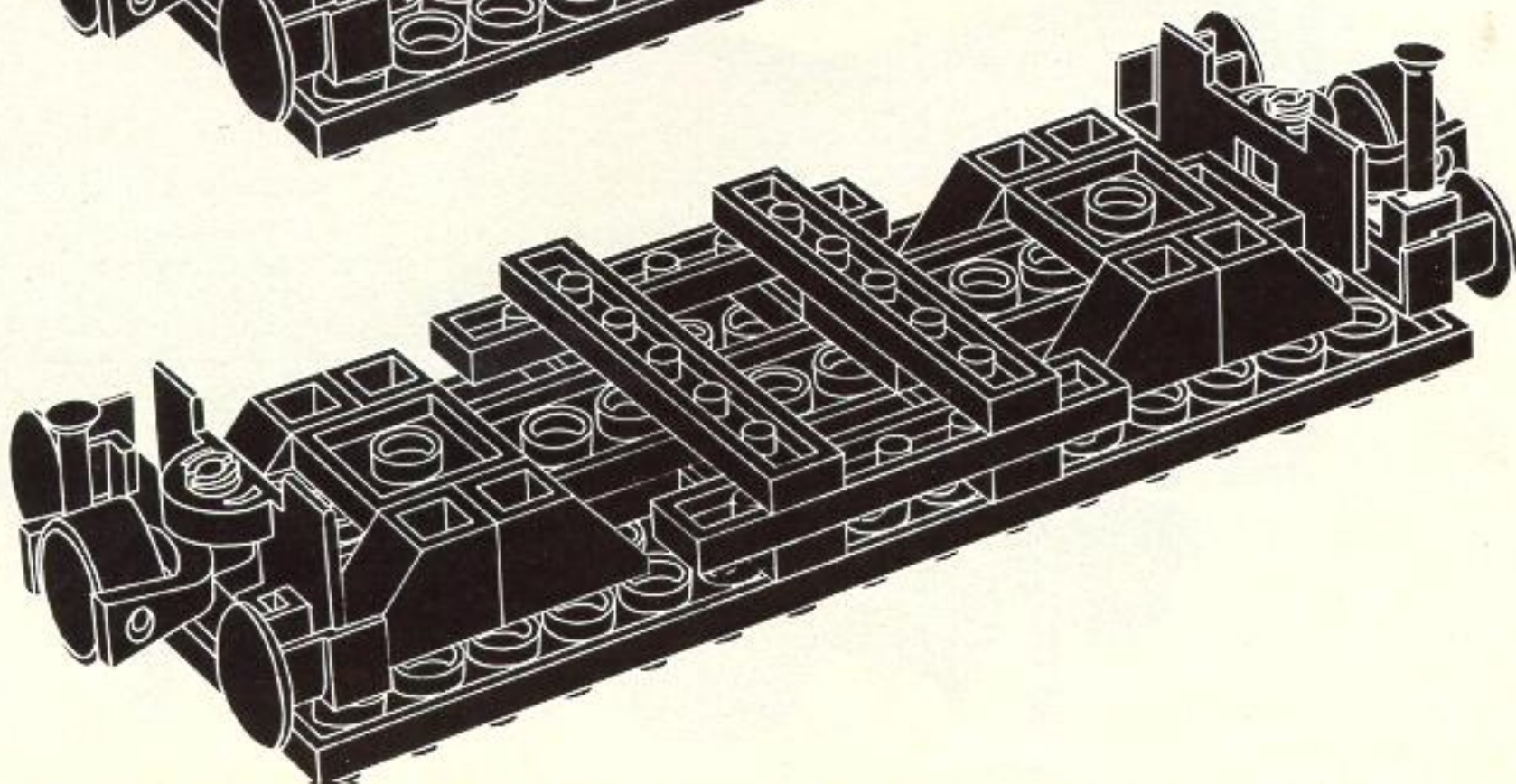

5

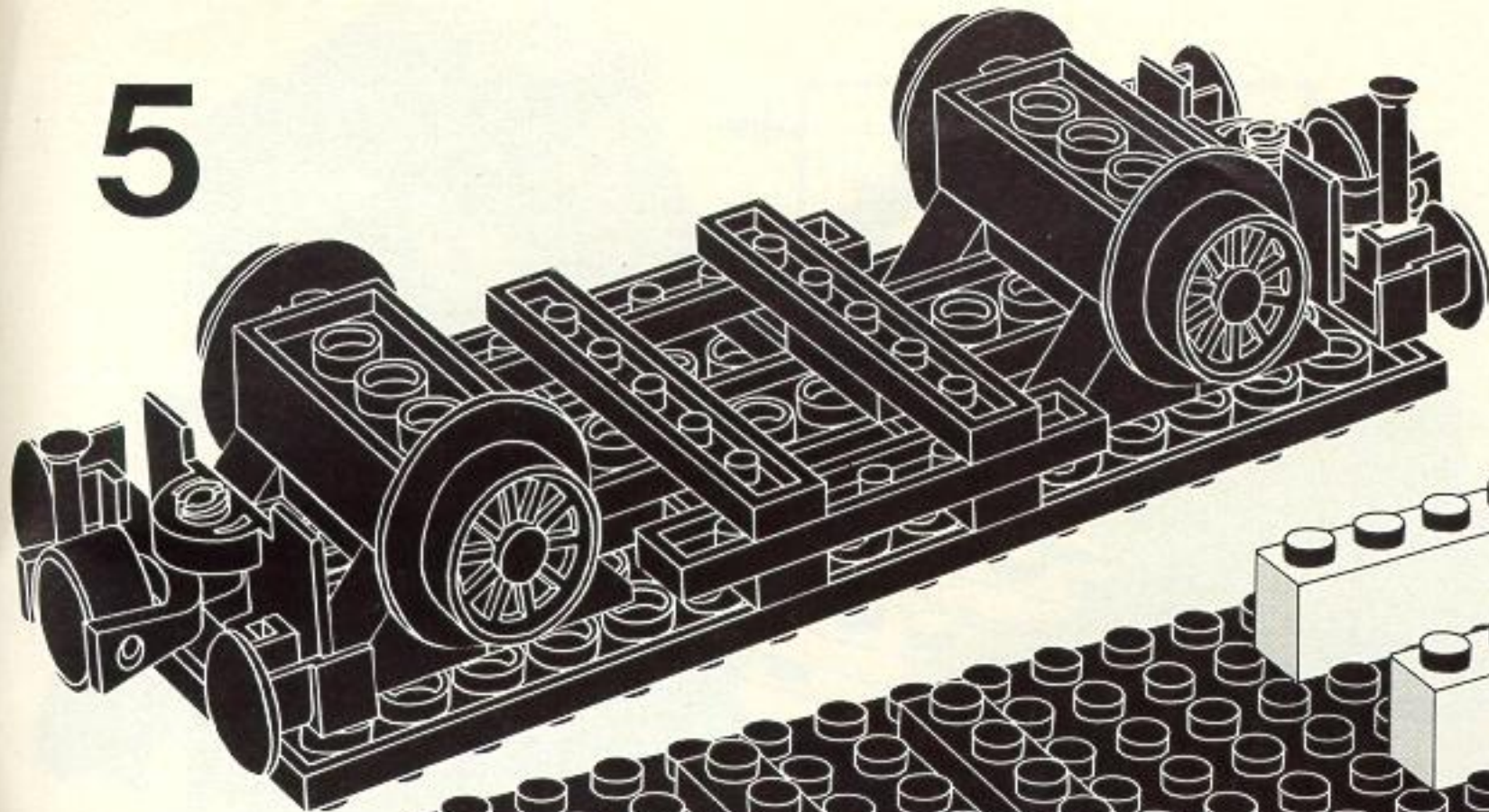

6

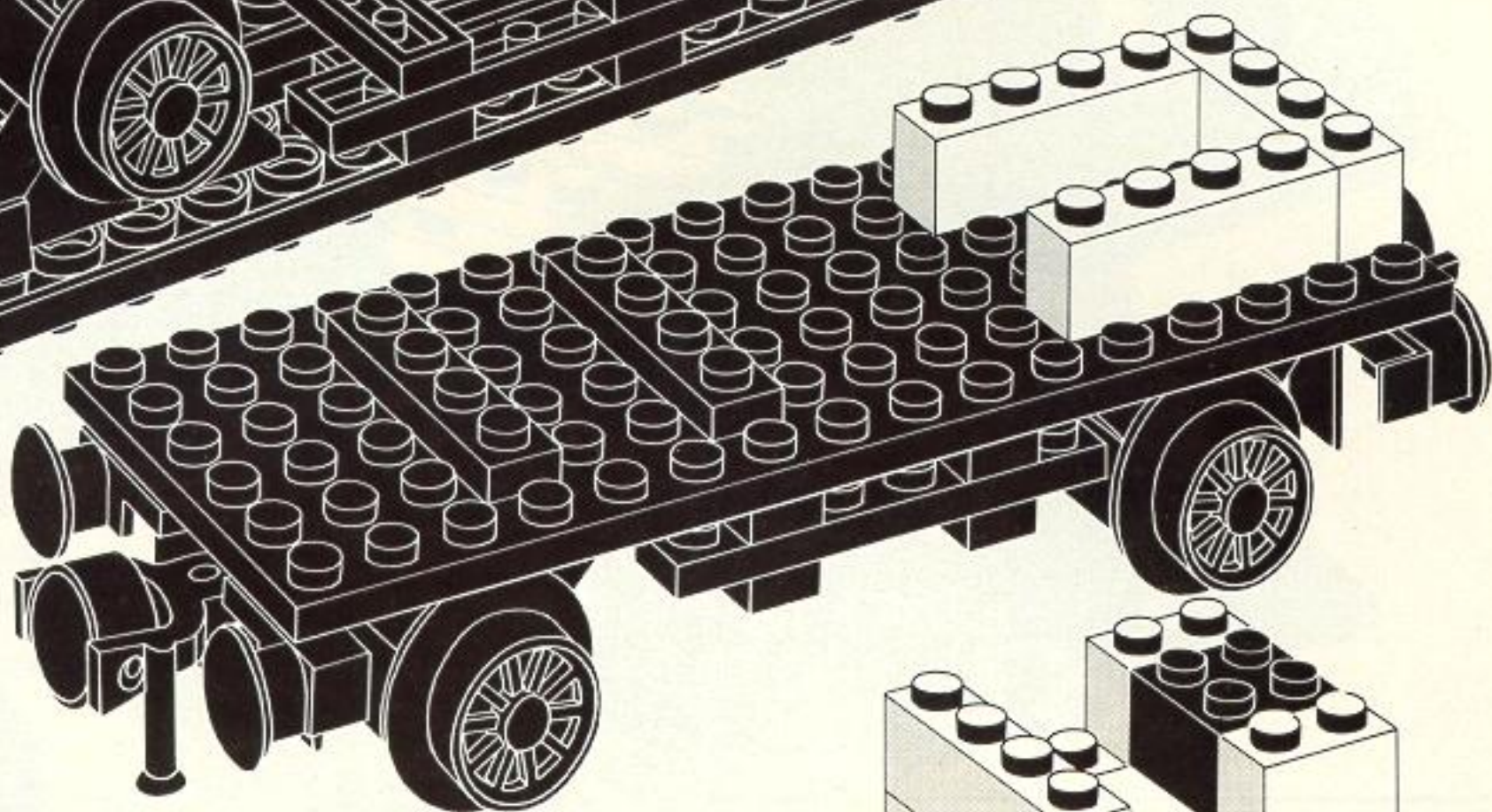

7

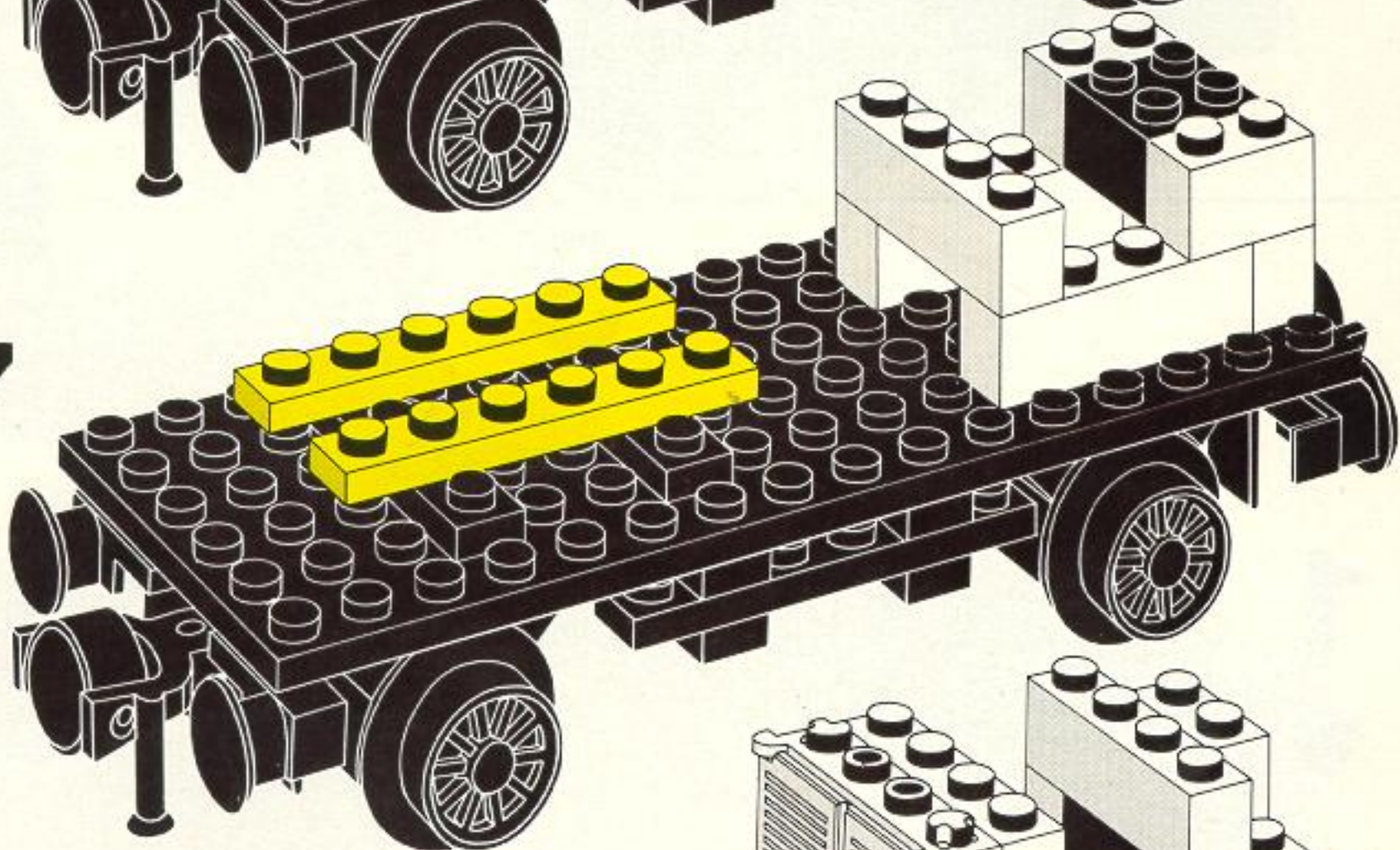

8

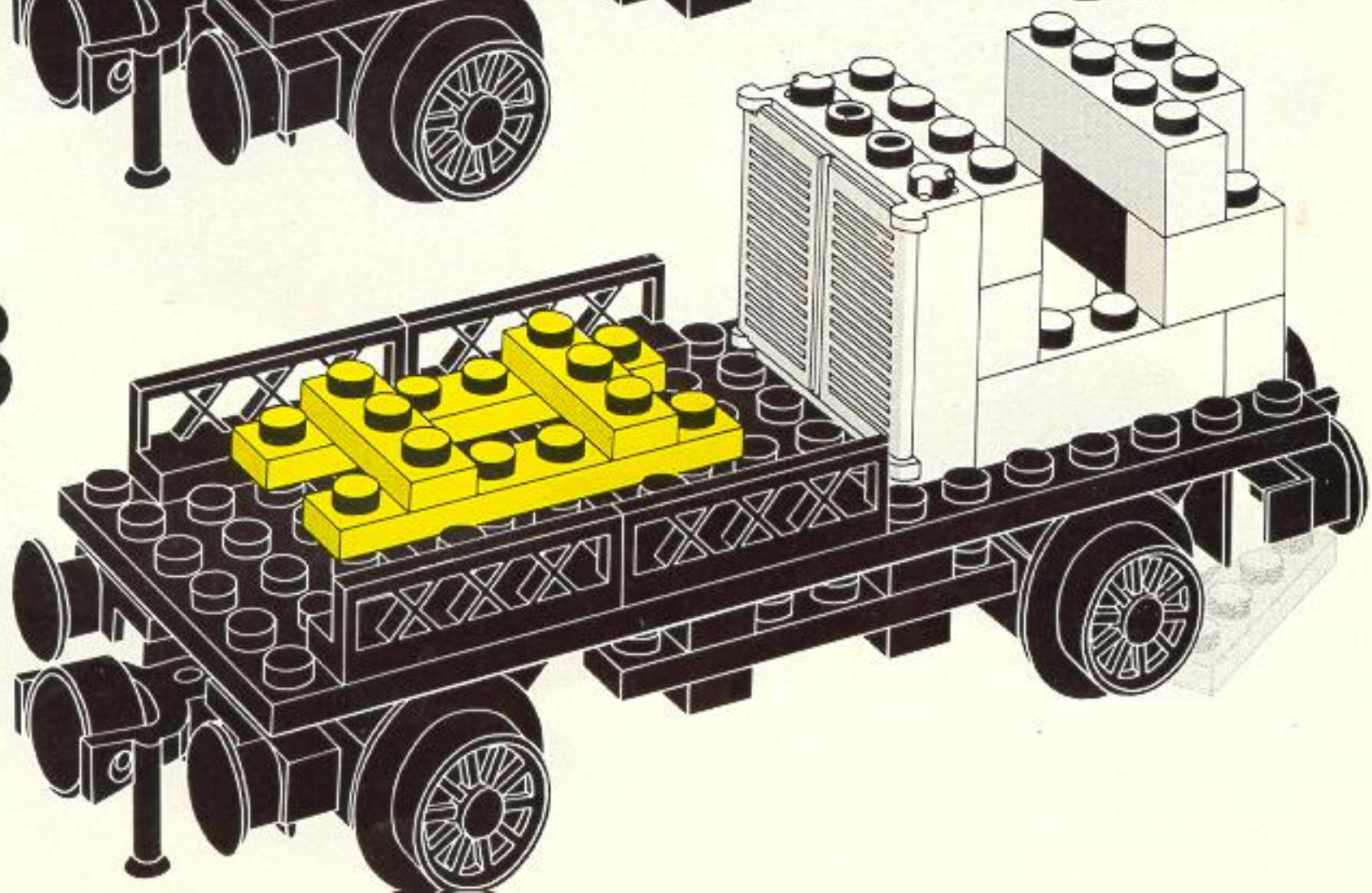

9

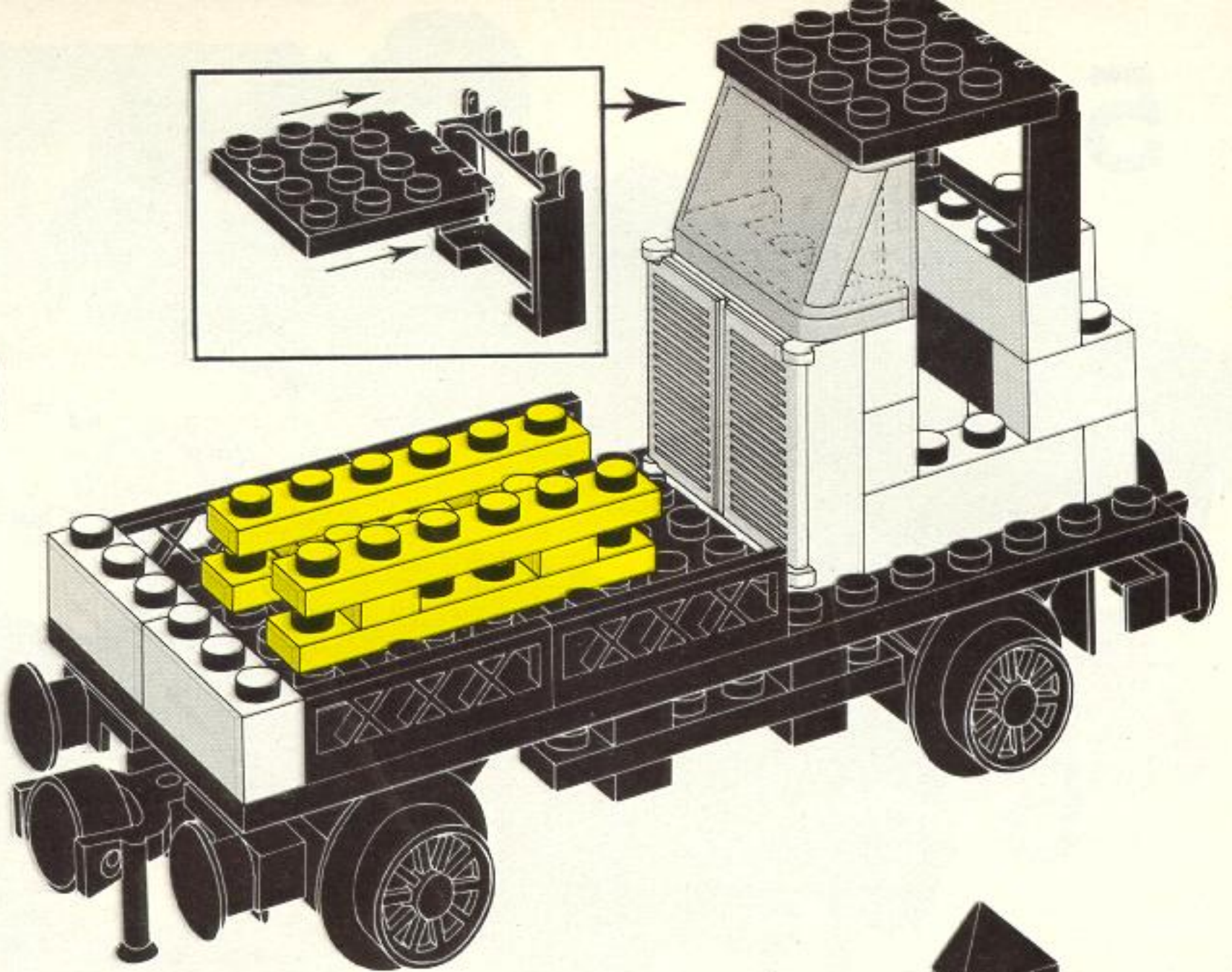
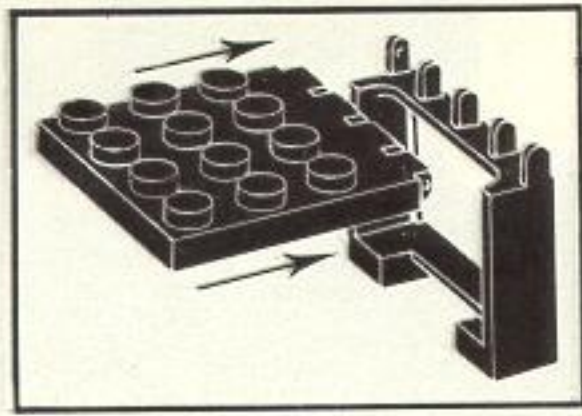

3

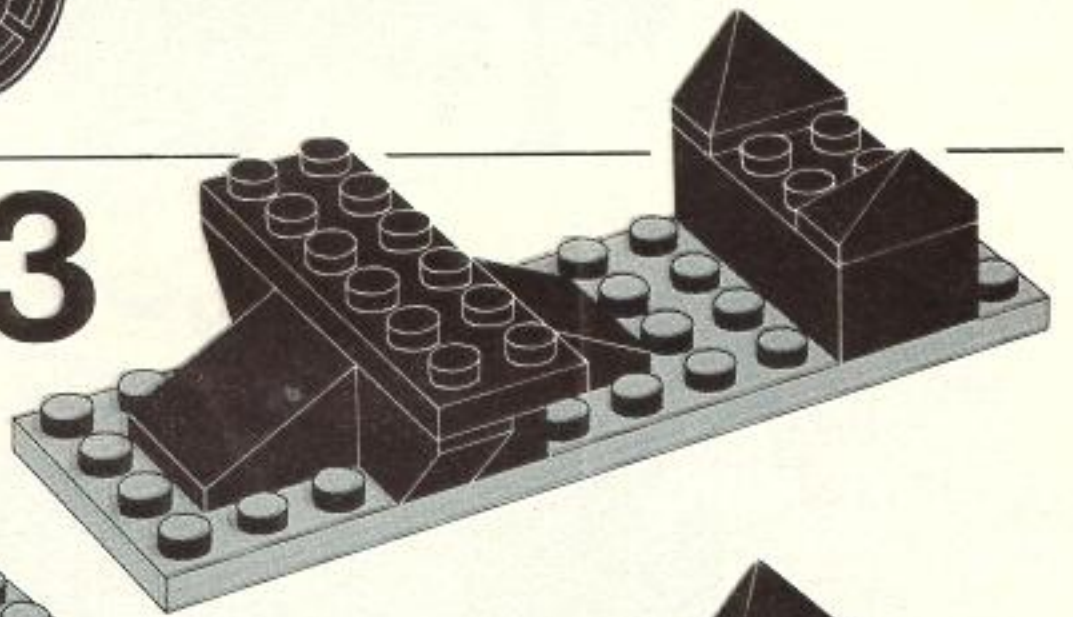

1

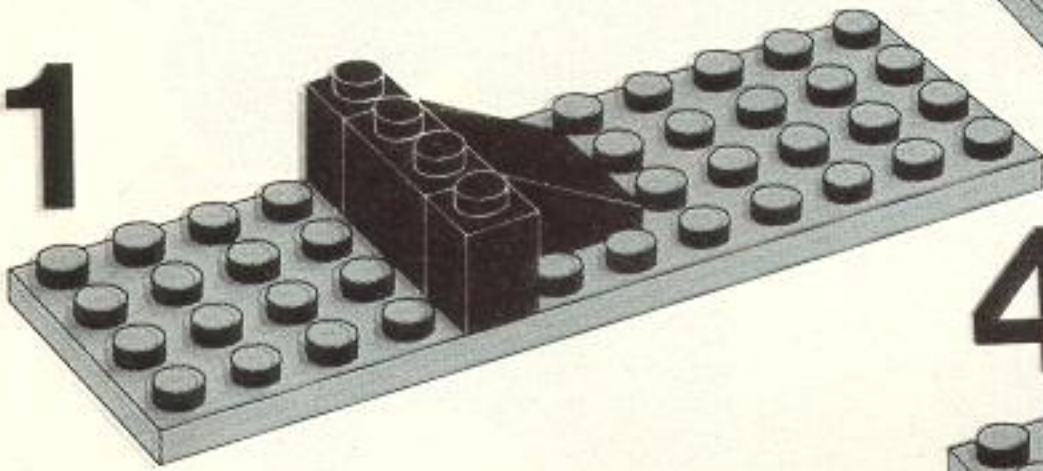

4

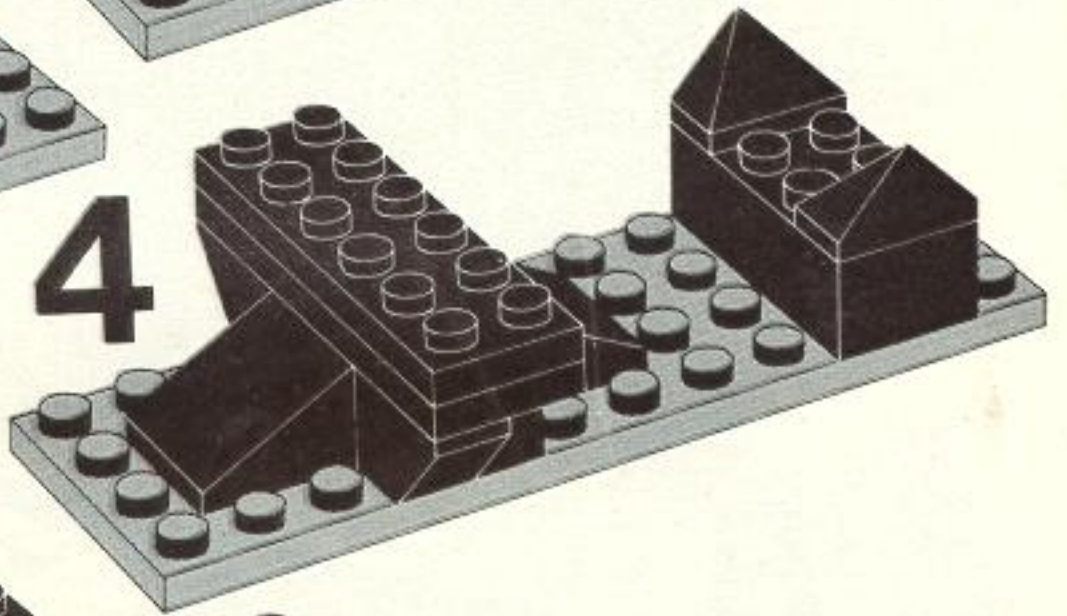

2

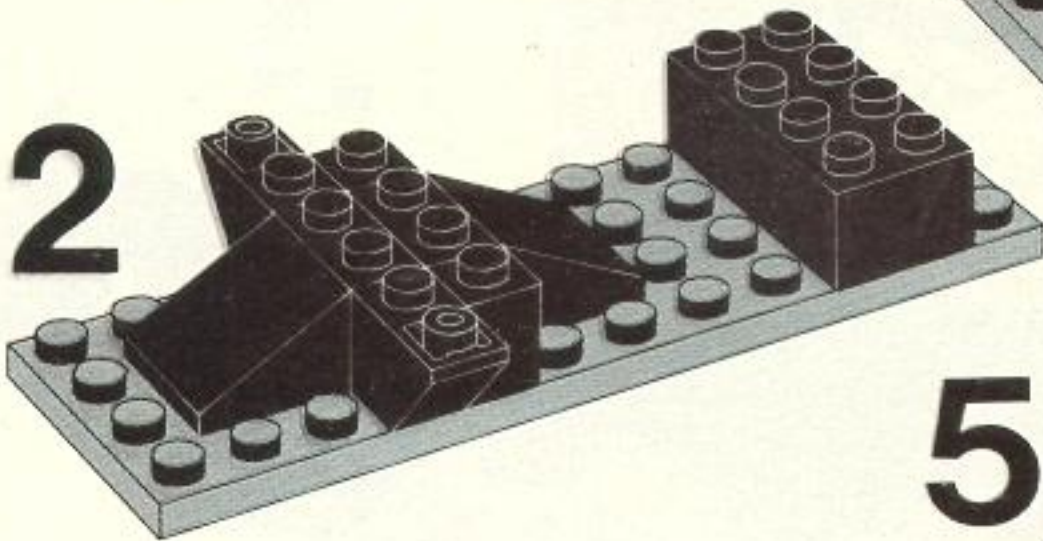

5

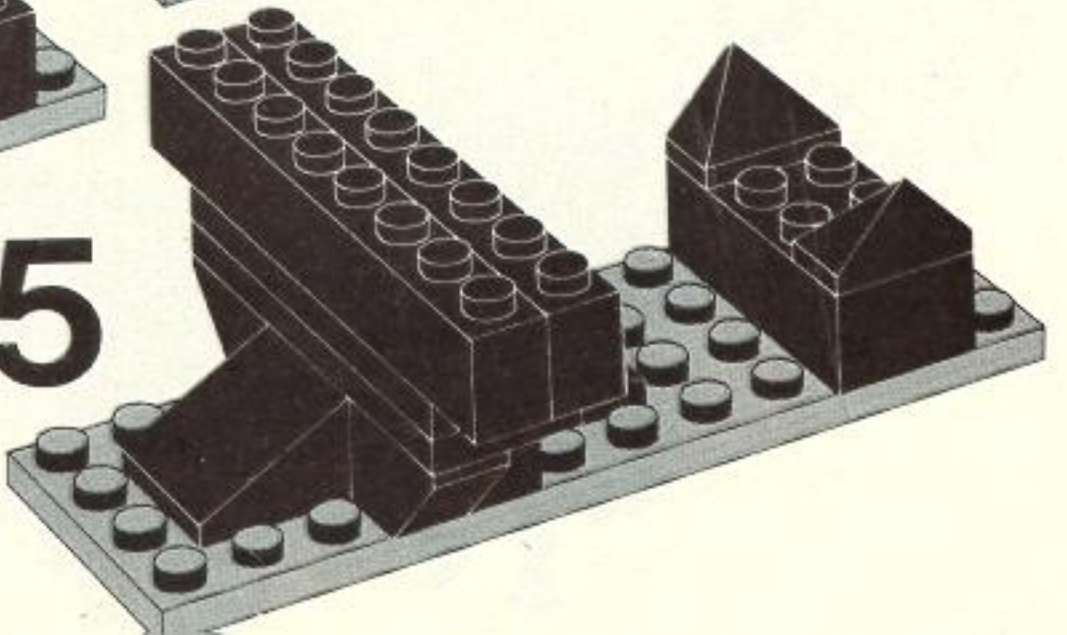

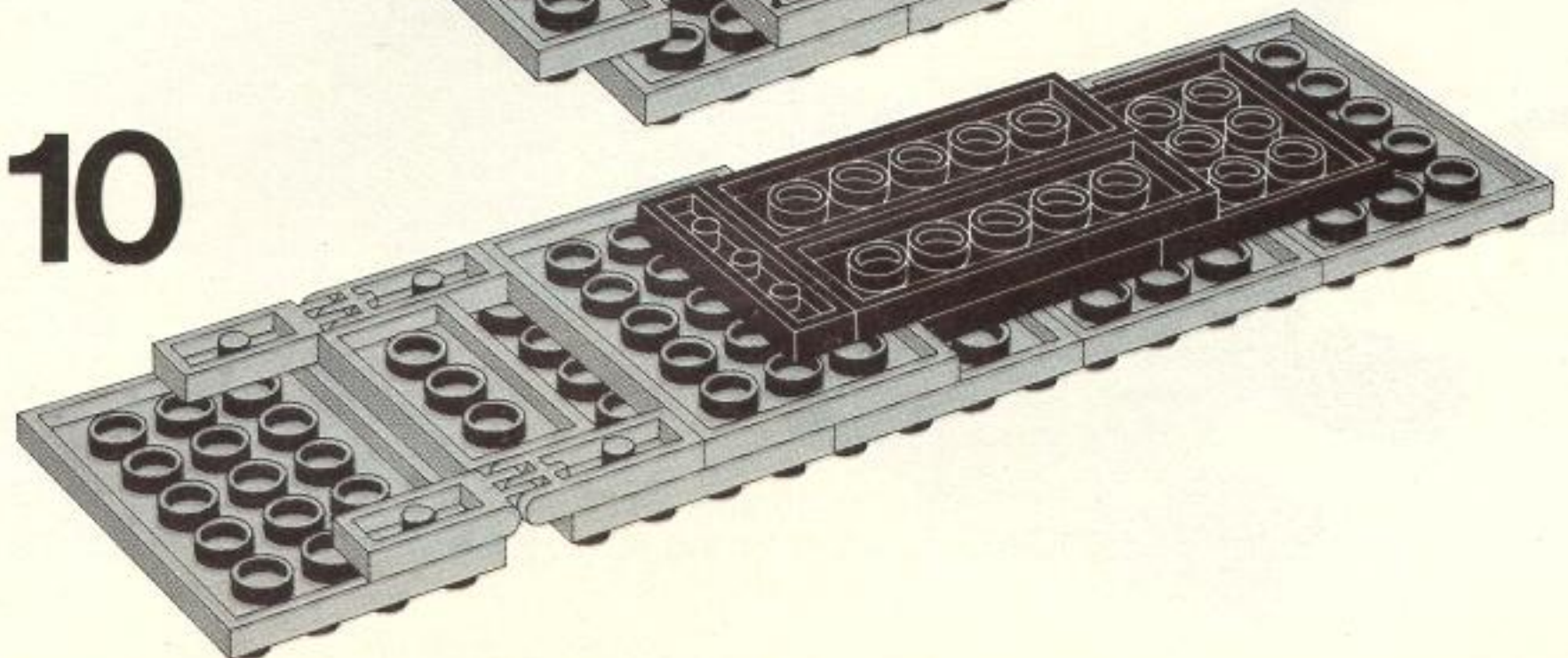
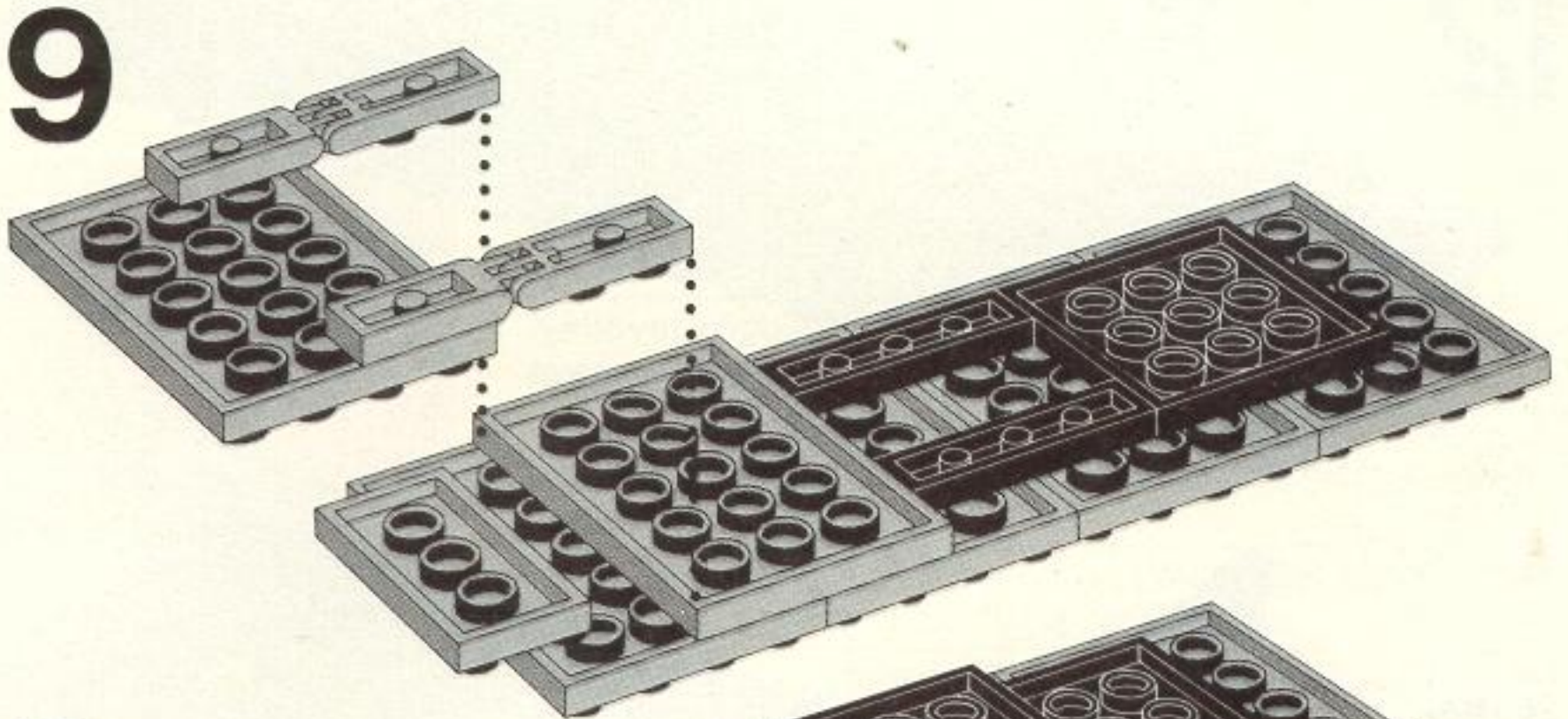
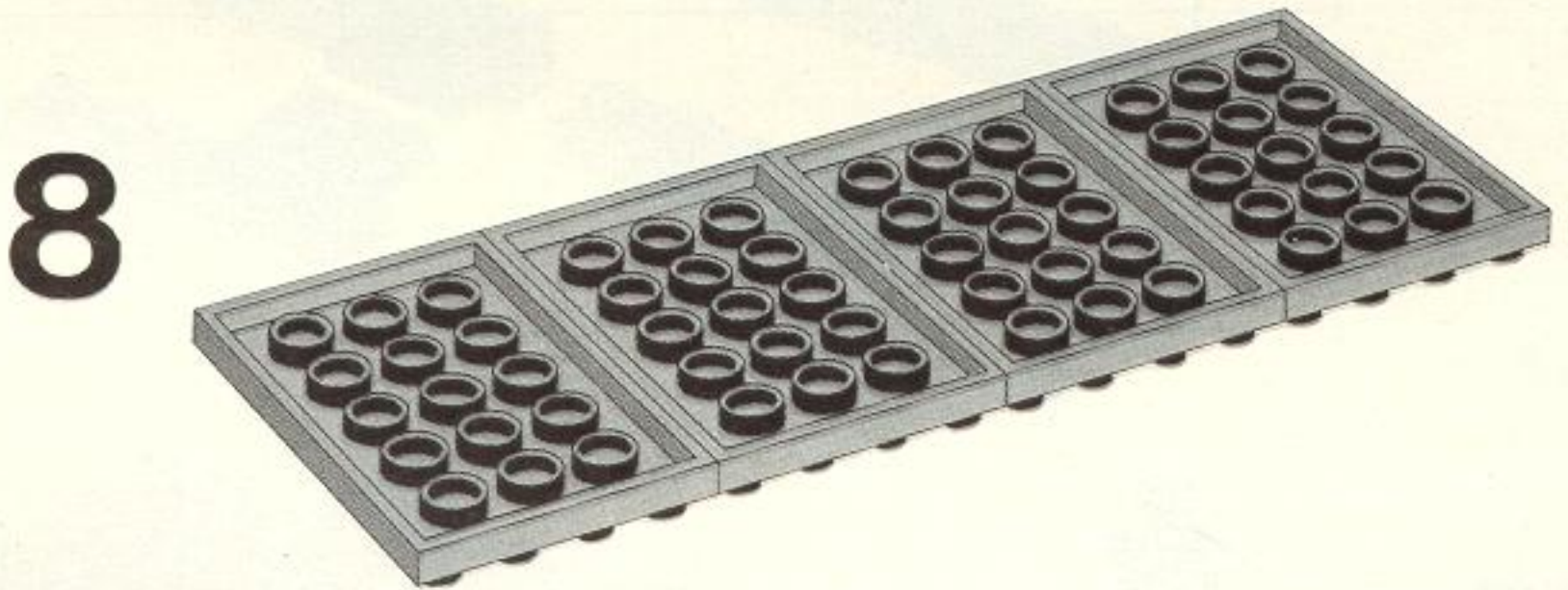
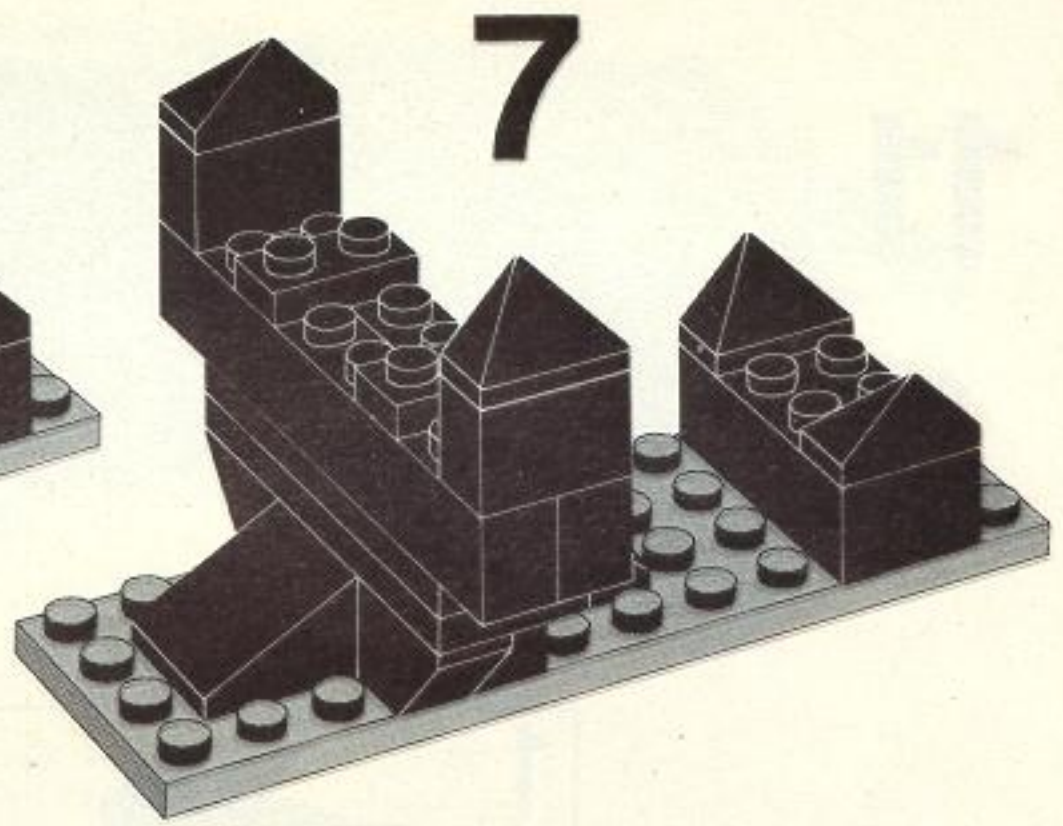
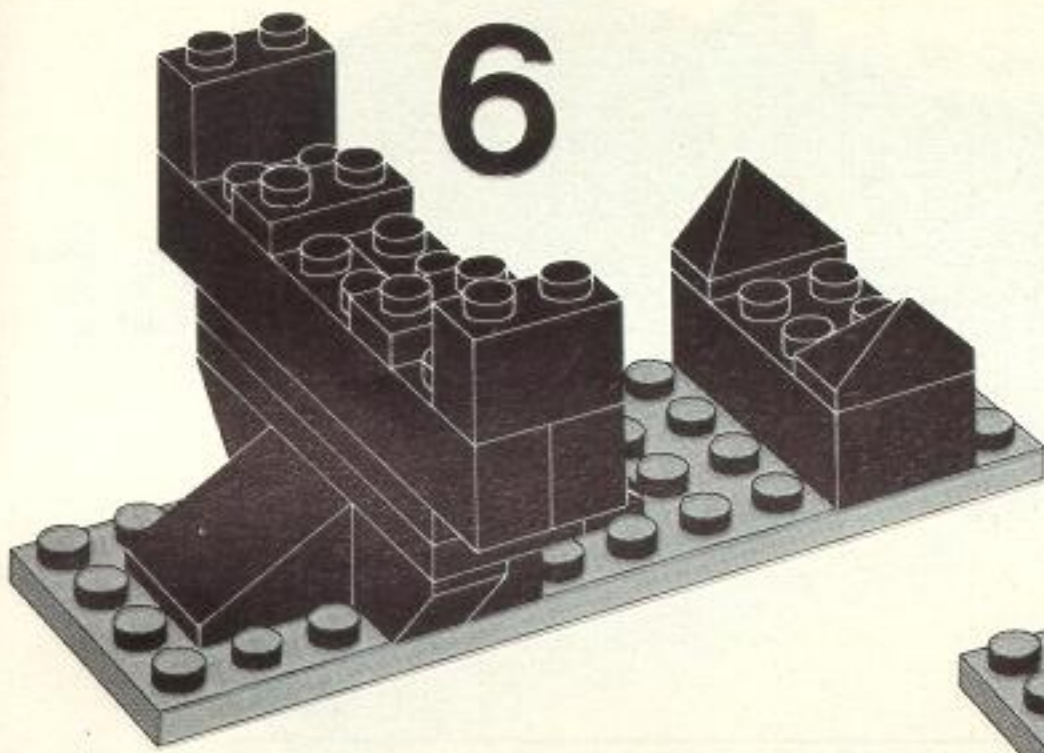

11

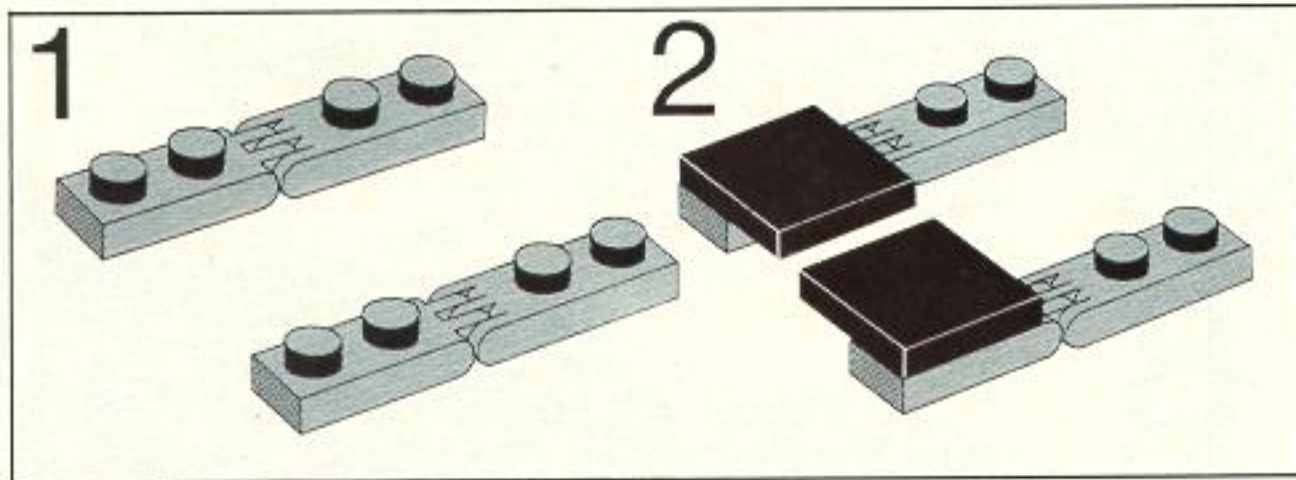
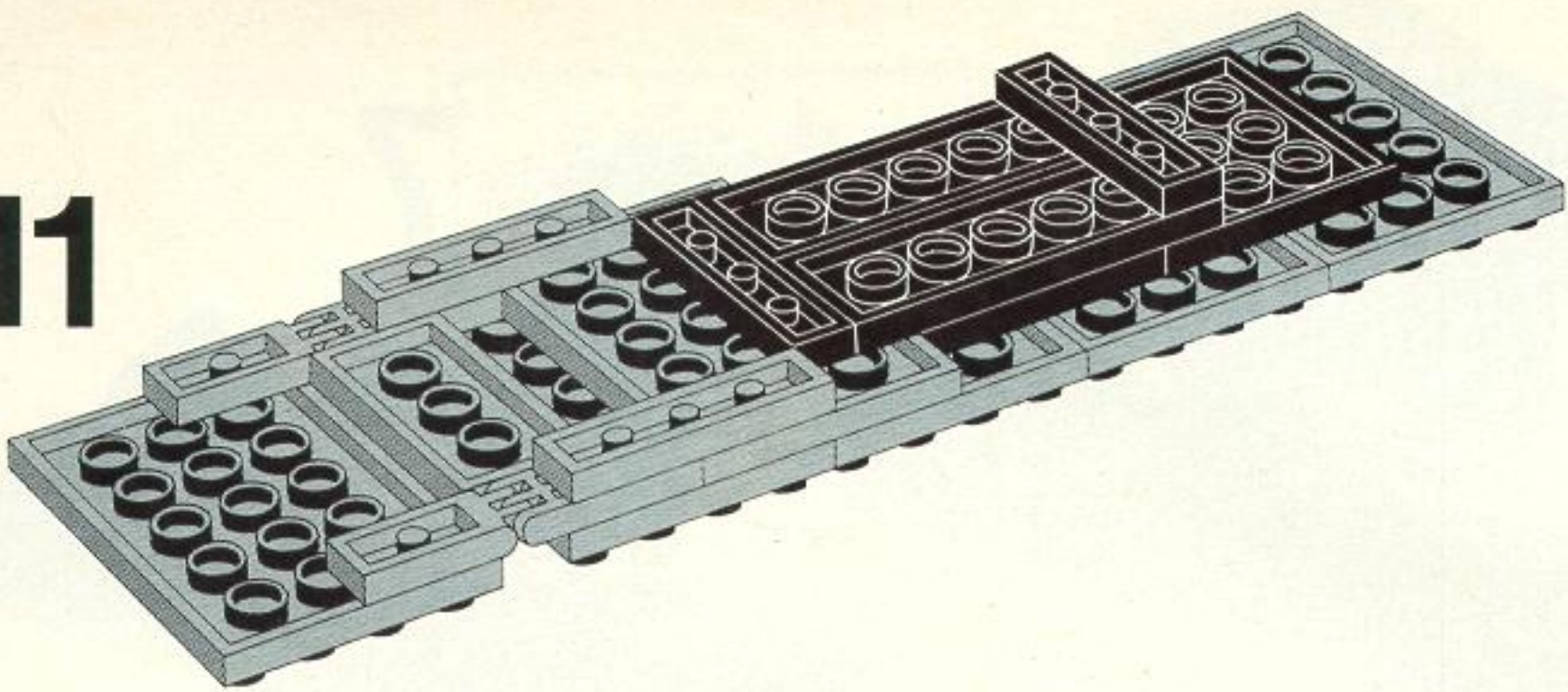

12

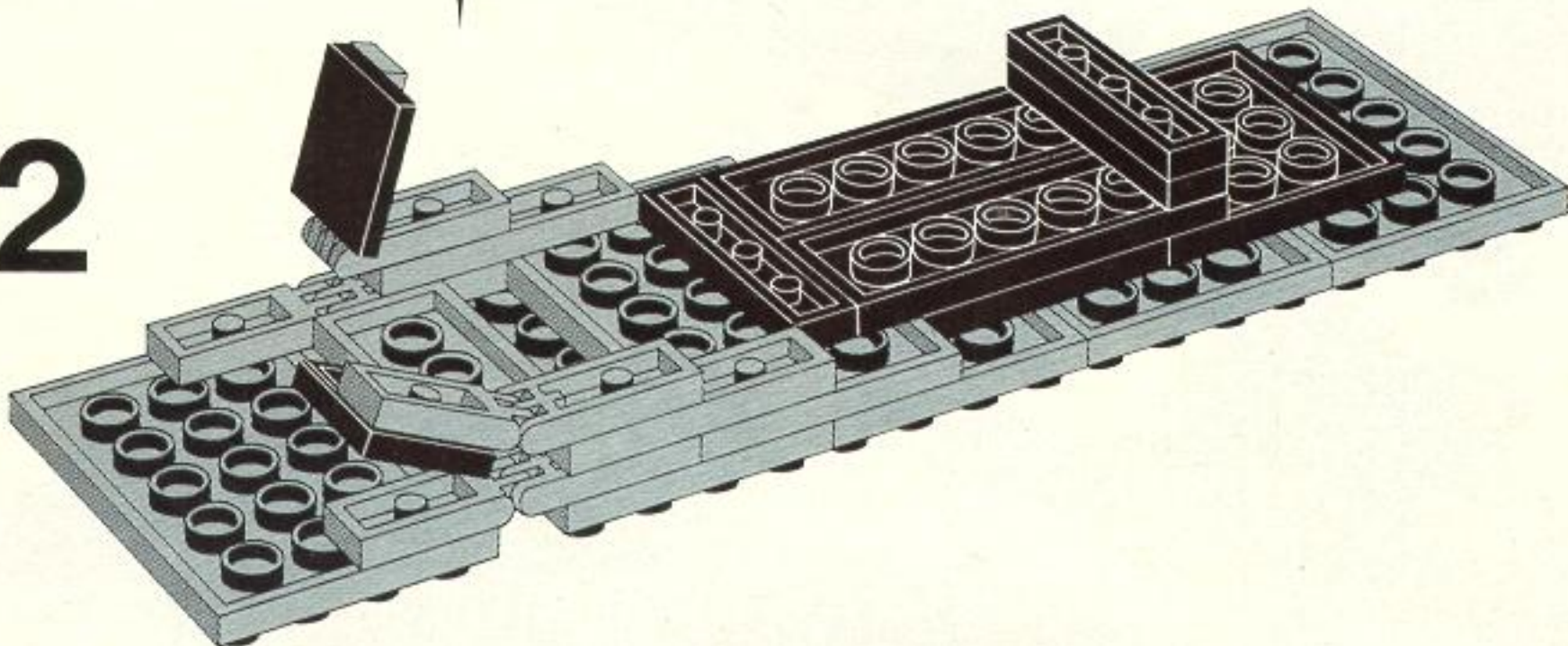

13

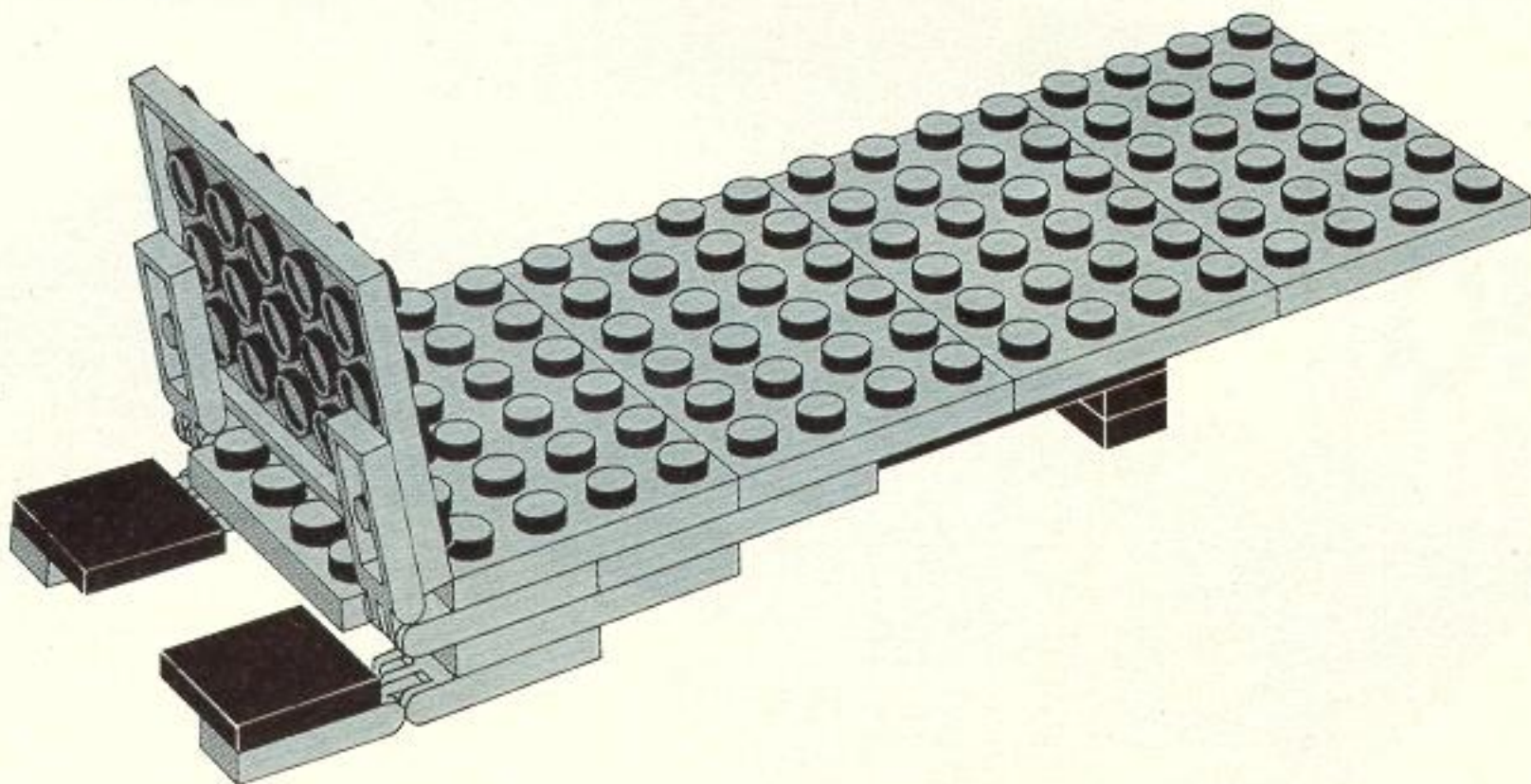

14

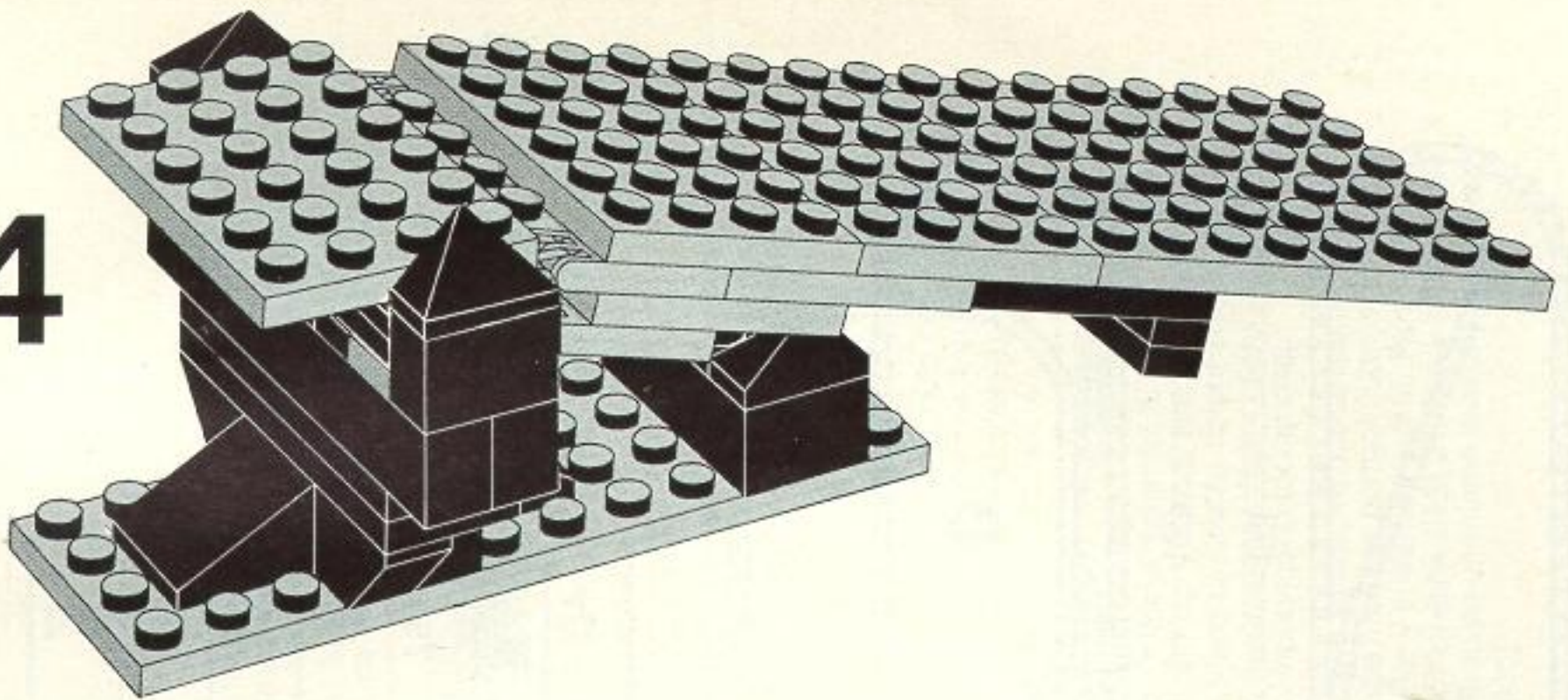

Die Schienen sind regelmäßig mit einem sauberen Radiergummi oder einem leicht in Spiritus getränkten Lappen zu reinigen.

Nettoyer régulièrement les rails avec une gomme ou avec un chiffon imbibé d'alcool à brûler.

Vraag een volwassene om regelmatig de rails schoon (vetvrij) te maken met een doekje en wat methylalcohol.

Rens jævnligt skinnerne med et almindeligt stykke viskelæder eller med en klud fugtet med sprit.

Du kan rengöra rälsen med ett vanligt radergummi eller en bomullstuss fuktad med T-sprit.

Puhdista sähköä johtavat kiskot säännöllisesti tavallisella pyyhekumilla tai talousspriillä kostutetulla rätillä.





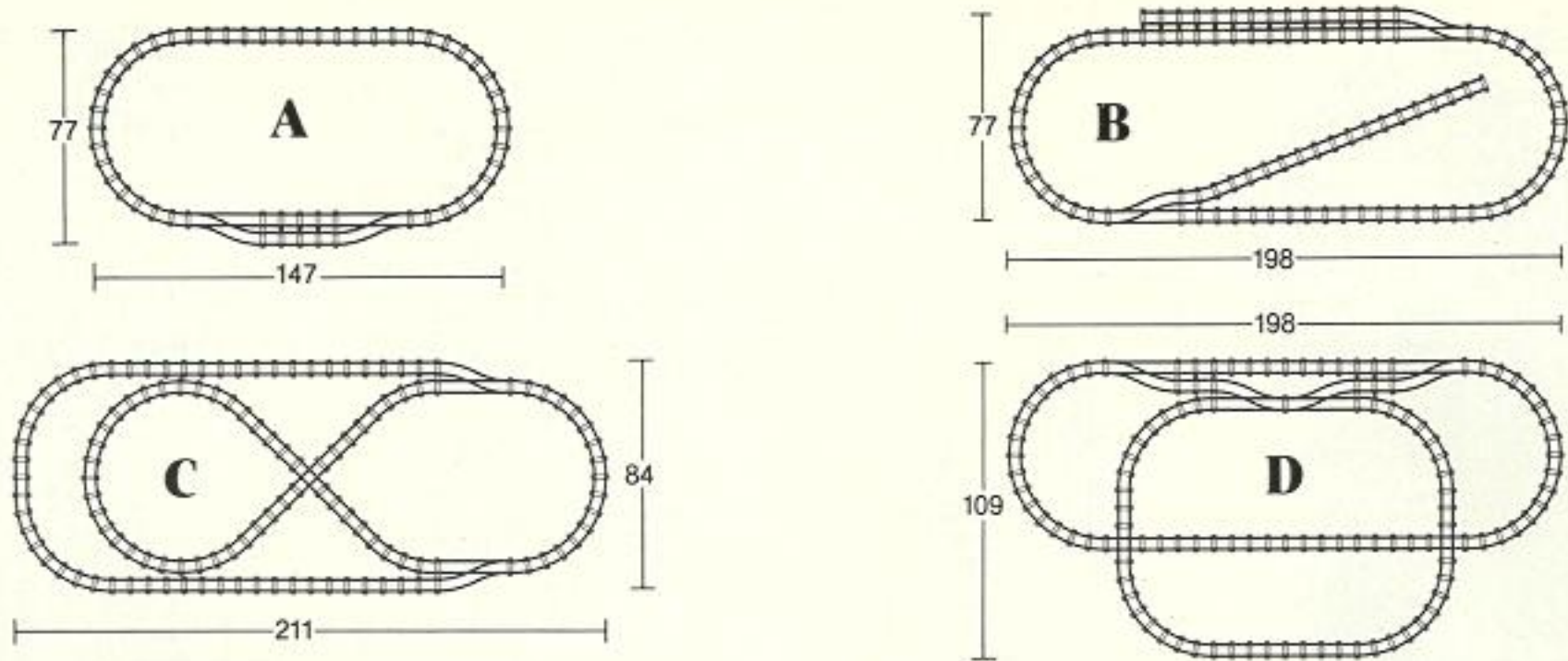

Clean the rails regularly with a hard or ink rubber or with a cloth dipped in methylated spirits.

Pulire regolarmente le rotaie con carta vetrata a grana fine o un panno imbevuto di alcool.

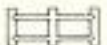
Las vías deben limpiarse regularmente con una goma de borrar o con un trapo mojado en alcohol.

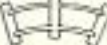



	4,5v/12v	12v	4,5v/12v	12v	12v	12v
	 7850	 7854	 7851	 7855	 7857	 7856
A	2	2	2	2	0	1
B	4	4	3	3	0	1
C	4	4	4	4	1	1
D	3	3	4	4	2	2

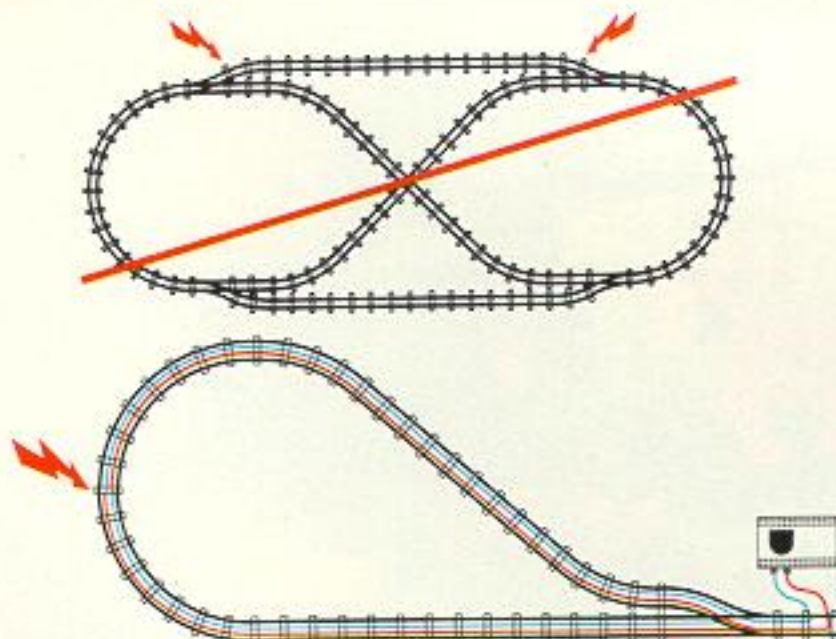

Einige Gleisanlagen können zu Kurzschlüssen führen. So zum Beispiel die hier gezeigte. Sollte es zu einem Kurzschluß kommen, schaltet sich der Transformator automatisch ab, und der Zug kann nicht mehr fahren. Um zu prüfen, ob bei Deiner Gleisanlage eine Kurzschlußgefahr besteht, brauchst Du nur die linke und rechte Schiene mit jeweils einer unterschiedlichen Farbe nachzuzeichnen. Sollten sich beide Farben auf der gleichen Seite treffen, gibt es einen Kurzschluß.

Certaines constructions de circuit 12 V peuvent provoquer un court-circuit, comme celui-ci par exemple. S'il y a un court-circuit, le transformateur est automatiquement coupé et le train ne peut plus avancer. Pour vérifier si un circuit peut fonctionner, dessinez votre réseau en prenant un crayon d'une couleur pour le rail intérieur et un crayon d'une autre couleur pour le rail extérieur (comme illustré). Si les deux couleurs se rejoignent sur le même côté, il y a aura un court-circuit.

Soms zal bij een 12 Volt baan kortsluiting optreden, b.v. bij de baan die je hier afgebeeld ziet. Op dat moment zal de automatische beveiliging in de transformator de stroom onderbreken, zodat de trein niet verder kan rijden. Dit kun je voorkomen door even met verschillende kleurpotloden de binnen- en buitenbaan te volgen. Komen de 2 verschillende kleuren bij elkaar dan zal kortsluiting optreden.

Nogle opbygninger af 12V togbaner vil kortslutte, f.eks. den, der er vist her. Hvis banen er kortsluttet slår afbryderkontakten i transformatoren automatisk fra, og toget kan ikke køre. Du kan selv kontrollere, om din bane vil kortslutte ved at lade 2 farver følge hhv. den yderste og den inderste del af banen (som vist). Hvis de 2 farver mødes på samme side kortslutter banen.

Några uppläggningar av 12 volt tågbanor kortslutes, t.ex. den som vi visar här. Om banan är kortsluten, slås avstängningskontakten i transformatorn automatiskt av och tåget kan ej köra. Du kan själv kontrollera om det är kortslutning i din bana genom att följa respektive färg från den yttersta och den nedersta delen av banan (som på bilden.) Om de 2 färgerna möts på samma sida kortsluts banan.

Jotkut 12 V ratayhdistelmät voivat aiheuttaa oikosulun, esim. tässä esitetty. Jos rata on oikosulussa, katkeaa virta muuntajasta automaattisesti, ja juna pysähtyy. Voit itse varmistaa, ettei oikosulkua aiheudu piirtämällä suunnittelemasi ratajärjestelmän paperille seuraavasti: Piirrä ulommainen kisko esim. punaisella ja sisempi sinisellä. Jos punainen ja sininen kohtaavat samalla puolella, syntyy oikosulku.

Some 12 volt track layouts will short-circuit, e.g. the one shown here. If the track short-circuits the transformer automatically cuts out and the train stops. To check whether your track will short-circuit, trace 2 colours along the inner and outer track respectively. (as shown). If the 2 colours meet on the same side, the track will short-circuit.

Errate composizioni di tracciati ferroviari a 12 V possono causare corto circuito. (vedi illustrazione). In questo caso il trasformatore è predisposto per il disinnesto automatico della corrente evitando al treno di rimettersi in moto. Per evitare il corto circuito nei tracciati eseguire il seguente controllo: Tracciare due linee parallele di diverso colore che riproducano il tracciato elettrificato (vedi illustrazione). Non ci sarà corto circuito se i colori delle linee non si sovrappongono toccandosi.

Al establecer trayectos con las vías de 12 voltios, se puede producir algún cortocircuito, como el del ejemplo. Si se produce cortocircuito, el transformador se desconecta automáticamente y el tren se parará. Para verificar si tu trayecto está en cortocircuito, comprueba si los 2 colores de las vías, el de fuera y el de dentro, se encuentran en un mismo lado, en cuyo caso estará en cortocircuito. (Ver ilustración).

