

7838



123287

1



2

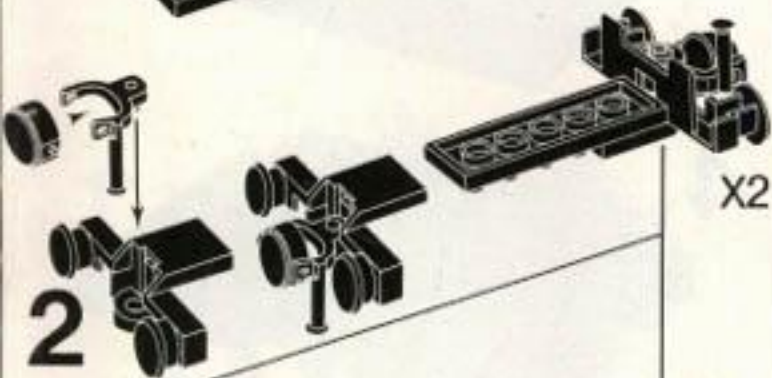

3



X2

4

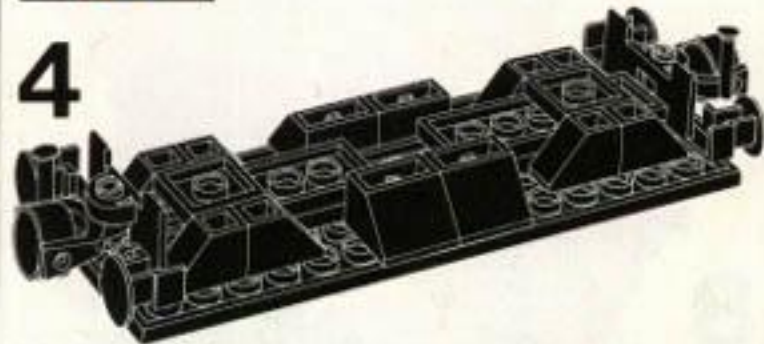

5

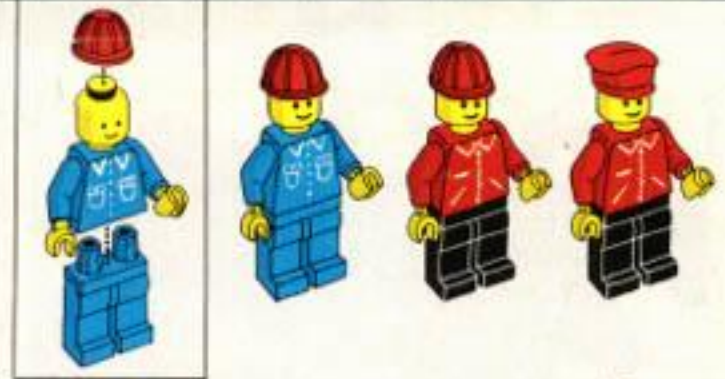
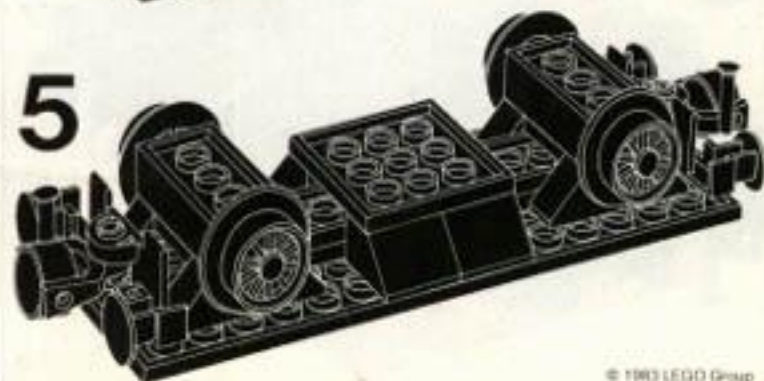



X4

6

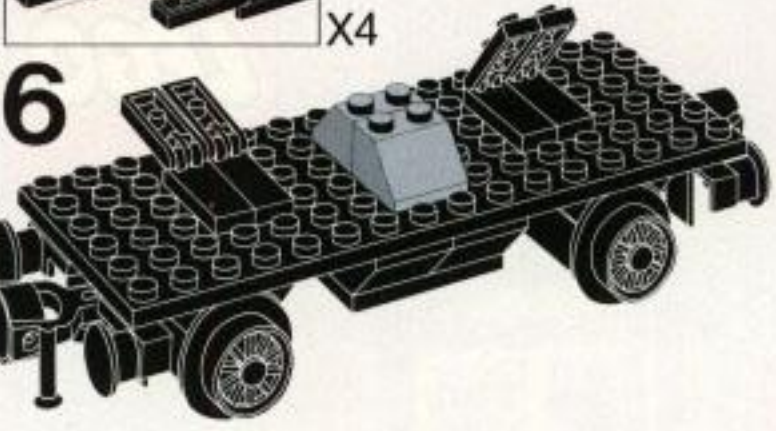

X4

7

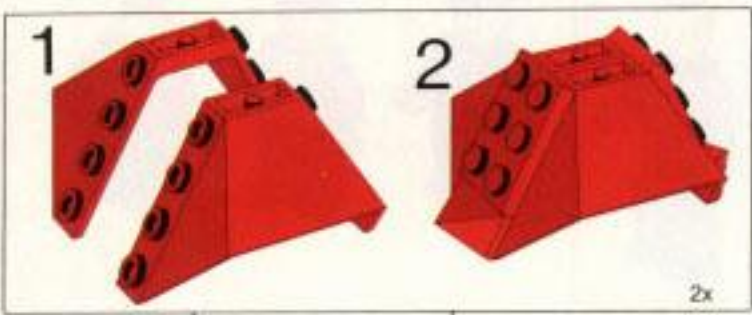
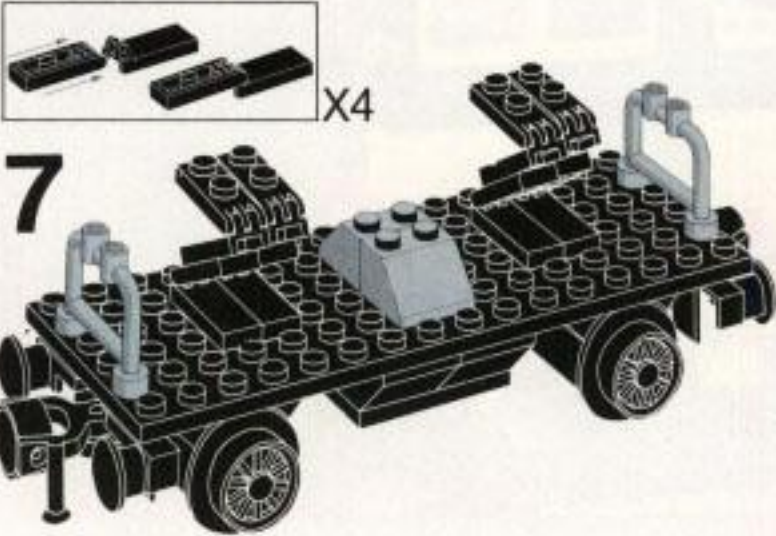

2x

8

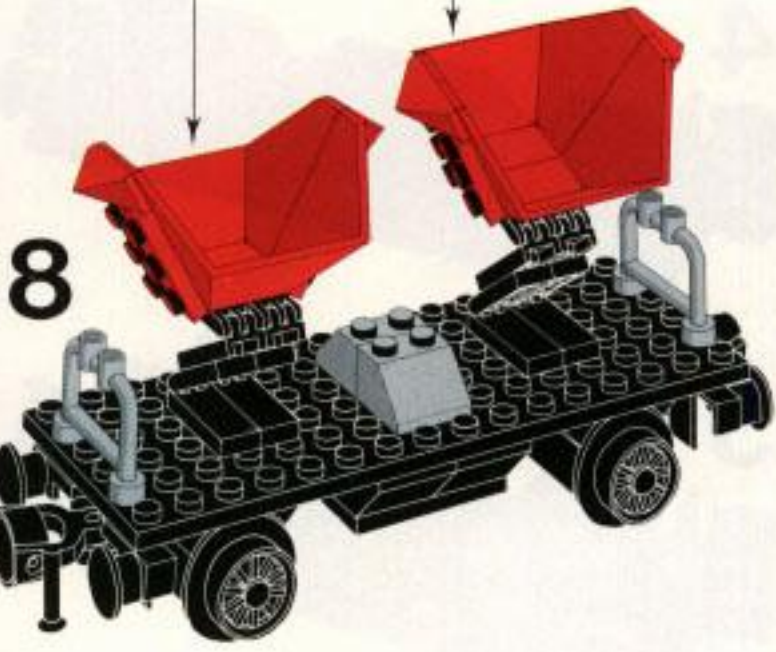

1



2

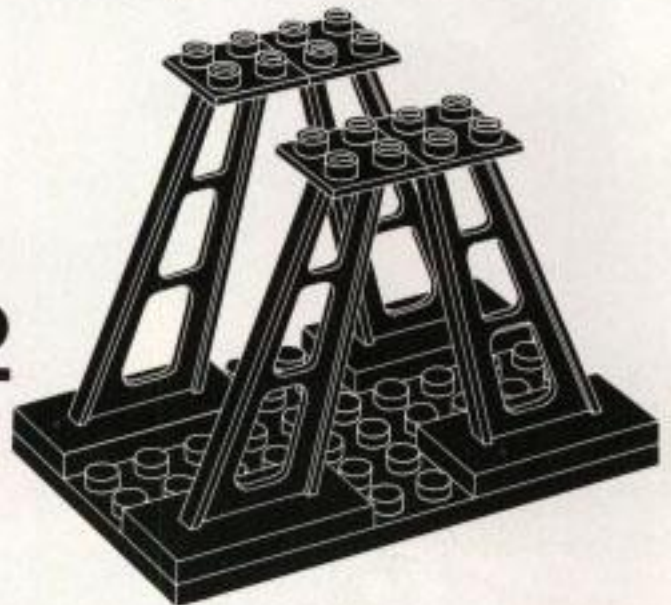

3



4



5



6

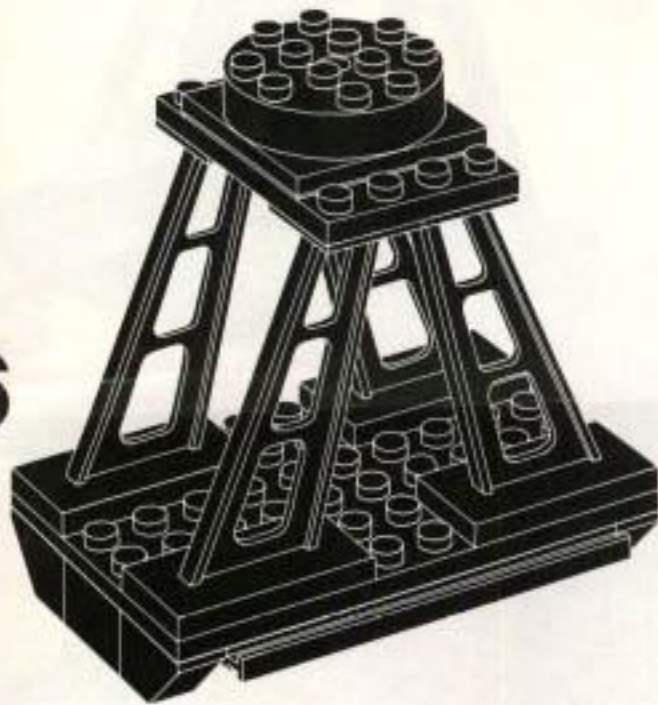

1

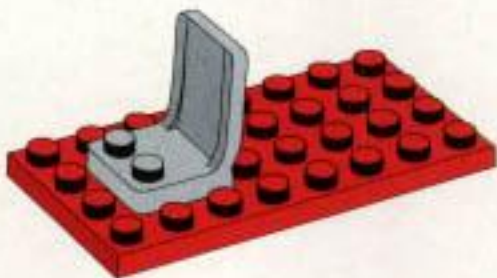

2

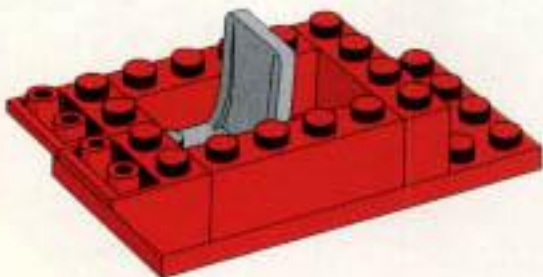

3

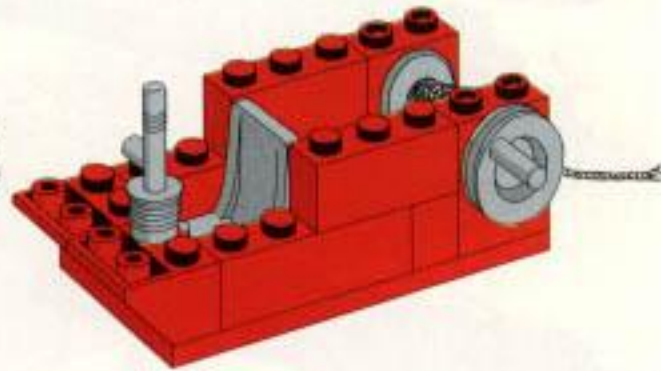

1



2



3



4

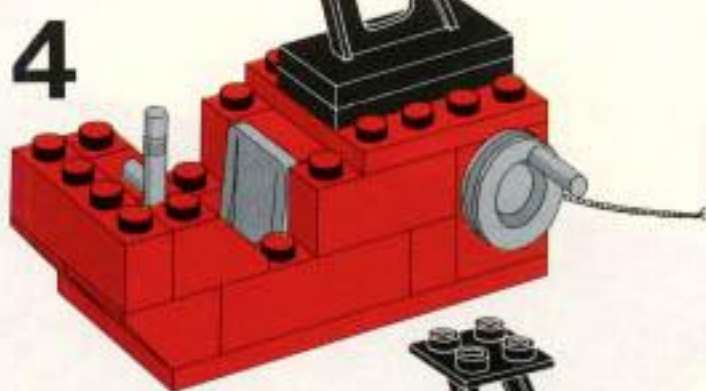

5

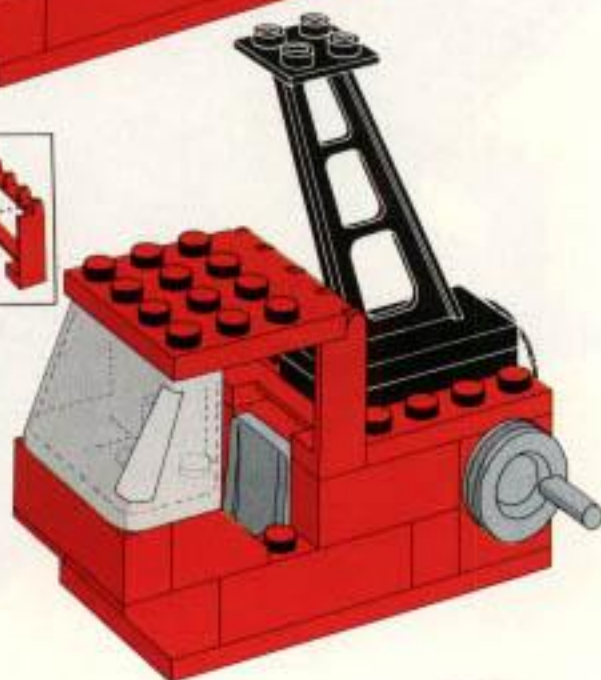

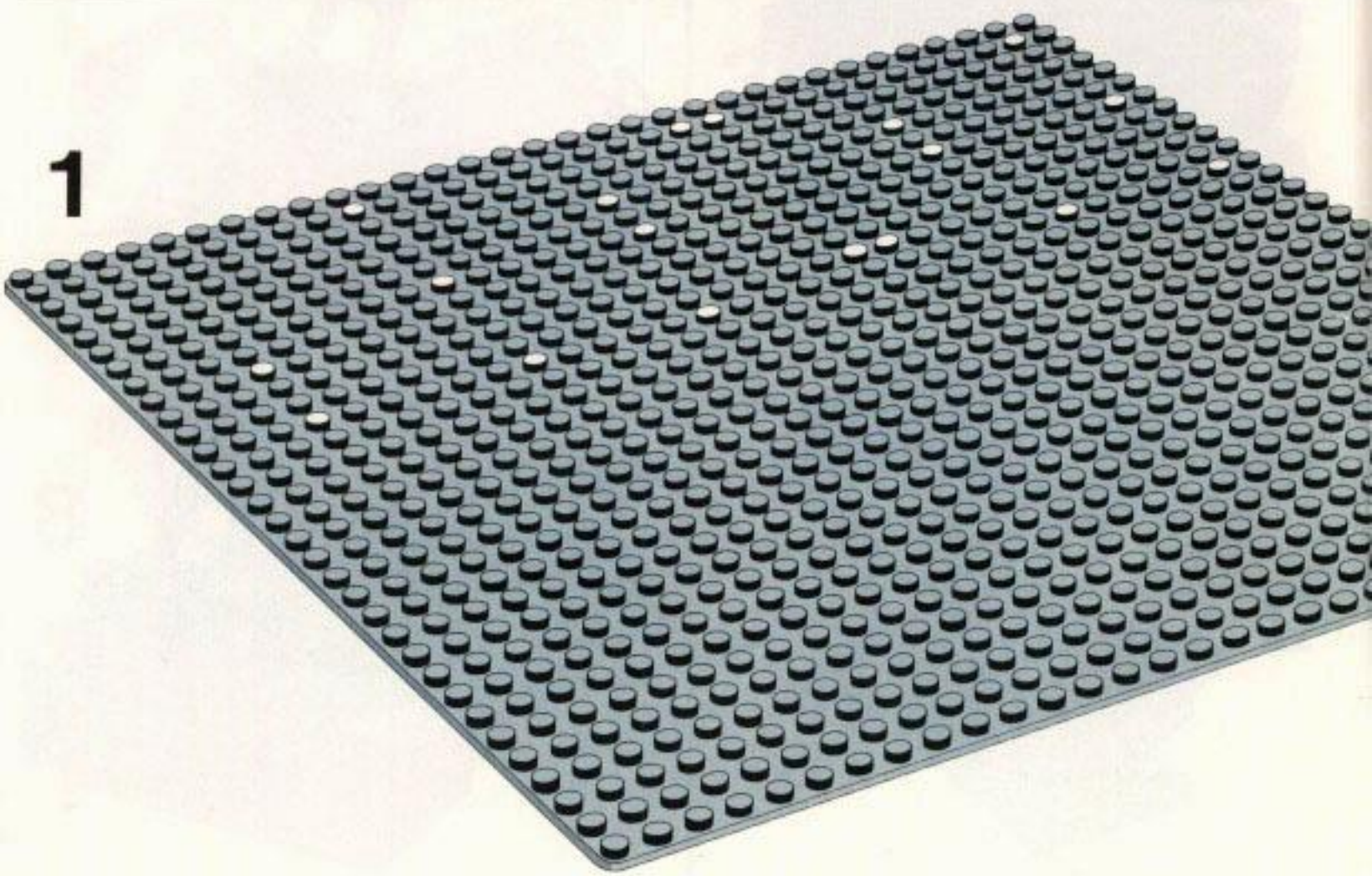
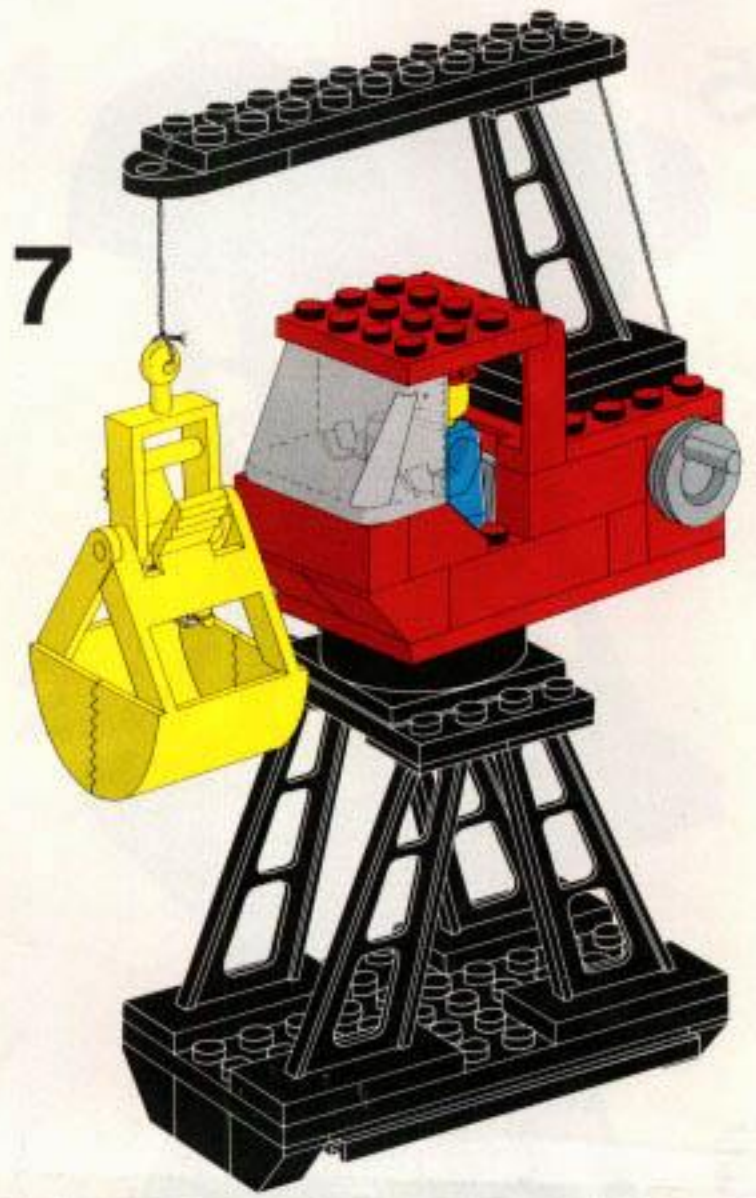
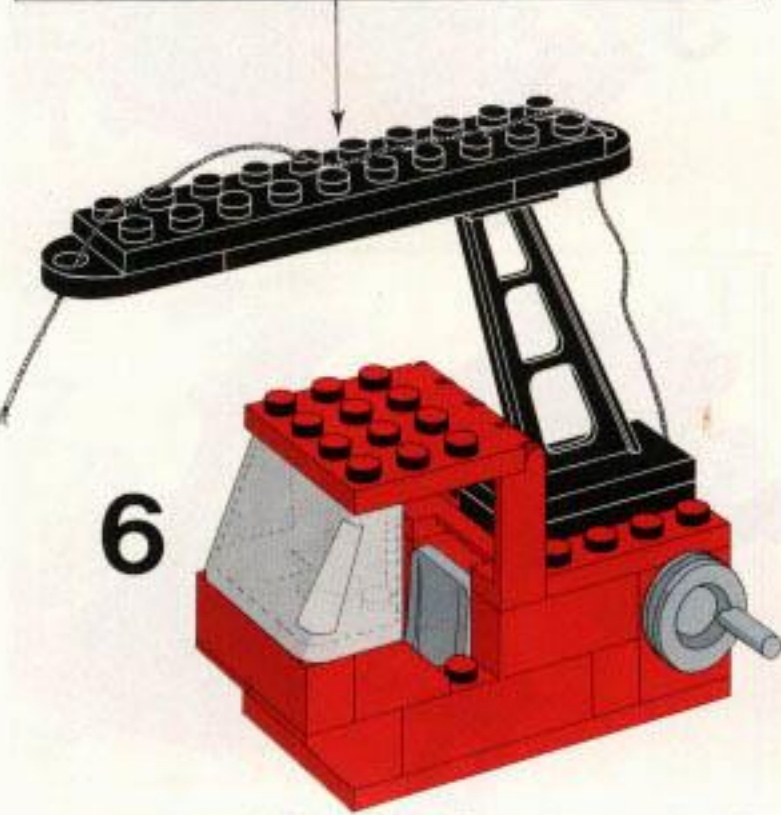
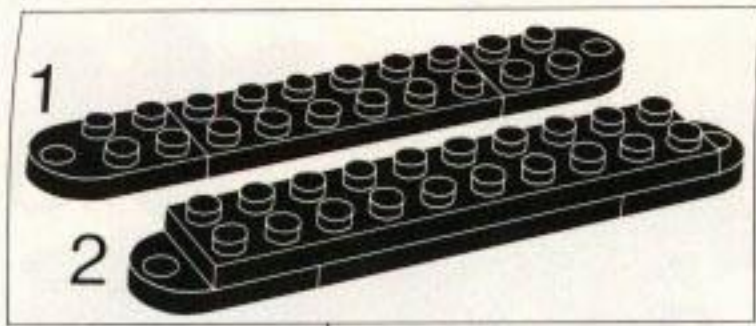

2

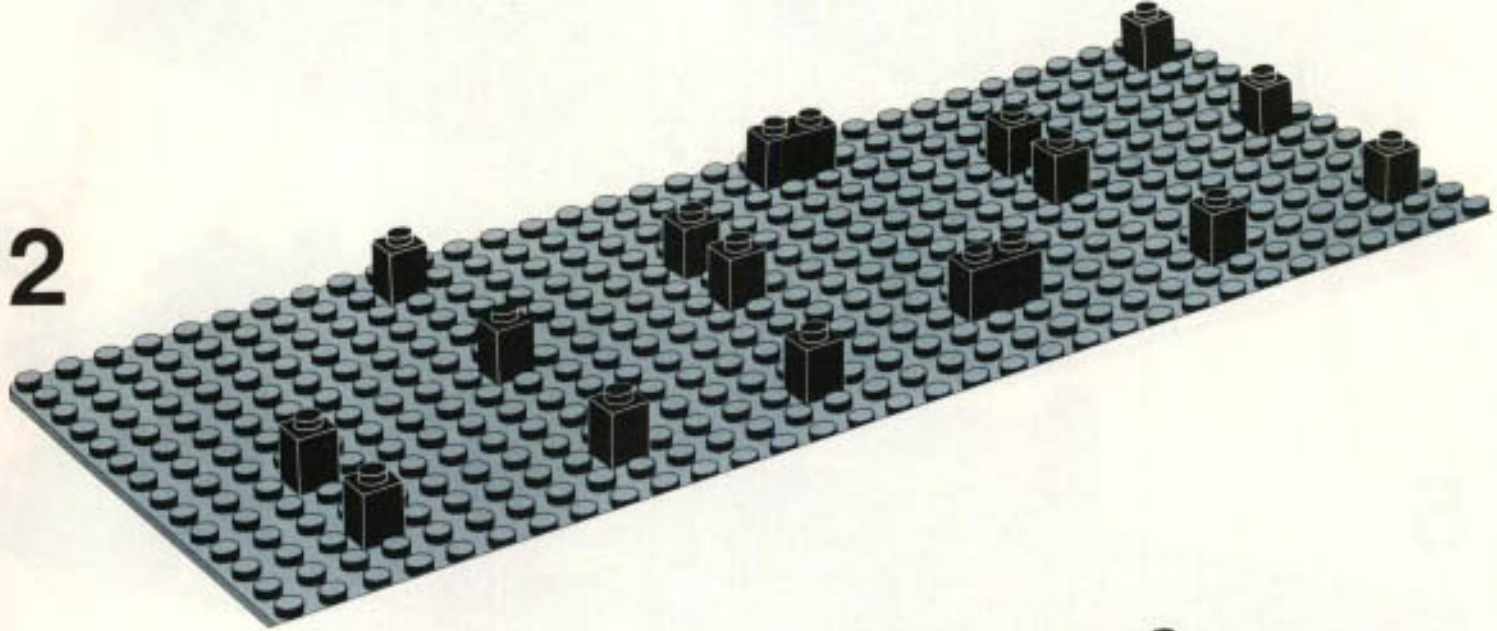

3

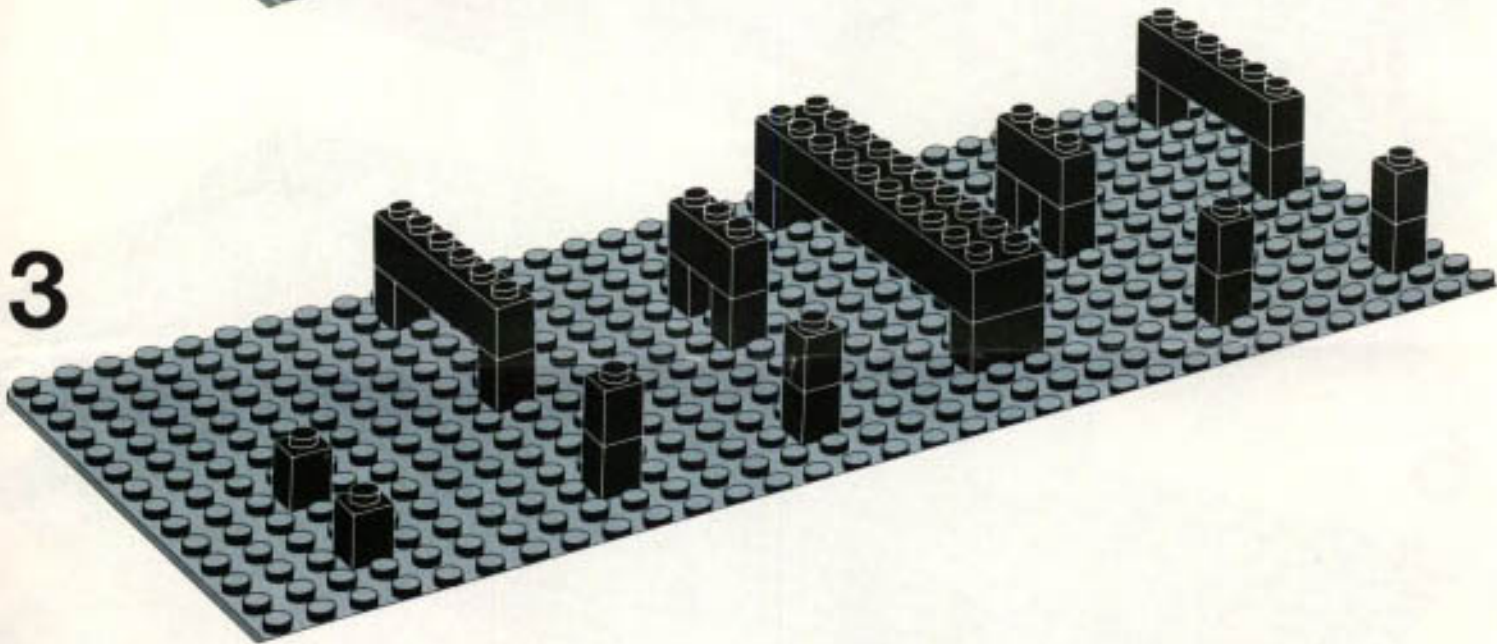

4

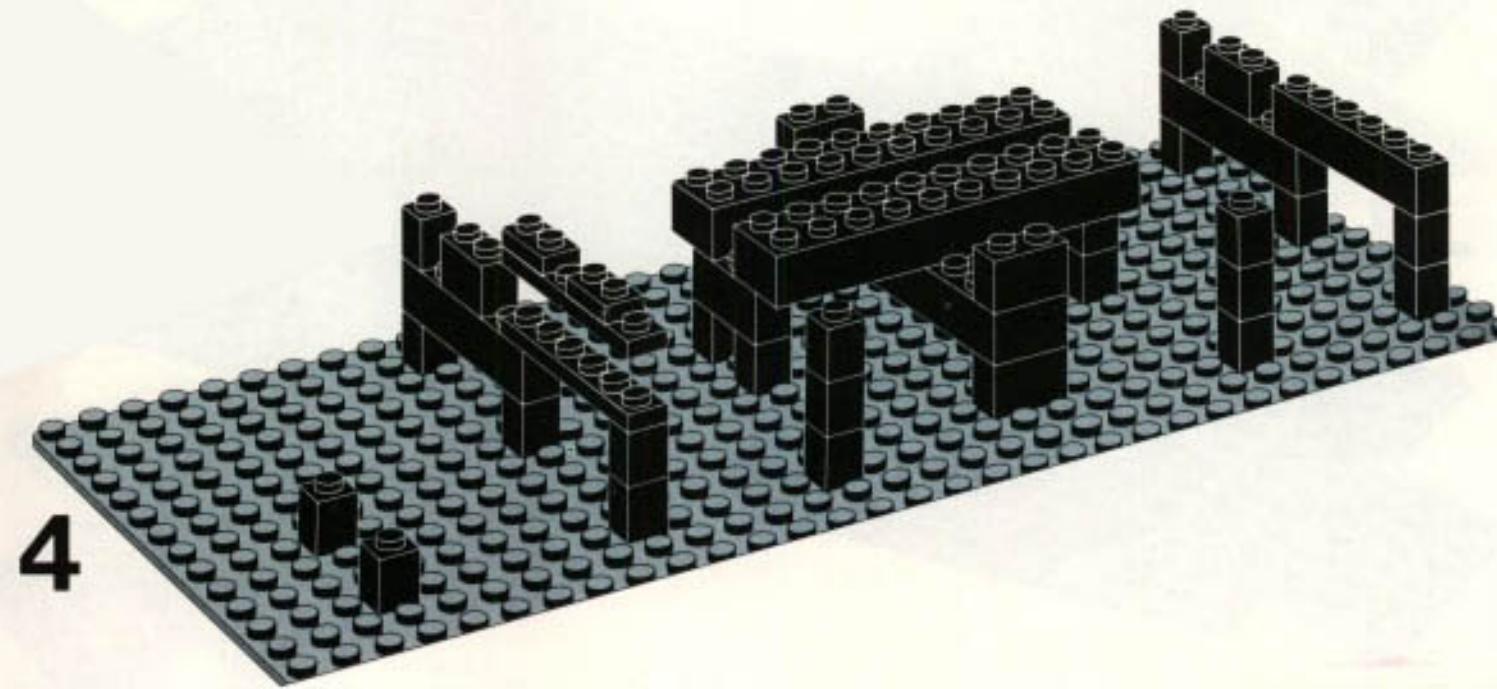



1



2

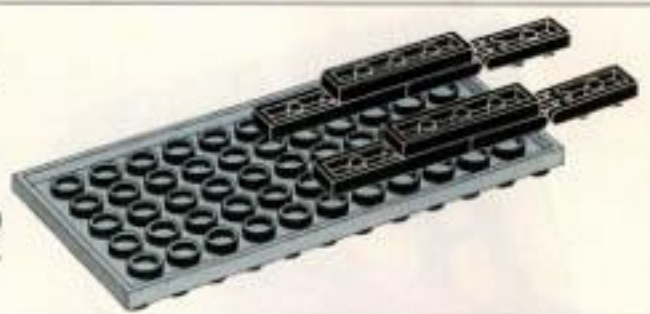

5

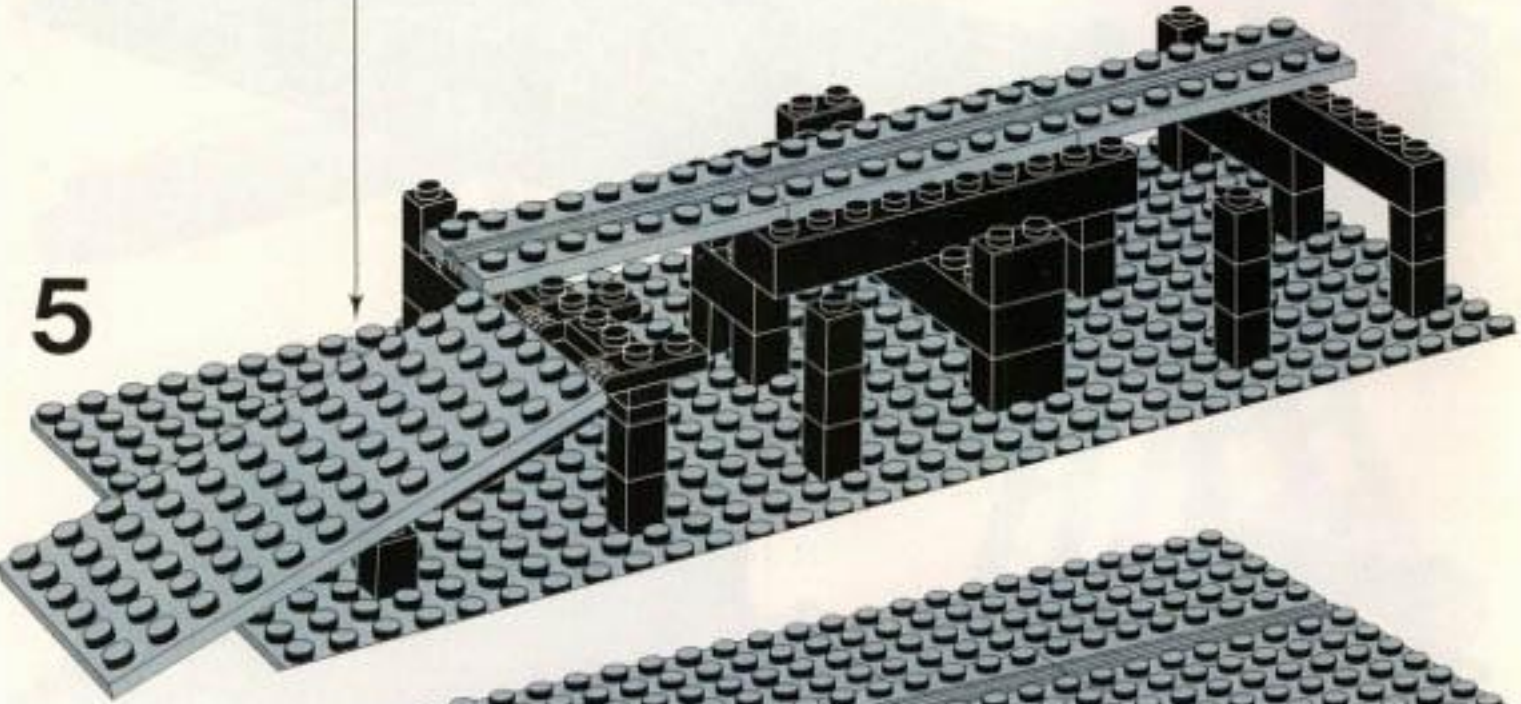

6

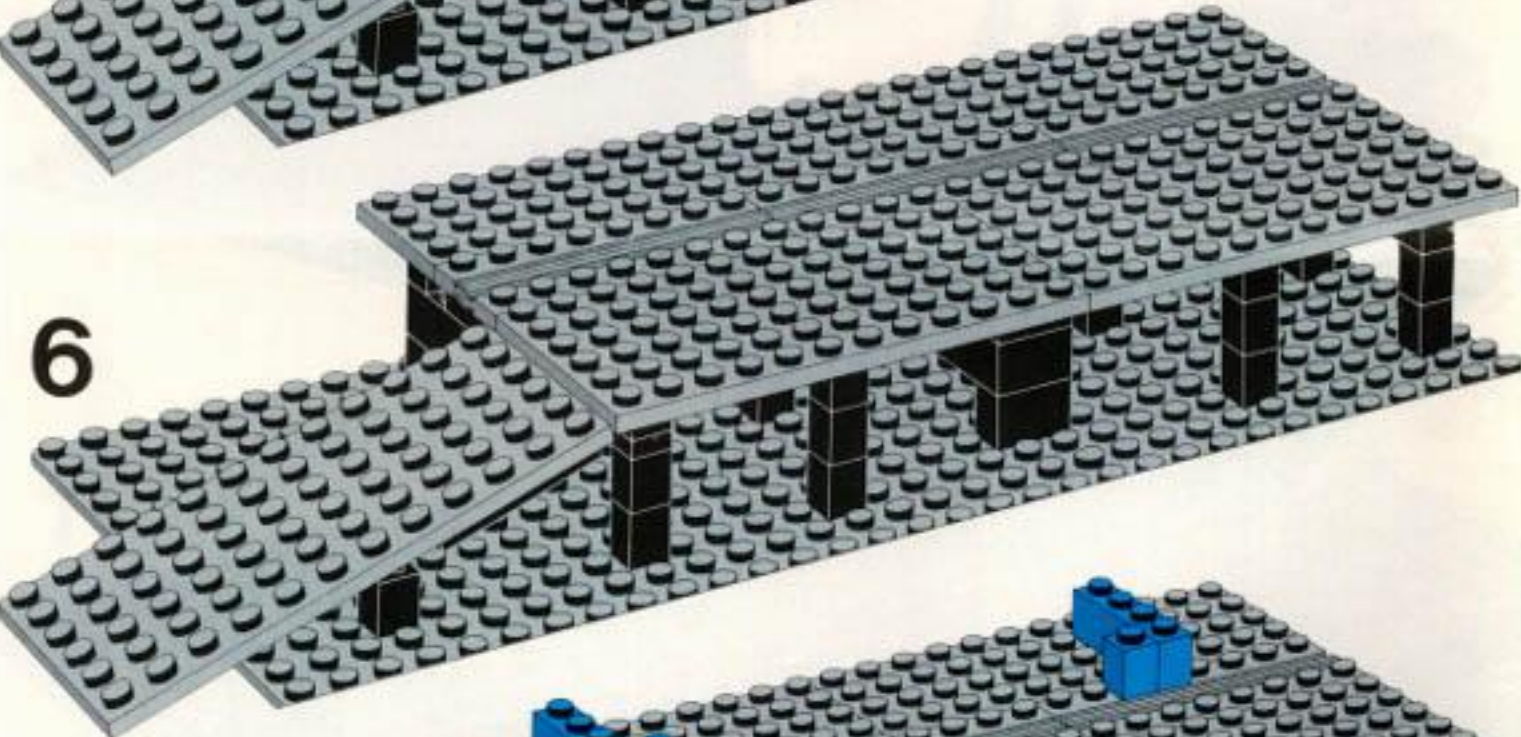

7

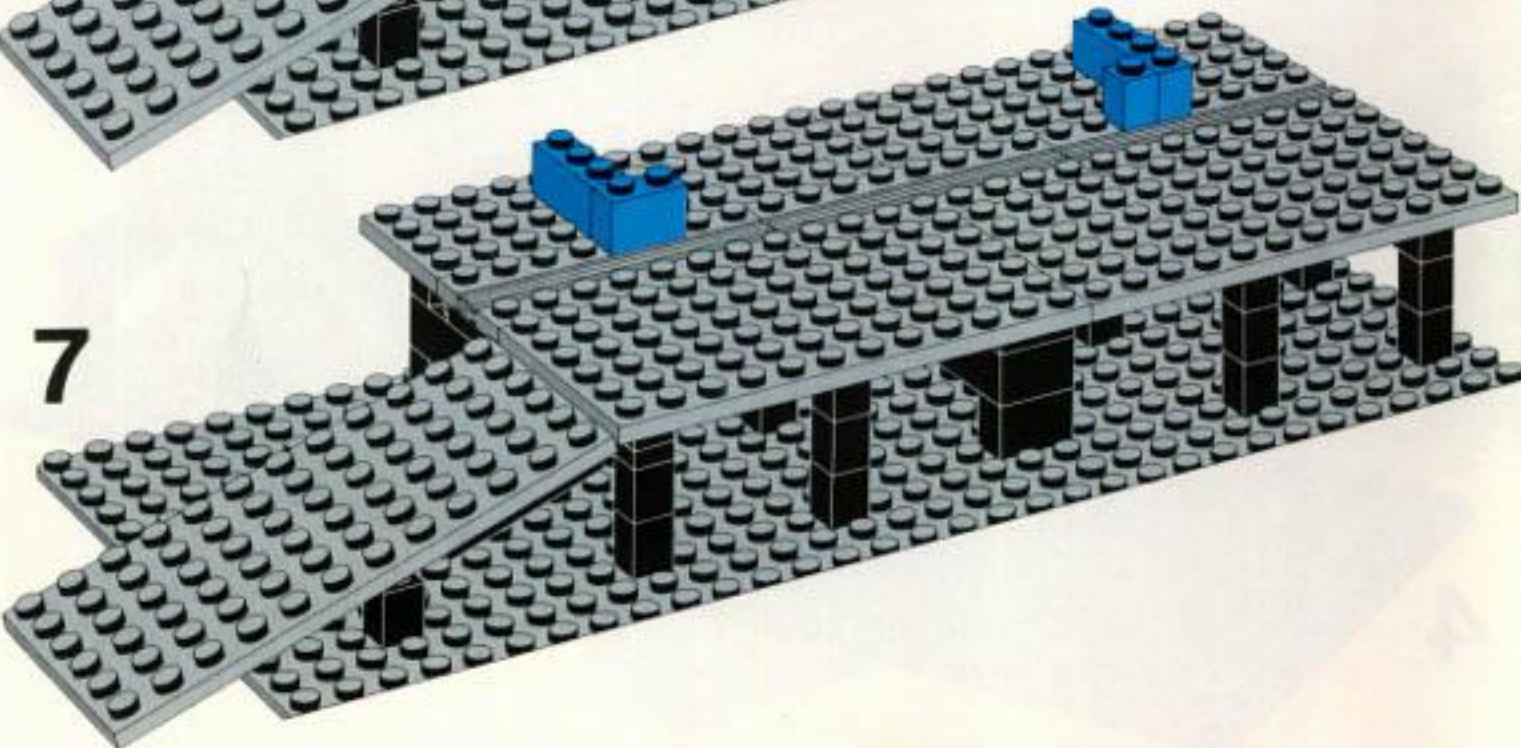

8

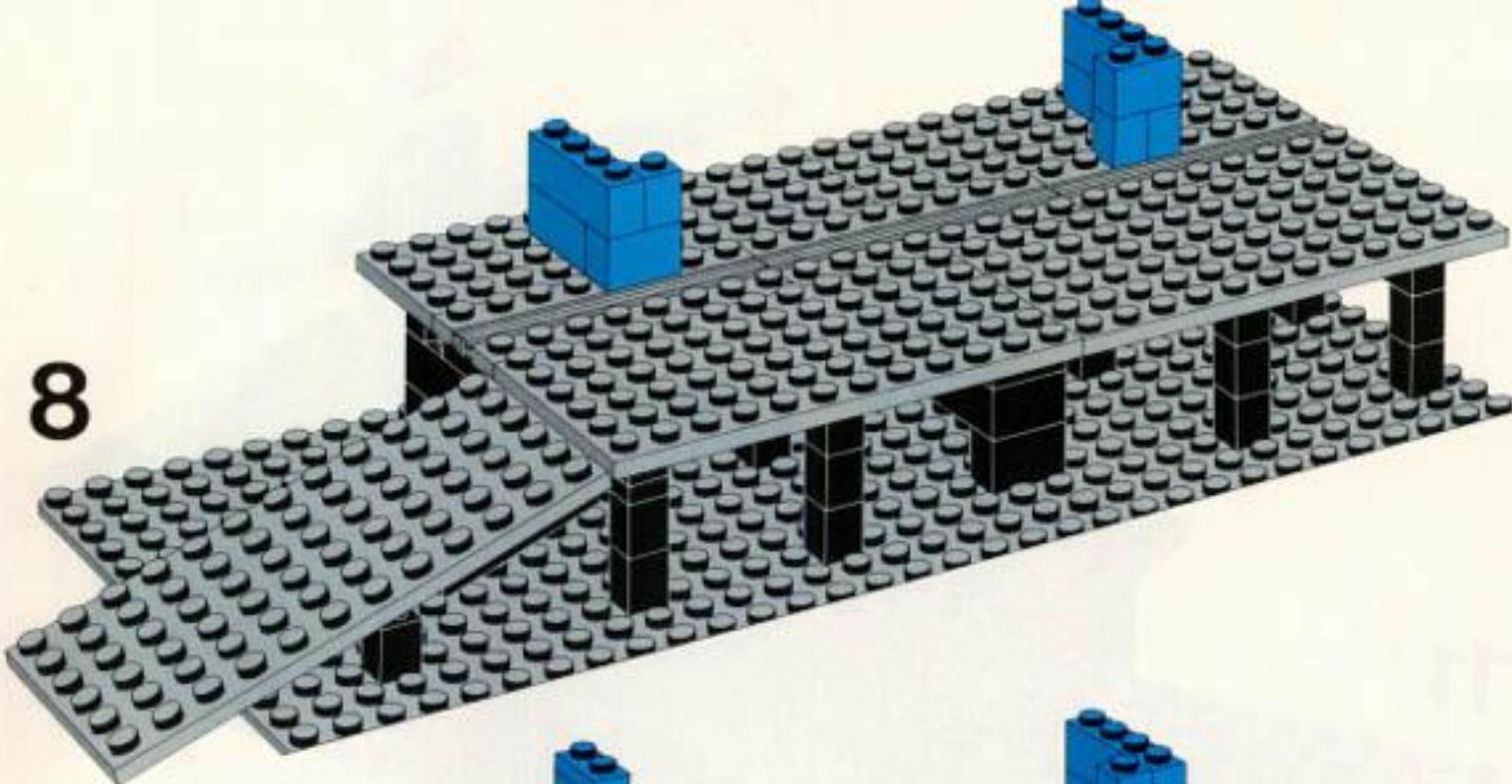

9

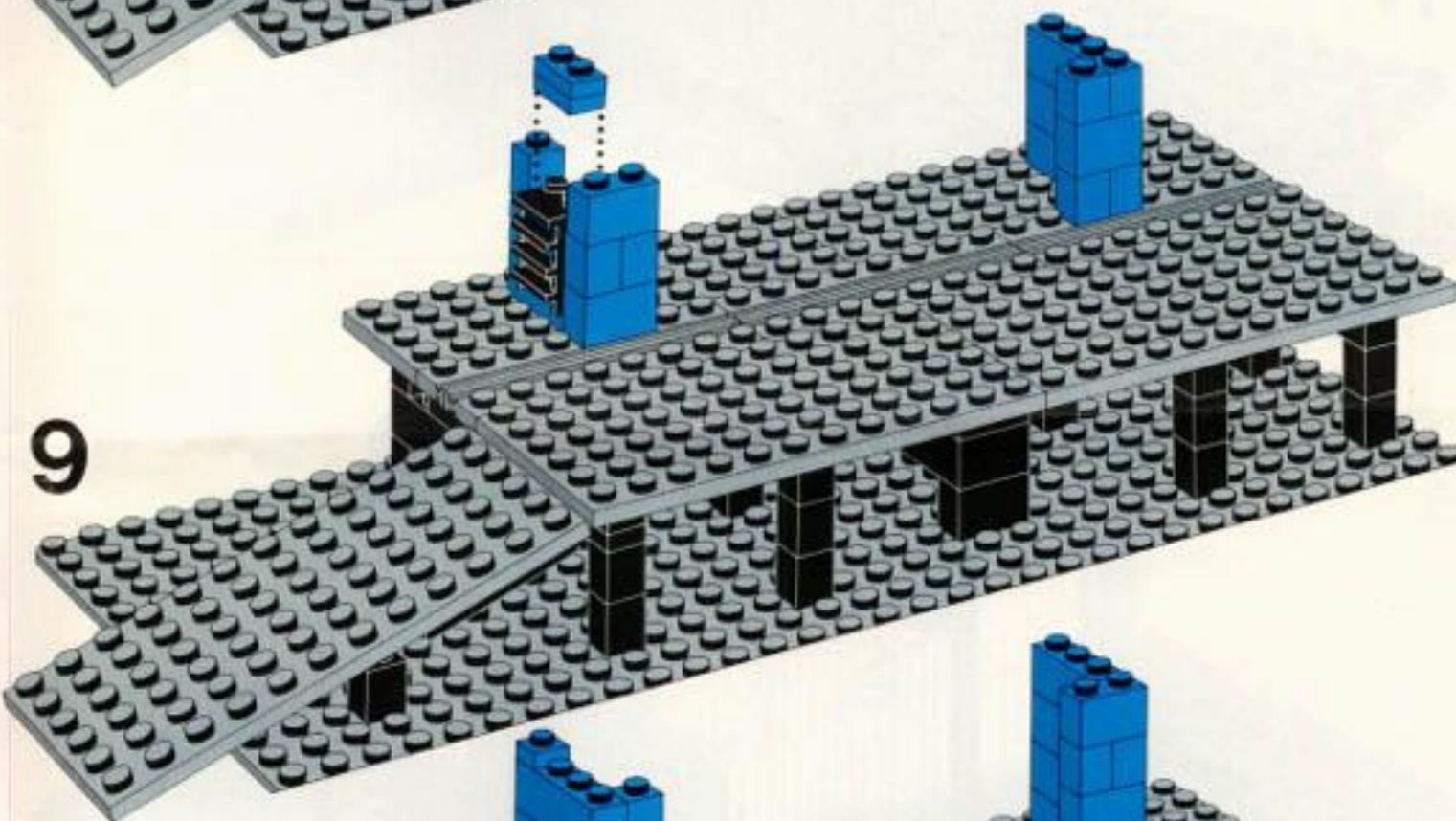

10

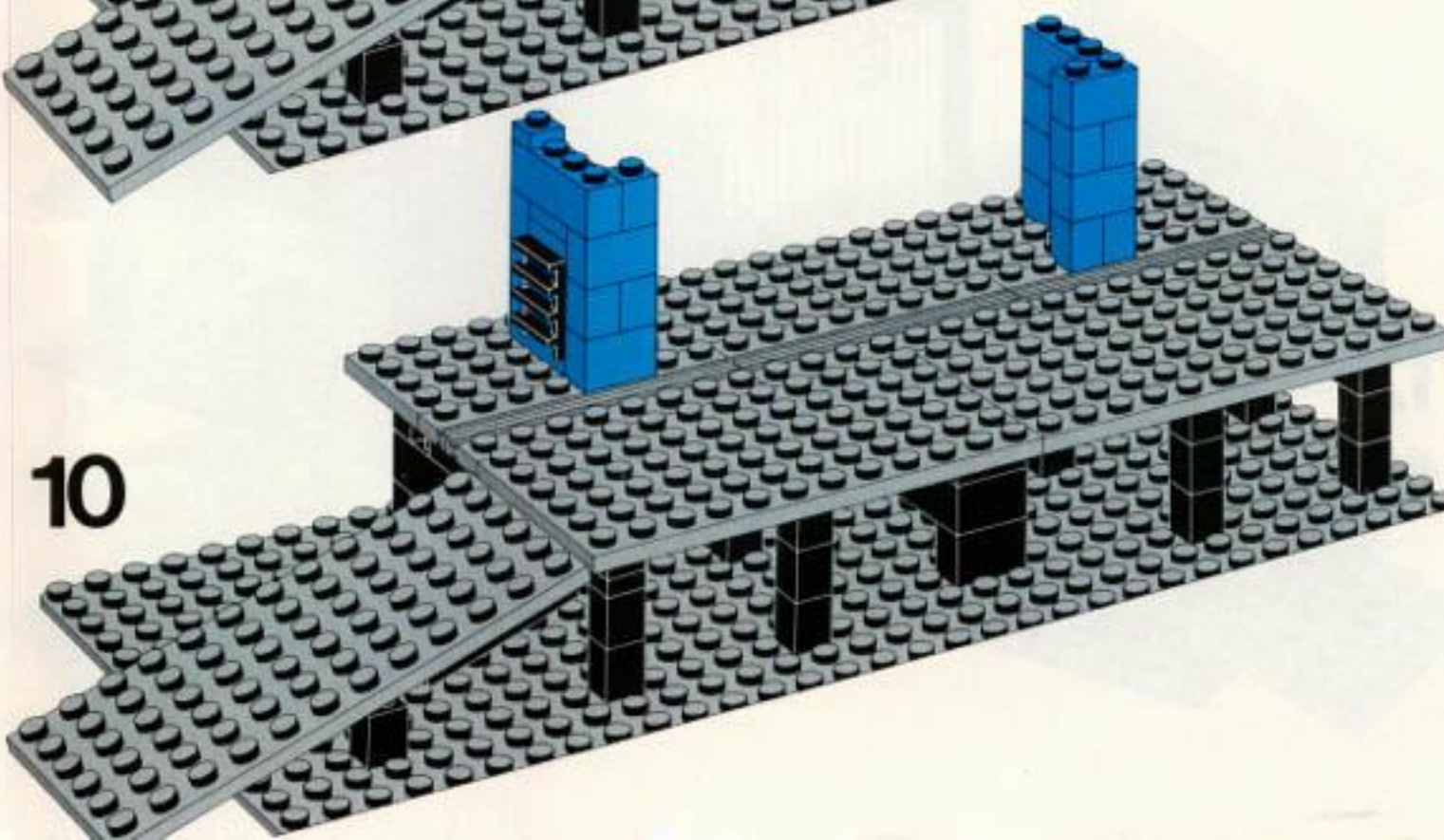

11

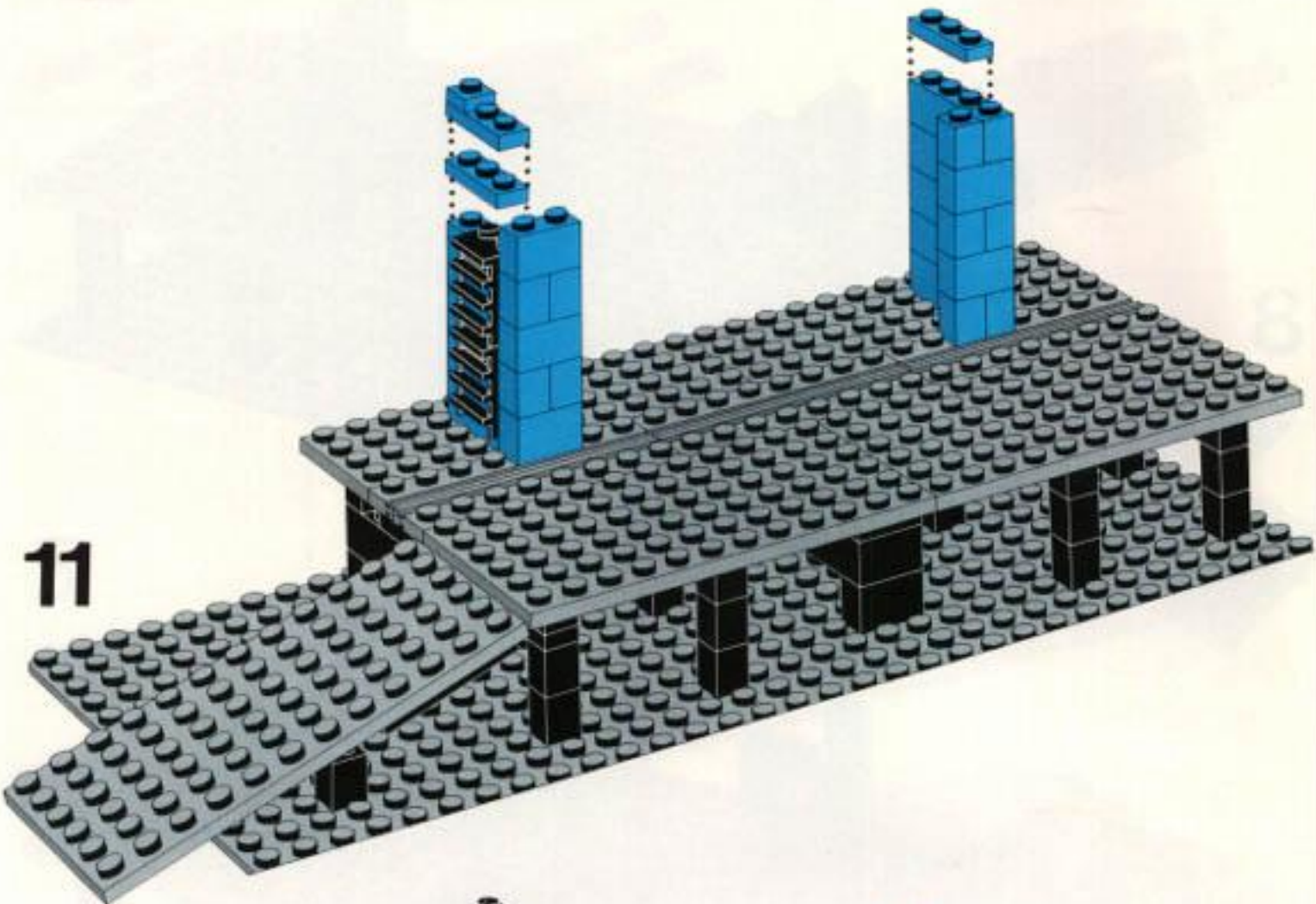

12

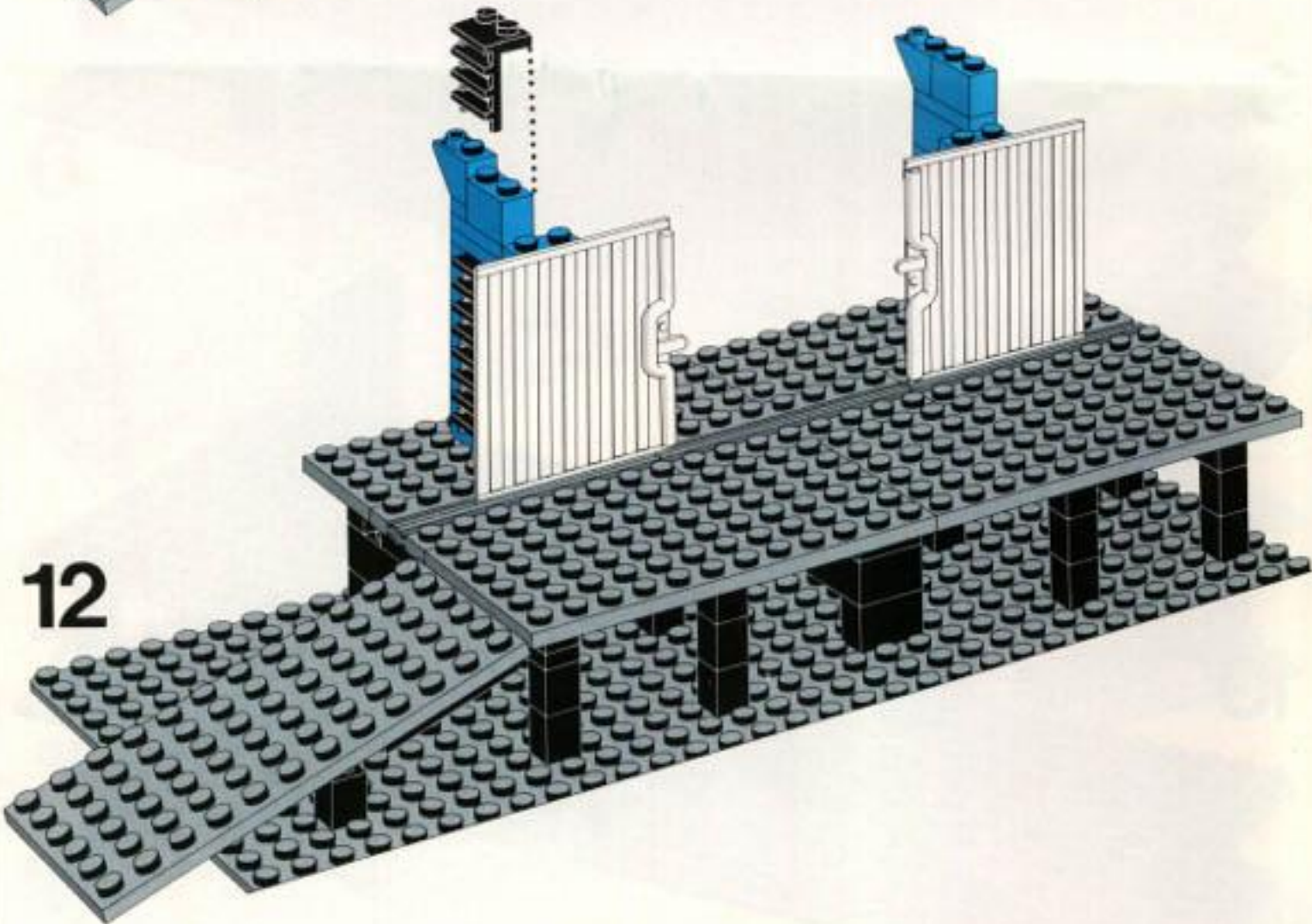

14

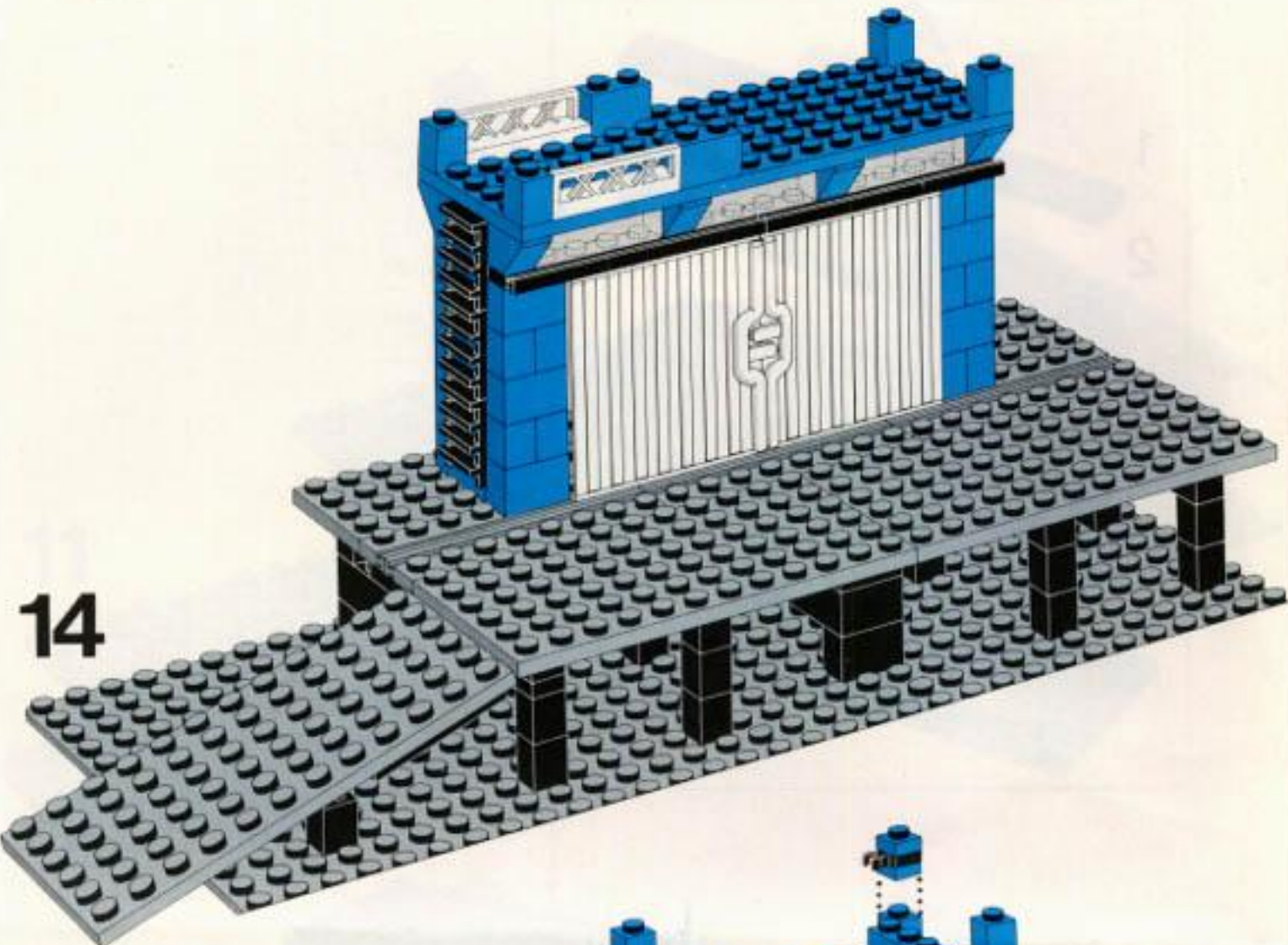

15

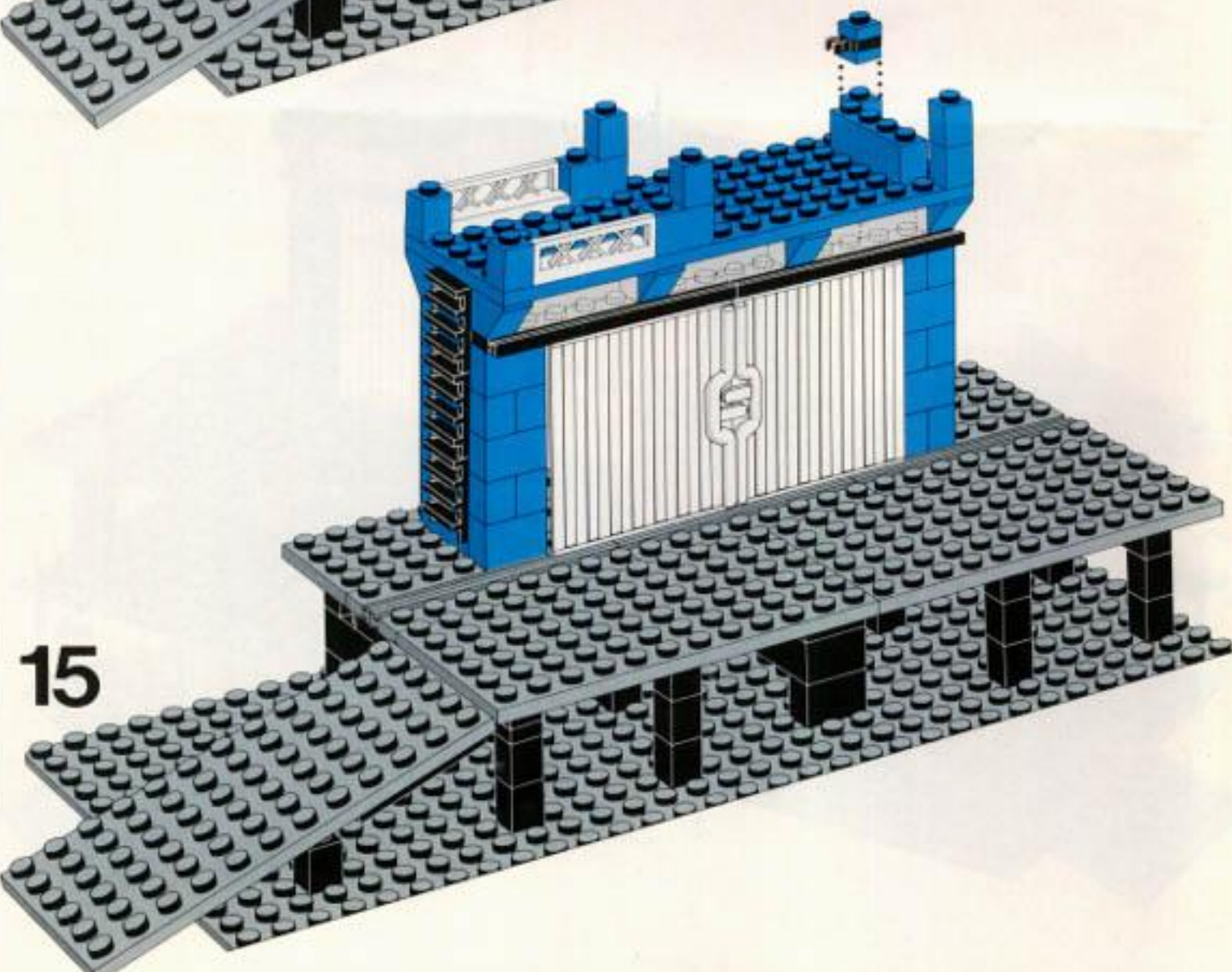

16

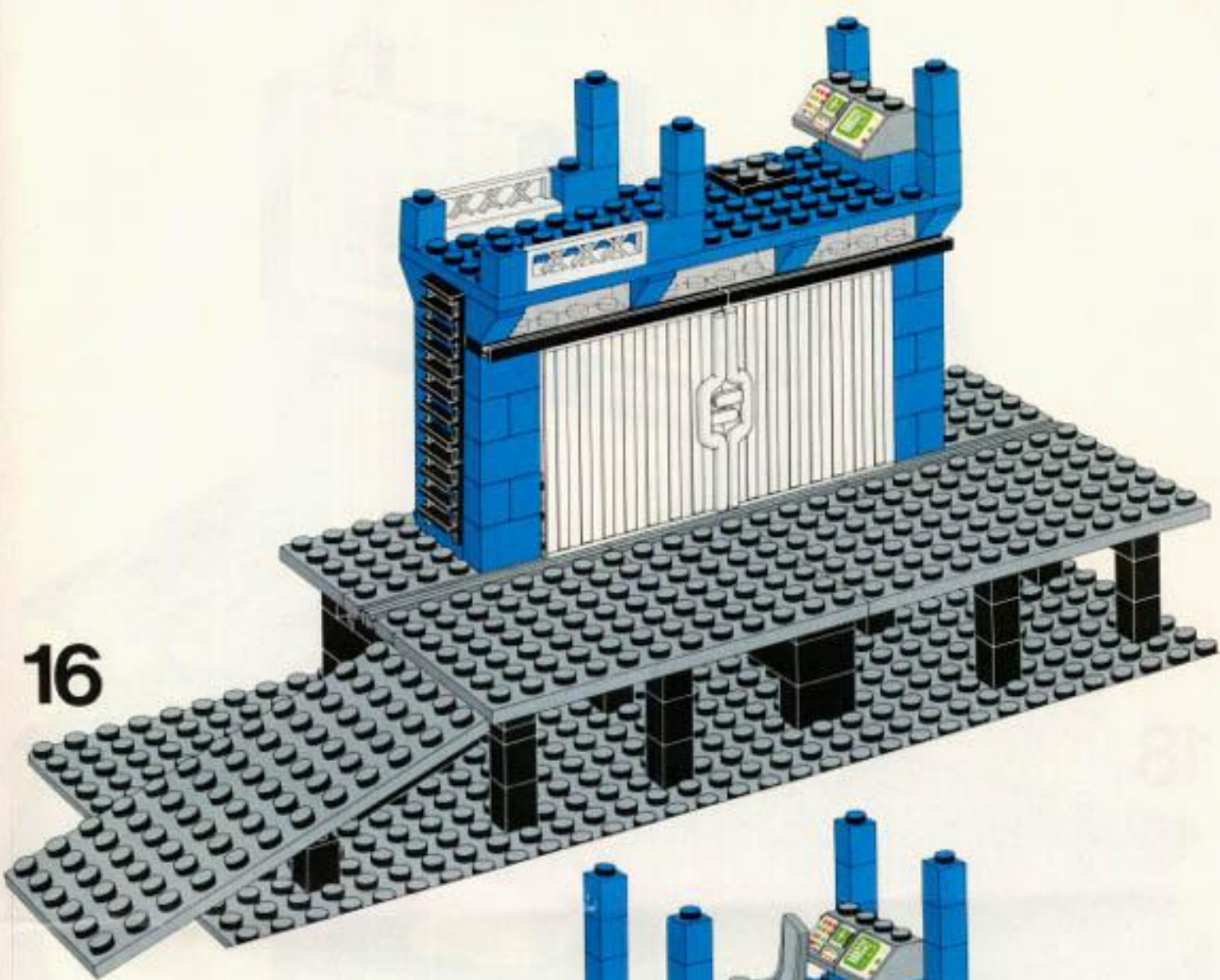

17

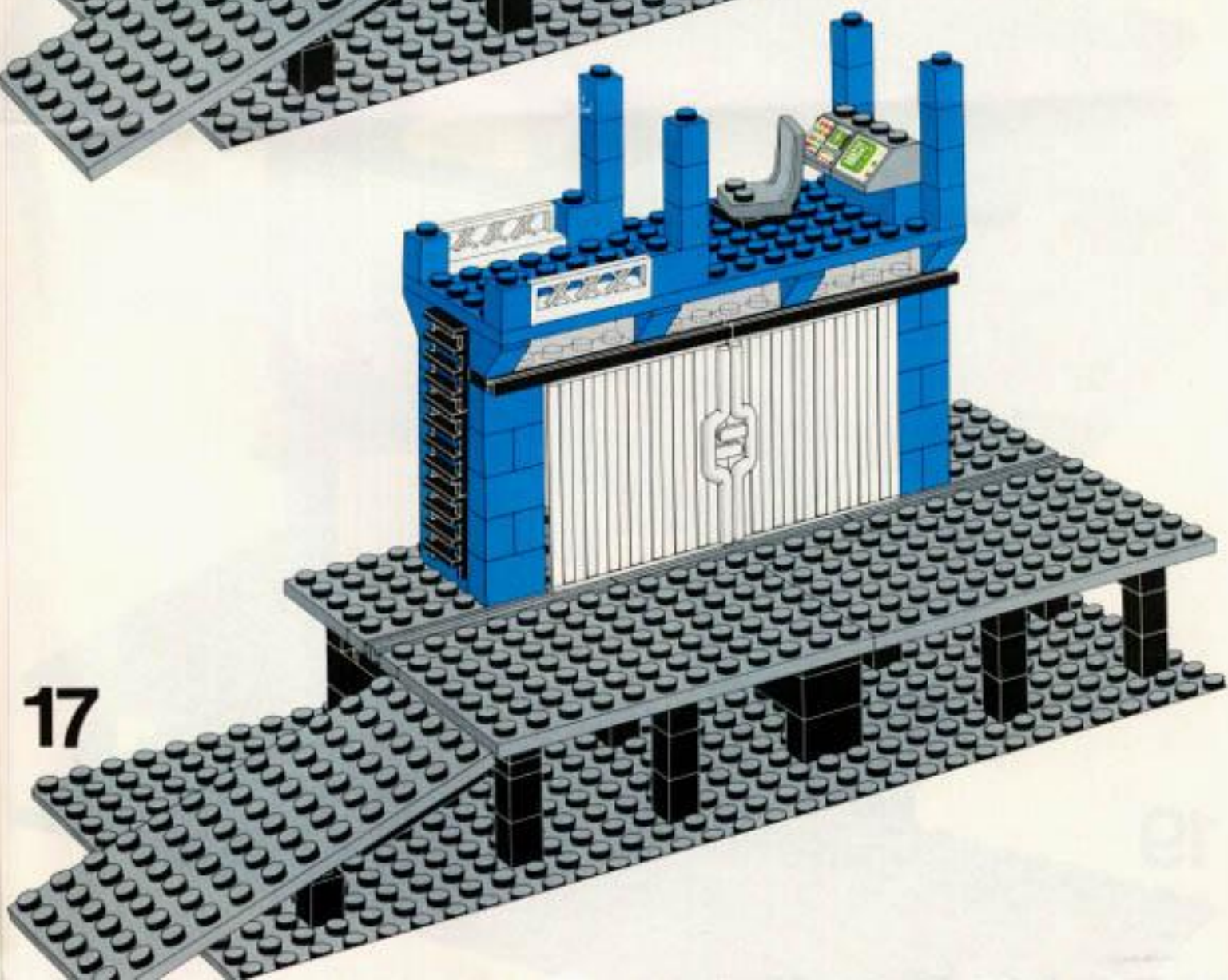

18

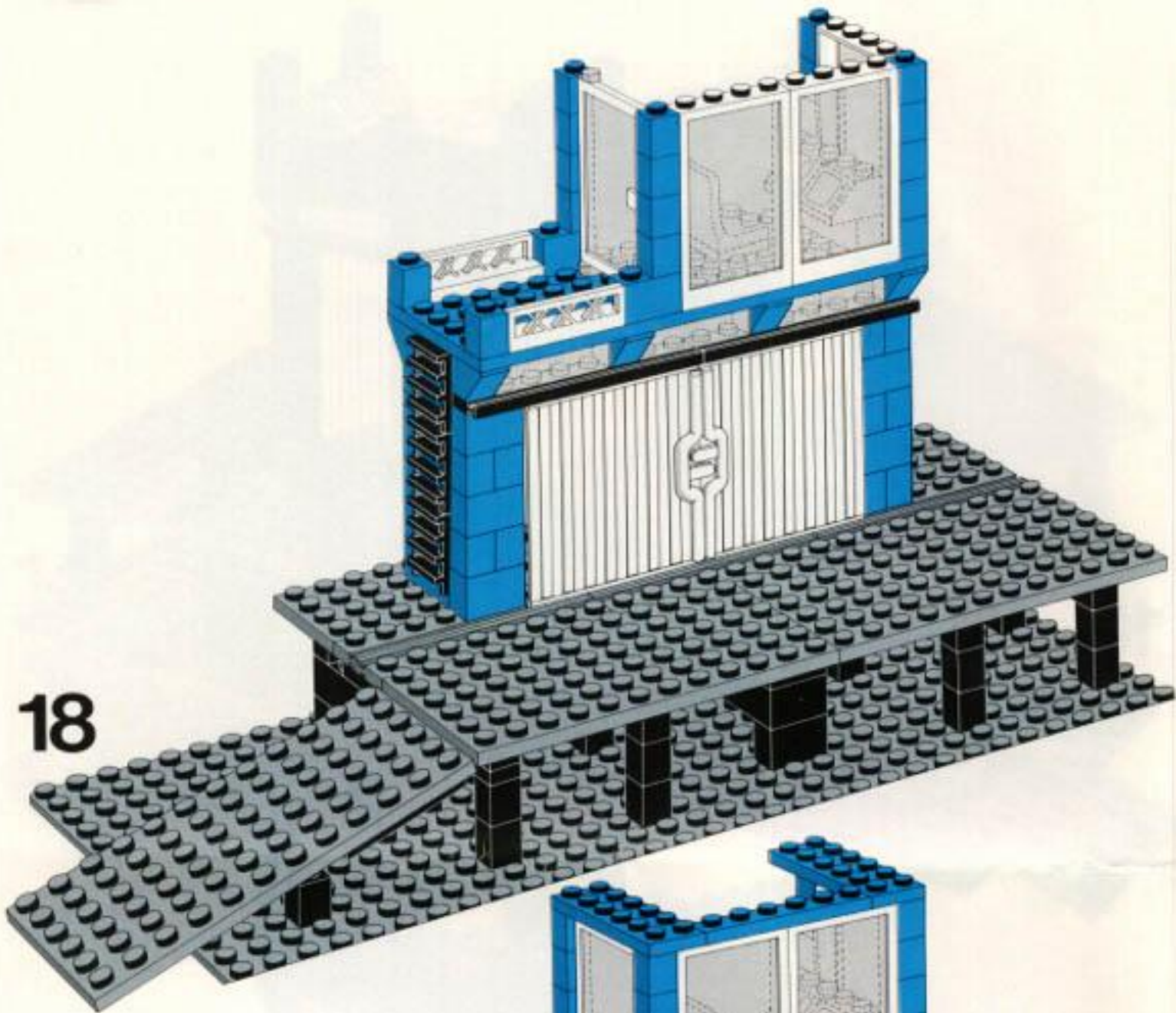

19

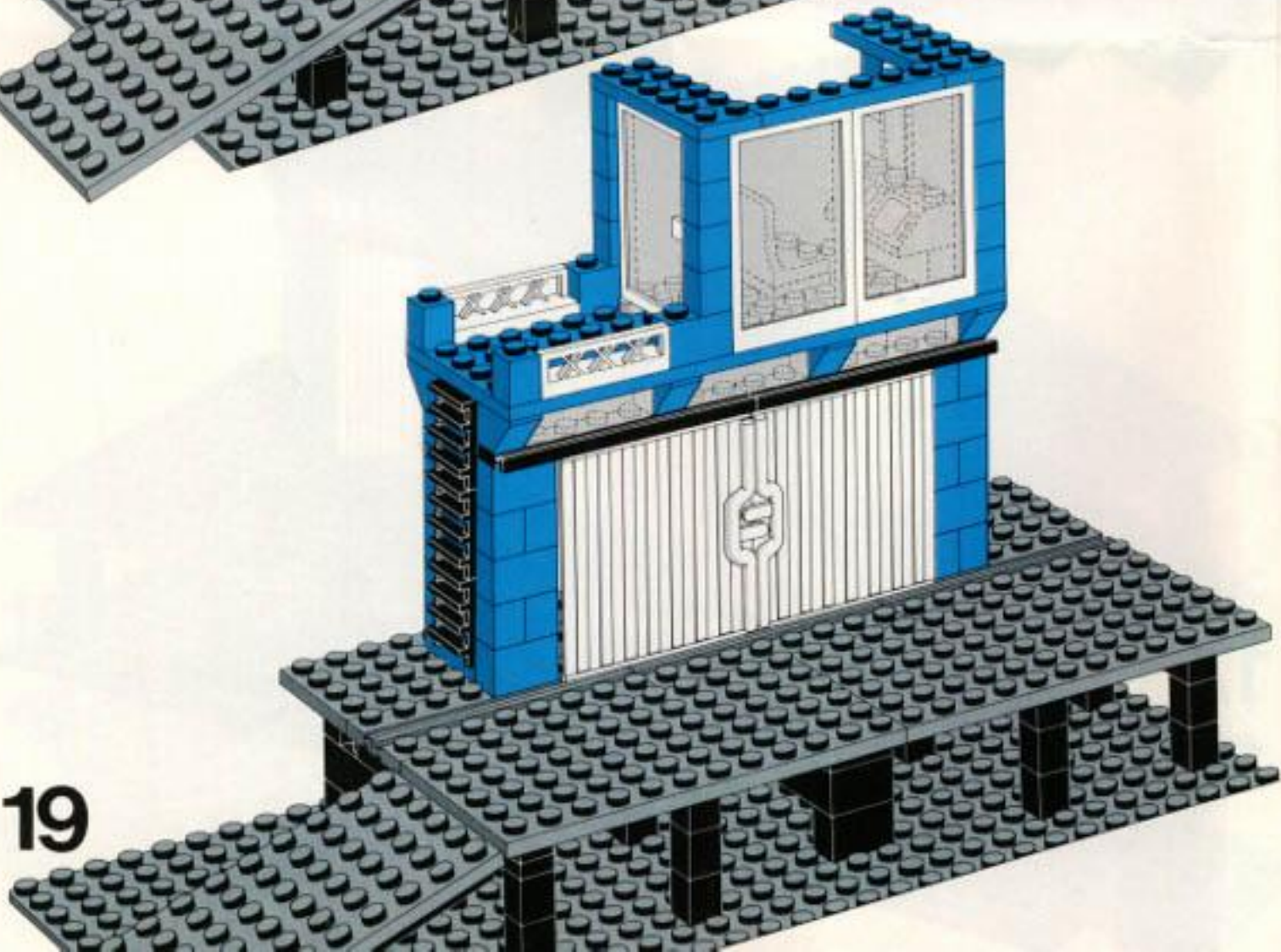

20

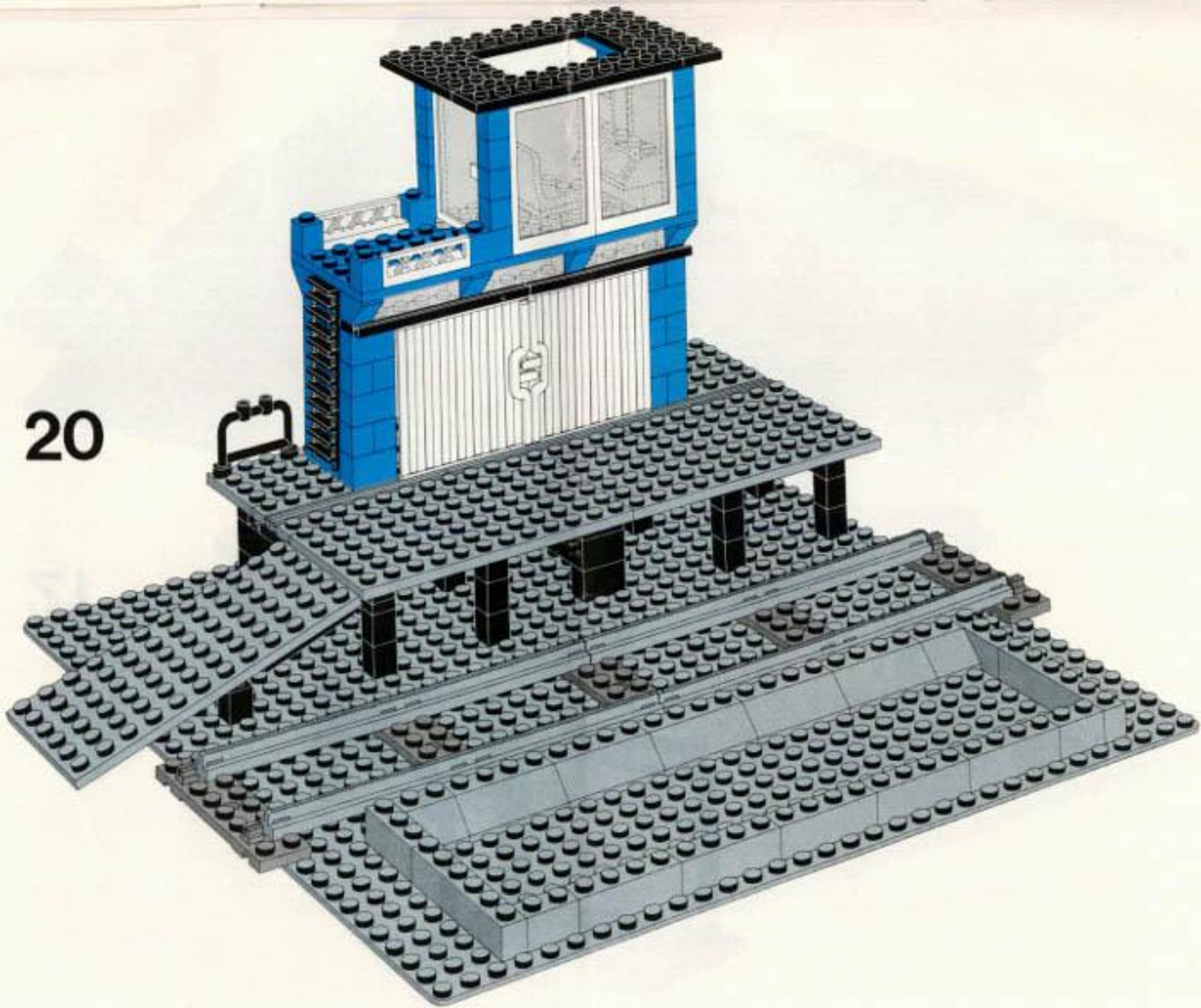

21

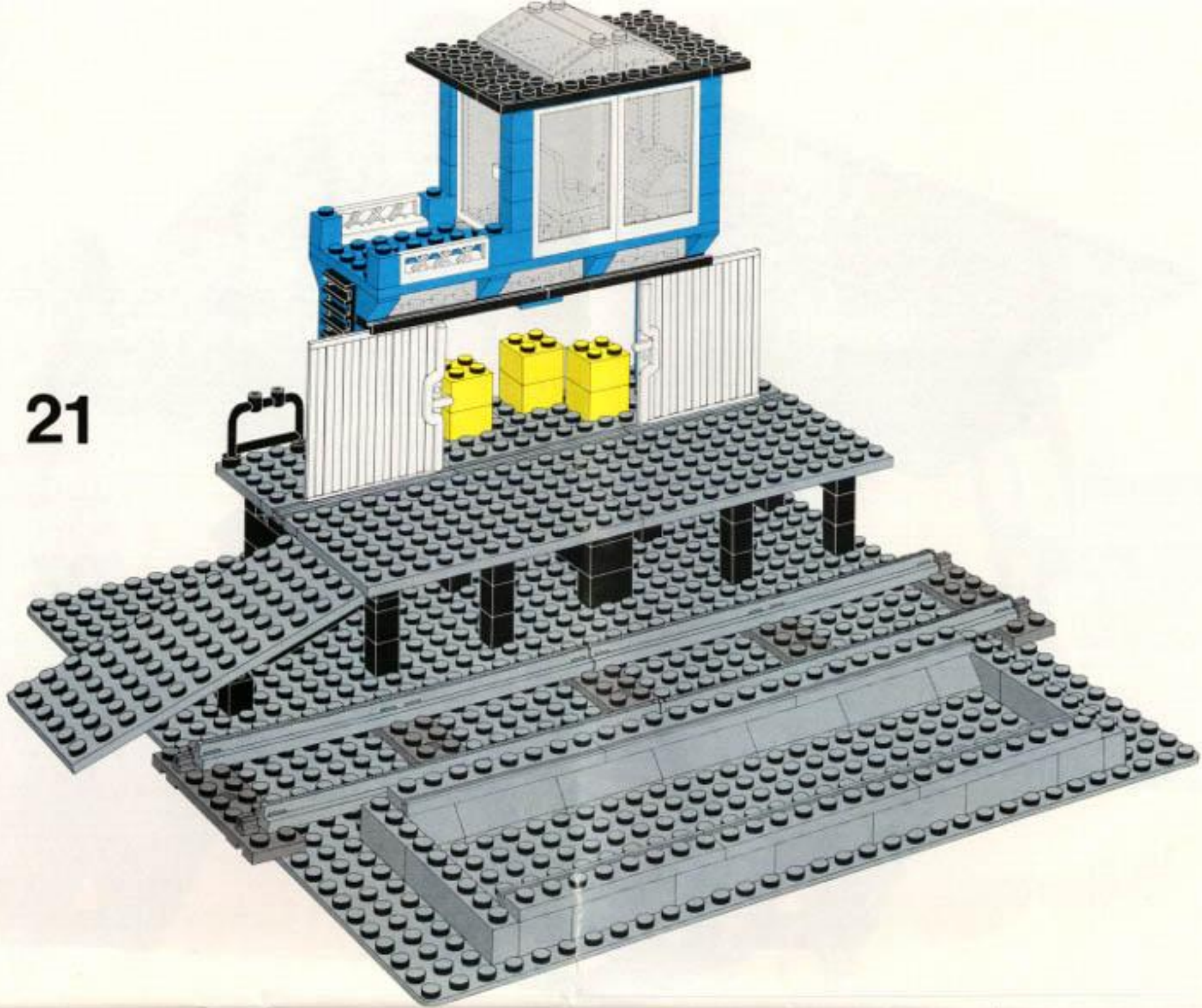

22



