

BIONICLE

www.bionicle.com



8756

SIDORAK





LEGO

BIONICLE

1

8756

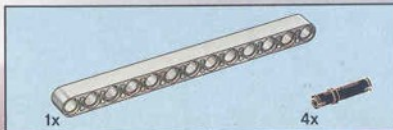

1

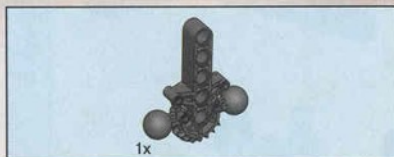
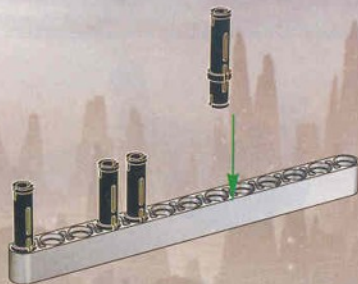

2

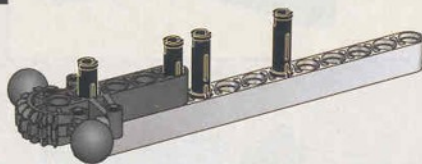

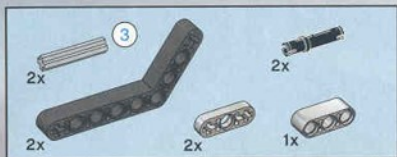

3

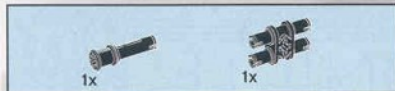
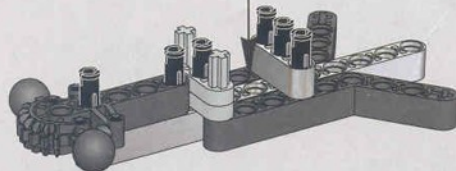
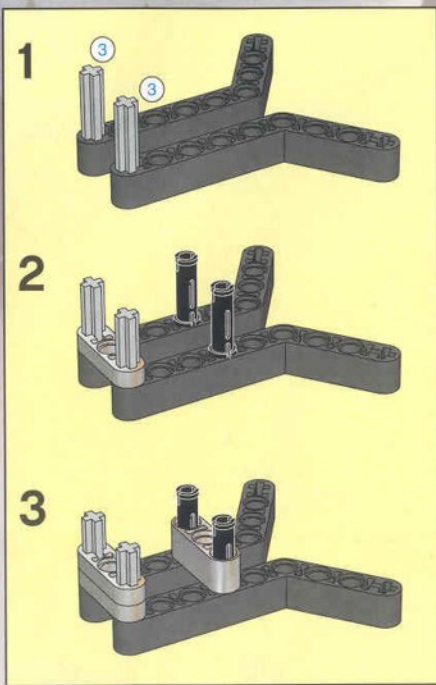

4

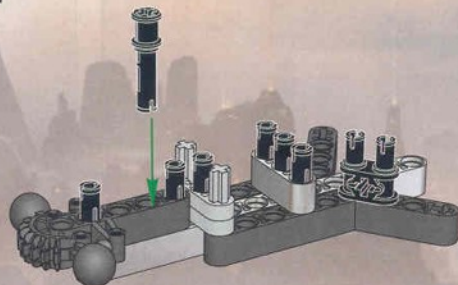

5

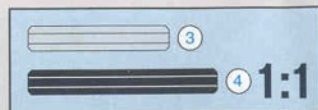
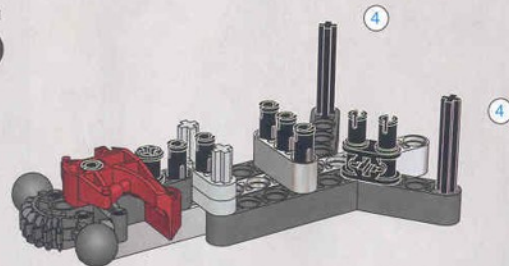

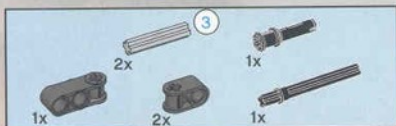

6

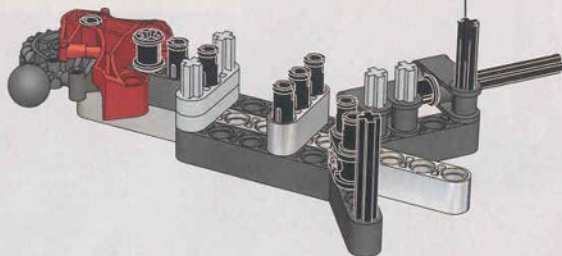
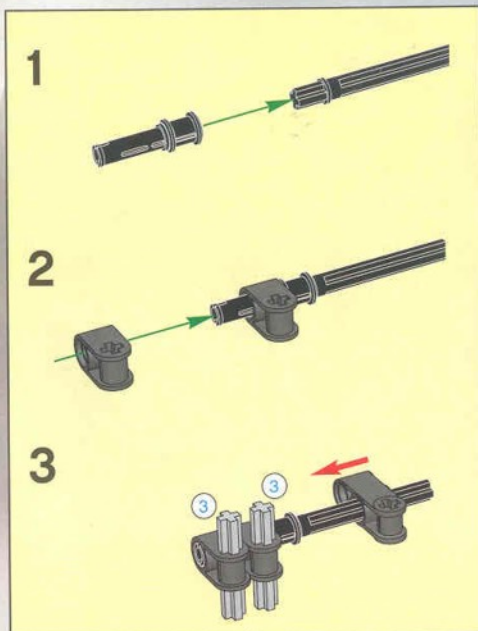

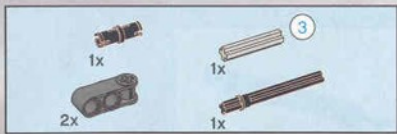

7

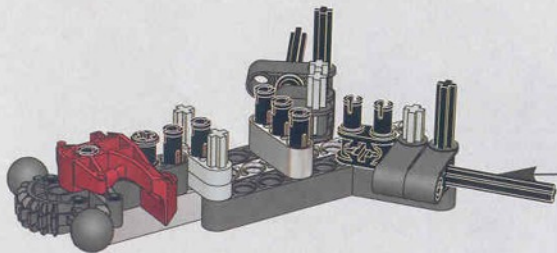
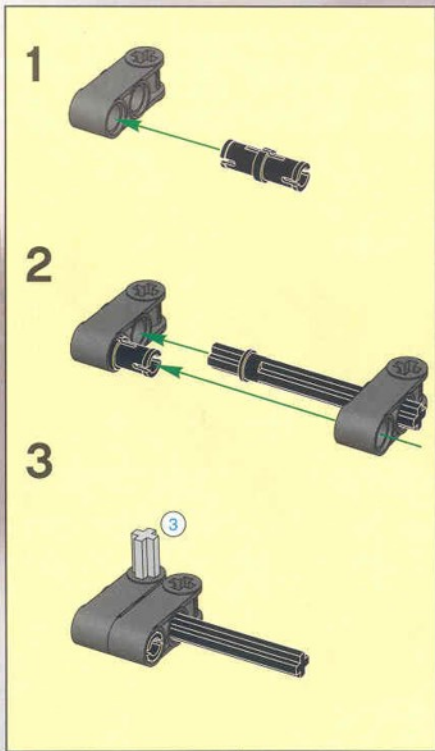

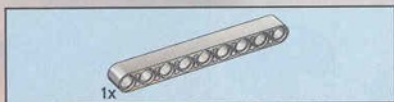

8

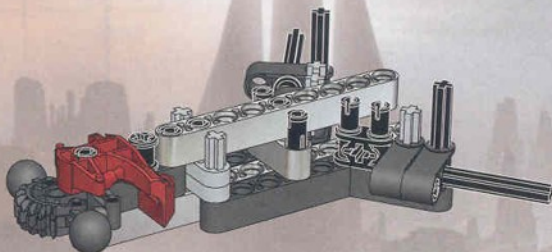

9

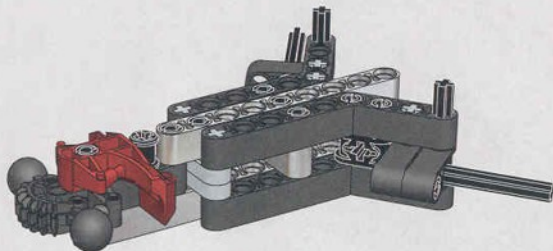



10

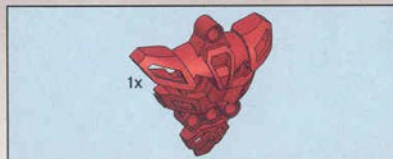
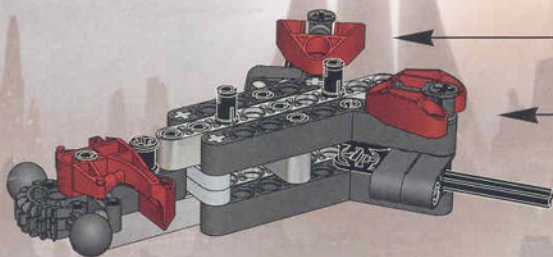
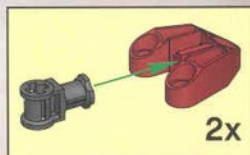

11

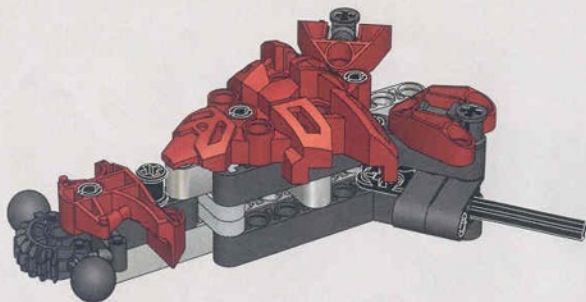



12

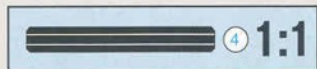
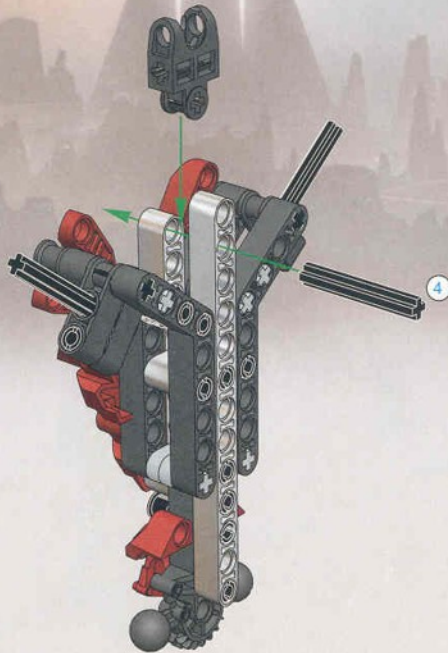



1x

13

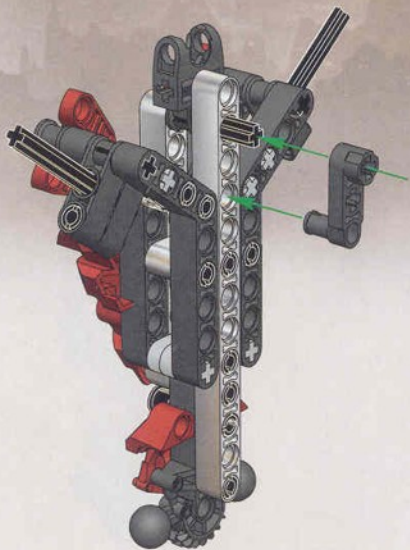



14

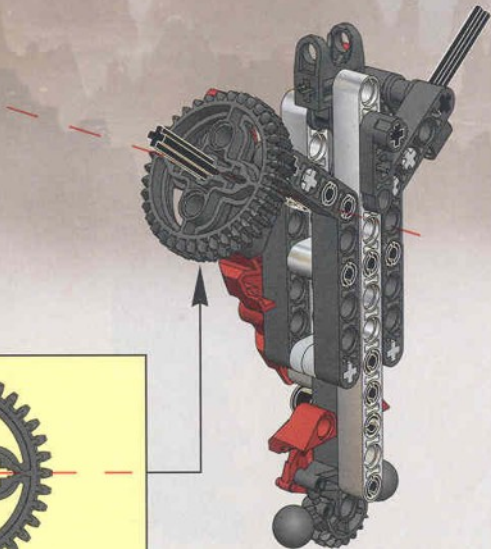
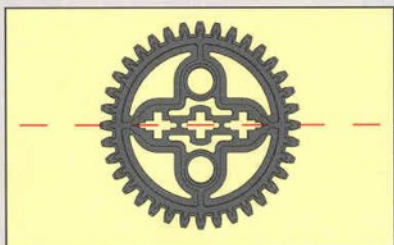



15

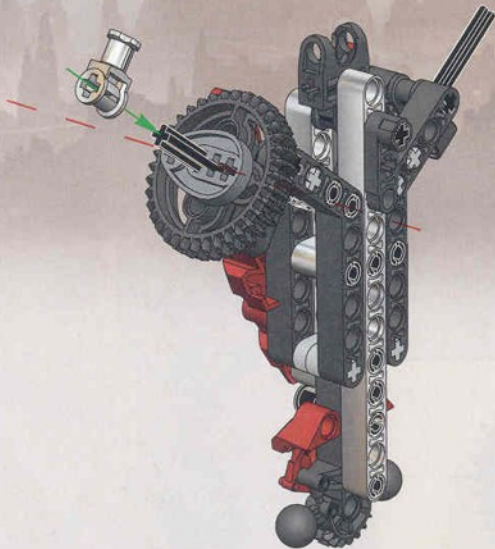

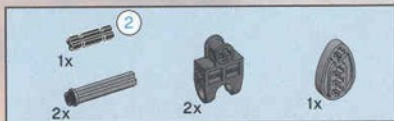

16

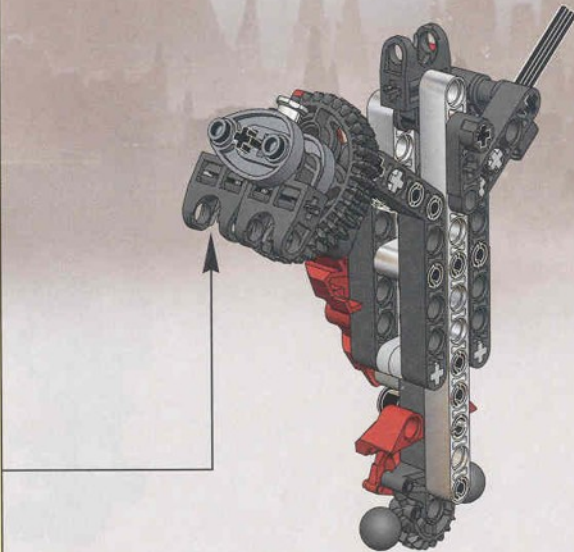
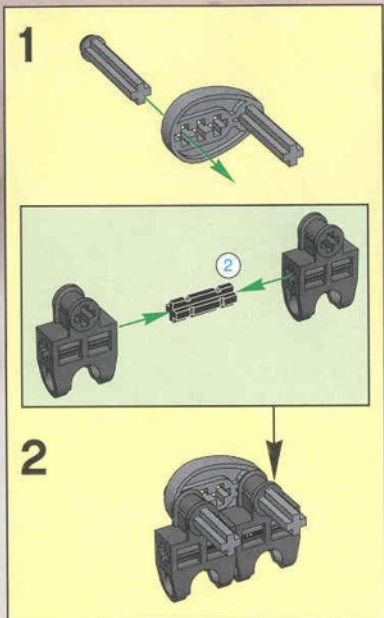



1x

17

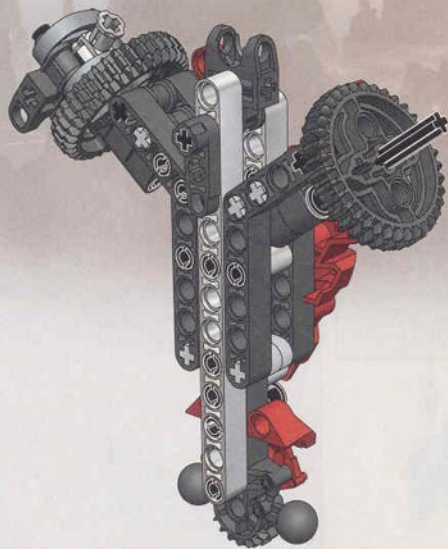



18

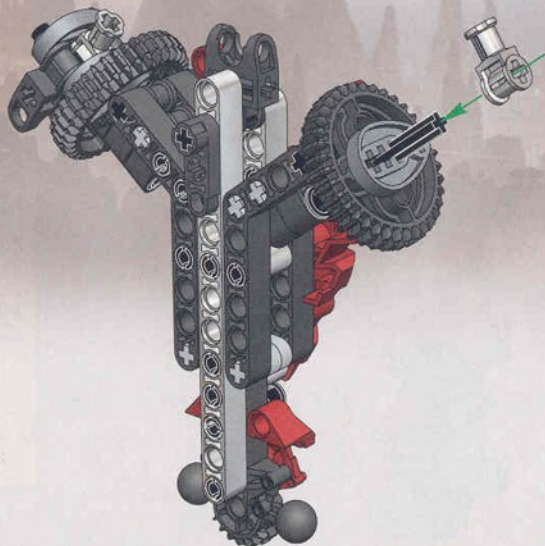



19

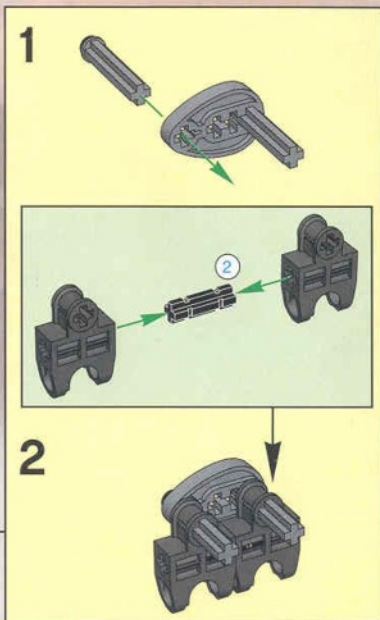
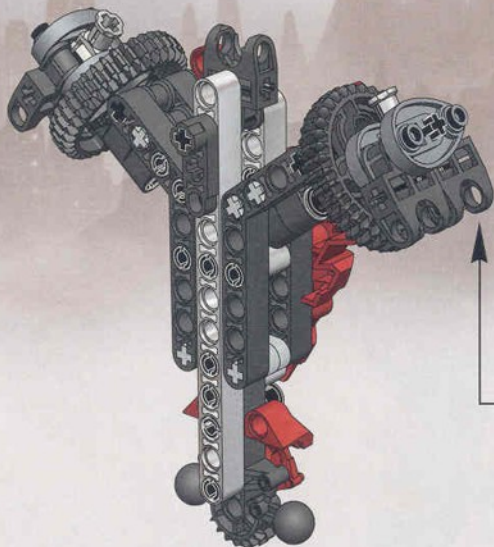

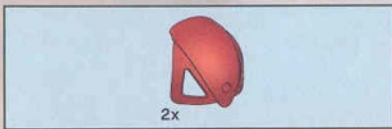

20

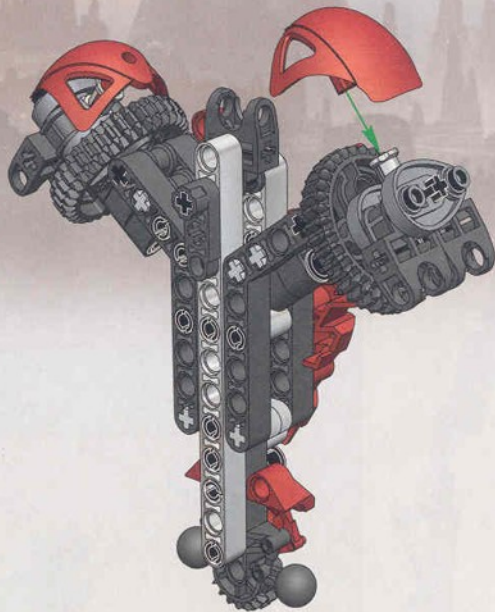

BIONICLE

2

8756

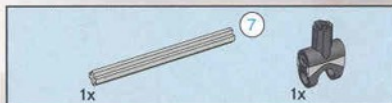

1

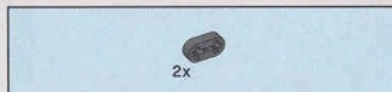
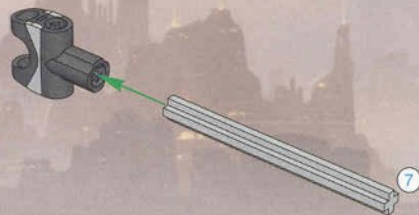

2

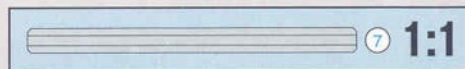
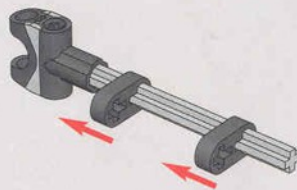



3

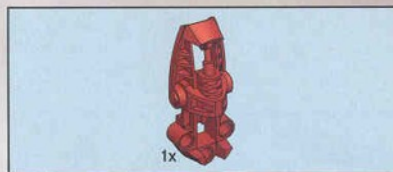
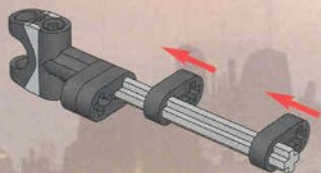

4

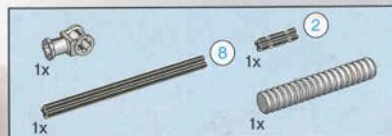
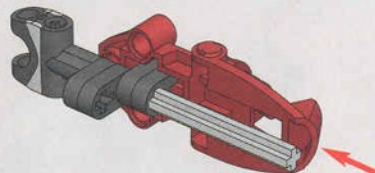

5

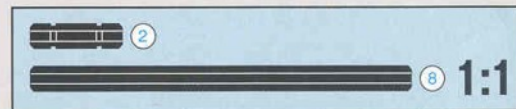
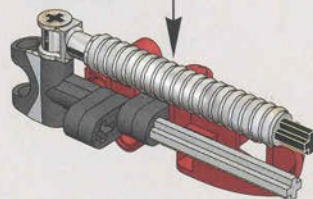
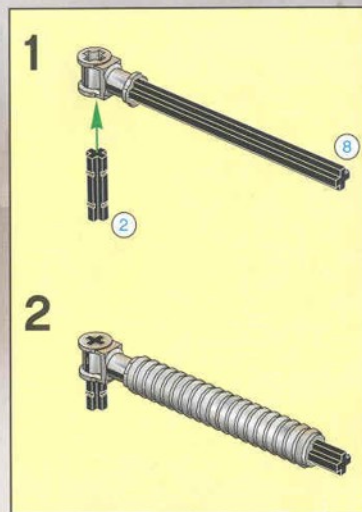

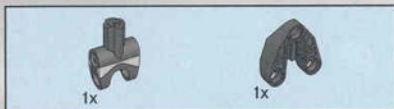

6

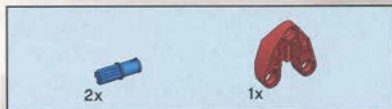
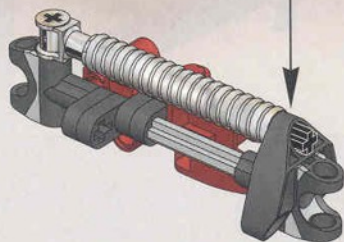
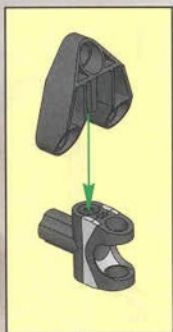

7

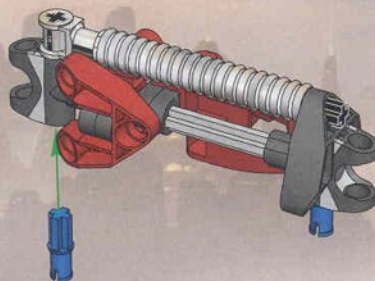

8

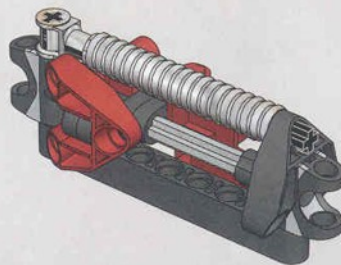

21

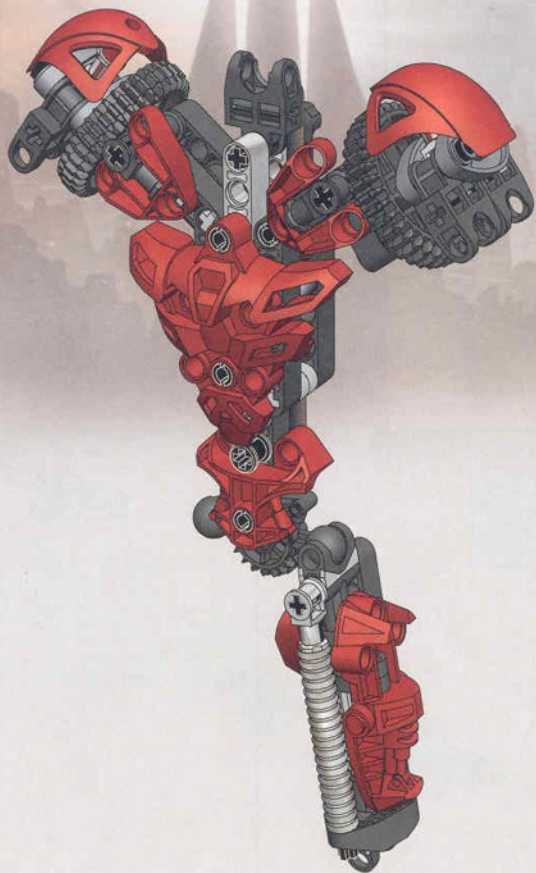

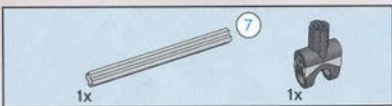
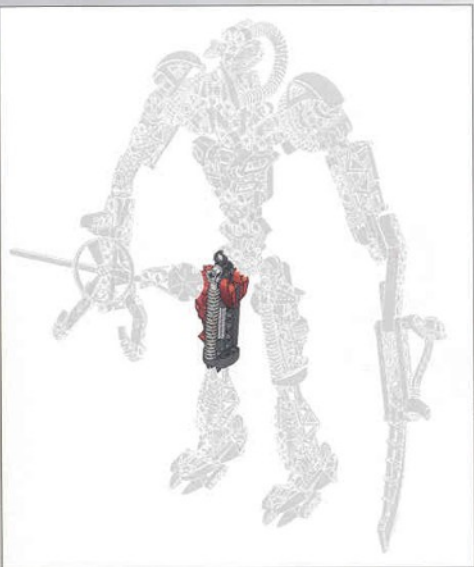

1

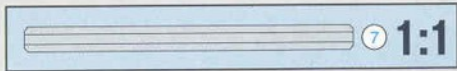
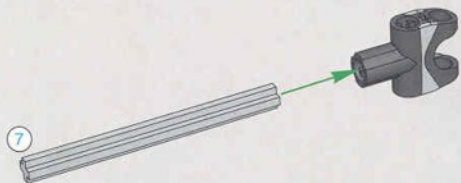

2

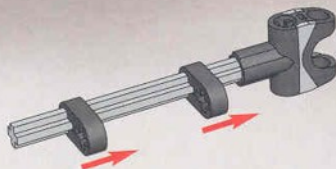

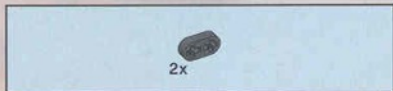

3

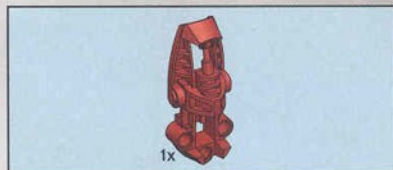
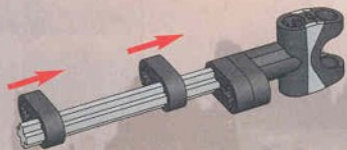

4

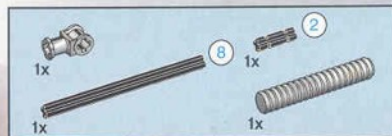
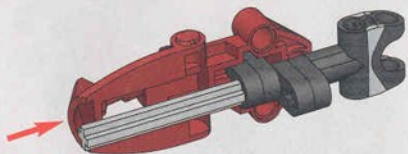

5

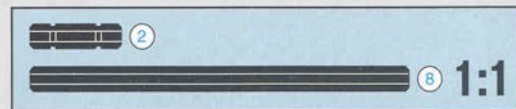
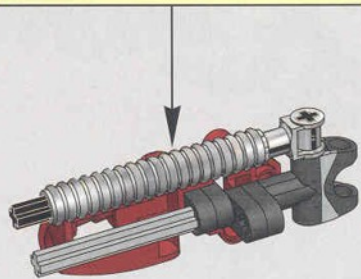
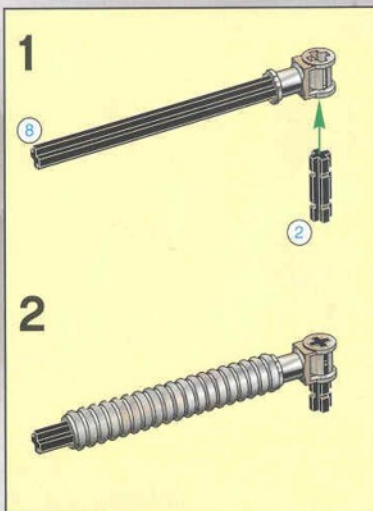

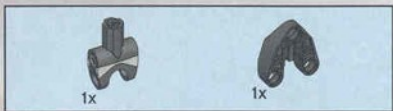

6

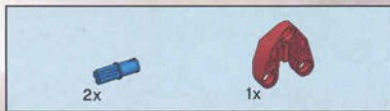
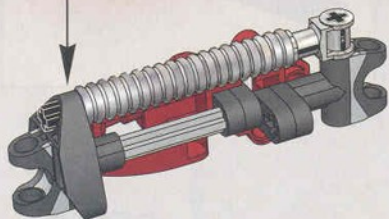

7

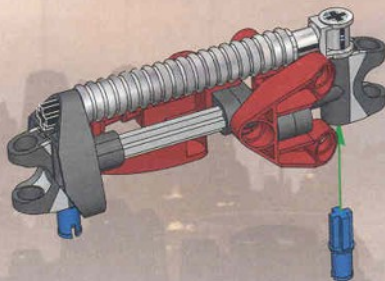

8

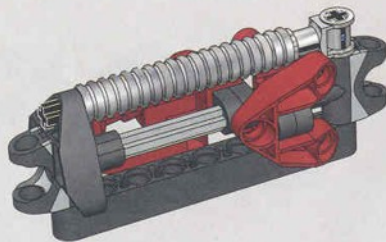

22

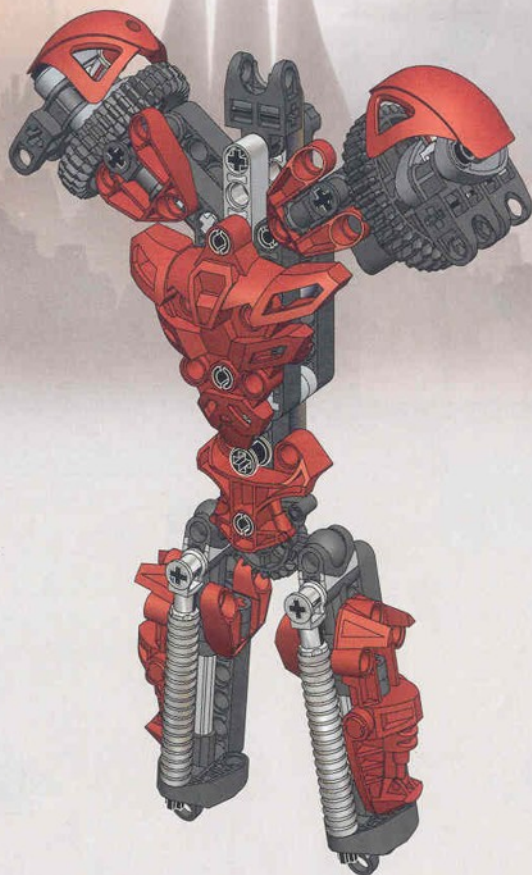



1

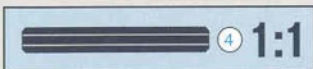
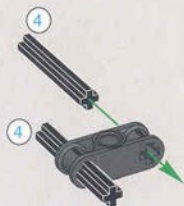

2



3

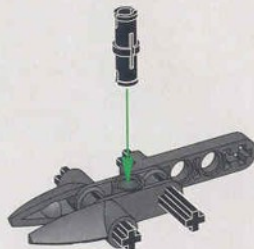

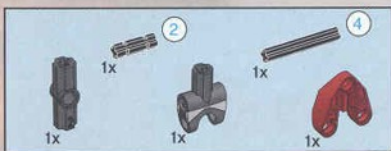

4

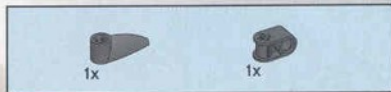
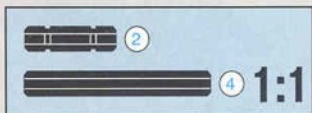
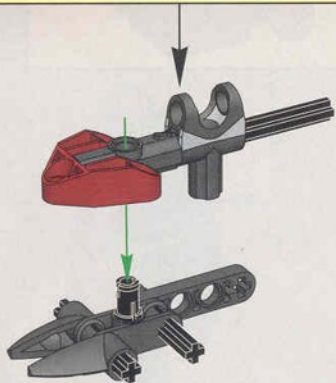
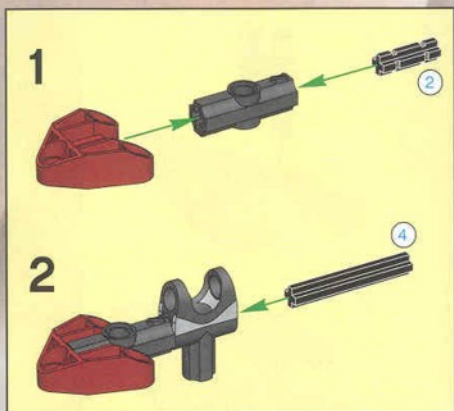

5



6

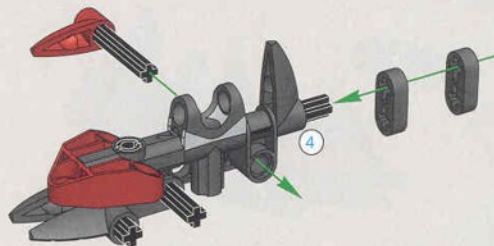



7

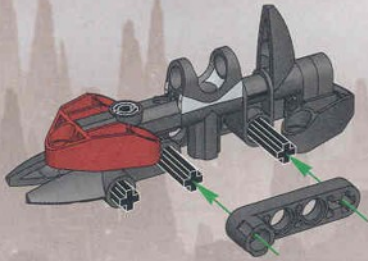

8

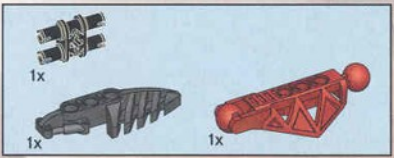
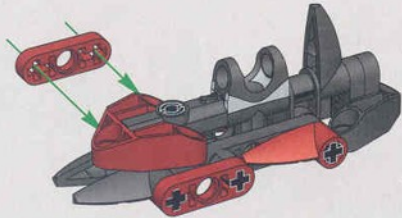

9

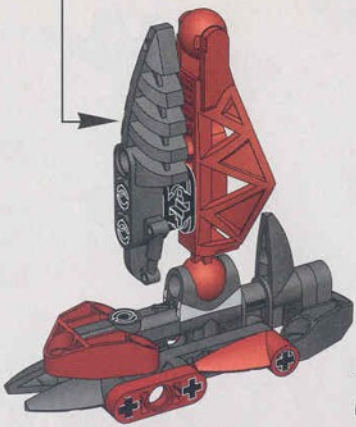
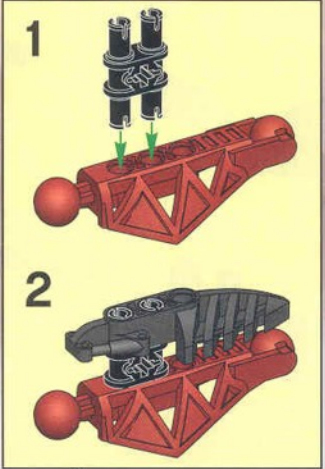

2x

23



BIONICLE

3

8756



1

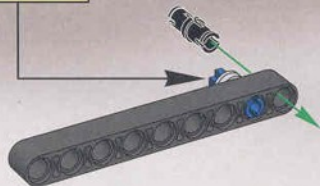

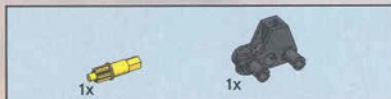

2

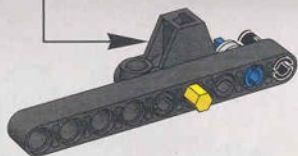

3

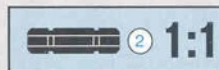
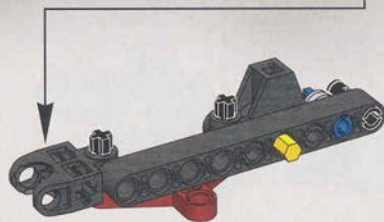
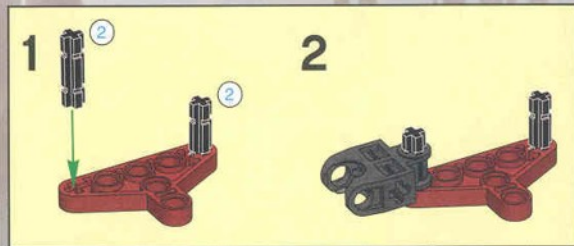



4

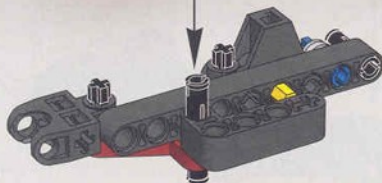
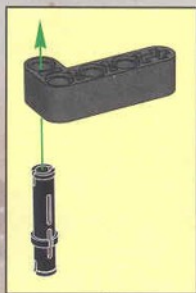

5

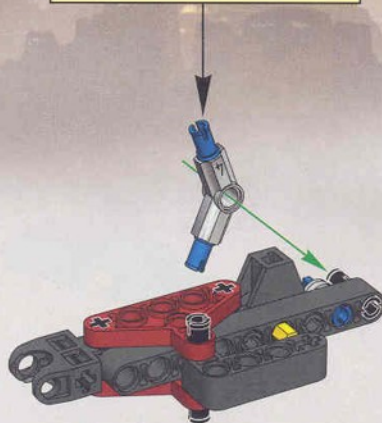
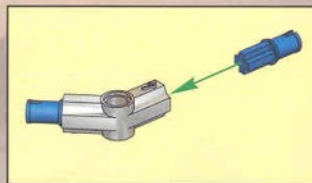

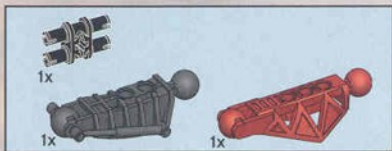

6

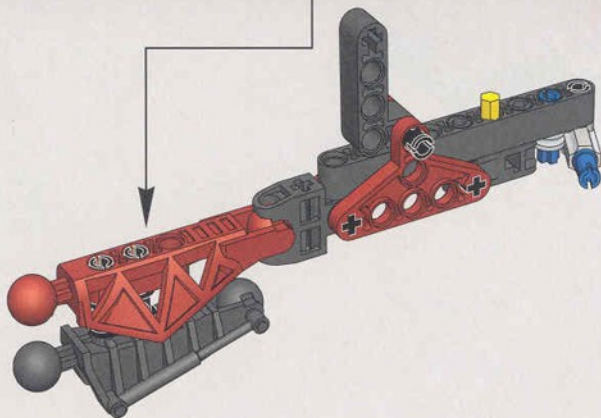
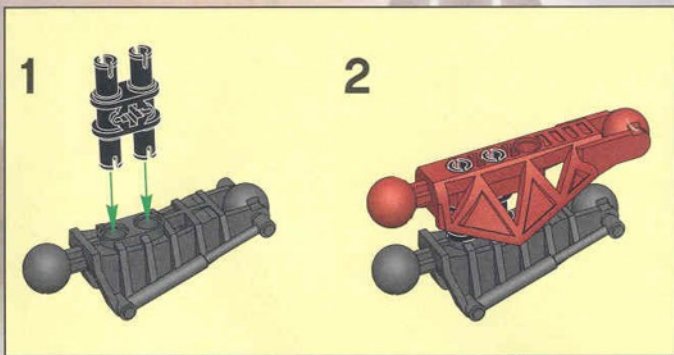



2x

7

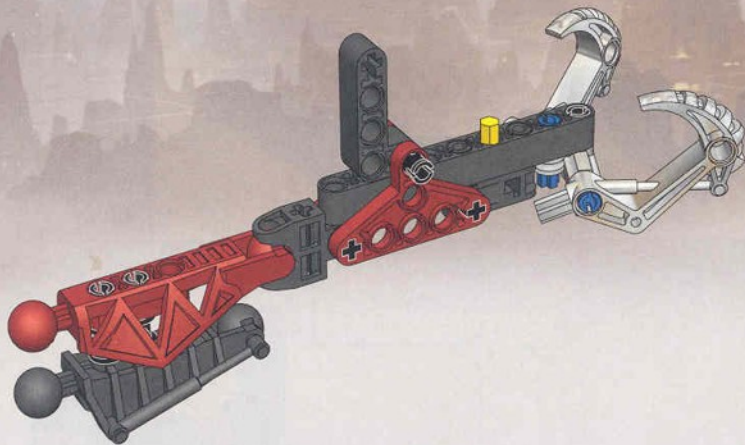

24



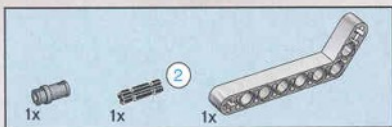
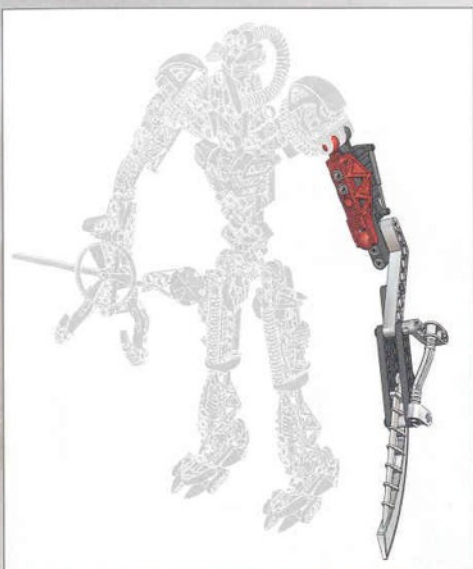

1

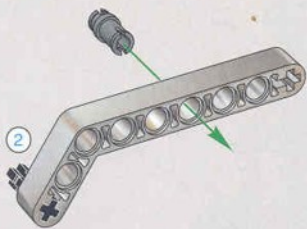

2

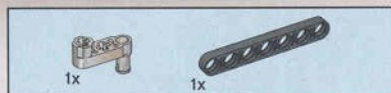
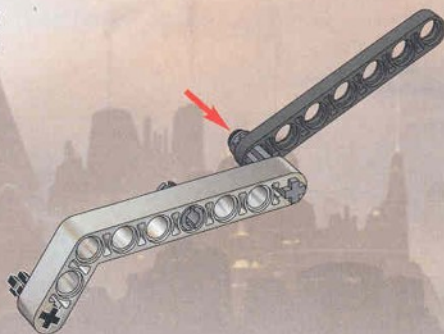

3

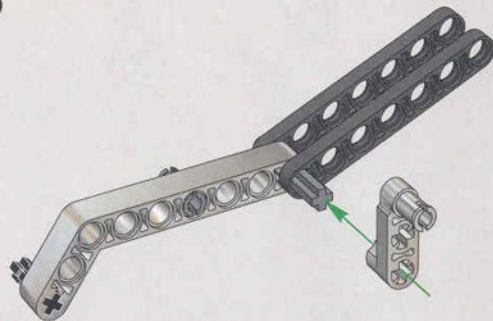

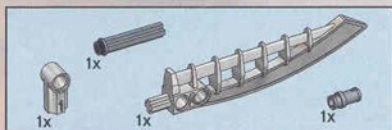

4

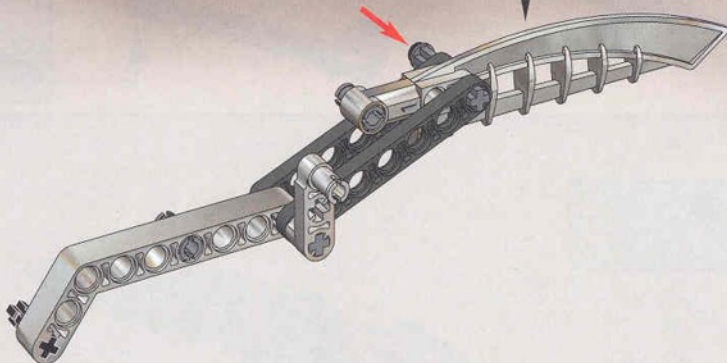



5

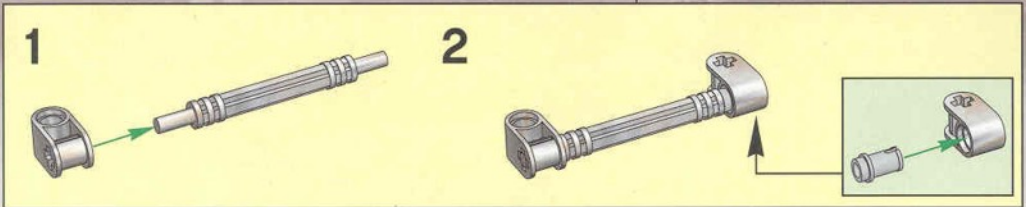
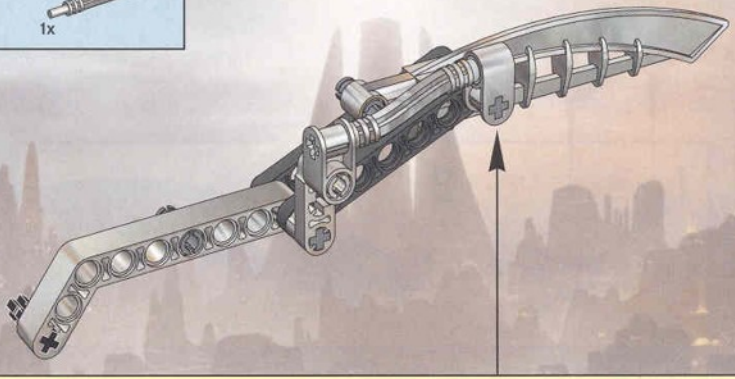

6

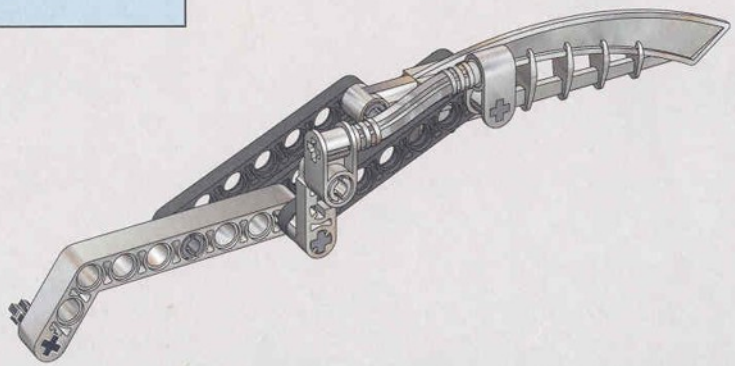

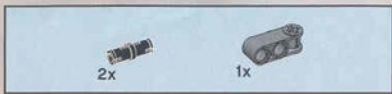

7

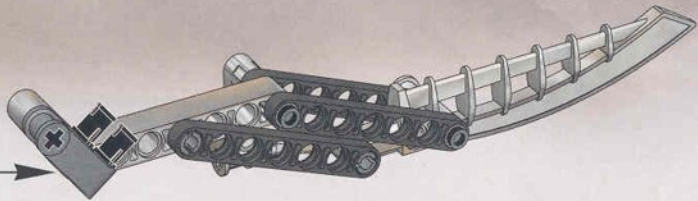
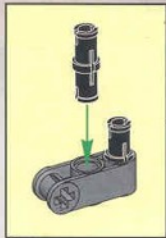

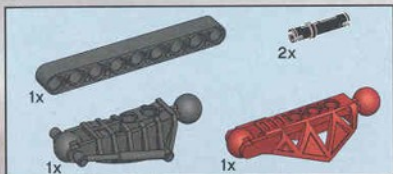

8

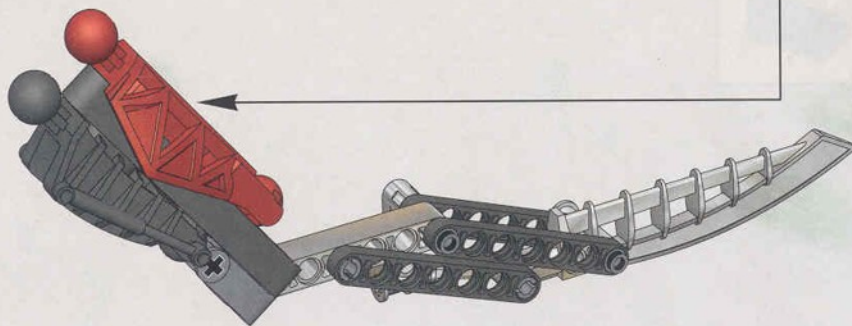
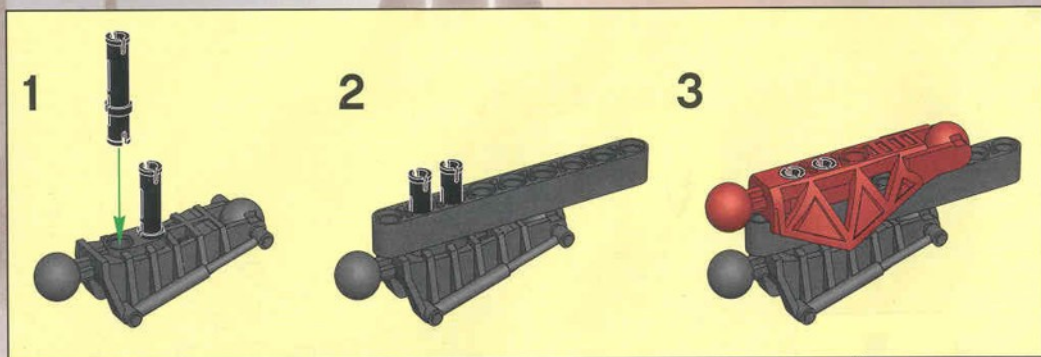

25

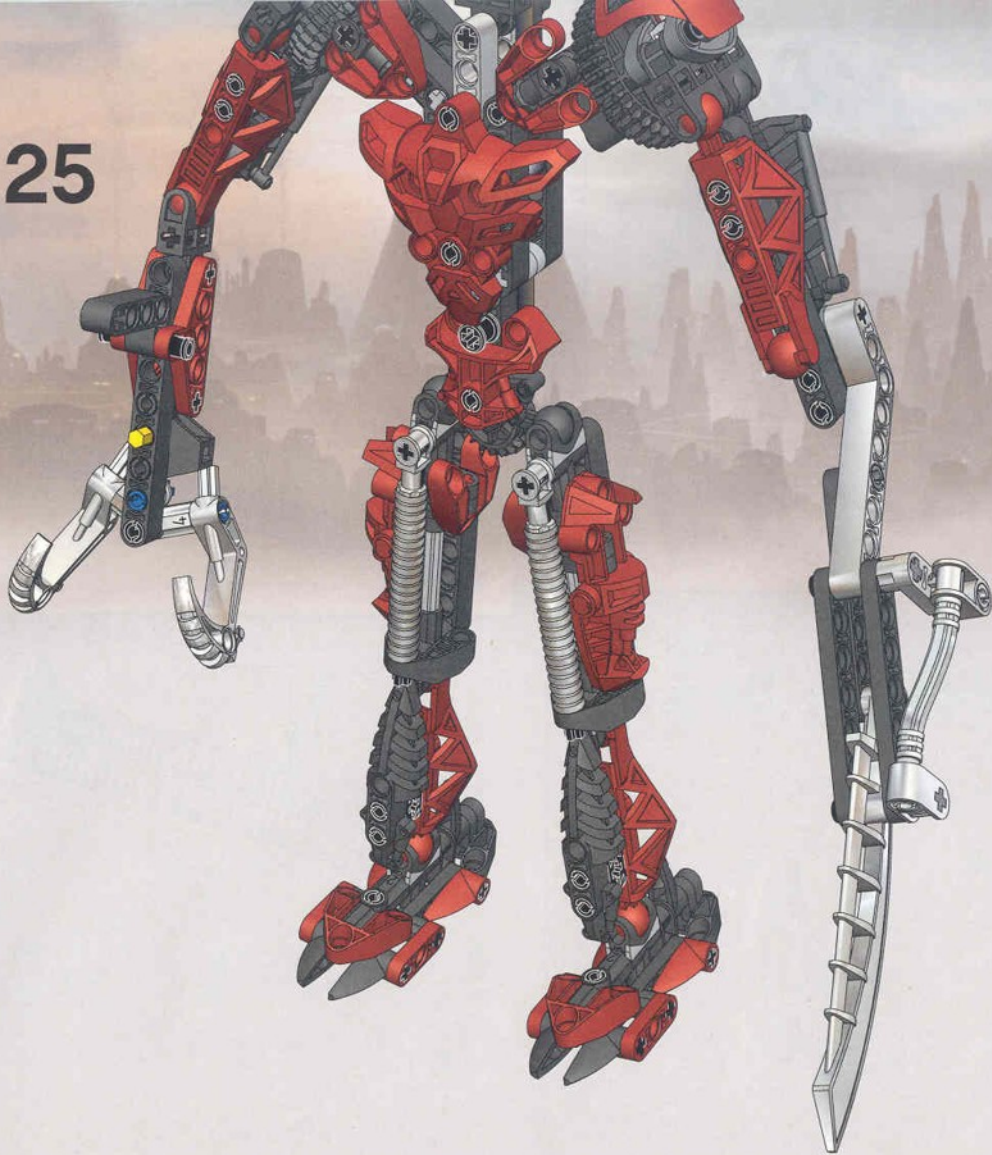

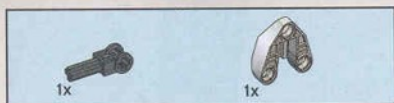
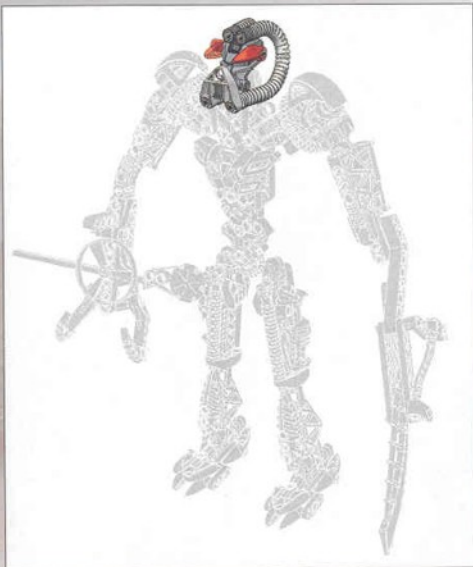

1



2

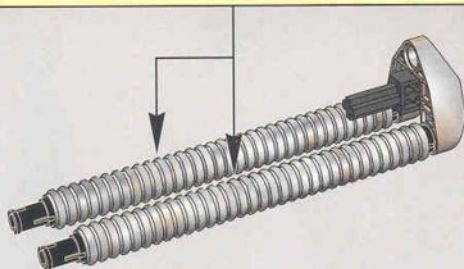
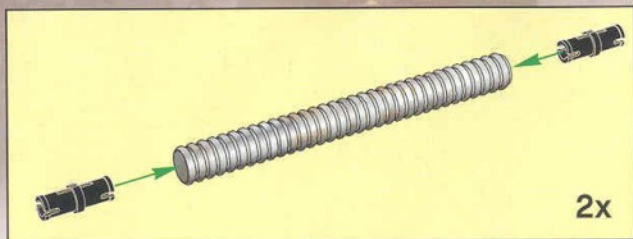



3



4

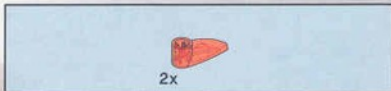
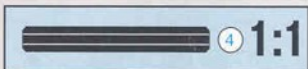
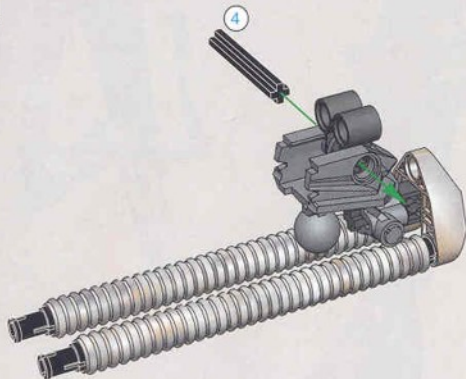

5

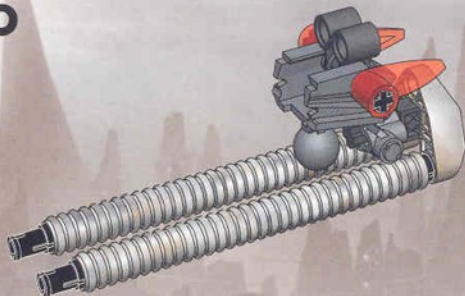

6

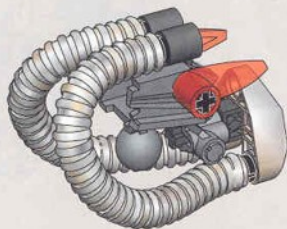

26



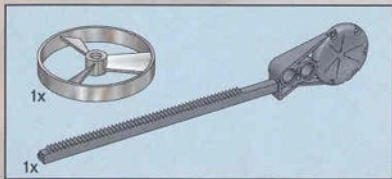

27

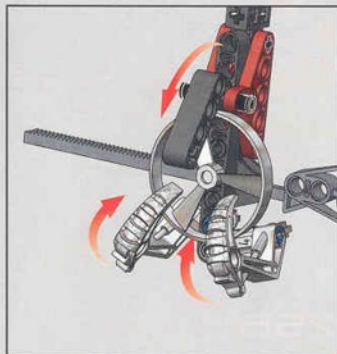
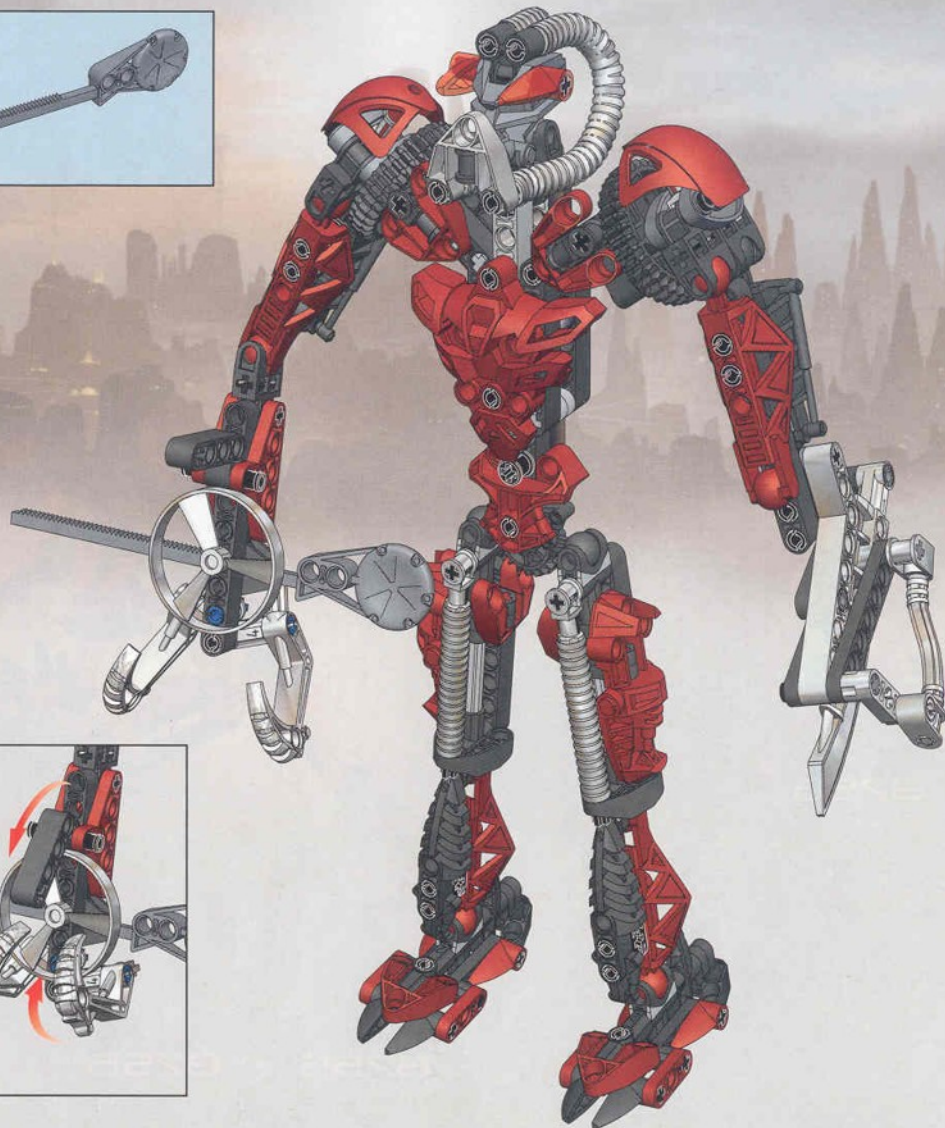



8755



8756



8755 + 8756

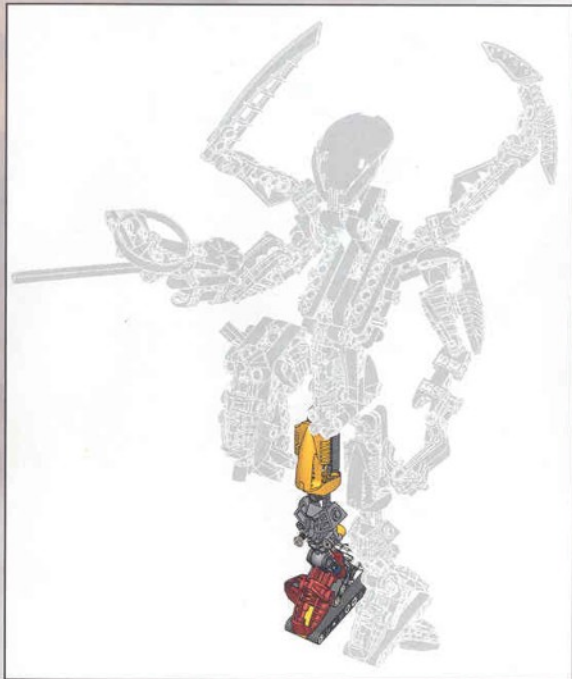

1

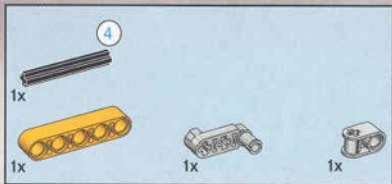

2

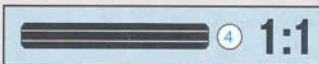
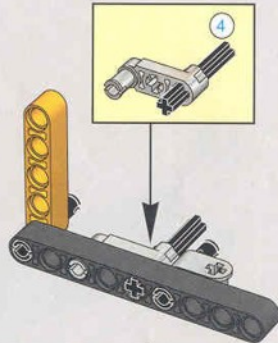



3

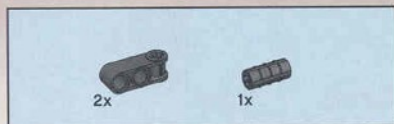
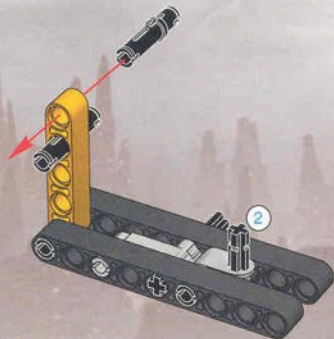

4

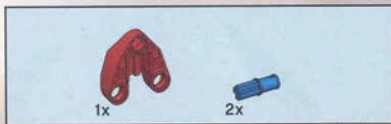
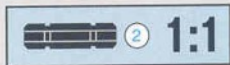
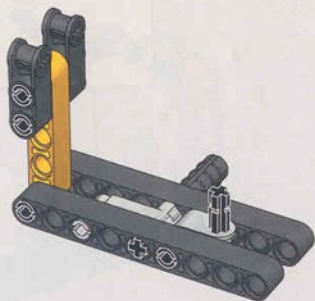

5

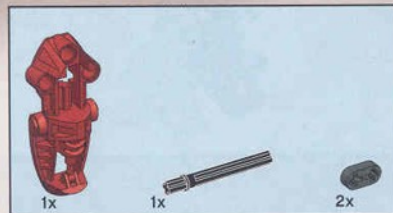
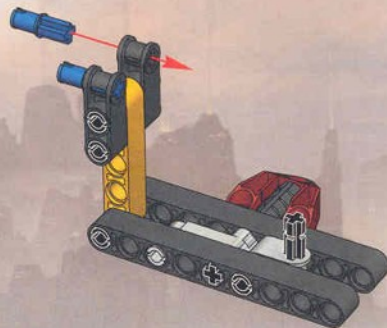

6

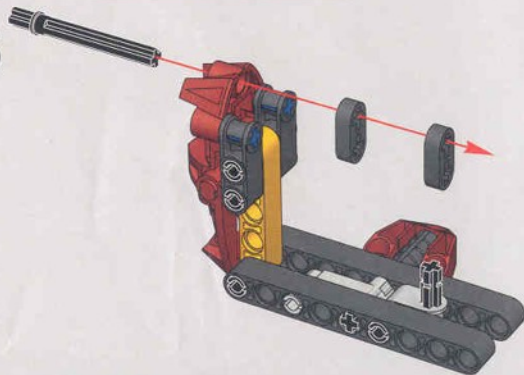

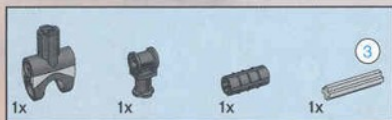

7

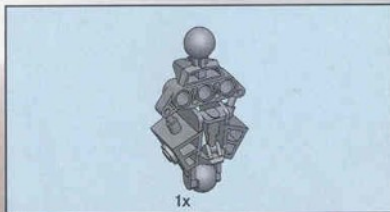
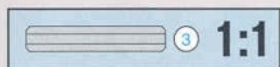
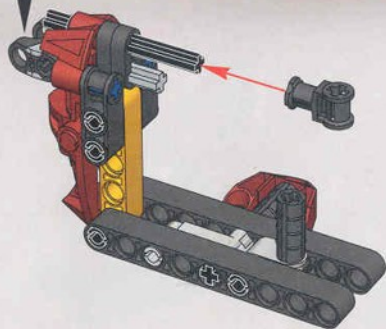

8

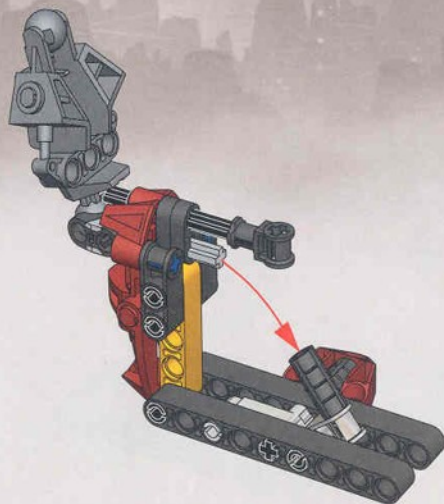



9

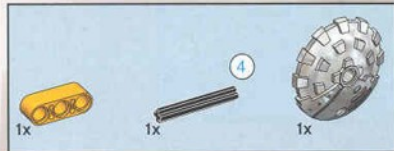
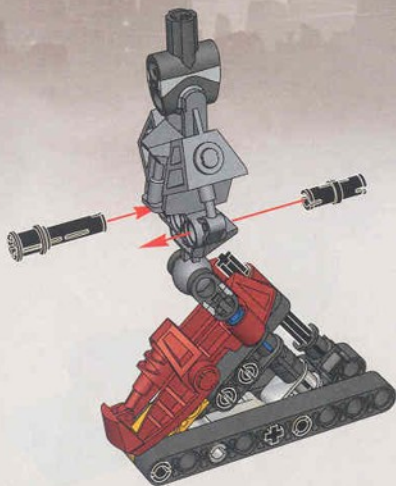

10

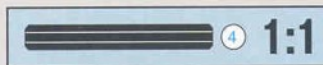
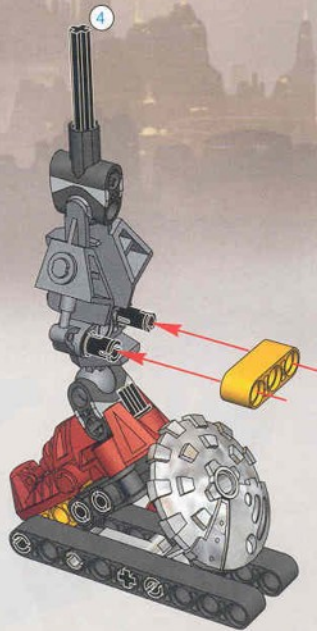

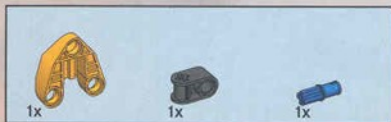

11

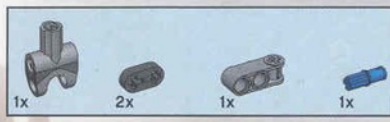
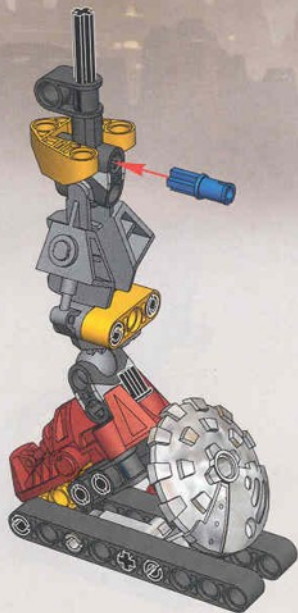

12

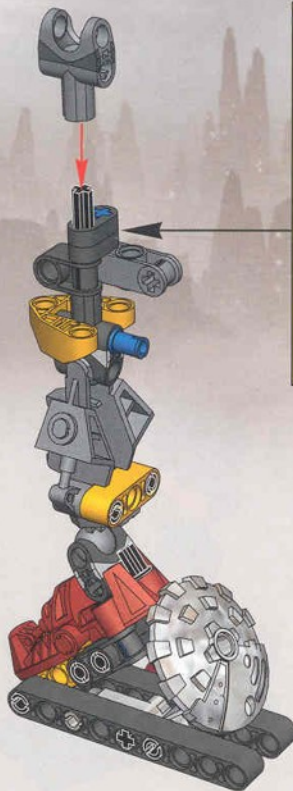

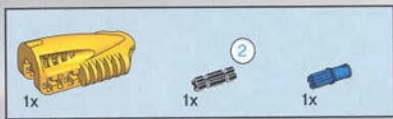

13

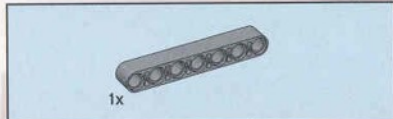
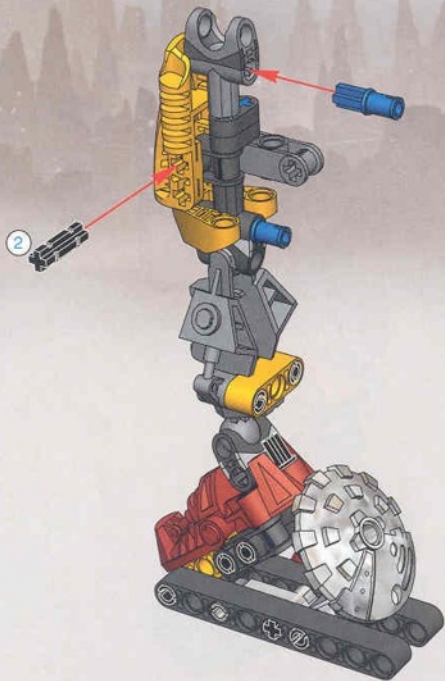

14

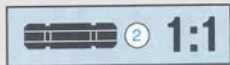
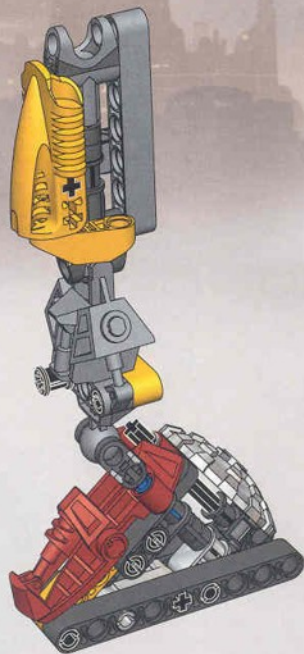

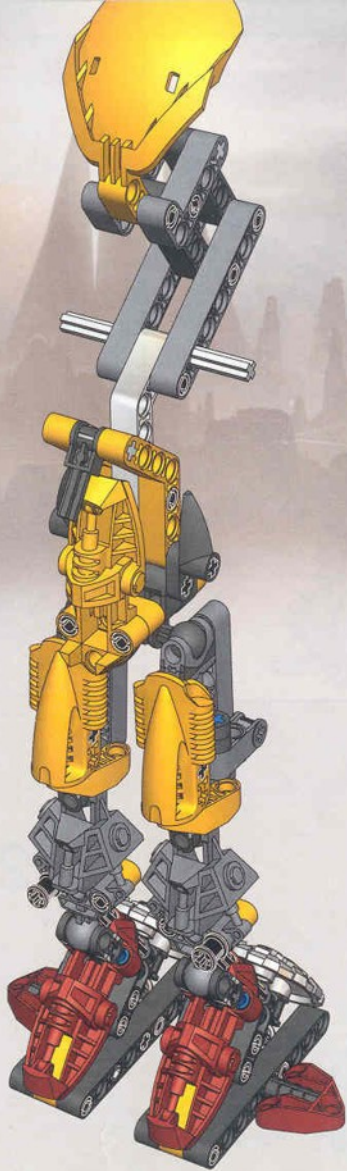

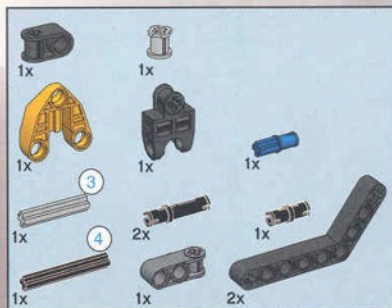
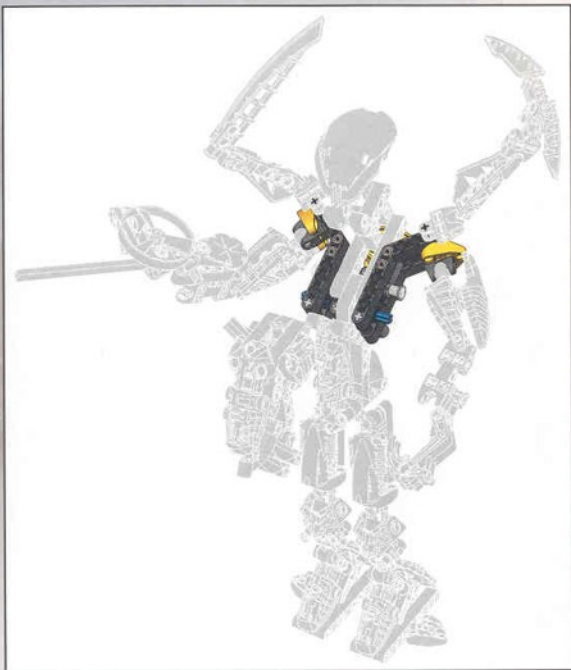

15

1

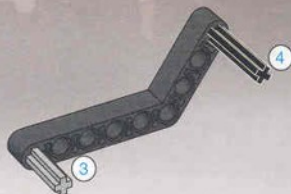

2

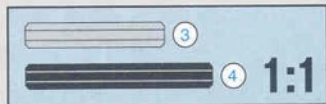
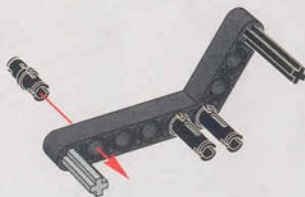

3

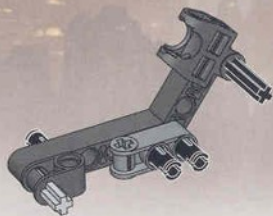

4

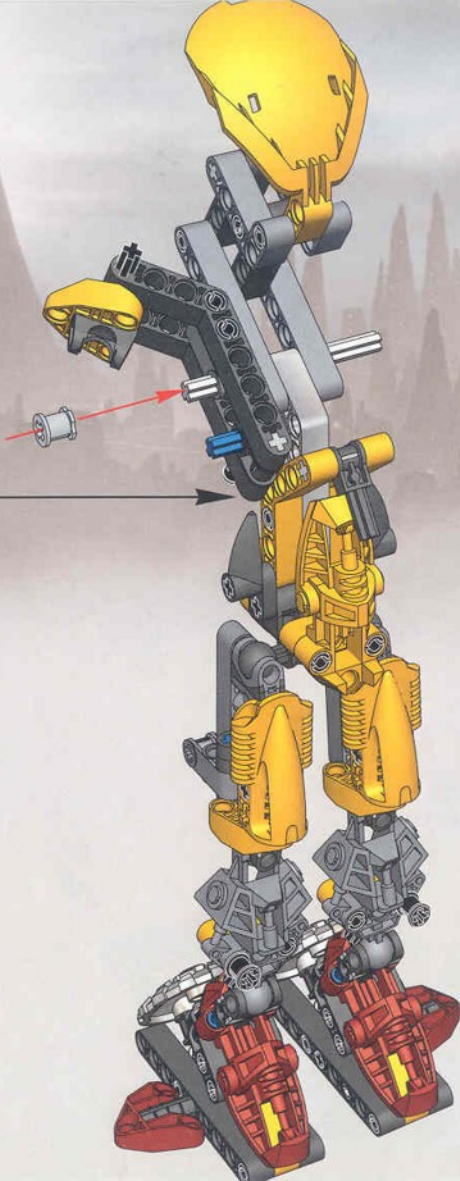
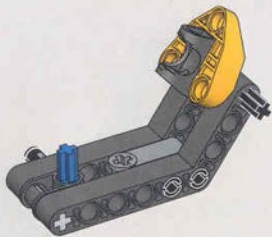

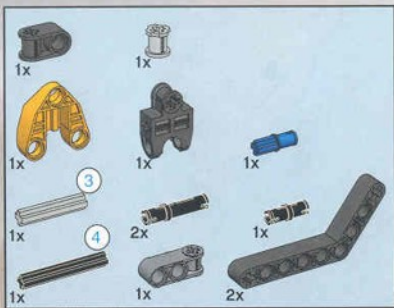

16

1



2

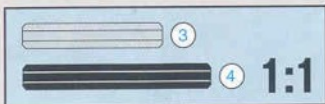
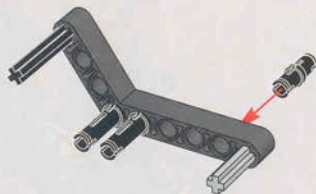

3

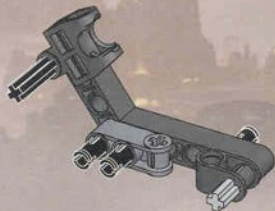

4

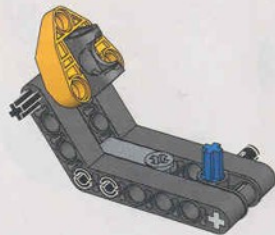

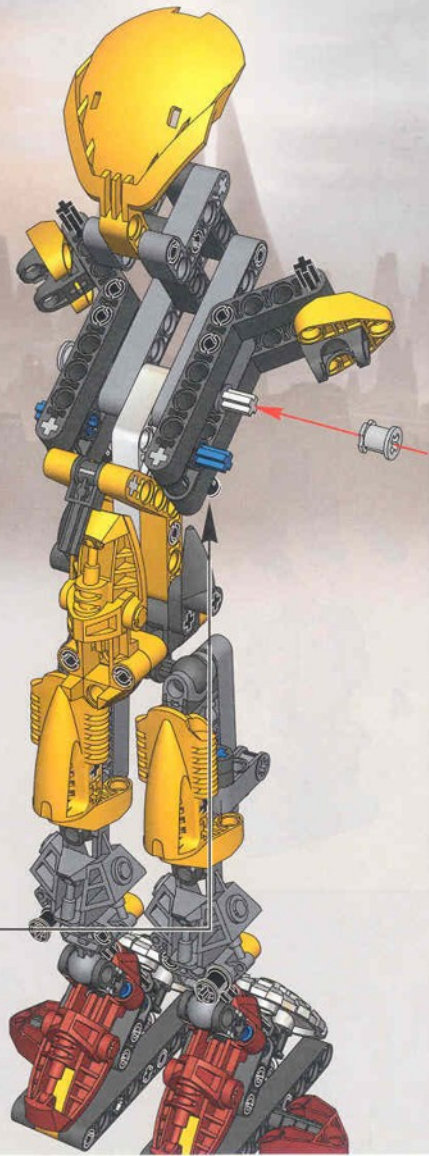

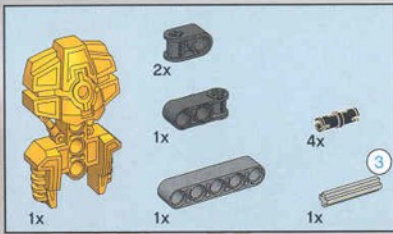

17

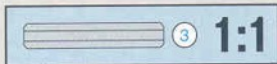
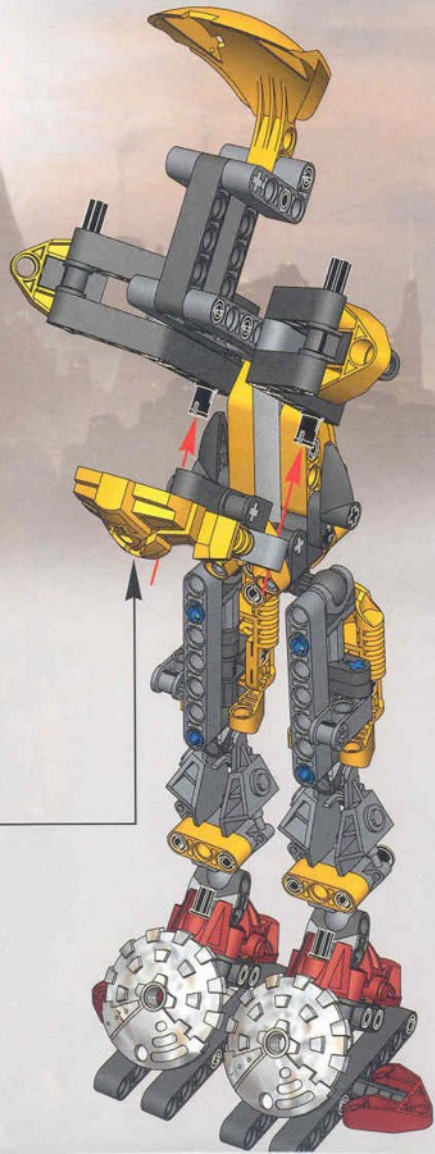
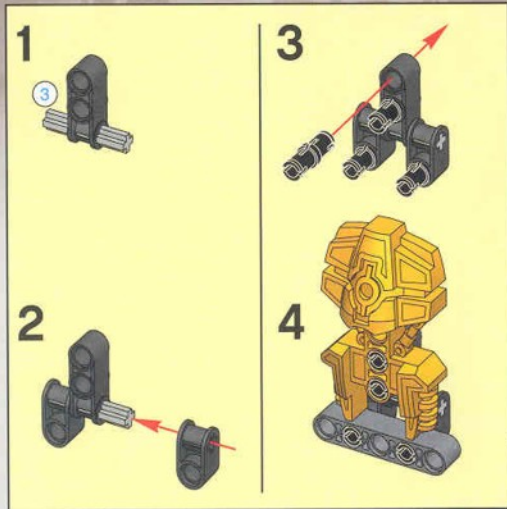

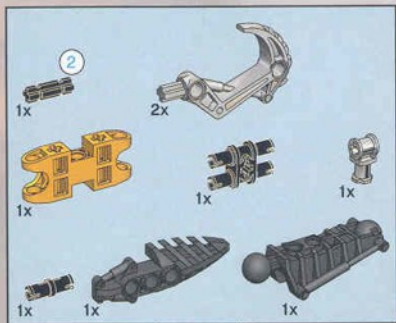

18

1

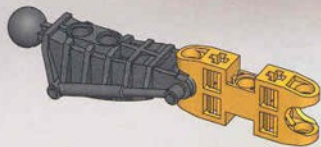

2



3

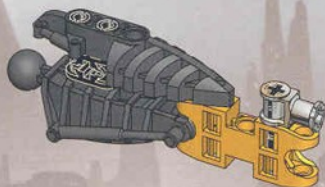

4

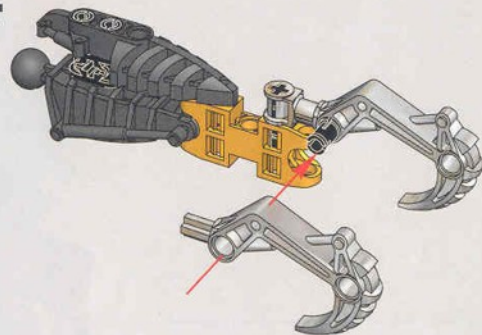

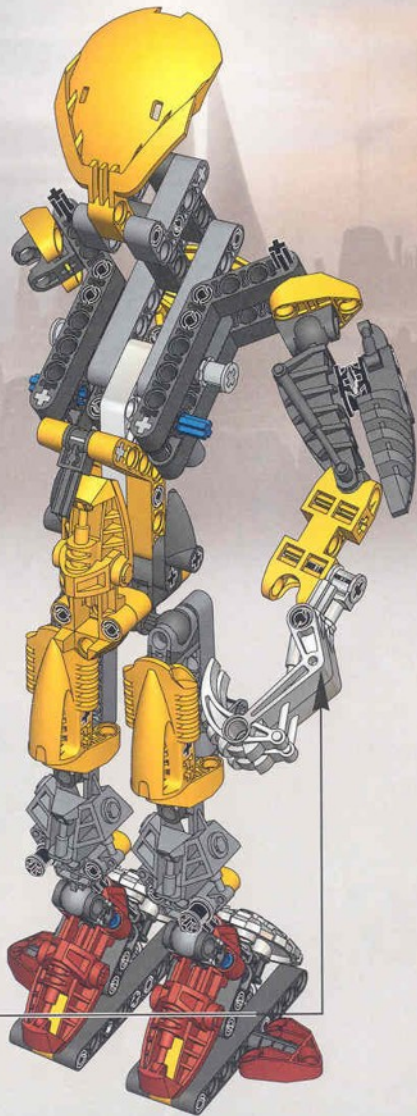

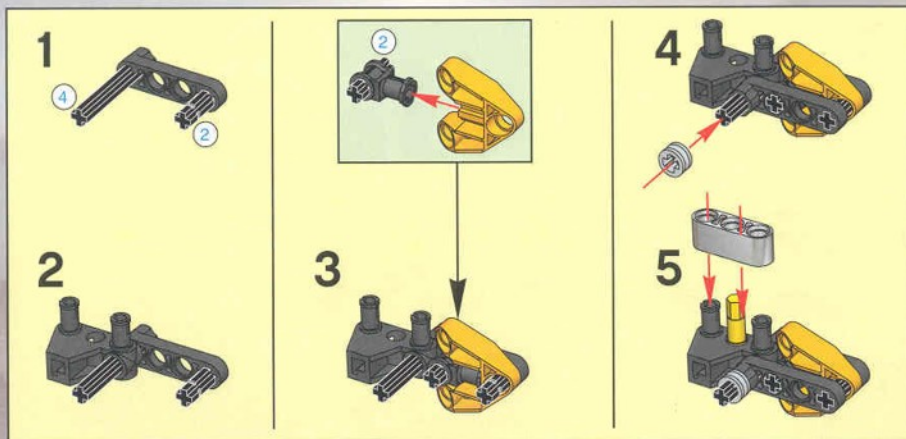

5

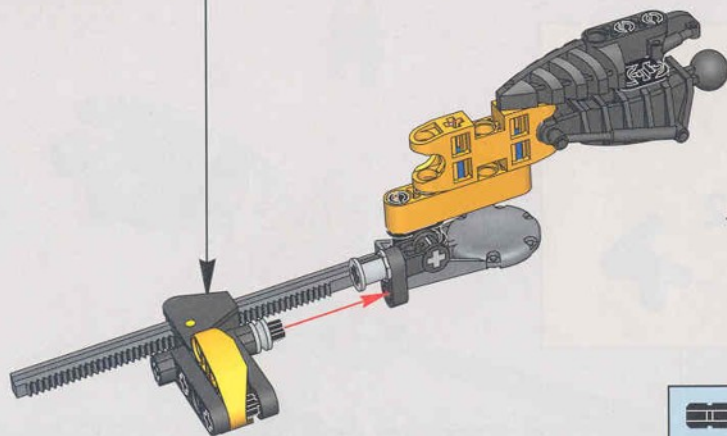



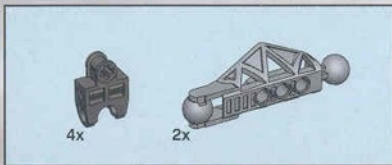

20

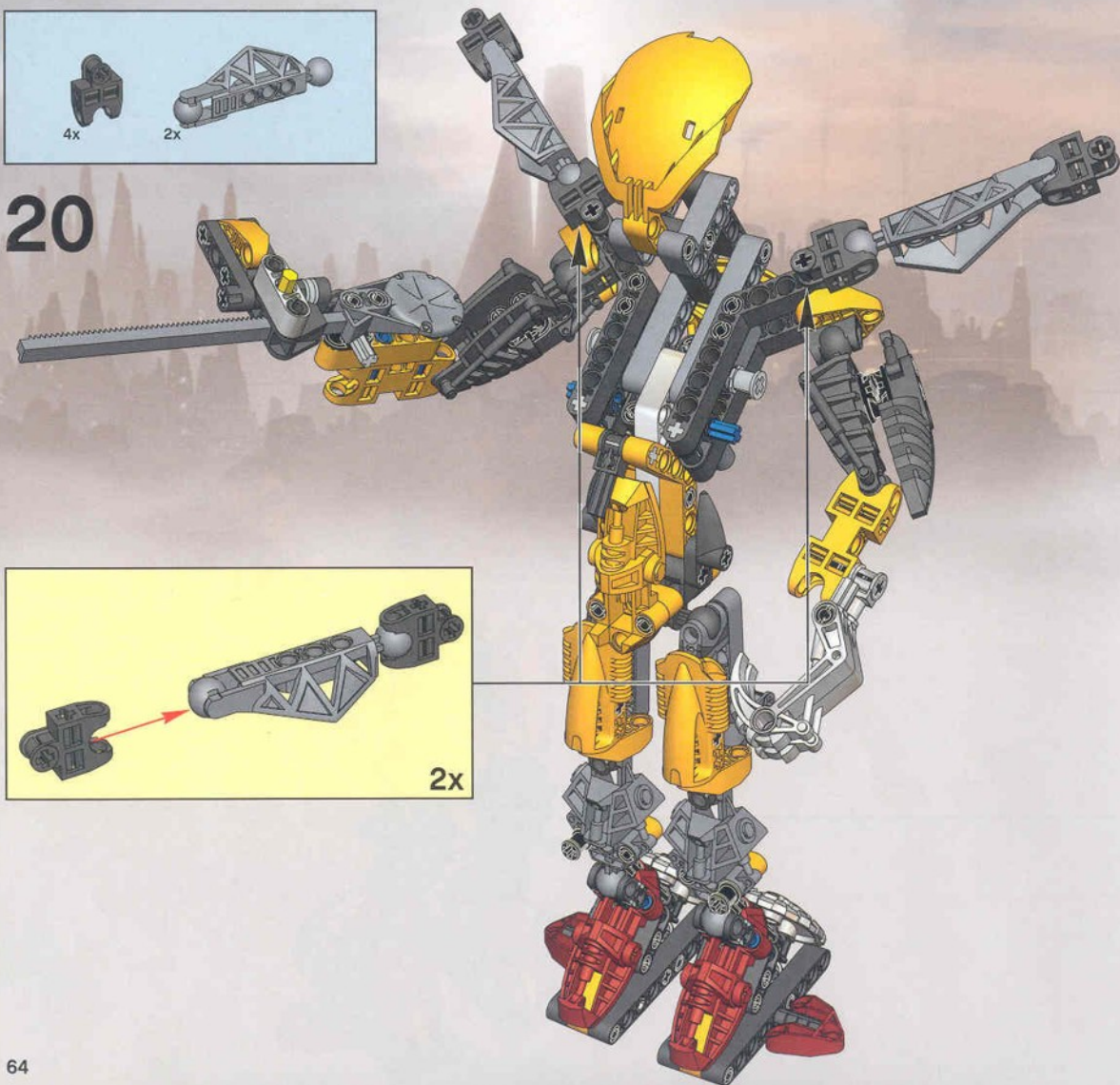
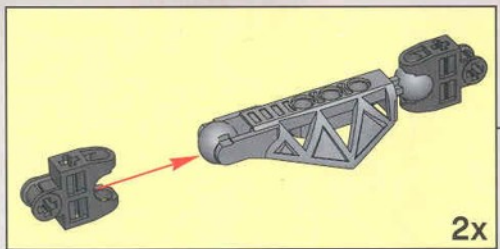

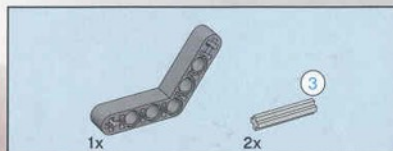
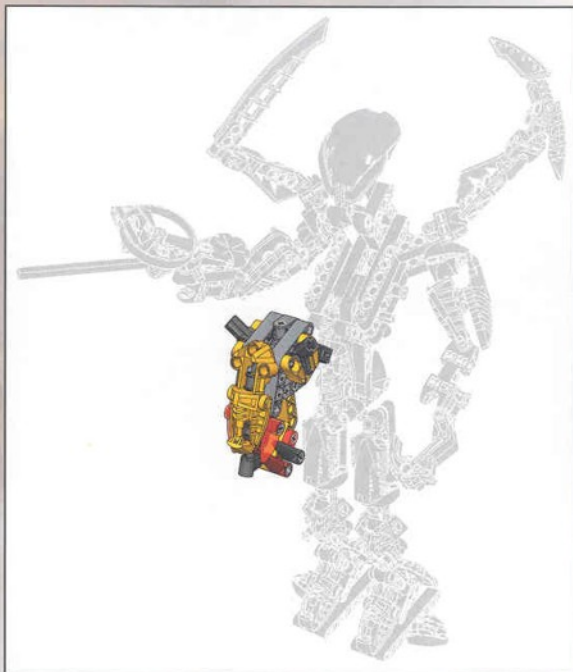

1

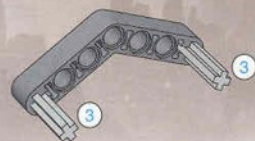

2

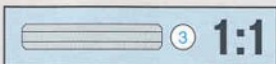
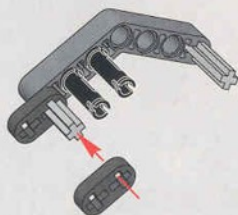

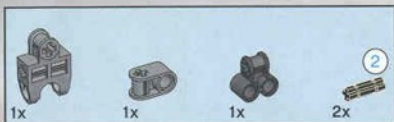

3

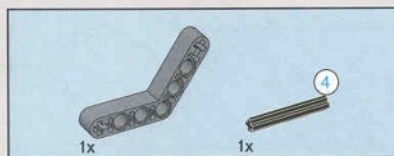
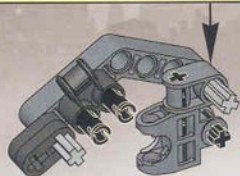
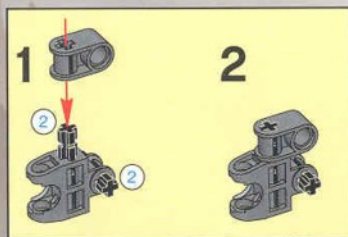

4

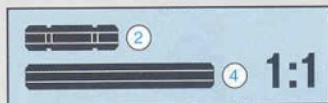
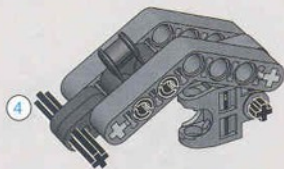

5

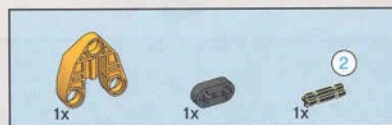
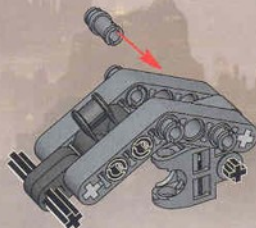

6

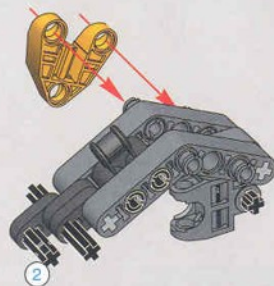

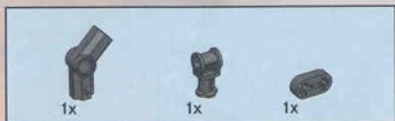

7

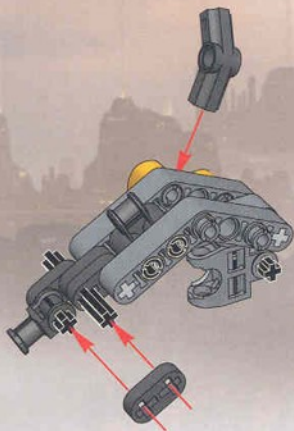

8

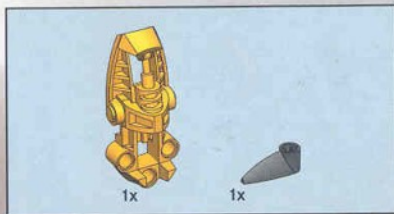
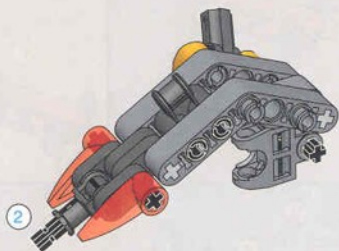

9

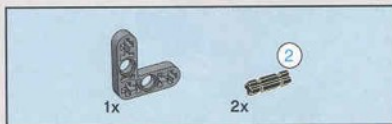

10

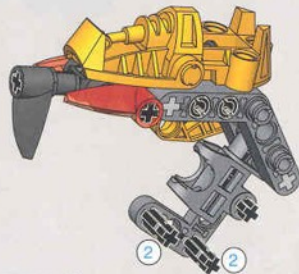



11

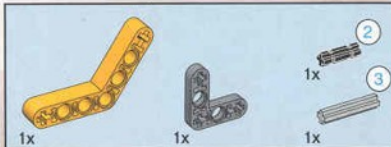
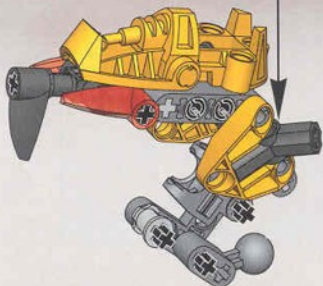
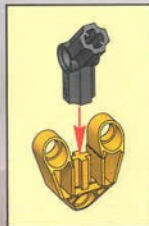

12

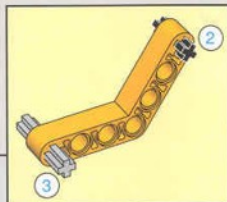
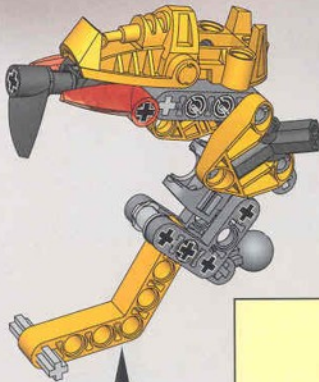



13

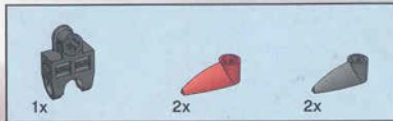
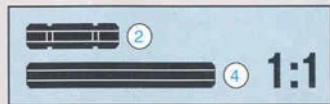
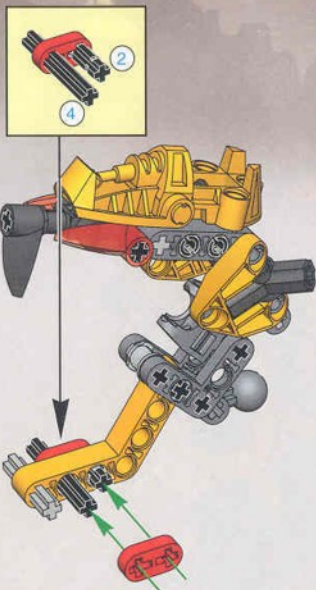

14

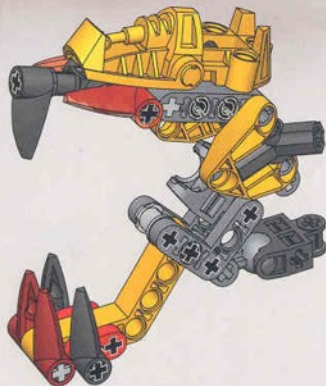

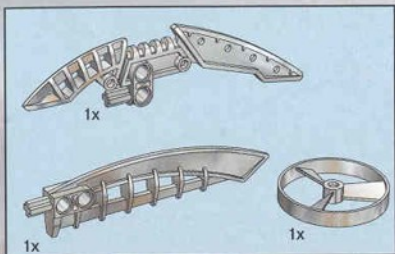

21

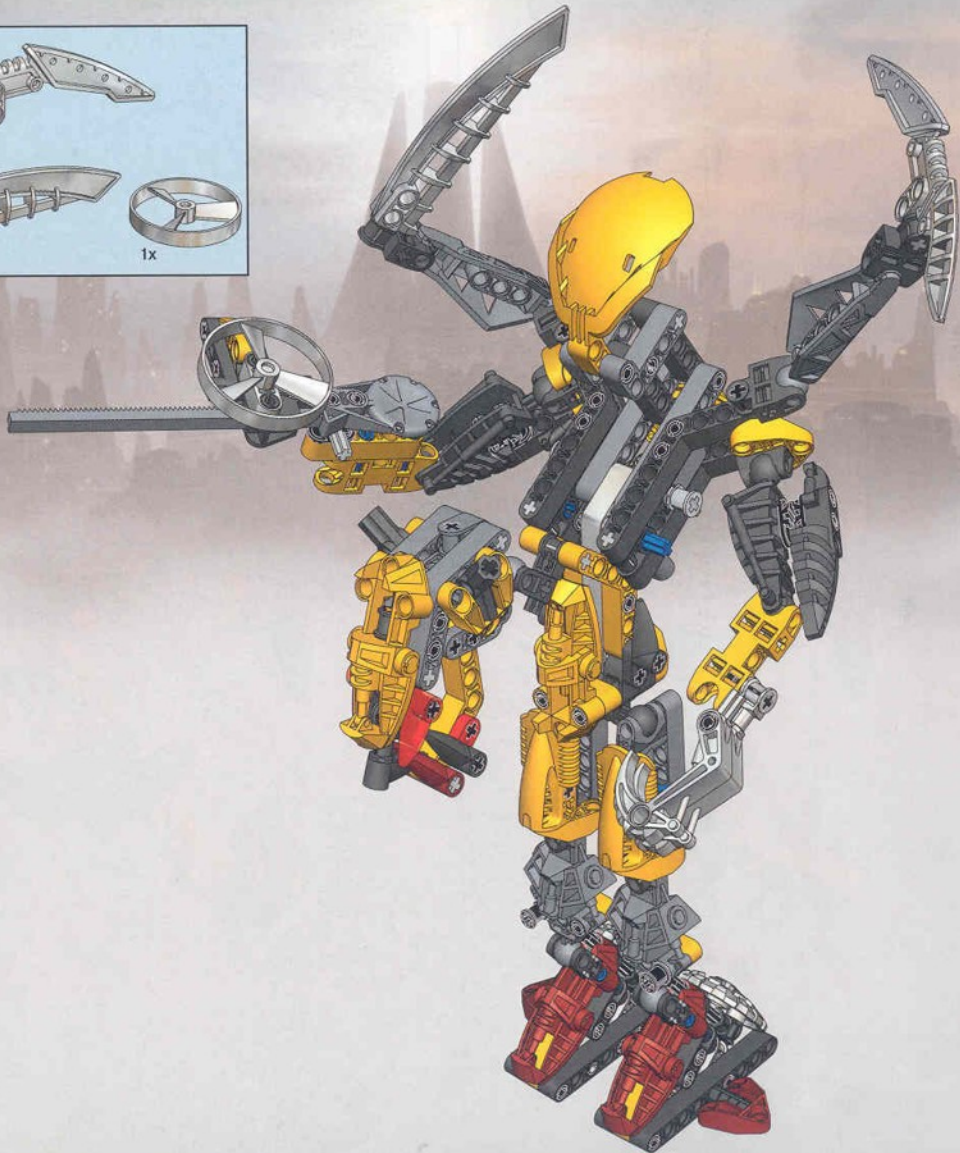

ROODAKA
8761



KEETONGU
8755

TOA HORDIKA
VAKAMA
8736



TOA HORDIKA
POKAMA
8737



TOA HORDIKA
WHENUA
8738



TOA HORDIKA
ONEWA
8739



TOA HORDIKA
MATAU
8740



TOA HORDIKA
NUJU
8741





VISORAK
VOHTARAK
8742



VISORAK
ROPORAK
8745



VISORAK
BOGGARAK
8743



VISORAK
SUUKORAK
8747



VISORAK
KEELERAK
8746



VISORAK
OOHNORAK
8744

LEGO

LEGOLAND



WWW.LEGOLAND.COM

LEGO, the LEGO logo, the Brick- and Knob configuration and LEGOLAND are trademarks of the LEGO Group. ©2004 The LEGO Group.

Win! Gagne! Gewinne! 当たります



WIN LEGO® PRODUCTS

We would like to know what you think about our new LEGO® product. If you could help us by answering a few questions you are in with a chance of winning an exciting LEGO prize. It will only take you about 3 minutes! Log on to the web address below for further instructions.

We would really like to hear what you think about your new LEGO product. If you'd like to help us, go to the web address below for further instructions.



Estimado usuario LEGO®

Al contestar algunas preguntas en inglés, francés, alemán o japonés, en el sitio www.acnielsen.aim.dk/lego, podrás participar en el sorteo de algunos valiosos premios LEGO®.



抽選でレゴ®製品が当たります

私たちは、皆さんが好きなレゴ®の製品についてどんな感想をお持ちか、知りたいと思っています。質問に答えて、楽しいレゴ®製品の抽選に参加しましょう。アンケートの回答には、ほんの少しの時間としかかかりません！詳しくは、以下のウェブアドレスまでアクセスしてください。



GAGNE DES PRODUITS LEGO®

Nous aimerions savoir ce que tu penses de ton nouveau produit LEGO®. Si tu veux bien nous aider en répondant à quelques questions, tu recevras peut-être bientôt un fantastique prix LEGO. Et cela ne te prendra que 3 minutes environ ! Tu obtiendras davantage d'informations en visitant le site Internet indiqué ci-dessous.

Nous aimerions savoir ce que tu penses de ton nouveau produit LEGO. Si tu souhaites nous aider, rends-toi à l'adresse Internet ci-dessous où tu trouveras des instructions supplémentaires.



Caro Consumidor da LEGO®

Ao responder a algumas perguntas em Inglês, Francês, Alemão ou Japonês no endereço www.acnielsen.aim.dk/lego irá participar num concurso para ganhar valiosos prémios da LEGO®.



GEWINNE LEGO® PRODUKTE

Wir sind sehr an deiner Meinung über dein neues LEGO® Produkt interessiert. Wenn du uns den Gefallen tust und ein paar Fragen beantwortest, kannst du einen tollen LEGO Preis gewinnen. Das Ganze dauert nur etwa 3 Minuten! Gehe einfach zu der unten angegebenen Webadresse - dort findest du weitere Informationen.

Wir möchten gerne wissen, was Sie von Ihrem neuen LEGO Produkt halten. Wenn Sie uns helfen möchten, besuchen Sie bitte die u.a. Website, auf der Sie alles Weitere erfahren.



Kedves Ifjú LEGO® Vásárló

Ha ellátogatasz a www.acnielsen.aim.dk/lego honlapra és ott angol, francia, német vagy japán nyelven megválaszolsz néhány kérdést, akkor részt veszel egy versenyben, amelyben értékes LEGO® díjakat nyerhetsz.

LEGO, the LEGO logo, the CURTAINS logo and BRICKNICLE are trademarks of the LEGO Group. ©2005 The LEGO Group. Ferrari, all associated logos and the distinctive designs are trademarks of Ferrari S.p.A. The body of the Ferrari car is protected as Ferrari property under trade dress and/or design regulations.

www.acnielsen.aim.dk/LEGO



2005

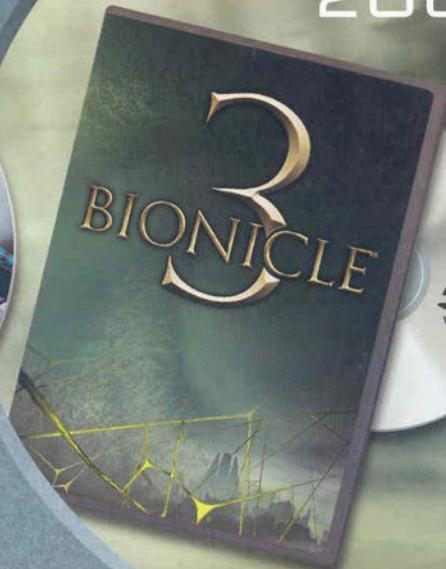

4271685

©2005 The LEGO Group.



www.bionicle.com

