



BIONICLE

LAVA CHAMBER GATE

www.bionicle.com



8894



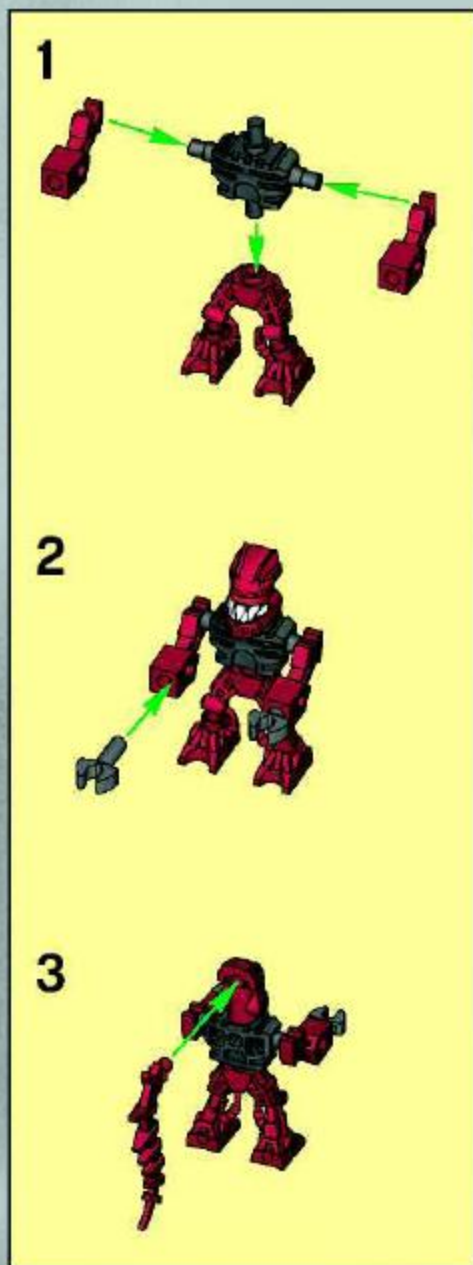
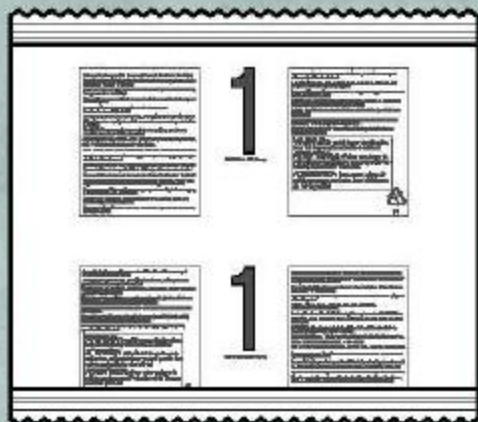

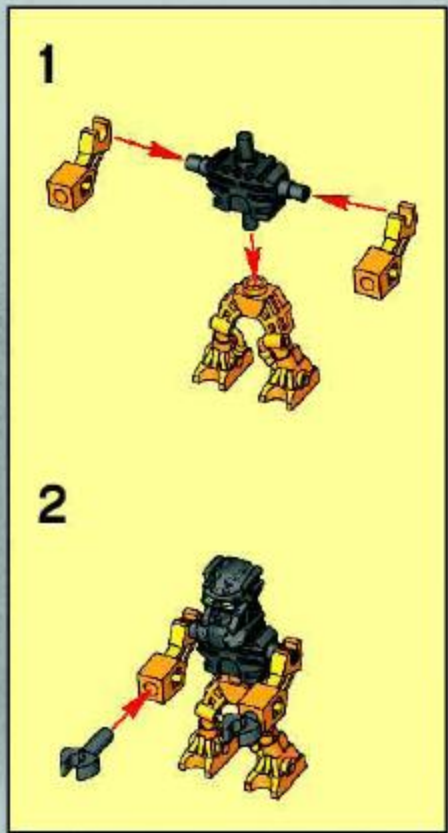

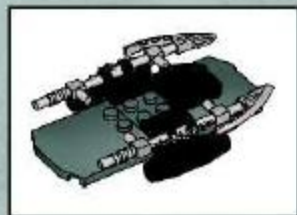

1



2

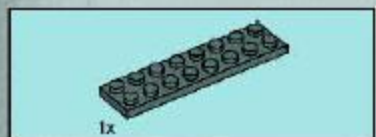

3

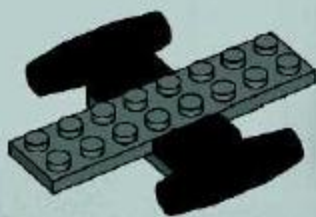



4

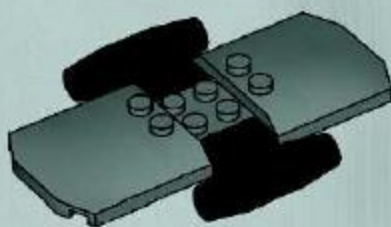

5

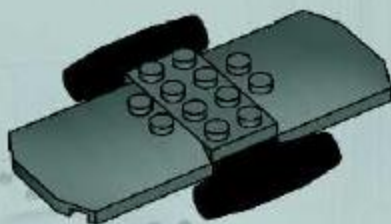

6



7

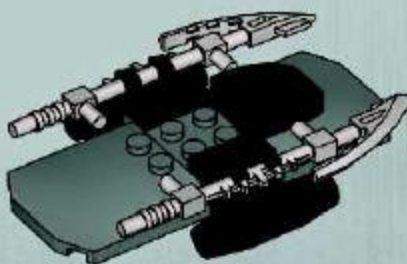



1:1



1



2



3

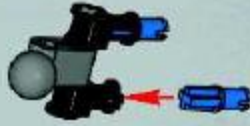



4

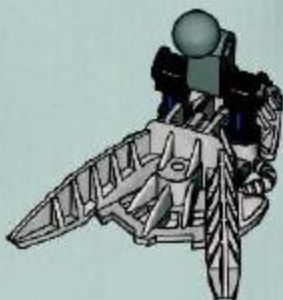

5



6



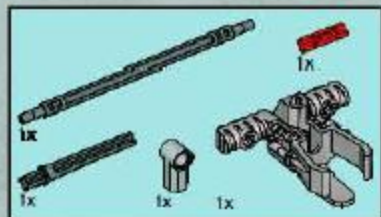

7

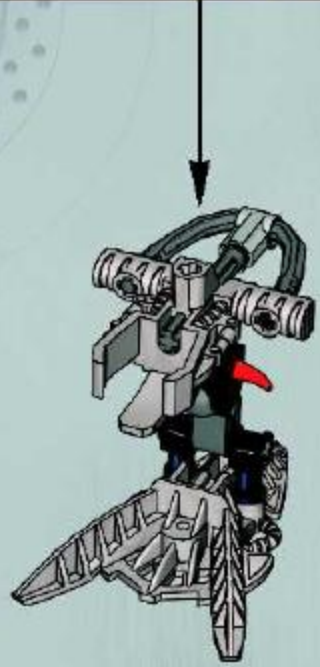
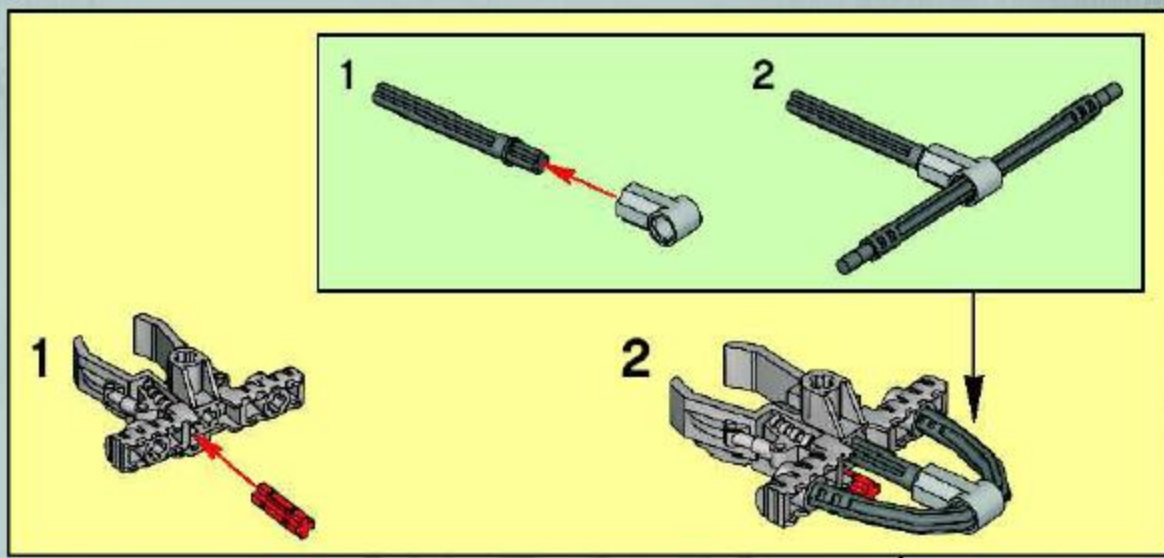

CAUTION: Do not aim at eyes or face.
ATTENTION: Ne pas viser les yeux ni le visage.
PRECAUCIONE: No lo dirija a los ojos ni cara.

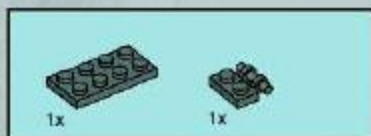

1



2



3





4



5

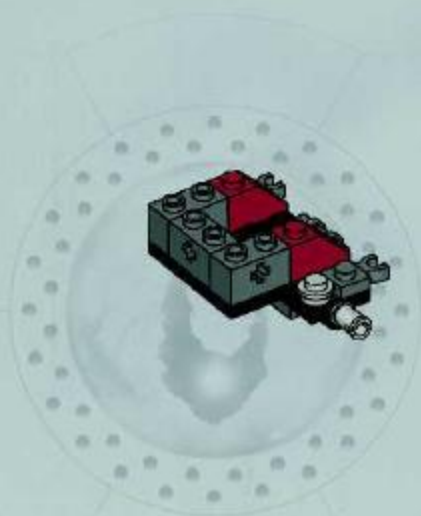

6

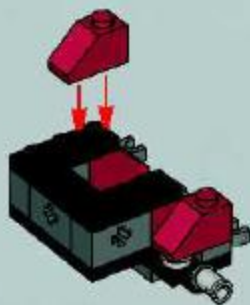



7

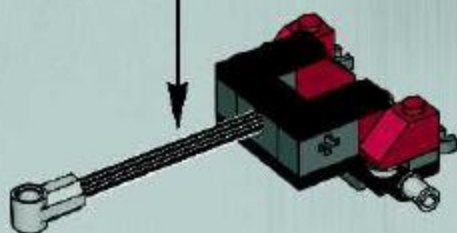
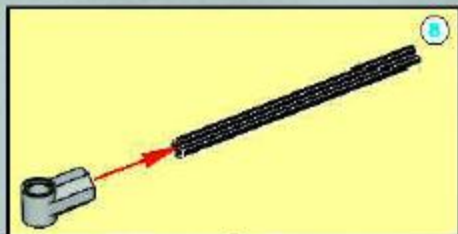

8

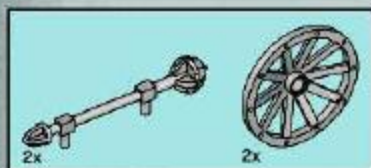

9

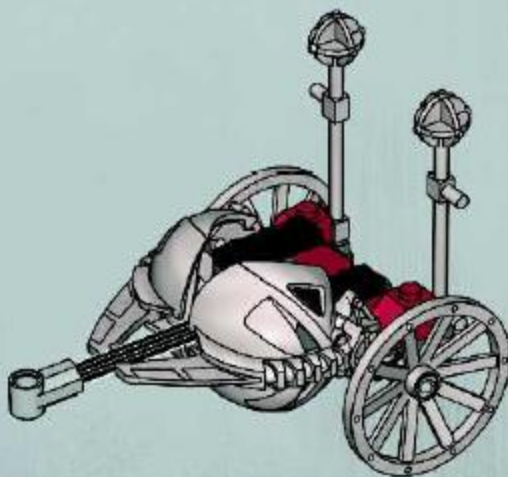

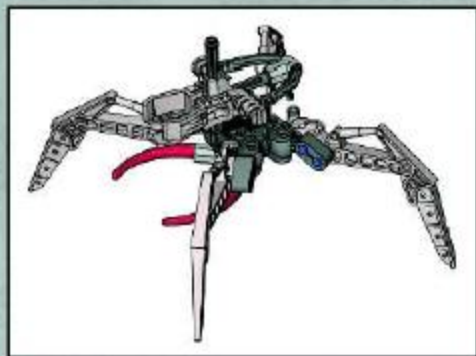

1



2



3





4

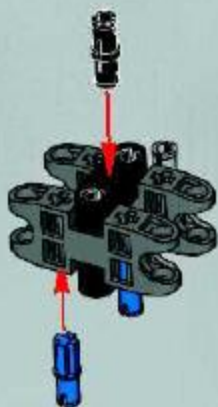

5

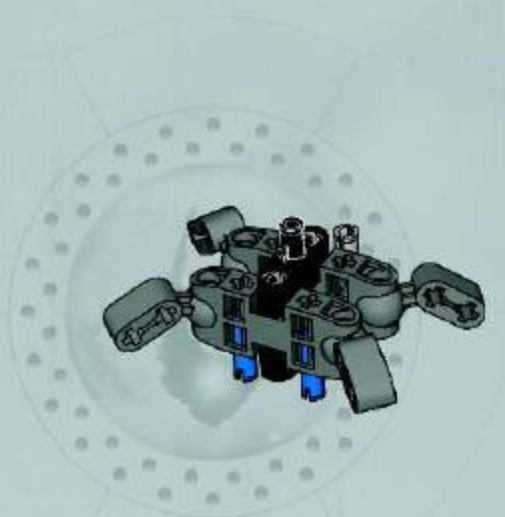

6

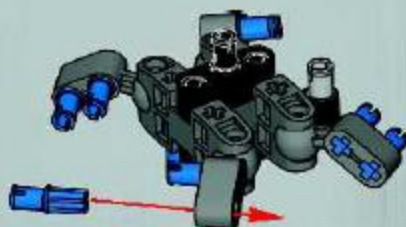



7

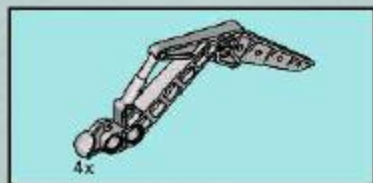
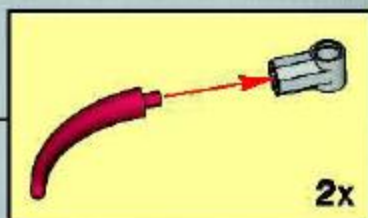
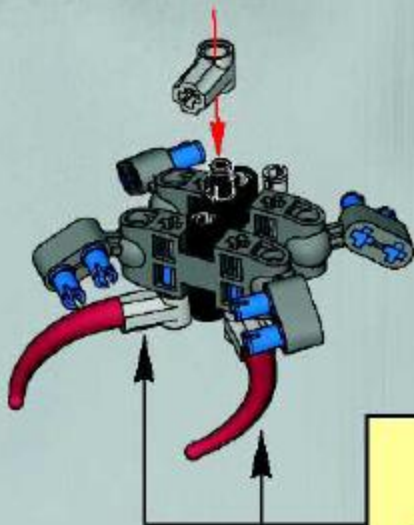

8

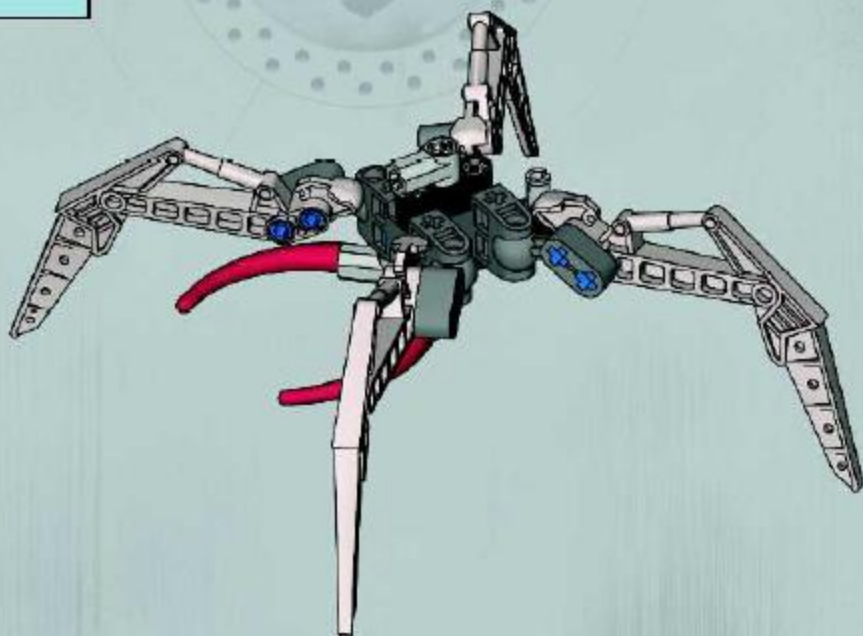

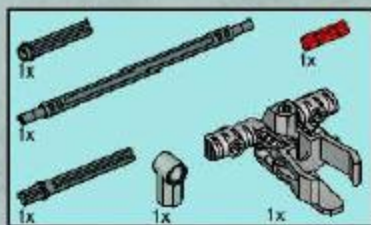

9

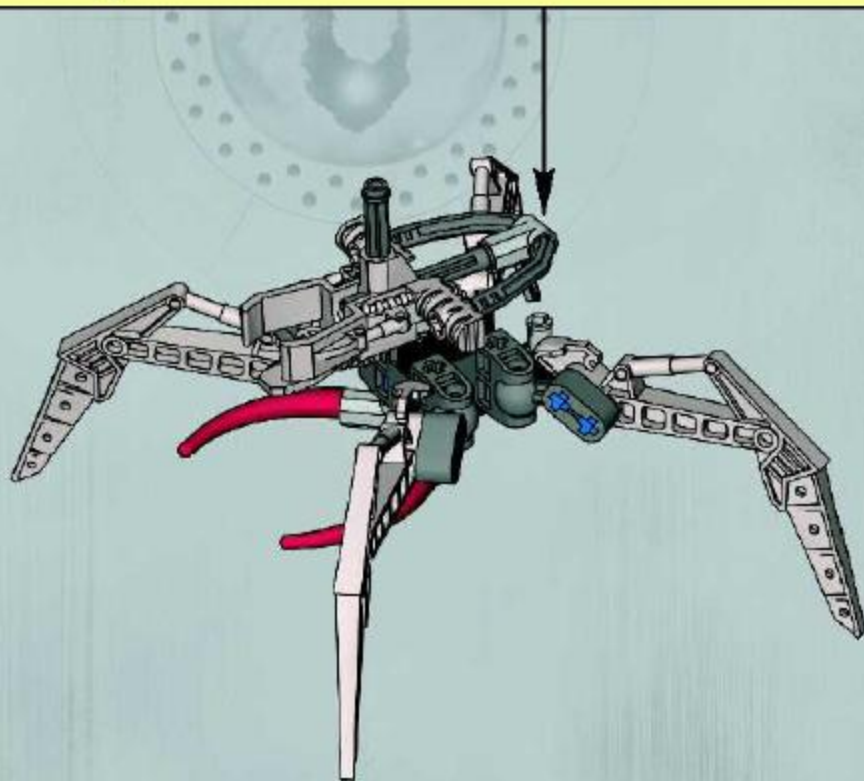
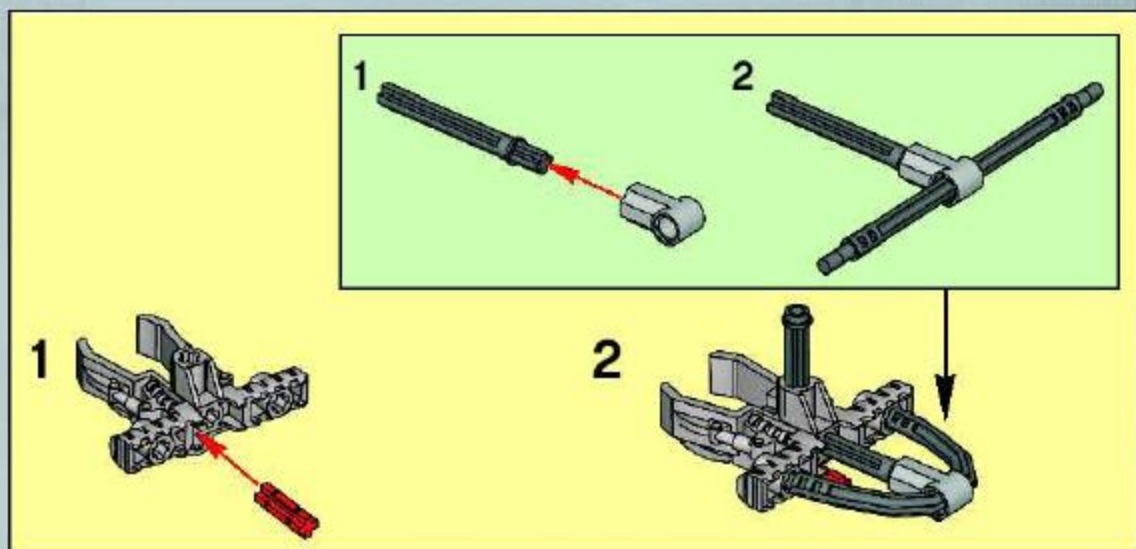

10

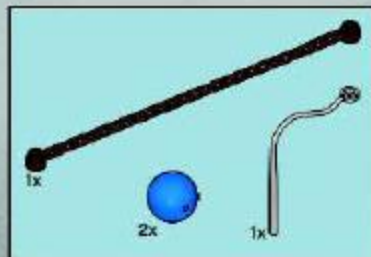
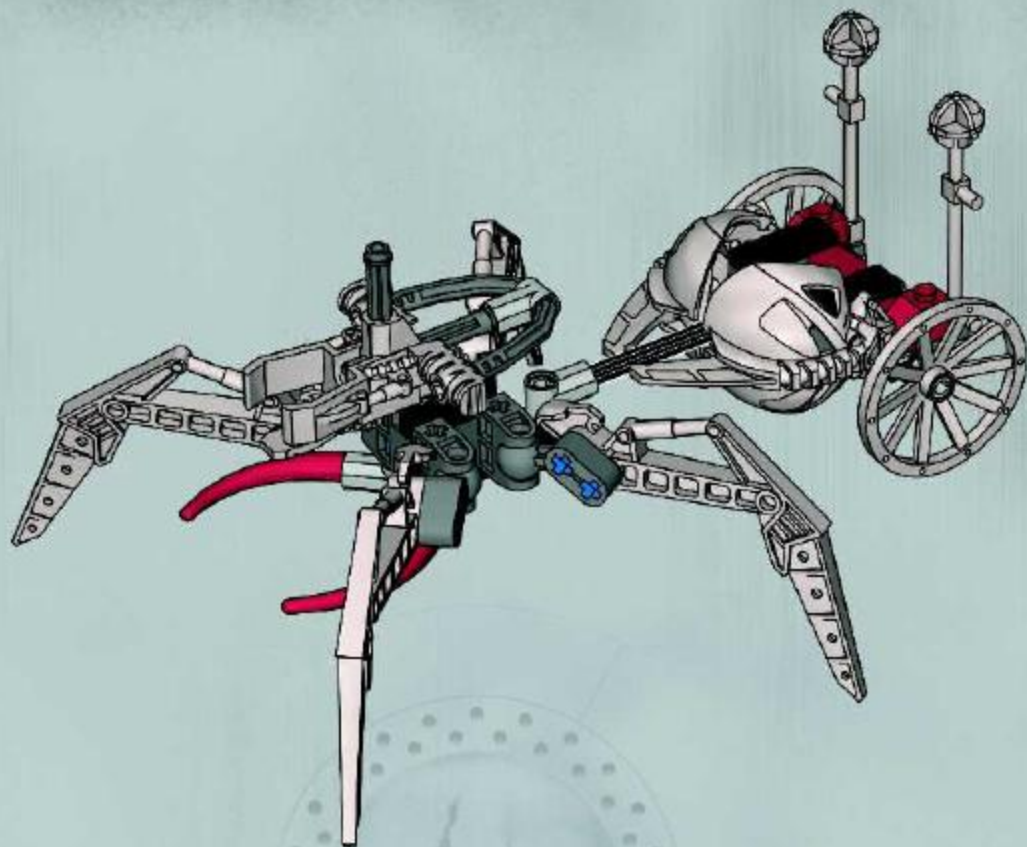

11

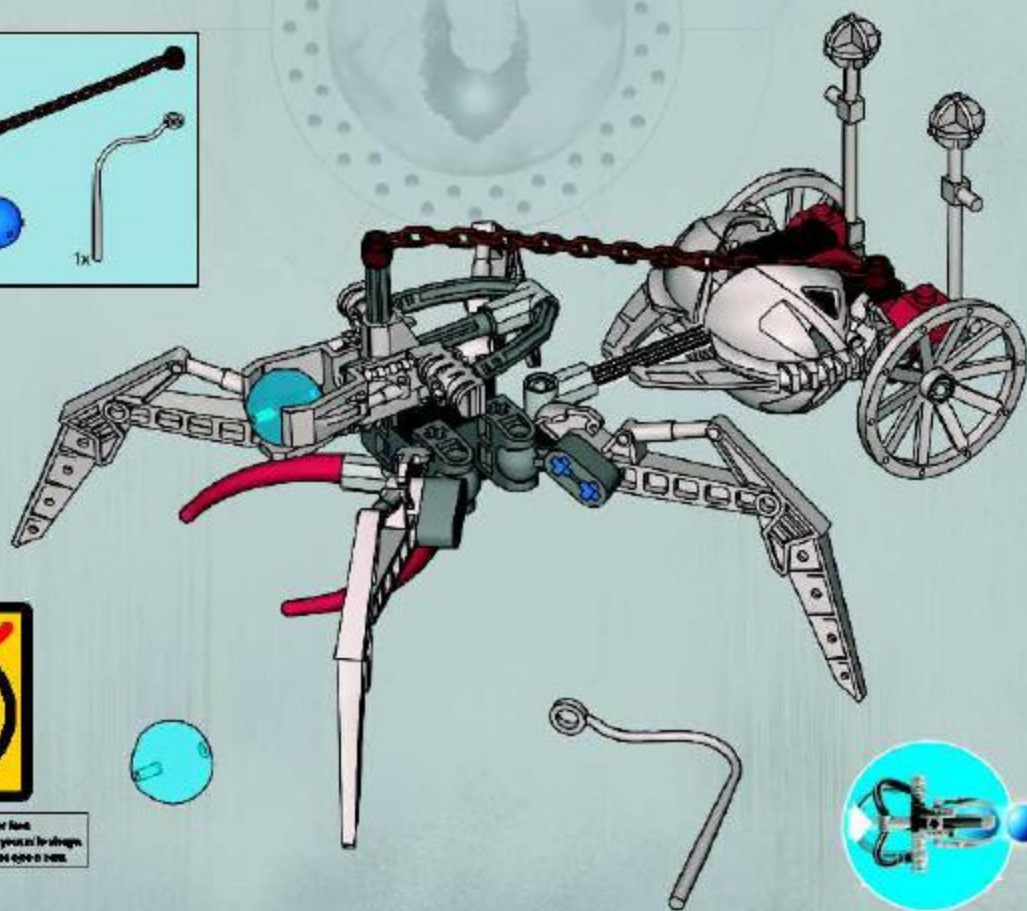

CAUTION: Do not aim at eyes or face.
ATTENTION: Ne pas viser les yeux ni le visage.
PRECAUCIÓN: No le dirija a los ojos o a la cara.

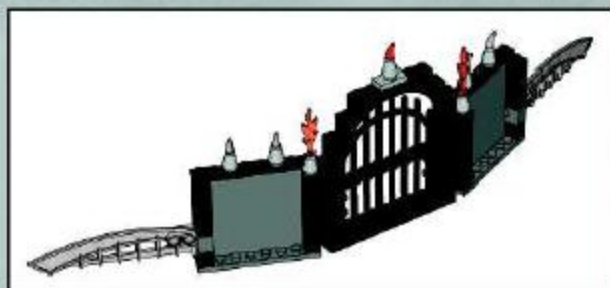

1

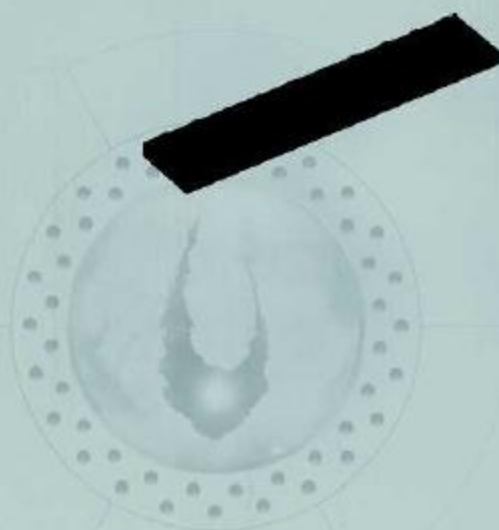

2

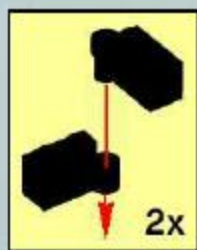

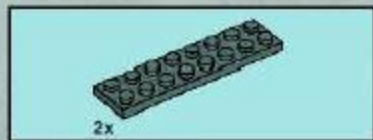

3

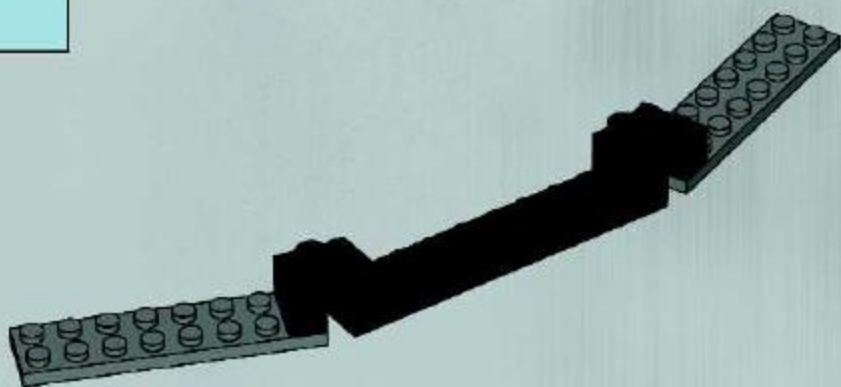

4

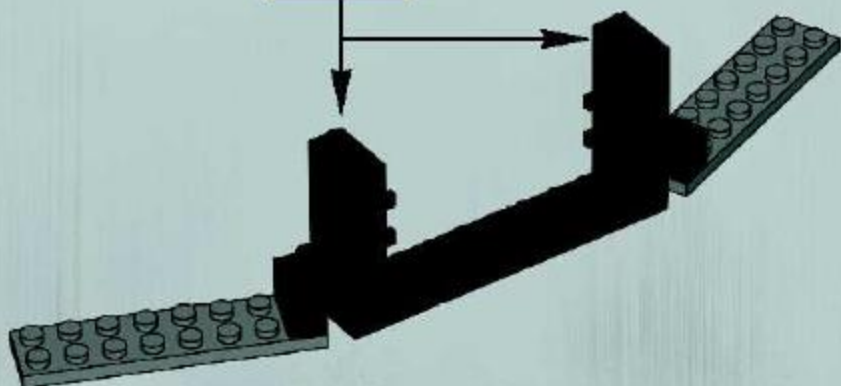
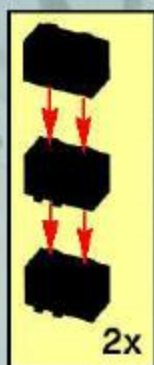



5

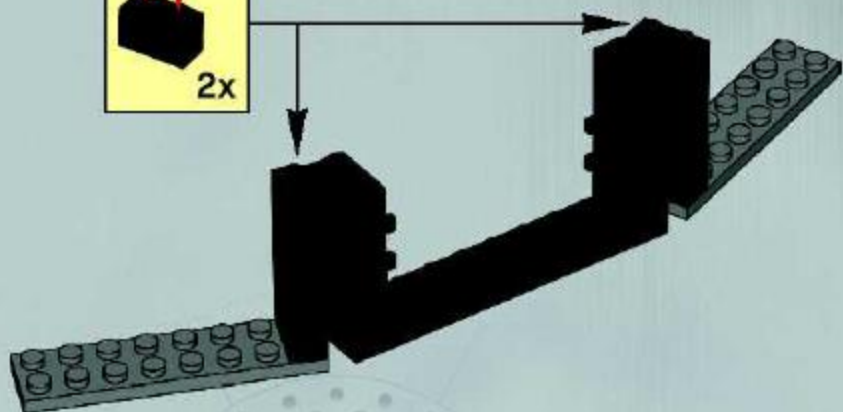
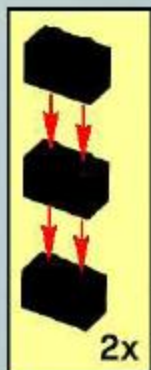

6

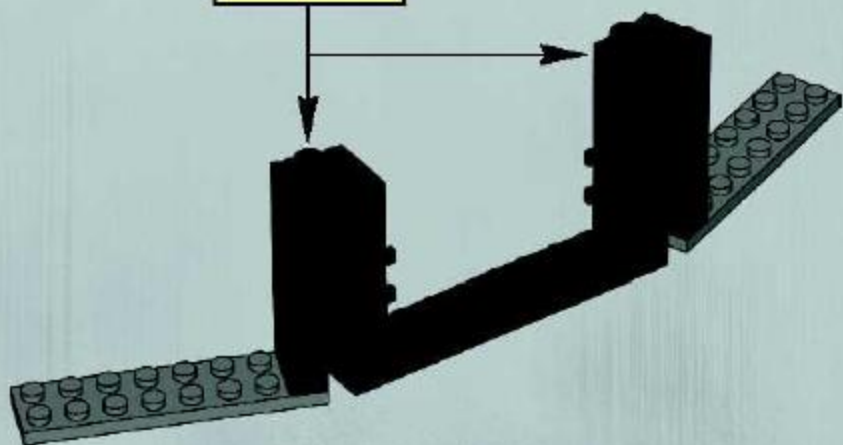
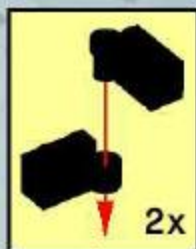

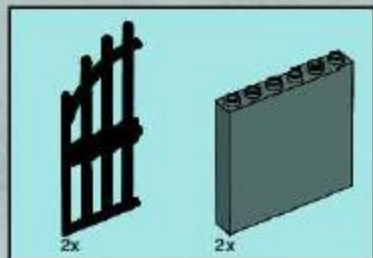

7

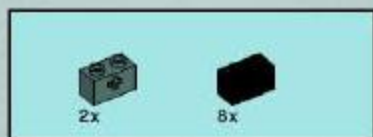
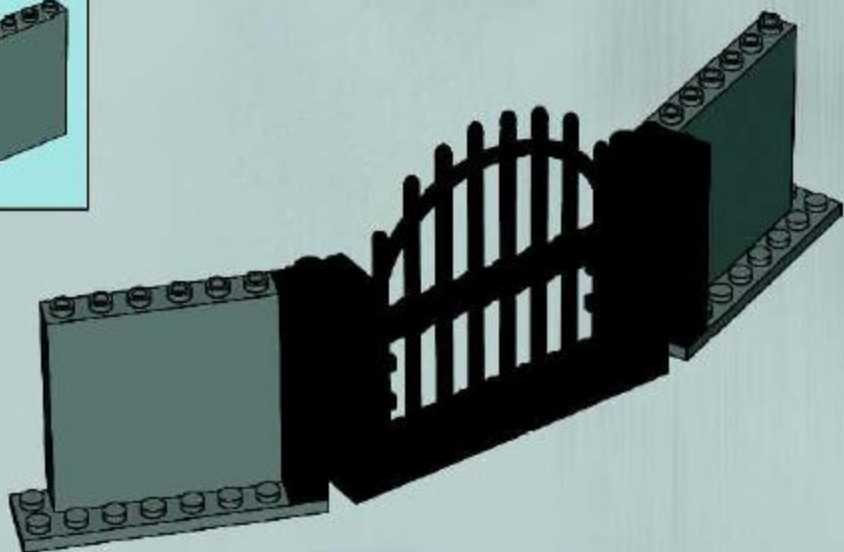

8

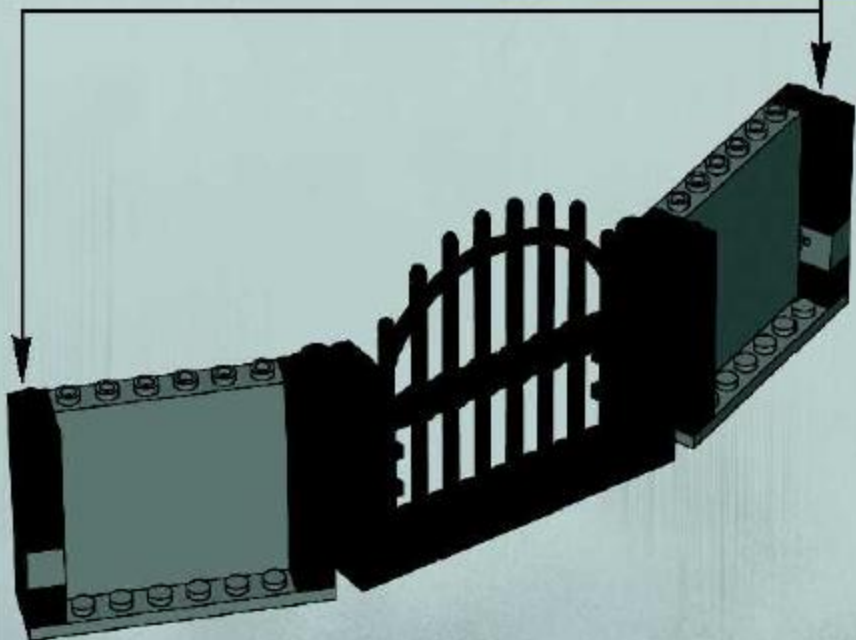
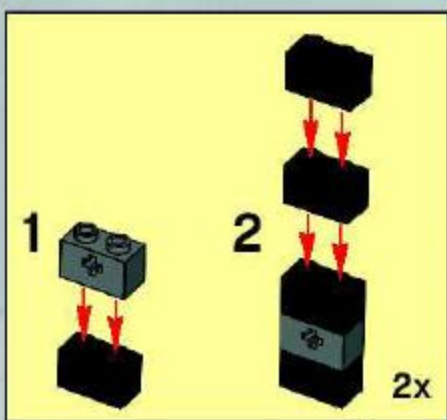



9

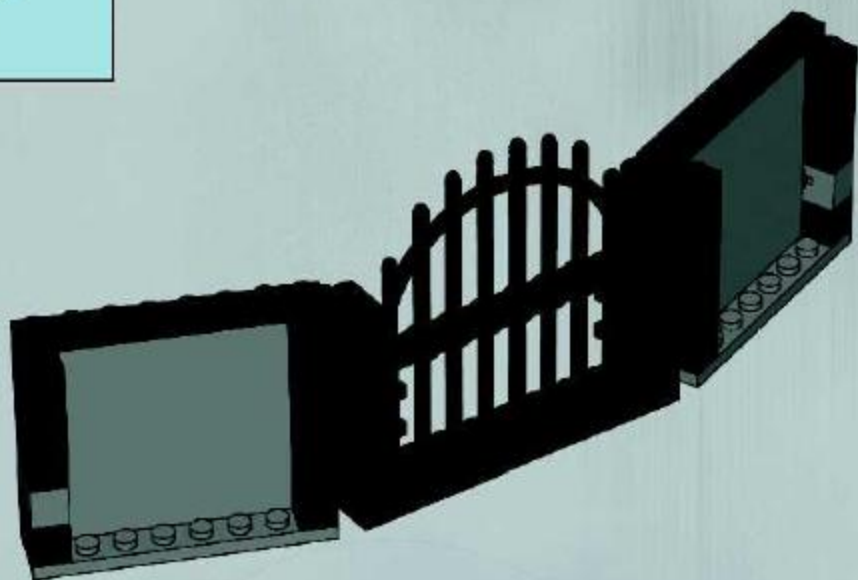

10

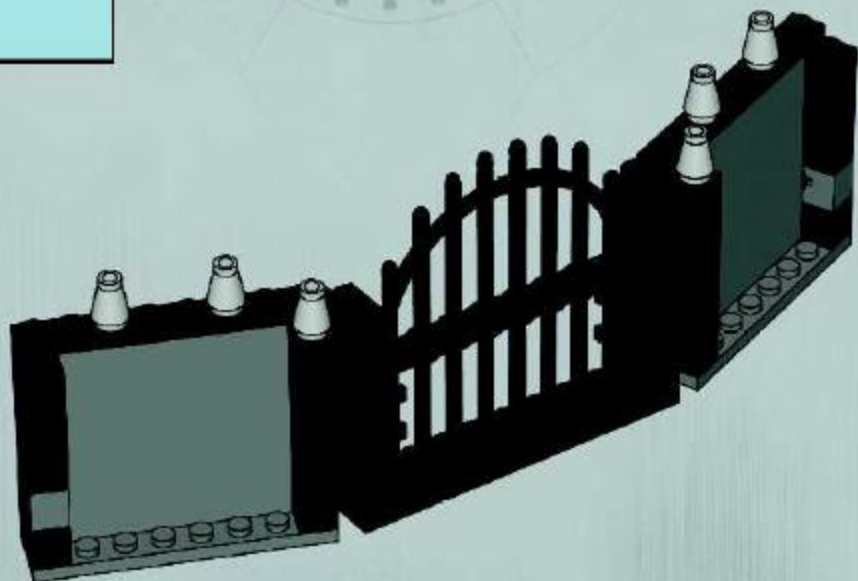

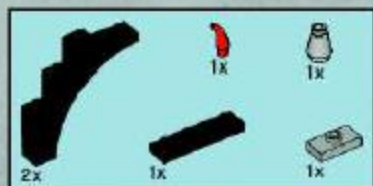

11

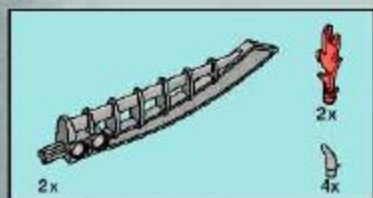
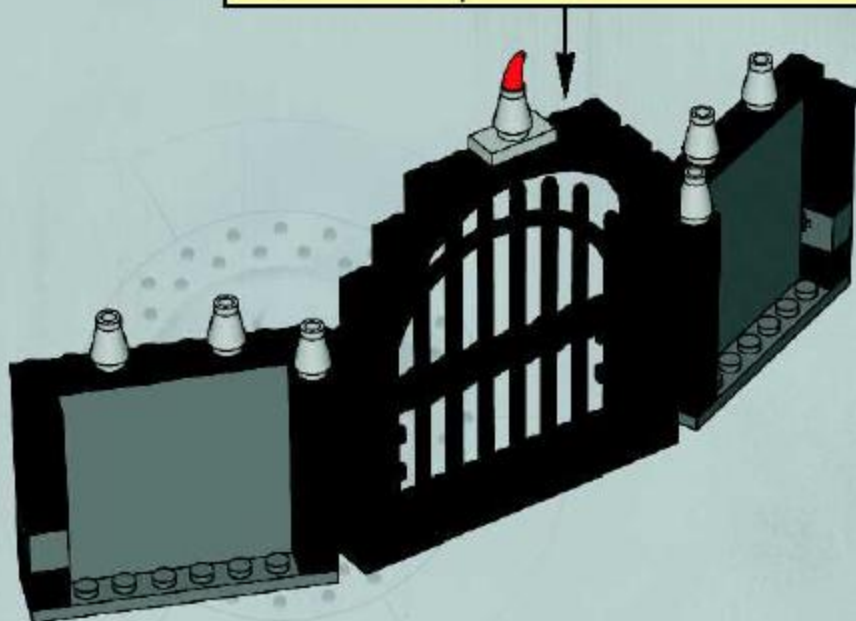
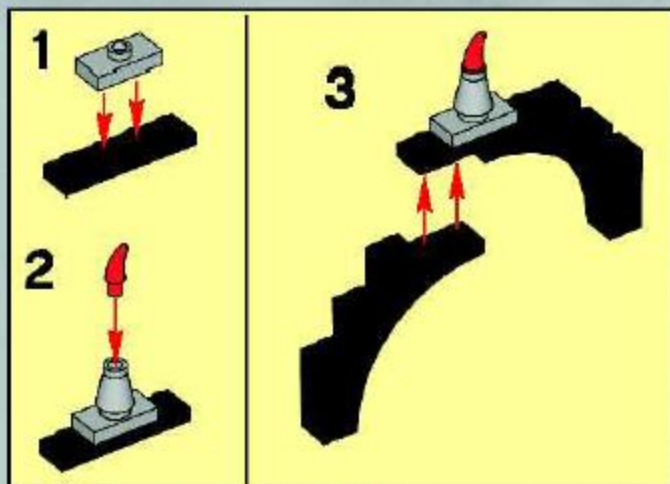

12



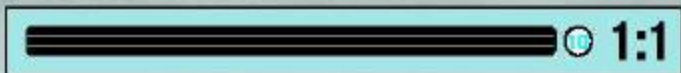
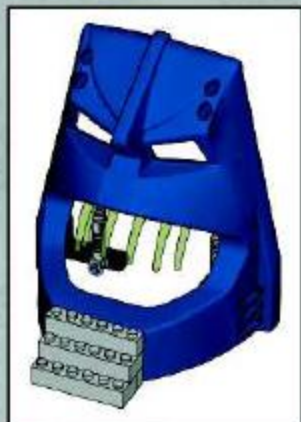

1

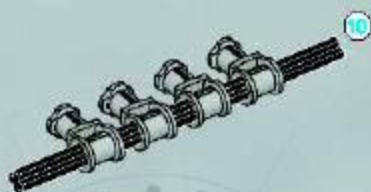

2



3

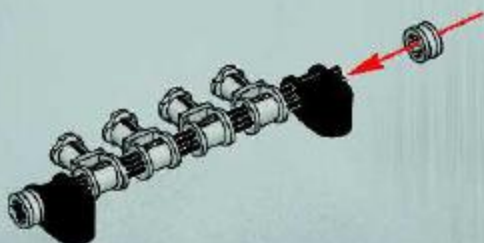



4

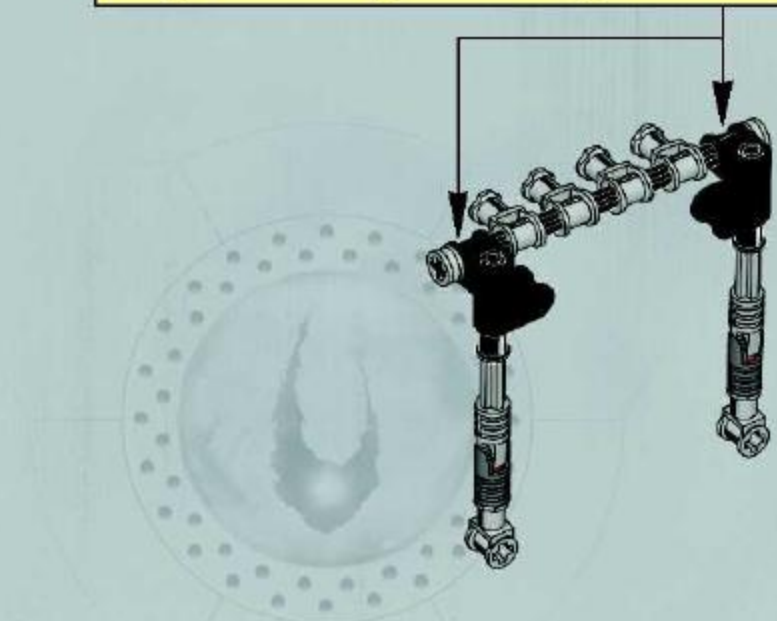
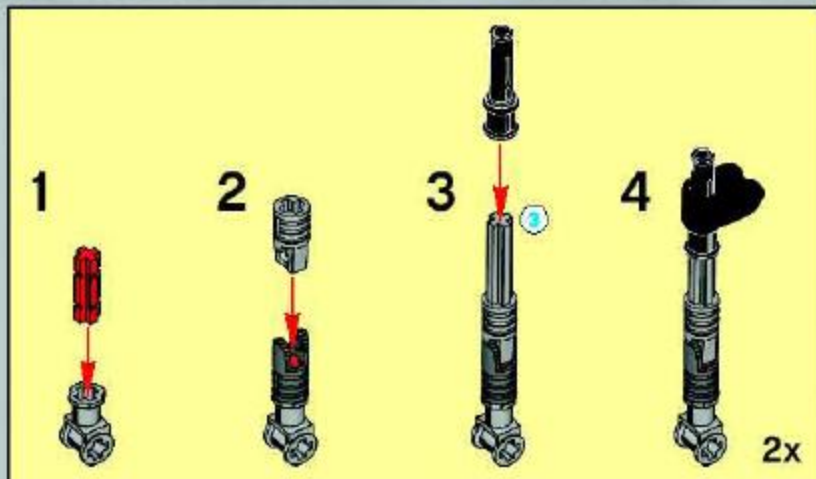

5

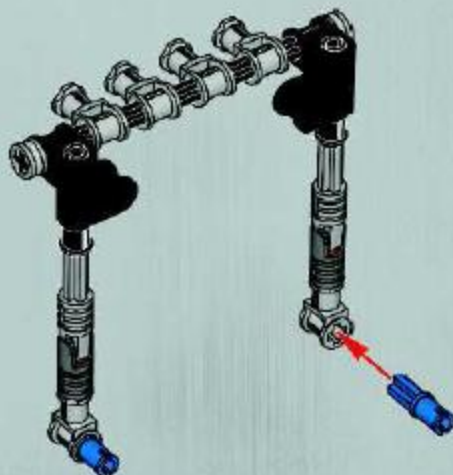



6



7

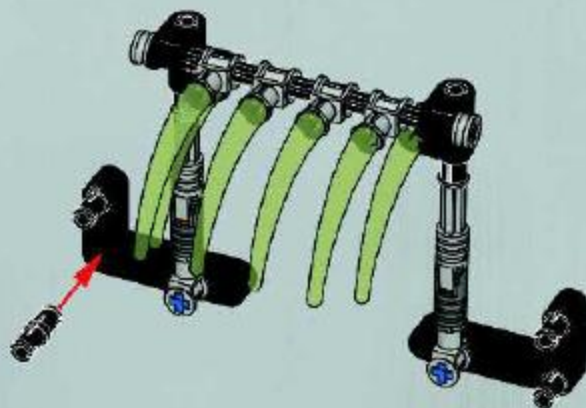

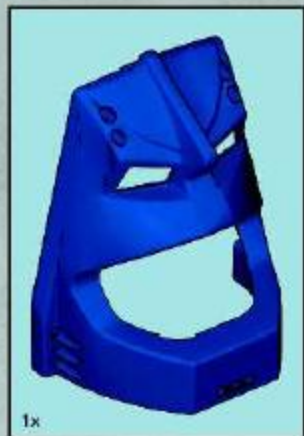

8



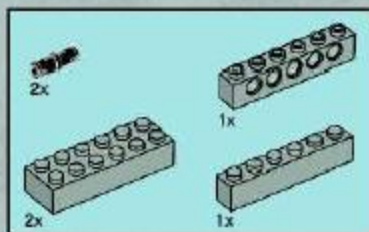

9

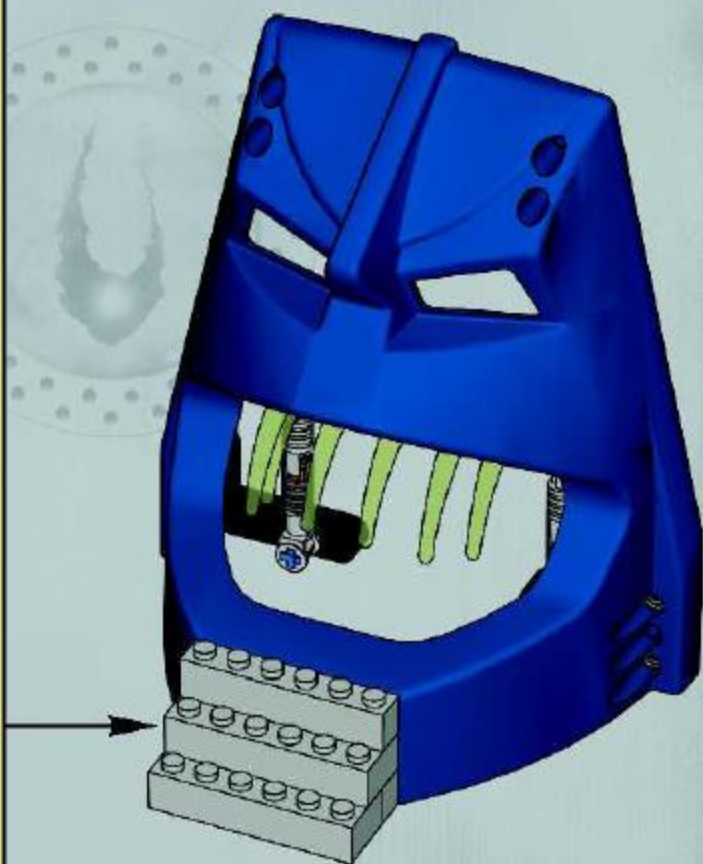
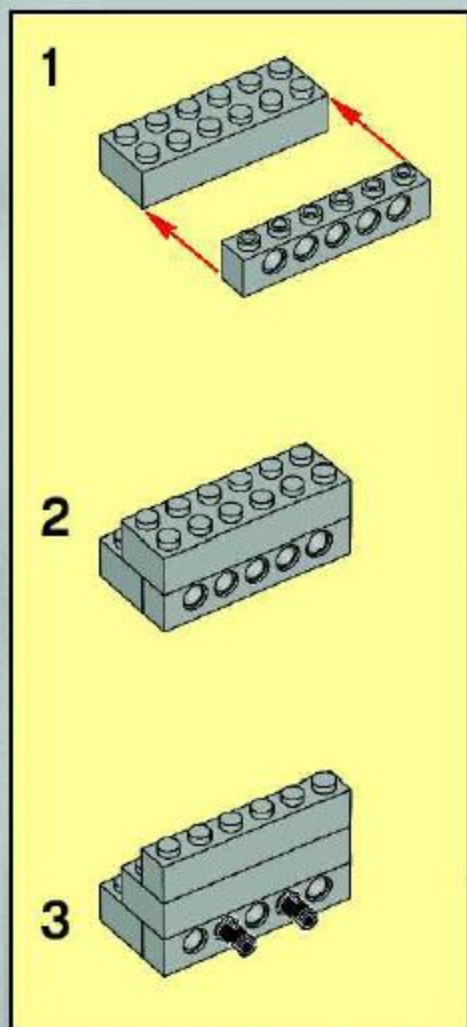

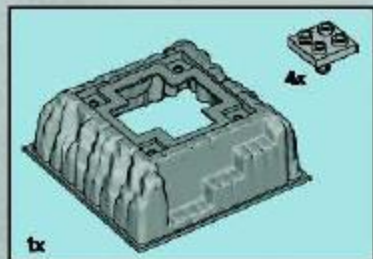
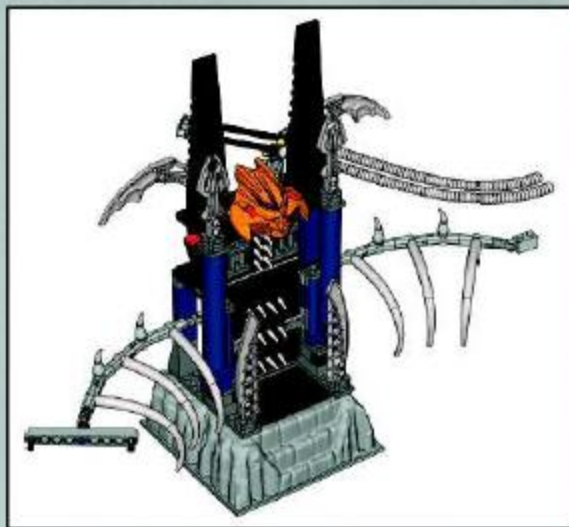

1

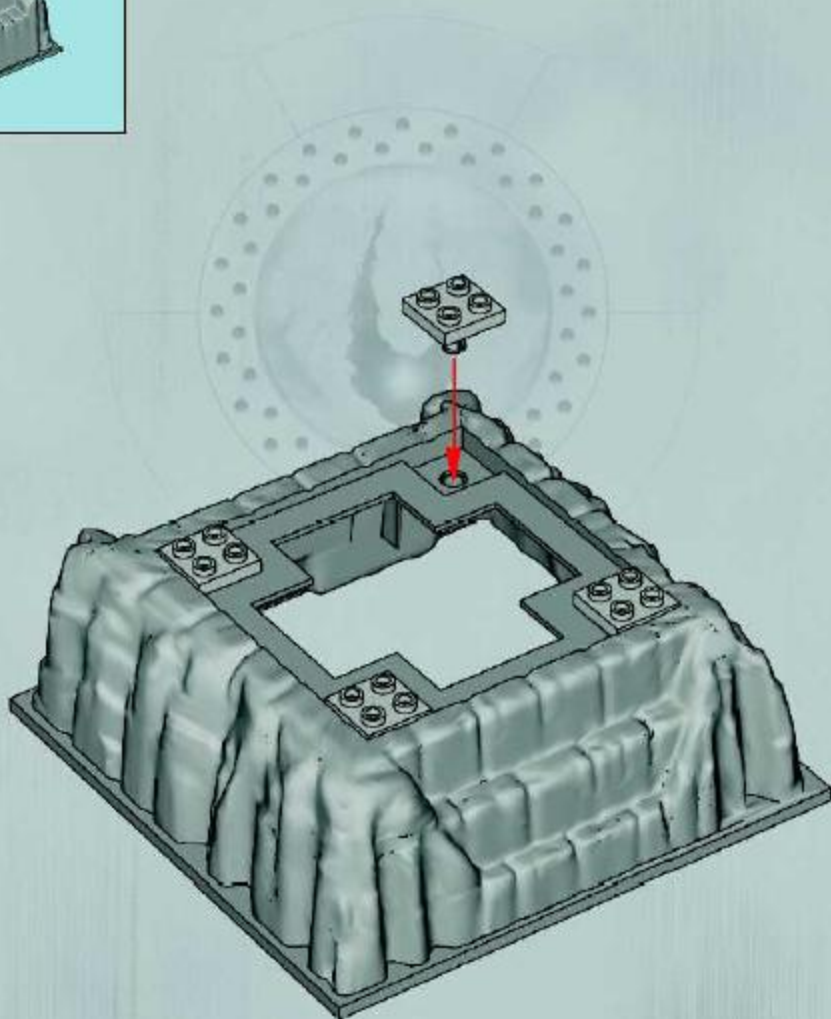

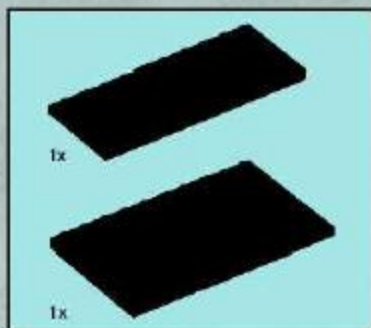

2

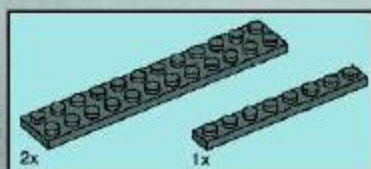
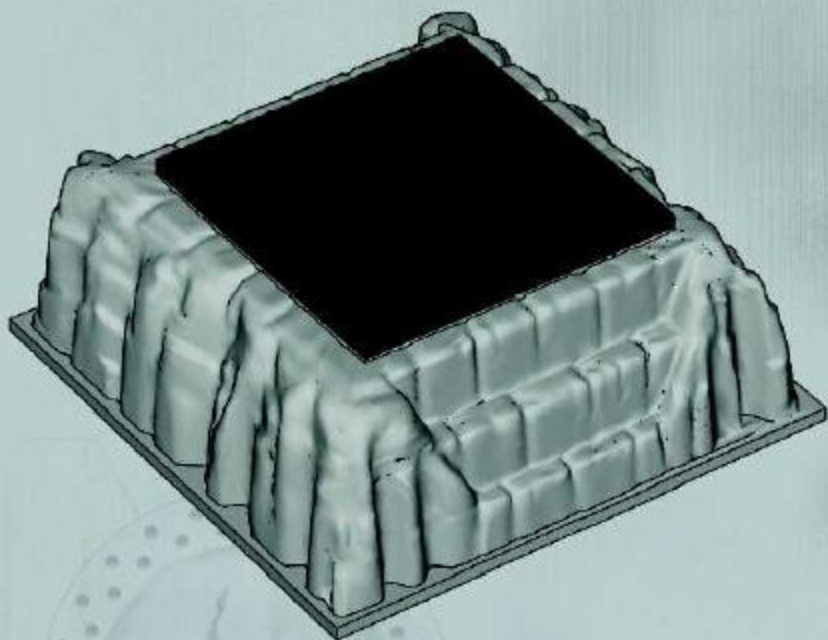

3

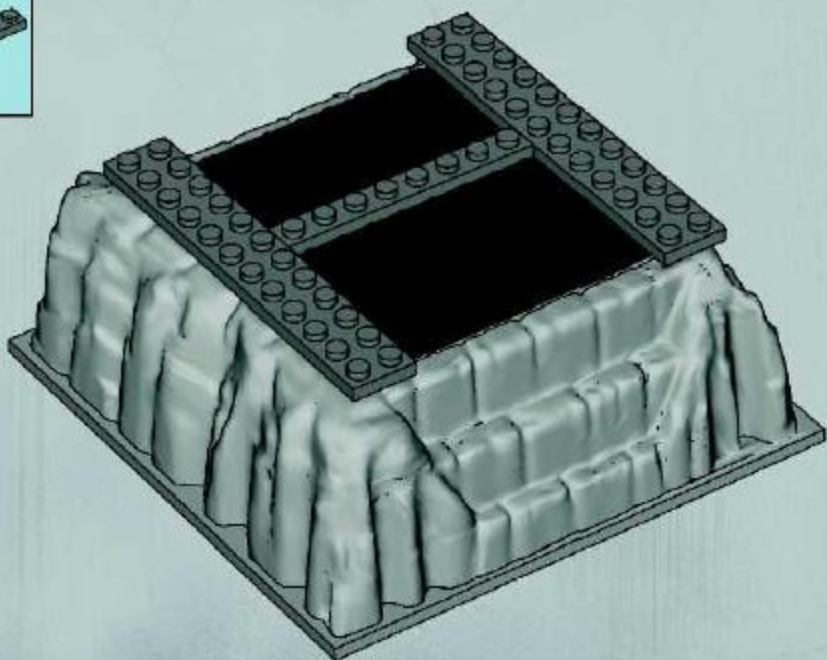

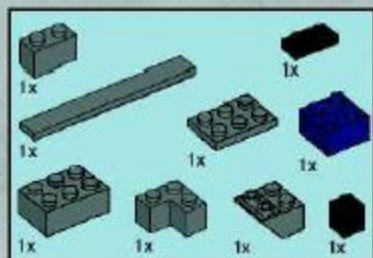

4

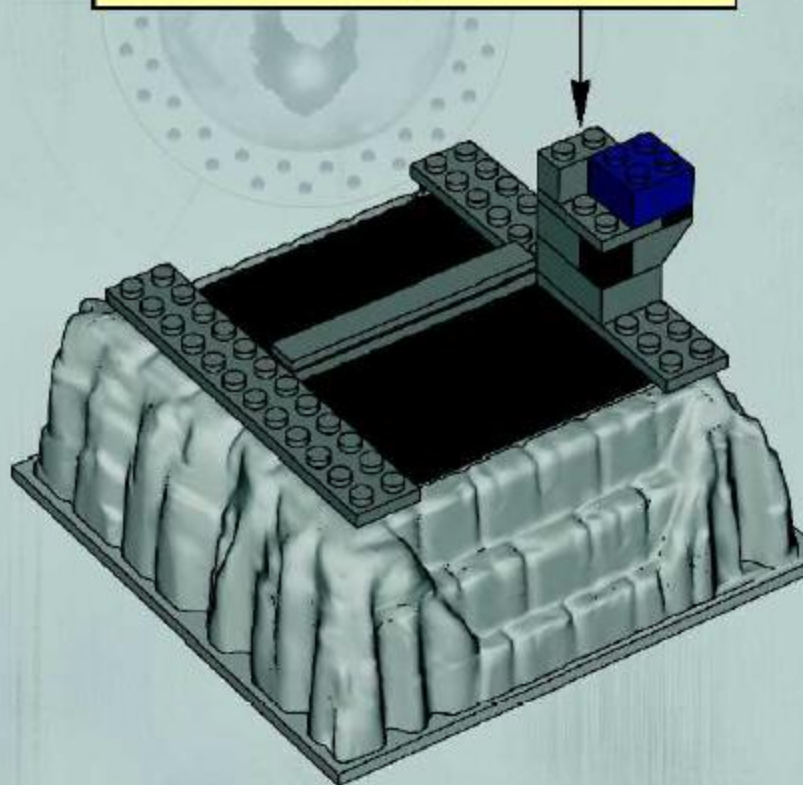
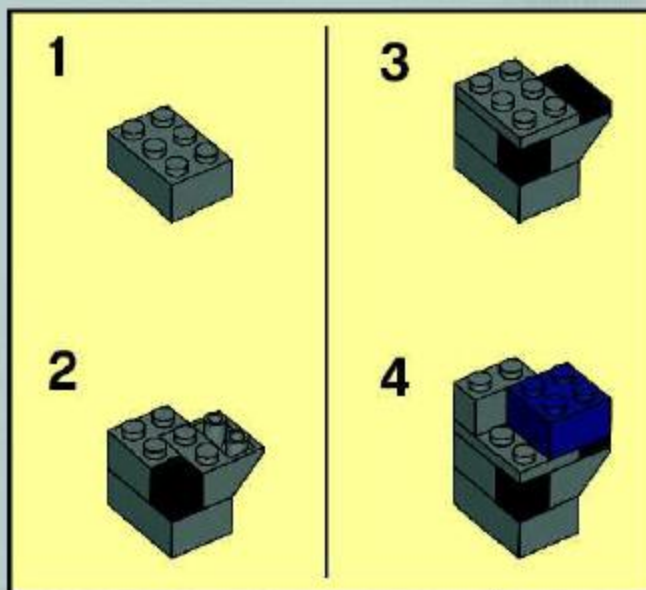

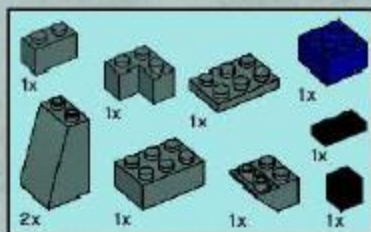

5

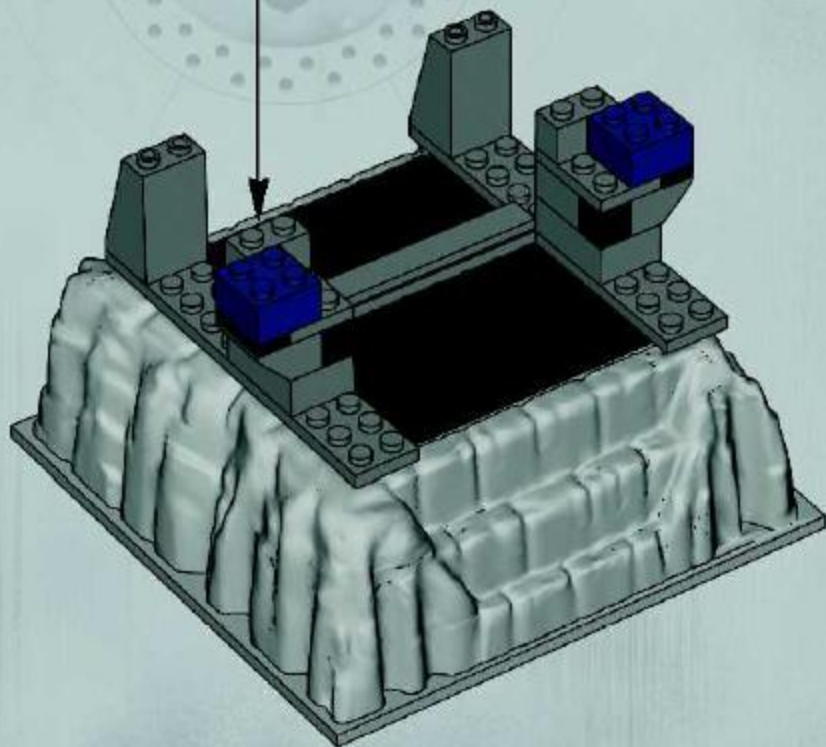
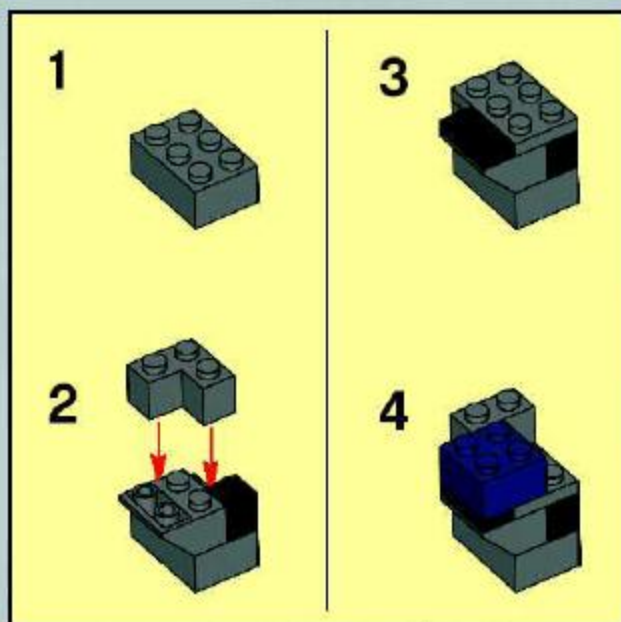

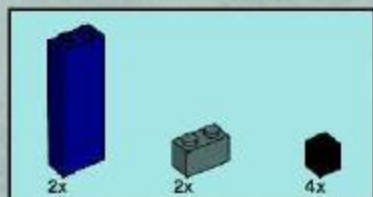

6

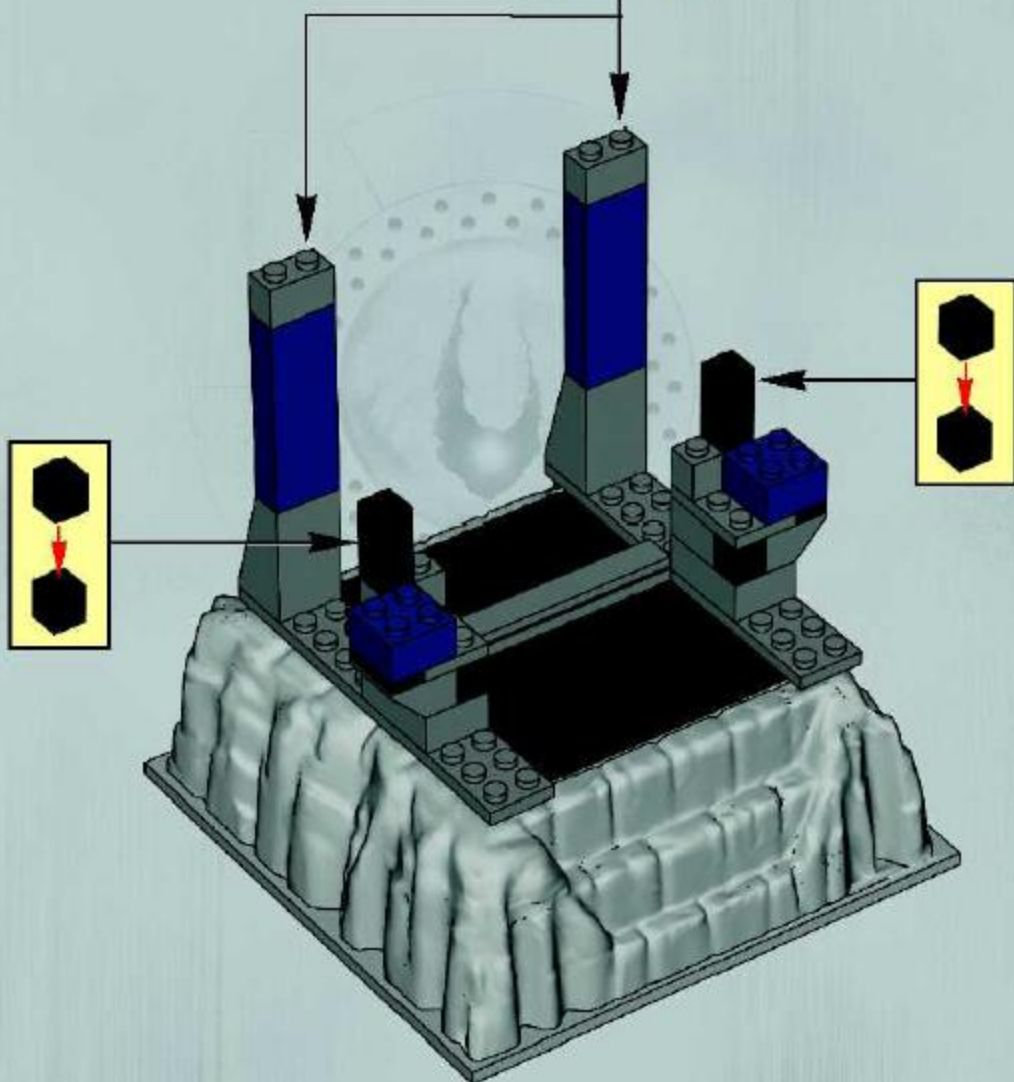
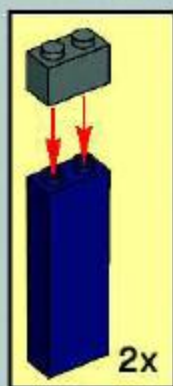

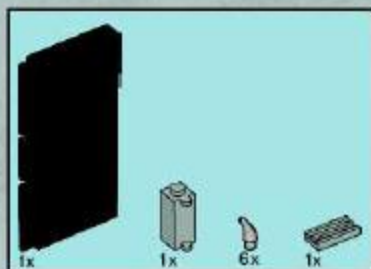

7

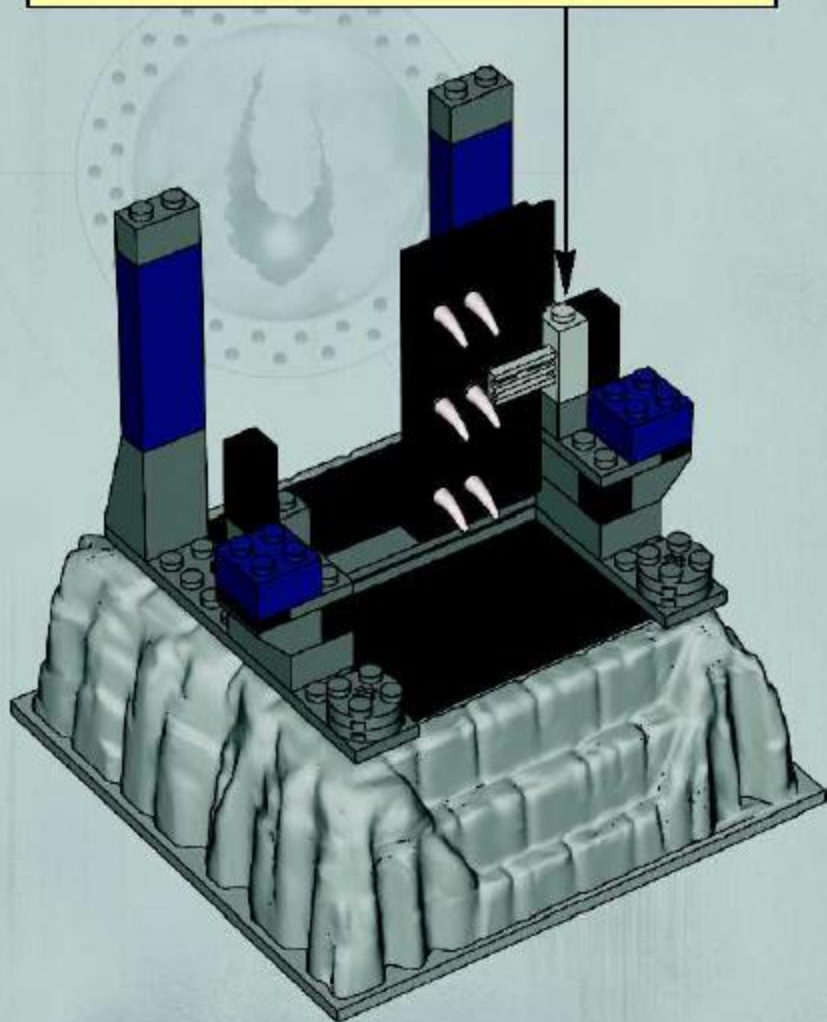
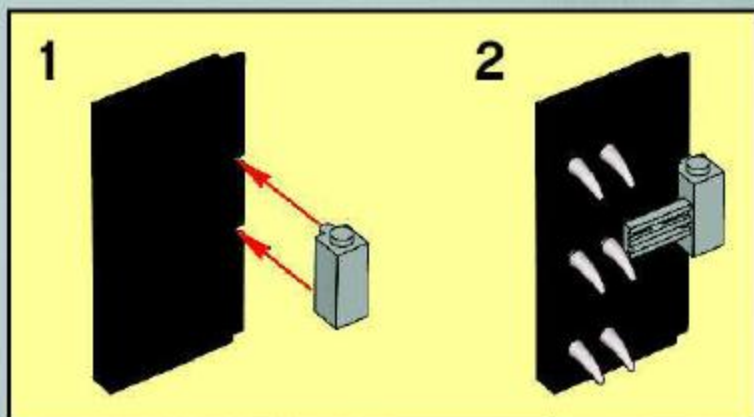

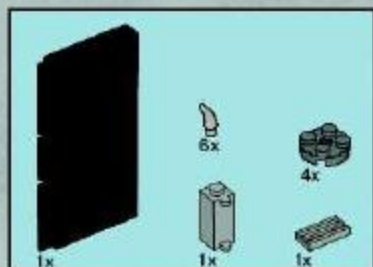

8

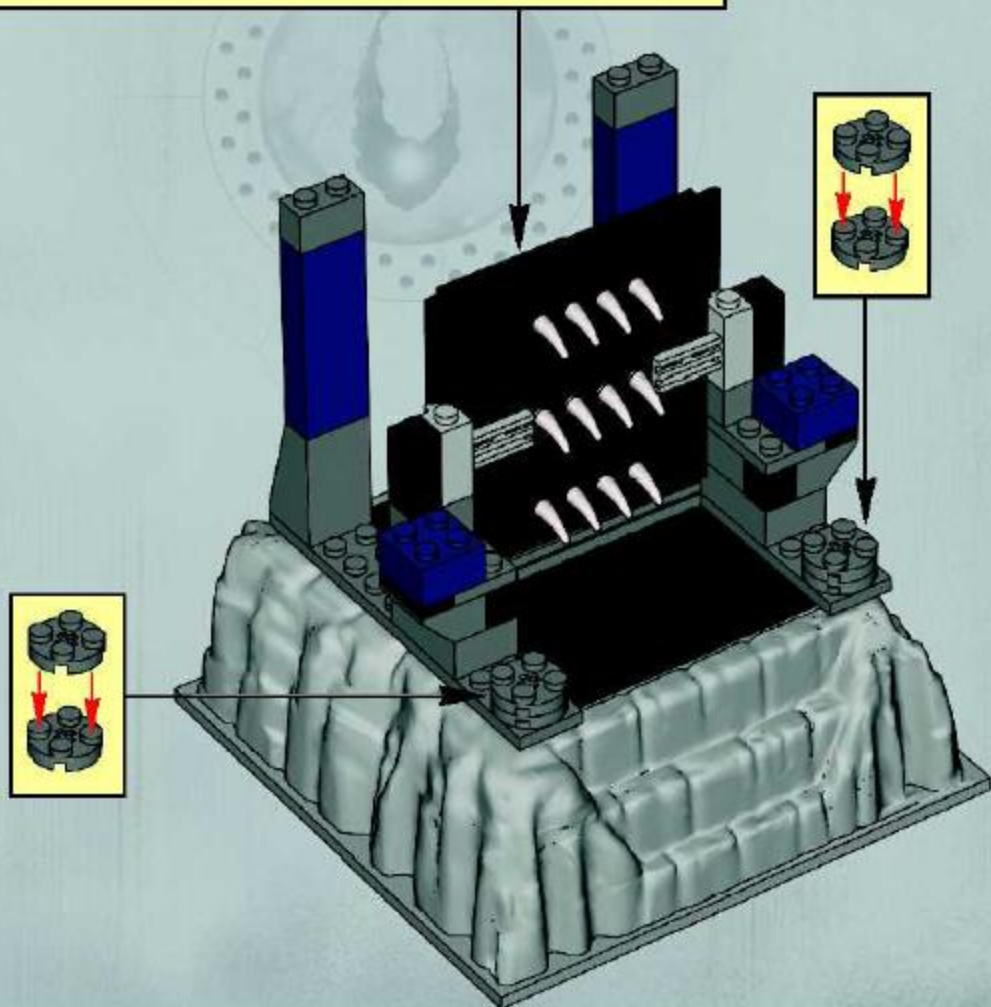
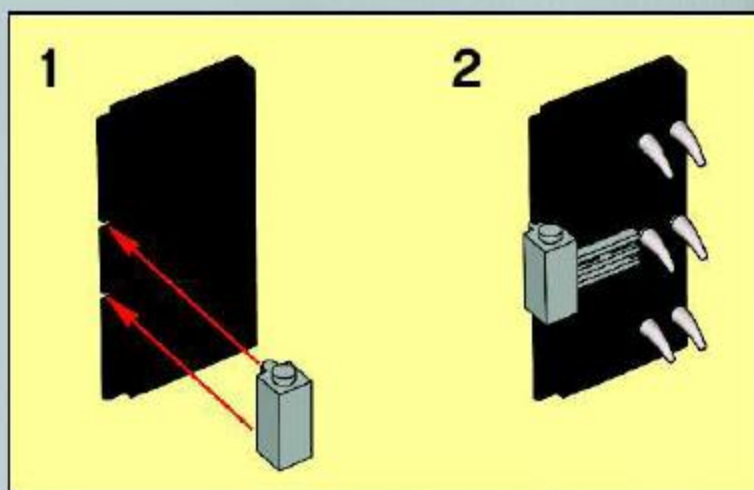

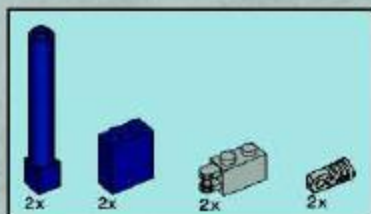

9

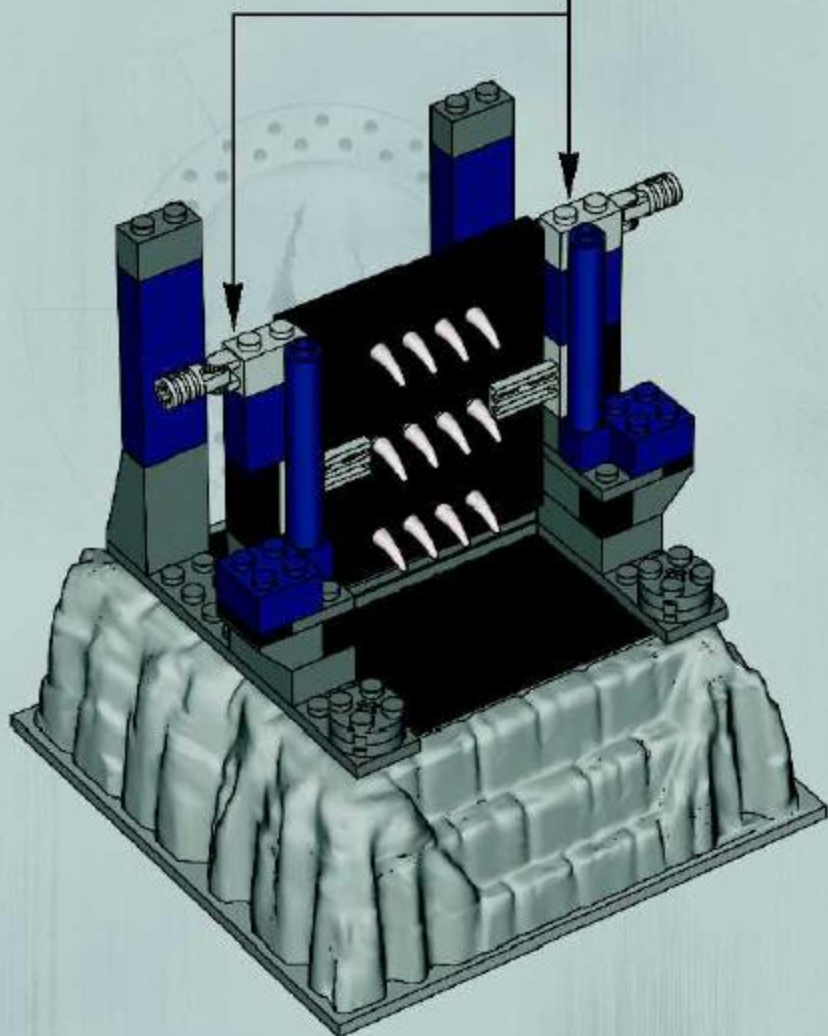
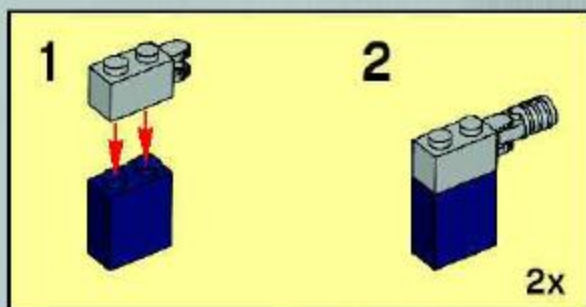



4x

10

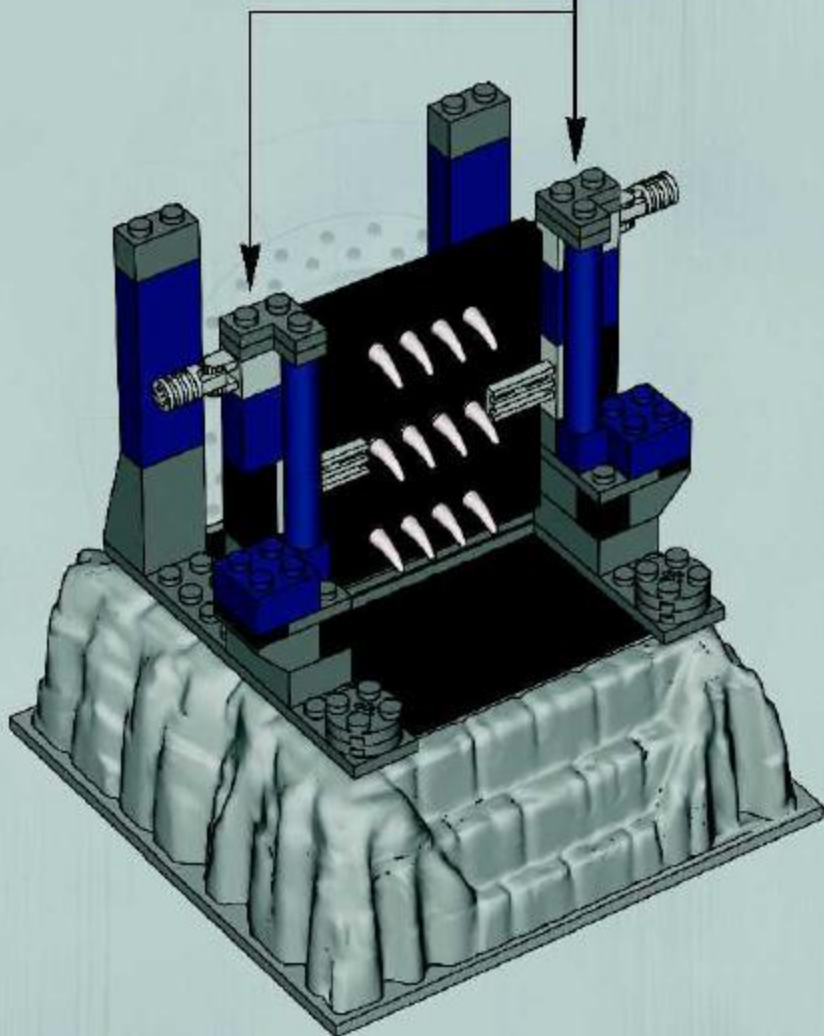
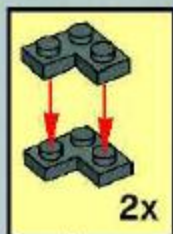

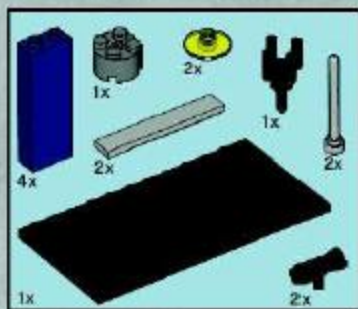

11

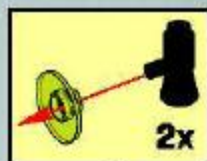
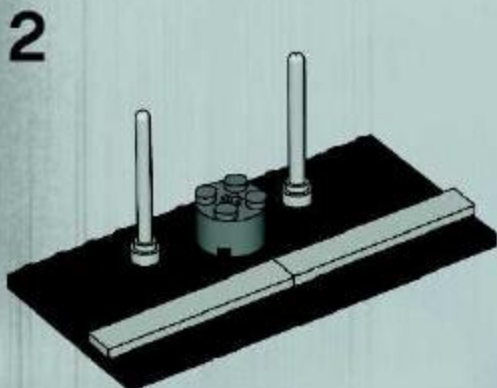
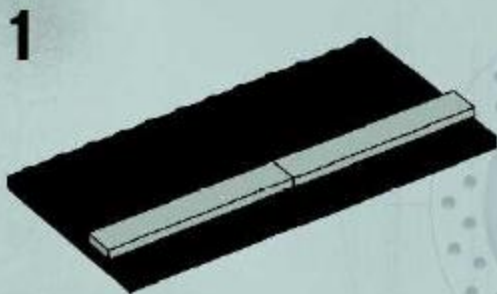

3

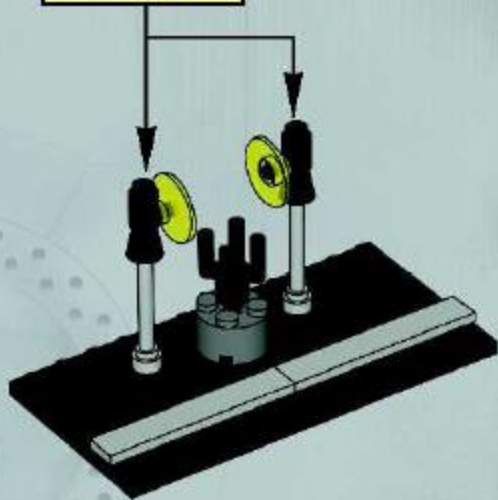

4

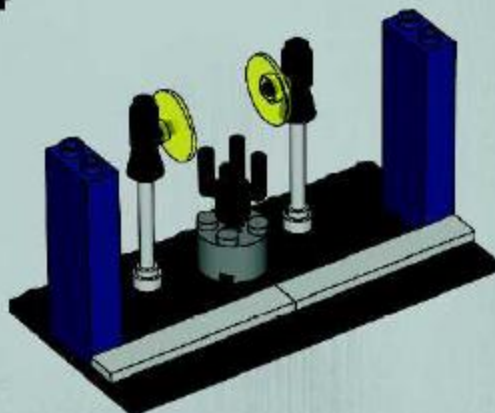

5

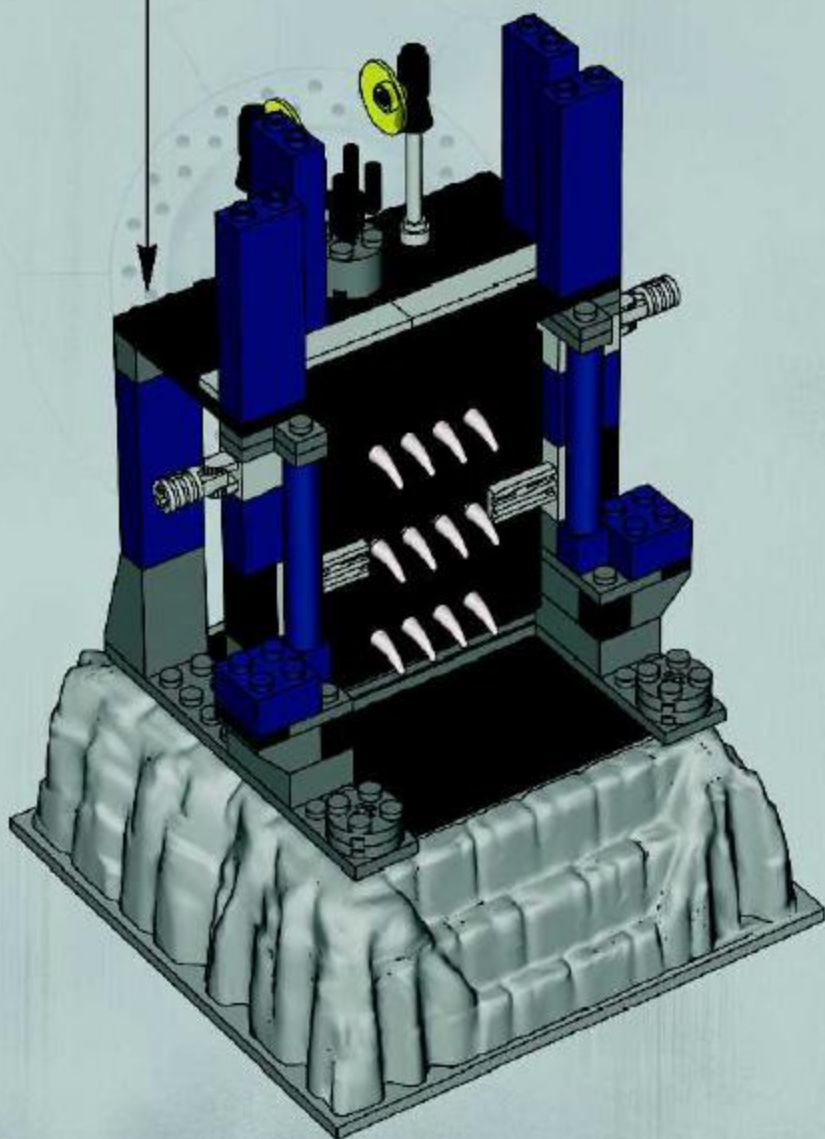
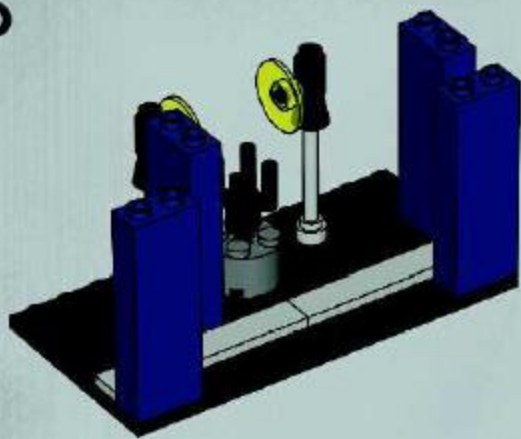

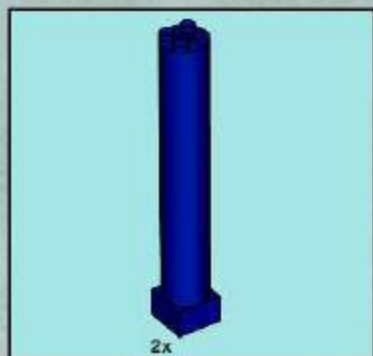

12

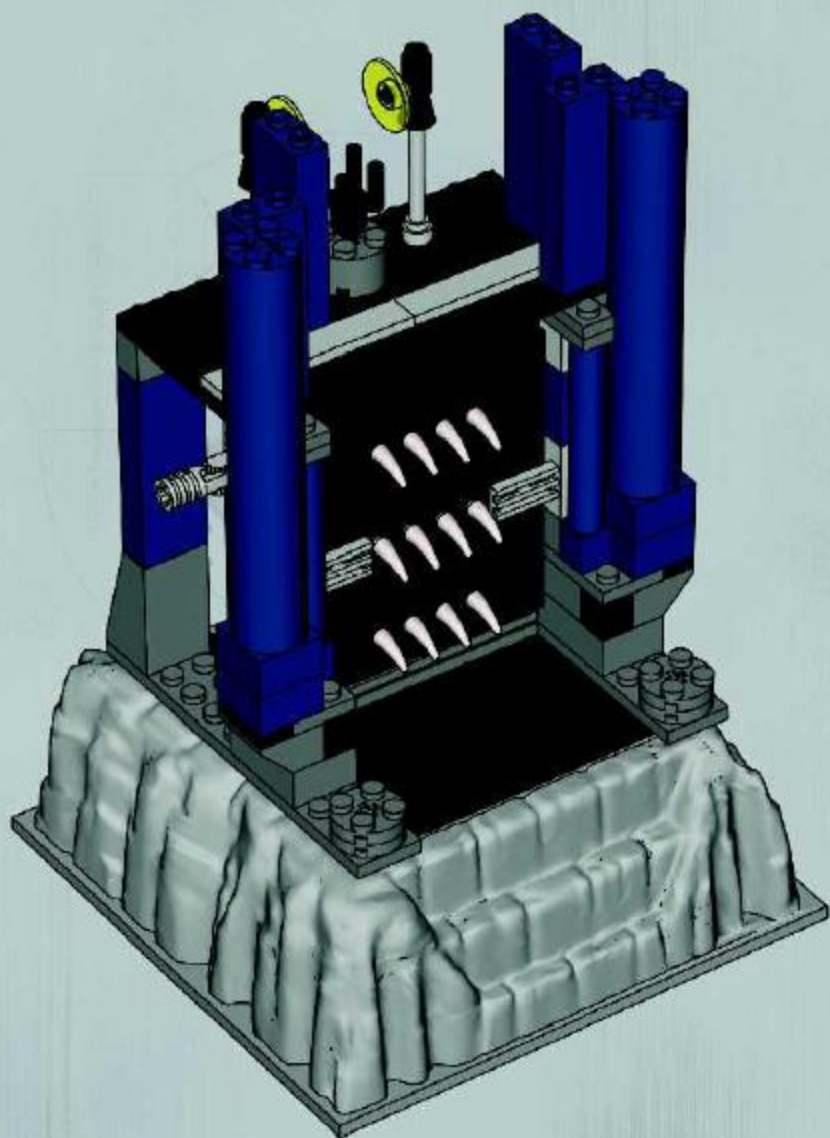

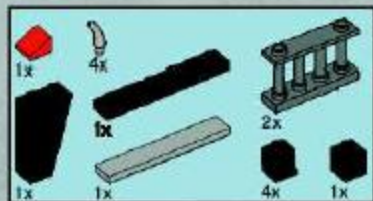

13

1



2



3



4

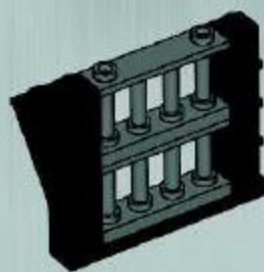

5

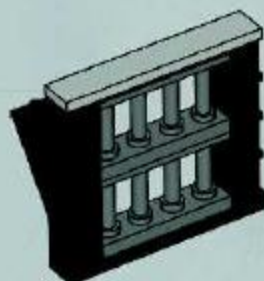

6



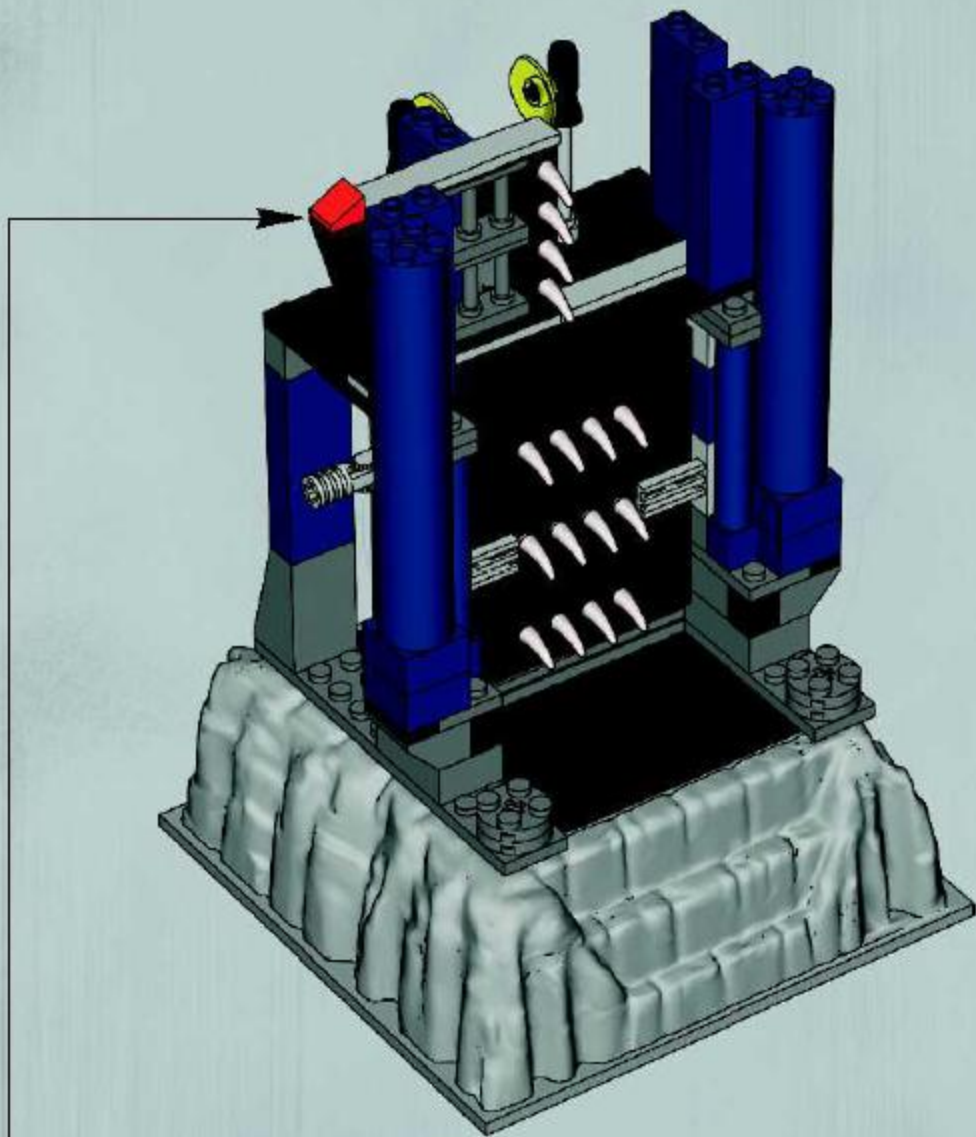

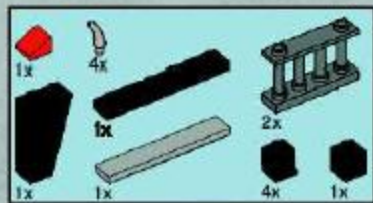

14

1

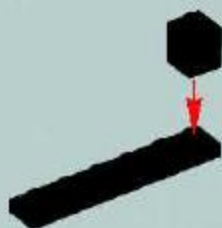

2



3

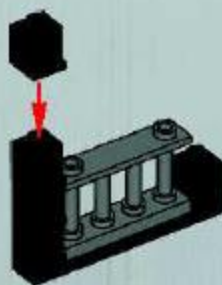

4

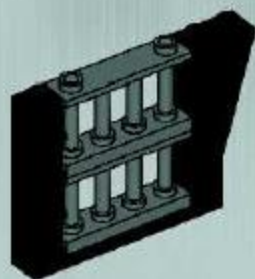

5

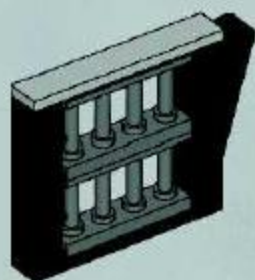

6

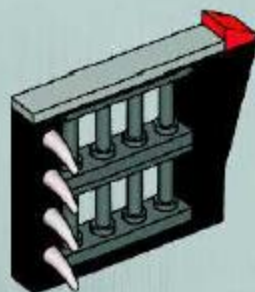

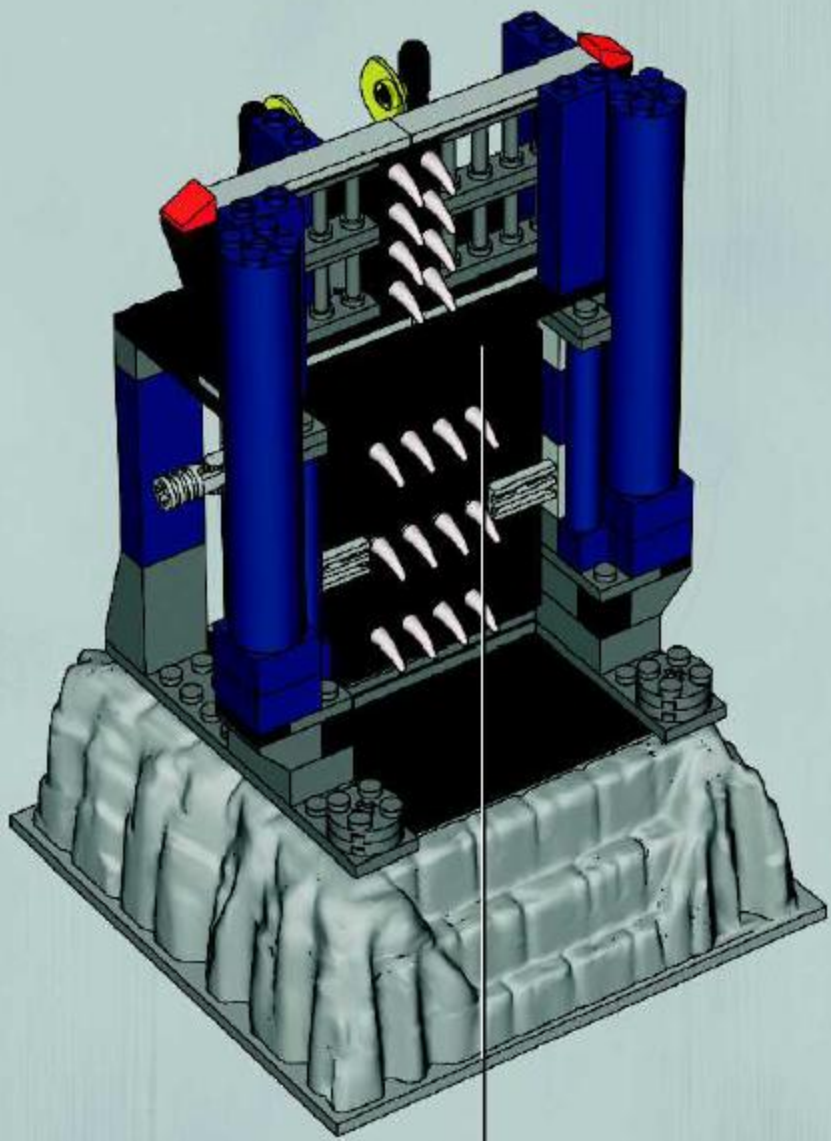

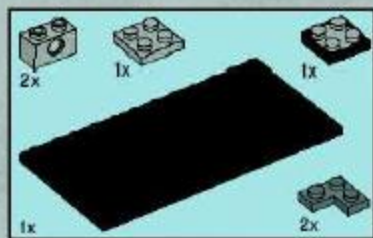

15

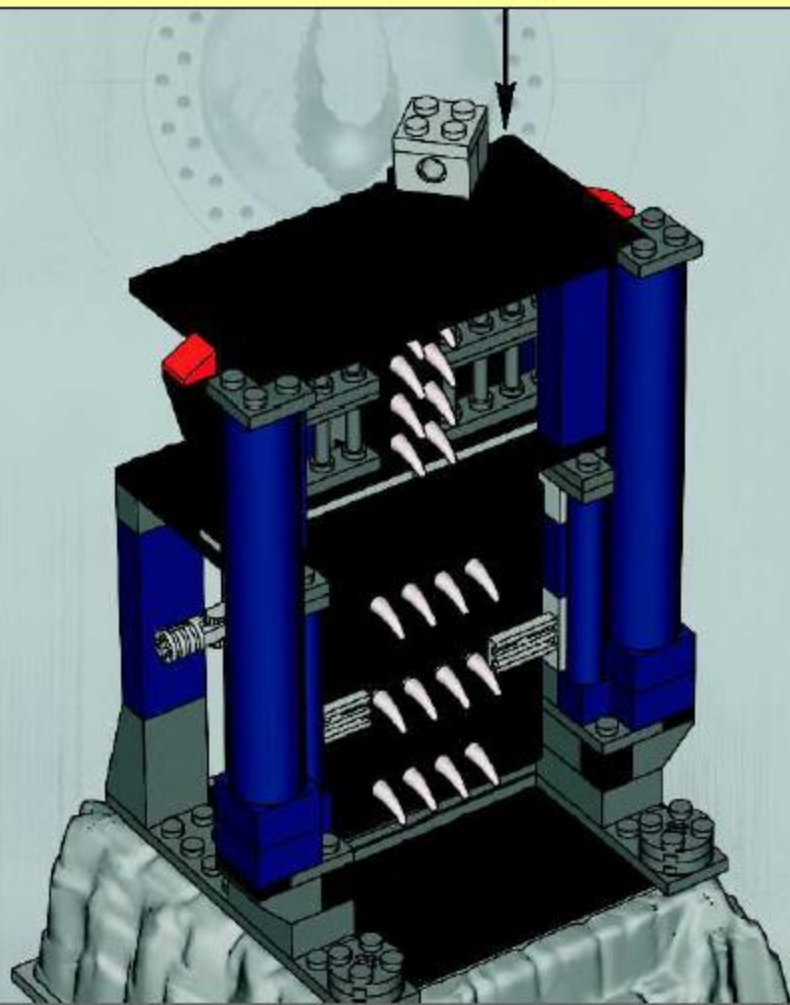
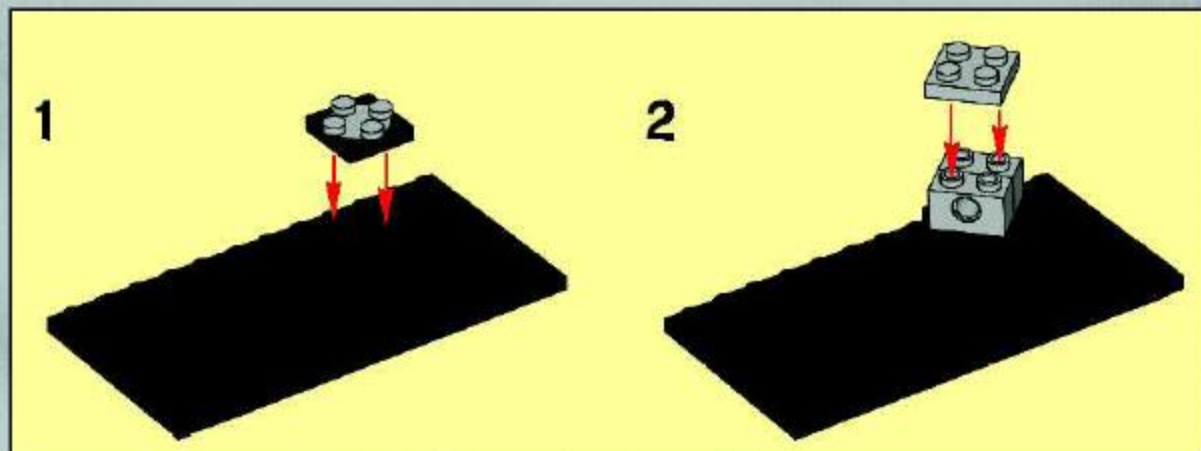



16

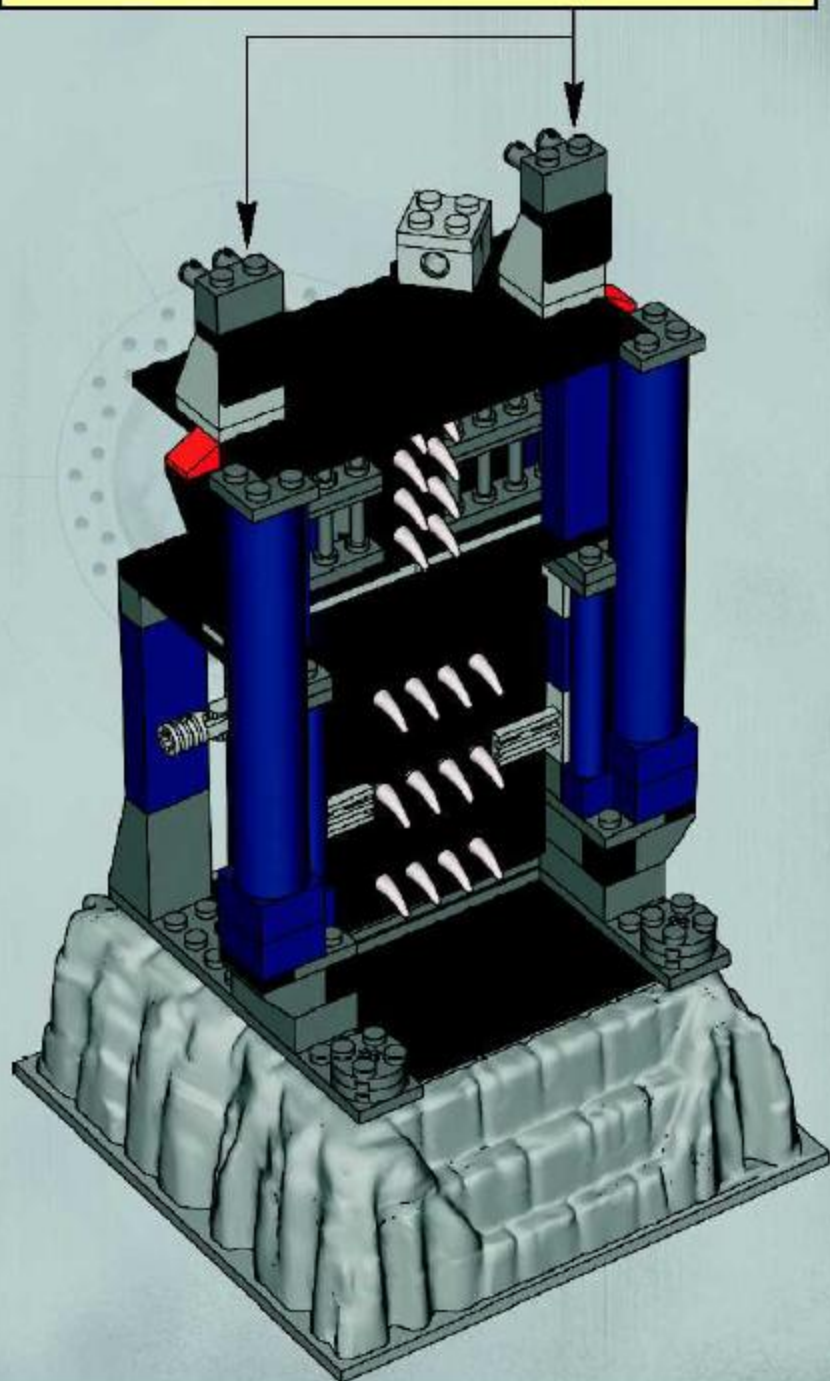
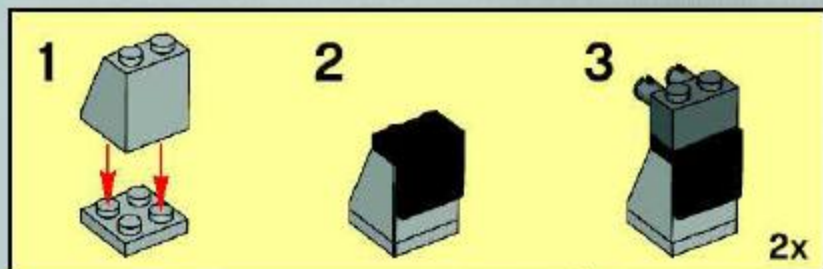

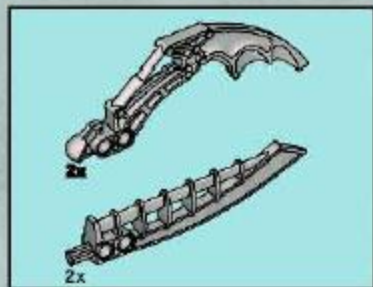

17

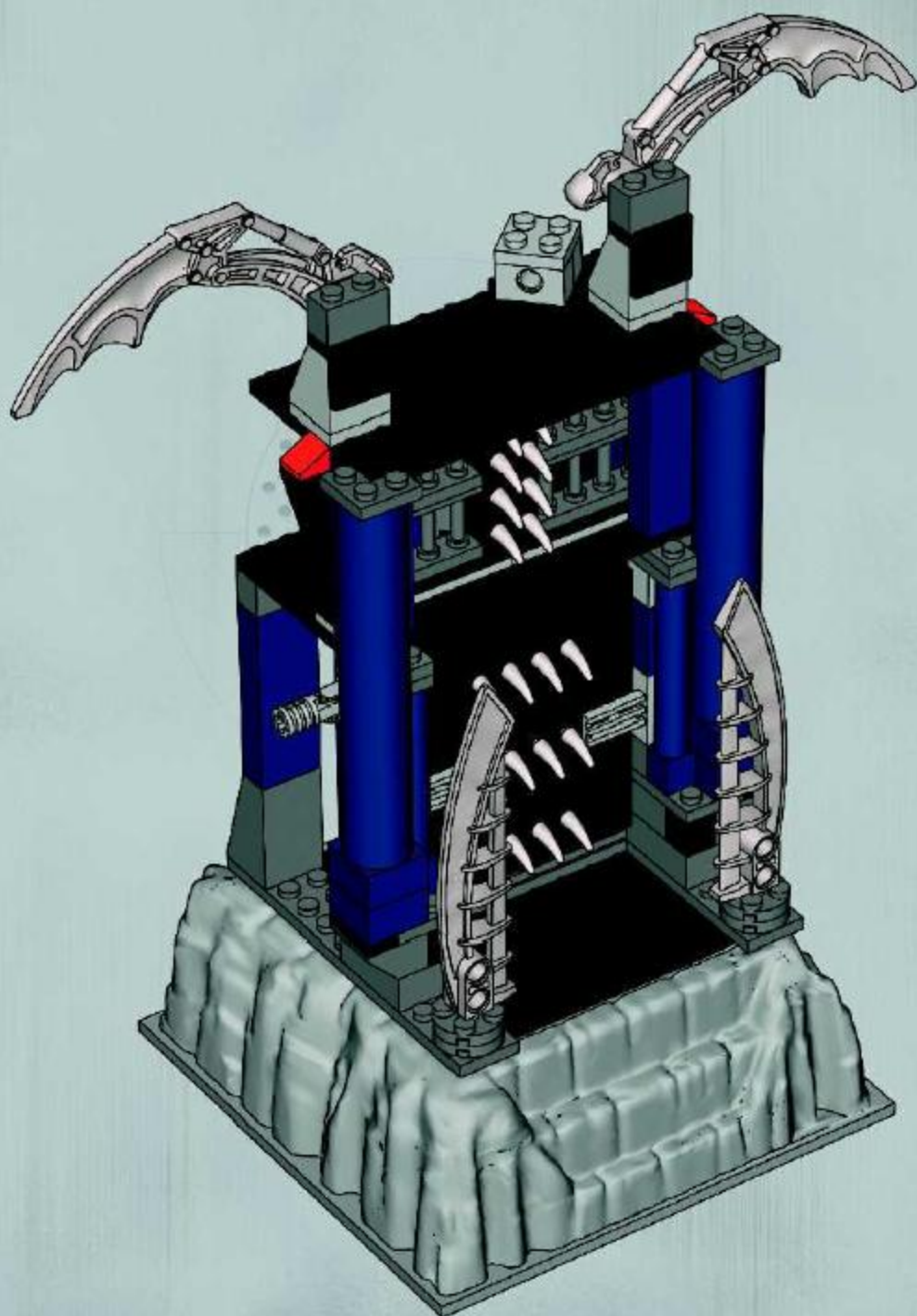



18

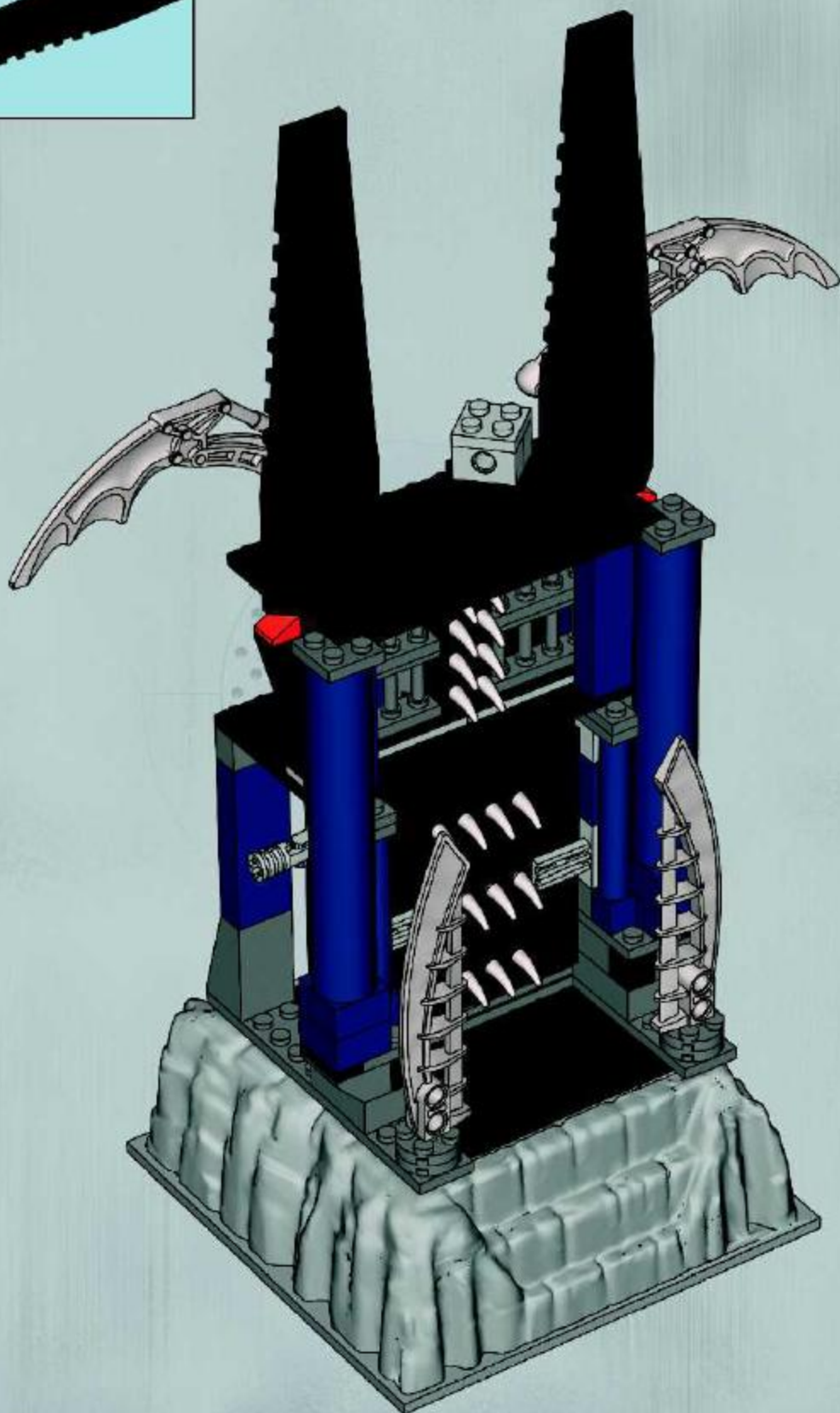



4x

19

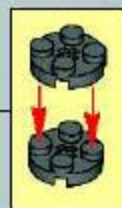
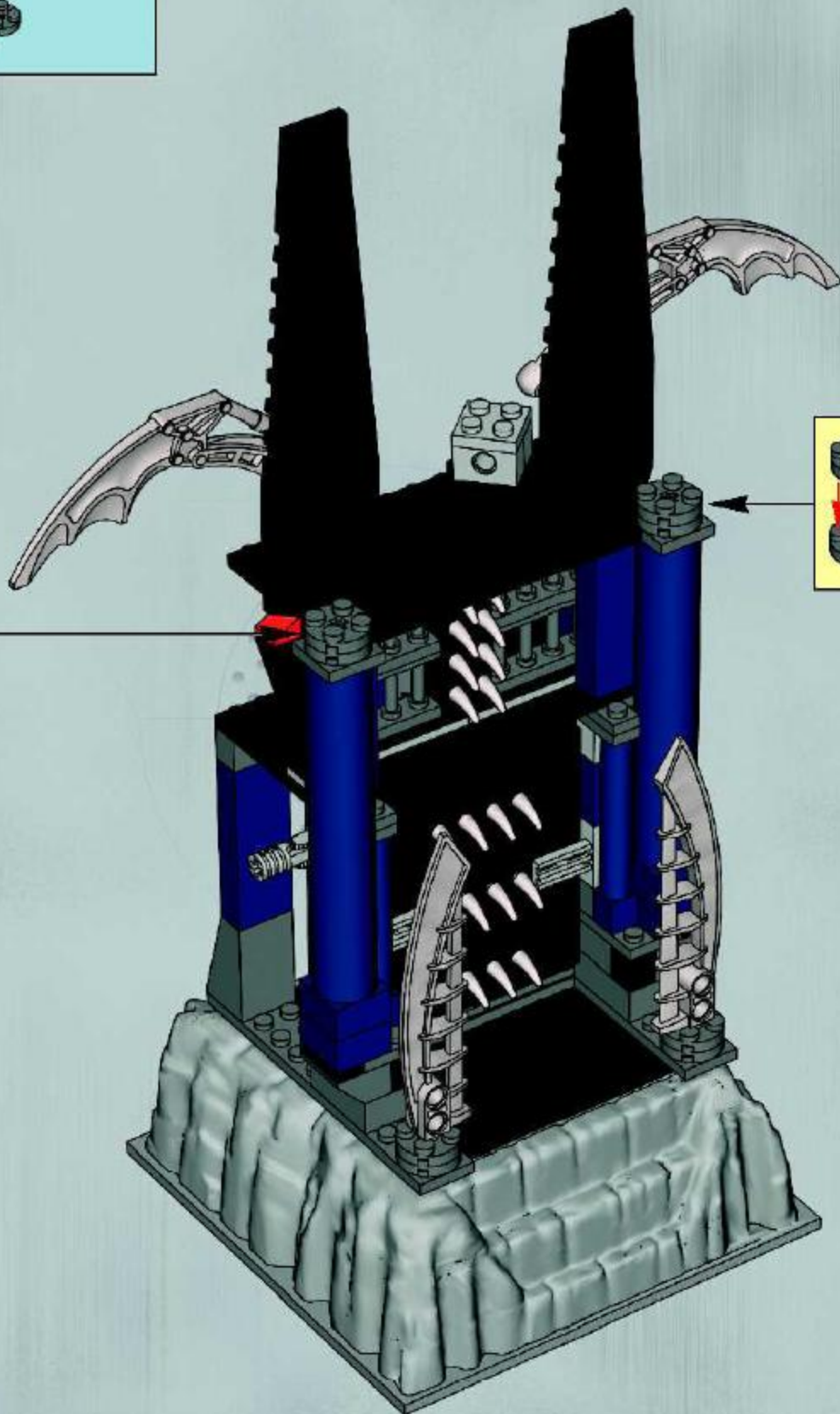
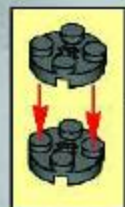



20

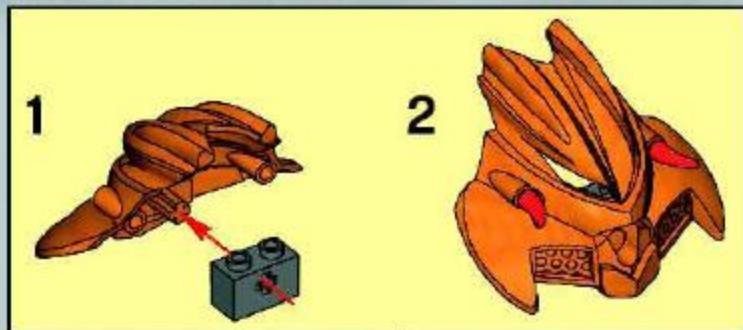

7

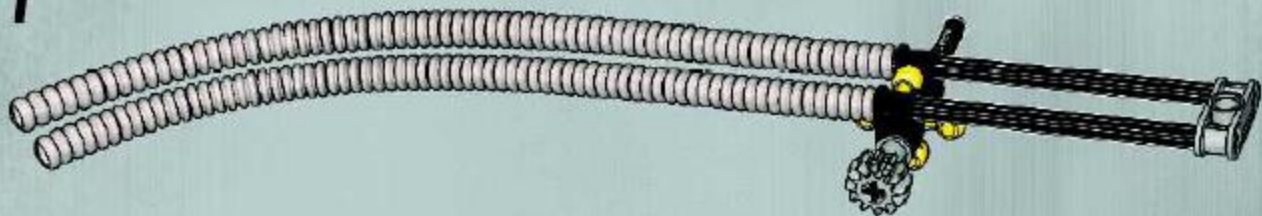

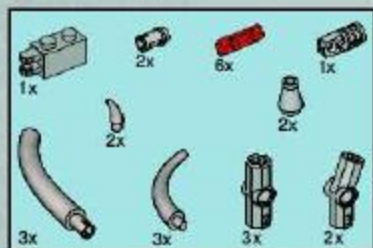
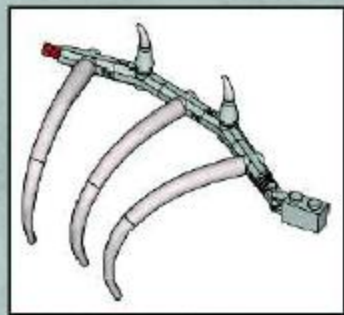

22

1

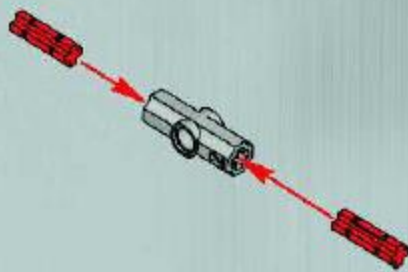

2

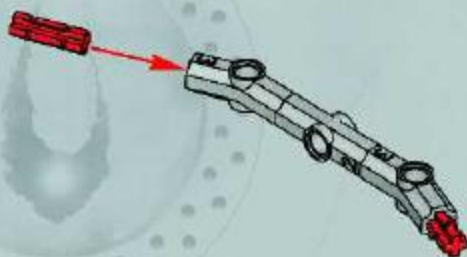

3

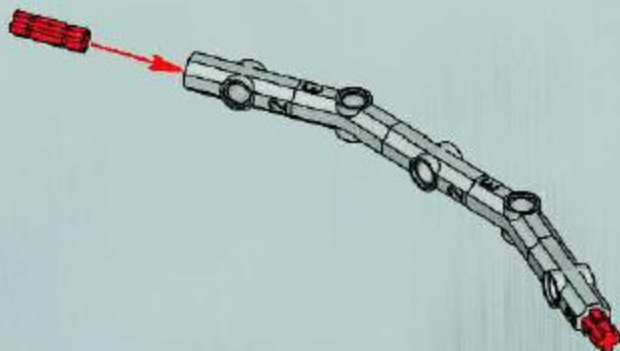

4

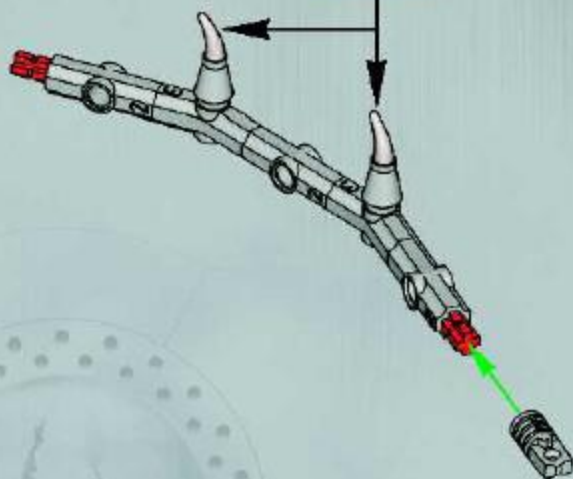
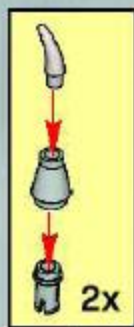

5

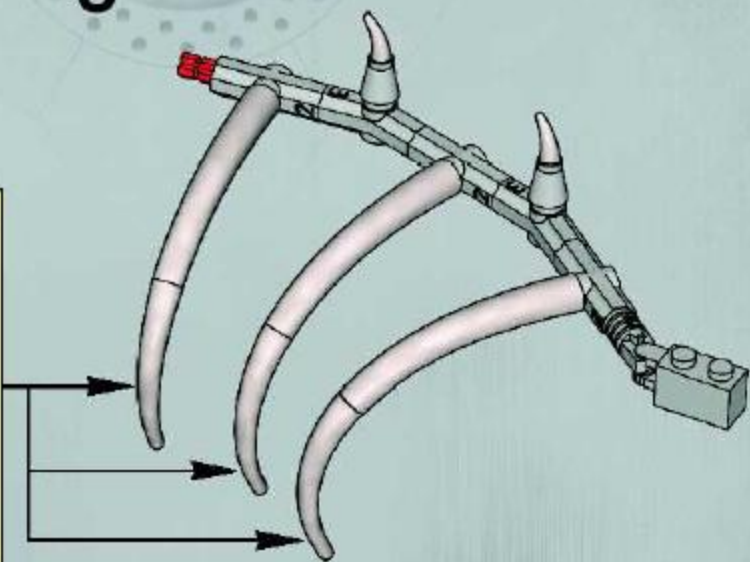
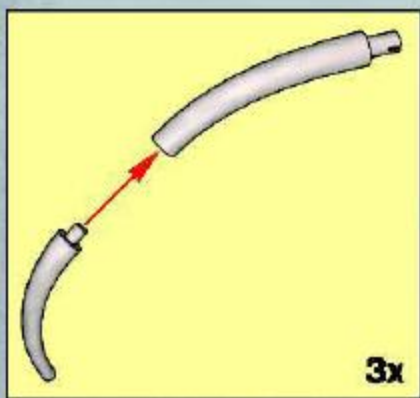



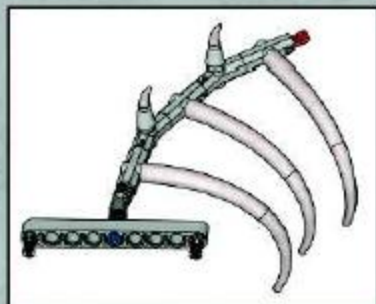

1

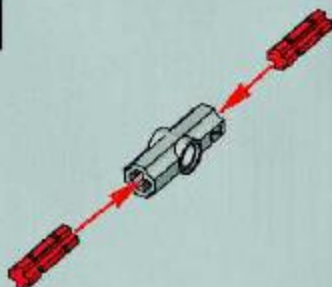

23

2

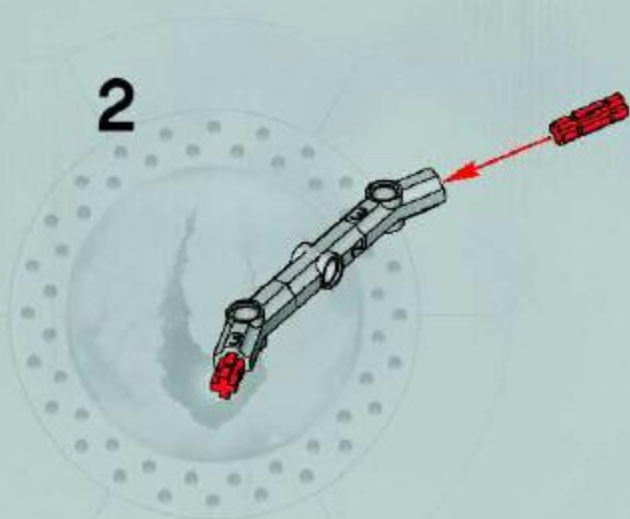

3

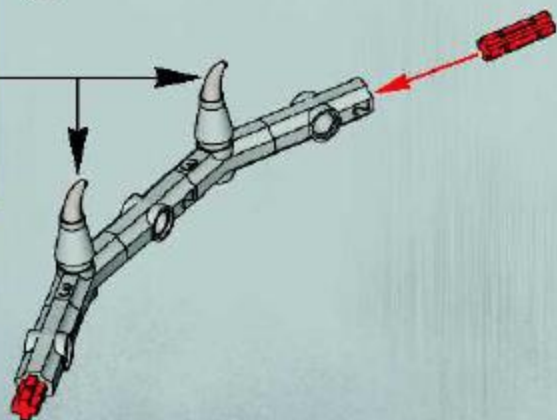
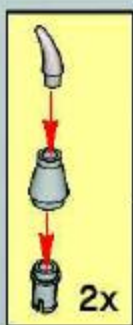

4

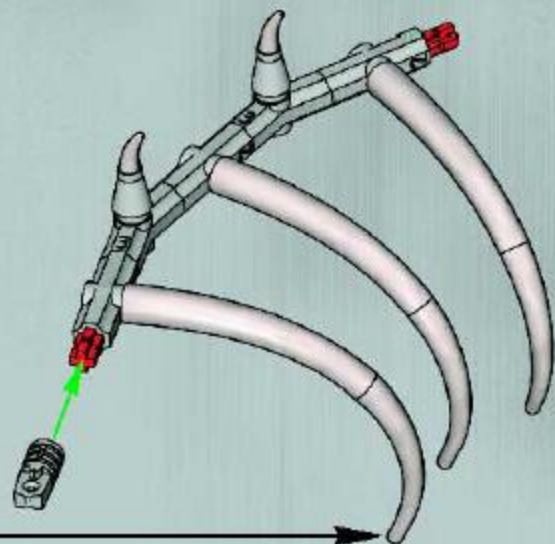
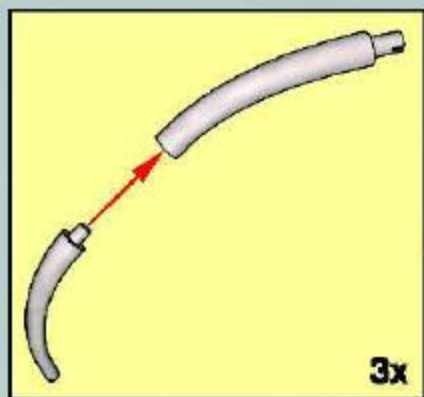

1

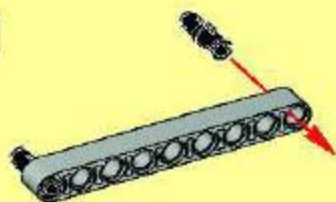

2

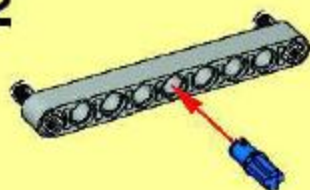

3

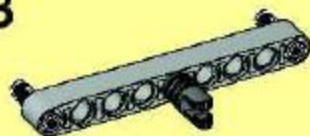

5

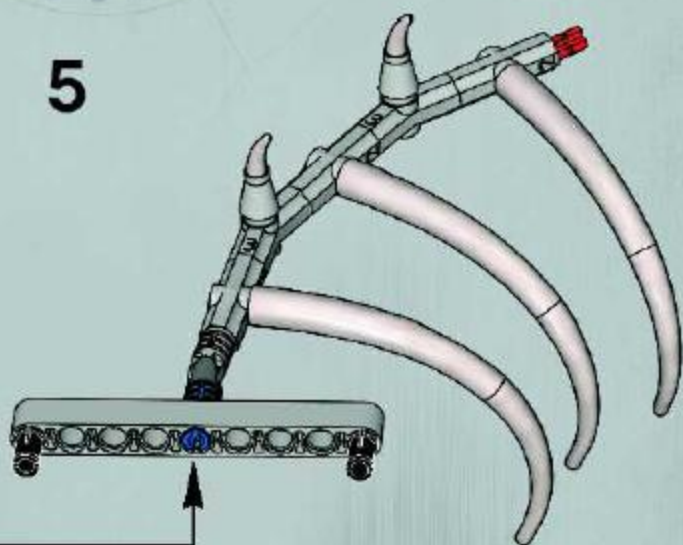



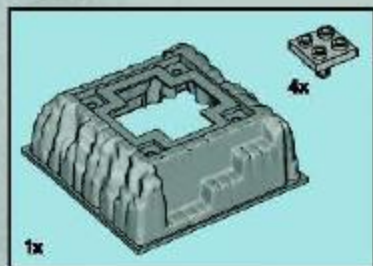

1

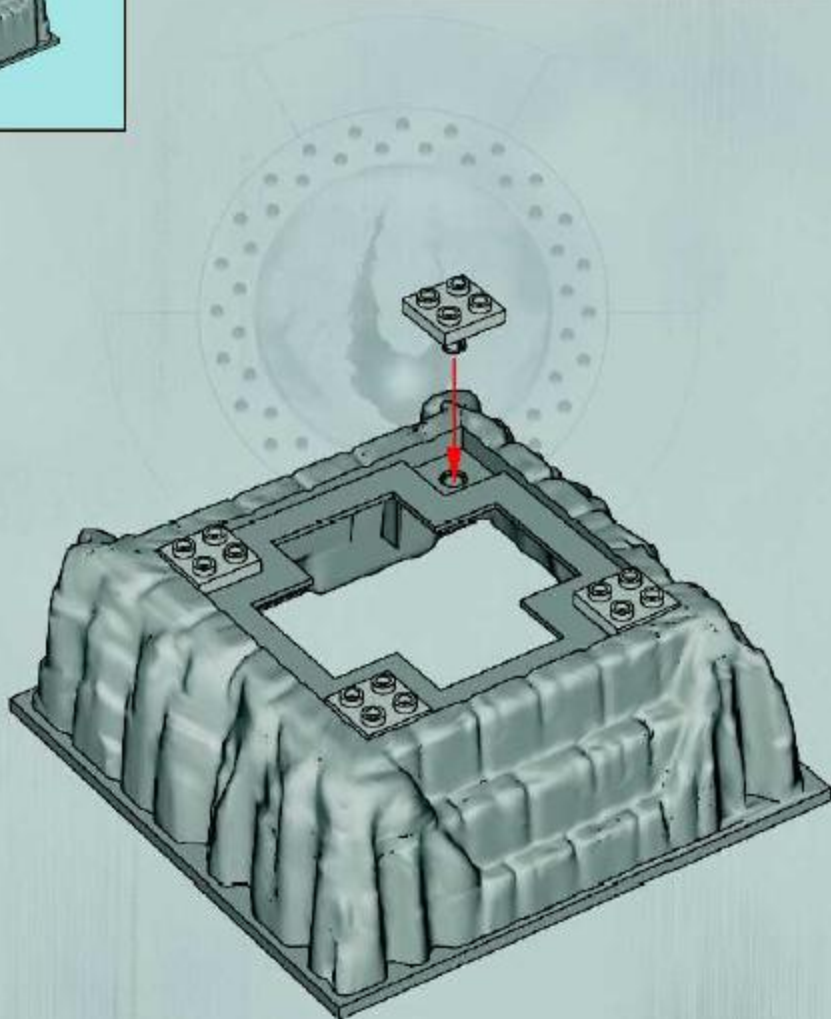

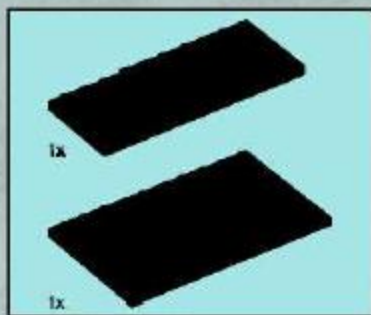

2

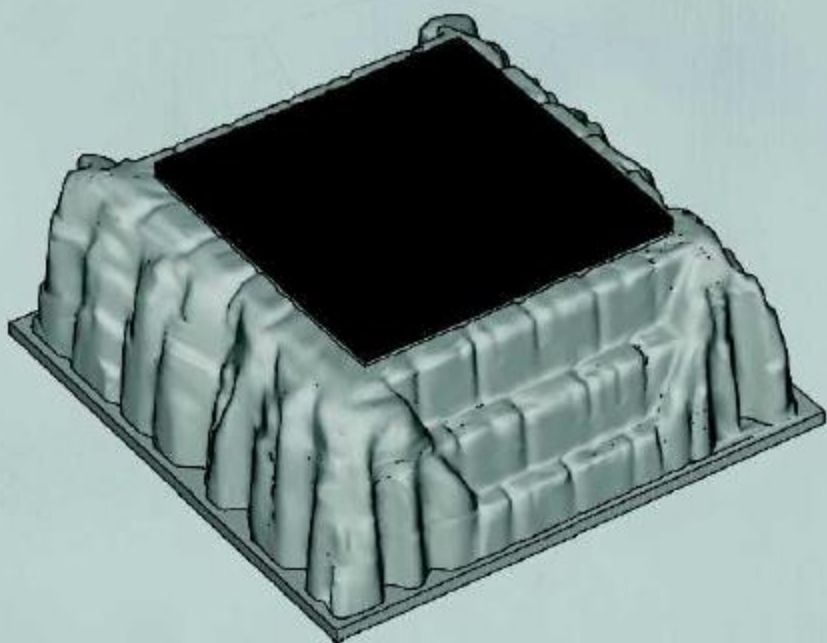

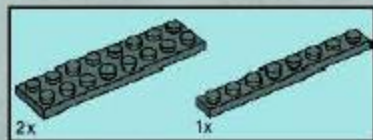

3

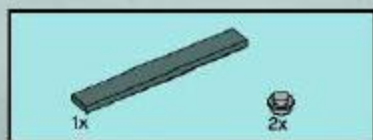
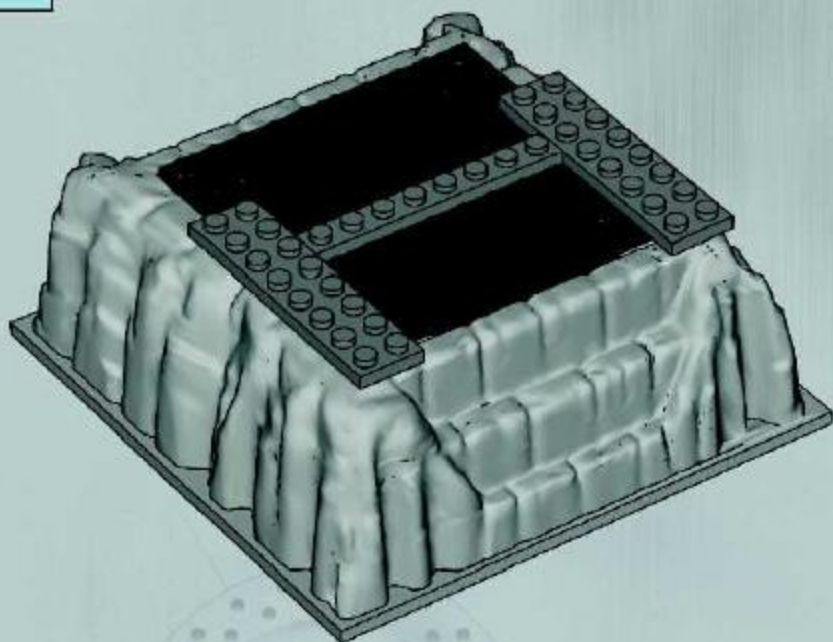

4

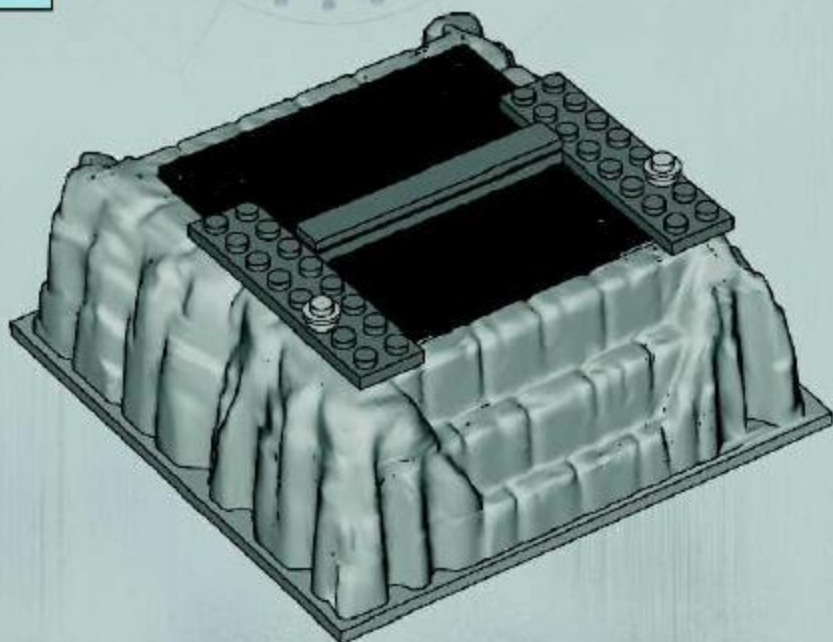

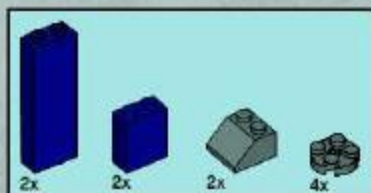

5

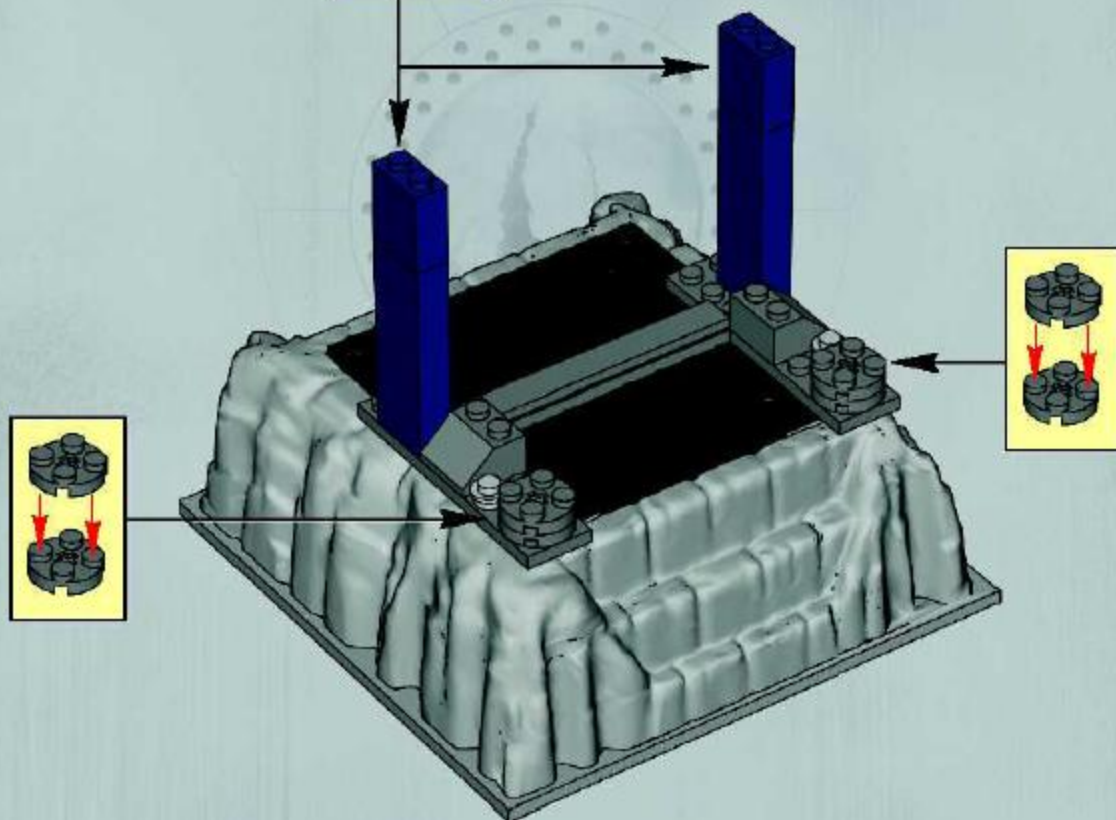
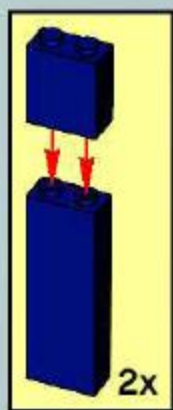

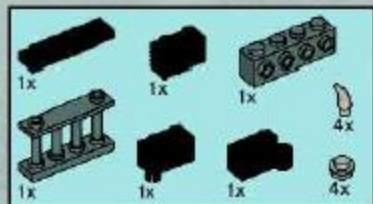

6

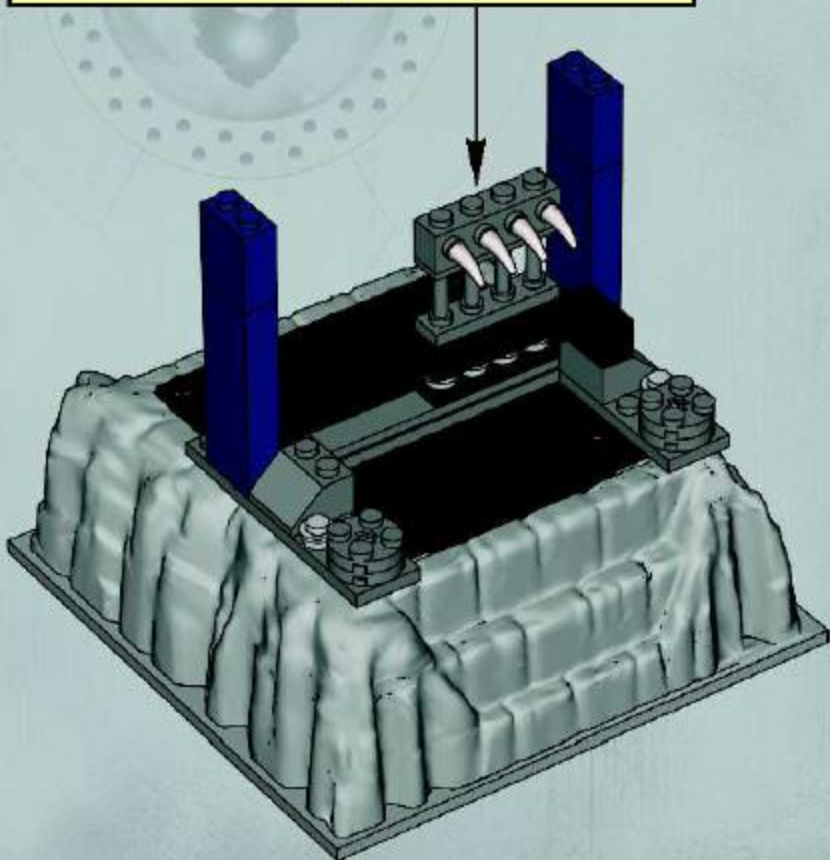
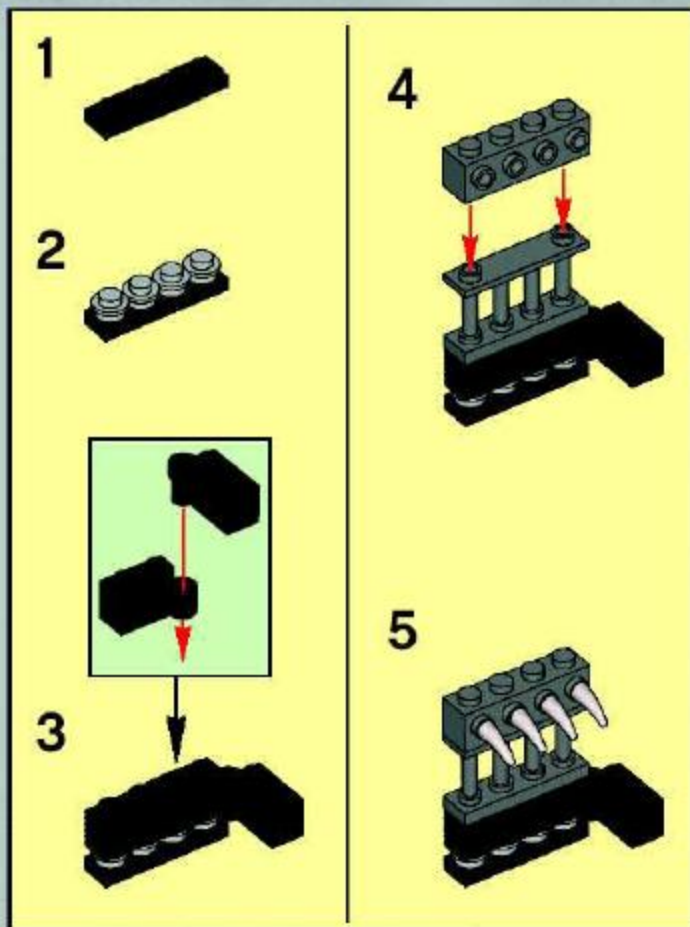

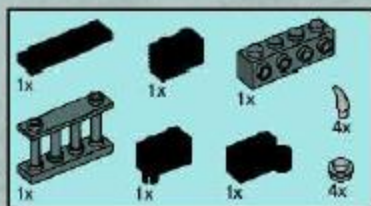

7

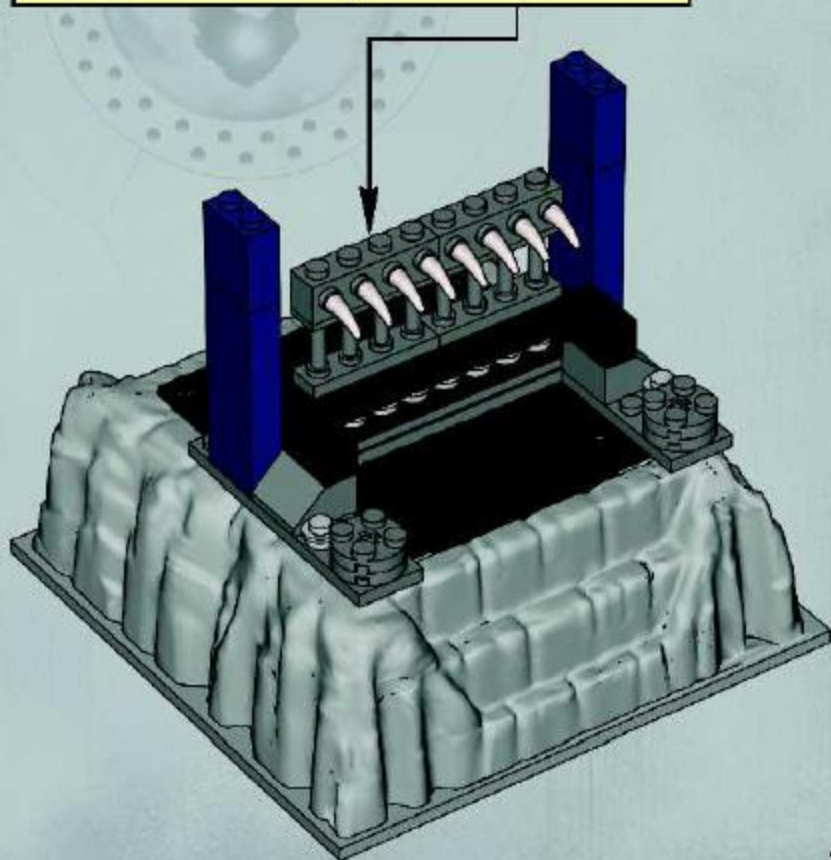
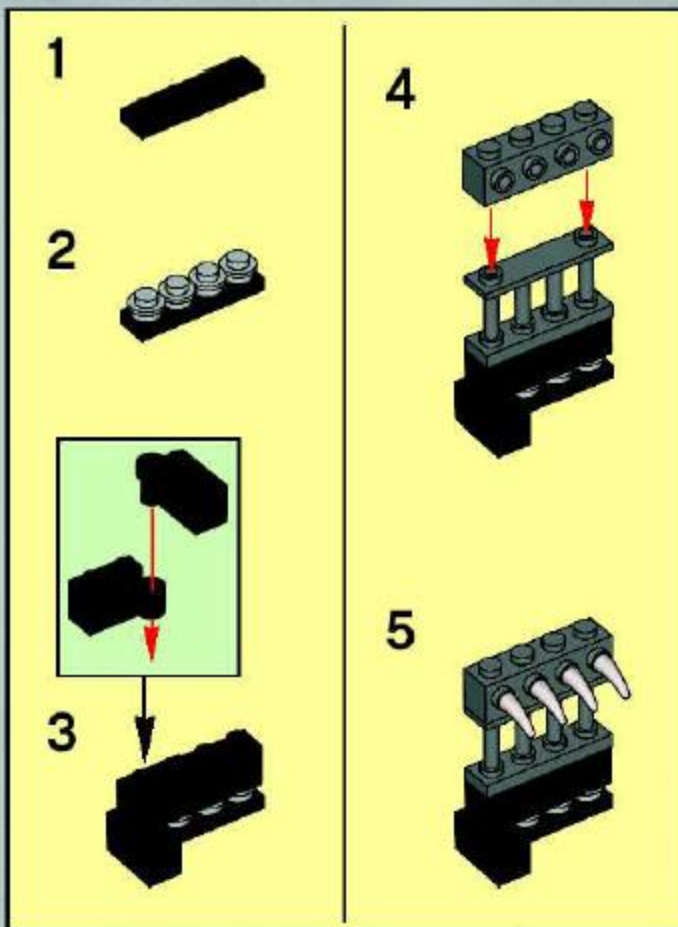



8

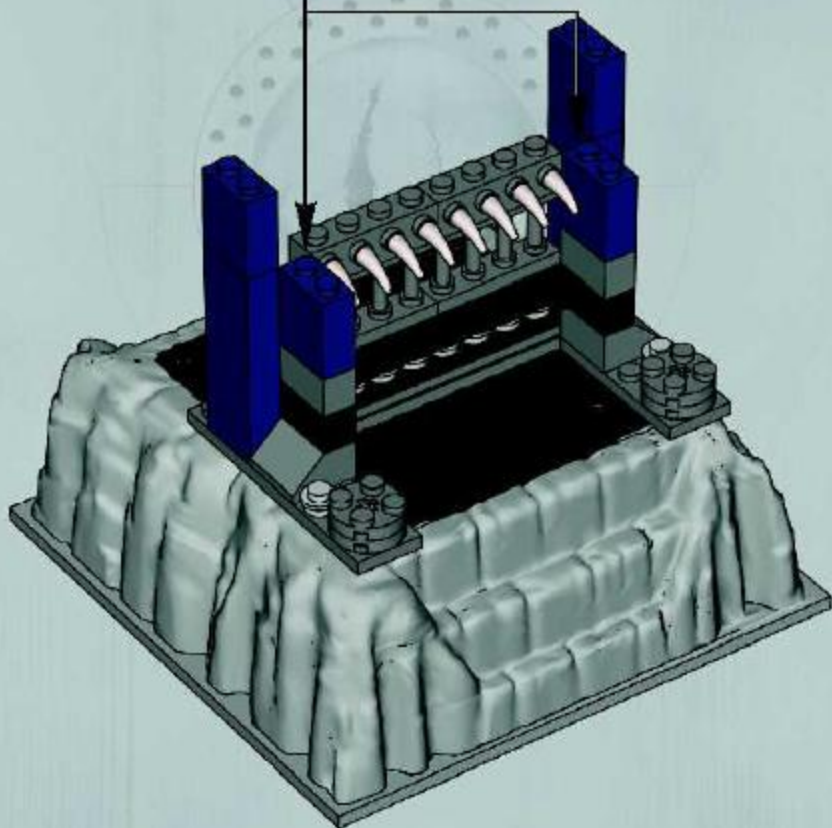
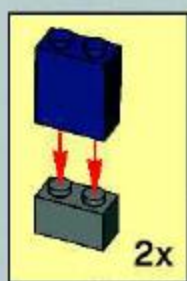



9

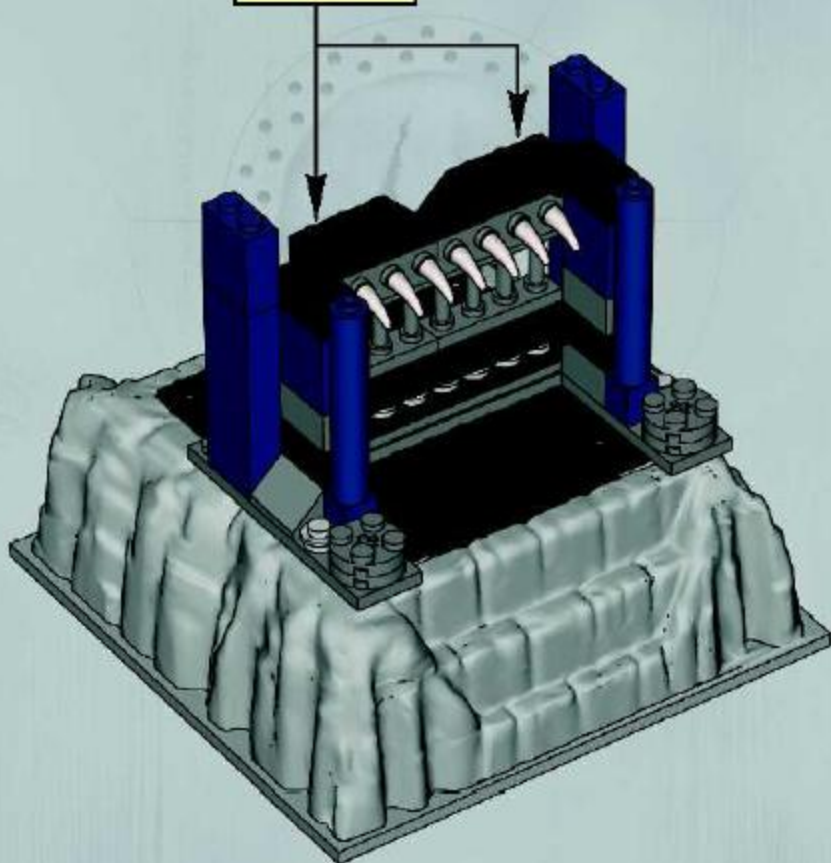
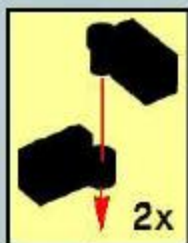



10

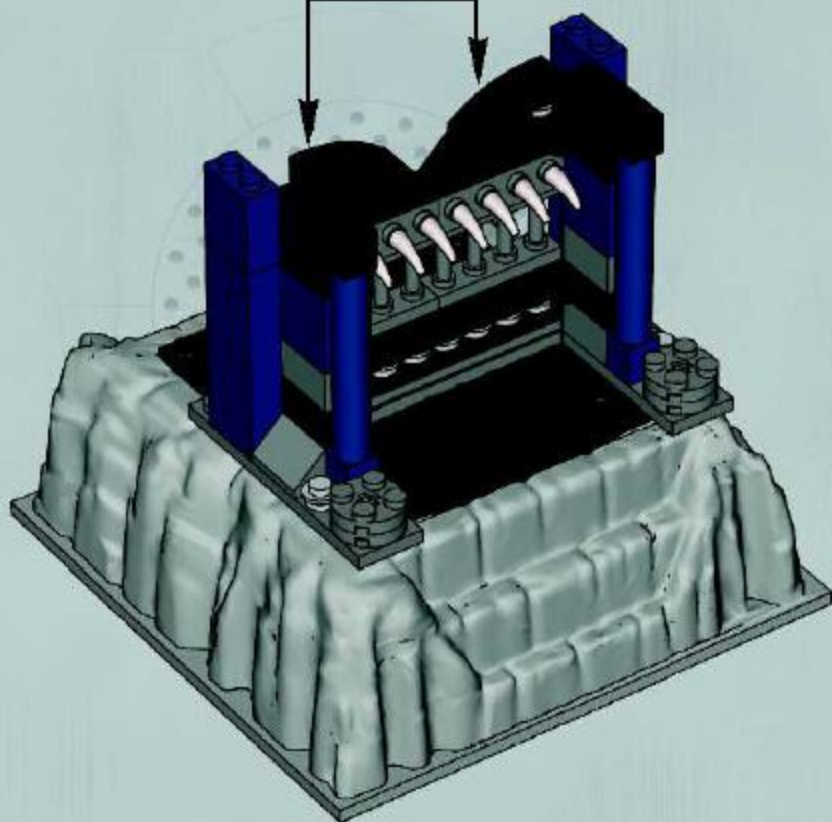

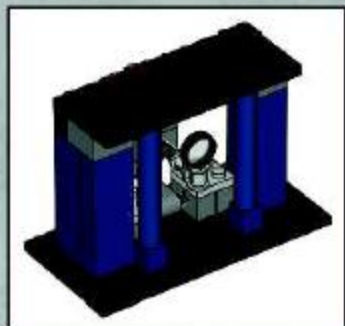

1

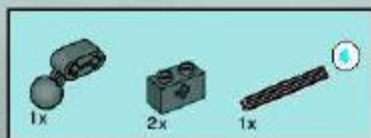
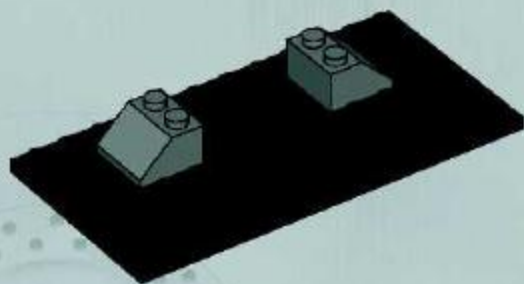

2

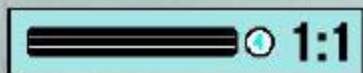
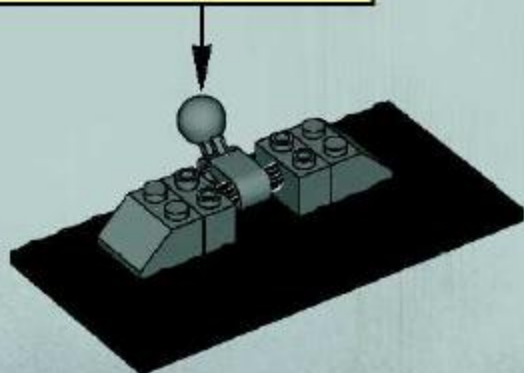
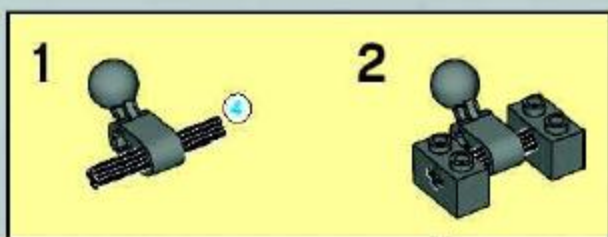

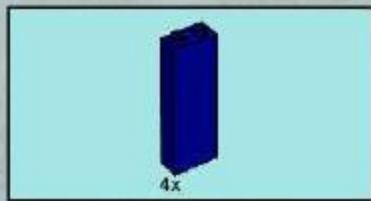

5

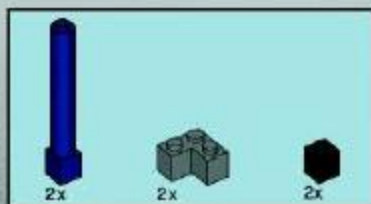
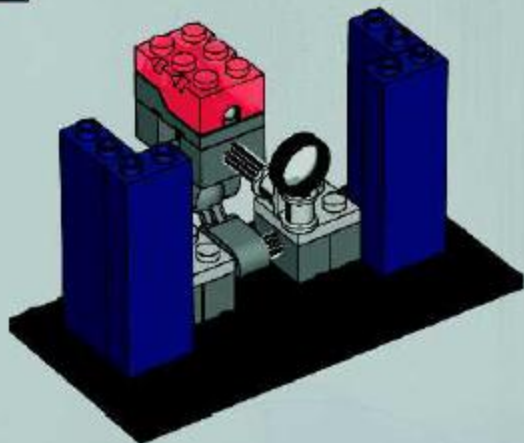

6

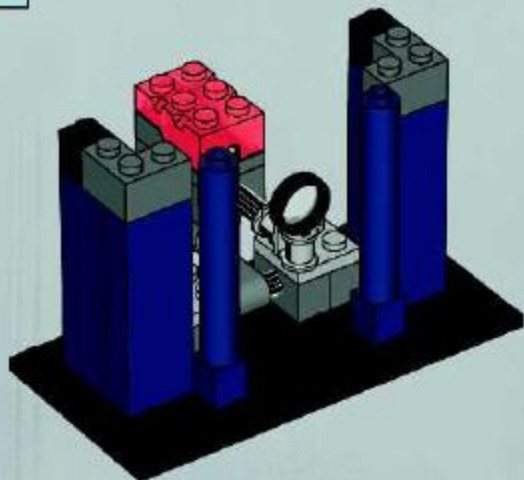



7

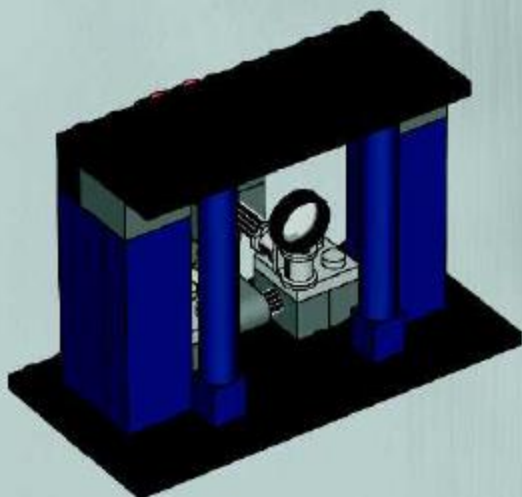

11



6

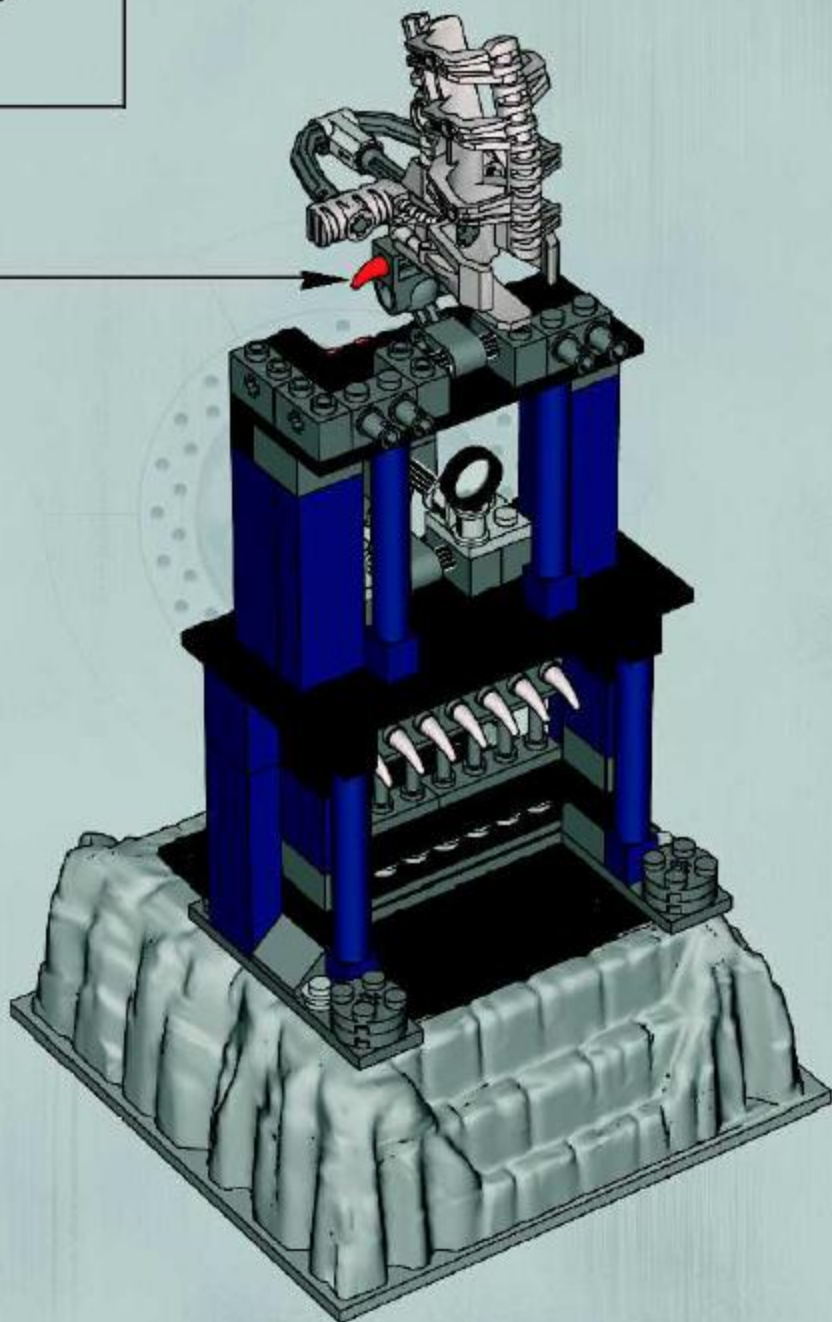
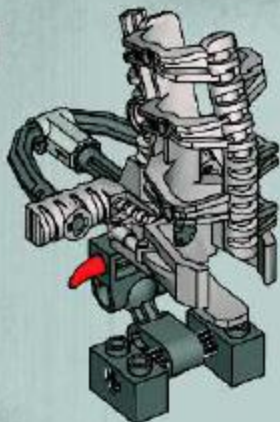

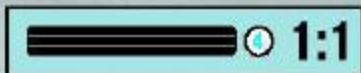

14

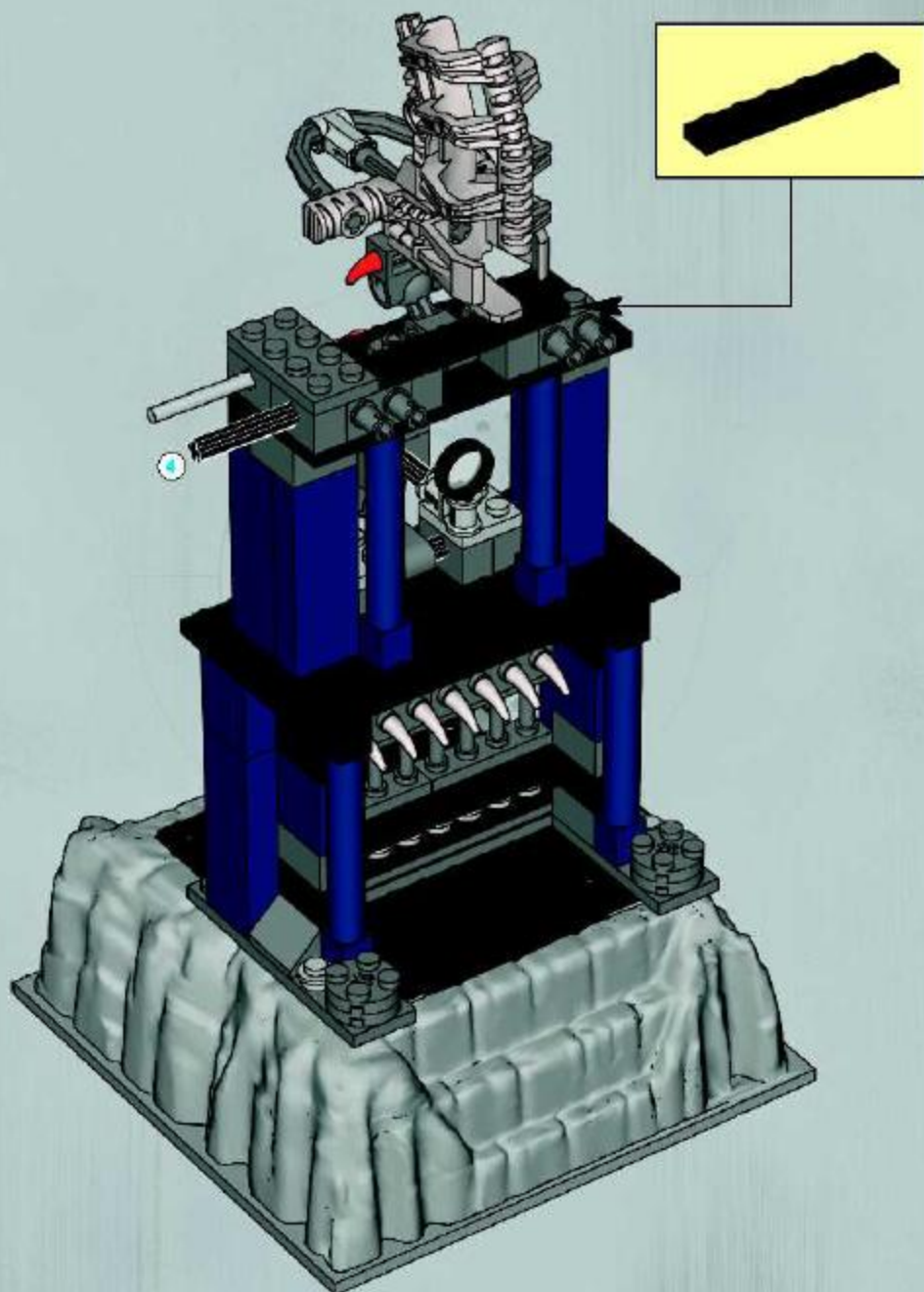

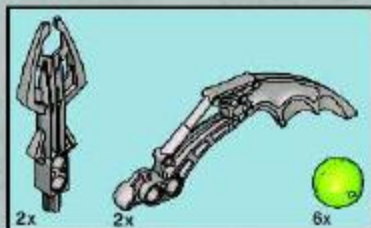

CAUTION: No sharp edges or tips.
ATTENTION: No pointes ou bords tranchants.
PRECAUCIÓN: No lo alfe en las esquinas.

15



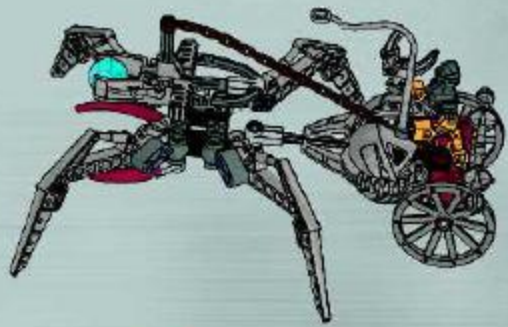
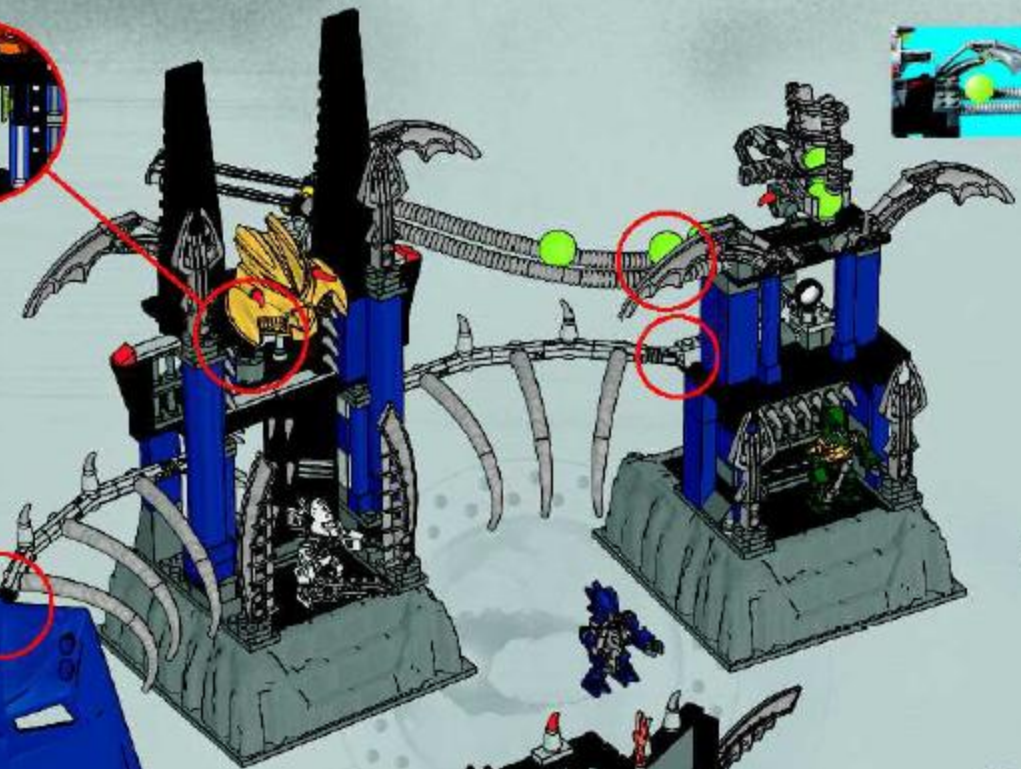

- 3x 4140801
- 2x 4277932
- 8x 407026
- 1x 4159103
- 4x 4294336
- 10x 300526
- 16x 300426
- 4x 4118624
- 3x 352226
- 1x 4294550
- 2x 4261161
- 2x 4107001
- 9x 4121715
- 2x 655826
- 6x 4173658
- 1x 4143875
- 8x 386126
- 8x 389026
- 2x 3417026
- 1x 4119326
- 2x 434926
- 2x 4204143
- 1x 4296954
- 1x 4268922
- 4x 601826
- 5x 302326
- 2x 267726
- 2x 4121066
- 2x 244926
- 1x 4142682
- 2x 244426
- 1x 4221774
- 1x 4288938
- 2x 4166414
- 2x 4166497
- 2x 4166410

- 3x 370526 **4**
- 2x 370526 **5**
- 2x 370526 **6**
- 1x 370726 **10**
- 1x 370726 **12**
- 2x 370826
- 1x 4142135
- 2x 4142823
- 1x 4114128
- 4x 371026
- 3x 366626
- 2x 346026
- 1x 363226
- 3x 333026
- 1x 4243010
- 2x 303326
- 3x 302626
- 2x 4200480

- 4x 4176653
- 2x 4276514
- 2x 4275510
- 4x 4252703
- 4x 4252625
- 1x 4276534
- 2x 4494485
- 1x 4494064
- 4x 4222133
- 6x 4494074
- 6x 4494490
- 1x 4494493
- 2x 4494069
- 6x 4493859

- 36x 4494066
- 1x 4494500
- 1x 4288824
- 2x 4495107
- 2x 4297059
- 1x 4294000

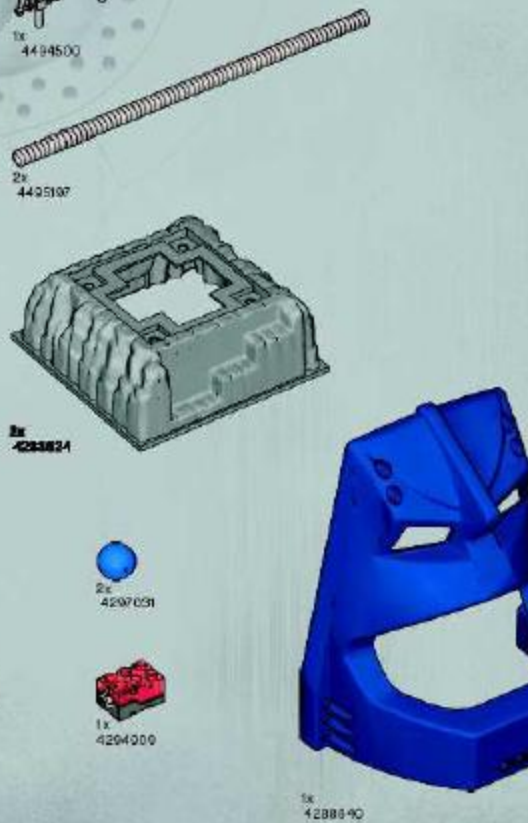



1x 4208210
 1x 4204147
 1x 4206050
 4x 4206347
 2x 4204541
 6x 4274538
 12x 4274535
 2x 4206785
 6x 4206122
 2x 4206119
 6x 4211088
 4x 4210697
 3x 4210695
 2x 4217820
 2x 4210632

2x 4211105
 4x 4211100
 1x 4249139
 7x 4209258
 6x 4210095
 6x 4206495
 1x 4211086
 3x 4203024
 2x 4217826
 12x 4211042
 2x 4211043
 4x 4211065
 2x 4210940
 4x 4211064
 1x 4210660
 2x 4211000
 2x 4210666
 2x 4210666
 2x 4209542
 14x 4210905

2x 4210725
 2x 4211118
 2x 4210068
 3x 4202000
 2x 4210998
 5x 4210997
 2x 4211007
 17x 4142885
 7x 4270053
 2x 4244371
 3x 4204100
 1x 4279763
 1x 4211898
 1x 4211293
 1x 4211466
 2x 4211793
 4x 4211549

2x 4211573
 7x 4211550
 4x 4211552
 6x 4211507
 3x 4211078
 1x 4211022
 7x 4211503
 3x 4211807
 6x 4211483
 3x 4211815
 1x 4211834
 1x 4211021
 2x 4211350
 11x 4211499
 2x 4234535
 1x 4211525
 2x 4249560
 2x 4211440
 2x 4211473
 6x 4211573
 1x 4211626
 1x 4211451

5x 4211397
 6x 4237064
 1x 4203493
 2x 4206948
 1x 4206944
 1x 4208928
 2x 4206946
 1x 4206943
 4x 4204995
 2x 4204542
 1x 4206952
 1x 4208925
 1x 4204148
 1x 4204149
 1x 4206953
 2x 4208815
 1x 4204544
 1x 4224620

4x 4204141
 1x 4208923
 2x 812647
 2x 4204003
 1x 4204537
 1x 4208955
 1x 4204150
 1x 4206109
 1x 4208915
 4x 4209600
 2x 4206788
 1x 4204145
 4x 4208811
 2x 4204538
 6x 4207137
 2x 3106349
 6x 4200080
 15x 4200482

VOYA NUI



8892 PIRAKA OUTPOST



8893 LAVA CHAMBER GATE



8894 PIRAKA STRONGHOLD

GB

Important information about batteries
Never use different types of batteries together or a combination of old and new batteries. Always remove the batteries if the product is not to be used for a long time or if the batteries have run down. Never use damaged batteries. Only use batteries of the same recommended, or a recommended type, with the battery as that the poles are correctly positioned. Rechargeable batteries must be recharged using the correct battery charger under the supervision of an adult. No other recharging batteries while they are still in the product and you must never try to do so. Never attempt to recharge any re-chargeable batteries. Never short-circuit the battery leads.

FI

Tähtäviestit paristojen käytöstä
Älä laittaa kättyä vanhoja paristoja uuteen. Älä yhdistä vanhoja paristoja uuteen vanhojen ja uusien paristojen kanssa. Poista paristot tuotteen ulkopuolelta, jos et aio käyttää niitä. Käytä vain suositeltuja paristoja. Älä käytä vaurioituneita paristoja. Älä käytä vanhoja paristoja uuden kanssa. Käytä vain suositeltuja paristoja. Käytä vain saman suositellun tyyppin paristoja. Älä yhdistä vanhoja paristoja uuden kanssa. Käytä vain suositeltuja paristoja. Älä yritä lataa latauslaitteella paristoja, jotka ovat vielä tuotteen sisällä. Älä yritä lataa latauslaitteella paristoja, jotka eivät ole suositeltuja paristoja. Älä yritä lataa latauslaitteella paristoja, jotka eivät ole suositeltuja paristoja. Älä yritä lataa latauslaitteella paristoja, jotka eivät ole suositeltuja paristoja.

PL

Ważne informacje dotyczące baterii
Nigdy nie łączył różnych rodzajów baterii lub nigdy nie łączył starej baterii z nową. Zawsze usuwaj baterie, jeśli produkt nie ma być używany przez dłuższy czas lub jeśli baterie są wyczerpane. Nigdy nie używaj uszkodzonych baterii. Tylko używaj baterii tego samego zalecanego typu, który jest zgodny z tym, jak są umieszczone w urządzeniu. Ładowalne baterie należy ładować wyłącznie za pomocą ładowarki, którą należy używać pod nadzorem osoby dorosłej. Nie należy ładować baterii, które znajdują się w urządzeniu i nie należy nigdy próbować to zrobić. Nigdy nie należy próbować ładować baterii ładowarką. Nigdy nie należy próbować ładować baterii ładowarką. Nigdy nie należy próbować ładować baterii ładowarką.

SI

Pomembni informaciji o baterijskih celicah
Nikoli ne uporabljajte različne vrste baterijskih celic ali nikoli ne uporabljajte stare in nove baterije skupaj. Vedno odstranite baterije, če se proizvod ne bo uporabljal za daljši čas ali če baterije niso več uporabne. Nikoli ne uporabljajte poškodovanih baterijskih celic. Uporabljajte le baterijske celice iste ali priporočene vrste, ki so skladne s tem, kako so baterijske celice nameštene v napravo. Napolnilne baterijske celice napolnite le s polnilnikom, ki ga uporabljate pod nadzorstvom odrasle osebe. Ne poskušajte napolniti baterijskih celic, ki so v napravi, in ne poskušajte napolniti baterijskih celic, ki niso priporočene. Nikoli ne poskušajte napolniti baterijskih celic s polnilnikom. Nikoli ne poskušajte napolniti baterijskih celic s polnilnikom. Nikoli ne poskušajte napolniti baterijskih celic s polnilnikom.

DE

Wichtige Informationen zu Batterien
Niemals die verschiedenen Arten von Batterien zusammen verwenden. Entfernen Sie alle die Batterien heraus, wenn sich das Produkt längere Zeit nicht genutzt wird oder wenn die Batterien leer sind. Verwenden Sie immer hochwertige Batterien. Verwenden Sie ausschließlich empfohlene oder geeignete Batterien. Achten Sie beim Einsetzen der Batterien auf die richtige Polung. Verwenden niemals defekte oder mit einem Schaden behaftete Batterien. Verwenden Sie nie alte Batterien zusammen mit neuen. Verwenden Sie nur die empfohlenen Batterien. Verwenden Sie nie alte Batterien zusammen mit neuen. Verwenden Sie nur die empfohlenen Batterien. Verwenden Sie nie alte Batterien zusammen mit neuen. Verwenden Sie nur die empfohlenen Batterien.

SE

Viktig information om batterier
Använd aldrig olika typer av batterier samtidigt och bra heller en gammal och en ny batterier. Ta alltid ur batterierna om produkten inte ska användas under en längre tid. Använd alltid kvalitetsbatterier. Använd bara batterier av den typ som rekommenderas eller av en rekommenderad typ. Laddningsbara batterier ska laddas med batteriladdare. Använd alltid batteriladdare som rekommenderas av tillverkaren. Använd aldrig olika typer av laddningsbara batterier samtidigt och använd aldrig gamla och nya laddningsbara batterier samtidigt. Använd aldrig olika typer av laddningsbara batterier samtidigt och använd aldrig gamla och nya laddningsbara batterier samtidigt.

CZ

Důležité informace o bateriích
Nikdy nepřemísťavajte rôznych druhov typov batérií alebo kombinácie starých a nových batérií. Nikdy nie spájajte staré batérie so novými. Batérie nikdy nepoužívajte, ak sú poškodené alebo ak nie sú vhodné pre daný výrobok. Nikdy nepoužívajte poškodené batérie. Používajte iba batérie rovnakej alebo odporúčanej typy batérií. Batérie nikdy nepoužívajte so starými batერიами. Používajte iba batérie rovnakej alebo odporúčanej typy batérií. Batérie nikdy nepoužívajte so starými batერიами. Používajte iba batérie rovnakej alebo odporúčanej typy batérií.

RO

Informații importante cu privire la baterii
Nu combinați diferite tipuri de baterii în același dispozitiv. Nu combinați baterii noi și vechi. Înlocuiți bateriile doar dacă produsul nu este folosit timp îndelungat sau dacă bateriile sunt epuizate. Nu folosiți baterii defecte sau deteriorate. Folosiți numai baterii de tipul recomandat, sau de un tip echivalent. Încălziți bateriile astfel ca pot să fie în contact corect. Bateriile reîncărcabile trebuie reîncărcate utilizând un dispozitiv de încălzire adecvat și recomandabil pentru acest tip de baterii. Nu încercați să încălziți o baterie încărcată în produs. Nu încercați să încălziți o baterie încărcată în produs. Nu încercați să încălziți o baterie încărcată în produs.

FR

Informations importantes concernant les piles
Ne jamais utiliser un mélange de différents types de piles, ni de piles neuves et de piles anciennes ou de piles neuves, toujours utiliser les piles et le produit et/ou son emballage devant une pile usagée. Ne jamais utiliser des piles défectueuses. Utiliser uniquement les piles de type recommandé ou d'un type équivalent. En contact les piles, respecter les polarités. Ne jamais recharger les piles d'un produit avec un chargeur différent de celui recommandé par le fabricant. Ne jamais recharger les piles d'un produit avec un chargeur différent de celui recommandé par le fabricant. Ne jamais recharger les piles d'un produit avec un chargeur différent de celui recommandé par le fabricant.

PT

Informações importantes sobre baterias
Nunca use tipos diferentes de pilhas ou combinações de pilhas novas e antigas ou pilhas antigas e novas. Nunca use pilhas danificadas ou que não sejam adequadas para o produto. Nunca use pilhas danificadas ou que não sejam adequadas para o produto. Nunca use pilhas danificadas ou que não sejam adequadas para o produto. Nunca use pilhas danificadas ou que não sejam adequadas para o produto. Nunca use pilhas danificadas ou que não sejam adequadas para o produto.

SK

Dôležité informácie o batériách
Nikdy nezmiešavajte rôzne typy batérií ani kombinácie nových batérií a starých. Batérie nikdy nepoužívajte, ak sú poškodené alebo ak nie sú vhodné pre daný výrobok. Nikdy nepoužívajte poškodené batérie. Používajte iba batérie rovnakej alebo odporúčanej typy batérií. Batérie nikdy nepoužívajte so starými batერიами. Používajte iba batérie rovnakej alebo odporúčanej typy batérií. Batérie nikdy nepoužívajte so starými batერიами. Používajte iba batérie rovnakej alebo odporúčanej typy batérií.

BG

Важни информации за батерии
Никой не смесвайте различни типове батерии или комбинации от нови батерии и стари батерии. Никой не използвайте повредени батерии или батерии, които не са подходящи за продукта. Никой не използвайте повредени батерии. Използвайте само батерии от същия или от съвместим тип. Батериите никога не използвайте с остарели батерии. Използвайте само батерии от същия или от съвместим тип. Батериите никога не използвайте с остарели батерии. Използвайте само батерии от същия или от съвместим тип.

IT

Importanti informazioni sulle batterie
Non usare mai combinazioni diverse di tipi diversi di batterie nuove e vecchie. Non usare mai batterie danneggiate o che non siano adatte al prodotto. Non usare mai batterie danneggiate o che non siano adatte al prodotto. Non usare mai batterie danneggiate o che non siano adatte al prodotto. Non usare mai batterie danneggiate o che non siano adatte al prodotto. Non usare mai batterie danneggiate o che non siano adatte al prodotto.

GR

Σημαντικές πληροφορίες για τις μπαταρίες
Μην χρησιμοποιείτε ποτέ διαφορετικούς τύπους μπαταριών ή ποτέ νέες μπαταρίες με παλιές. Μην χρησιμοποιείτε κατεστραμμένες μπαταρίες ή μπαταρίες που δεν είναι κατάλληλες για το προϊόν. Μην χρησιμοποιείτε κατεστραμμένες μπαταρίες. Χρησιμοποιείτε μόνο μπαταρίες του ίδιου ή του συμβατού τύπου. Μην χρησιμοποιείτε ποτέ παλιές μπαταρίες μαζί με νέες μπαταρίες. Χρησιμοποιείτε μόνο μπαταρίες του ίδιου ή του συμβατού τύπου. Μην χρησιμοποιείτε ποτέ παλιές μπαταρίες μαζί με νέες μπαταρίες. Χρησιμοποιείτε μόνο μπαταρίες του ίδιου ή του συμβατού τύπου.

HU

Főleg fontos információk az elemekről
Soha ne használjon különböző típusú elemeket, illetve ne kombinálja az új elemeket a régi elemekkel. Mindig használjon csak az eredeti, vagy a készletben előírt típusú elemeket. Ne használjon sérült elemeket. Csak az ajánlott típusú elemeket használja. Ne használjon soha nem ajánlott típusú elemeket. Csak az ajánlott típusú elemeket használja. Ne használjon soha nem ajánlott típusú elemeket. Csak az ajánlott típusú elemeket használja.

LV

Svarīgā informācija par lietotāja drošību
Nāvēdīgā informācija šūnām (MMS) ir tā, kas ir jāzina
un kas ir jānodrošina lietotājam. Šādas svarīgās
informācijas saturam, ja to izsūtīsiet uz
daudzām lietotājiem, jābūt tādas pašas.
Nāvēdīgā informācija ir tā, kas ir jāzina
lietotājam, kas izsūtīsiet šādu informāciju.
Lietotājam jāzina, ka šāda informācija ir jāzina
lietotājam, kas izsūtīsiet šādu informāciju.
Lietotājam jāzina, ka šāda informācija ir jāzina
lietotājam, kas izsūtīsiet šādu informāciju.

CN

Información importante
La información importante es aquella que el usuario
debe conocer para poder utilizar el dispositivo de forma
correcta y segura. Esta información debe ser enviada
a todos los usuarios que se van a utilizar el dispositivo.
La información importante es aquella que el usuario
debe conocer para poder utilizar el dispositivo de forma
correcta y segura. Esta información debe ser enviada
a todos los usuarios que se van a utilizar el dispositivo.

Información importante
La información importante es aquella que el usuario
debe conocer para poder utilizar el dispositivo de forma
correcta y segura. Esta información debe ser enviada
a todos los usuarios que se van a utilizar el dispositivo.
La información importante es aquella que el usuario
debe conocer para poder utilizar el dispositivo de forma
correcta y segura. Esta información debe ser enviada
a todos los usuarios que se van a utilizar el dispositivo.

ES

Información importante sobre las baterías
No mezclar nunca diferentes tipos de baterías. Utilizar
baterías antiguas y nuevas a la vez puede dañar las
baterías, el producto o su calidad por un largo
período de tiempo o el las baterías puede dañarlas.
No utilizar nunca baterías dañadas. Utilizar solo el tipo
de batería recomendada o que se especifique.
Cualquier tipo de batería de reserva que se haya usado
en su momento correcto. Las baterías recargables deben
cargarse con un cargador adecuado hasta el nivel
de un 100%. Las baterías de reserva, si deben recargarse
deben cargarse con el producto. No intentar nunca
recargar baterías no recargables. Aunque sean que se
puedan o se intenten no se debe cargar.

LT

Informacija svariai informacijai
Svaria informacija yra ta, kurią vartotojas turi
žinoti, kad galėtų naudoti prietaisą teisingai ir
saugiai. Ši informacija turi būti siunčiama visiems
vartotojams, kurie naudoja prietaisą. Svaria informacija
yra ta, kurią vartotojas turi žinoti, kad galėtų
naudoti prietaisą teisingai ir saugiai. Ši informacija
turi būti siunčiama visiems vartotojams, kurie
naudoja prietaisą. Svaria informacija yra ta, kurią
vartotojas turi žinoti, kad galėtų naudoti prietaisą
teisingai ir saugiai. Ši informacija turi būti
siunčiama visiems vartotojams, kurie naudoja
prietaisą.

SR

Informacija važnioms informacijoms
Informacija važnioms informacijoms yra ta, kurią
vartotojas turi žinoti, kad galėtų naudoti prietaisą
teisingai ir saugiai. Ši informacija turi būti
siunčiama visiems vartotojams, kurie naudoja
prietaisą. Informacija važnioms informacijoms
yra ta, kurią vartotojas turi žinoti, kad galėtų
naudoti prietaisą teisingai ir saugiai. Ši informacija
turi būti siunčiama visiems vartotojams, kurie
naudoja prietaisą. Informacija važnioms
informacijoms yra ta, kurią vartotojas turi žinoti,
kad galėtų naudoti prietaisą teisingai ir saugiai.
Ši informacija turi būti siunčiama visiems
vartotojams, kurie naudoja prietaisą.

NL

Belangrijke informatie over apparaten
Belangrijke informatie over apparaten is informatie
die u moet weten om de apparaten te gebruiken en
om te voorkomen dat u schade aan de apparaten
aanbrengt. Deze informatie moet worden verzonden
naar alle gebruikers van de apparaten. Belangrijke
informatie is informatie die u moet weten om de
apparaten te gebruiken en om te voorkomen dat u
schade aan de apparaten aanbrengt. Deze informatie
moet worden verzonden naar alle gebruikers van de
apparaten. Belangrijke informatie is informatie die
u moet weten om de apparaten te gebruiken en om
te voorkomen dat u schade aan de apparaten
aanbrengt. Deze informatie moet worden verzonden
naar alle gebruikers van de apparaten.

UA

Важна інформація про пристрої
Важна інформація про пристрої – це інформація,
яку потрібно знати, щоб використовувати пристрої
правильно та безпечно. Ця інформація повинна
бути надіслана всім користувачам пристроїв.
Важна інформація – це інформація, яку потрібно
знати, щоб використовувати пристрої правильно
та безпечно. Ця інформація повинна бути
надіслана всім користувачам пристроїв. Важна
інформація – це інформація, яку потрібно знати,
щоб використовувати пристрої правильно та
безпечно. Ця інформація повинна бути надіслана
всім користувачам пристроїв. Важна інформація
– це інформація, яку потрібно знати, щоб
використовувати пристрої правильно та безпечно.
Ця інформація повинна бути надіслана всім
користувачам пристроїв.

KR

중요 정보에 대한 정보
중요 정보에 대한 정보는 기기를 올바르게 사용하고
안전하게 사용하기 위해 알아야 하는 정보입니다.
이 정보는 모든 기기 사용자에게 제공되어야
합니다. 중요 정보에 대한 정보는 기기를
올바르게 사용하고 안전하게 사용하기 위해
알아야 하는 정보입니다. 이 정보는 모든 기기
사용자에게 제공되어야 합니다. 중요 정보에
대한 정보는 기기를 올바르게 사용하고
안전하게 사용하기 위해 알아야 하는 정보입니다.
이 정보는 모든 기기 사용자에게 제공되어야
합니다.

DK

Vigt information om apparater
Vigt information om apparater er information, som
du skal vide for at bruge apparaterne korrekt og
sikkert. Denne information skal sendes til alle
brugere af apparaterne. Vigt information om
apparater er information, som du skal vide for
at bruge apparaterne korrekt og sikkert. Denne
information skal sendes til alle brugere af
apparaterne. Vigt information om apparater er
information, som du skal vide for at bruge
apparaterne korrekt og sikkert. Denne information
skal sendes til alle brugere af apparaterne.

TR

Önemli cihazlarla ilgili bilgiler
Önemli cihazlarla ilgili bilgiler, cihazları doğru
ve güvenli şekilde kullanmak için bilmeniz
gerekli olan bilgilerdir. Bu bilgiler tüm cihaz
kullanıcılarına gönderilmelidir. Önemli cihazlarla
ilgili bilgiler, cihazları doğru ve güvenli şekilde
kullanmak için bilmeniz gerekli olan bilgilerdir.
Bu bilgiler tüm cihaz kullanıcılarına
gönderilmelidir. Önemli cihazlarla ilgili bilgiler,
cihazları doğru ve güvenli şekilde kullanmak
için bilmeniz gerekli olan bilgilerdir. Bu
bilgiler tüm cihaz kullanıcılarına
gönderilmelidir. Önemli cihazlarla ilgili bilgiler,
cihazları doğru ve güvenli şekilde kullanmak
için bilmeniz gerekli olan bilgilerdir. Bu
bilgiler tüm cihaz kullanıcılarına
gönderilmelidir.

JP

重要な情報について
重要な情報とは、機器を正しく安全に使用する
ために必要な情報です。この情報は、すべての
機器利用者に対して提供する必要があります。
重要な情報とは、機器を正しく安全に使用する
ために必要な情報です。この情報は、すべての
機器利用者に対して提供する必要があります。
重要な情報とは、機器を正しく安全に使用する
ために必要な情報です。この情報は、すべての
機器利用者に対して提供する必要があります。

EE

Oluline seadmete kohta teave
Oluline seadmete kohta teave on teave, mis on
vajalik, et kasutada seadmeid õigesti ja turvaliselt.
See teave tuleb saata kõigile seadmete kasutajatele.
Oluline seadmete kohta teave on teave, mis on
vajalik, et kasutada seadmeid õigesti ja turvaliselt.
See teave tuleb saata kõigile seadmete kasutajatele.
Oluline seadmete kohta teave on teave, mis on
vajalik, et kasutada seadmeid õigesti ja turvaliselt.
See teave tuleb saata kõigile seadmete kasutajatele.

HR

Važna informacija o uređajima
Važna informacija o uređajima je informacija koja
je potrebna za pravilno i sigurno korištenje uređaja.
Ova informacija treba biti poslana svim korisnicima
uređaja. Važna informacija o uređajima je
informacija koja je potrebna za pravilno i sigurno
korištenje uređaja. Ova informacija treba biti
poslana svim korisnicima uređaja. Važna
informacija o uređajima je informacija koja je
potrebna za pravilno i sigurno korištenje uređaja.
Ova informacija treba biti poslana svim
korisnicima uređaja.

RU

Важная информация об устройствах
Важная информация об устройствах – это информация,
которую необходимо знать, чтобы использовать
устройства правильно и безопасно. Эта информация
должна быть отправлена всем пользователям устройств.
Важная информация об устройствах – это информация,
которую необходимо знать, чтобы использовать
устройства правильно и безопасно. Эта информация
должна быть отправлена всем пользователям устройств.
Важная информация об устройствах – это информация,
которую необходимо знать, чтобы использовать
устройства правильно и безопасно. Эта информация
должна быть отправлена всем пользователям устройств.



Win! Gagne! 当たります Gewinne!

Win LEGO products

We would like to know what you think about your new LEGO product. Log on to the web address below for further instructions.

Gagne des produits LEGO

Nous aimerions savoir ce que tu penses de ton nouveau produit LEGO. Tu obtiendras davantage d'informations en visitant le site Internet indique ci-dessous.

Gewinne LEGO produkte

Wir sind sehr an deiner Meinung über dein neues LEGO Produkt interessiert. Gehe einfach zu der unten angegebenen Webadresse – dort findest du weitere Informationen.

Estimado usuario LEGO

Al contestar algunas preguntas en inglés, francés, alemán o japonés, en el sitio www.acnielsen.aim.dk/lego, podrás participar en el sorteo de algunos valiosos premios LEGO.

Caro Consumidor da LEGO

Ao responder a algumas perguntas em Inglês, Francês, Alemão ou Japonês no endereço www.acnielsen.aim.dk/lego irá participar num concurso para ganhar valiosos prémios da LEGO.

Kedves ifjú LEGO Vásárló

Ha ellátogatsz a www.acnielsen.aim.dk/lego honlapra és ott angol, francia, német vagy japán nyelven megválaszolsz néhány kérdést akkor részt veszel egy versenyben, amelyben értékes LEGO díjakat nyerhetsz.

投票でLEGO製品が当たります

私たちは、皆さんが買い求めたLEGO製品についてどんな感想をお持ちか、知りたいと思っています。質問に答えて、楽しいLEGO製品の抽選に必ず参加してください。アンケートの回答には、ほんの少しだけおかけしますが、詳しくは、以下のウェブアドレスまでアクセスしてください。



www.acnielsen.aim.dk/LEGO



Any questions regarding your new LEGO product, please contact:

Customer Service | Kundenservice
Service Consommateurs
Servicio Al Consumidor at
www.lego.com/service or dial

 :

00800 5346 5555

 :

1-800-422-5346



Discover the **LEGO® UNIVERSE!**
 Entdecke das **LEGO® UNIVERSUM!**
 Ontdek het **LEGO® UNIVERSUM!**
 Découvre **L'UNIVERS LEGO®!**

LEGO club

FREE LEGO Magazines
 Des Magazines LEGO GRATUITS !
 GRATIS LEGO Magazine
 KOSTENLOSE LEGO Magazine



B1C26 B1C26 B1D6U B1D6U B1D6F B1D6C B1D6C B1D6C B1D6C B1D6N
 Sign up now! Jetzt anmelden!
 Abonne-toi maintenant! Meld je nu aan!
<http://club.LEGO.com/signup>

LEGO SHOP at HOME



www.LEGOshop.com/catalog



BIONICLE® Heroes
The new official video game
Coming Soon

BIONICLE® Heroes
Das neue offizielle Videospiel
Demnächst erhältlich

BIONICLE® Heroes
Le nouveau jeu vidéo officiel
Prochainement

BIONICLE® Heroes
El nuevo videojuego oficial
Muy pronto

BIONICLE® Heroes
O novo jogo de vídeo oficial
A chegar brevemente

BIONICLE® Heroes
Az új hivatalos videójáték
hamarosan a boltokban



www.lego.com



GAME BOY ADVANCE



NINTENDO DS

PlayStation 2



BIONICLE game software ©TT Games Publishing Ltd 2006. Developed by Traveller's Tales Ltd. Published by LEGO and TT Games under license from the LEGO Group. LEGO, the LEGO logo and BIONICLE are trademarks of the LEGO Group. All rights reserved. "DS" and "PlayStation" are registered trademarks of Sony Computer Entertainment Inc. All rights reserved. Xbox and the Xbox logos are either registered trademarks or trademarks of Microsoft Corporation in the United States and/or other countries and are used under license from Microsoft. All rights reserved. NINTENDO GAMECUBE, THE NINTENDO GAMECUBE LOGO, GAME BOY ADVANCE AND NINTENDO DS ARE TRADEMARKS OF NINTENDO.



WWW.BIONICLE.COM



©2006 The LEGO Group. All rights reserved.