

LEGO

トランスポーズ
EXO-FORCE



DESTRUCTOR

8112-1



1

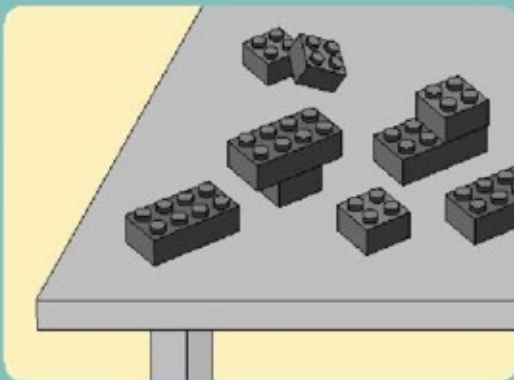

2

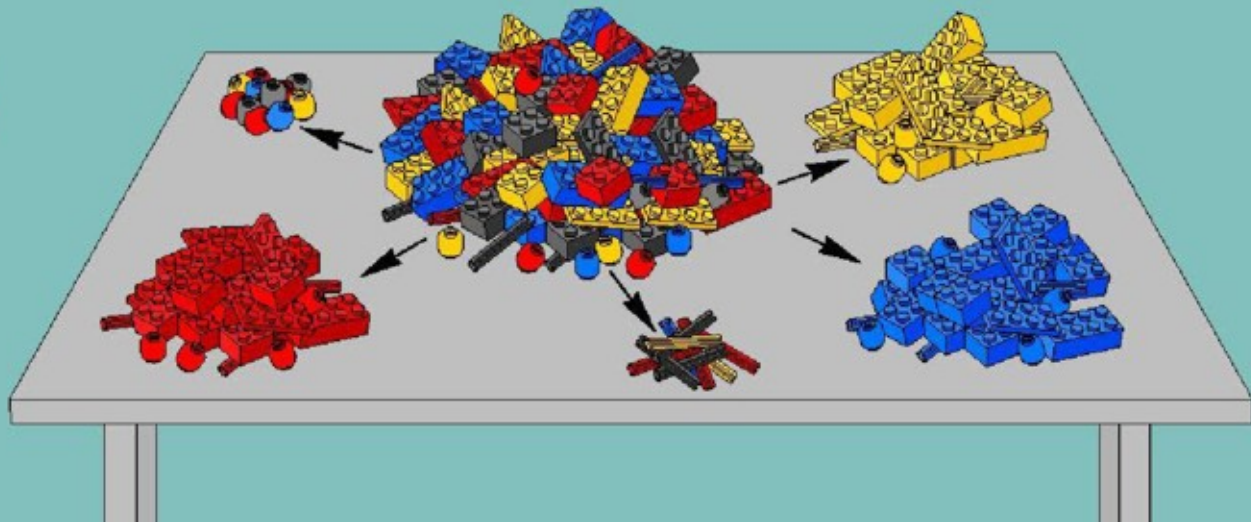

3

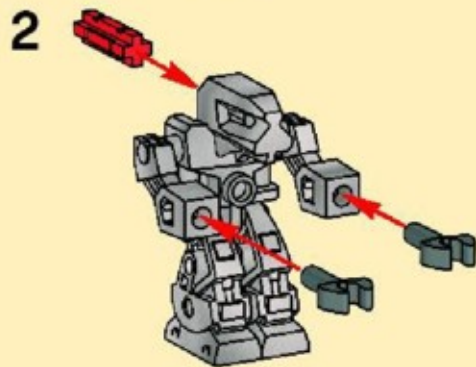
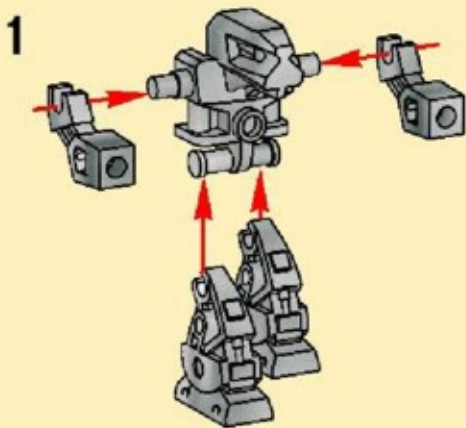



1x

1



2x

2

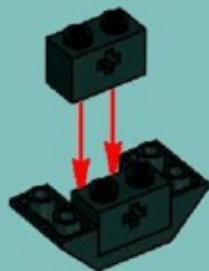



1x



1x

3



2x

4

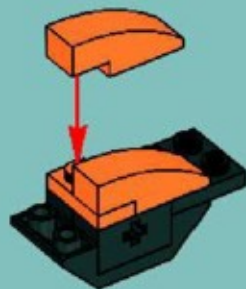



1x



2x

5



1x

6





2x



2x

7

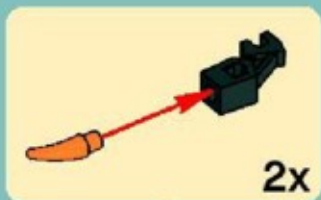

2x

8





1x



1x

9



8



2x



1x



1x

1





1x

2



1x

3





4

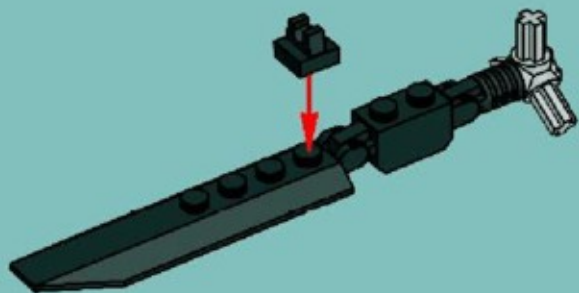

5

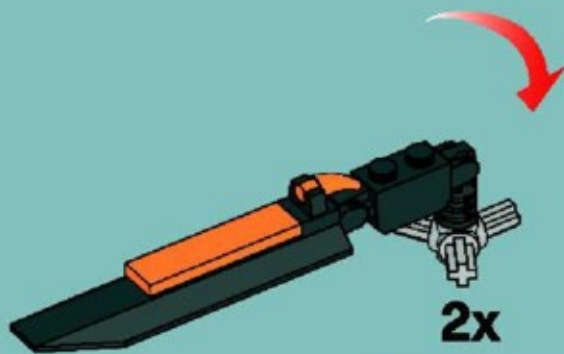

10

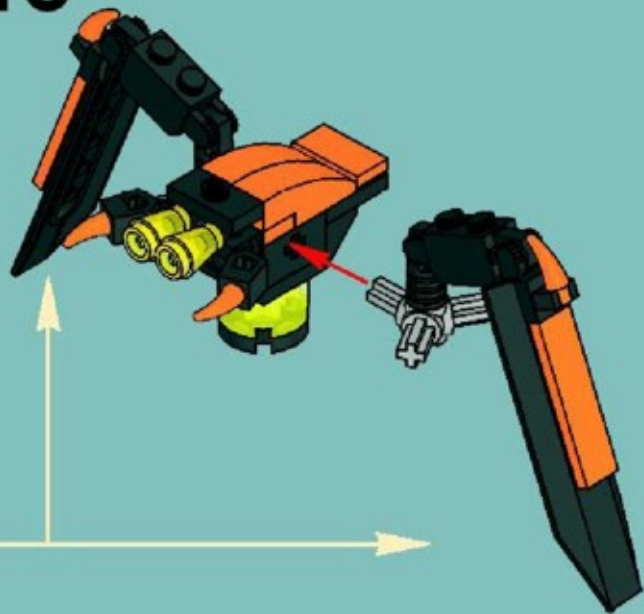

11

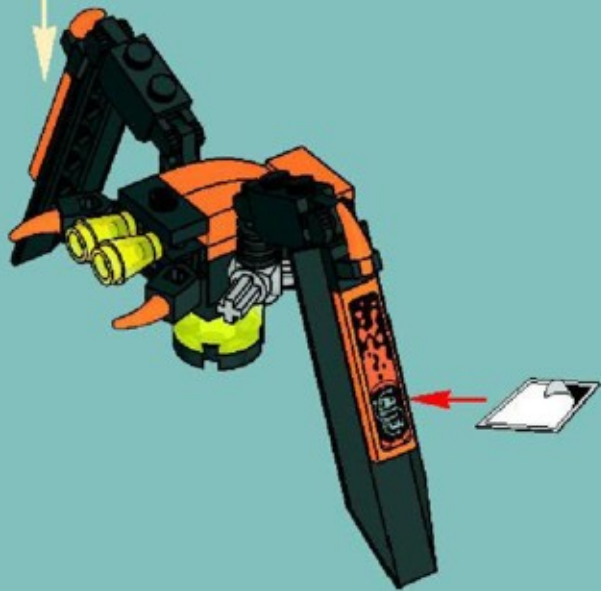



2x



1x



1x

1

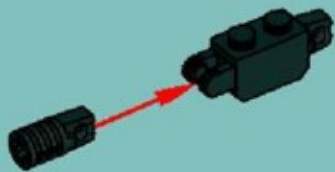

1x



1x

2

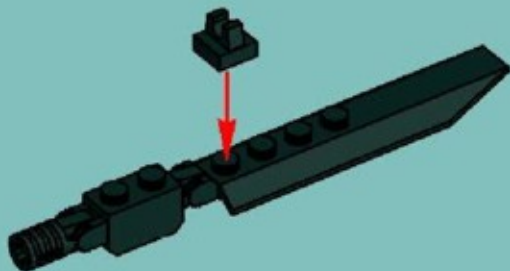



3



12



13

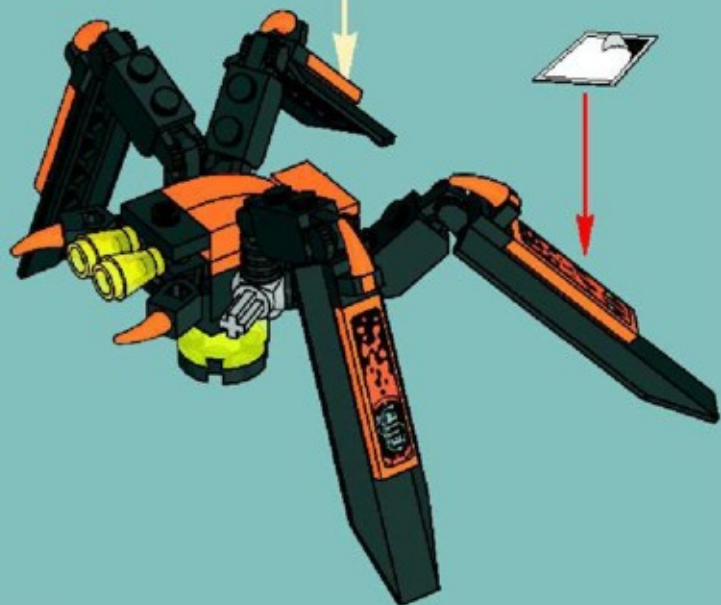

1

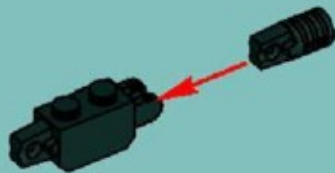



1x

2

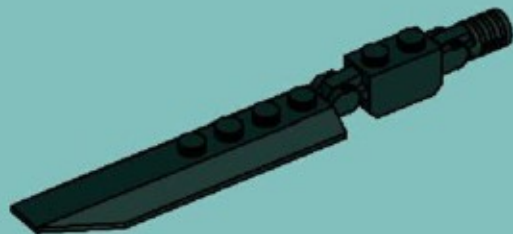

1x



1x



1x



1x

3

1



2





1x



1x

4



1x

5





1x



1x

6



1x



1x

7

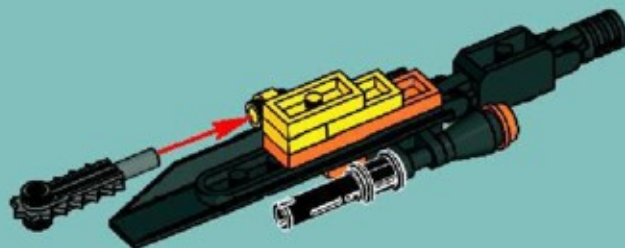

8



14





1

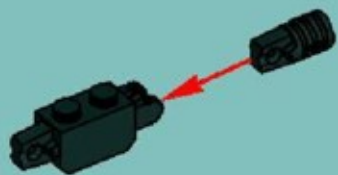

2

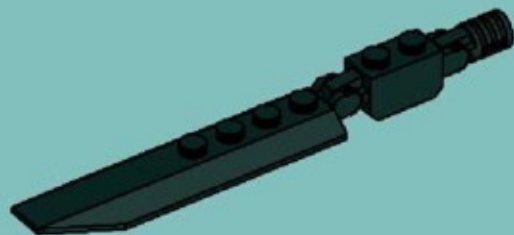



1x



1x



1x



1x

3

1



2





1x



1x

4



1x

5





1x



1x

6



1x



1x

7

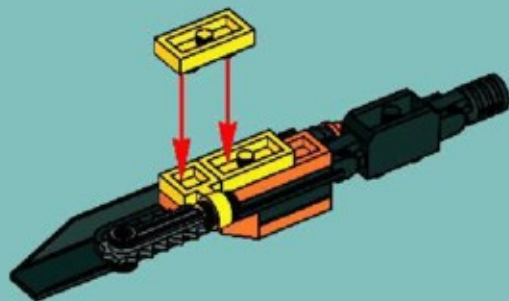

8



15



LEGO

トクショーブタイ
EXO-FORCE



8118



8111



8112



8117



8113



8114



8115



www.LEGO.com

トクシユブタイ

LEGO

EXO-FORCE



8112-2





1x

1



2



1x

2

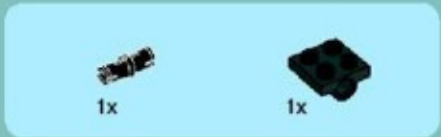

1x

1x

3

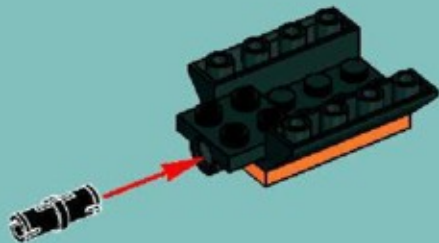



1x

4



2x



1x

5

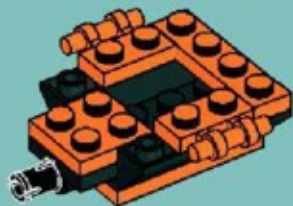



1x



1x

6

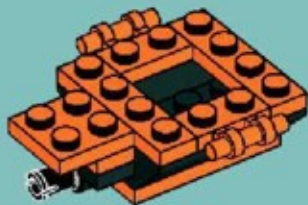

2x



1x



2x

7

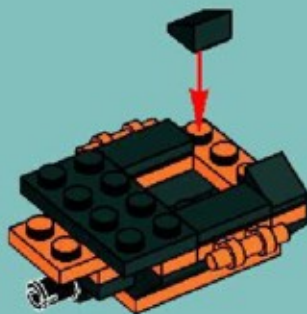



2x



1x



2x

8

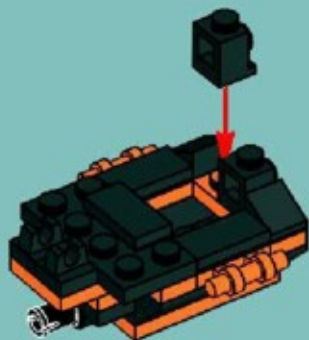

2x

9

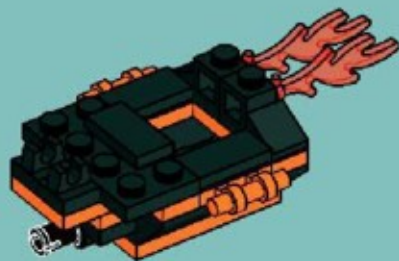



2x



1x

10

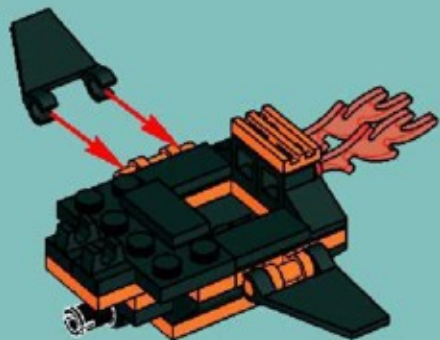

2x

11

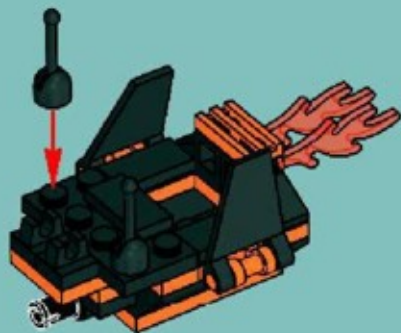



1x



1x

12

1

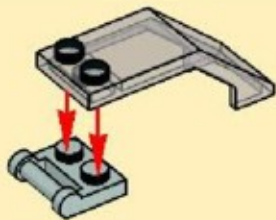

2

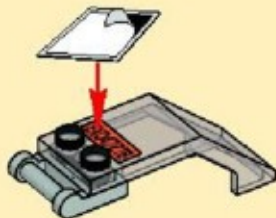

13





1x



2x

14

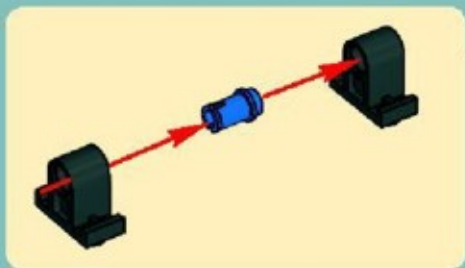



1x



1x

15







1x



1x

1



2x

2





2x

3



4x

4





1x



1x



1x

5

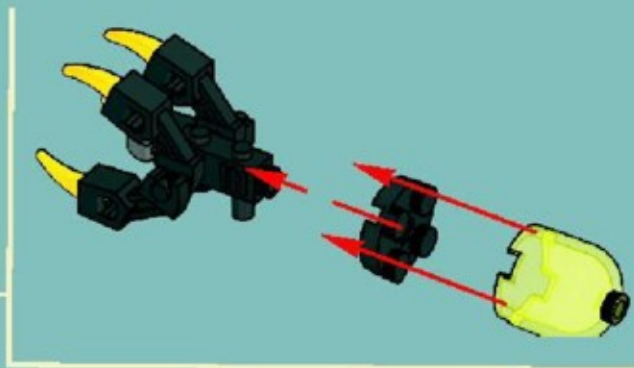





1x
82359



2x
4251969



1x
4188771



4x
4160593



6x
4520926



1x
4177932



2x
4190164



4x
418782



2x
4159007



1x
4158355



3x
4125254



2x
4504371



2x
4157103



2x
612647



4x
302324



2x
618849



2x
408124



1x
611649



2x
4506533



4x
4521048



2x
4140801



2x
407026



6x
4294996



2x
4184617



6x
4167106



2x
4233487



1x
4121715



2x
4504382



1x
4188534



1x
485426



2x
4144023



2x
459926



2x
244426



1x
4514341



1x
302026



6x
4192456



3x
306926



6x
4158848



2x
73587



2x
458926



6x
255526



1x
379426



2x
4140588



3x
403226



3x
4142865



2x
4502595



1x
4244627



2x
4211048



3x
4289542



2x
4494595



2x
4494600



1x
4494597



1x
4204624



1x
4143005



LEGO

EXODUS





8112



8115





LEGO
LEGO



0116



0111



0113



トクシュブタイ

LEGO FORCE



1114



1115



1112



1117



www.LEGO.com



club™

FREE LEGO Magazine • GRATUIT • GRATIS LEGO Magazin



Join Today!

**Abonne-toi
dès aujourd'hui!**

Meld je nu aan!

Jetzt anmelden!

  **US & Canada only**
1-866-534-6258 / 1-877-518-5346

(in France)

00800 5346 5555



www.LEGOclub.com



**VISIT THE WORLD'S
BIGGEST LEGO® SHOP!
www.LEGOshop.com**



YES! I want to join the LEGO® Club FREE!

OUI! Je veux m'abonner au Club LEGO® GRATUITEMENT!

Ja! Ich möchte Mitglied im kostenlosen LEGO Club werden.

Ja! Ik wil graag GRATIS lid worden van de LEGO Club.

First Name
Prénom
Vorsame
Voornaam

Boy
Garçon
Junge
Jongens

Last name
Nom de Famille
Familienam
Achternaam

Girl
Fille
Mädchen
Meisje

Street, No.
Rue
Straße, Nummer
Straat, nummer

City/Town/Village
Stadt
Woonplaats

State
Prov.

Zip/Postcode
Code Postal
PLZ
Postcode

Country
Pays
Land

Date of Birth
Date de naissance
Geburtsdag
Geboortedatum

Email

Parent's signature
Signature of a parent

Bevater's/Pl. Erziehungsberechtigter
Bevoegdheids ouders



BG28



BIOBU



BIOBC

Mail to: / Poster ic:

**LEGO Club
P.O. Box 1157
EnField, CT USA
06083-1157**

Mail to:

**LEGO Club
33 Both Road
Slough SL1 3UF
United Kingdom**

Per Post via:

**LEGO® Club
Postfach 14 15
D-36243 Niederaula**

The English version of this magazine can only be mailed to addresses in the US, Canada, the UK, and Republic of Ireland. This membership is valid for 2 years and includes five copies of the LEGO Magazine in the US and Canada plus one per 4 weeks for delivery of your first magazine. By signing this form you consent the LEGO Club to use your child's data for LEGO mailings. The data will only be used for LEGO mailings and will not be sold, rented or otherwise disclosed to any companies outside the LEGO Company except for disclosure to companies acting as our agents to help us provide services requested by the child. This consent good for two years membership per parent, guardian or organization. If you would not like to receive other communication from the LEGO Company please tick here: La version Française de cette revue peut être envoyée uniquement en France. L'abonnement est valide pour 2 ans et inclut des magazines gratuits de LEGO Magazine LEGO, Jan 1-3, UK et Canada, ainsi qu'une copie par 4 semaines pour la livraison de votre premier magazine. En signant ce formulaire vous consentez à ce que LEGO utilise les informations de votre enfant pour des envois postaux de LEGO. L'information sera utilisée uniquement pour des envois postaux par LEGO et ne sera en aucun cas, vendue, louée, échangée ni divulguée à d'autres entreprises autres que la compagnie LEGO, à l'exception des entreprises agissant en tant que nos agents pour des services demandés par l'enfant ou l'organisation. Ce consentement est valable pour deux ans par parent, tuteur ou organisation. Si vous ne souhaitez pas recevoir d'autres communications de la compagnie LEGO, veuillez cocher ici: Bei dem diespracheigen Angebot nur für die Länder A, U und CH. Die kostenlose Mitgliedschaft beinhaltet die Zusendung des LEGO Magazines und endet nach zwei Jahren. Für die Nutzung der persönlichen Daten Ihres Kindes, ist das erste Magazine kostenlos. Mit dieser Mitgliedschaft erkläre ich sich einverstanden, dass die Daten Ihres Kindes zum Zweck einer LEGO Club-Mitgliedschaft von der LEGO Gruppe gespeichert werden. Die Informationen werden ausschließlich für den Zweck der Lieferung von LEGO Produkten an Ihre Adresse genutzt. Deze versie is bedoeld voor landen waar de LEGO Company geen commerciële activiteiten heeft. Het lidmaatschap is geldig voor twee jaar en omvat vijf gratis exemplaren van het LEGO Magazine. Daarnaast wordt u vier keer per maand een exemplaar van het LEGO Magazine toegezonden. Door het ondertekenen van dit formulier geeft u toestemming dat LEGO de gegevens van uw kind gebruikt voor het verzenden van LEGO producten en andere berichten van LEGO Group, uitgezonderd de organisaties die namens ons optreden om de service te verbeteren waarmee het lidmaatschap is verbonden.



WIN LEGO® PRODUCTS

No purchase necessary.
Open to residents of all countries where
not prohibited.
Go to www. for official rules and details.

WIN LEGO® PRODUCTEN

Kopen niet nodig.
Open voor alle leeftijden, en in alle landen
waar geen verbod geldt.
Ga naar www. voor officiële regels en details.

GEWINNE LEGO® PRODUKTE

Die Teilnahme am Gewinnspiel führt zu
keinerlei Kaufverpflichtungen.
Sie können in allen nicht ausgeschlossenen
Ländern teilnehmen.
Die offiziellen Regeln und nähere Informationen
finden Sie unter www.

GAGNE DES PRODUITS LEGO®

Aucun achat n'est nécessaire.
Ouvert à tous les âges et aux résidents de
tous les pays, sauf en cas d'interdiction.
Rendez-vous sur www. pour obtenir plus
de détails et le règlement officiel.

レゴ®製品を「当てよう」

購入は不要です
禁止されていない限り、あらゆる
年代およびあらゆる国の居住者の
方々にご利用いただけます。
公認規則および詳細につきましては、
www.をご覧ください

