



PRINCE OF  
**PERSIA**  
THE SANDS OF TIME



20017



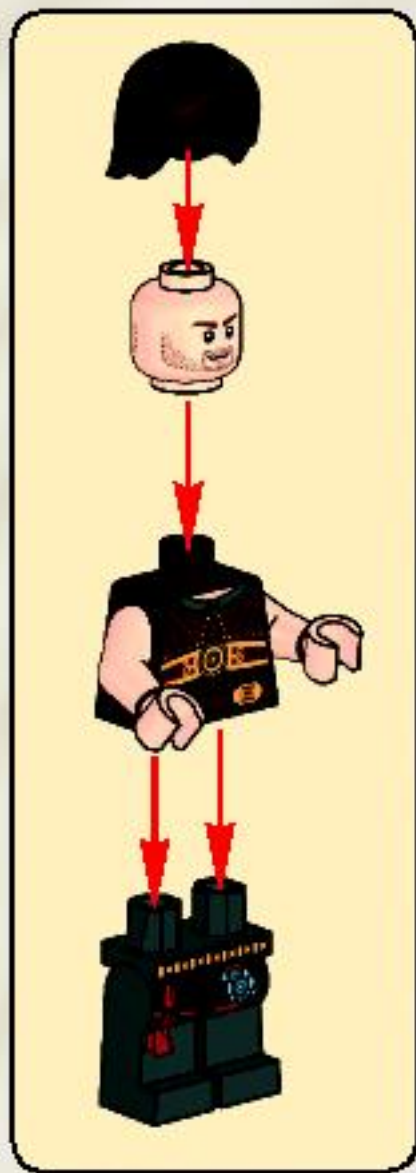

**1**

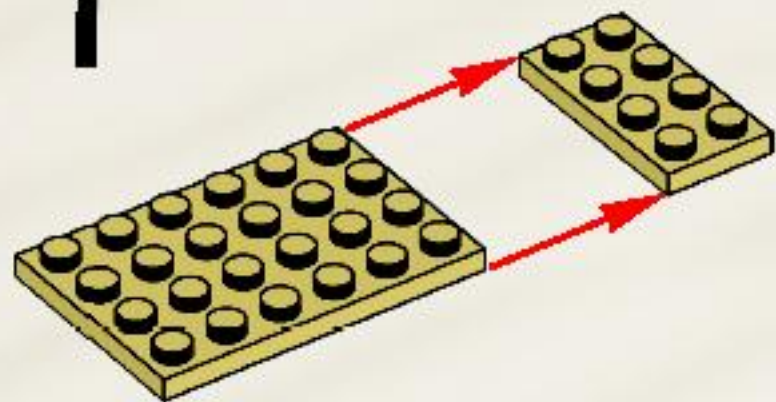

**2**

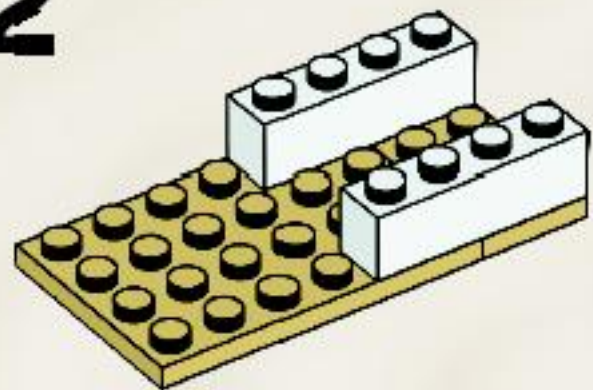

3

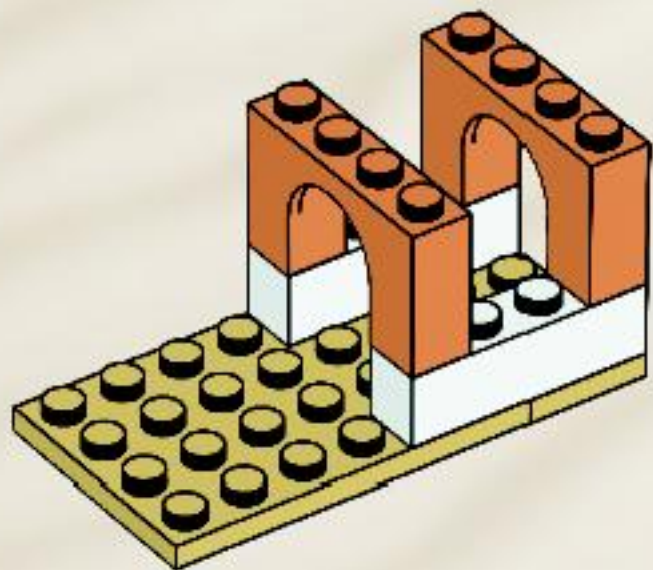

4

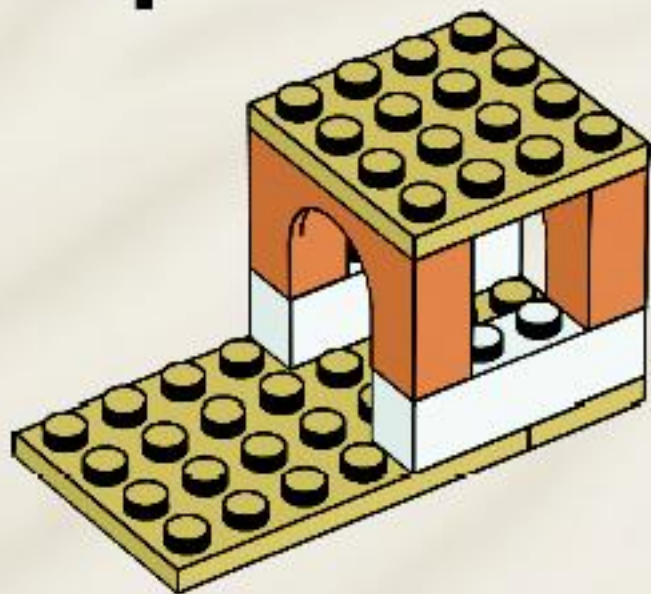

**5**

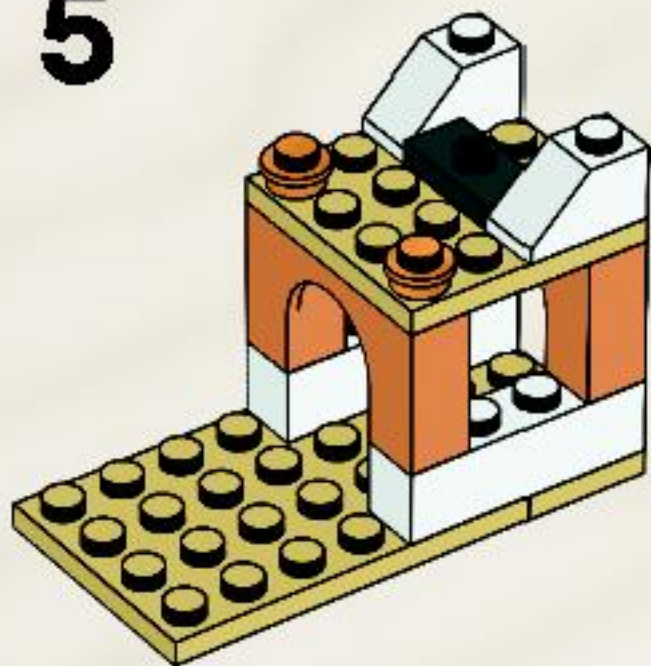

**6**

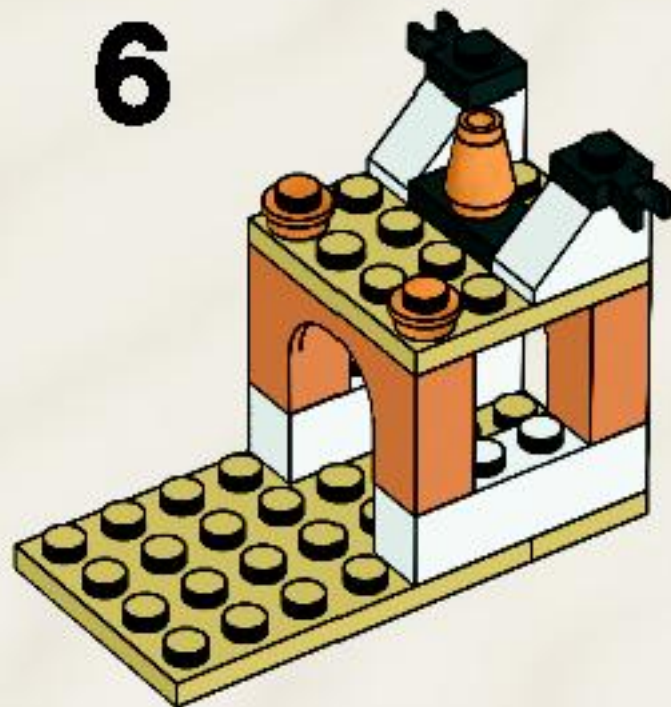

7

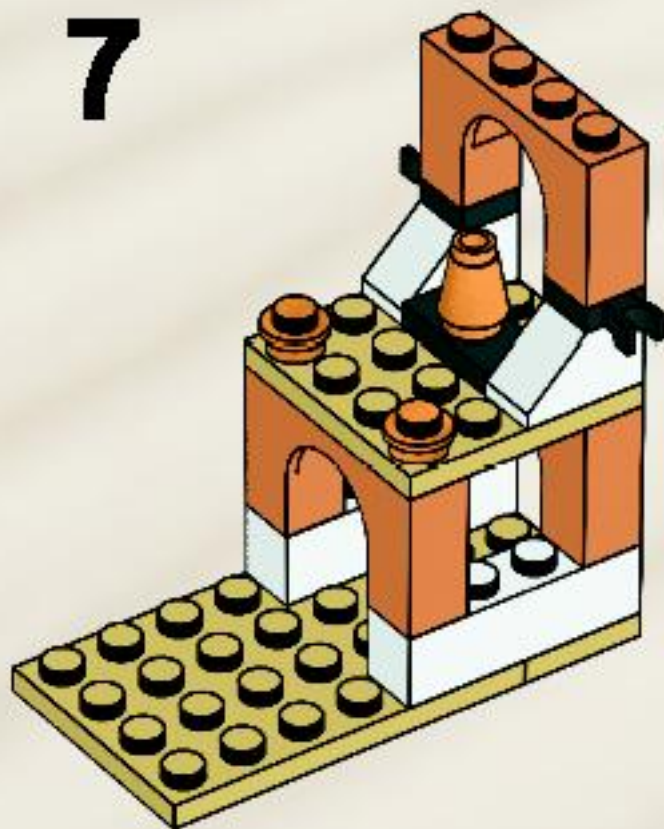

8

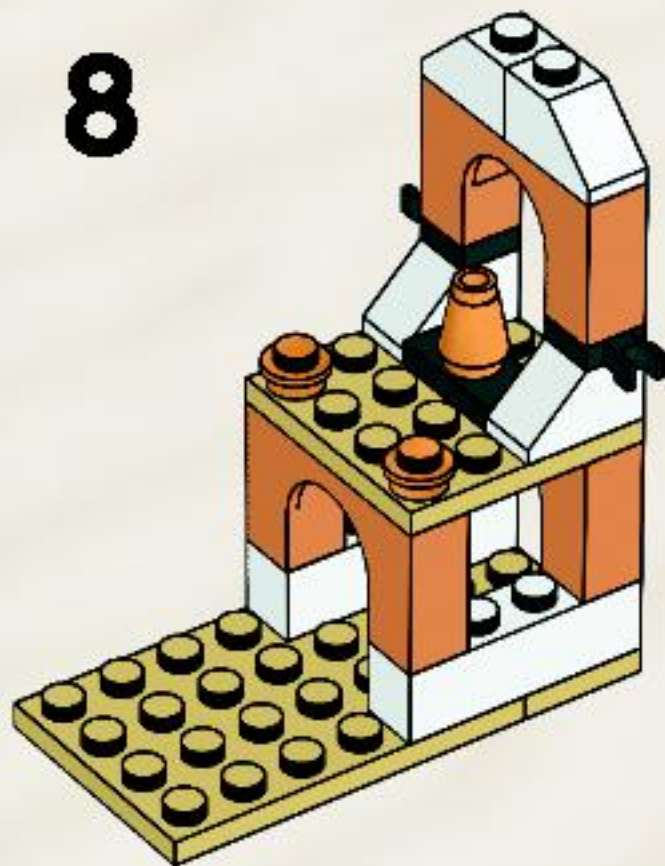

9





10

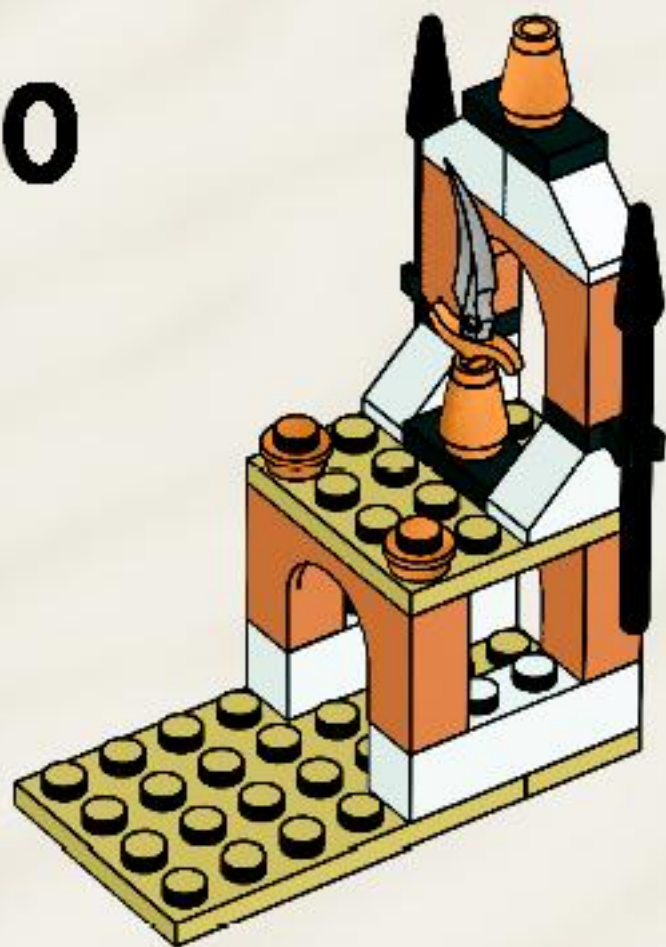

11

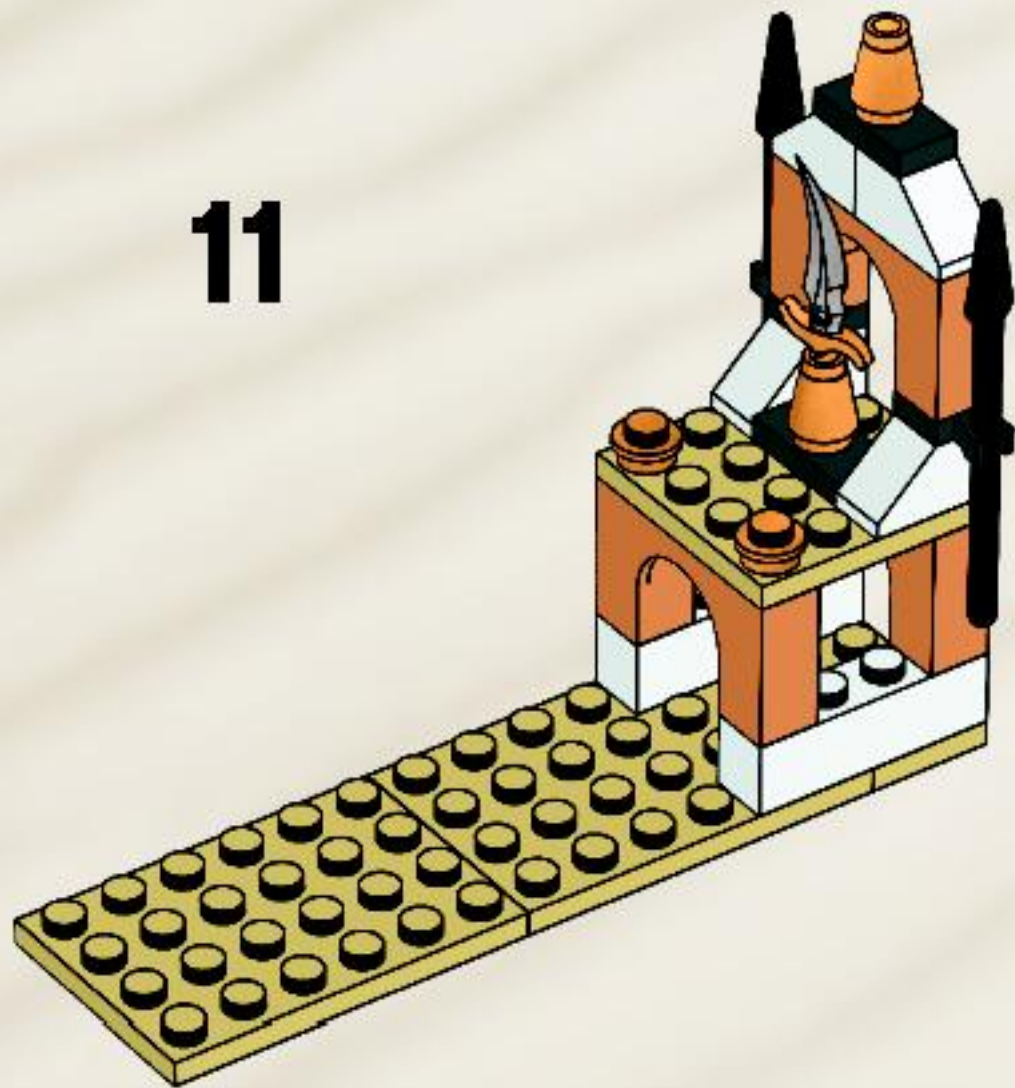

12

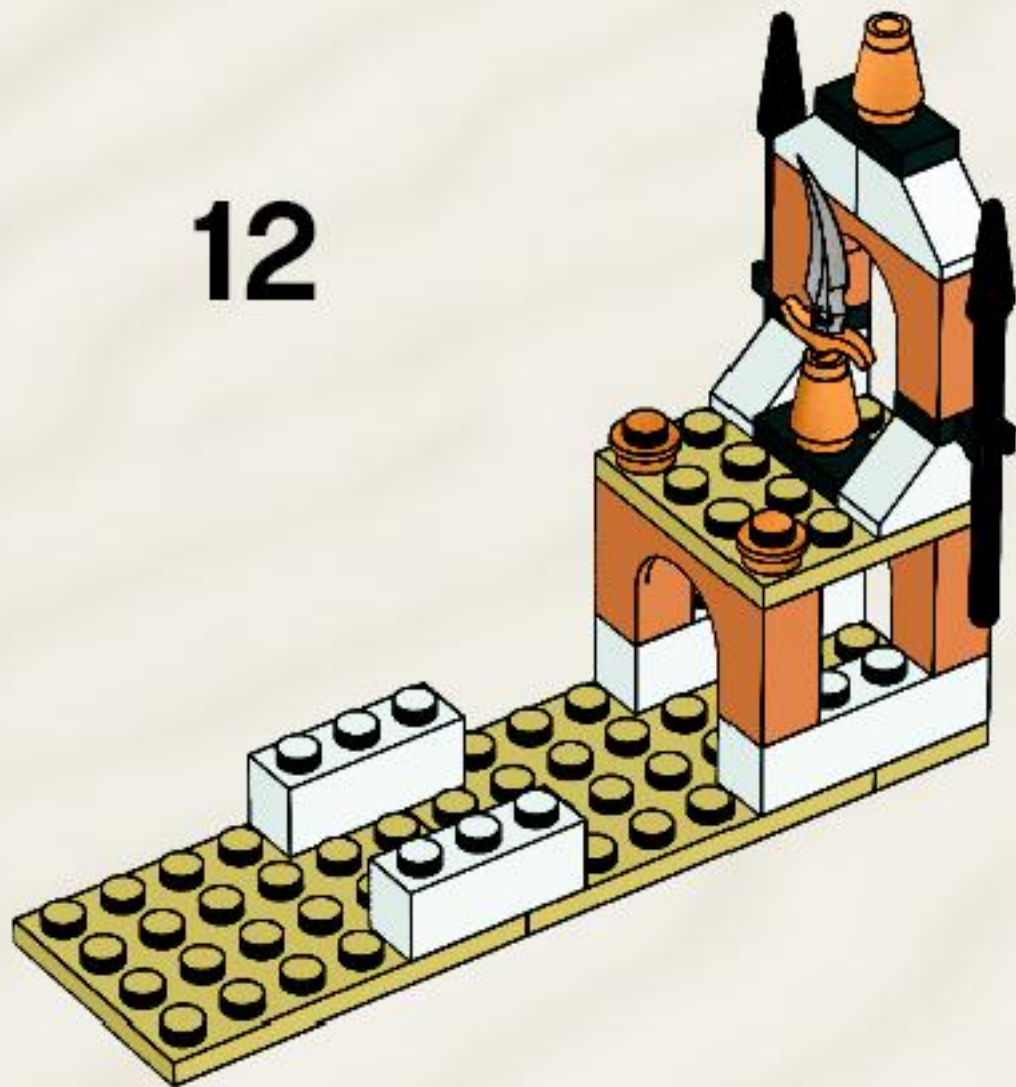

13

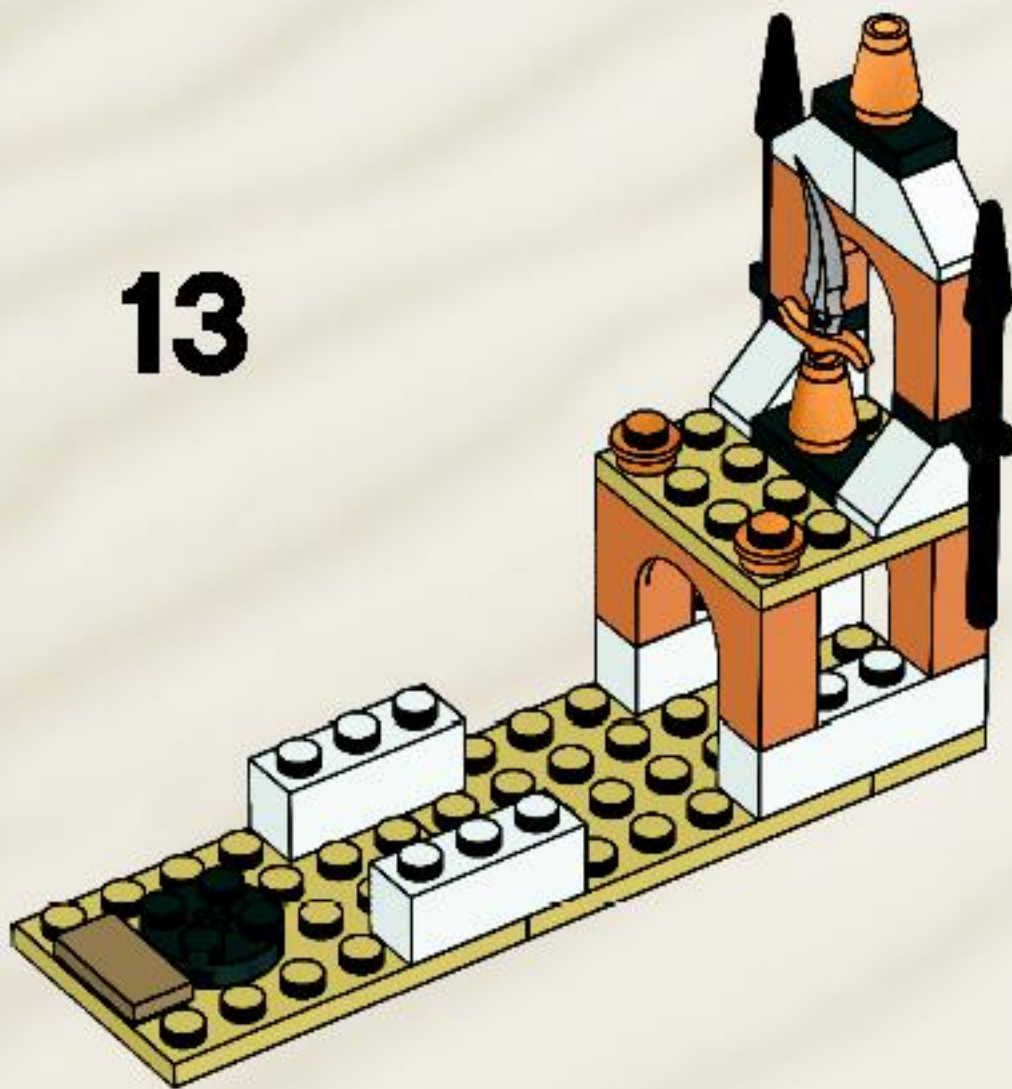

14





1

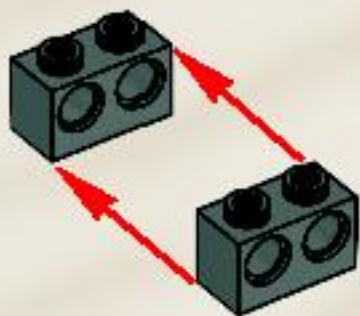

2



**3**

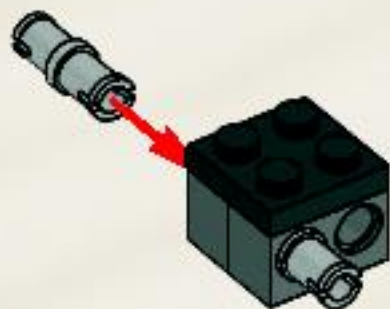

**4**

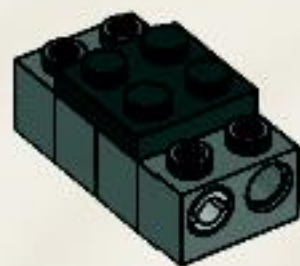

5

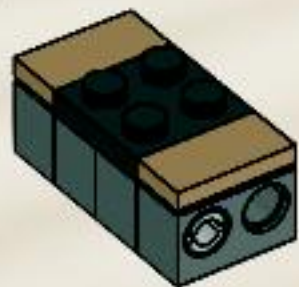

15

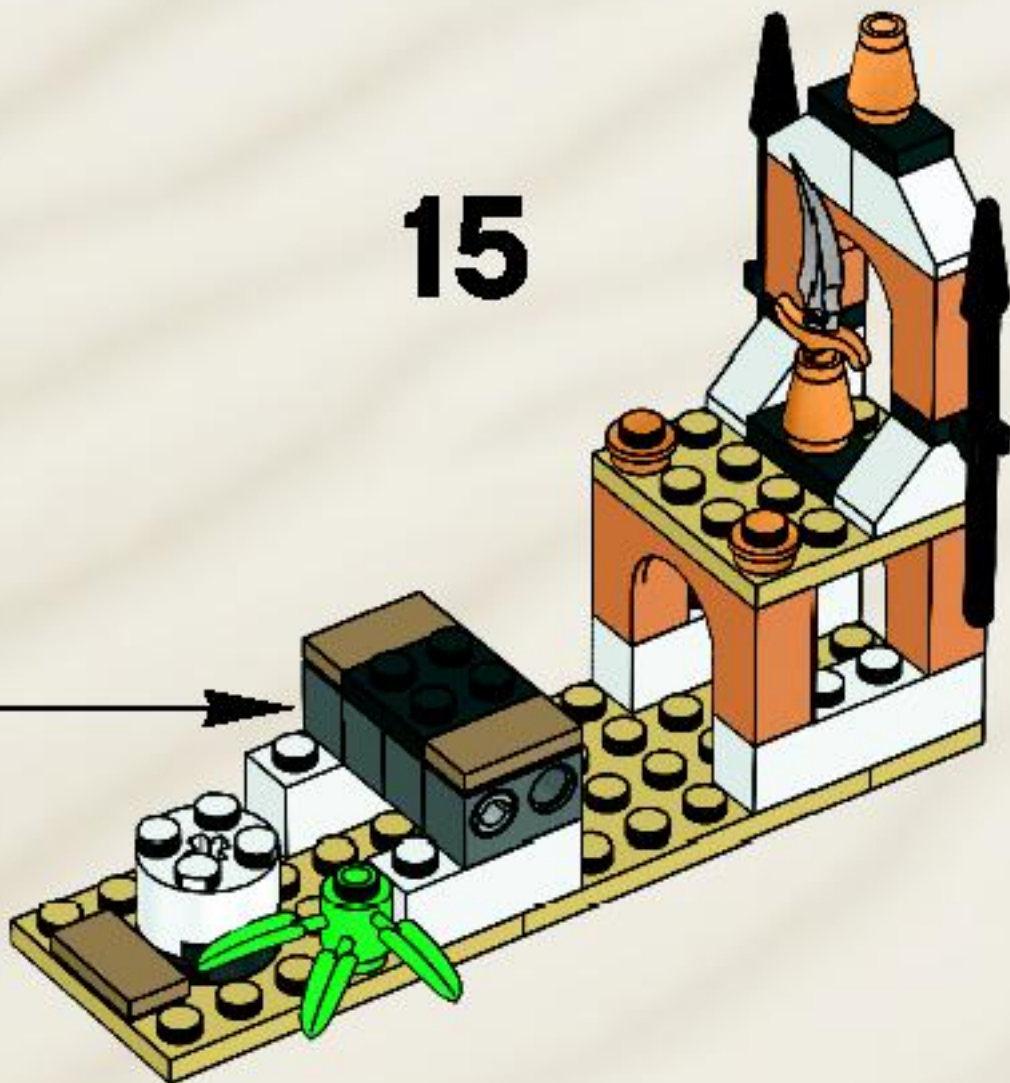



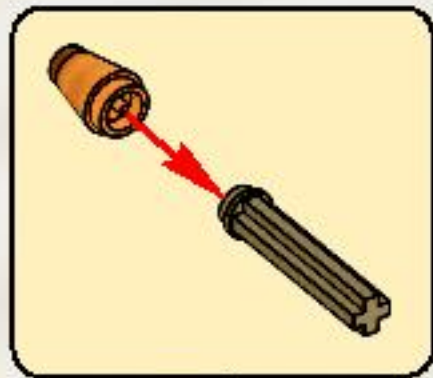

16

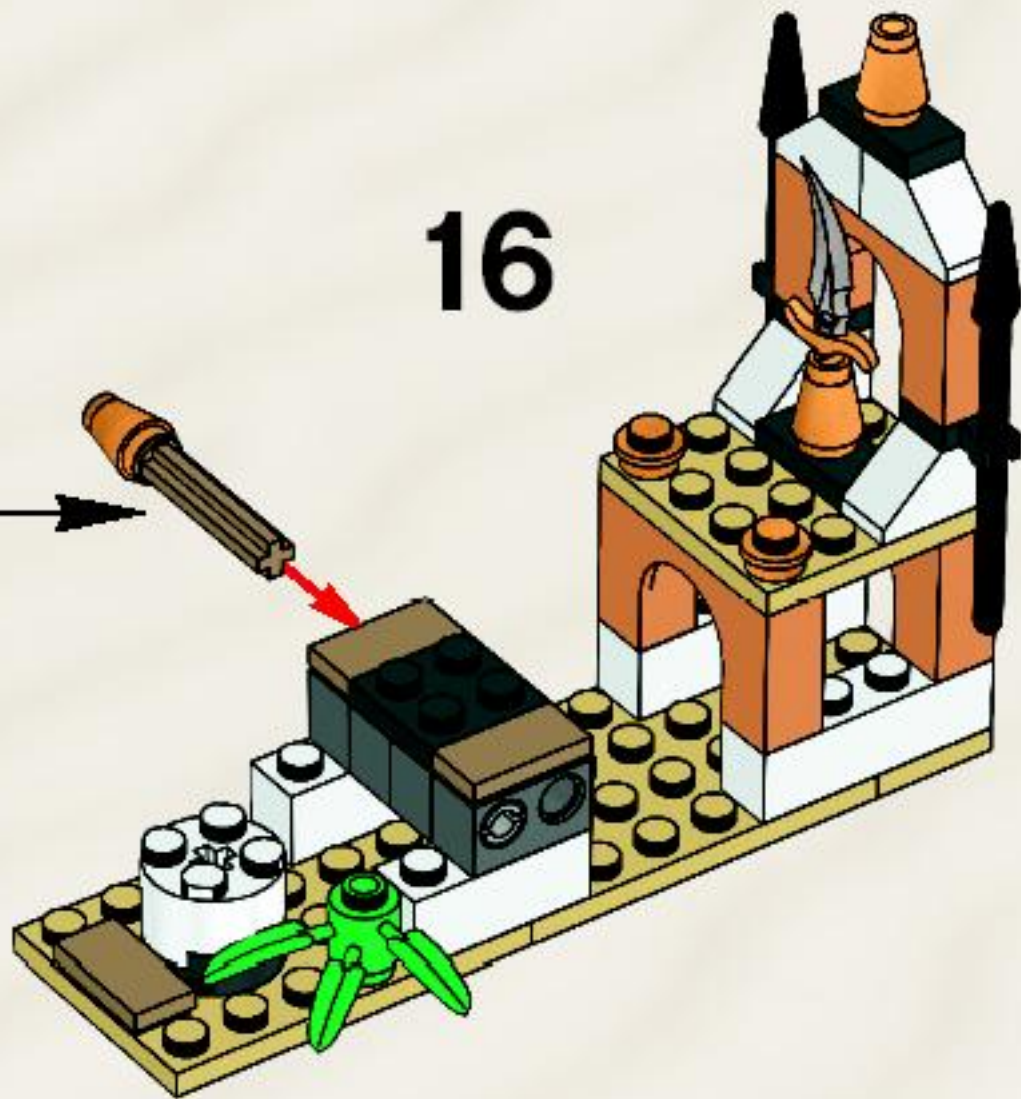

17

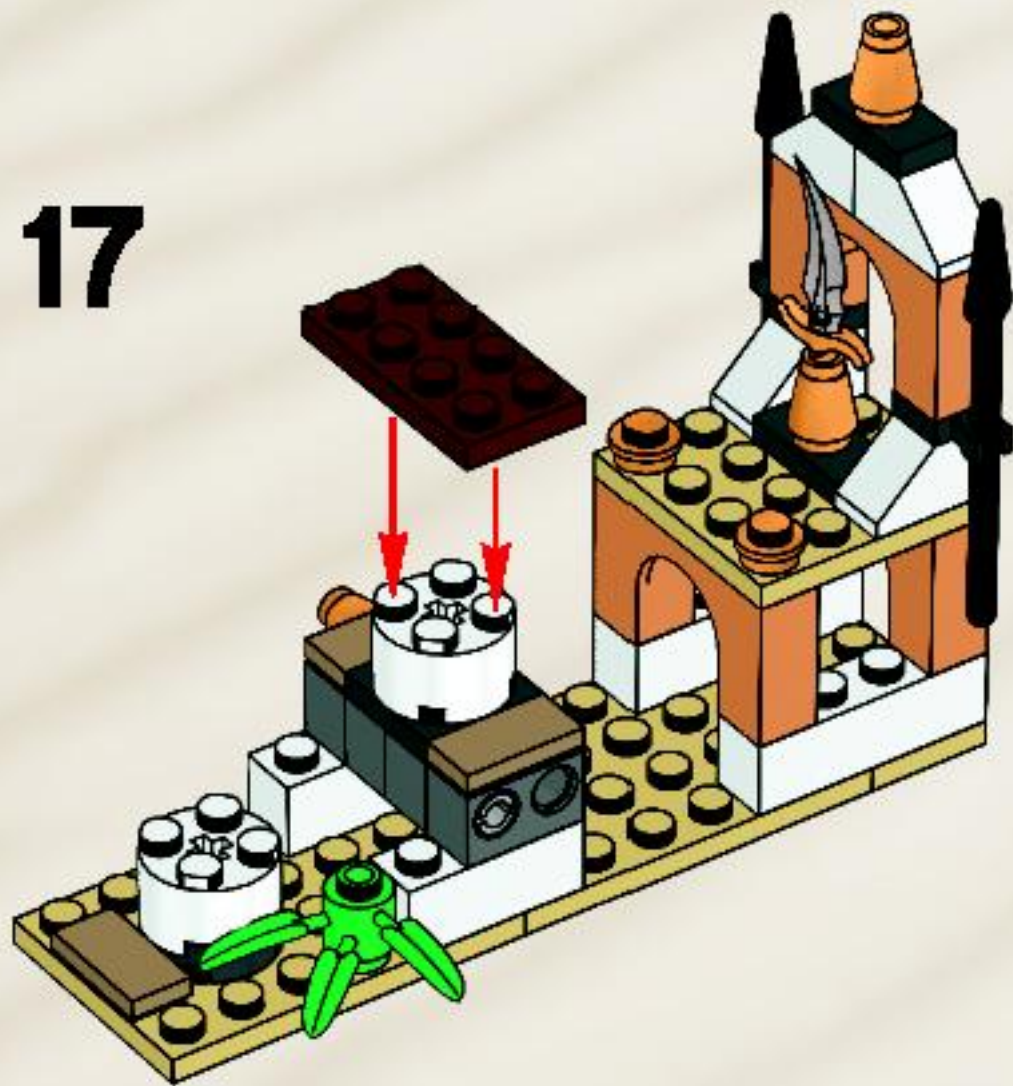

18

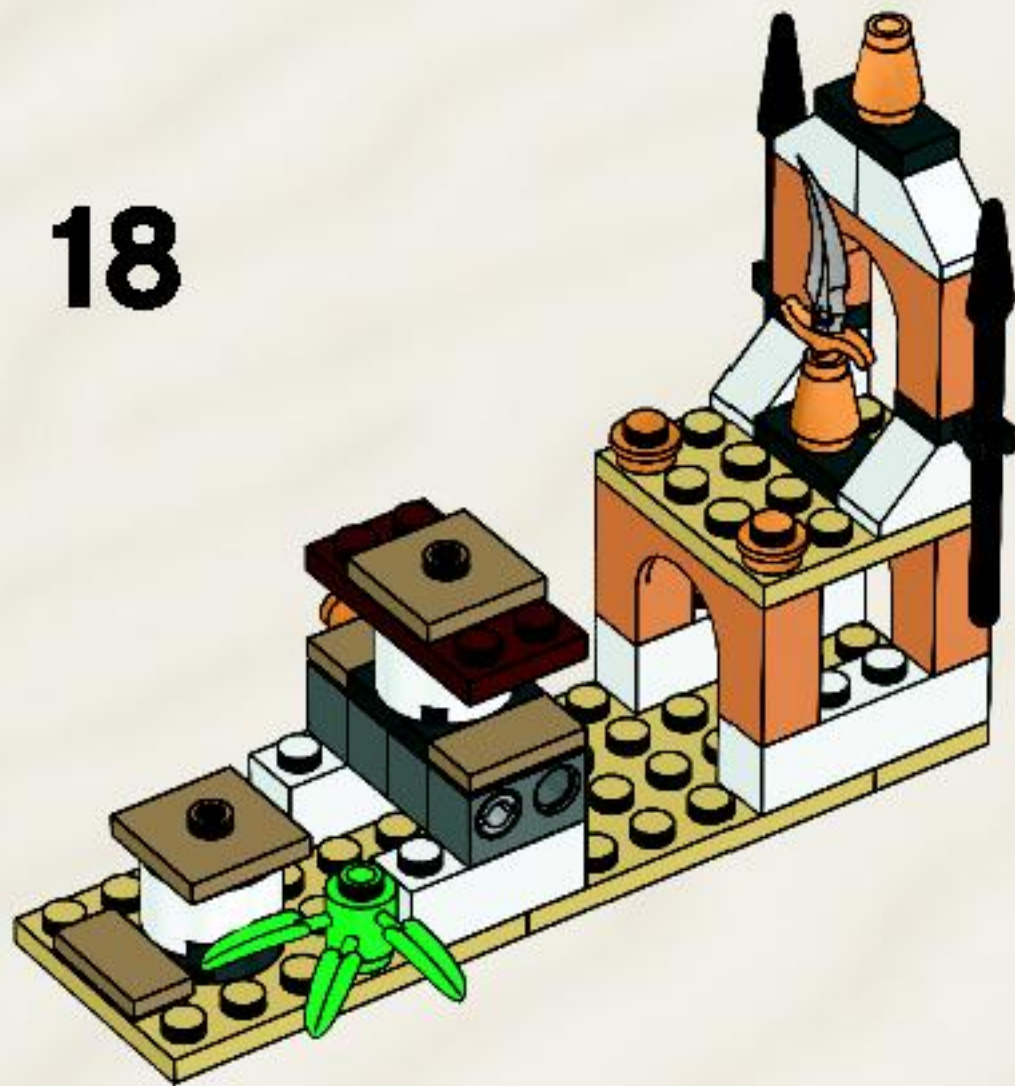

19

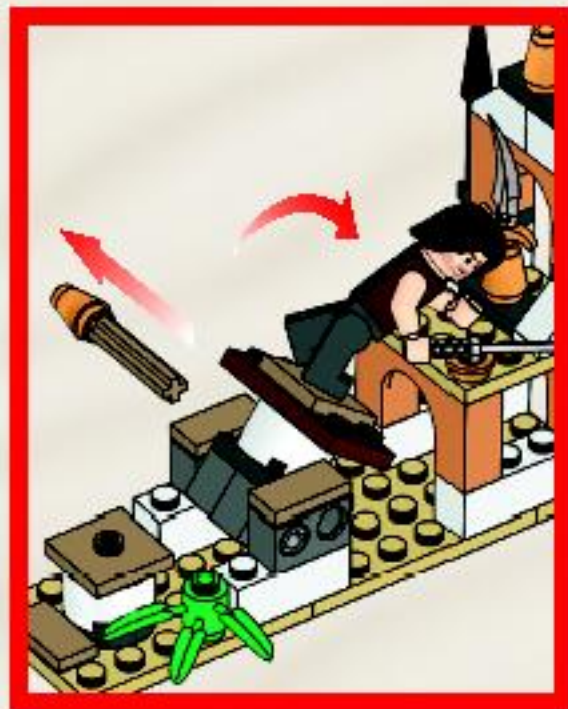



2x  
362201



2x  
4114001



1x  
4569471



4x  
4210762



2x  
4549898



2x  
4114052

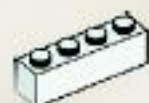

2x  
301001



1x  
302226



3x  
4496699



1x  
4568730



1x  
4580101



1x  
4114348



2x  
614301



2x  
4550017



2x  
4578032



3x  
4529247



1x  
4568934

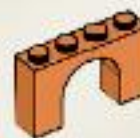

3x  
4569470



4x  
4121932



2x  
379426



1x  
4566927



2x  
4523159



1x  
4568950



1x  
4114309



1x  
403226



1x  
4211186



1x  
4243824



1x  
4580099



2x  
4211807



Customer Service

Kundenservice

Service Consommateurs

Servicio Al Consumidor

[www.lego.com/service](http://www.lego.com/service) or dial





7572





7573



LEGO and the LEGO logo are trademarks of the LEGO Group. ©2010 The LEGO Group.  
©Disney Enterprises, Inc. and Jerry Bruckheimer, Inc. 4591898



[www.LEGO.com](http://www.LEGO.com)