

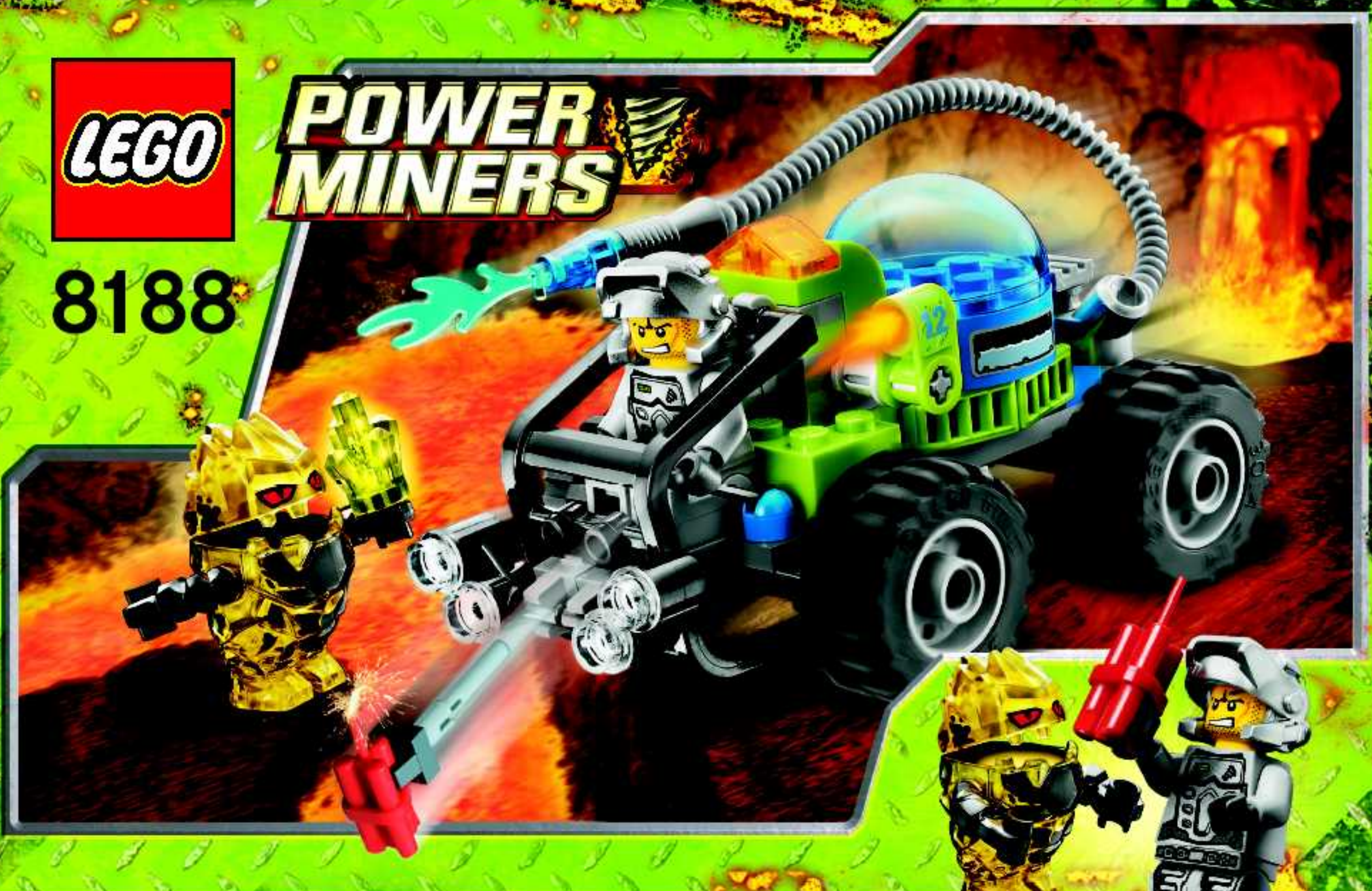

# POWER MINERS

8188





1

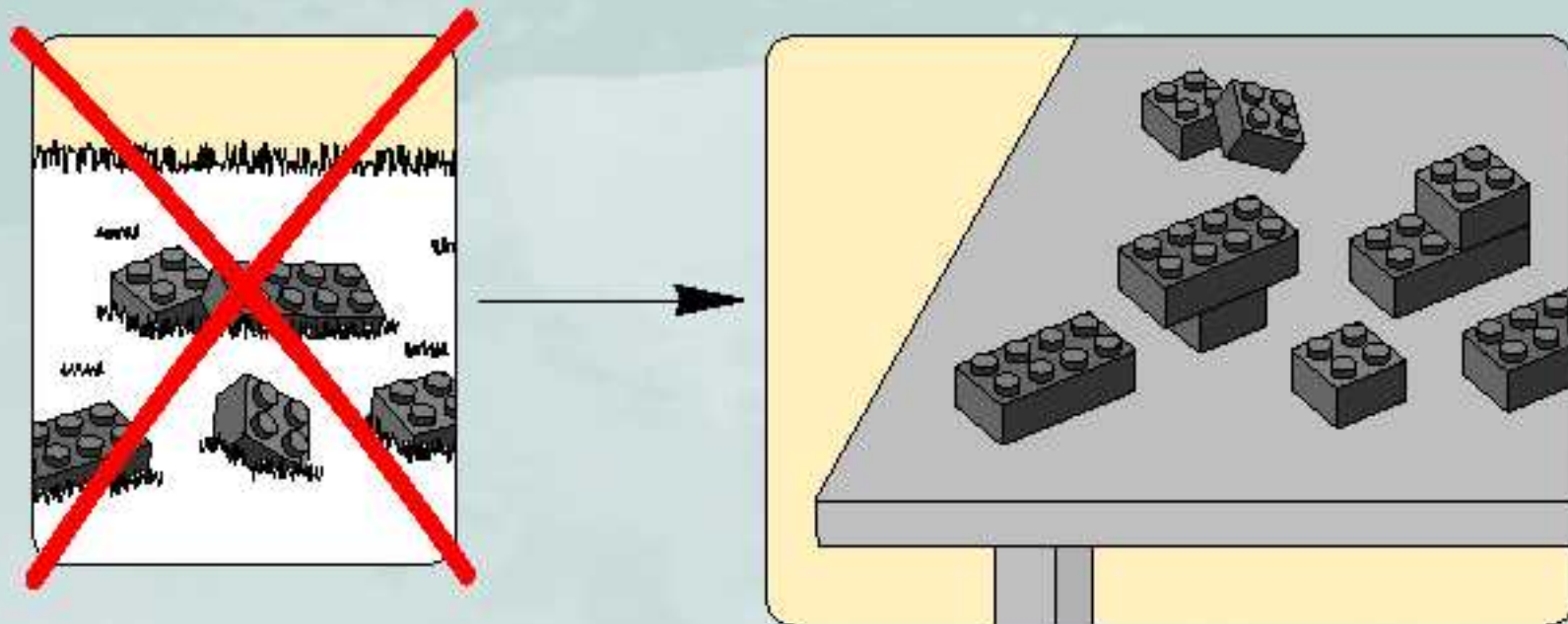

2

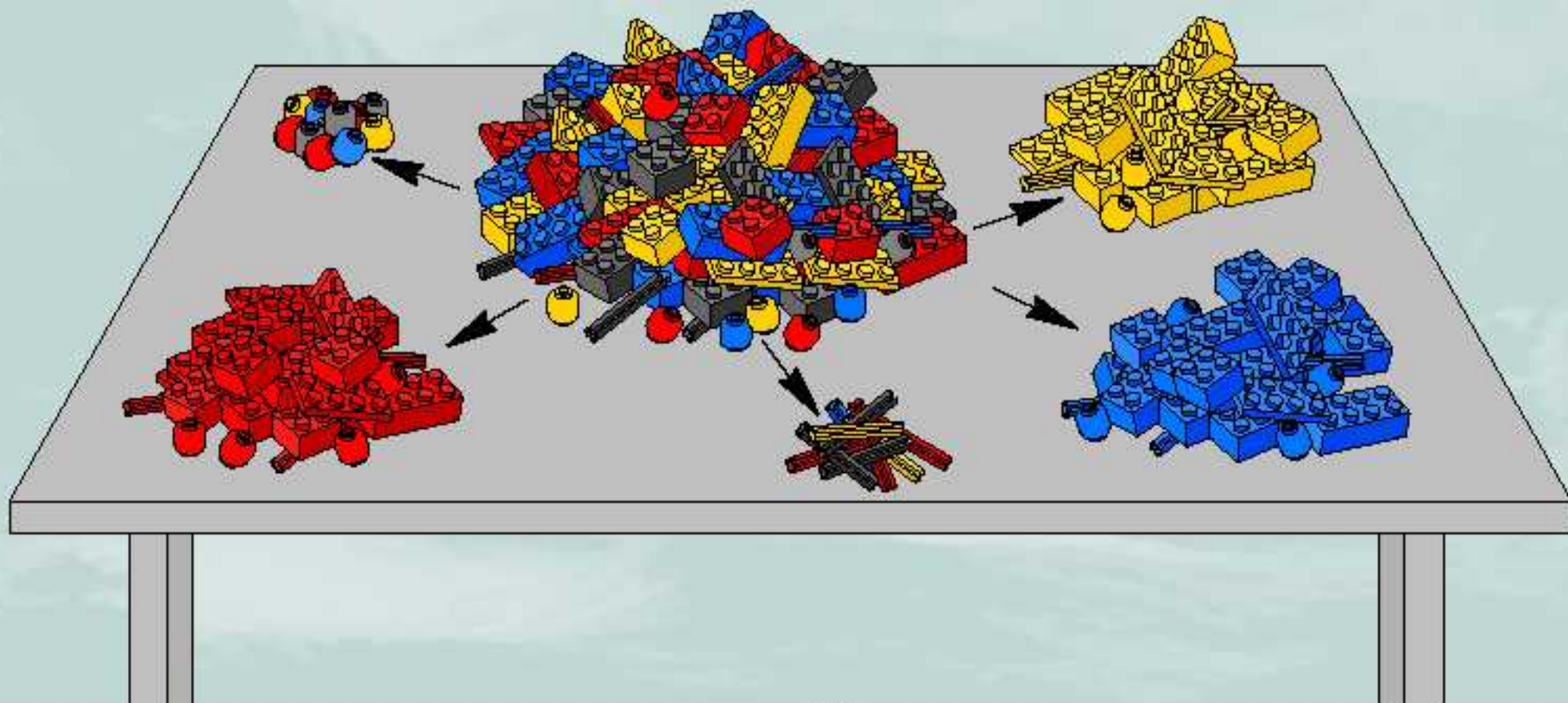

2

3

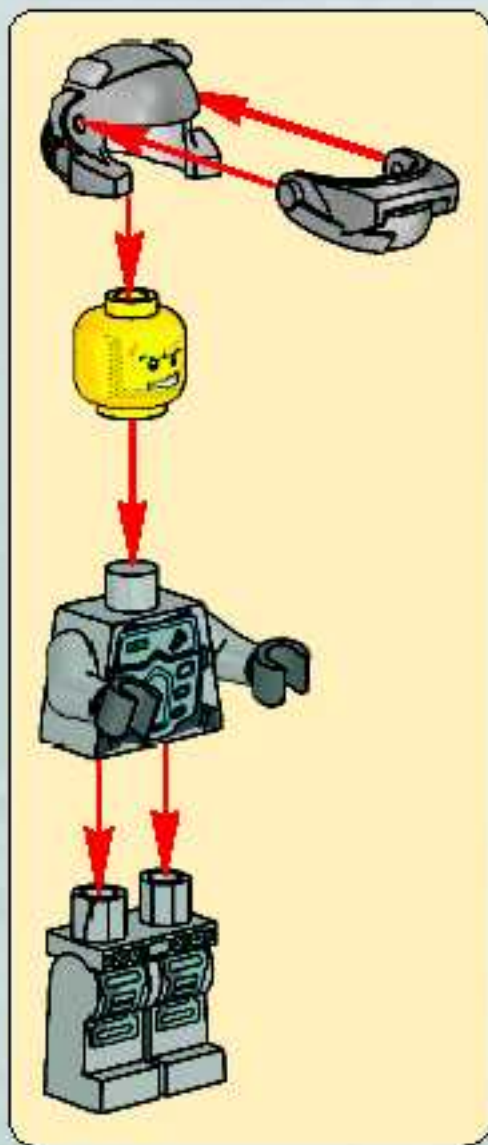

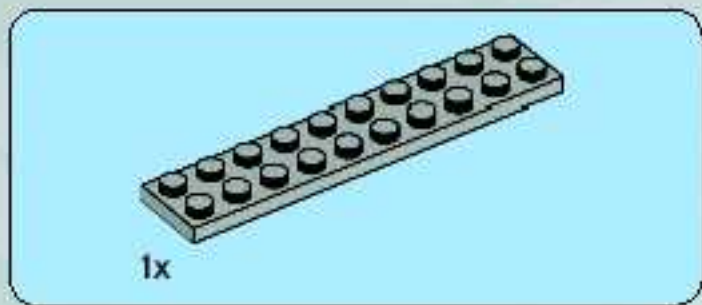

1

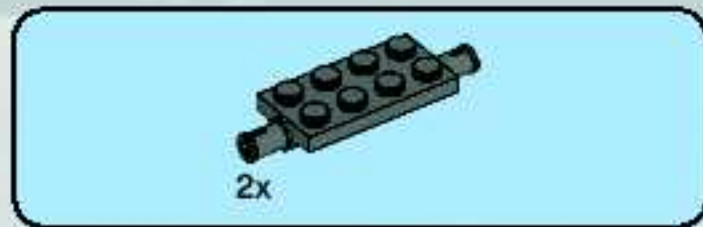
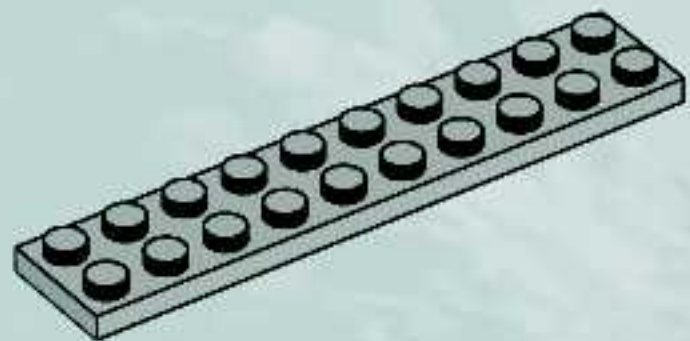

2

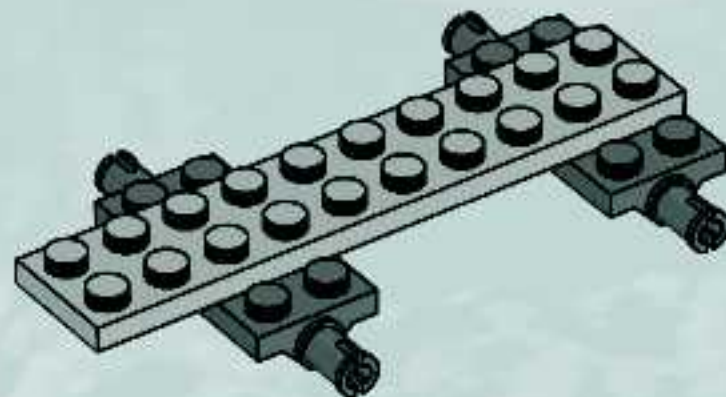





3

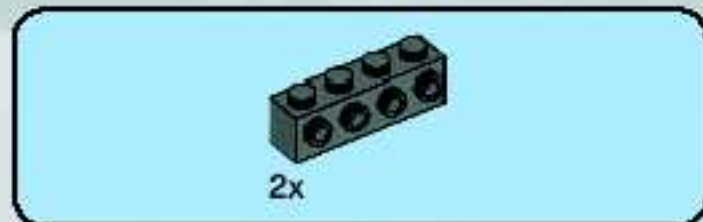
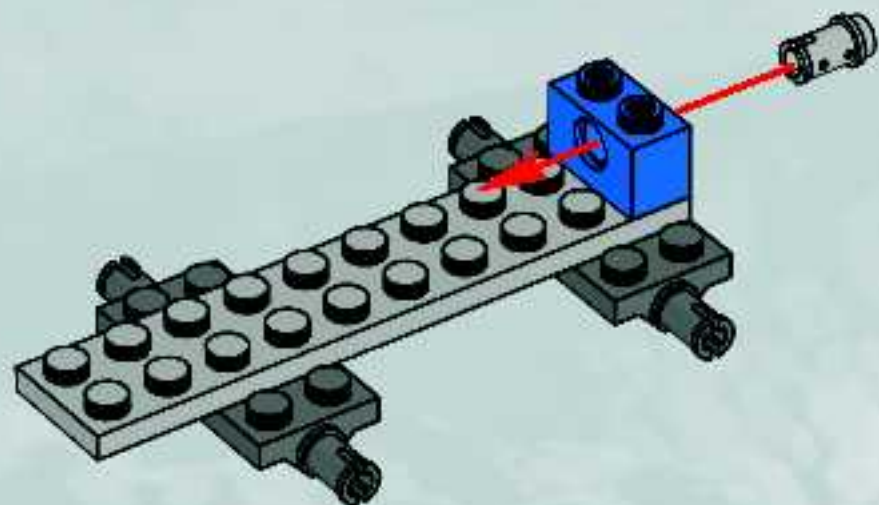

4

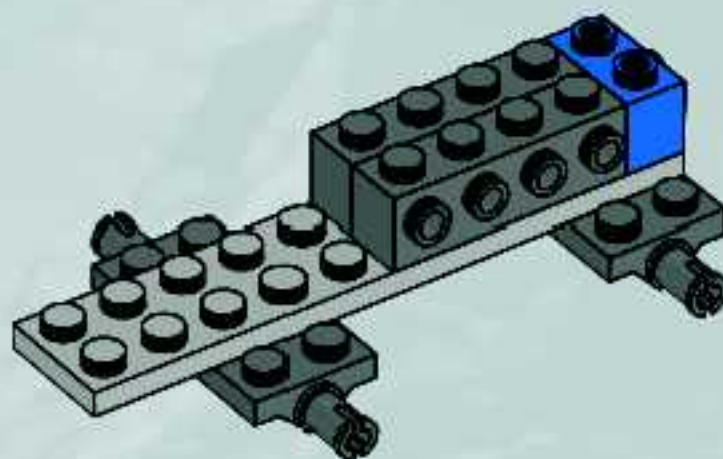

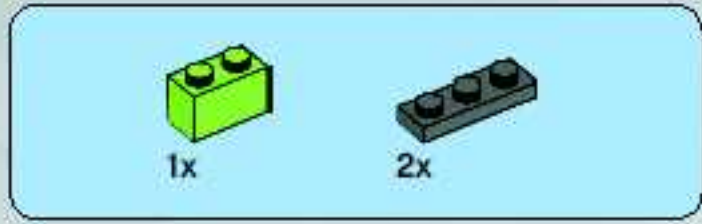

5

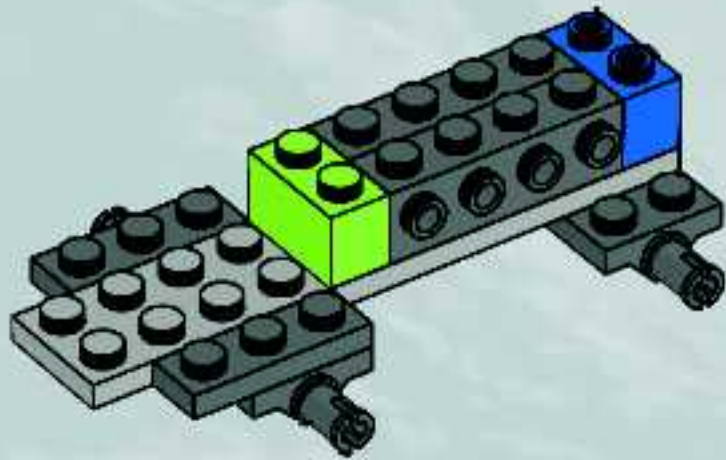

6

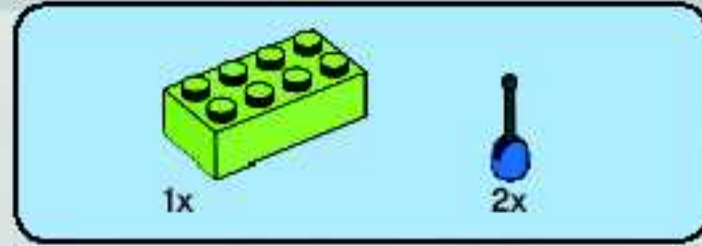

6

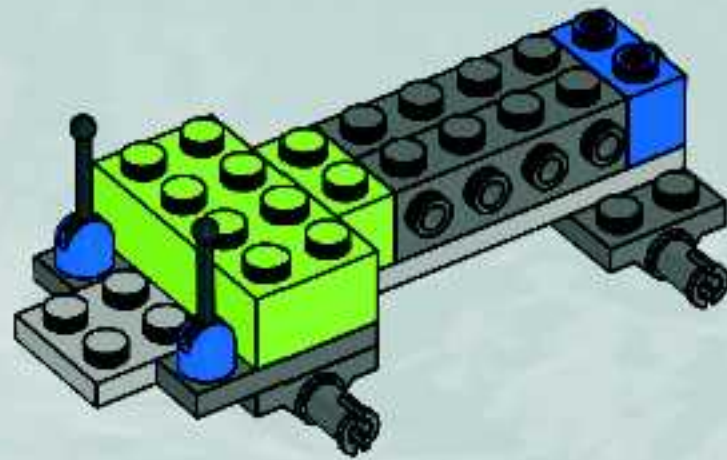

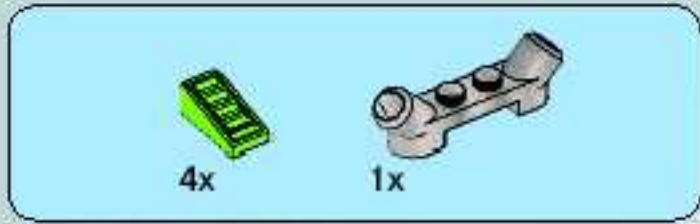

7

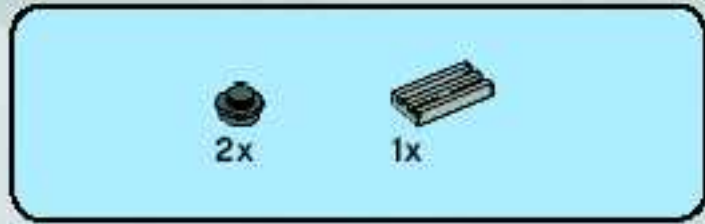
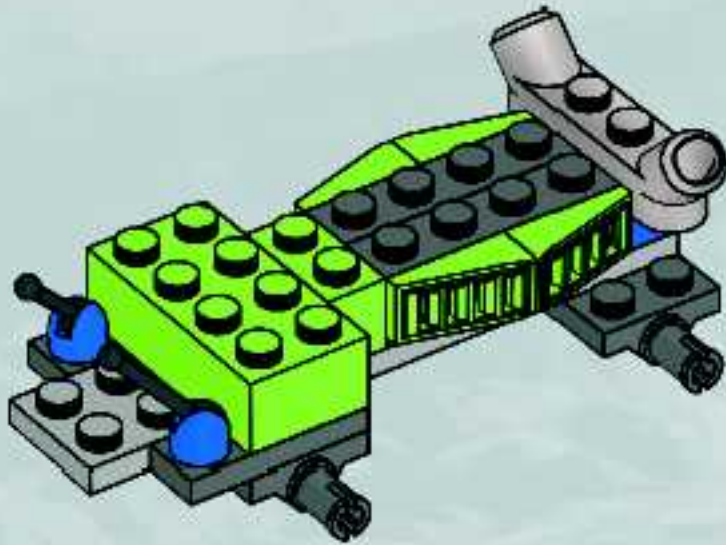

8

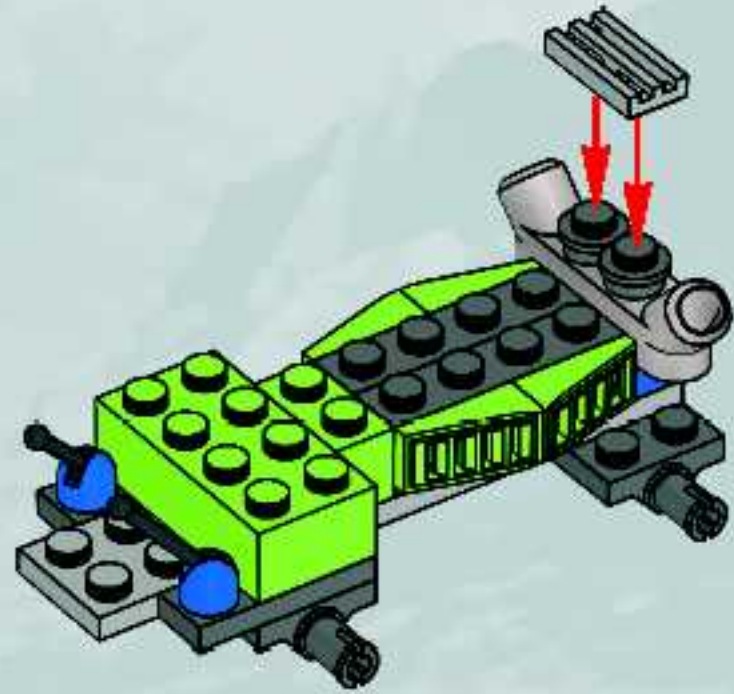



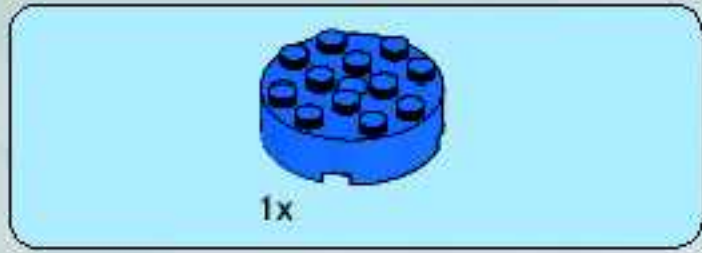

9

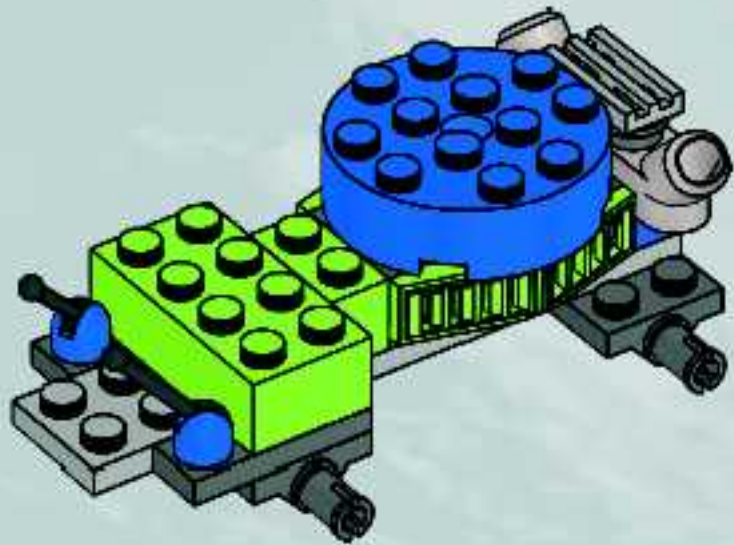

10

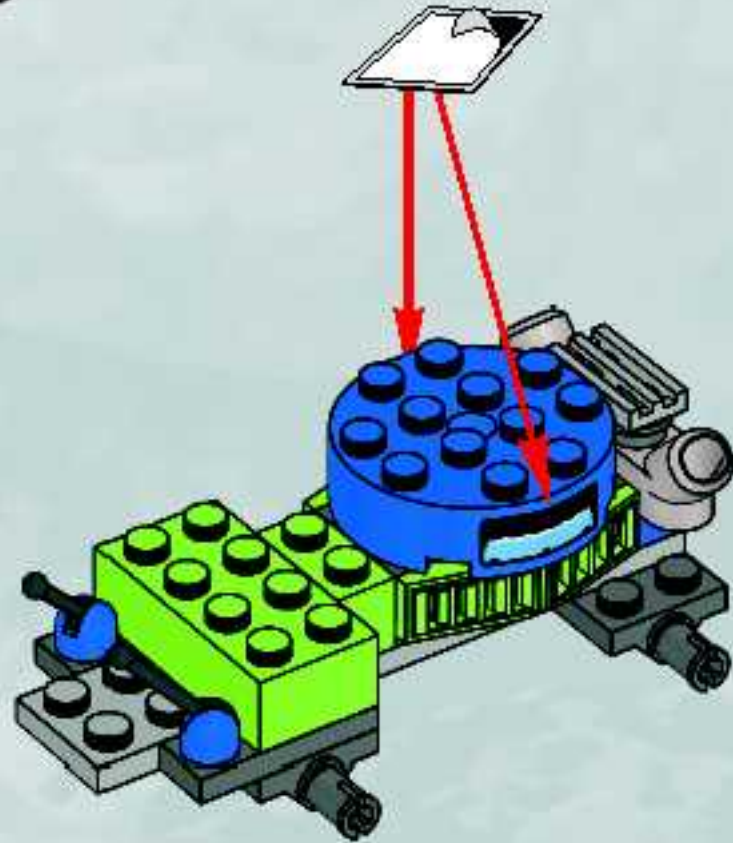



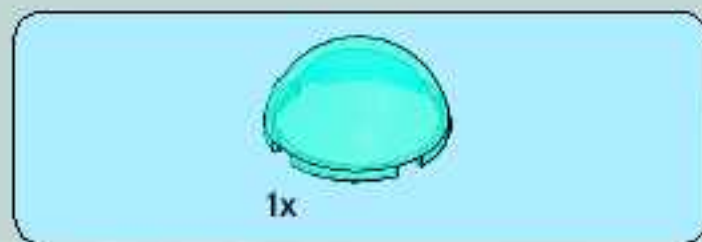

11

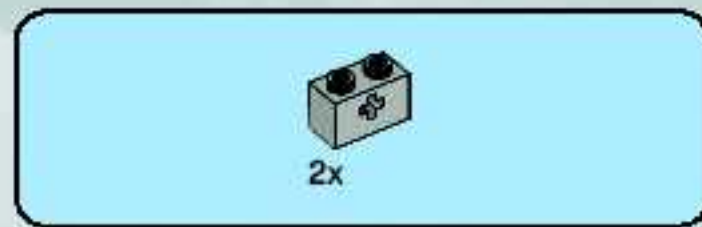
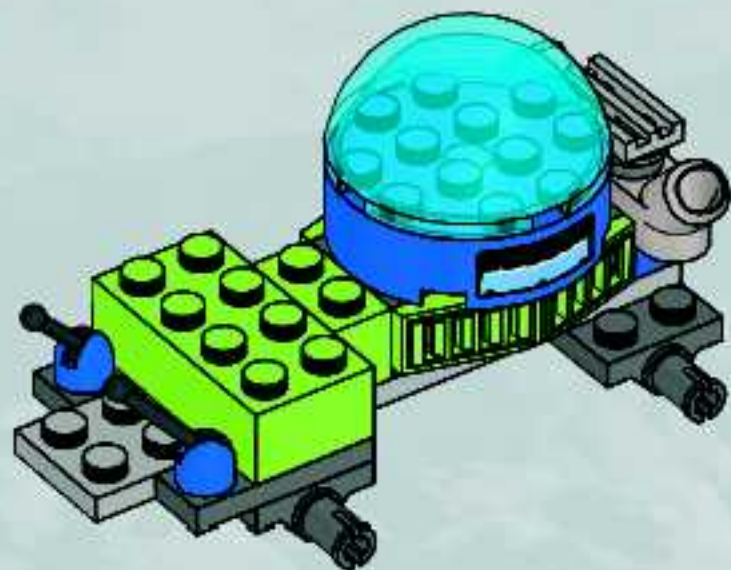

12

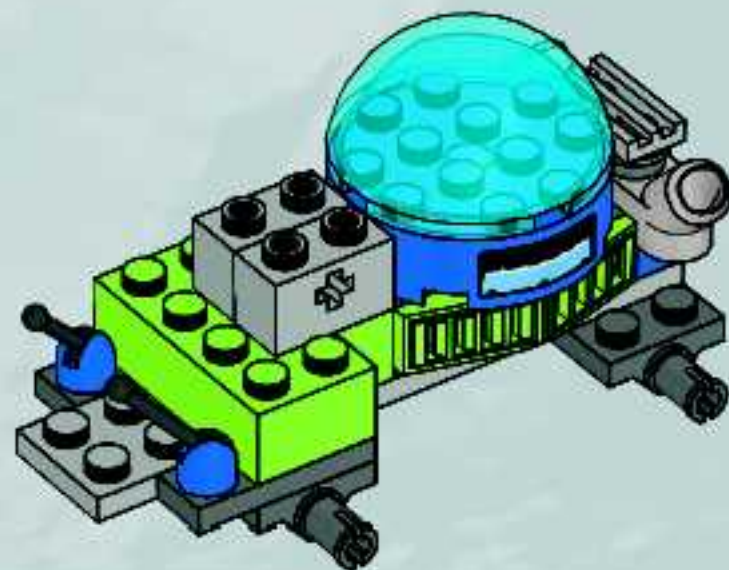

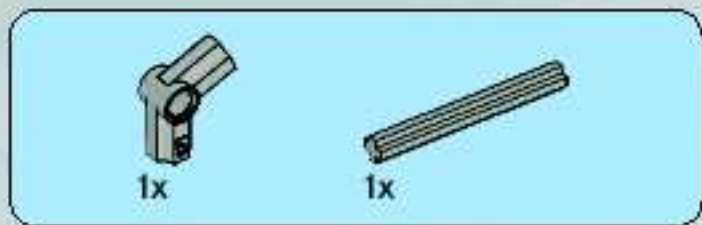

# 13

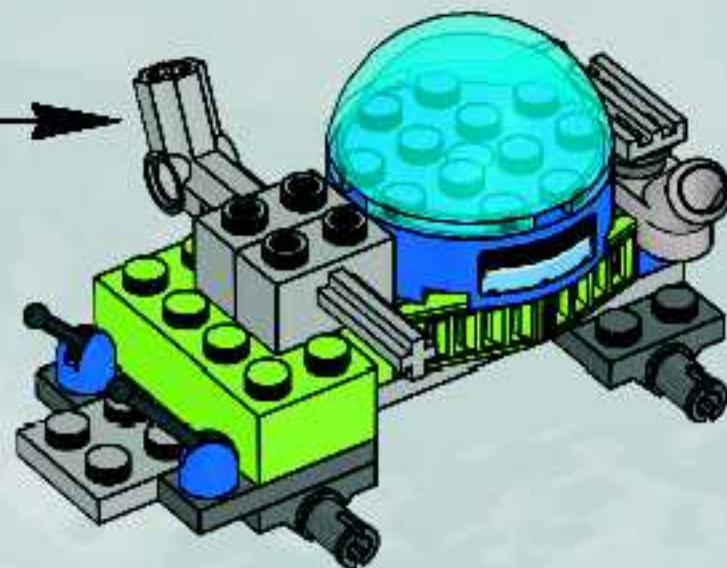
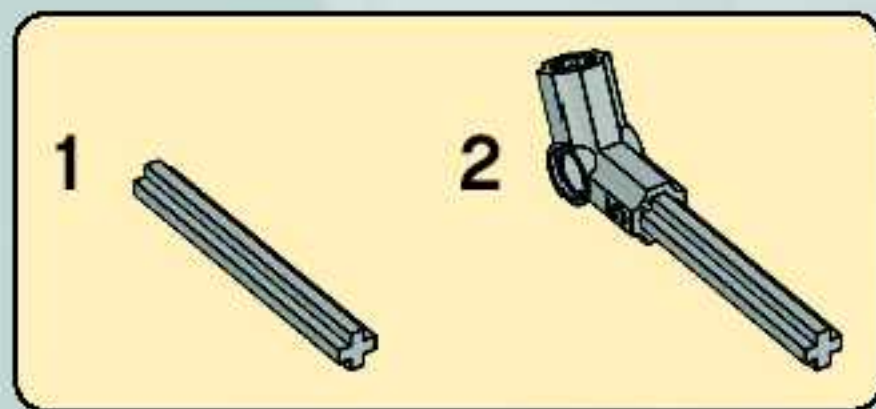





1x

# 14

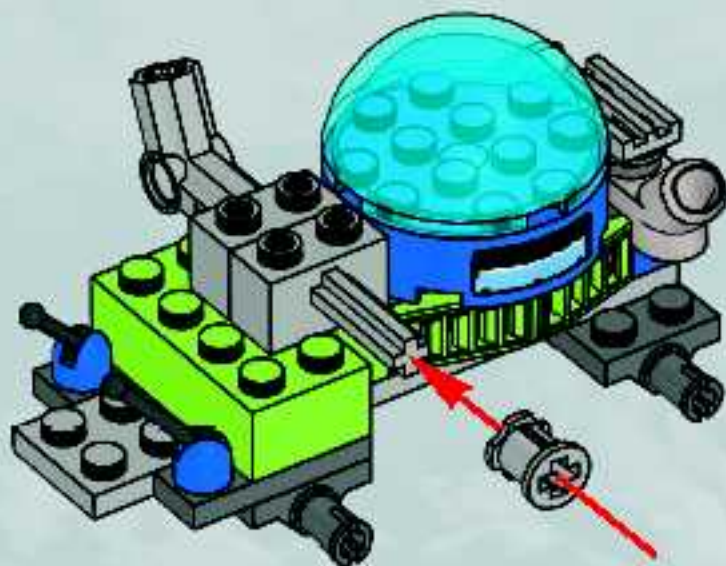

1x

# 15

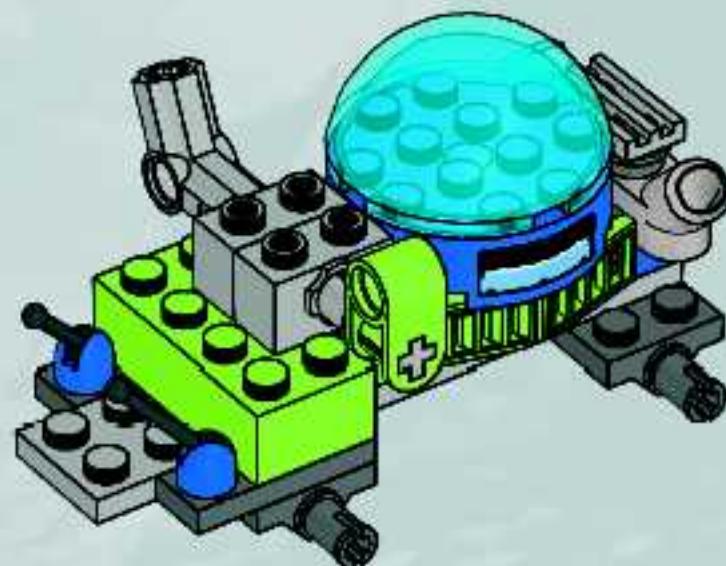

16

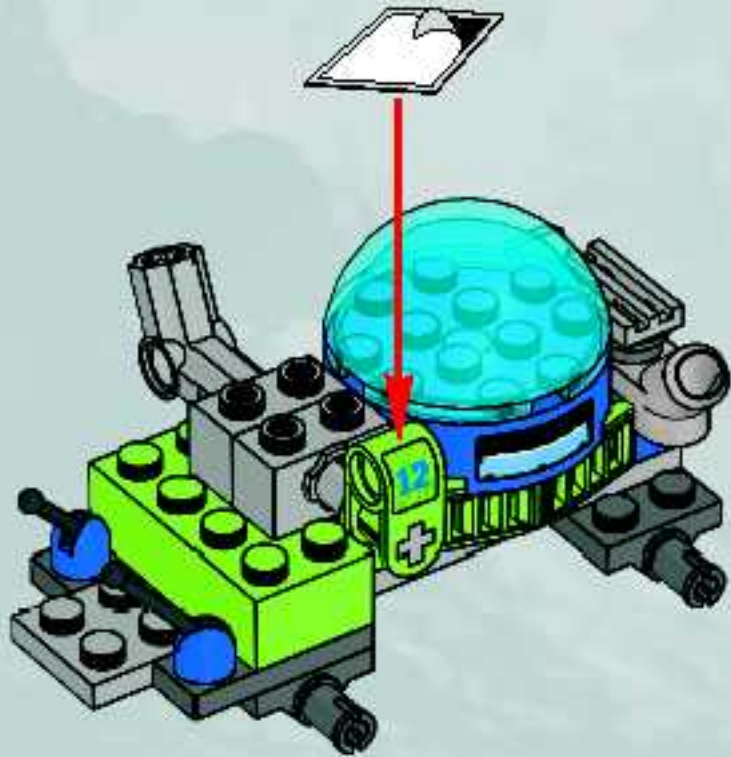

17

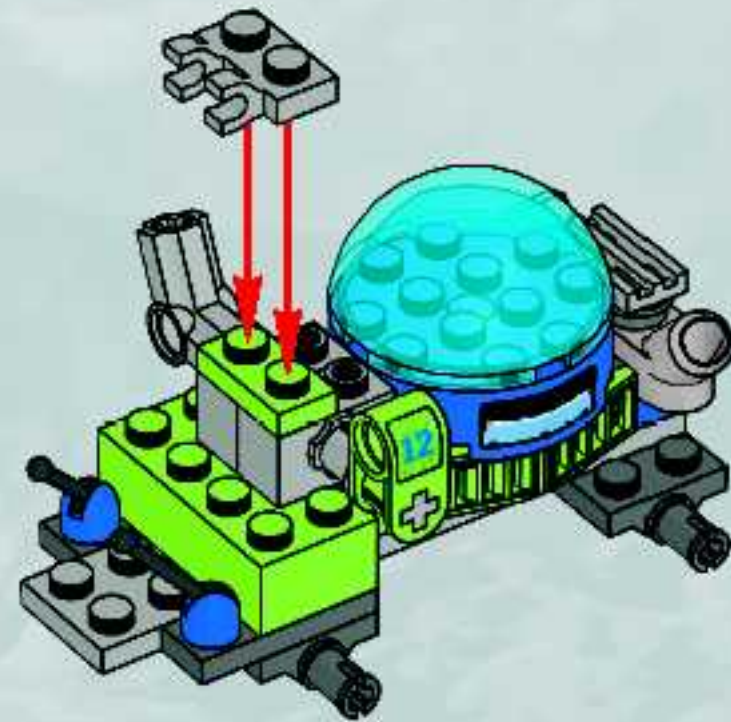





18

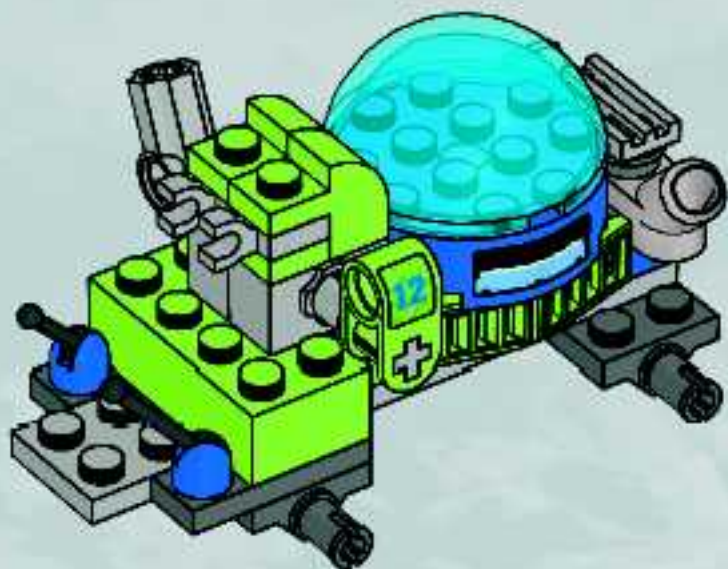

19



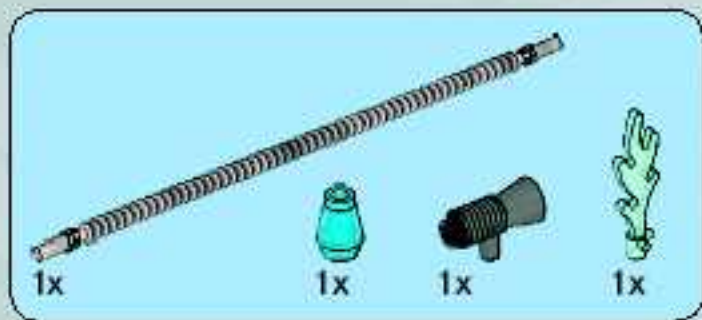

20

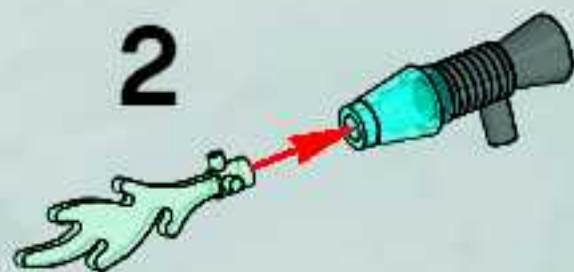
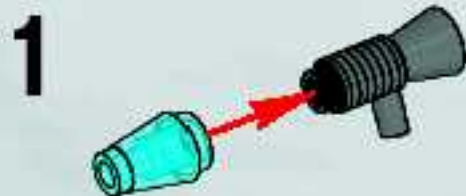



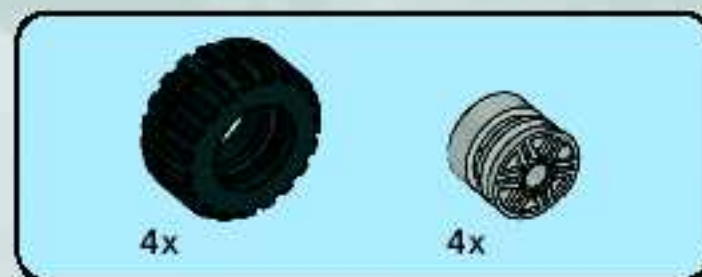
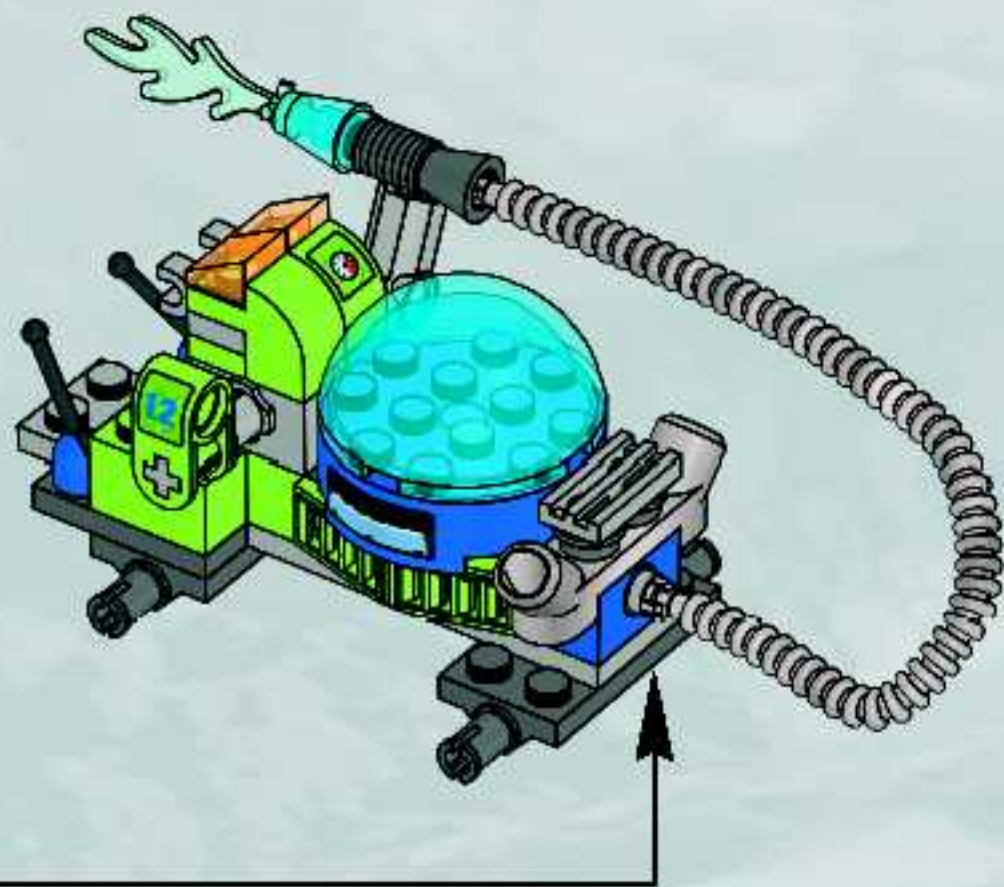

21

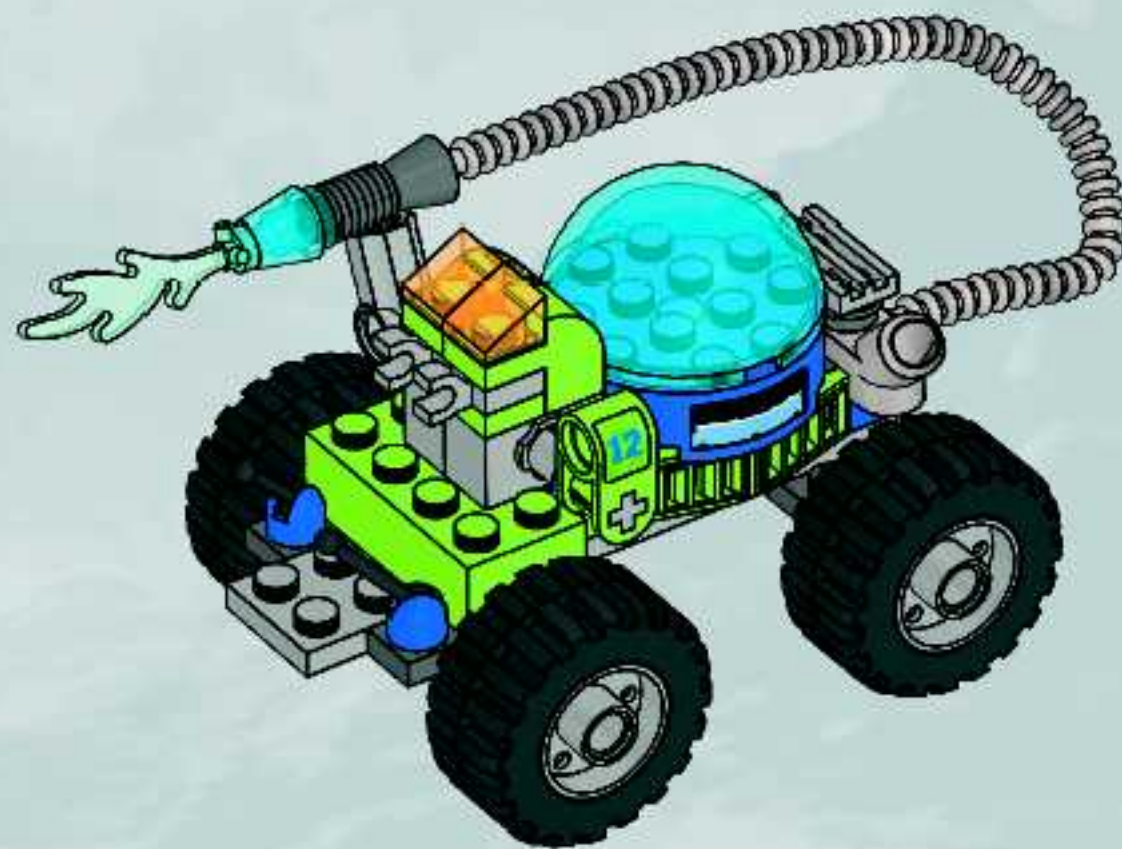

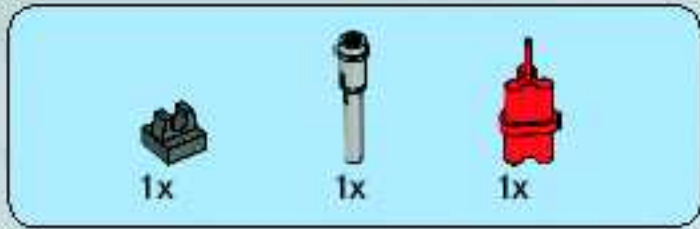

22

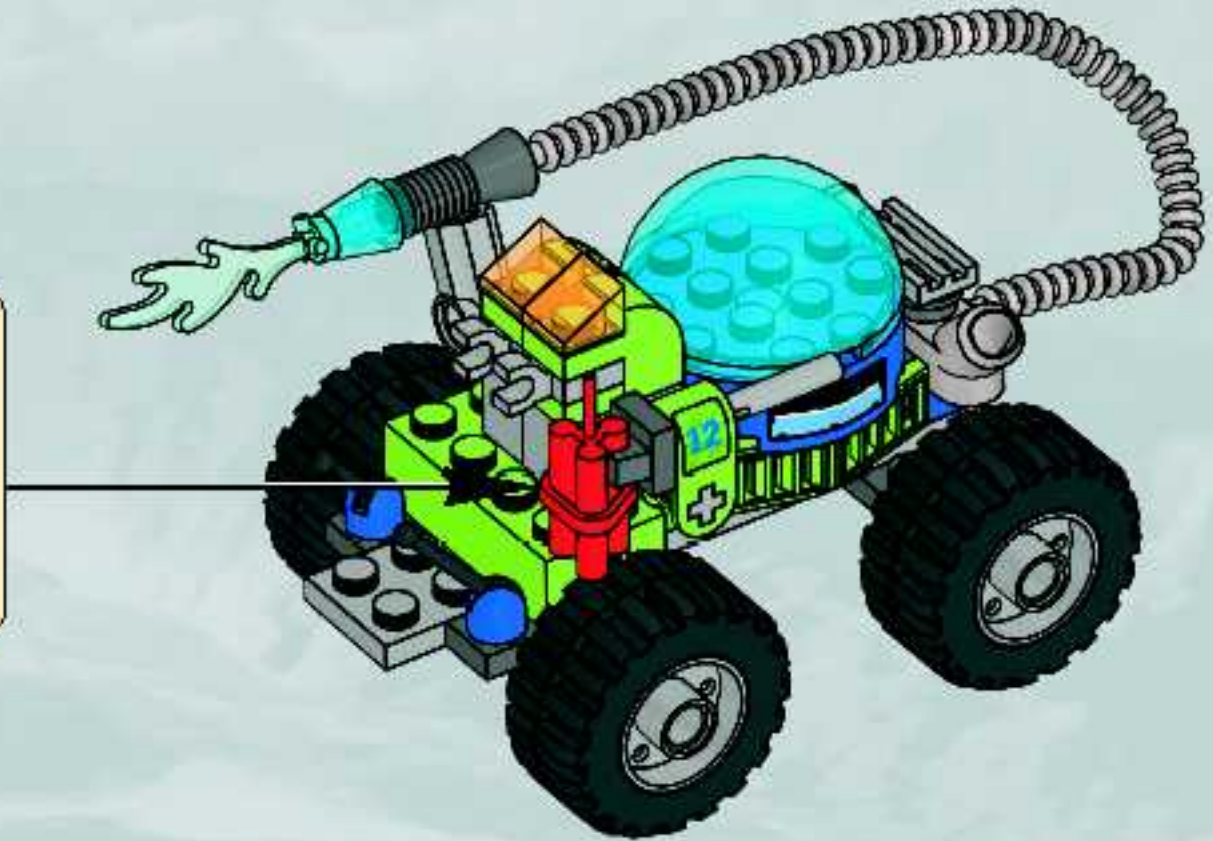
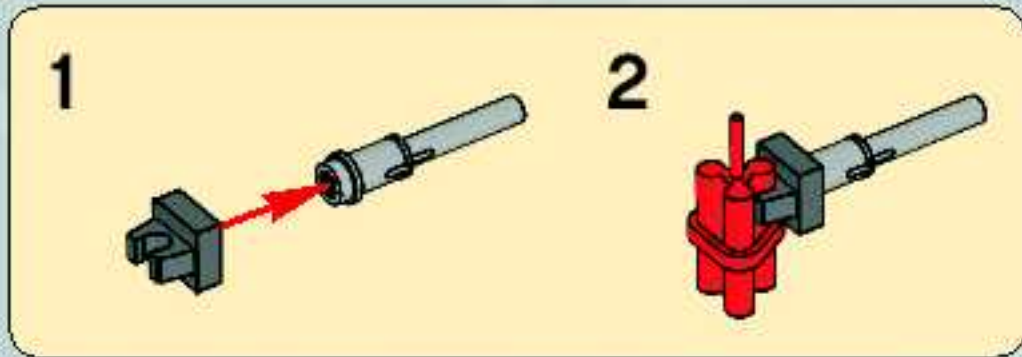





1



2





3

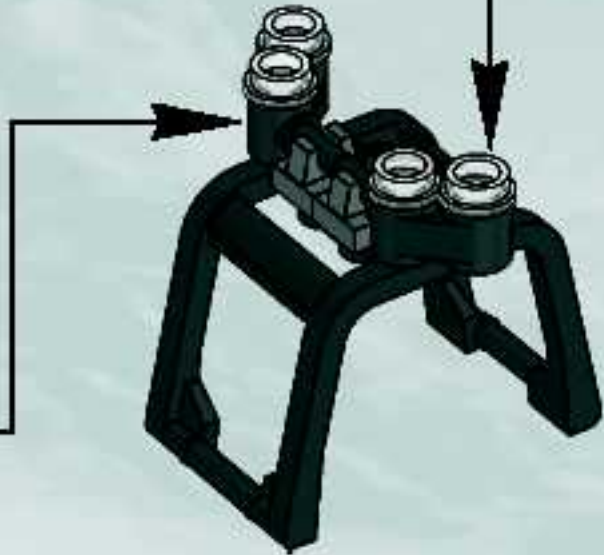
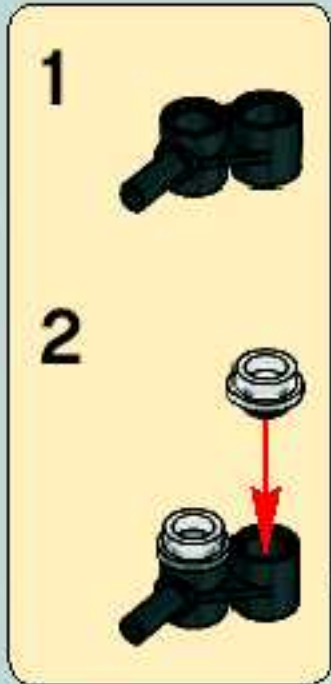
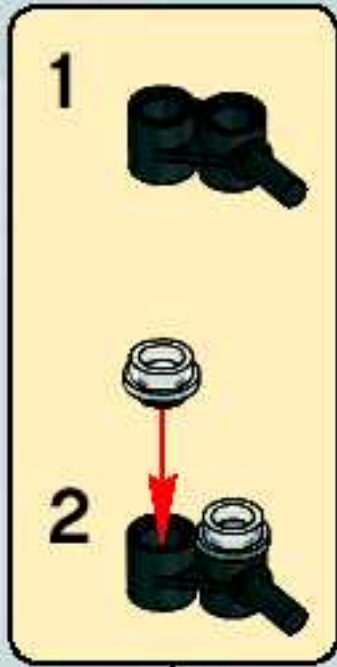

23

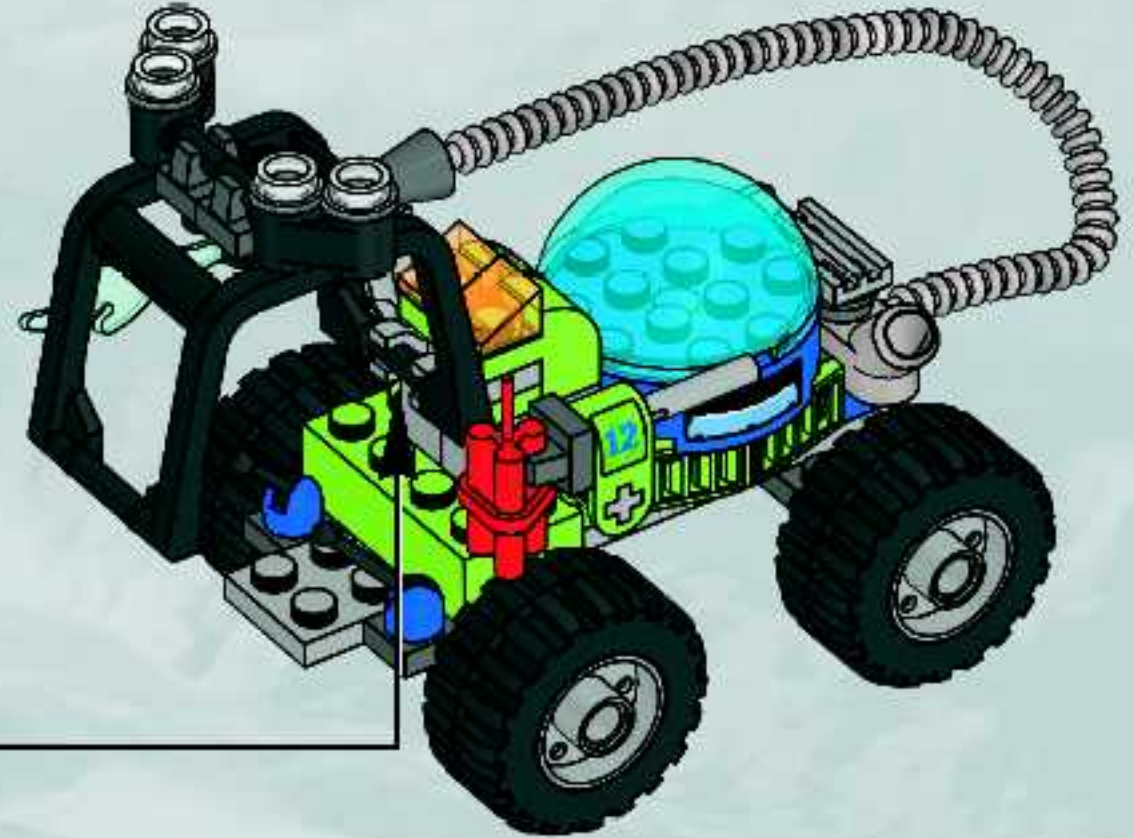



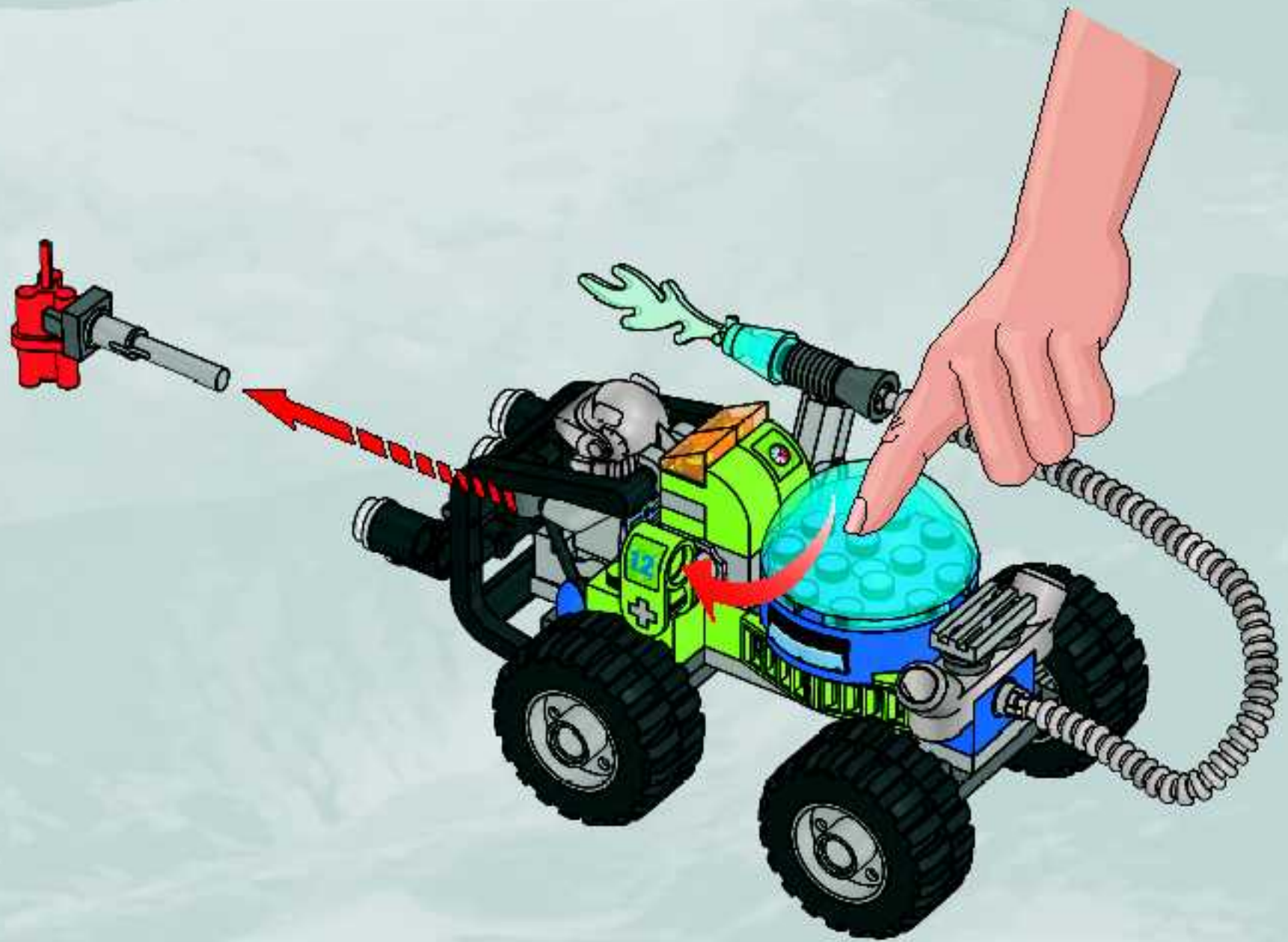



1x  
4538780



2x  
4562148



1x  
4155537



1x  
4164022

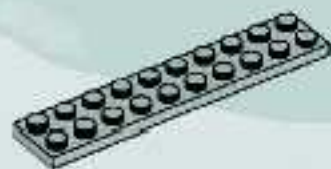

1x  
4211462



1x  
4561465



1x  
4567527



4x  
4140670



1x  
4567331



1x  
4165967



1x  
4520320



4x  
4299119



2x  
4210725



1x  
370023



1x  
4539385



1x  
4567520



4x  
4540385



1x  
4571223



1x  
4211350



2x  
4211133



2x  
4296152



1x  
4569353



2x  
4212446



1x  
4571238



1x  
4556157



3x  
4211069



4x  
3005740



2x  
4244369



1x  
4569374



1x  
4164037



1x  
4211622



1x  
4211551



2x  
4509884



1x  
4578028



1x  
4261453



2x  
4233493



1x  
4542169



2x  
4210633



Customer Service

Kundenservice

Service Consommateurs

Servicio Al Consumidor

[www.lego.com/service](http://www.lego.com/service) or dial



00800 5346 5555 :



1-800-422-5346 :







LEGO

# POWER MINERS

[powerminers.LEGO.com](http://powerminers.LEGO.com)



*Infernox*



*Combustix*



*Firax*



*Eruptor*







8189











# WIN!

Go to [www.nielsen.com/LEGO](http://www.nielsen.com/LEGO)  
to fill out a survey for a chance  
to win a cool LEGO® Product.  
No purchase necessary.  
Open to all residents where not prohibited.



## [www.nielsen.com/LEGO](http://www.nielsen.com/LEGO)

### GEWINNE!

Nimm an der Umfrage auf  
[www.nielsen.com/](http://www.nielsen.com/)  
LEGO teil und hab die Chance ein cooles  
LEGO® Produkt zu gewinnen!

Die Teilnahme am Gewinnspiel führt zu keinerlei  
Kaufverpflichtungen. Teilnahme in allen nicht  
ausgeschlossenen Ländern möglich.

### WIN!

Ga naar [www.nielsen.com/LEGO](http://www.nielsen.com/LEGO),  
vul een enquêteformulier in en  
maak kans op een  
cool LEGO® product.

Geen aankoopverplichting.  
Iedereen mag deelnemen, uitgezonderd  
ingezetenden  
van landen waar een enquêteverbod geldt.

### GAGNE!

Visite [www.nielsen.com/LEGO](http://www.nielsen.com/LEGO)  
pour répondre à un questionnaire  
et avoir une chance de gagner  
un produit LEGO® très cool!

Aucune obligation d'achat.  
Ouvert à tous les résidents des pays  
autorisés.

### 当てよう!

[www.nielsen.com/LEGO](http://www.nielsen.com/LEGO)  
にアクセスして、  
アンケートにご記入ください。  
当選者にはレゴ製品を  
差し上げます。

お買い上げの必要はありません。  
禁止されていない限り、すべての店舗にご利用いただけます。