

ATLANTIS

TREASURE

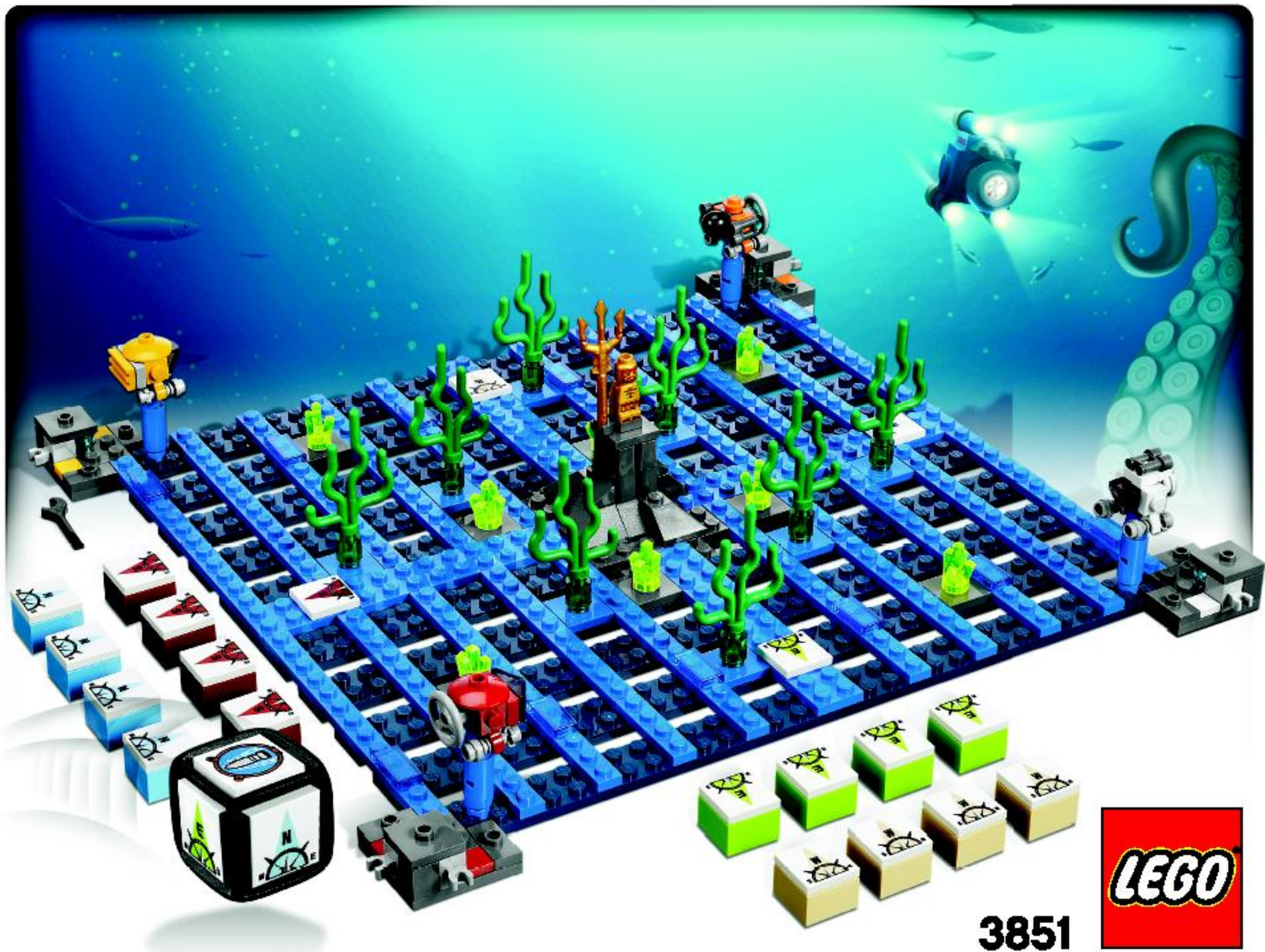

3851



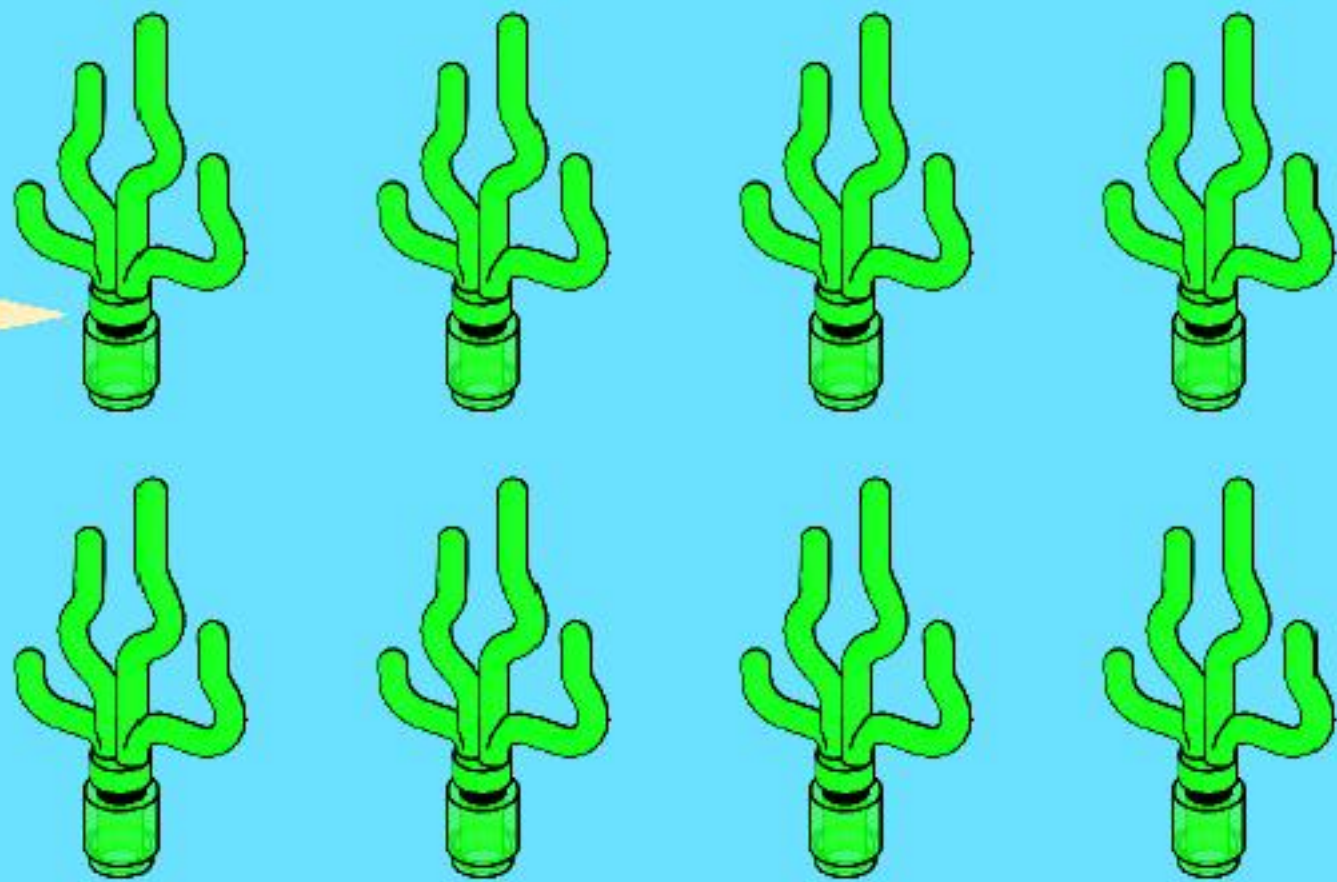
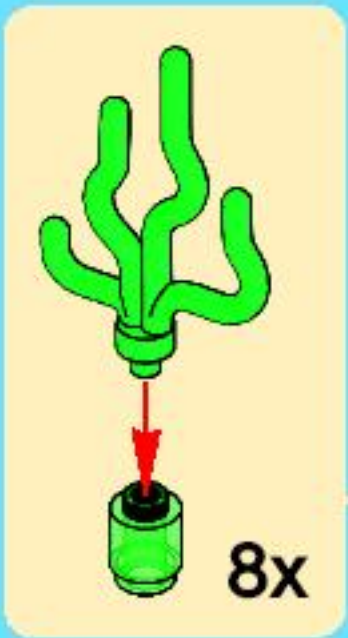
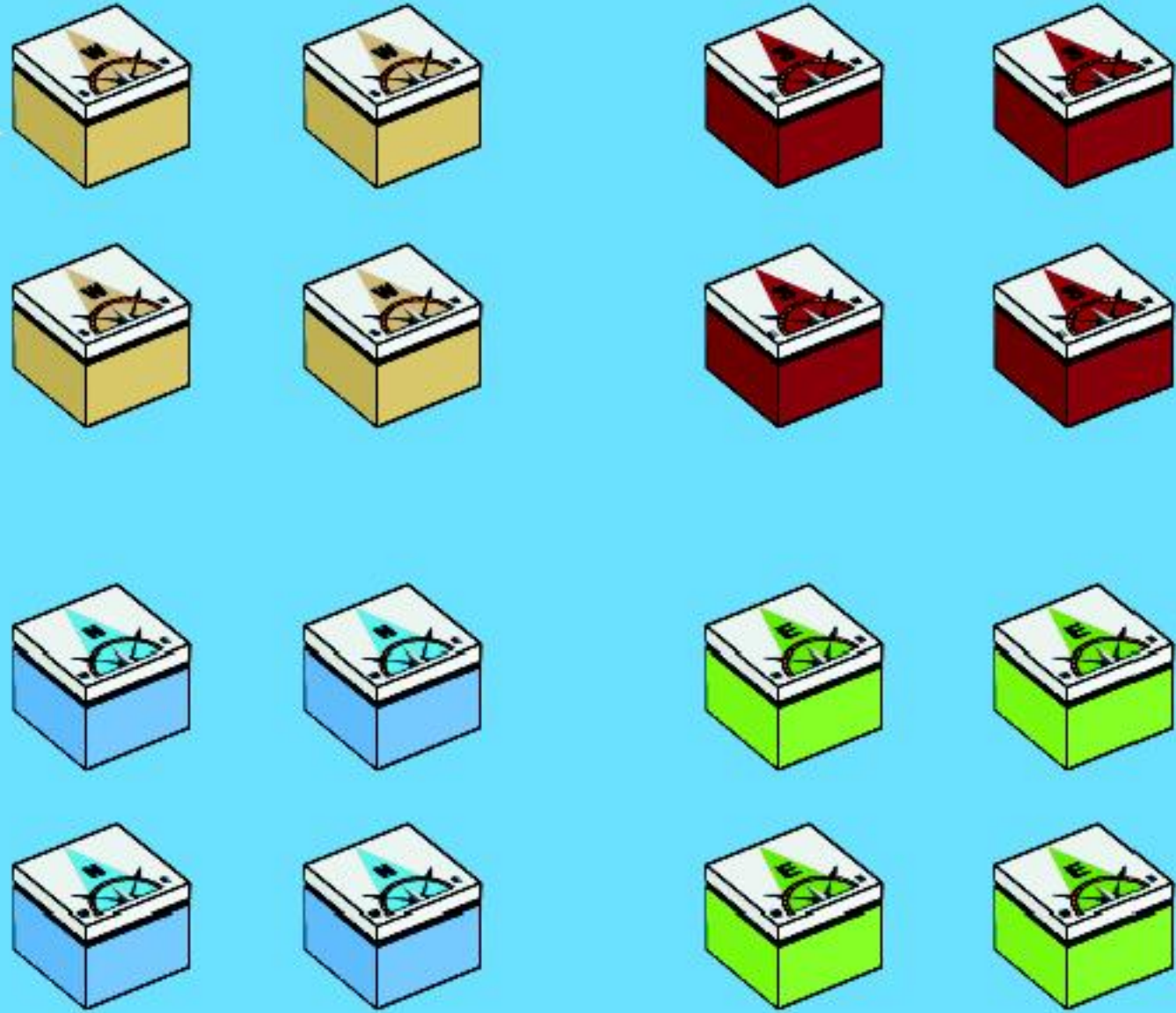
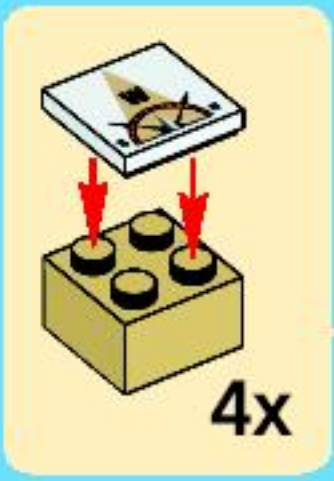

1



2



3



4



5

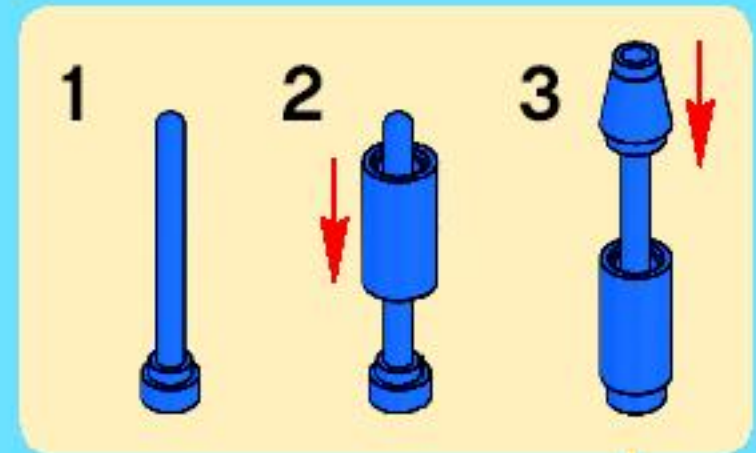

6



1



2



3



4



5



1



2

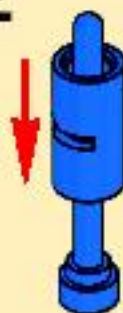

3



6



1



2



3



4



5



6

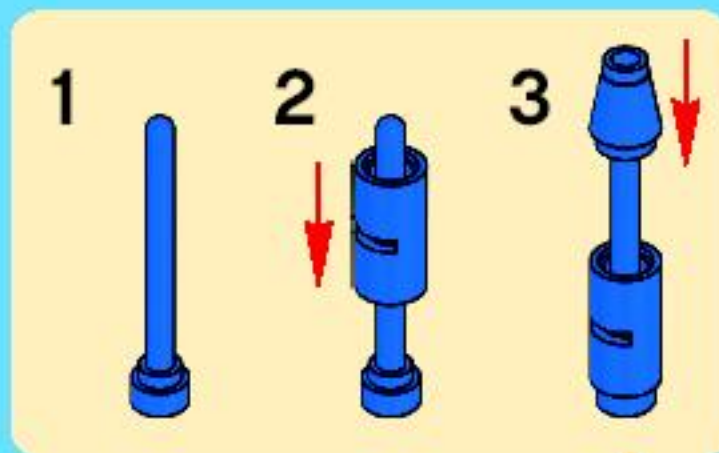

7



1



2



3

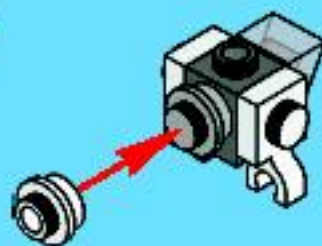

4



5



6

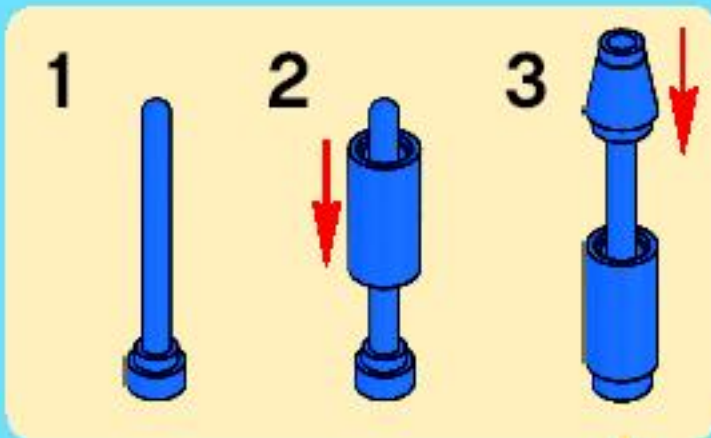

7



1



2

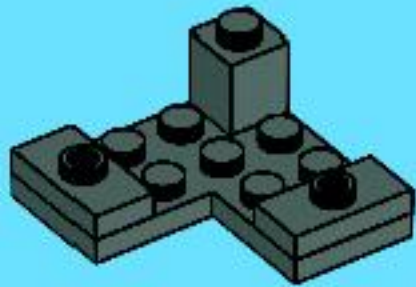

3

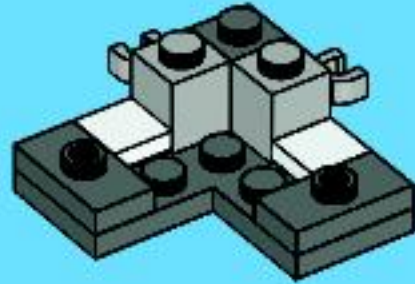

4

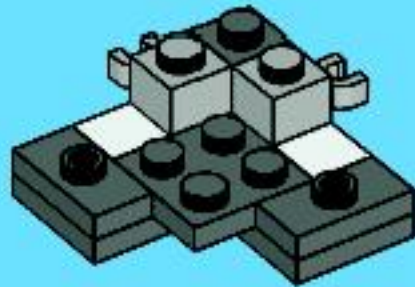

5

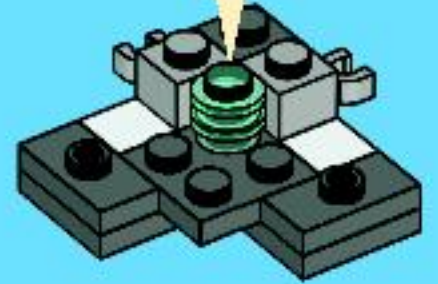

6

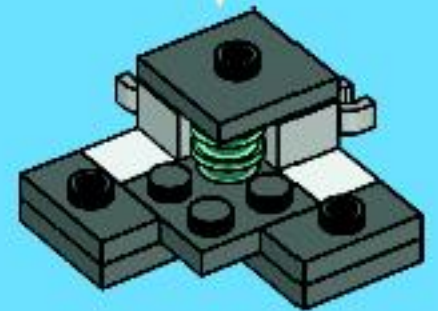
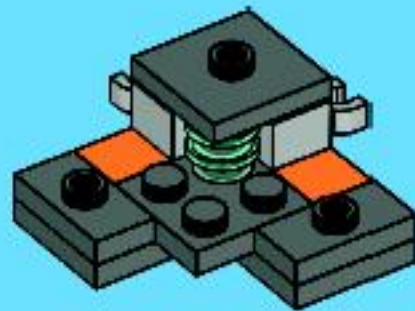
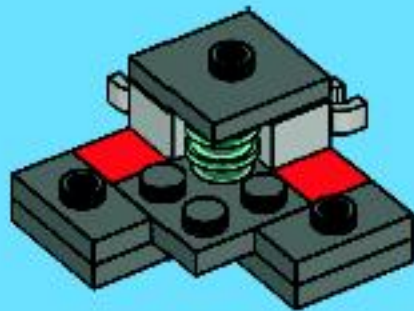
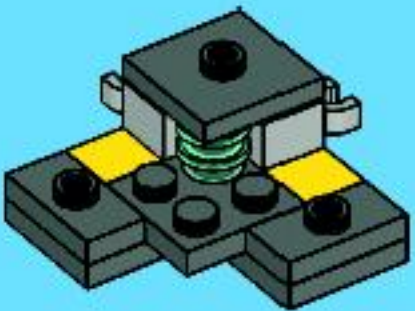
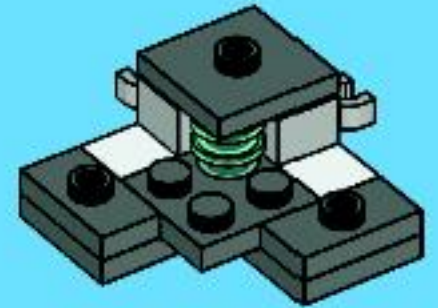



1

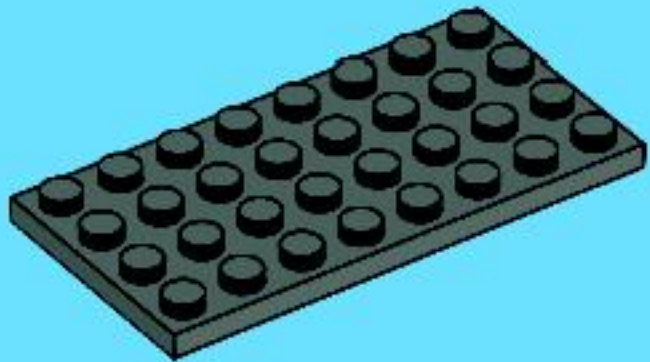

2

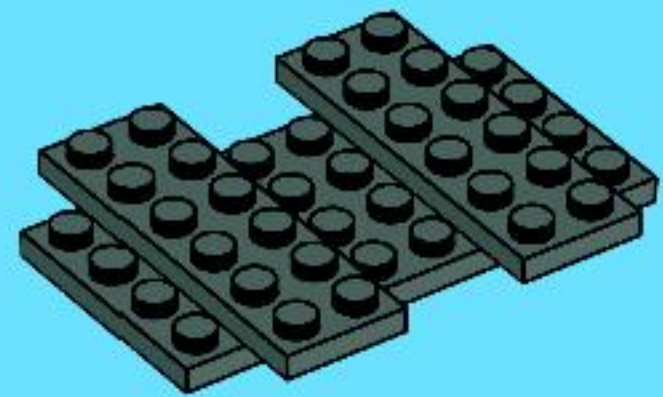

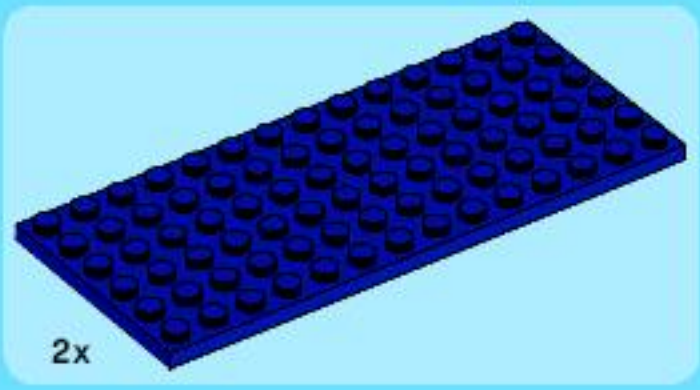

3

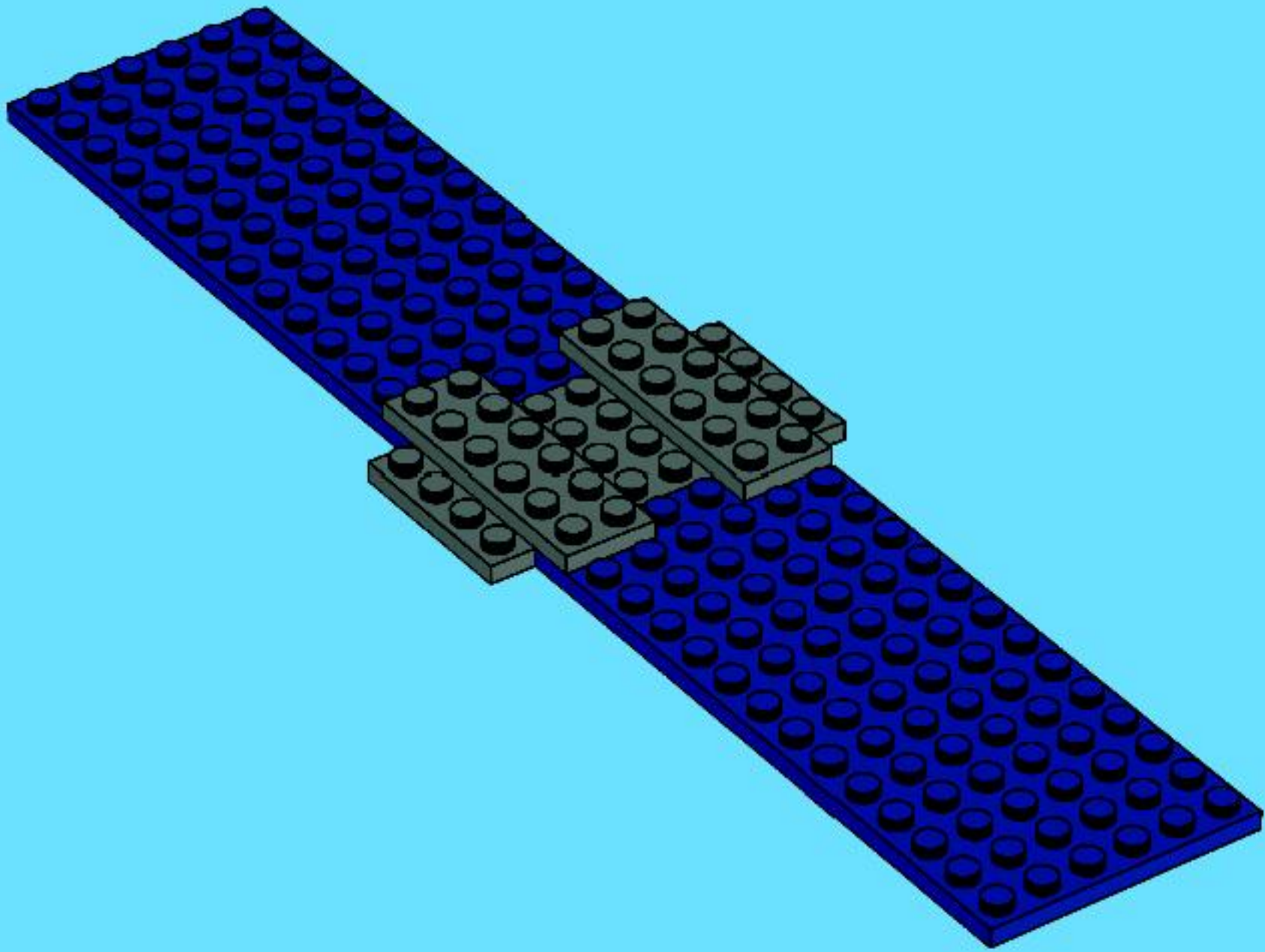

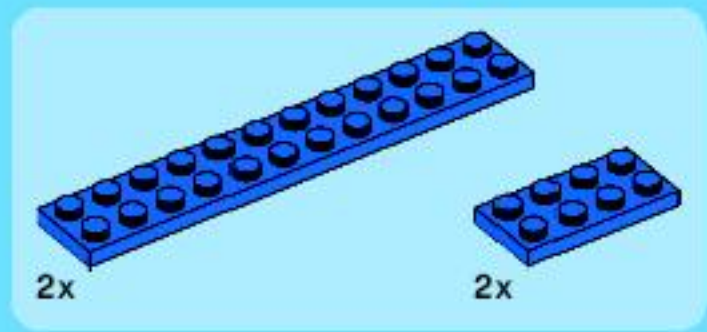

4

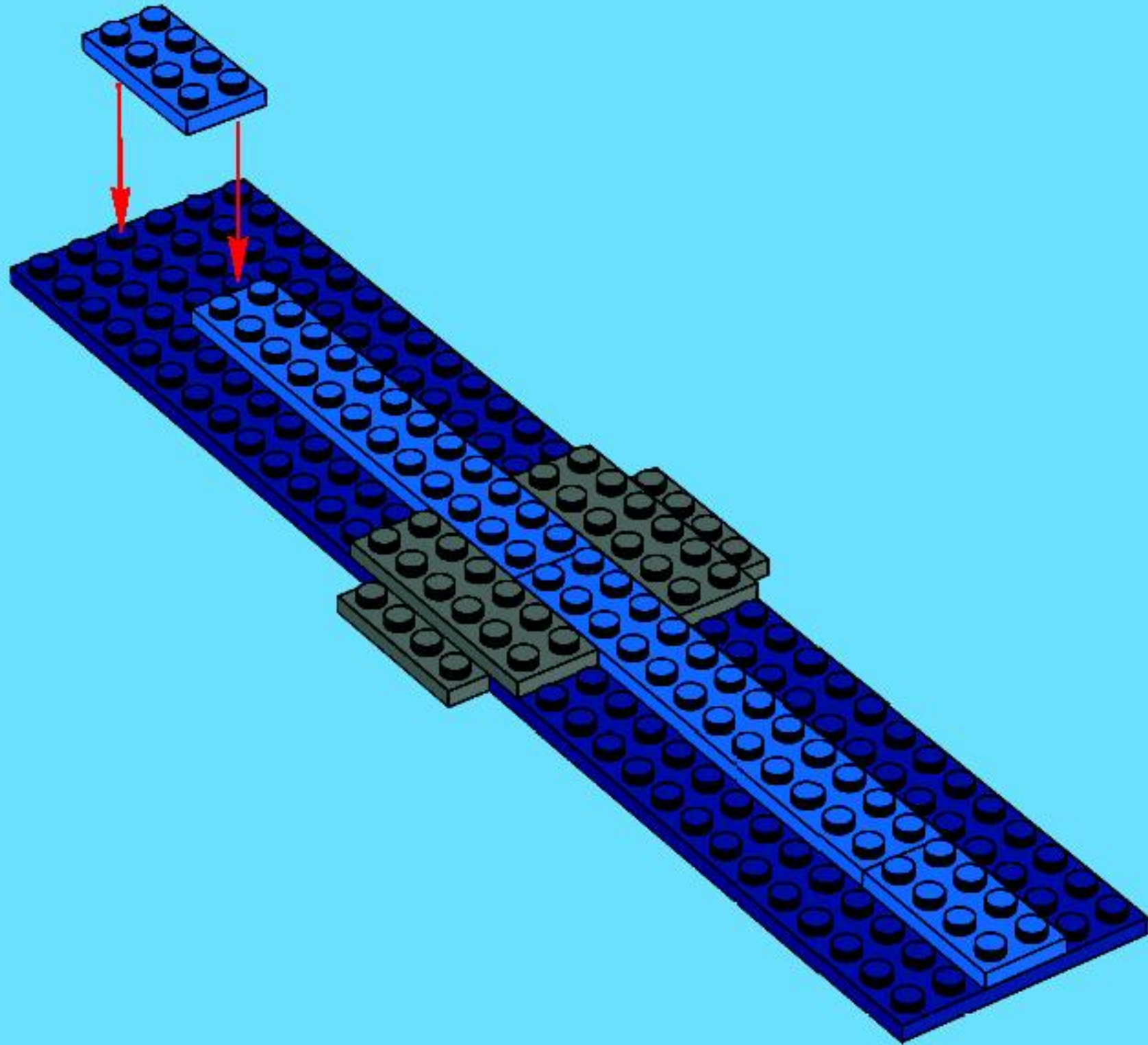

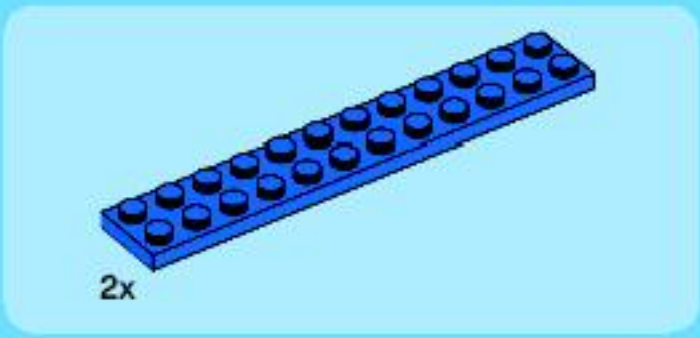

5

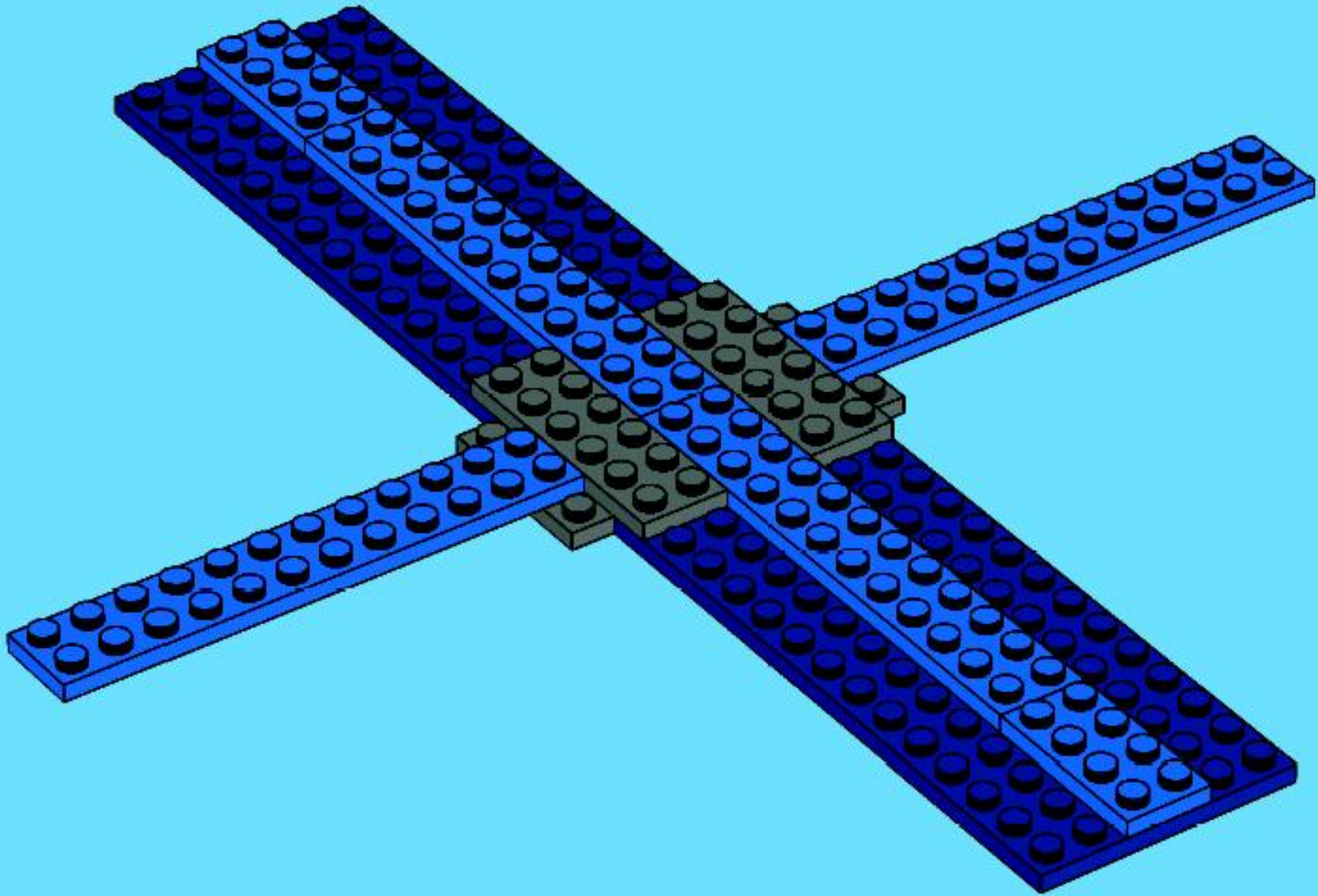

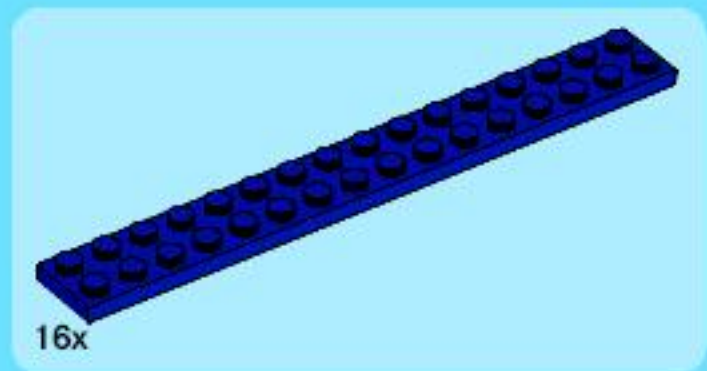

6

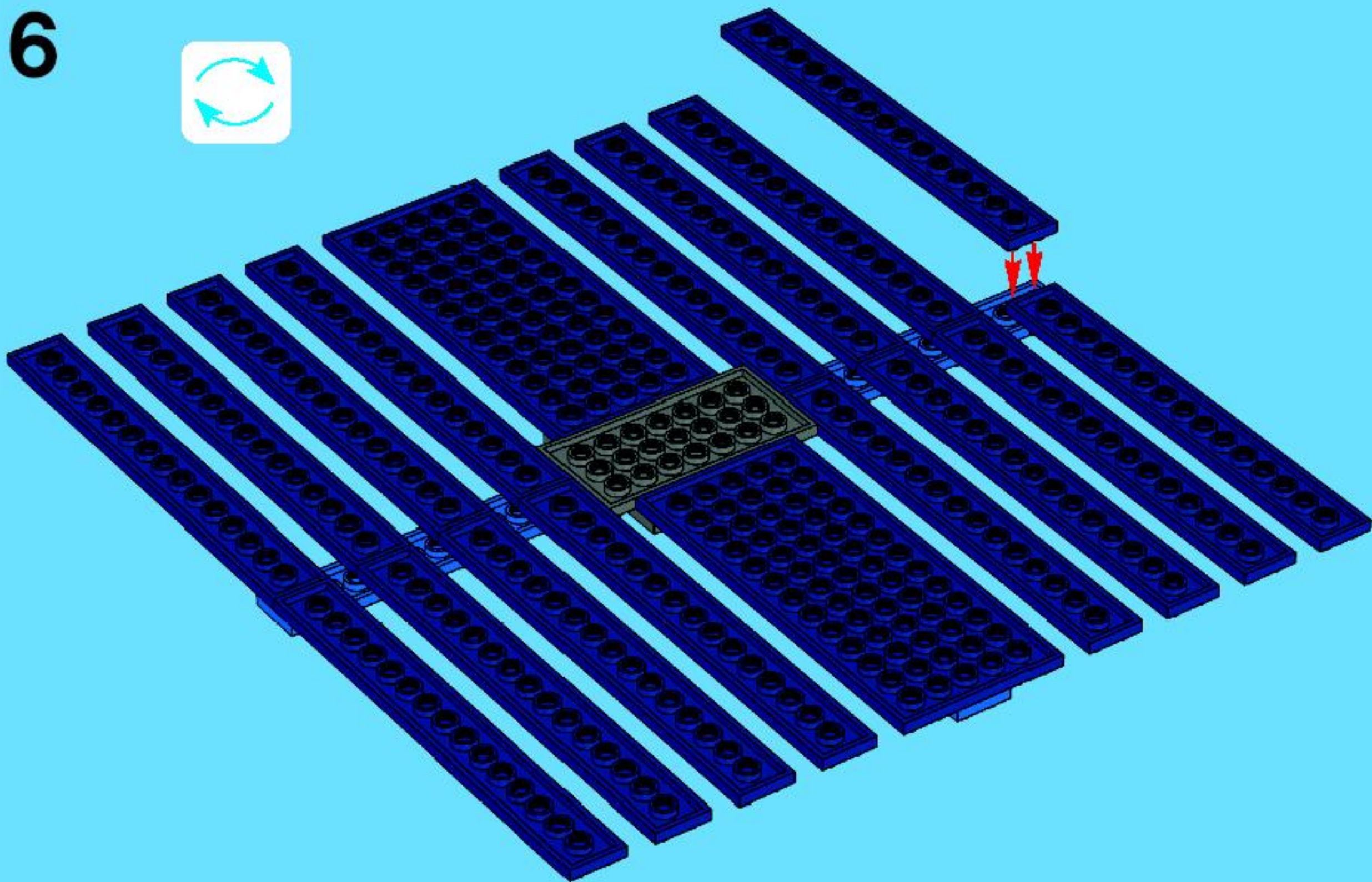

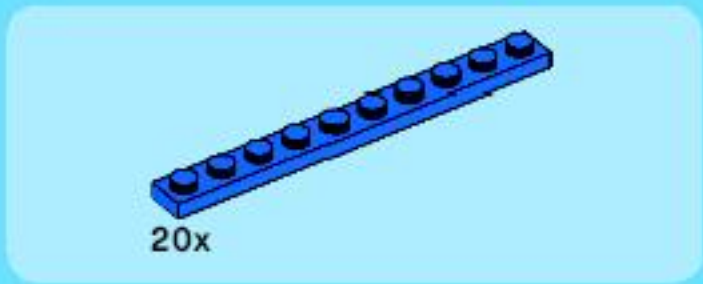

7

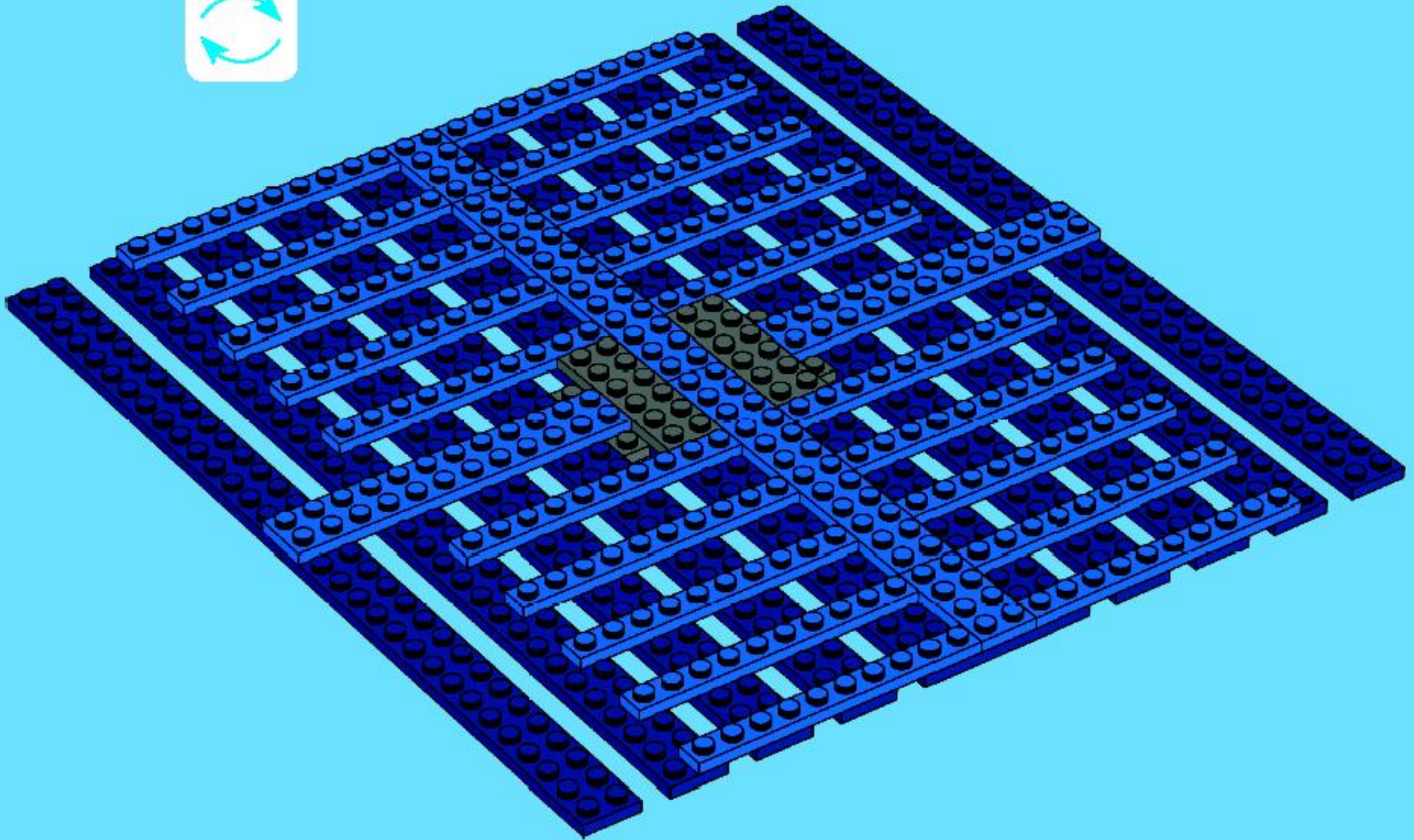



16x

8

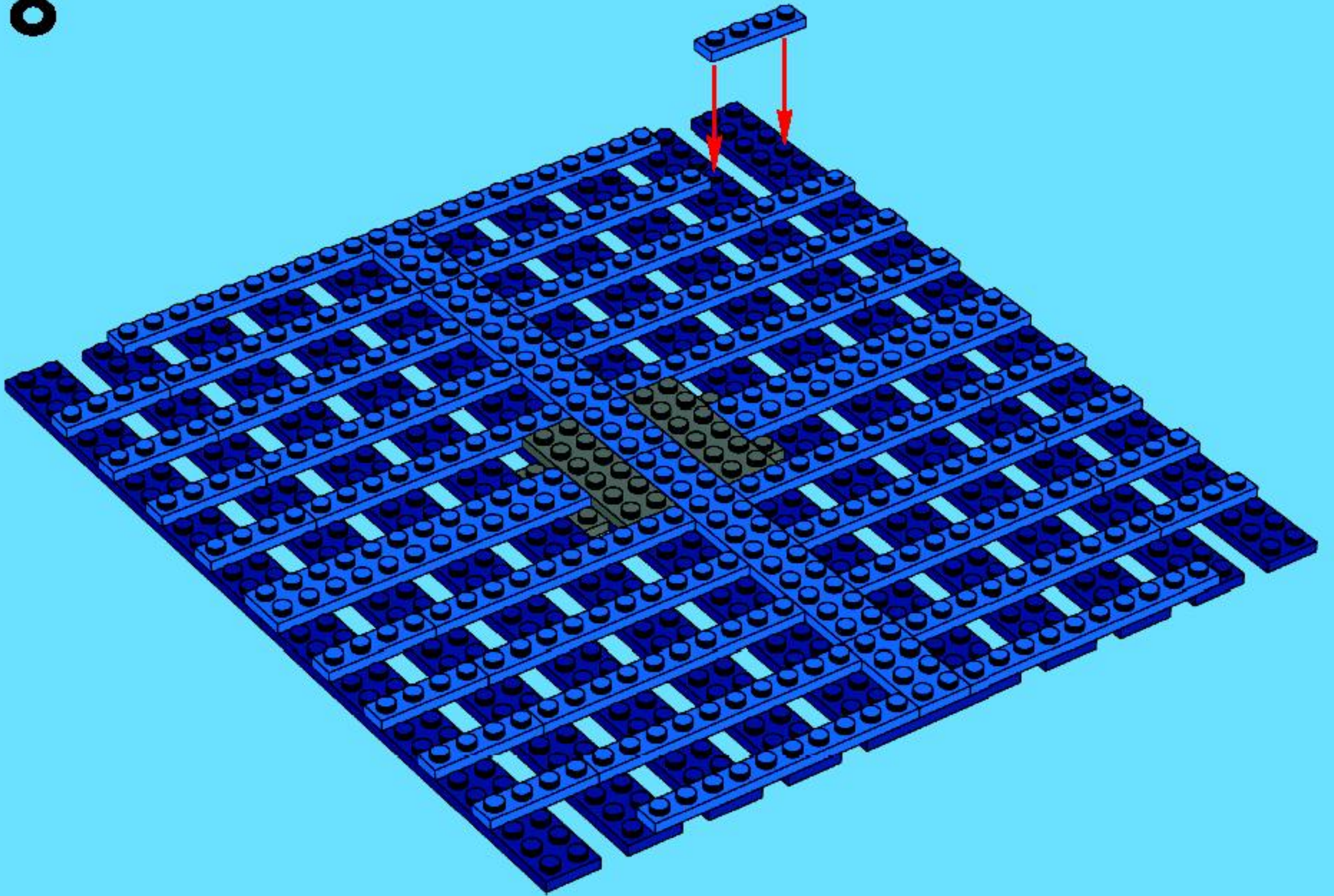



4x

9

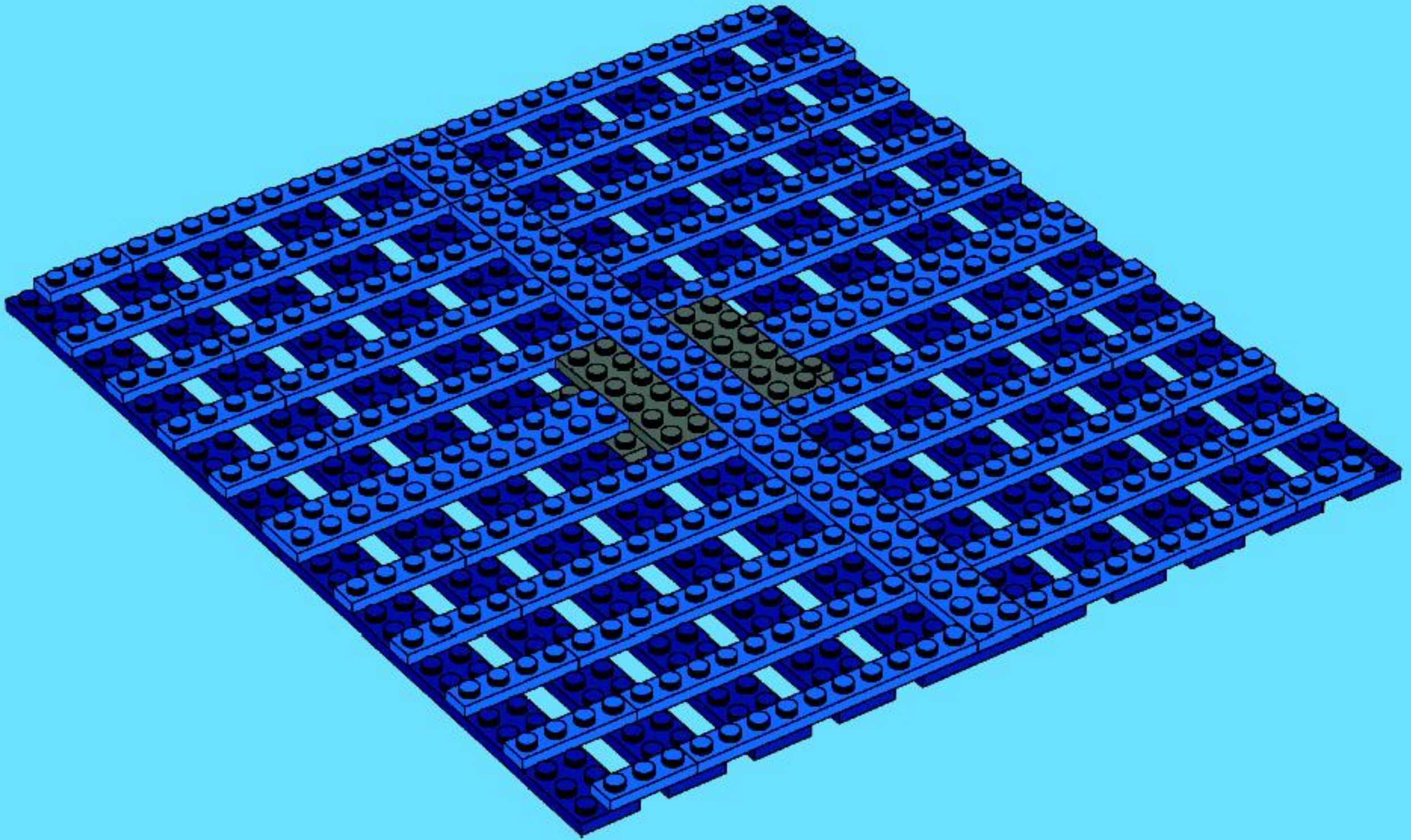



12x



1x

10

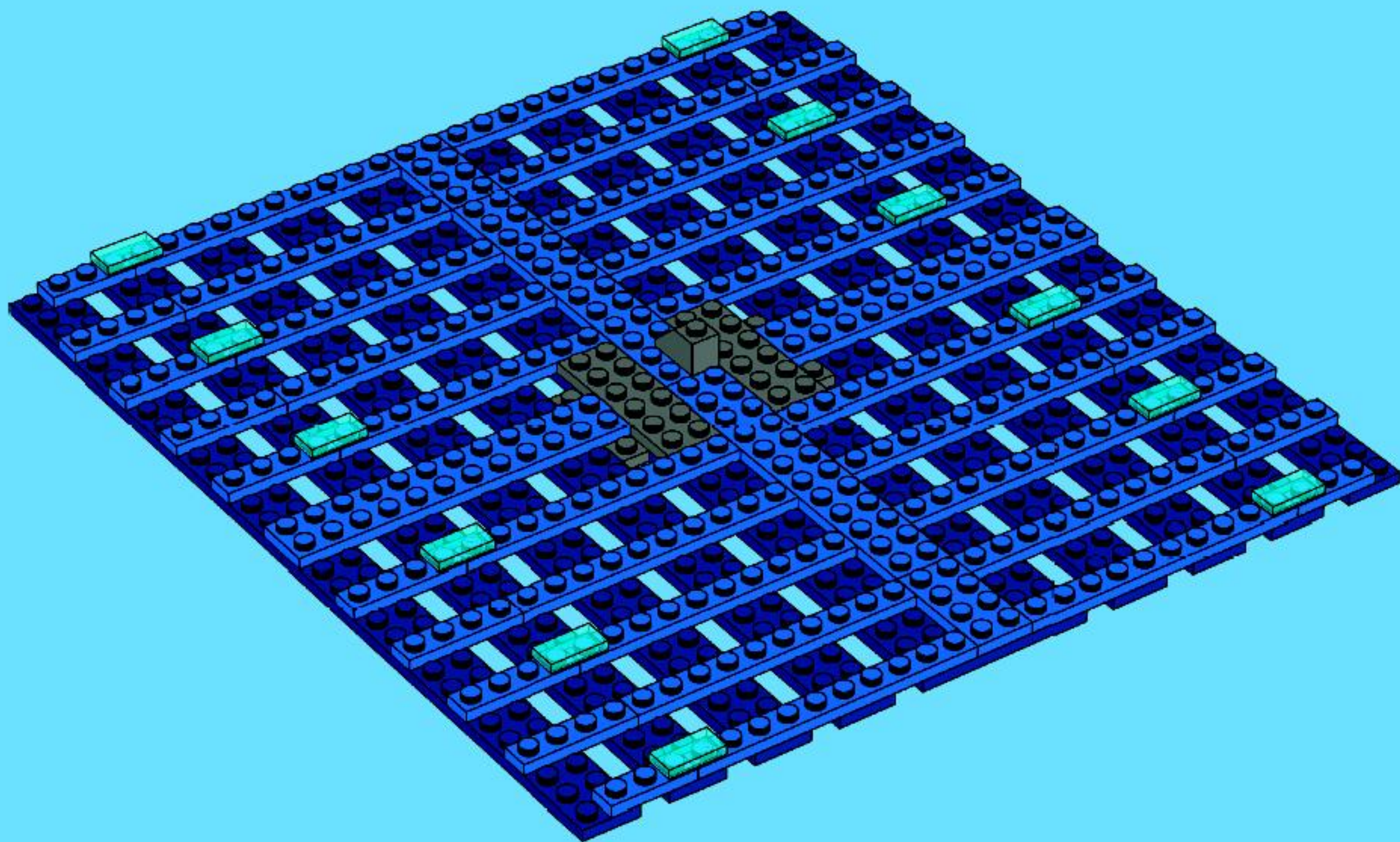



11

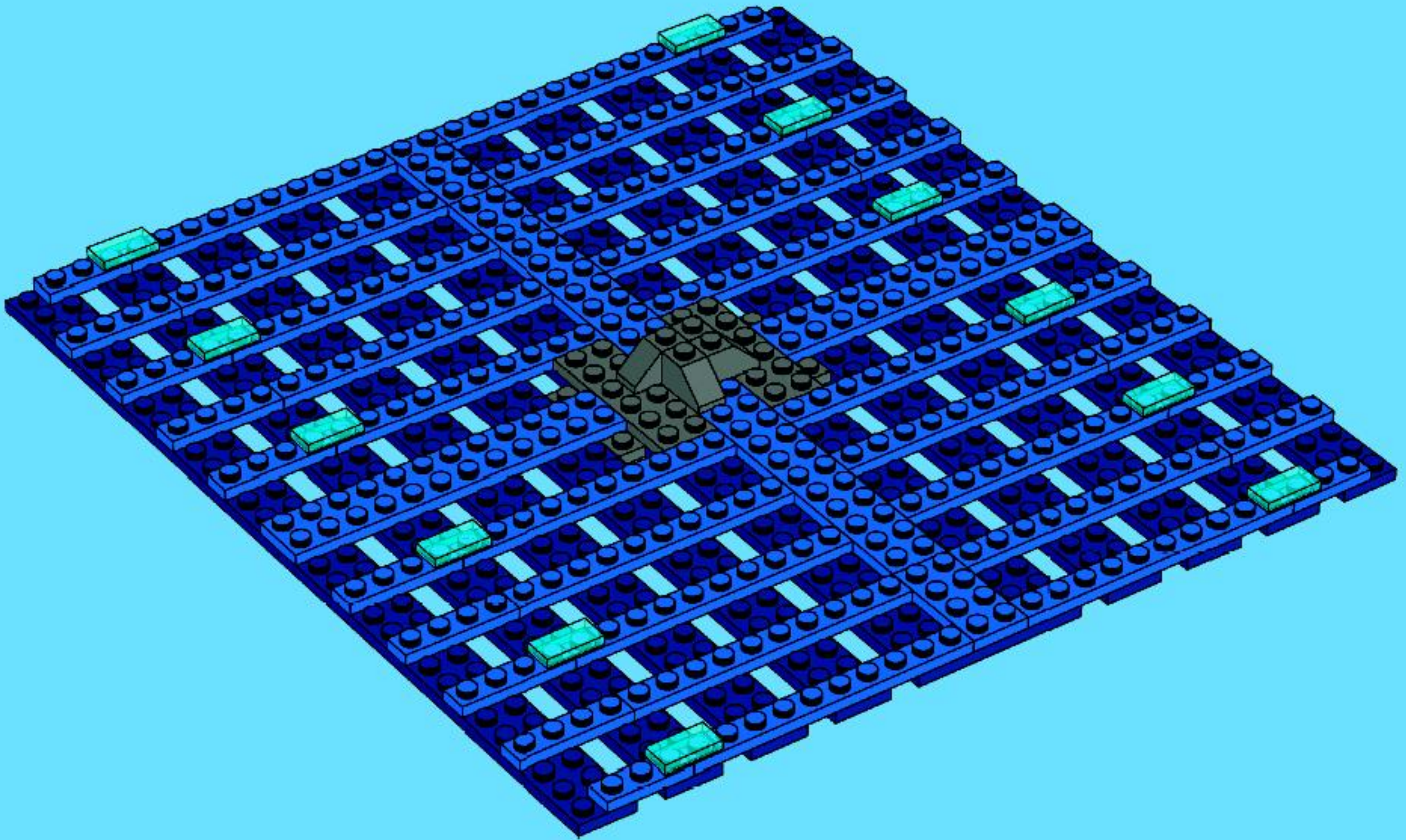



4x

12

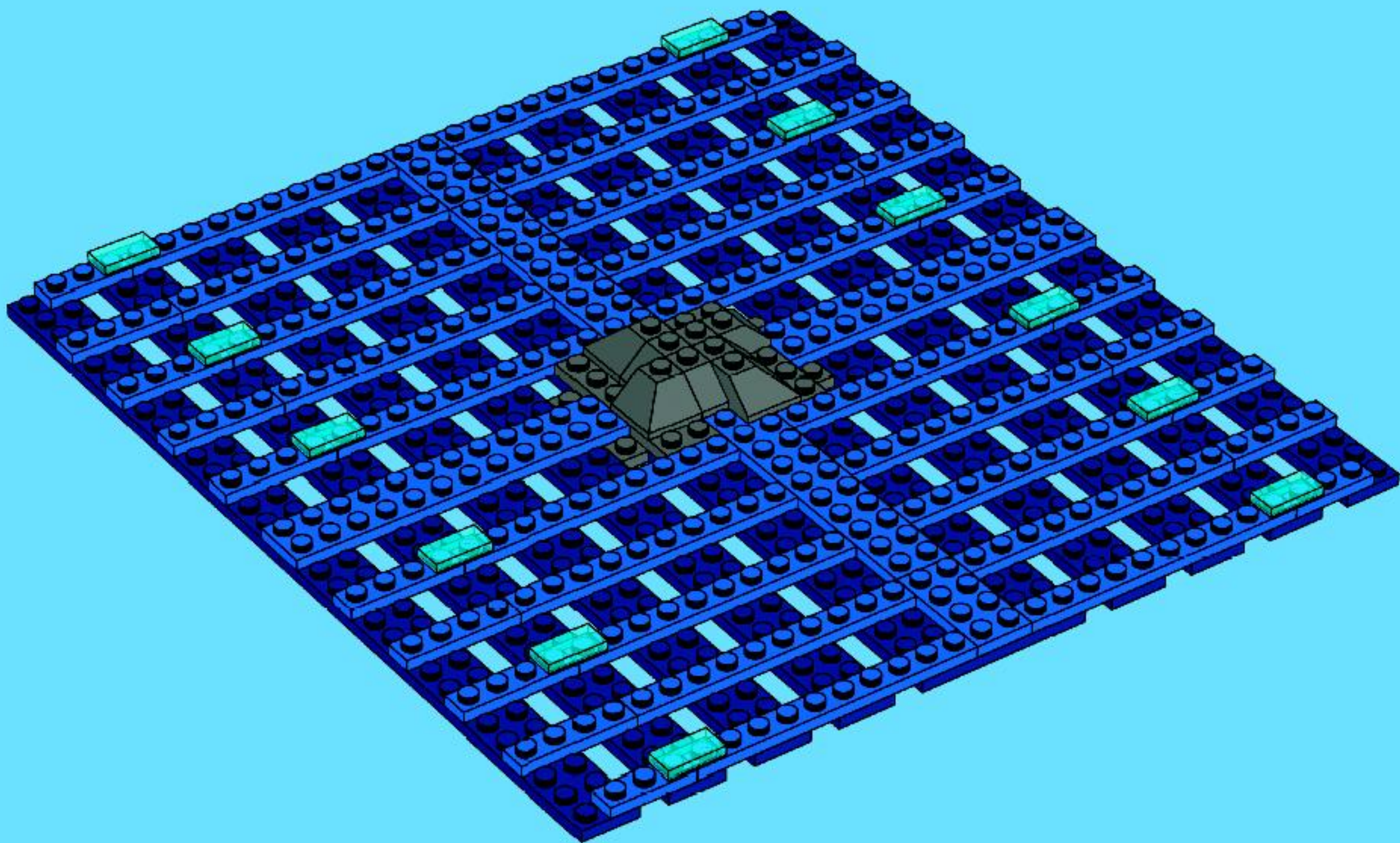



13

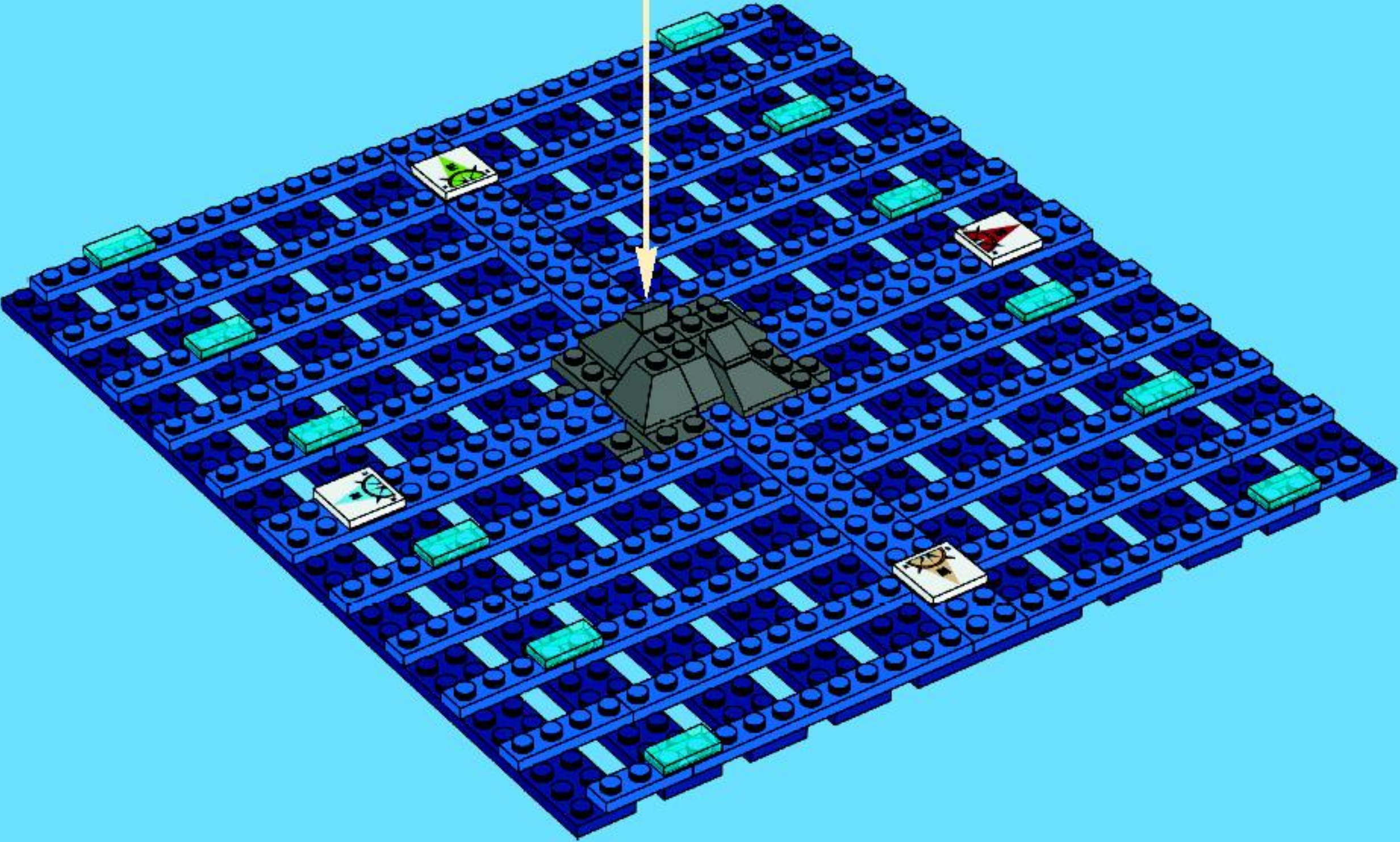



8x



8x

14

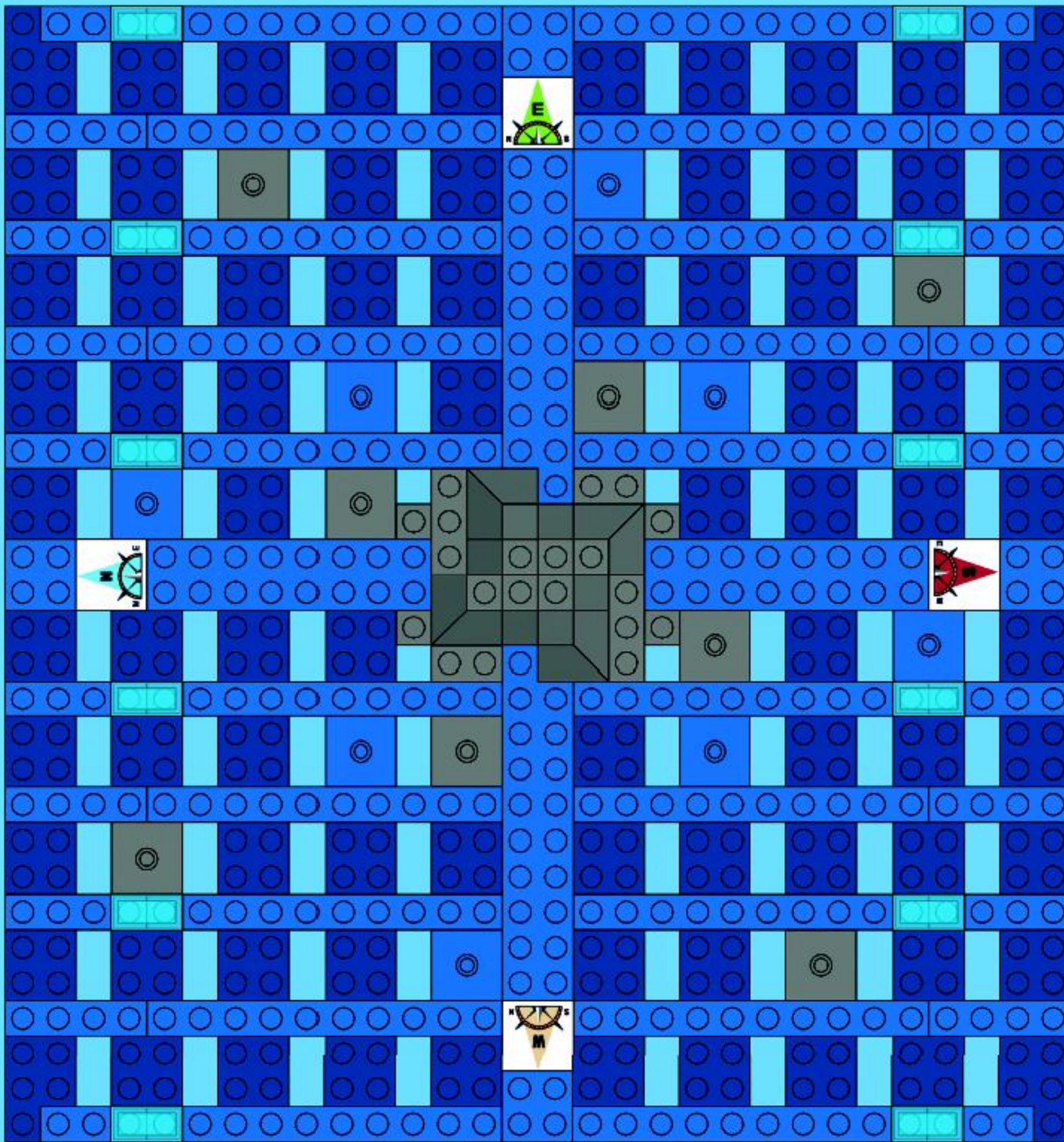

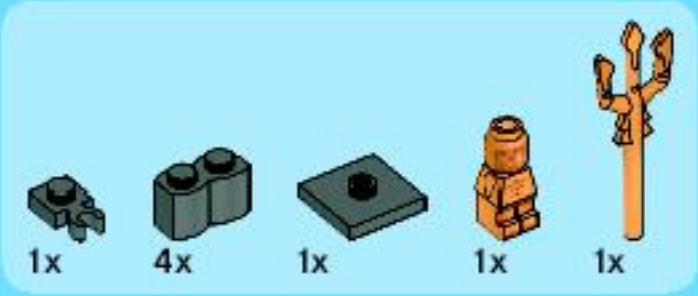

15

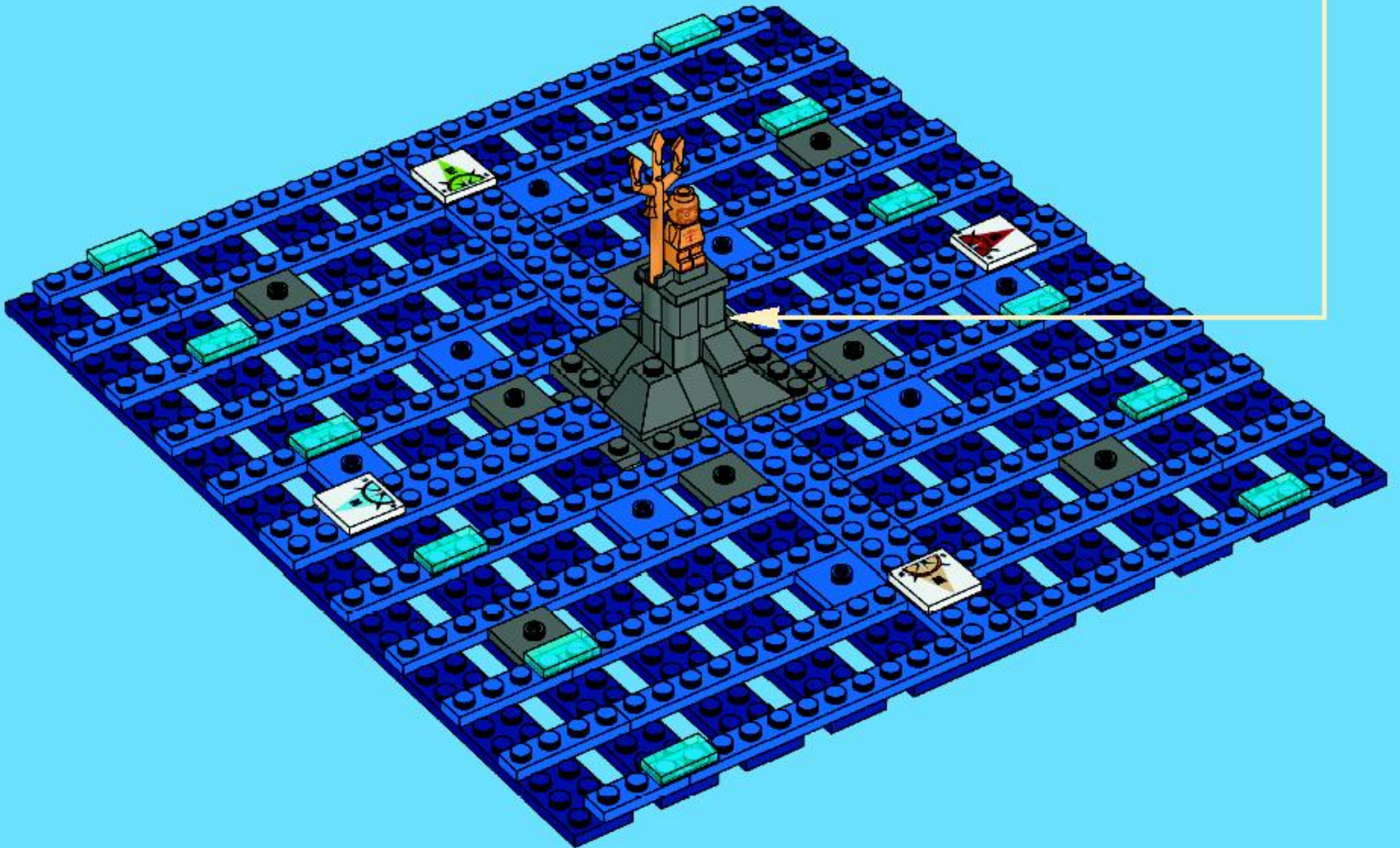
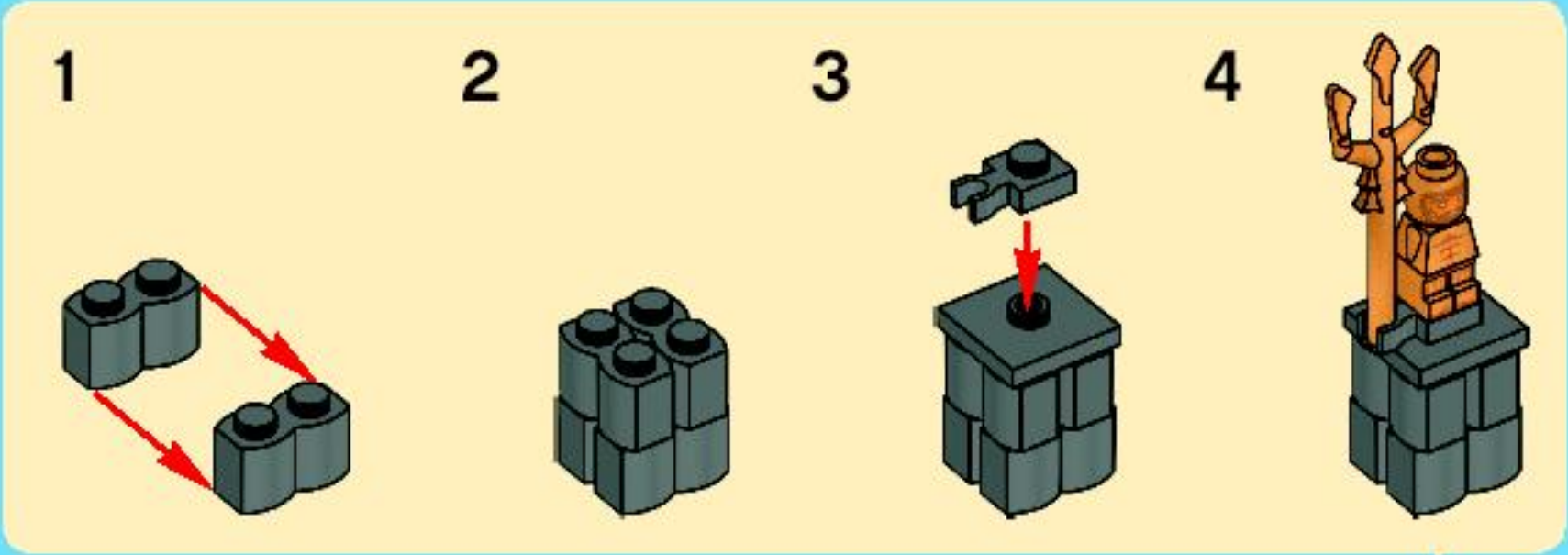



16

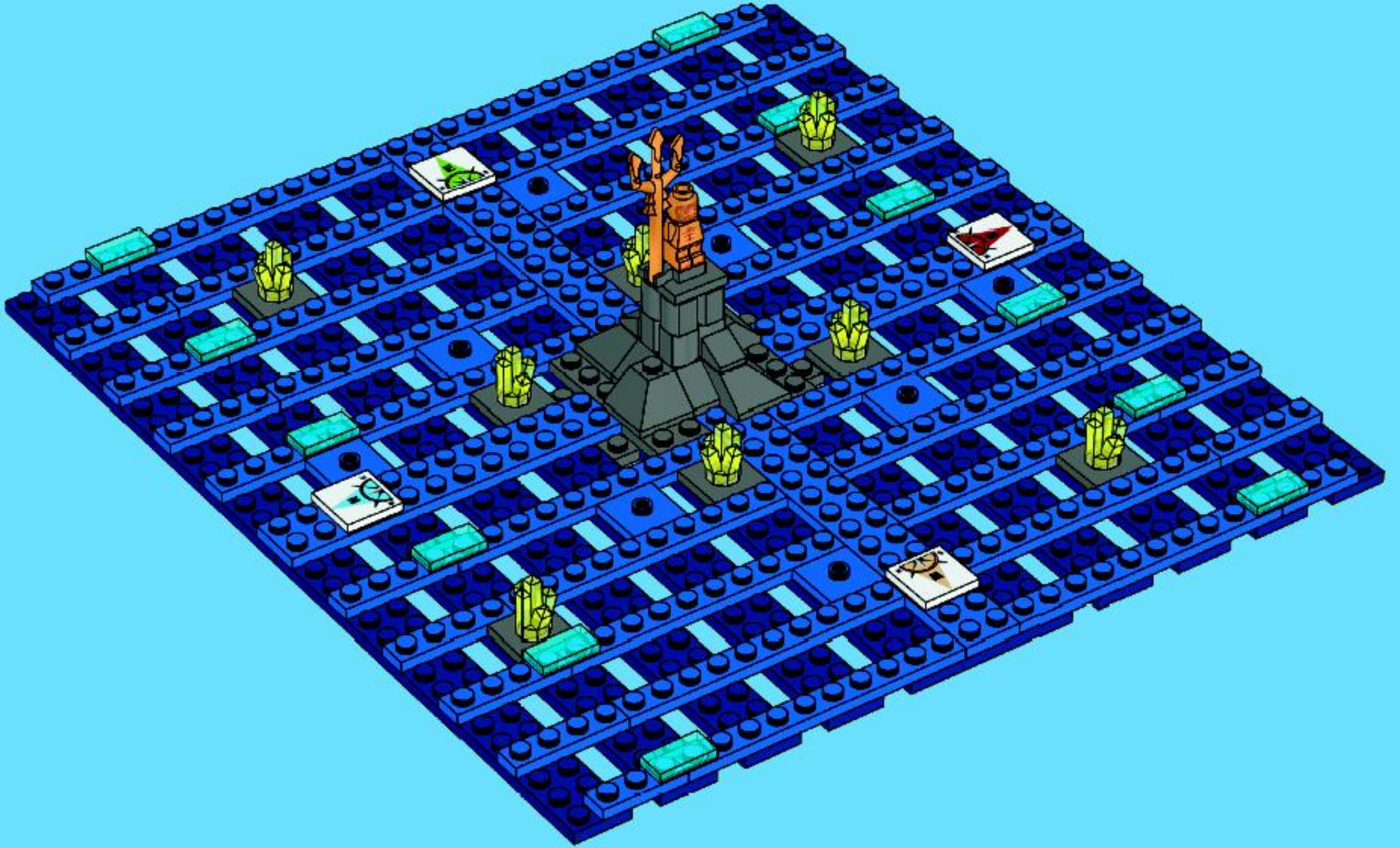

17

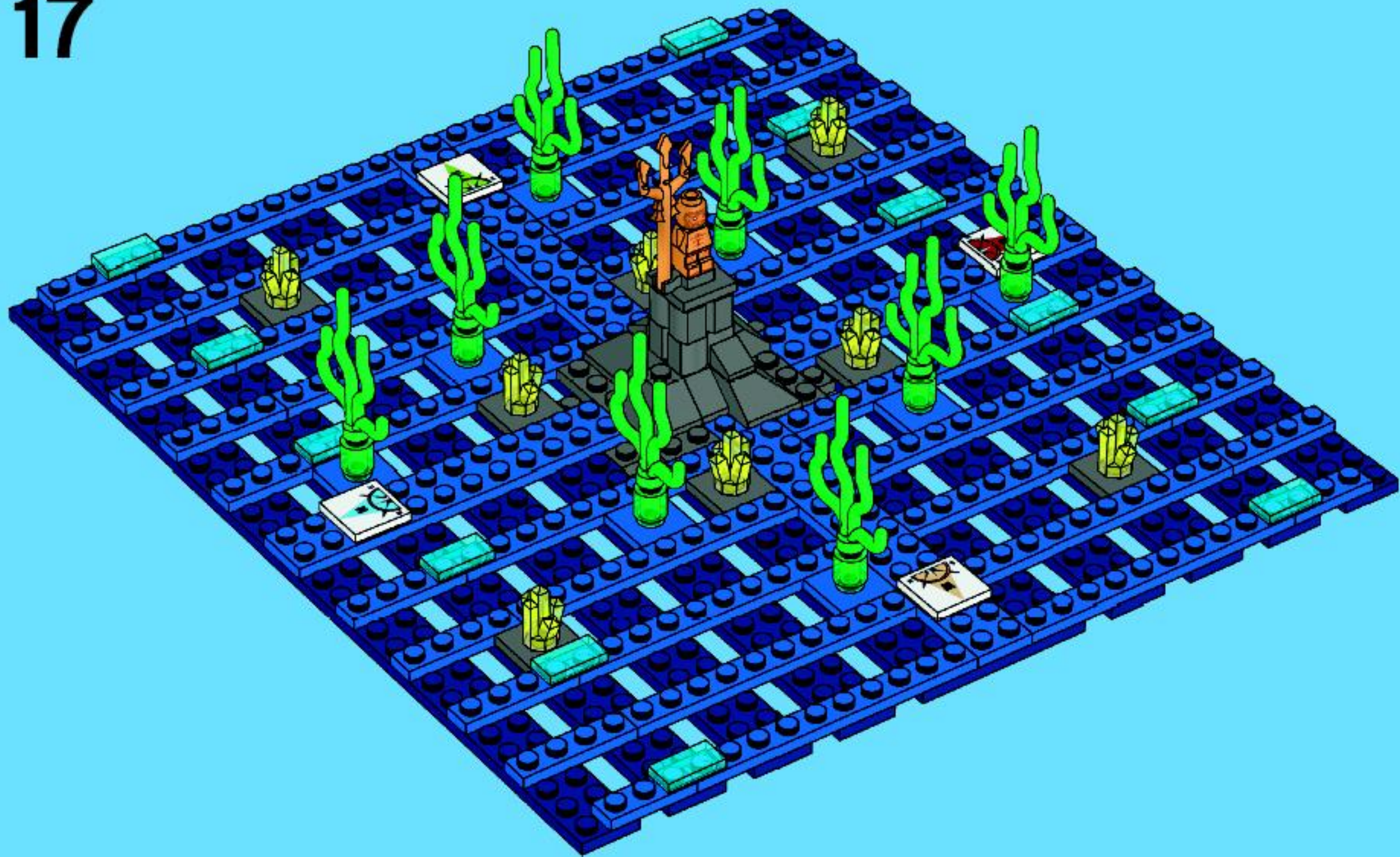

18



19







Customer Service

Kundenservice

Service Consommateurs

Servicio Al Consumidor

www.lego.com/service or dial



: 00800 5346 5555

: 1-800-422-5346





3848
Pirate Plank
2-4 7+ 10-20



3849
Orient Bazaar
2-4 7+ 10-20



3862
Harry Potter™ Hogwarts™
2-4 8+ 20-40



games.LEGO.com



games.LEGO.COM





Harry Potter™ HOGWARTS™



3862
Harry Potter™ Hogwarts™



2-4



8+



20-40



TM & © Warner Bros. Entertainment Inc.
(©10)



WIN!

Go to www.nielsen.com/LEGO
to fill out a survey for a chance
to win a cool LEGO® Product.
No purchase necessary.
Open to all residents where not prohibited.



www.nielsen.com/LEGO

GEWINNE! WIN!

Nimm an der Umfrage auf
www.nielsen.com/LEGO
teil und hab die Chance ein cooles
LEGO® Produkt zu gewinnen!

Die Teilnahme am Gewinnspiel führt zu keinerlei
Kaufverpflichtungen. Teilnahme in allen nicht
ausgeschlossenen Ländern möglich.

4598887

Ga naar www.nielsen.com/LEGO,
vul een enquêteformulier in en
maak kans op een
cool LEGO® product.

Geen aankoopverplichting.
Iedereen mag deelnemen, uitgezonderd
ingezetenden
van landen waar een enquêteverbod geldt.

GAGNE! 当てよう!

Visite www.nielsen.com/LEGO
pour répondre à un questionnaire
et avoir une chance de gagner
un produit LEGO® très cool!

Aucune obligation d'achat.
Ouvert à tous les résidents des pays
autorisés.

www.nielsen.com/LEGOにアクセスして、アンケ
ートにご記入ください。当選者にはレゴ製品を
差し上げます。

お買い上げの必要はありません。

禁止されていない限り、すべての年齢にご利用いただけます。