



Kingdoms



7948



1

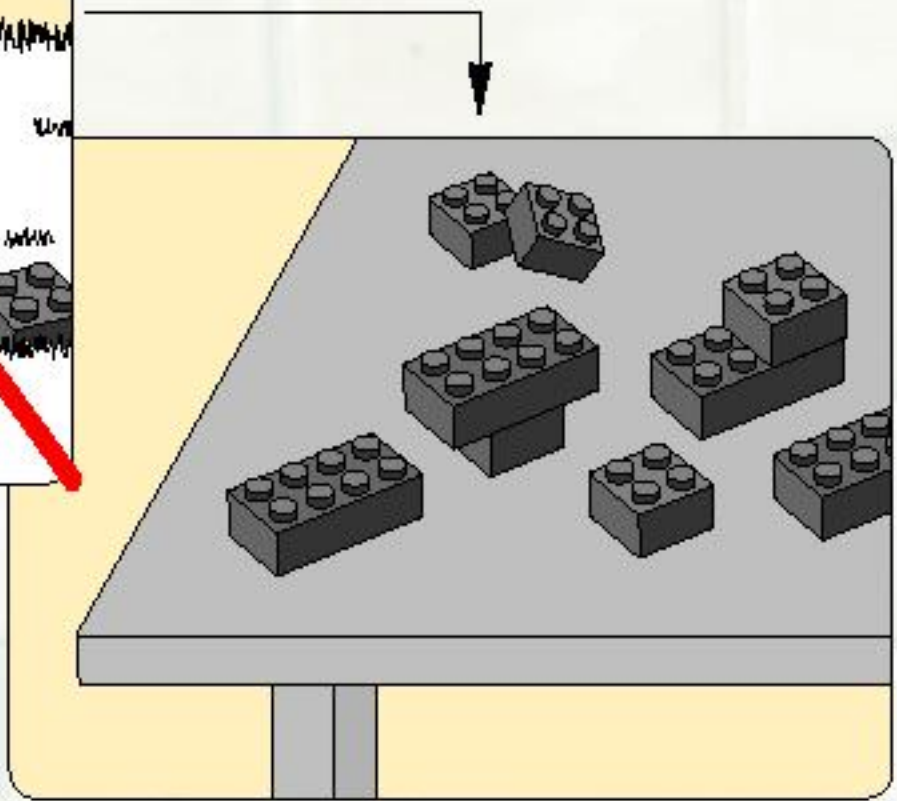
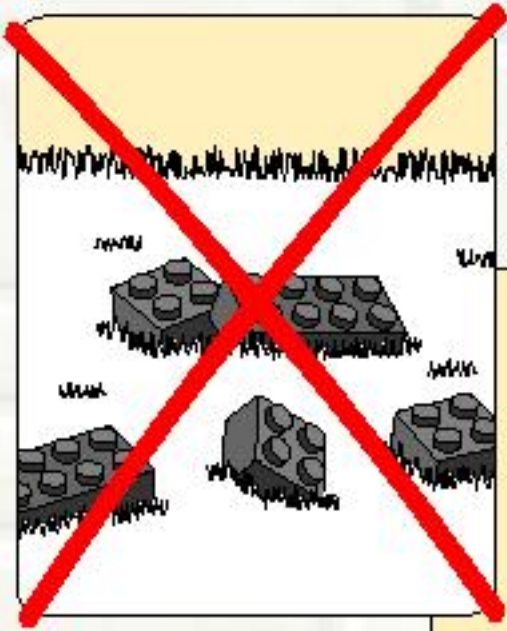

2



2

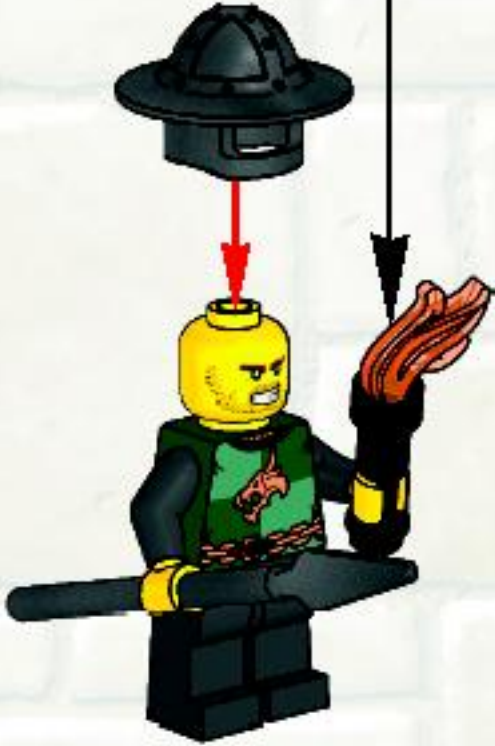
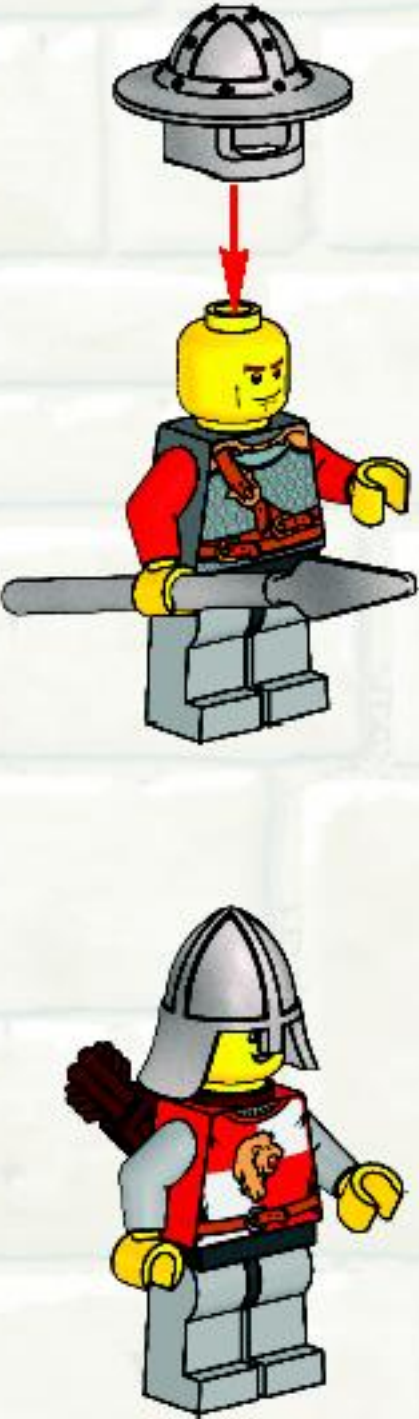
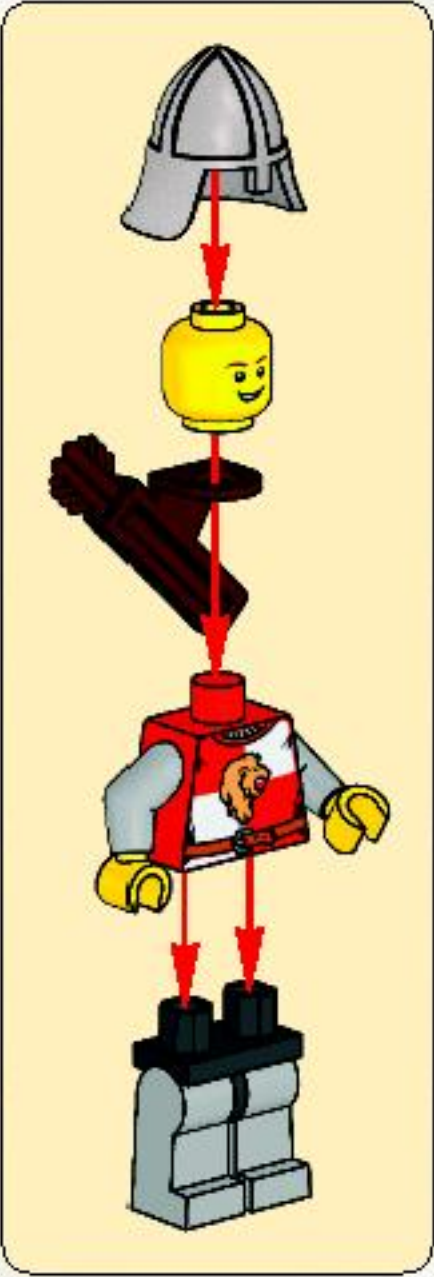
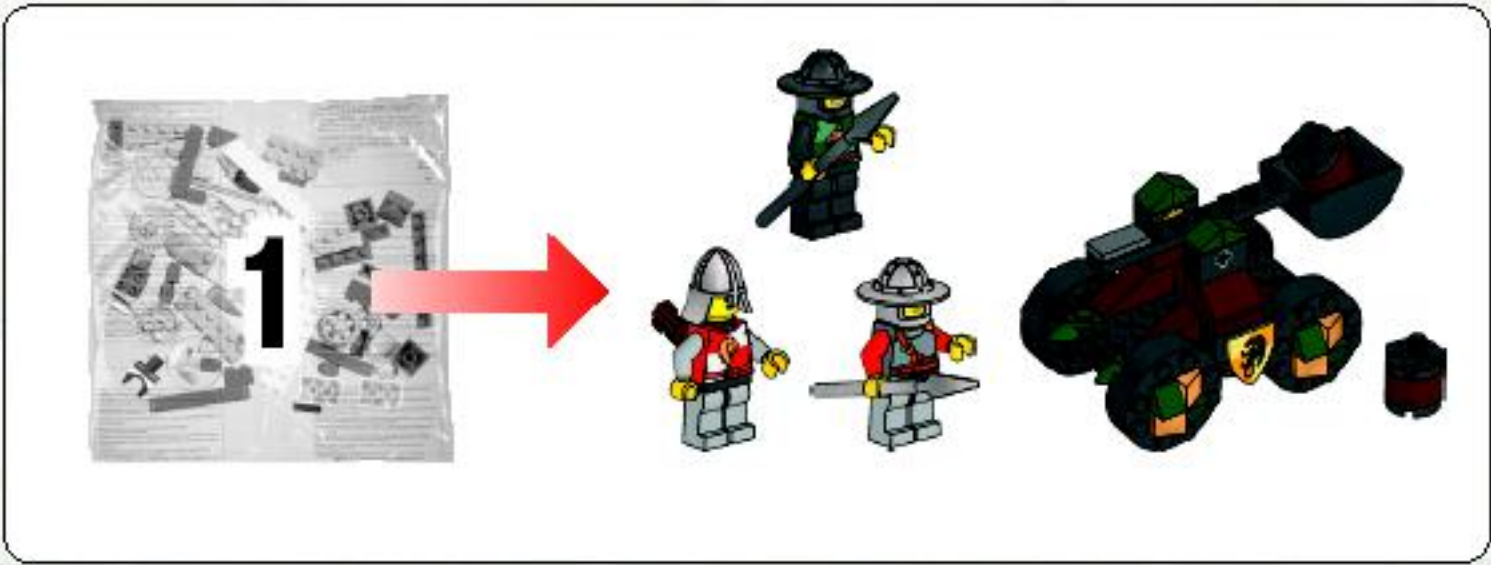

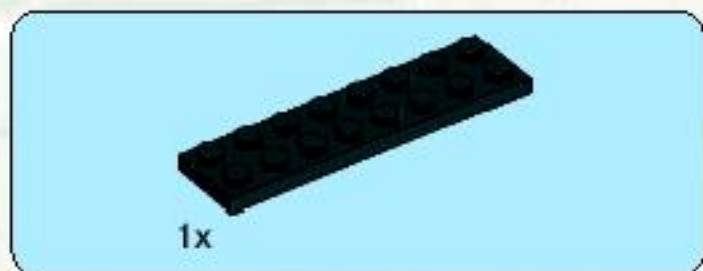

1

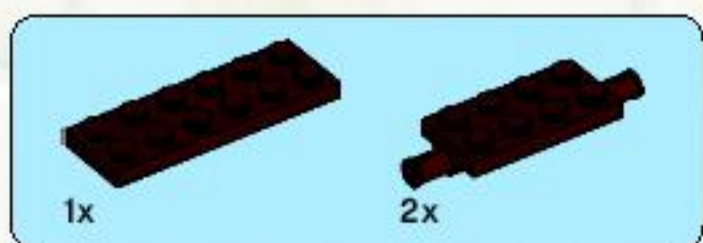

2





3

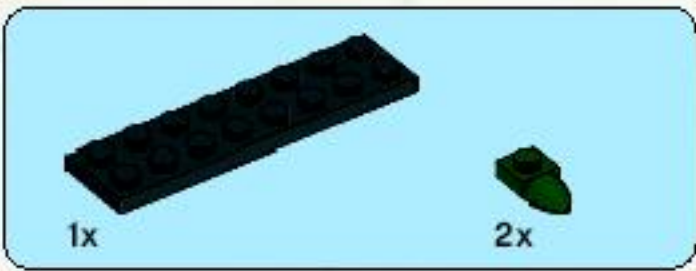
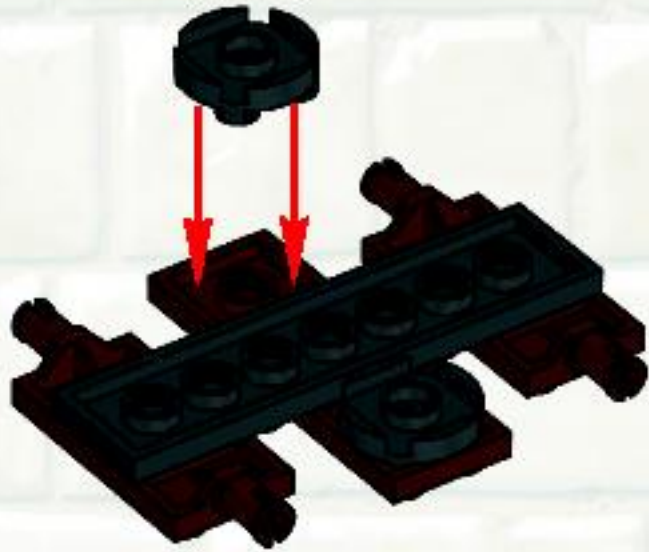

4



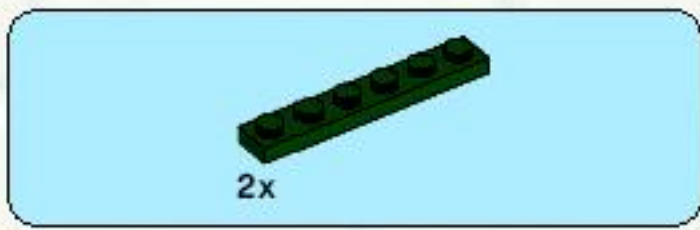

5

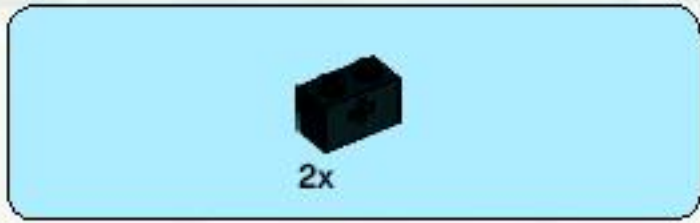
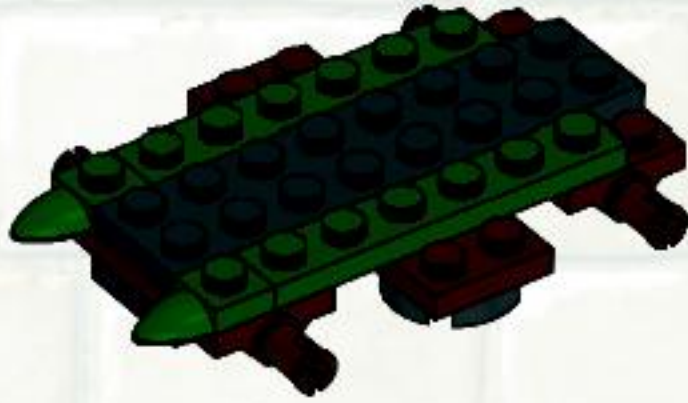

6

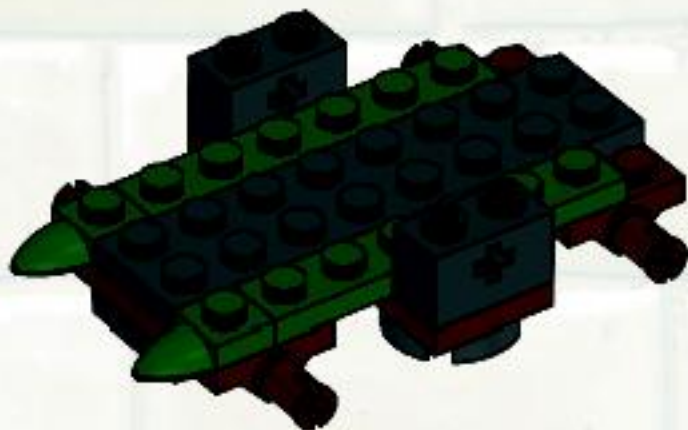

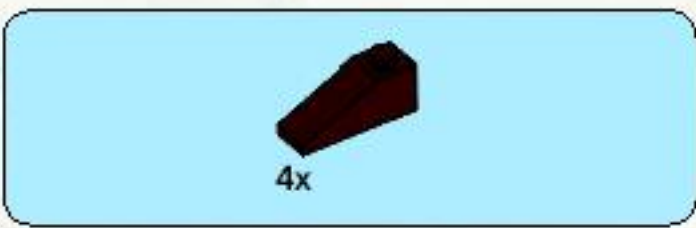

7

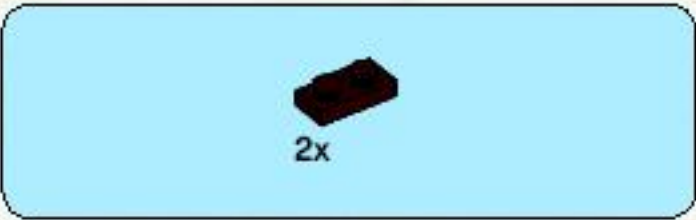
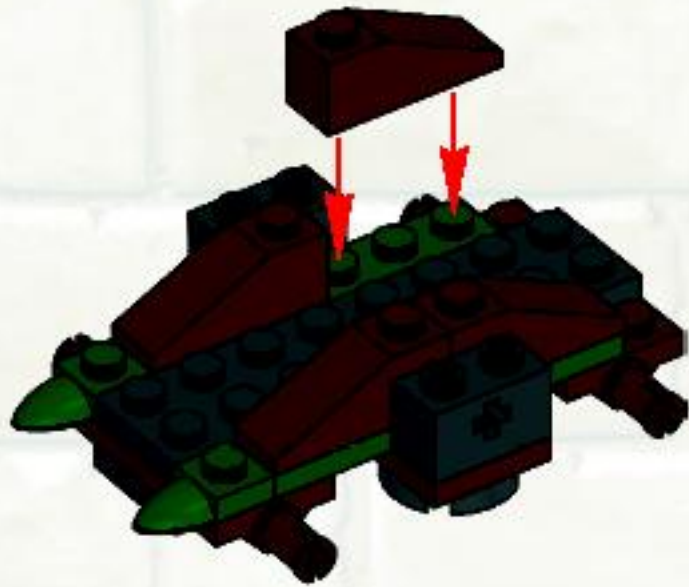

8





9

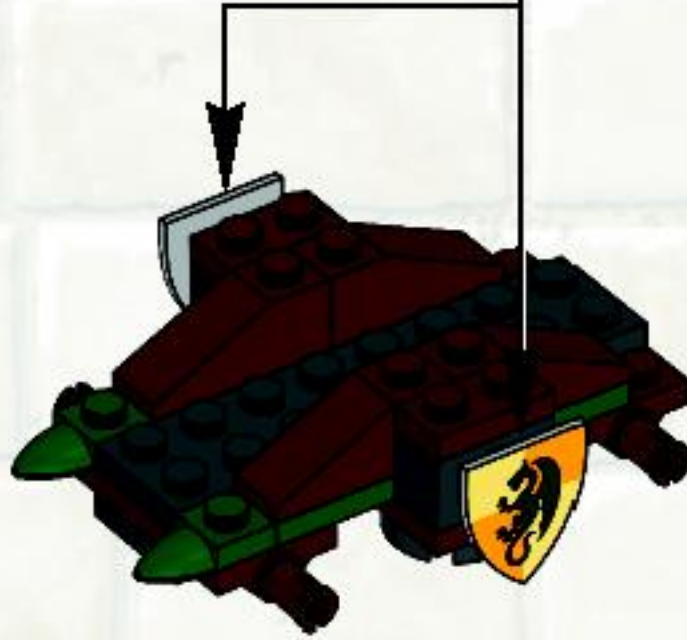

10



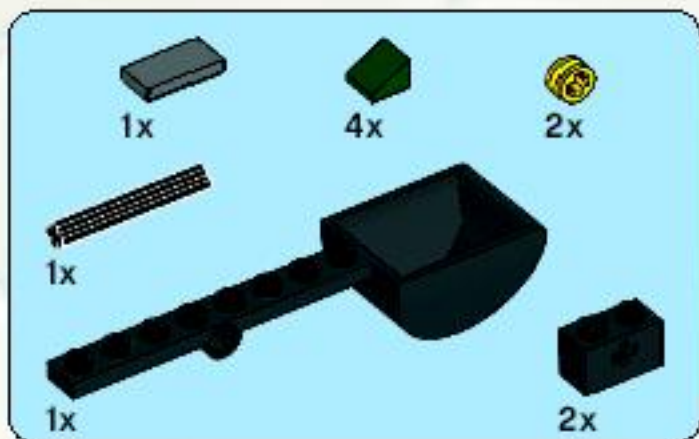
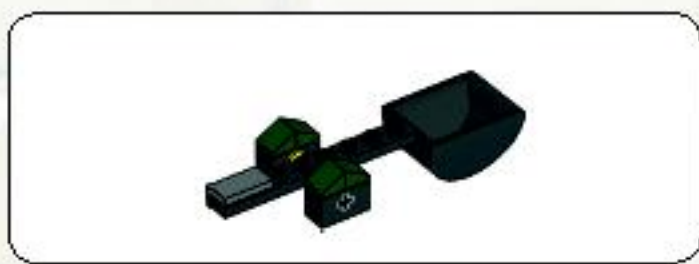

11

1

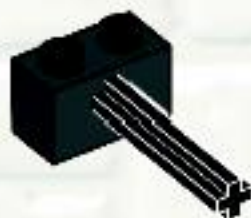

2



3

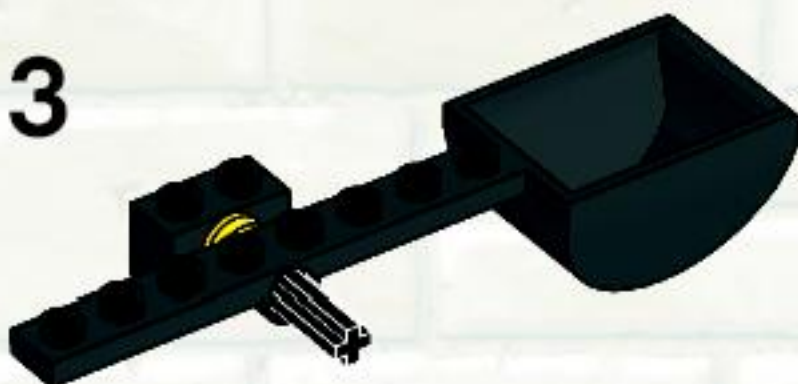

4

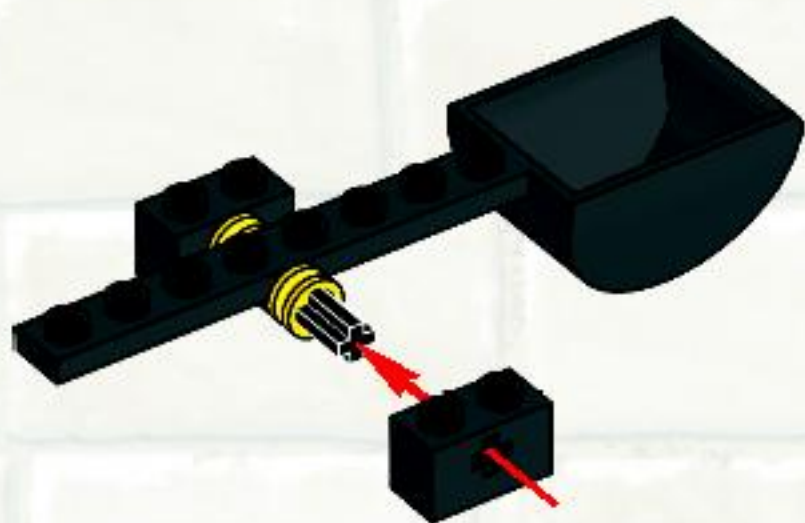

5

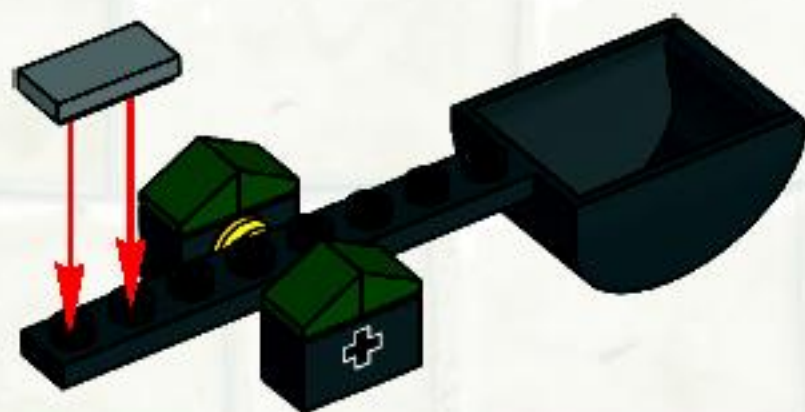

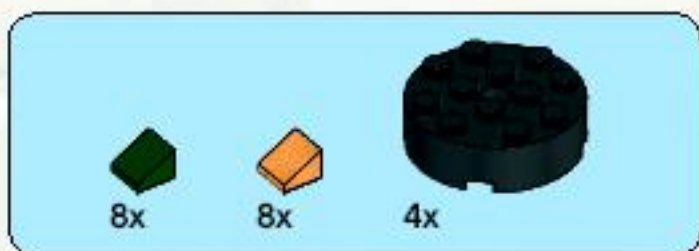

12

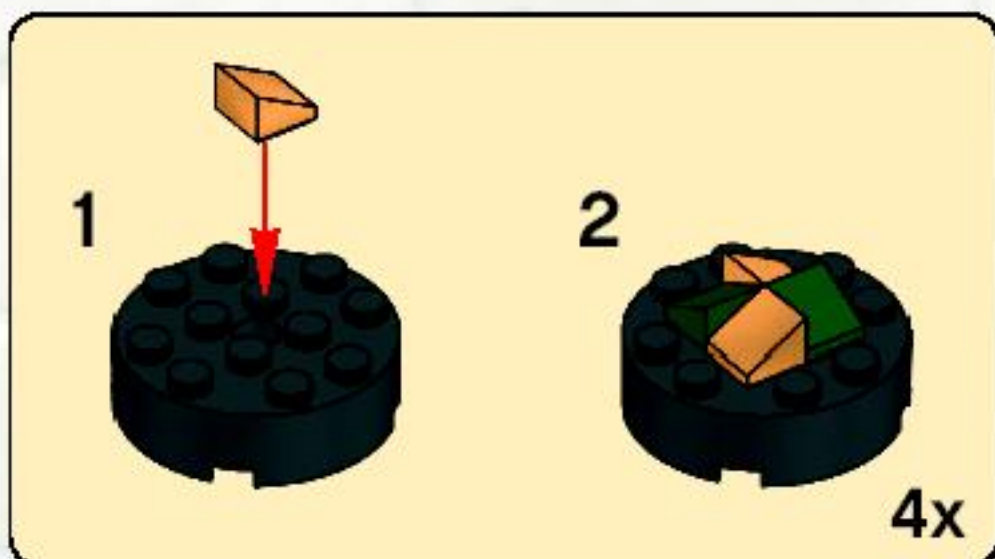



13

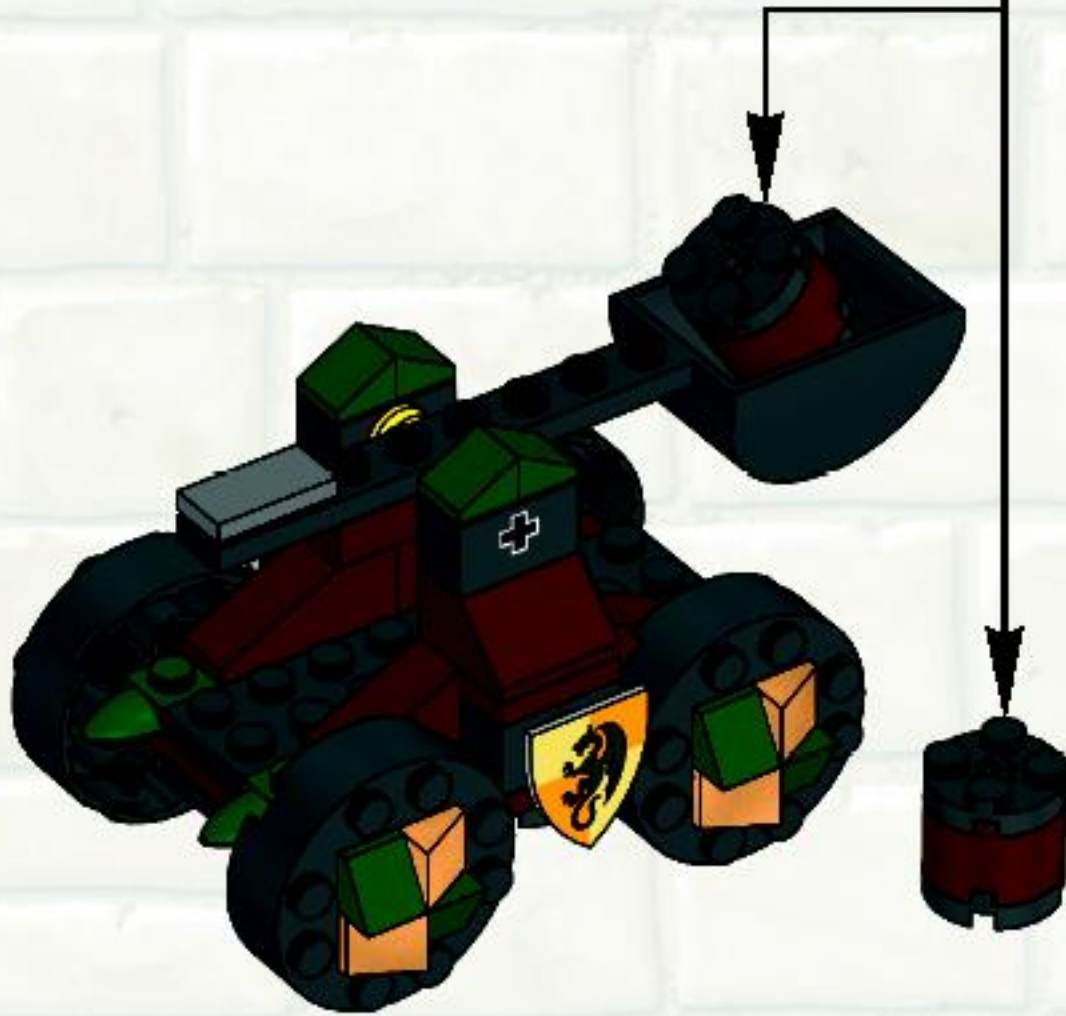
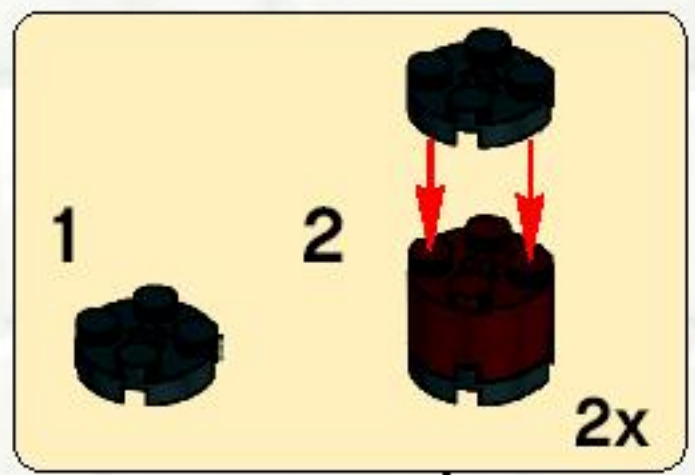

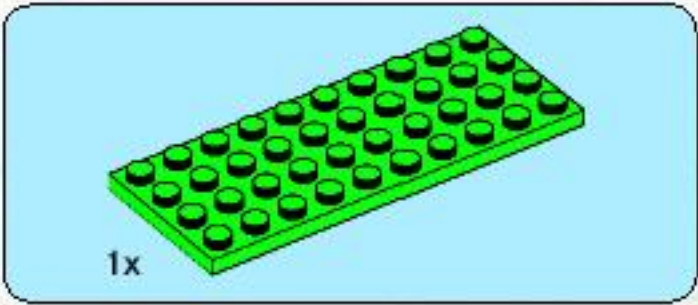
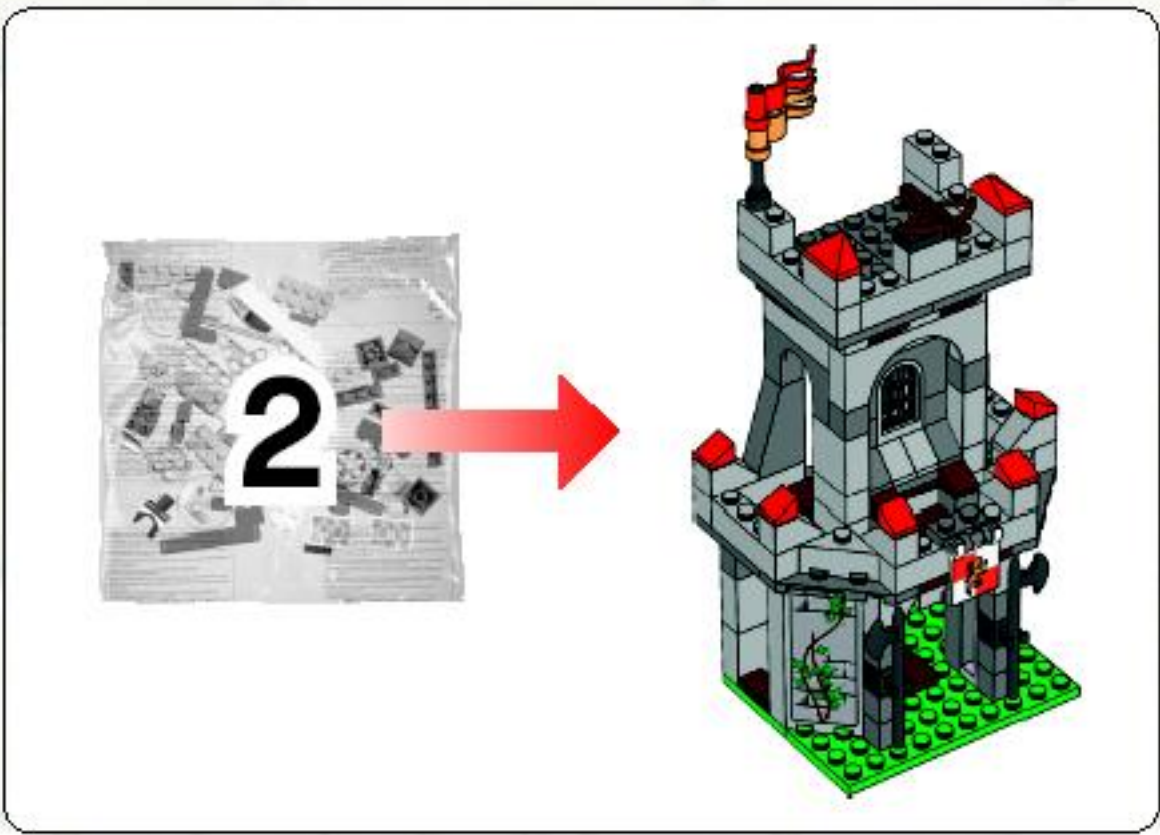

1

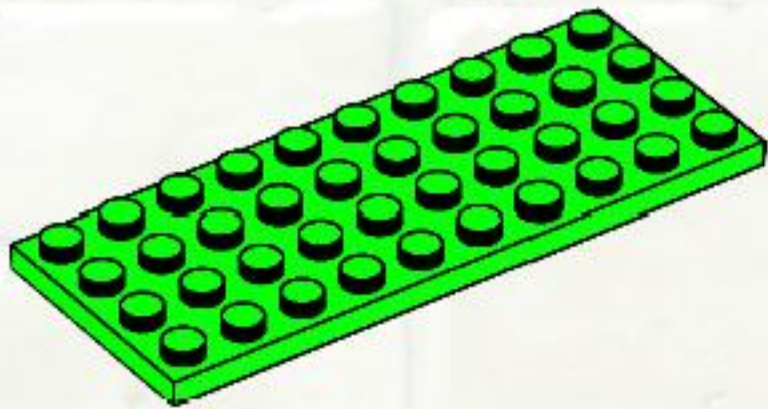

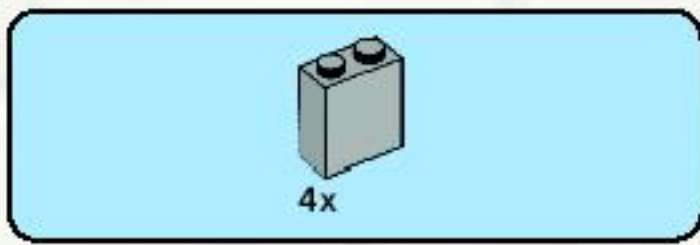

2

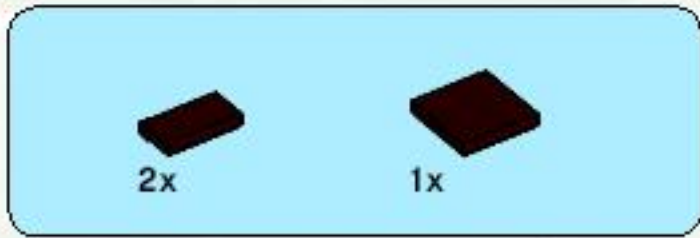
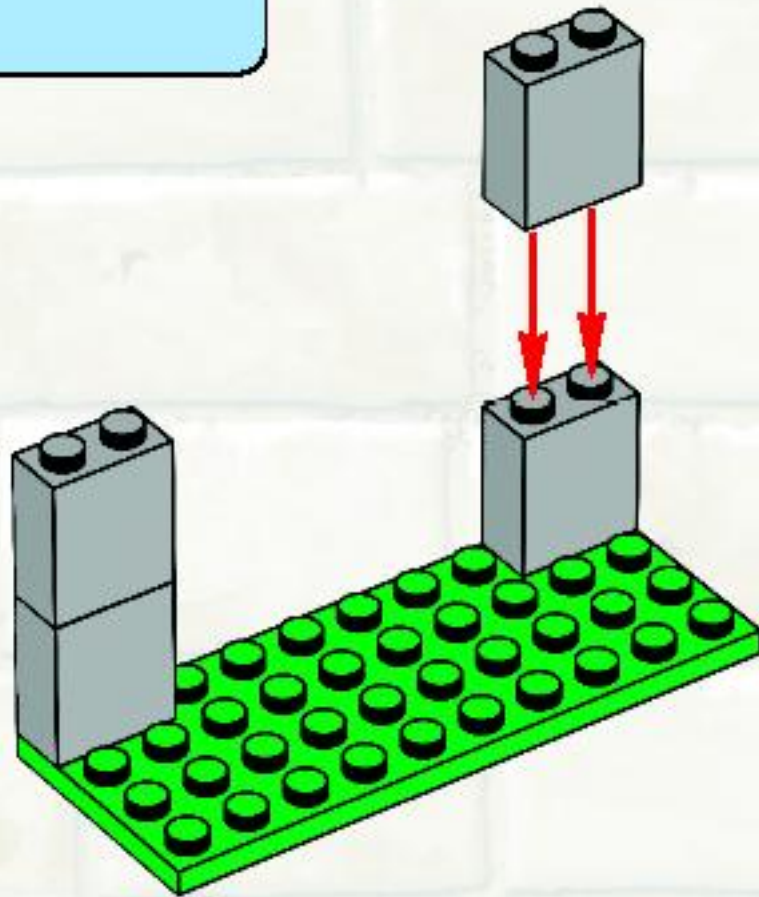

3

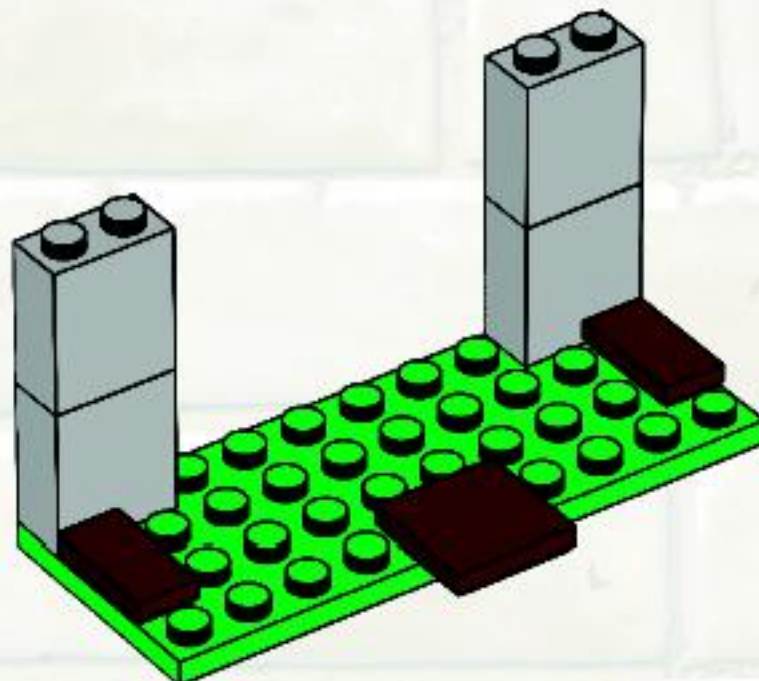

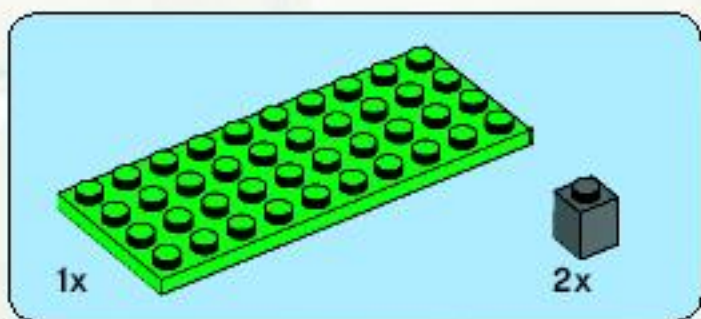

4

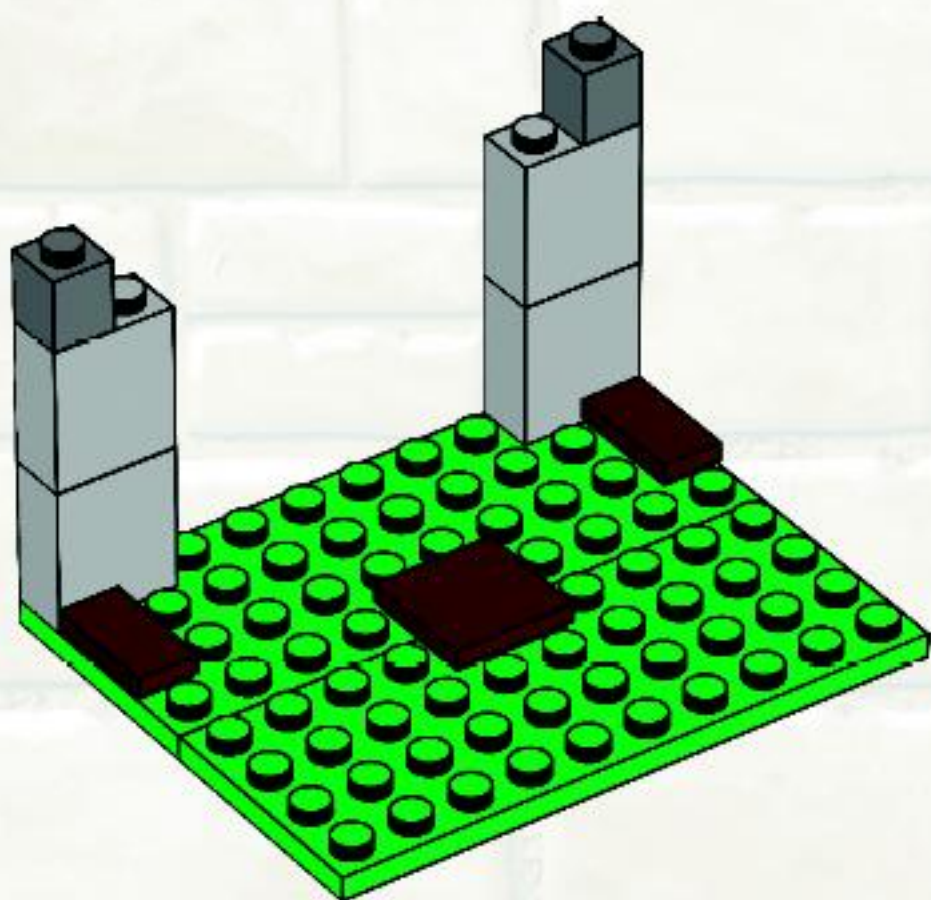

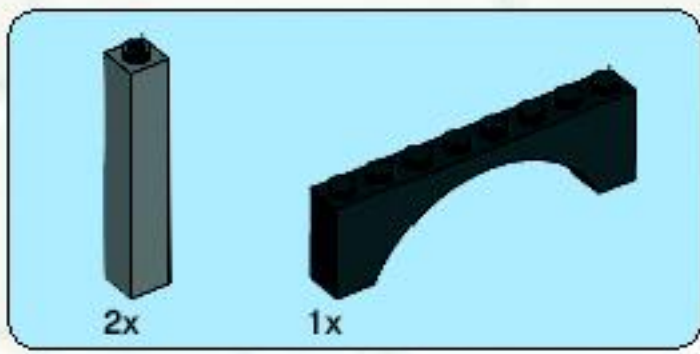

5

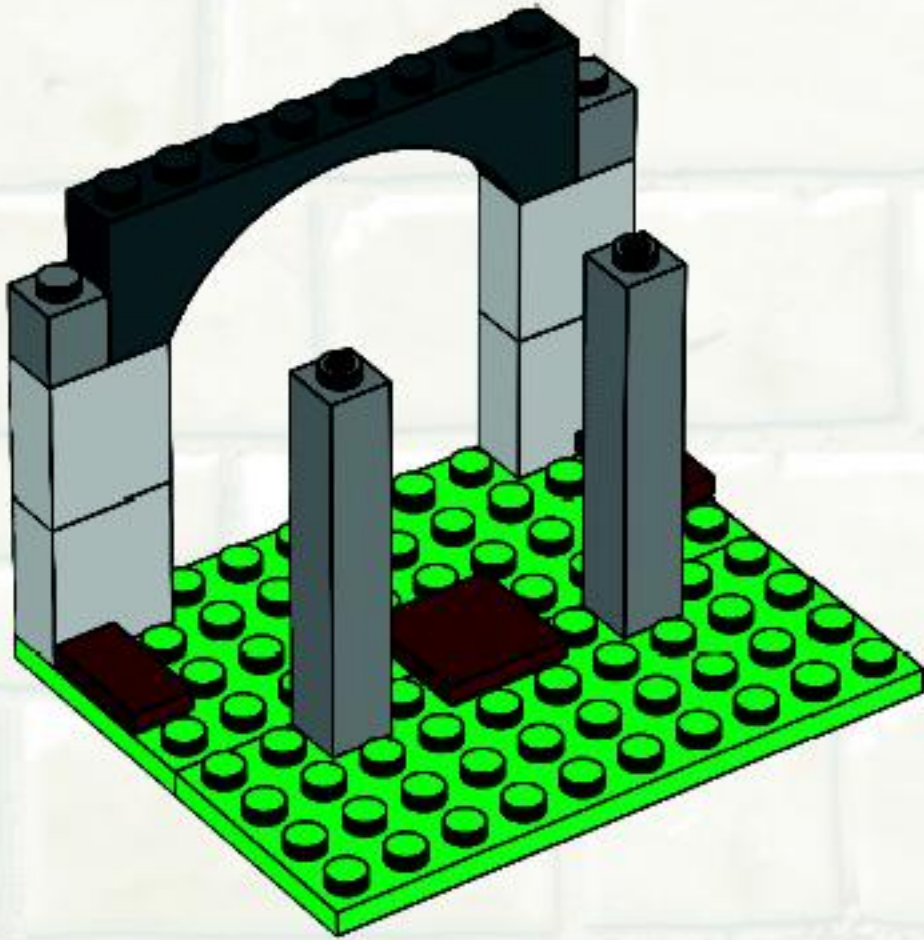

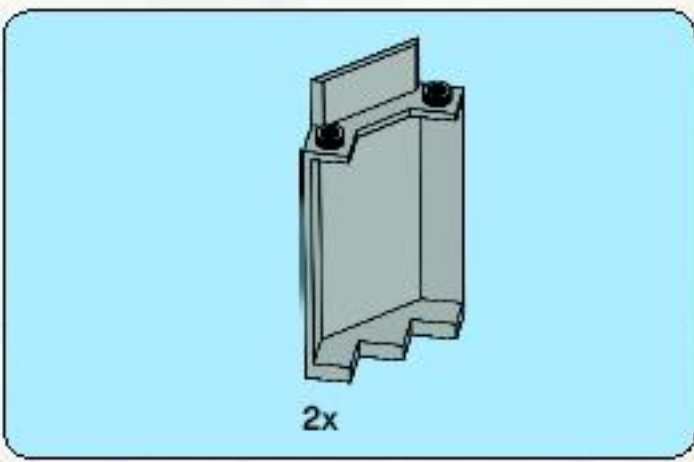

6

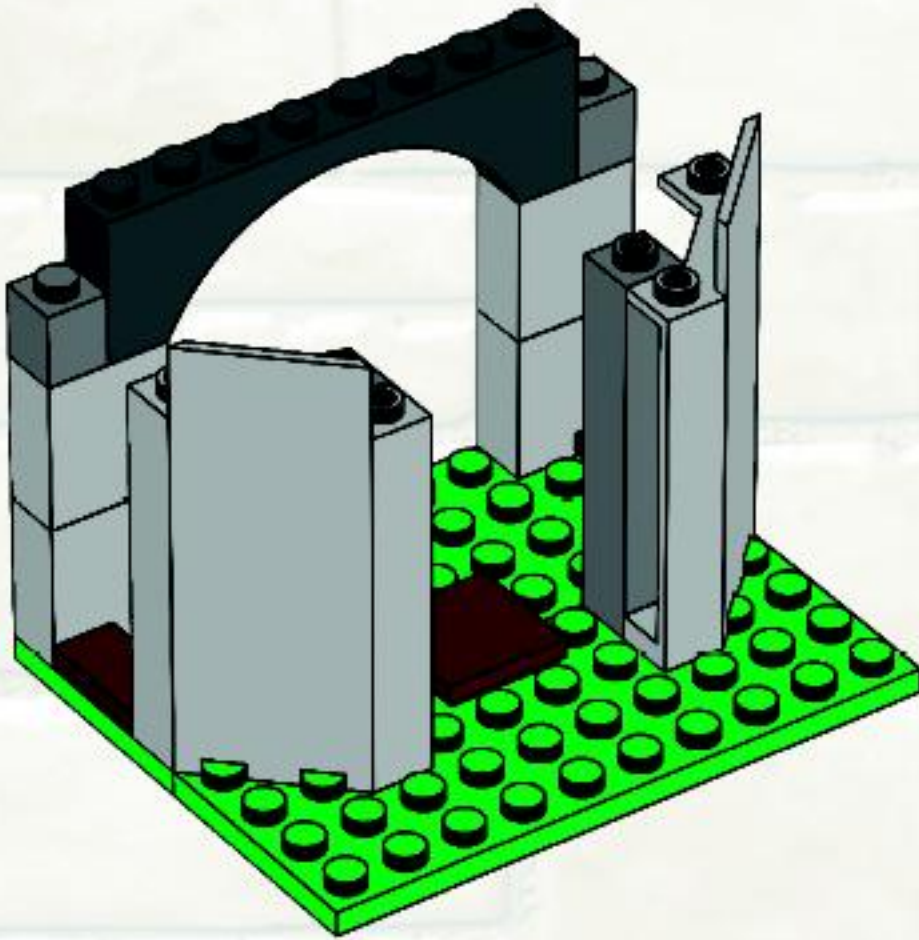

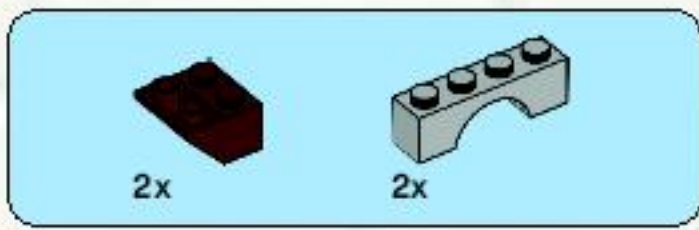

7

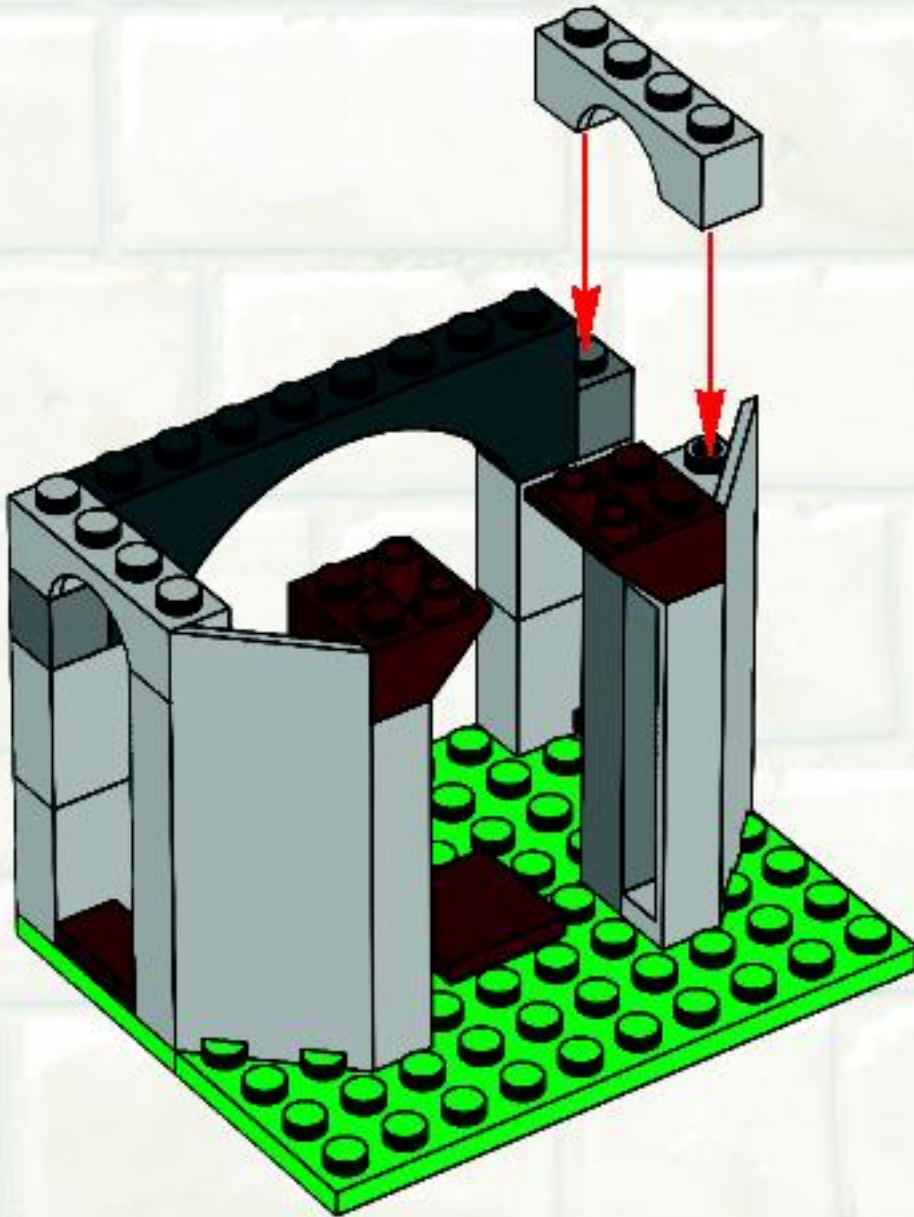

8

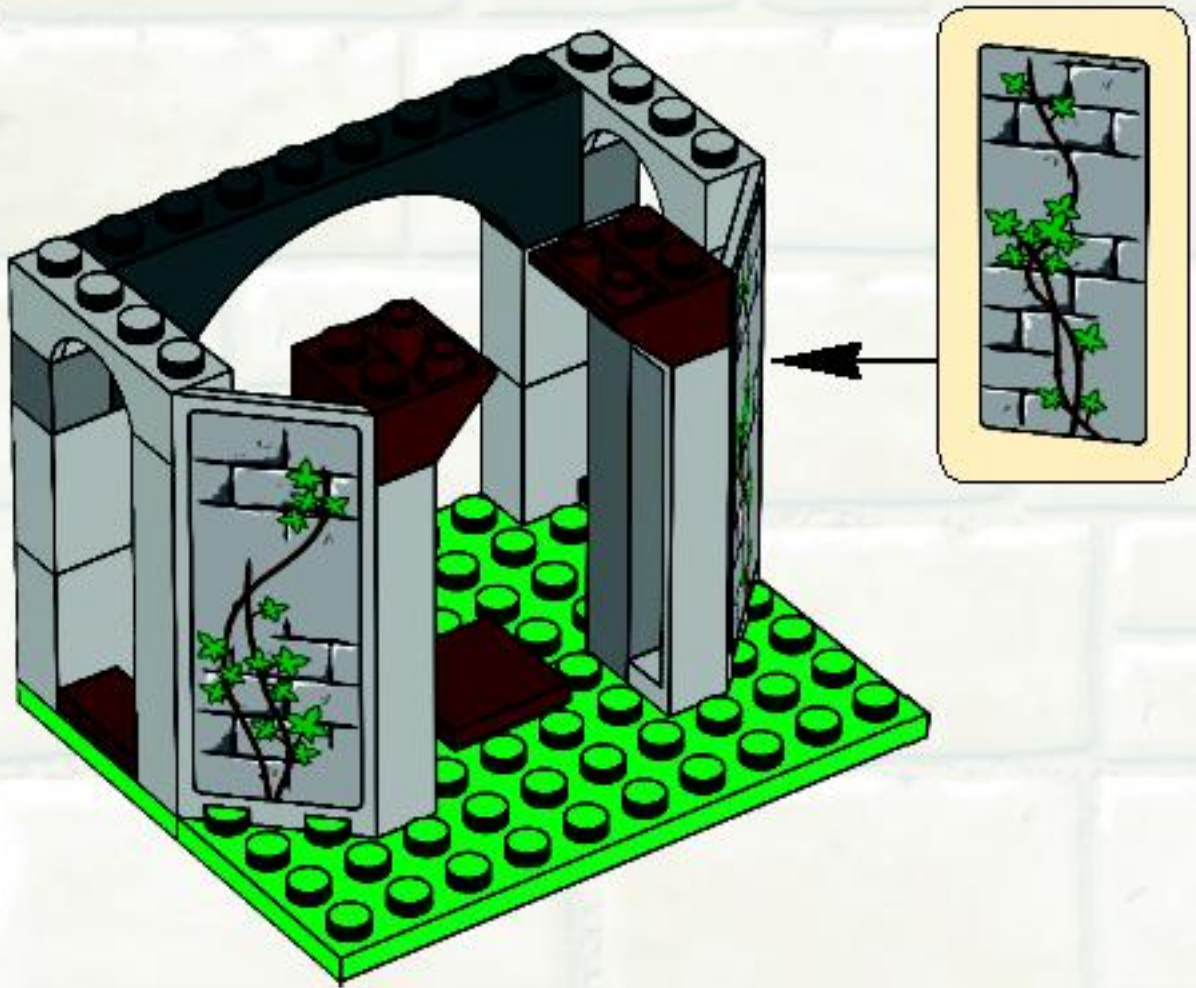



6x



2x

9

1



2



3

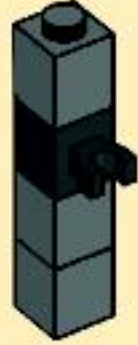

2x

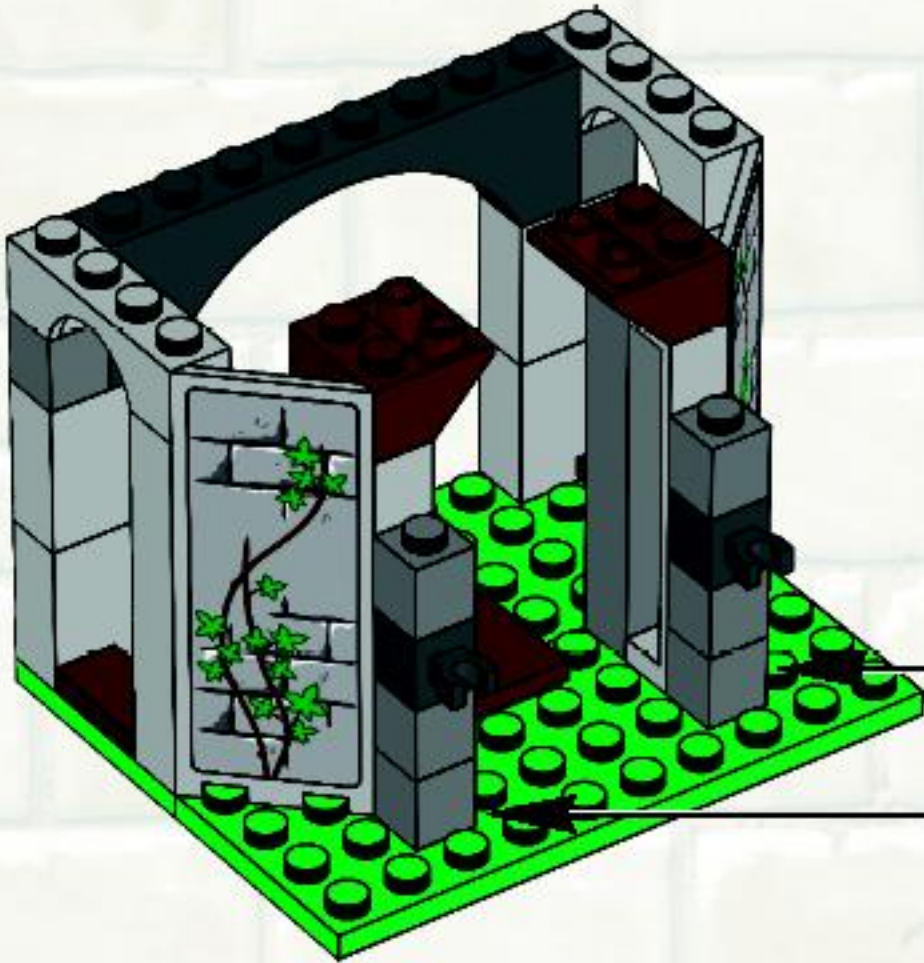

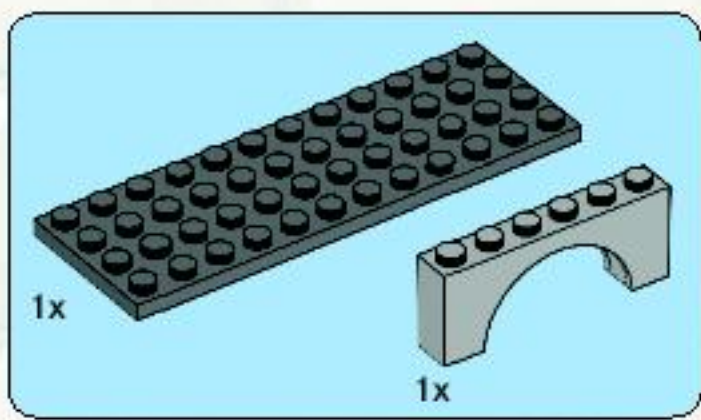

10

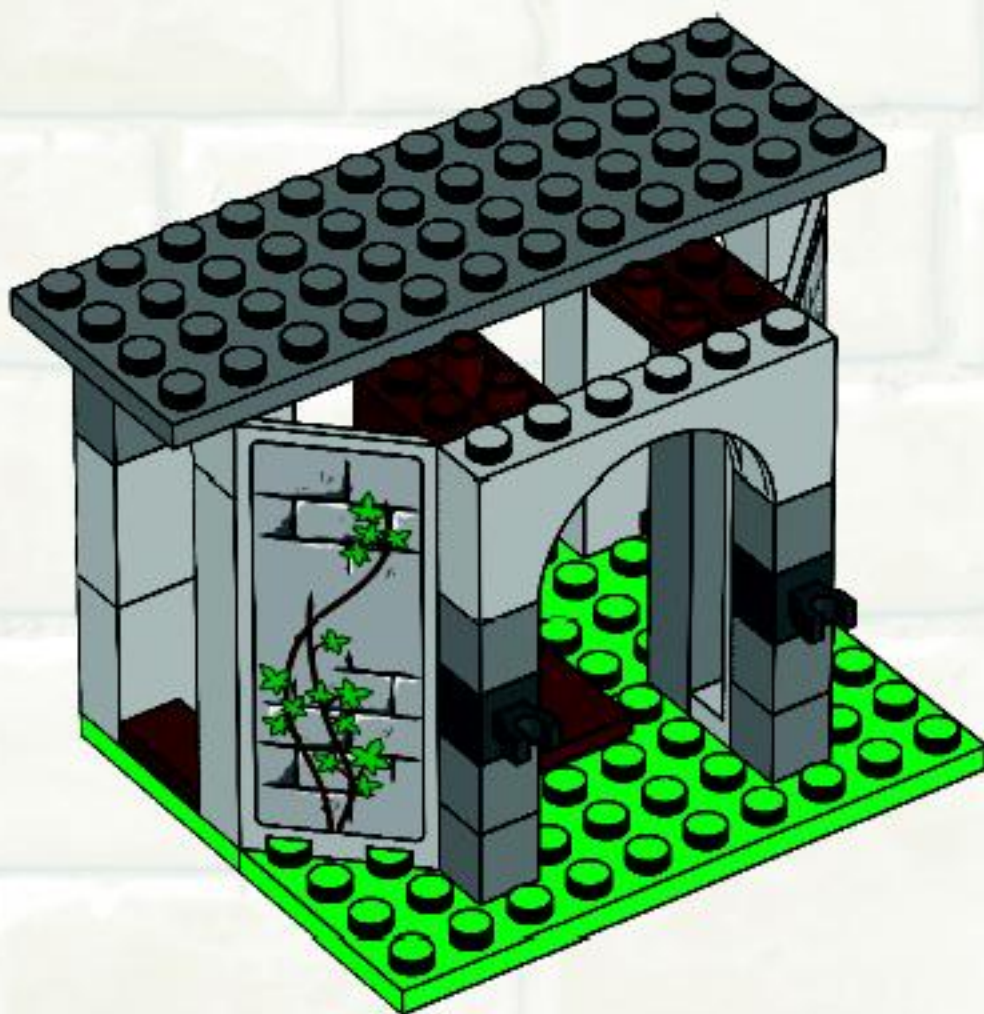

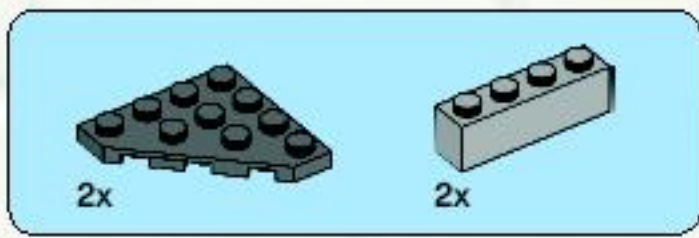

11

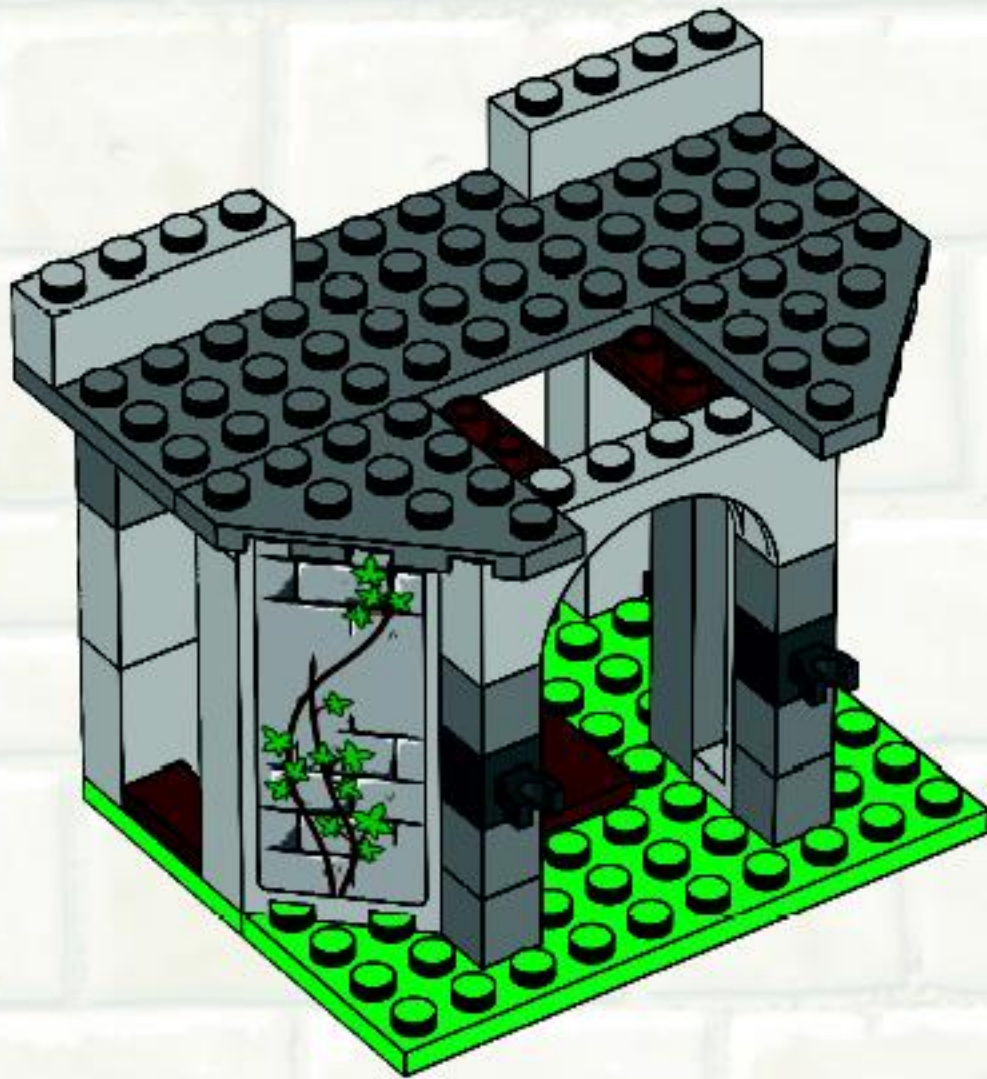

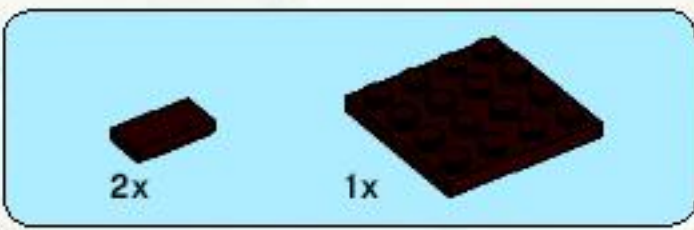

12

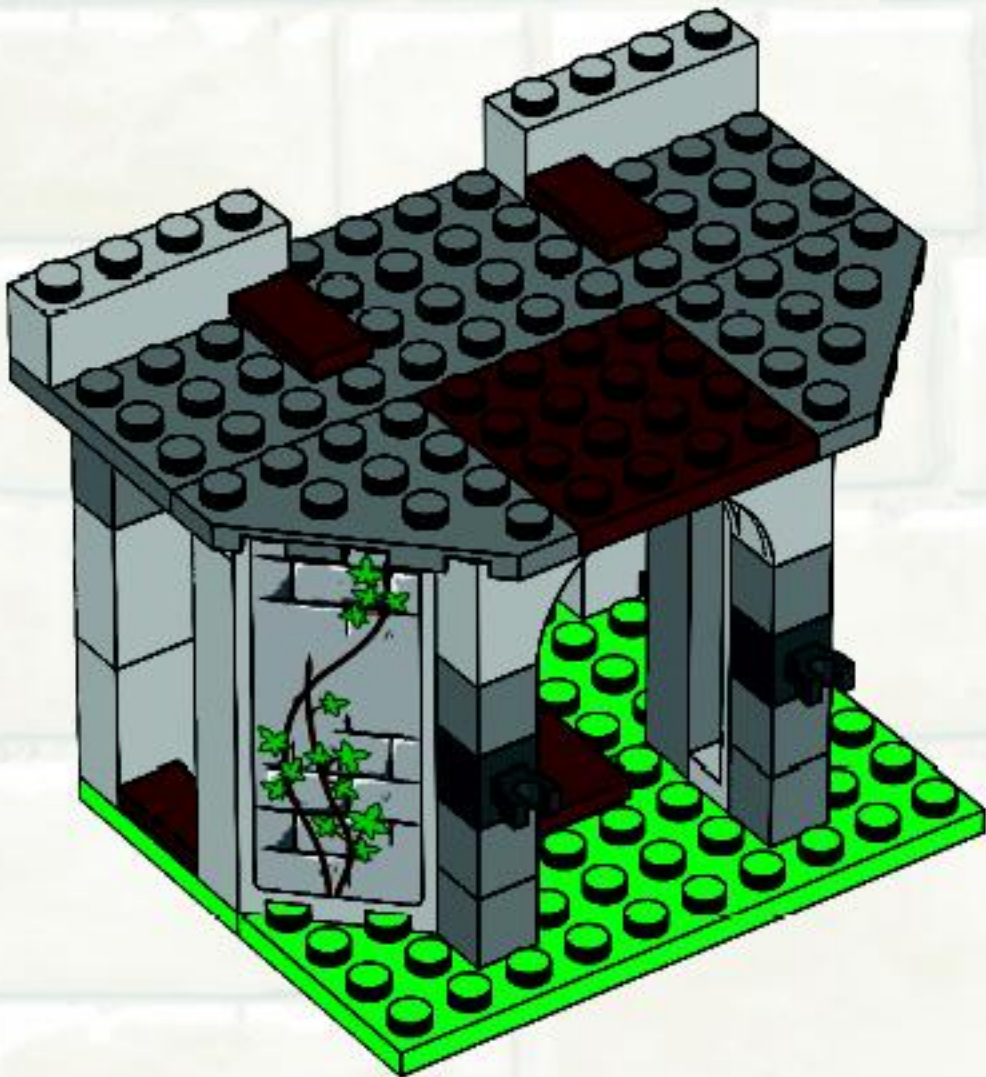

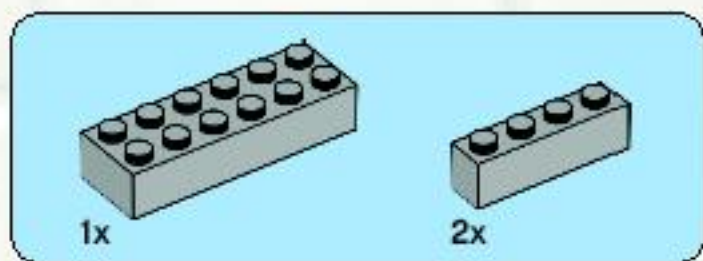

13

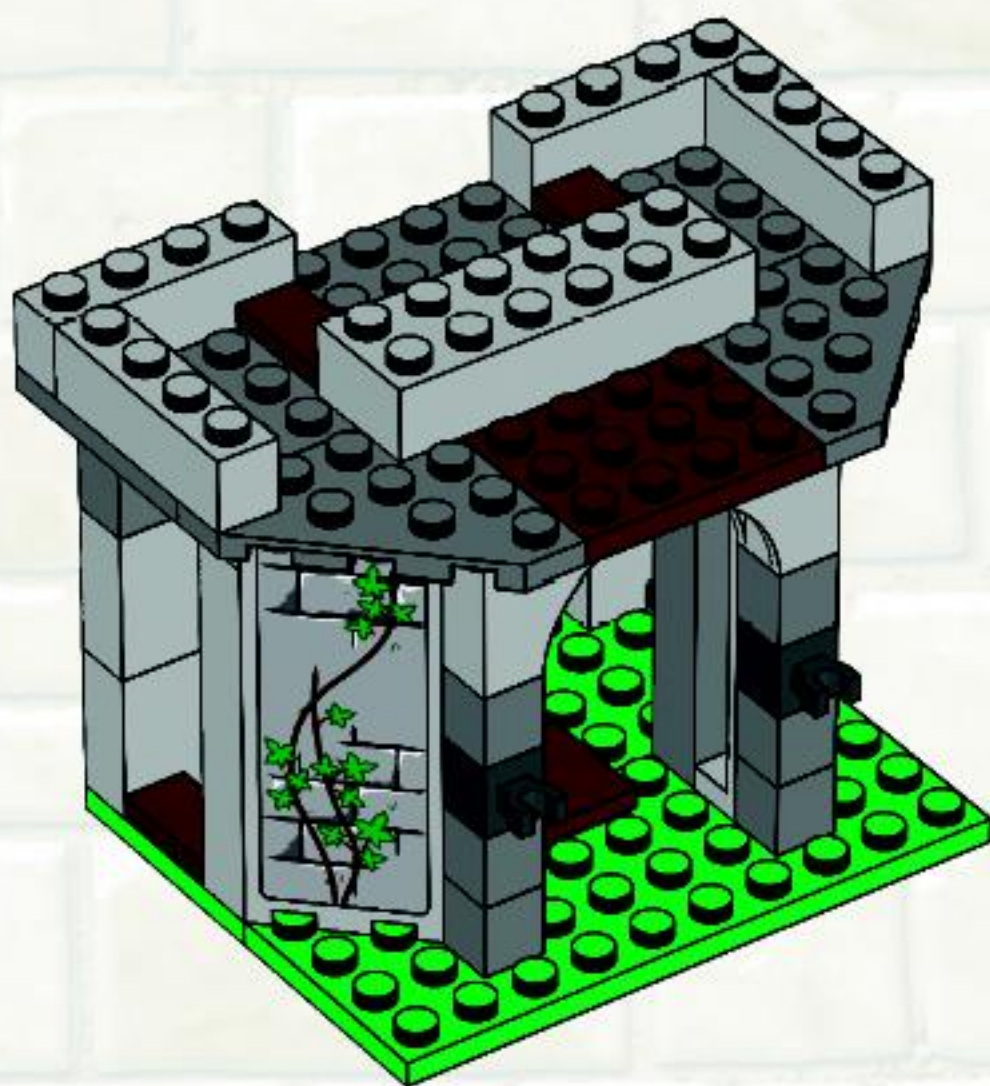

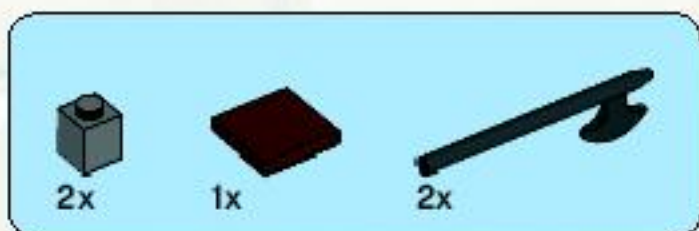

14

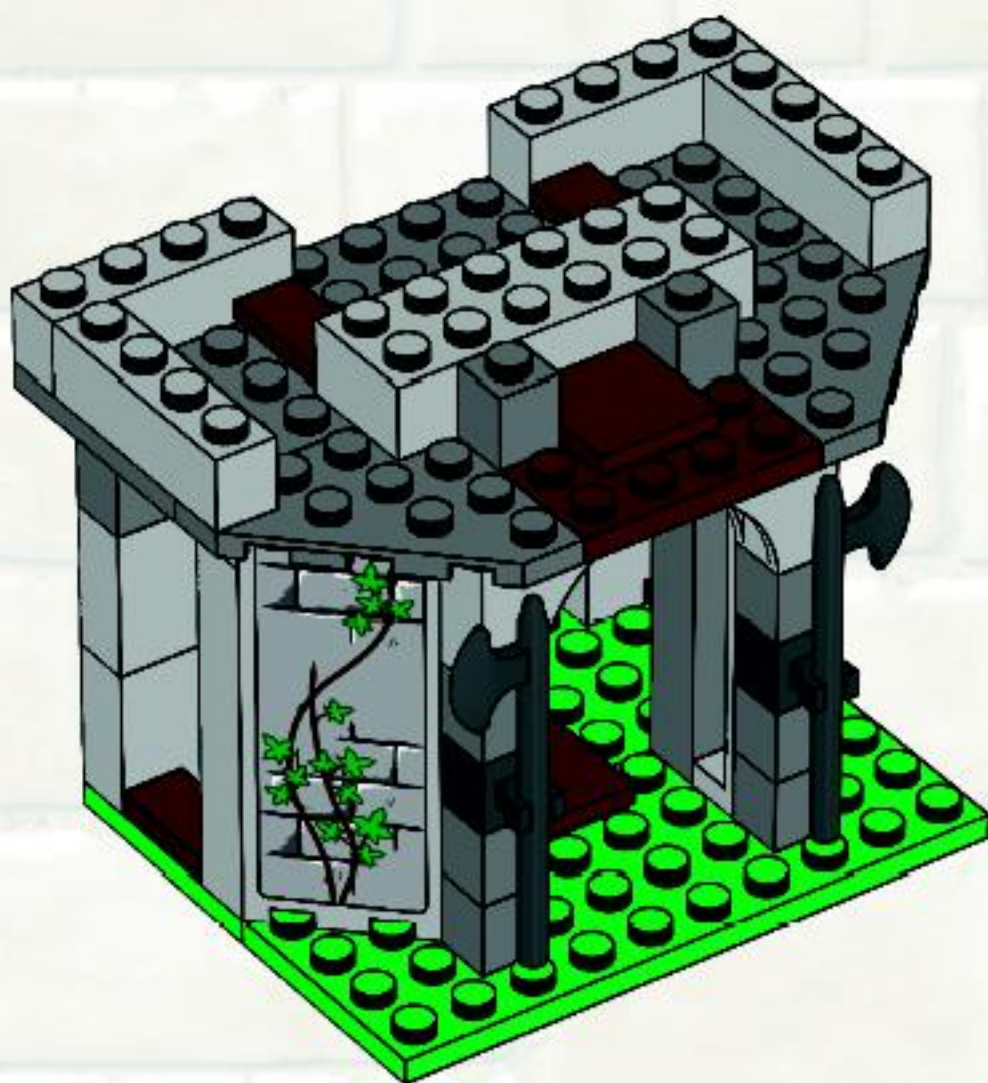

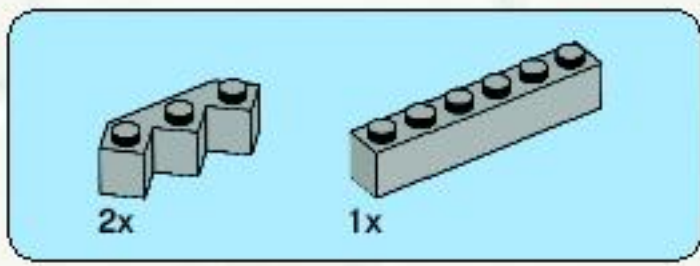

15

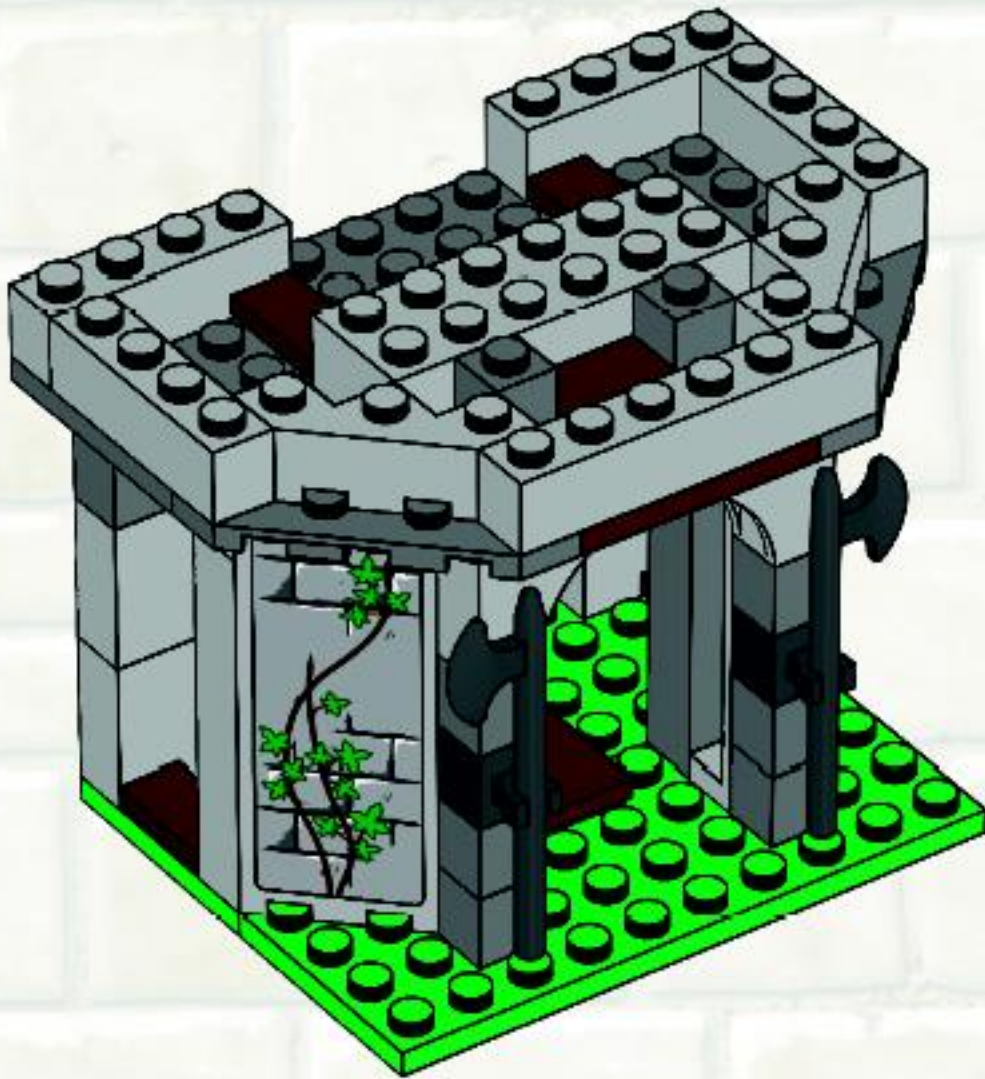

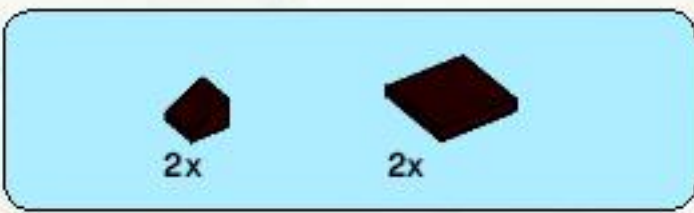

16

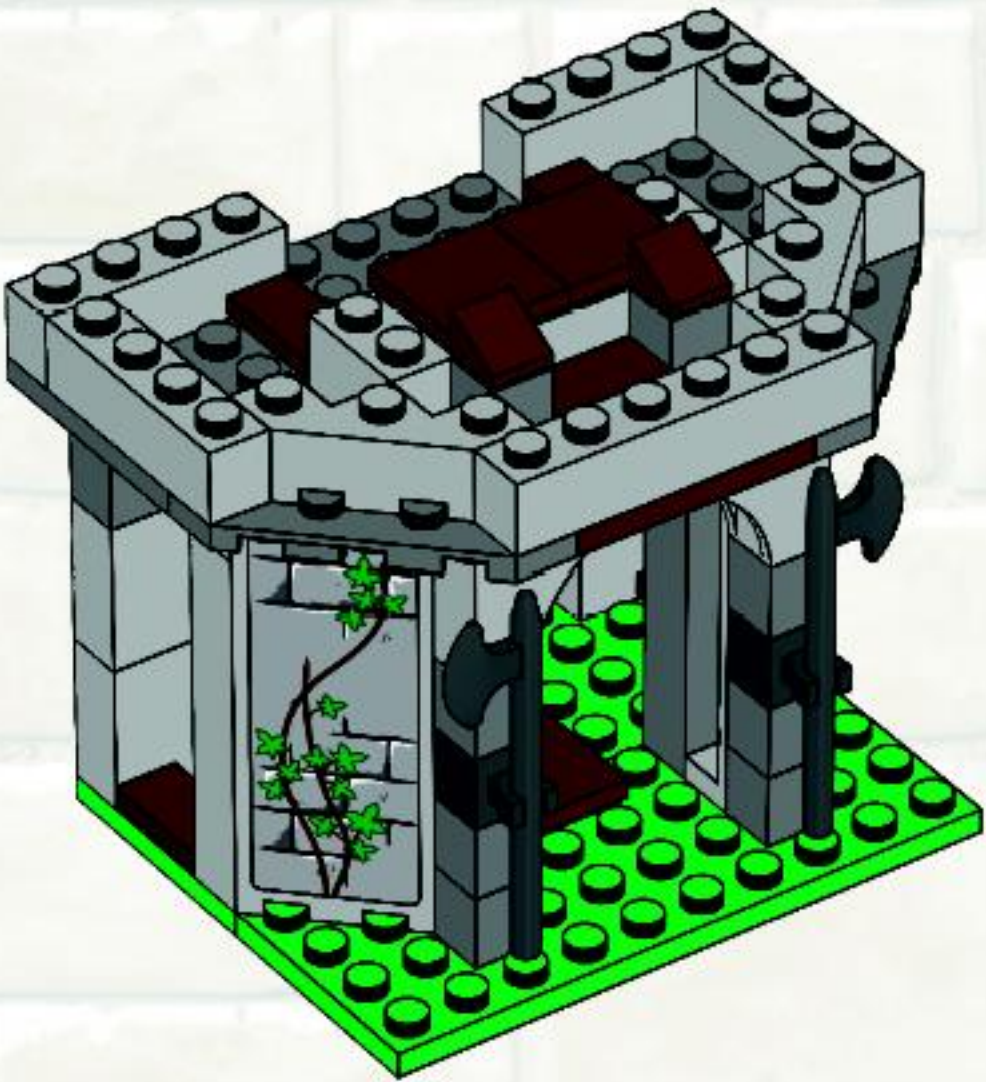

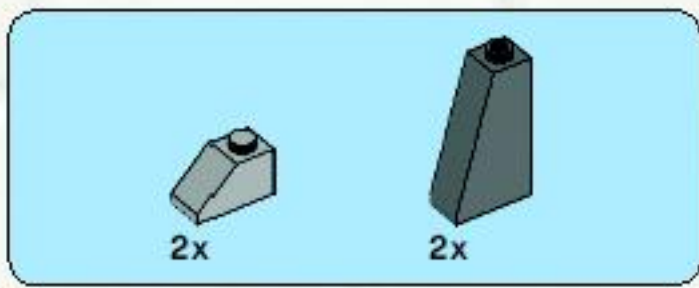

17

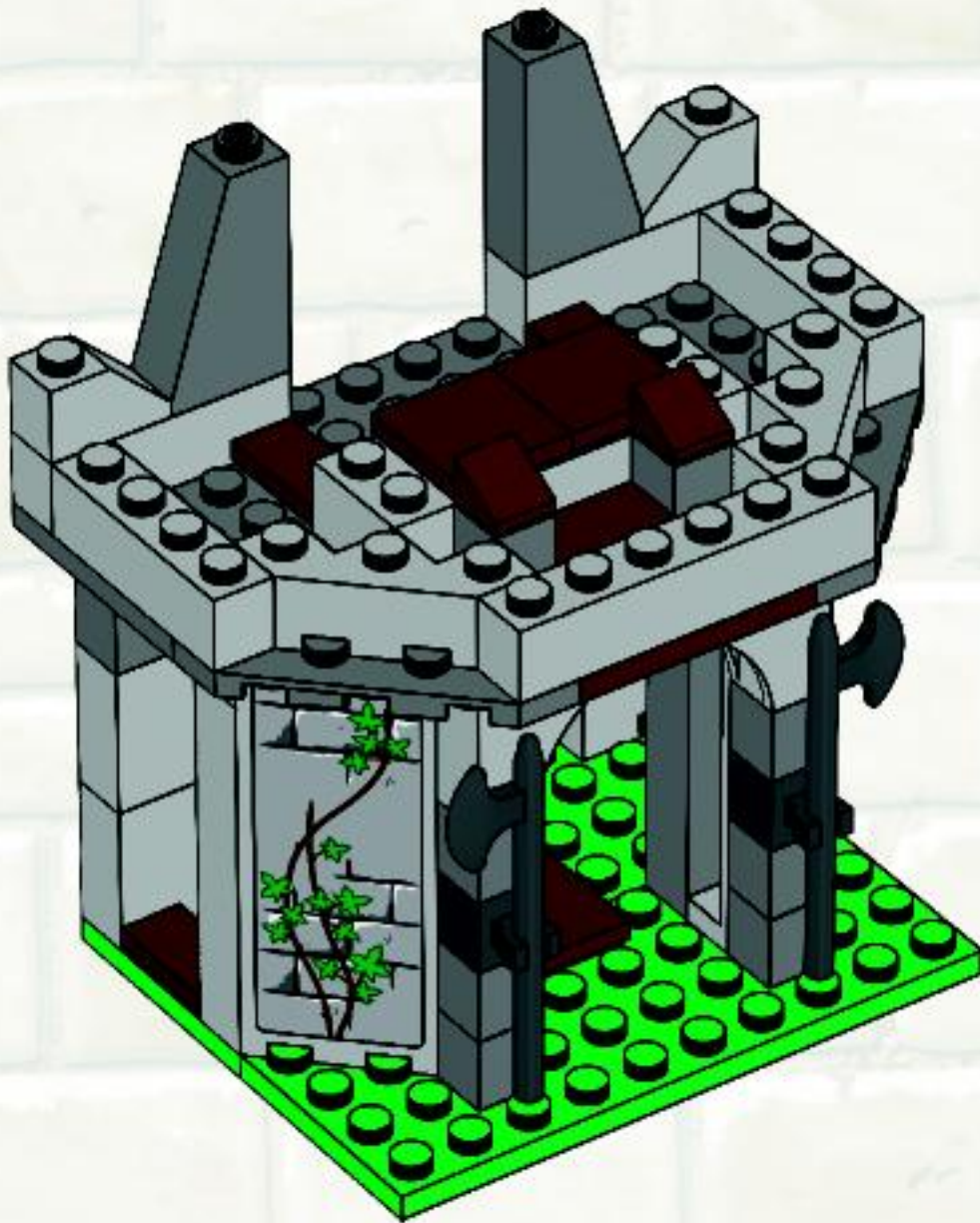



4x

18

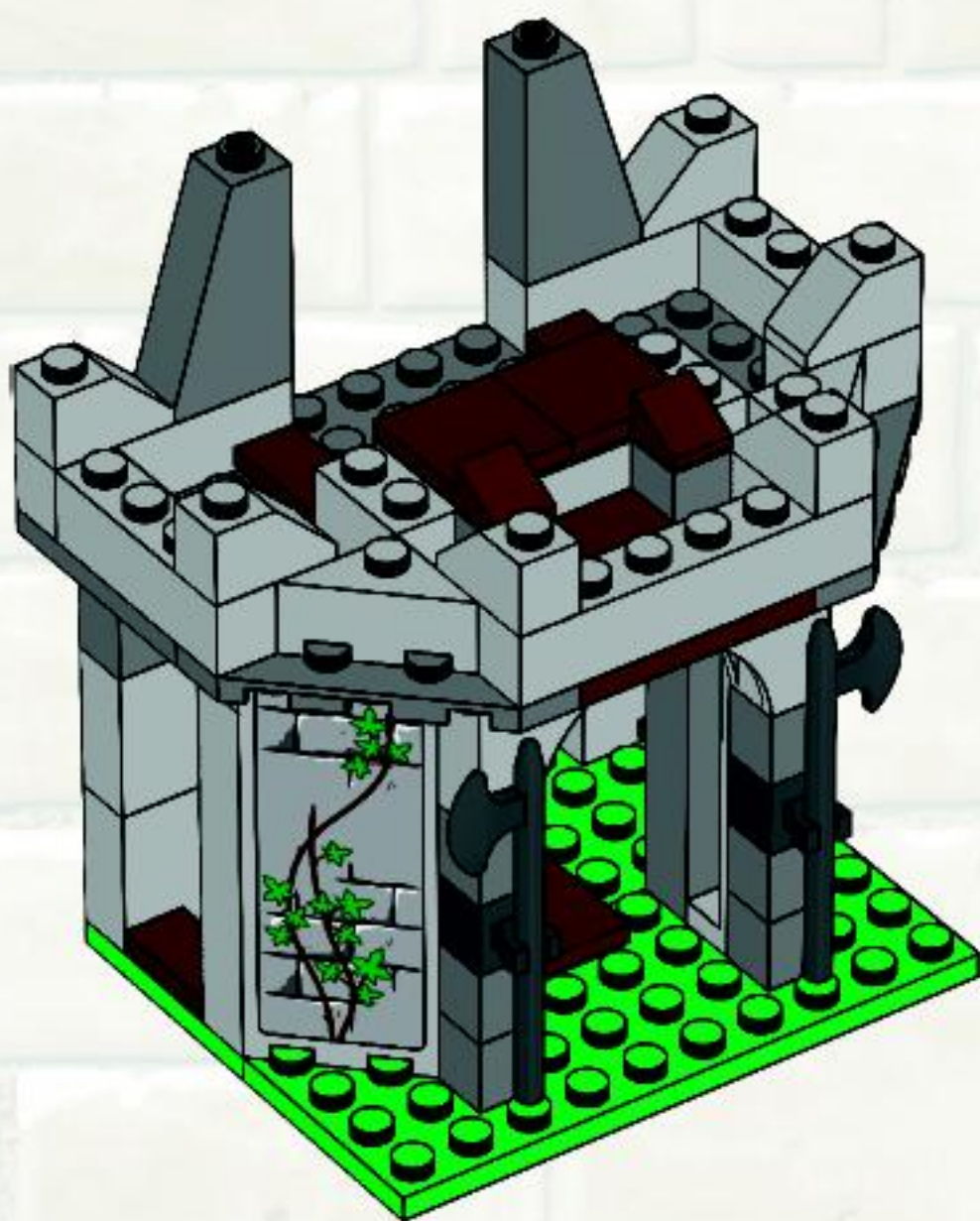

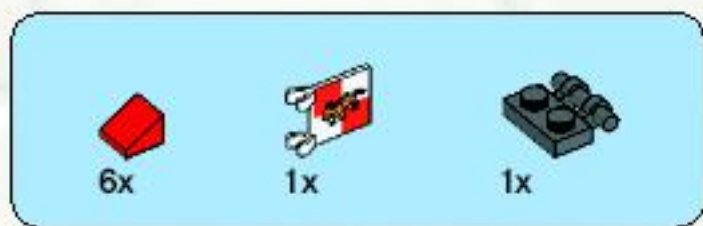

19

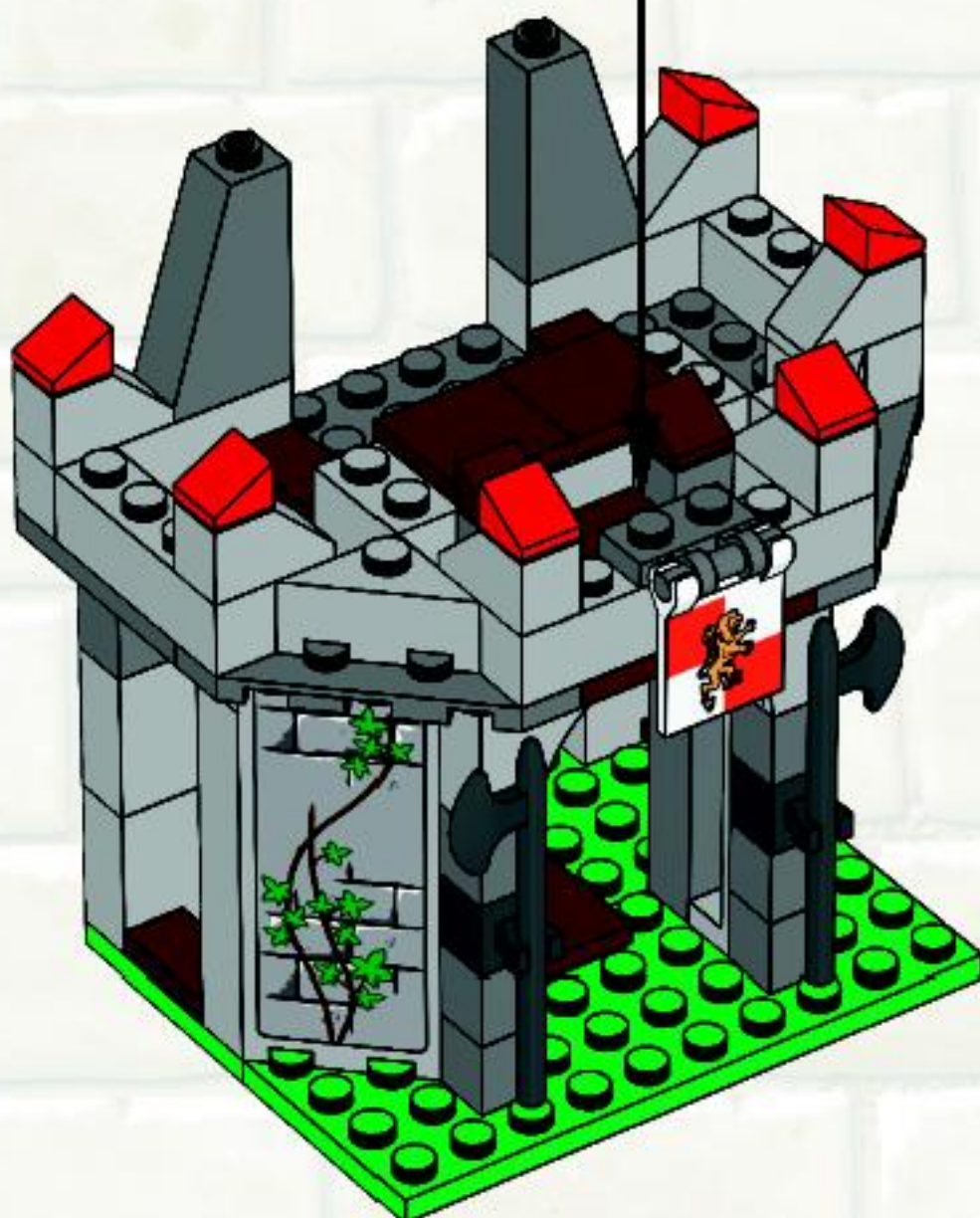
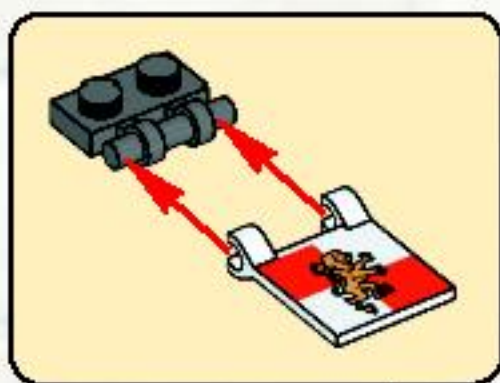

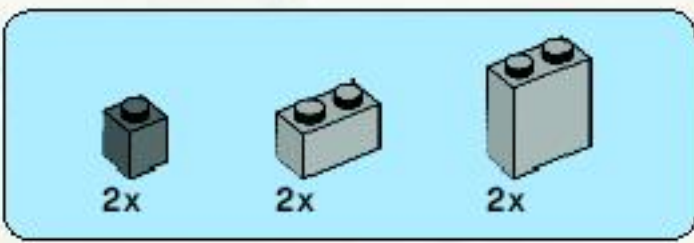

20

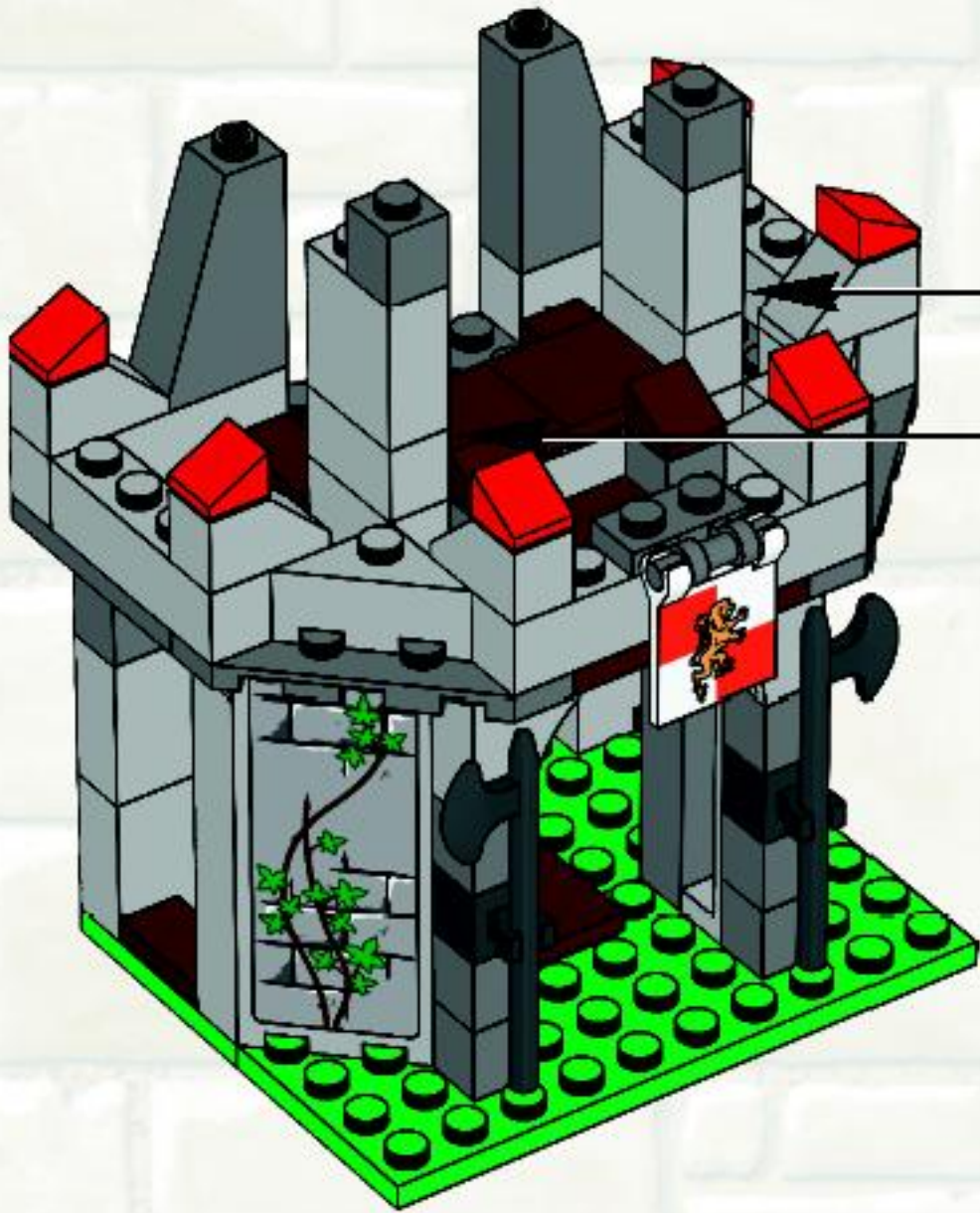
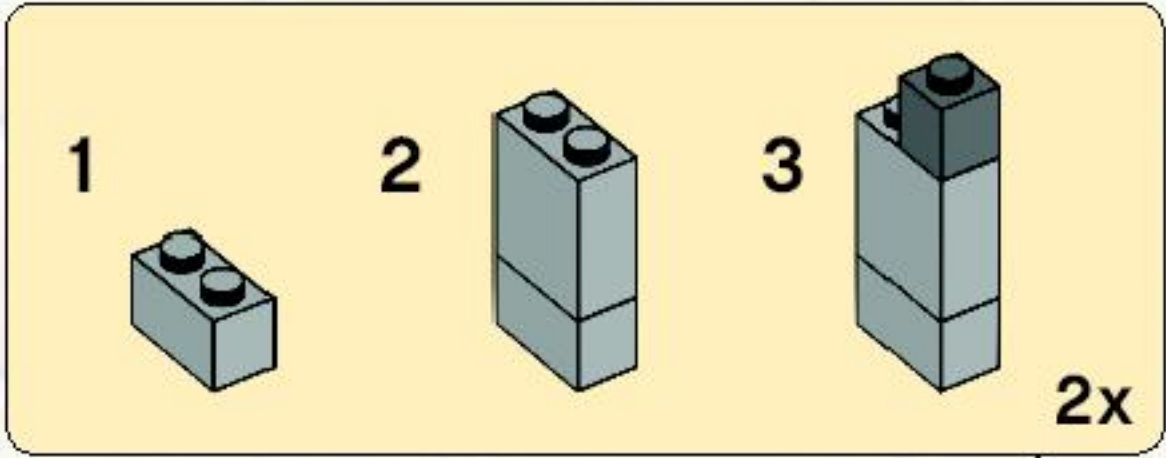

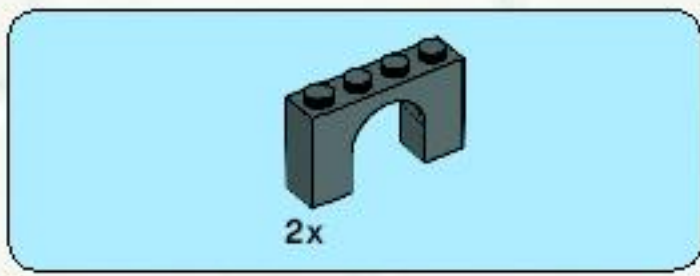

21

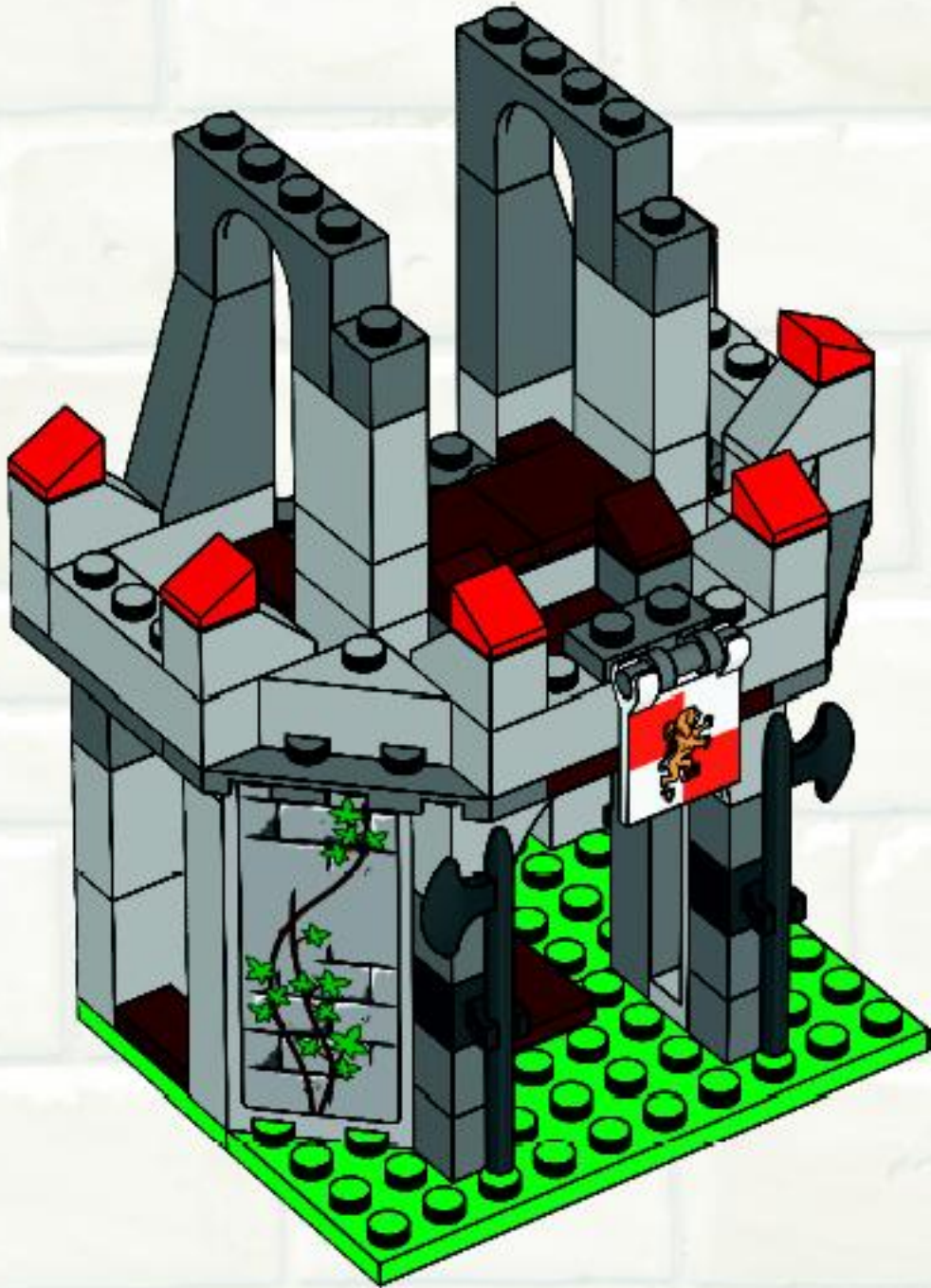

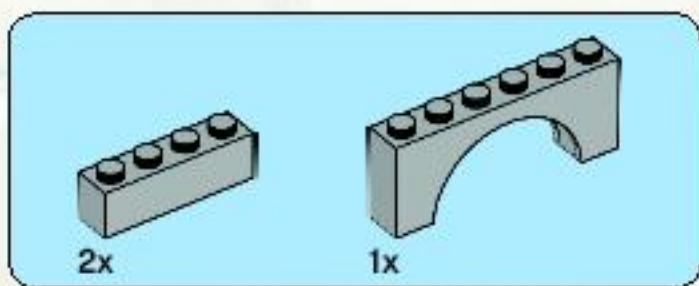

22

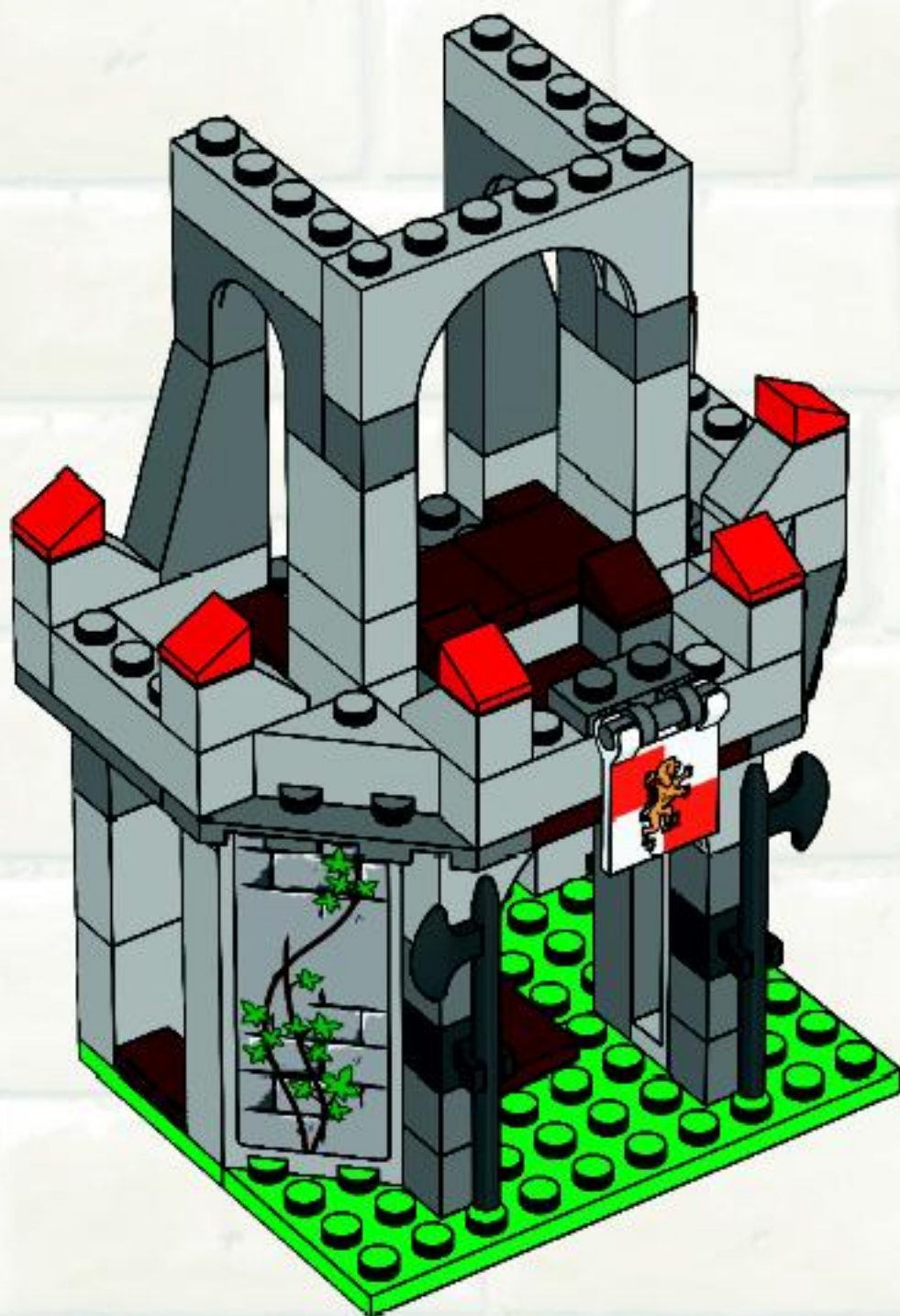

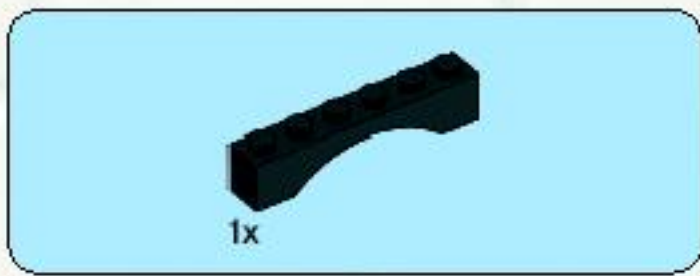

23

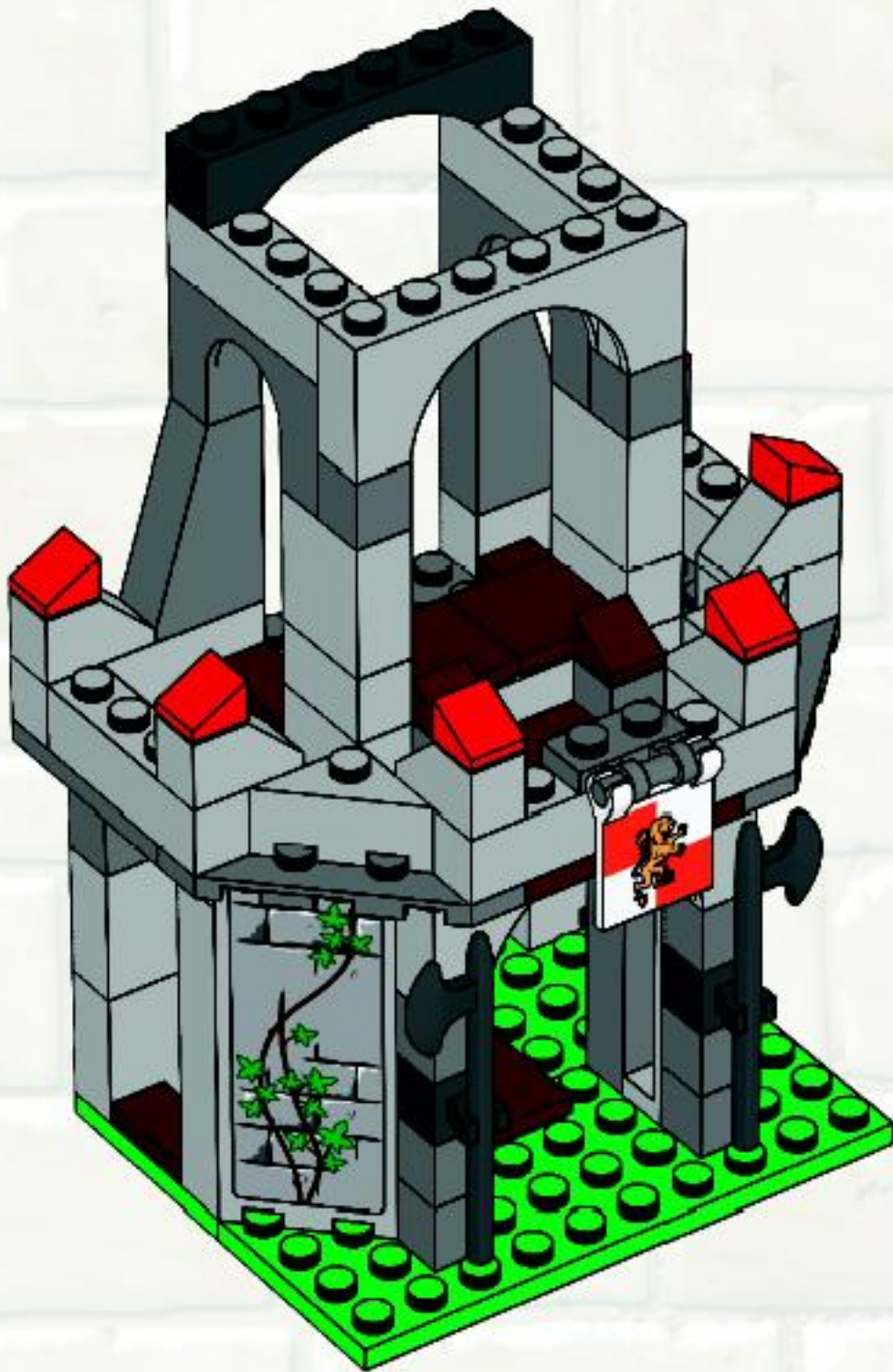

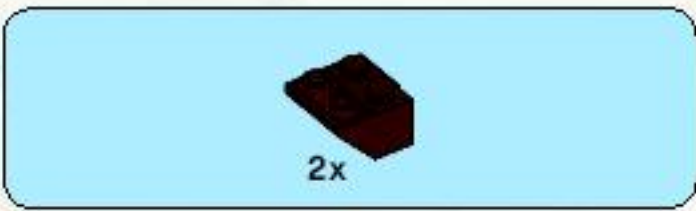

24

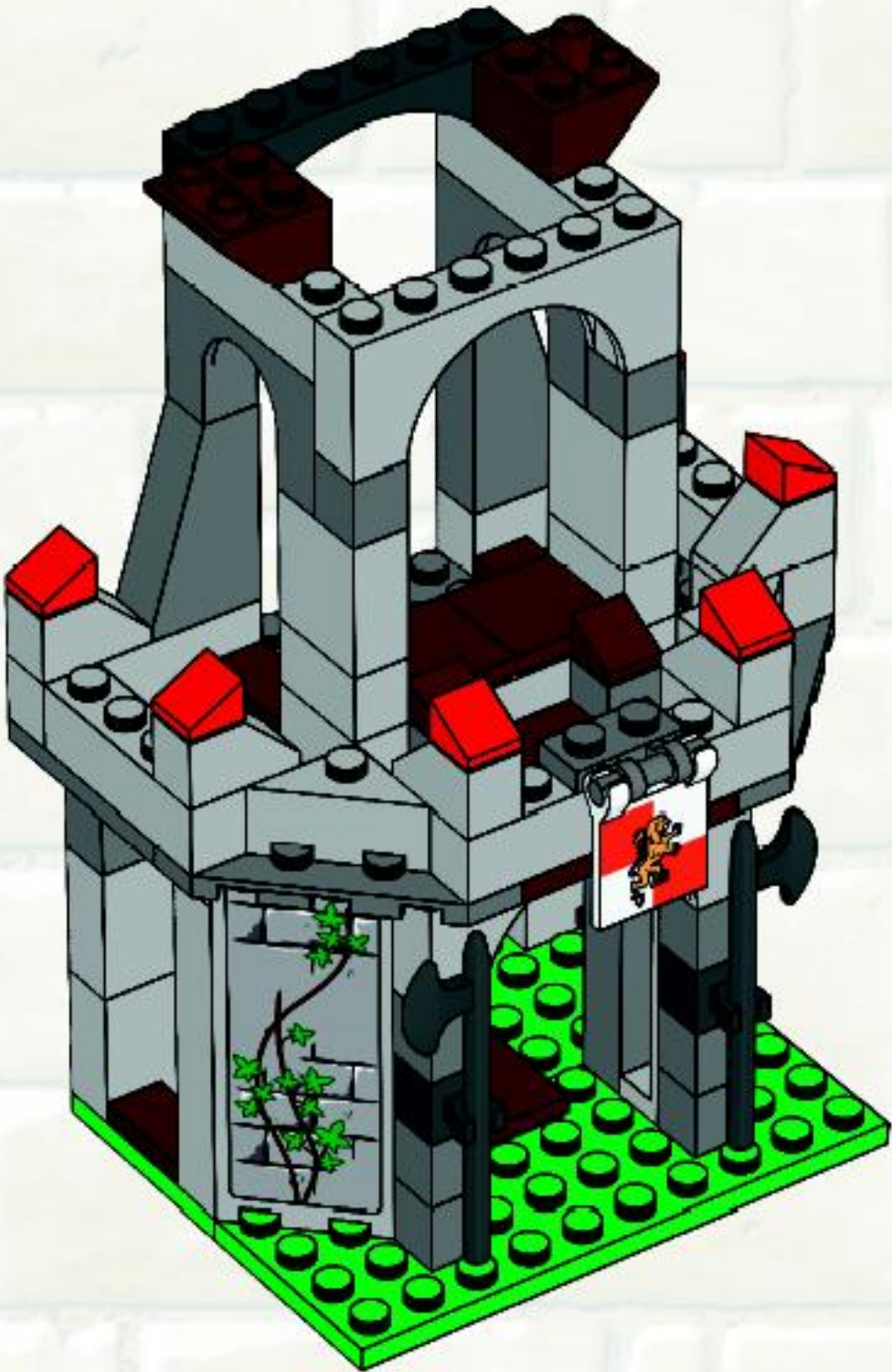



2x



3x

25

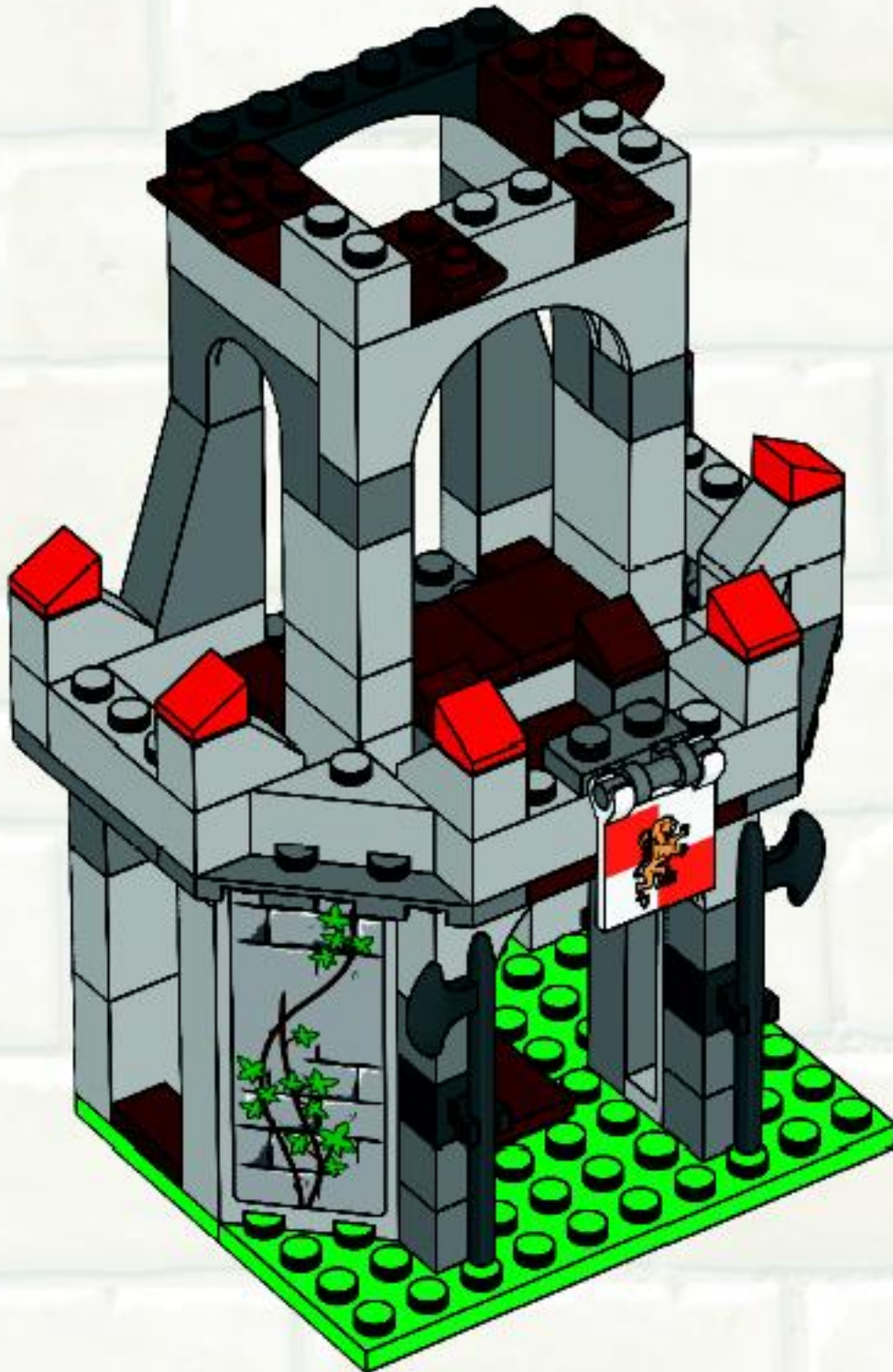



26

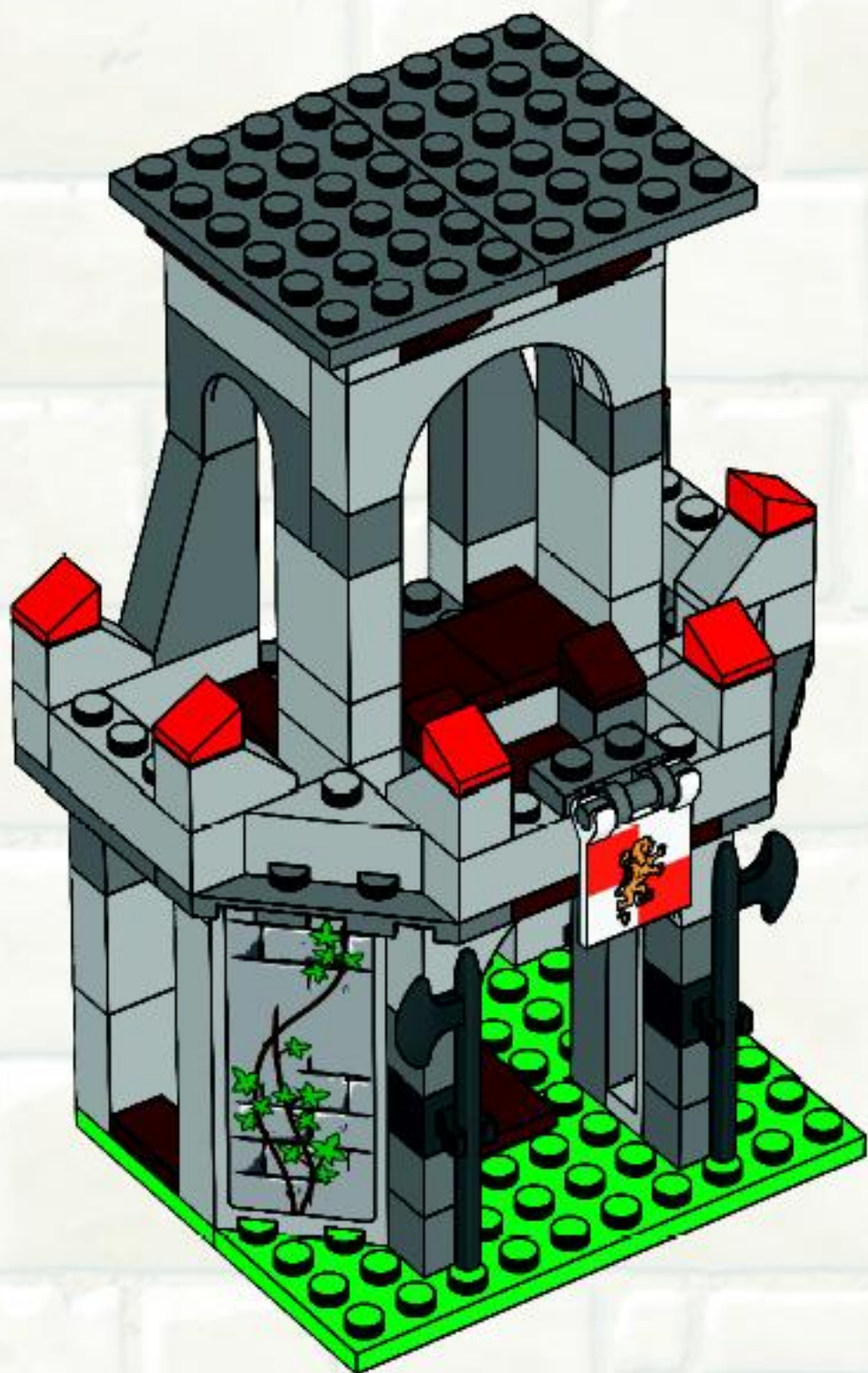

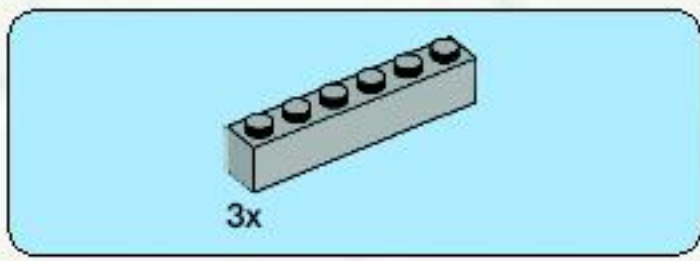

27

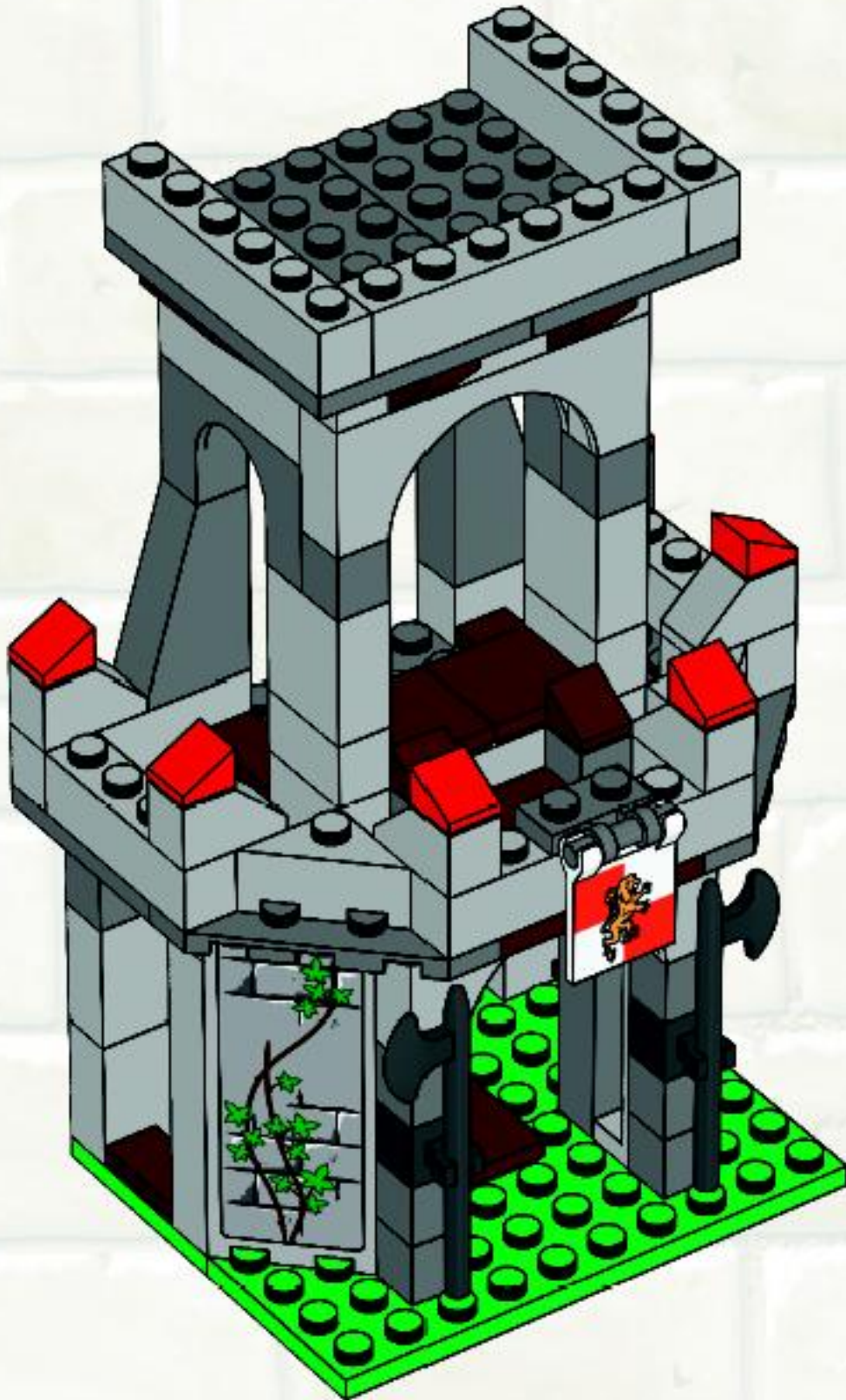



5x

28

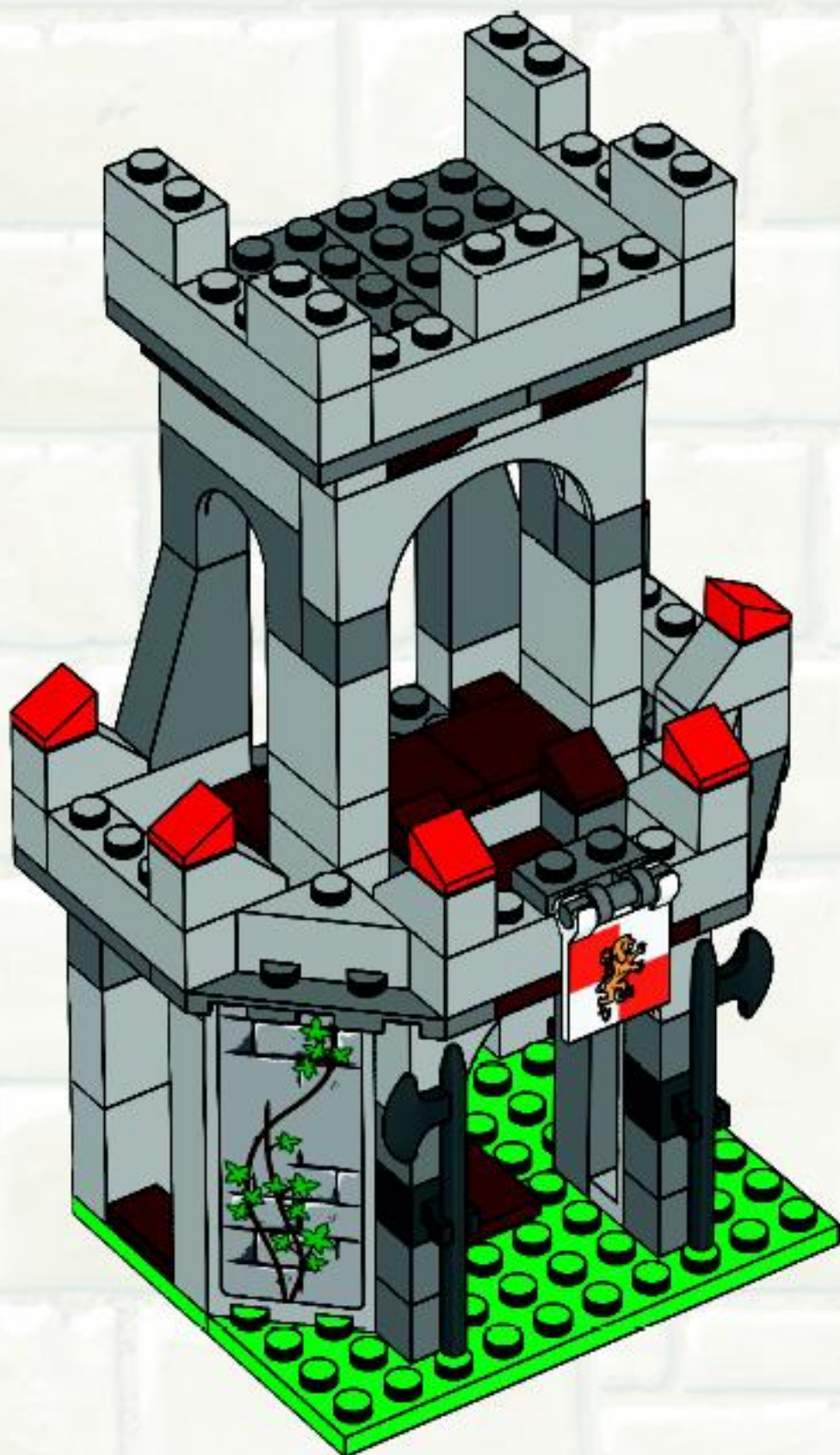



1x



2x

29

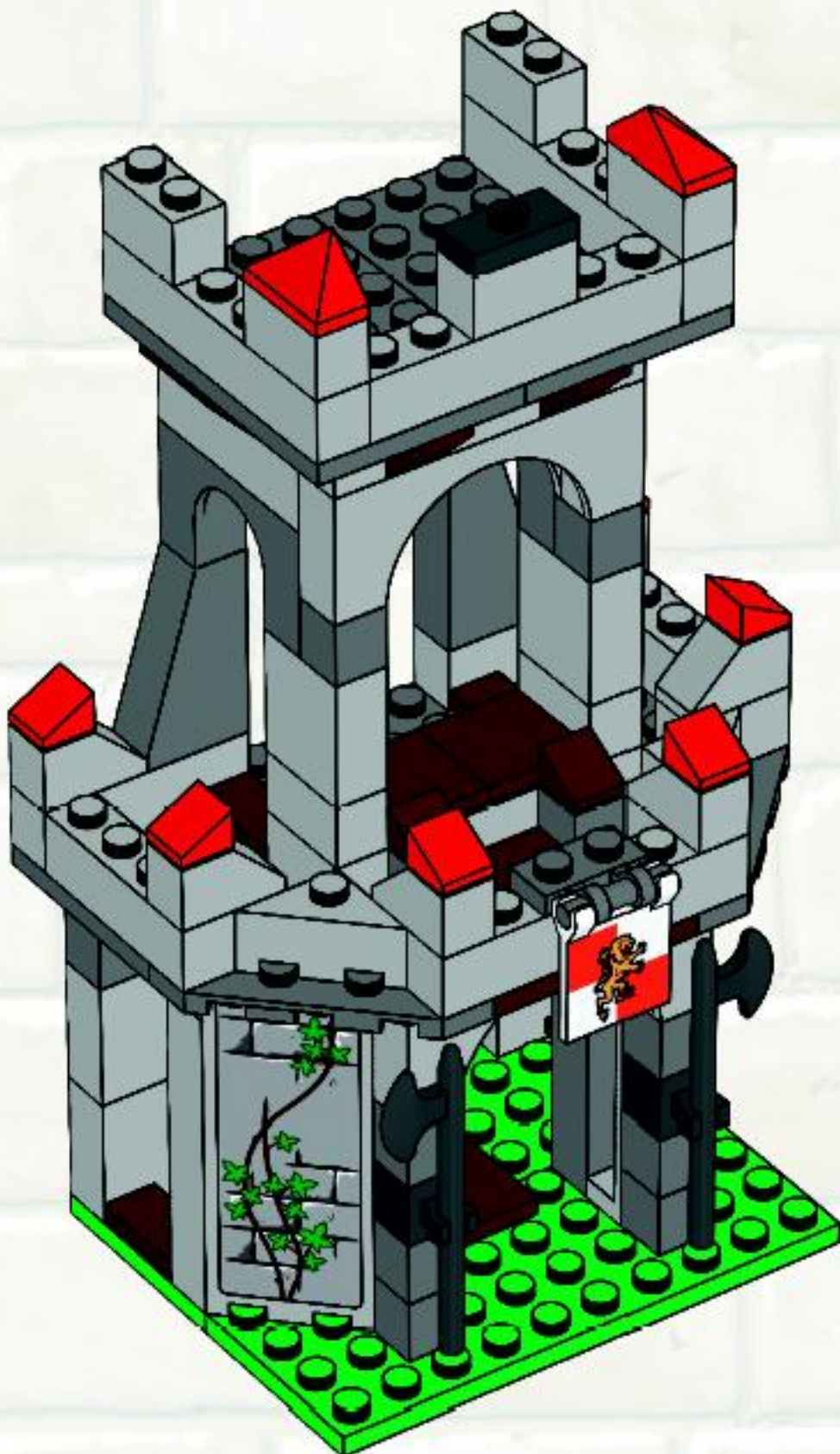

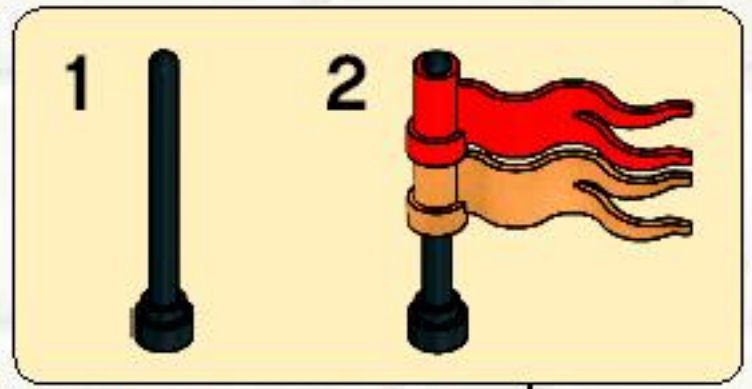
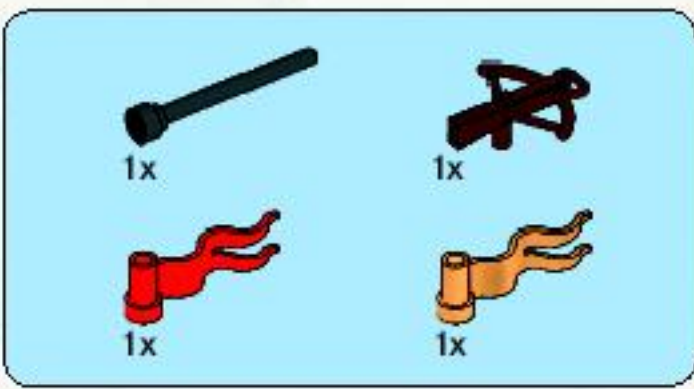

30

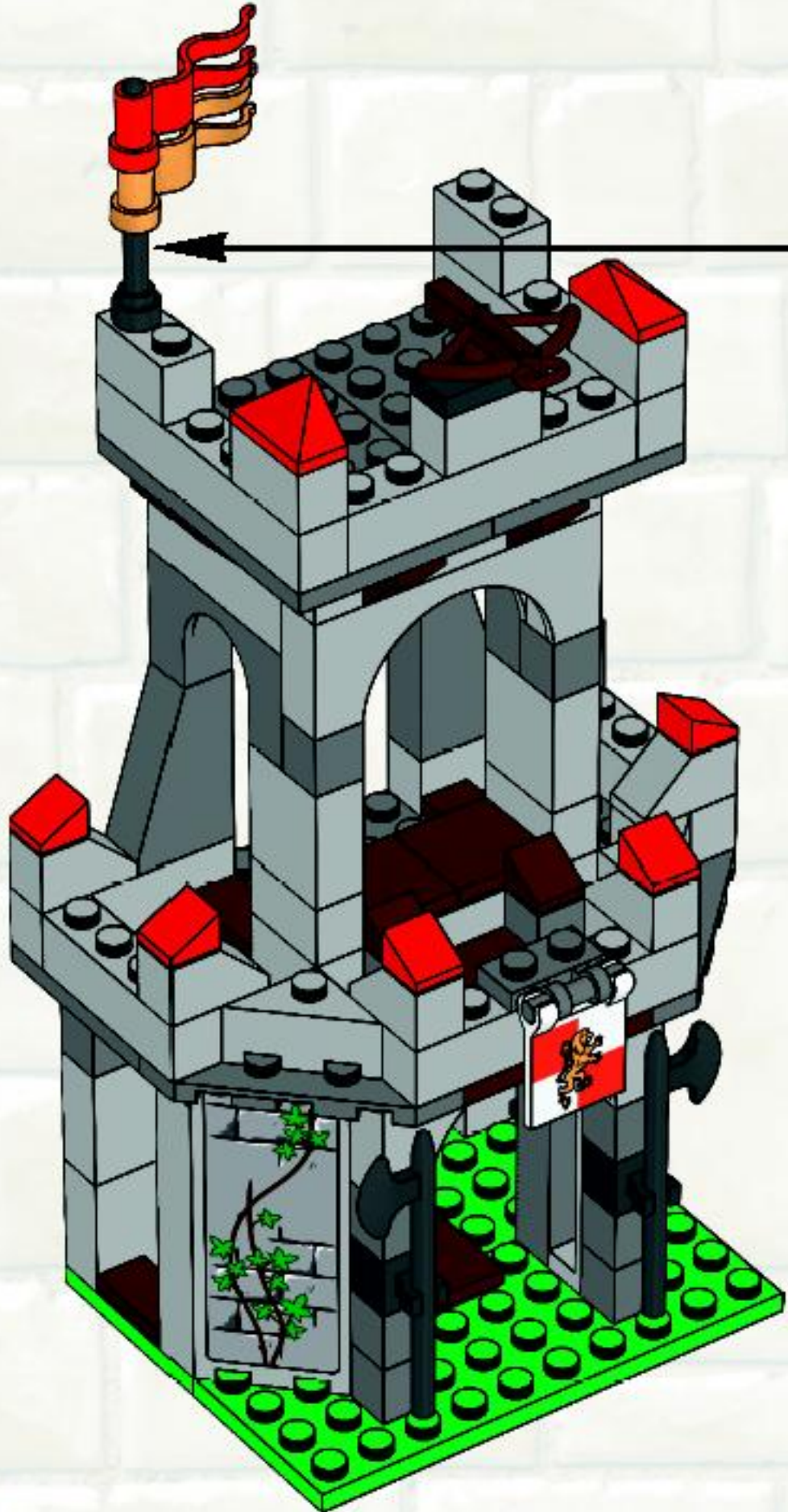

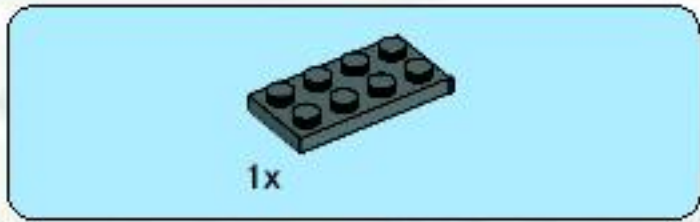
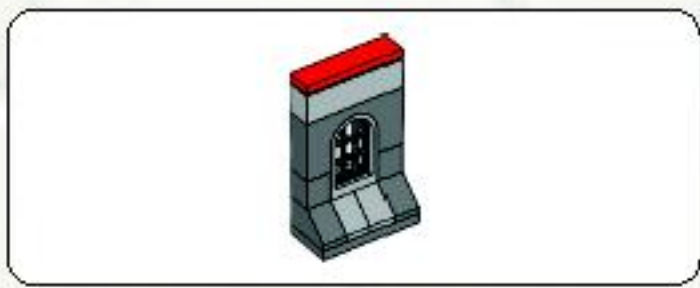

1

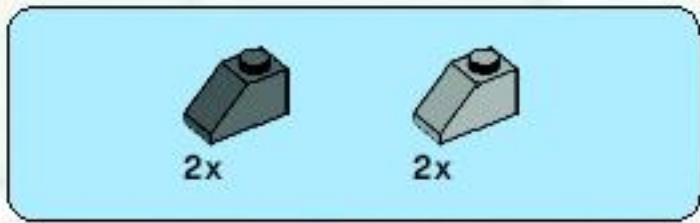

2

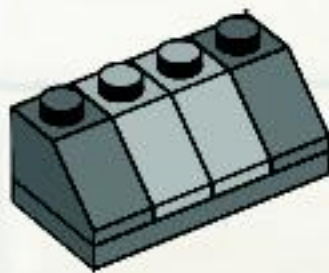

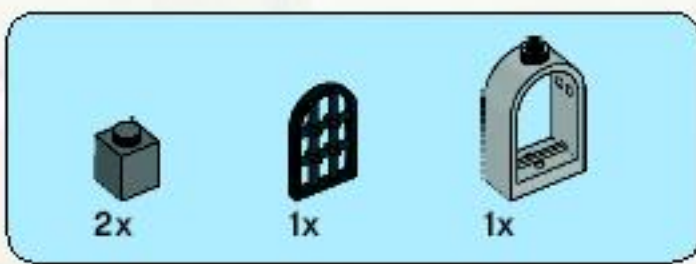

3

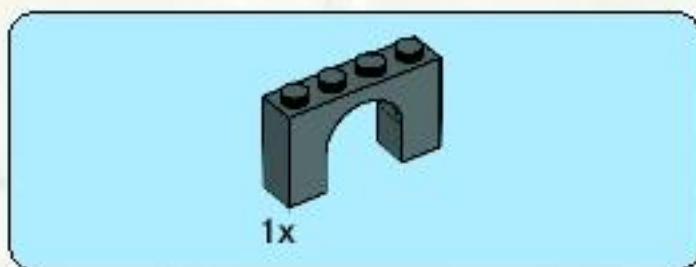
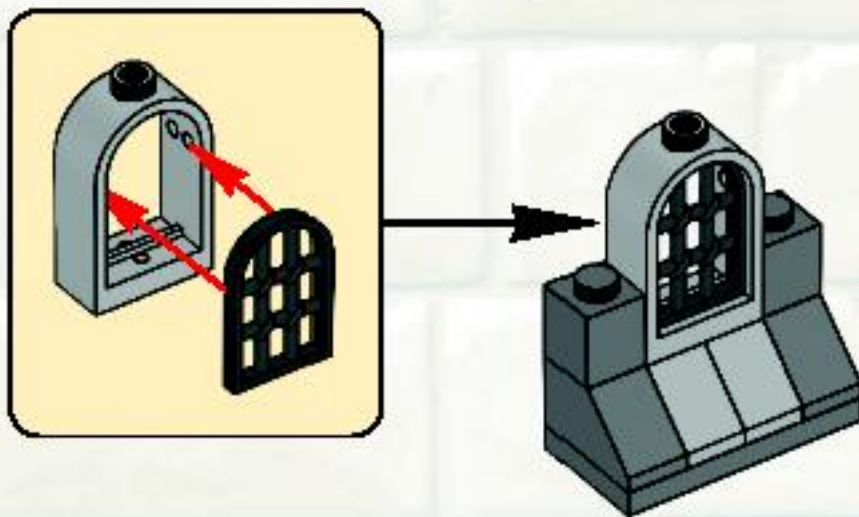

4

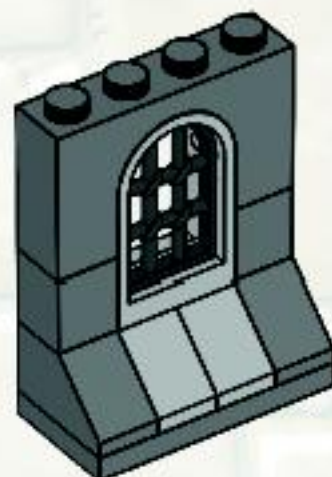

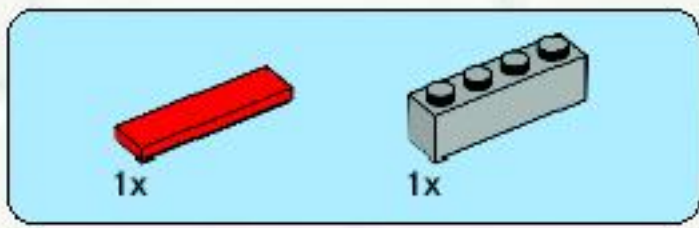

5

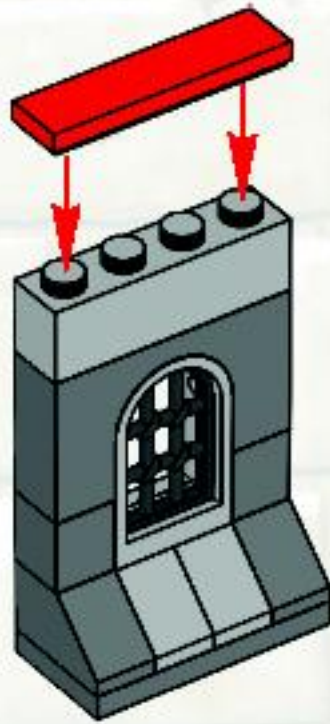

31

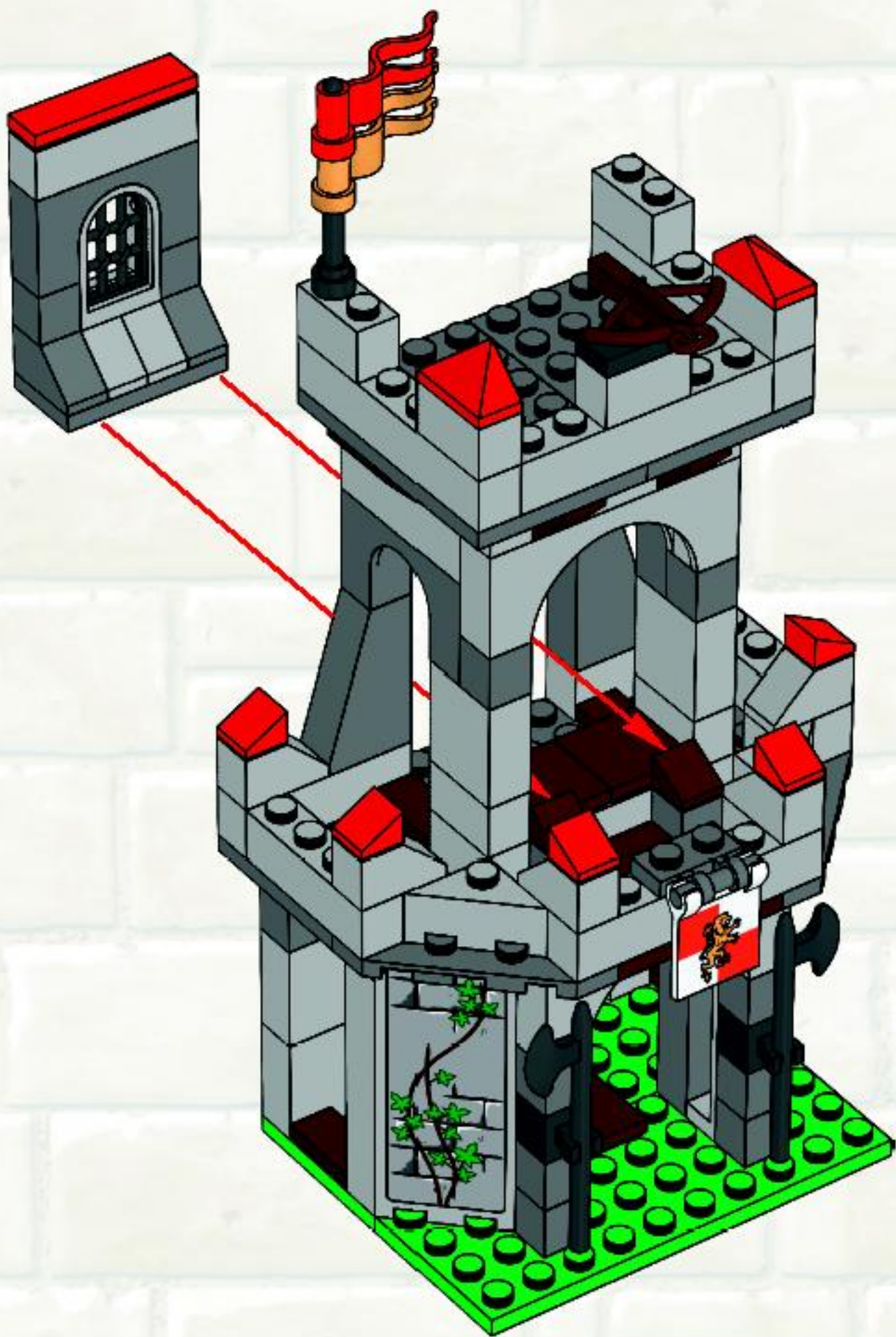





Kingdoms



1x
4538950

1x
4586207

6x
4504379

2x
4195004

1x
243121

1x
449521

1x
4586497

1x
4570043

1x
4528206

1x
4215503

2x
4239601

2x
4533771

4x
4233487

4x
4558957

6x
403226

1x
379426

1x
4105221

1x
395726

1x
9339

2x
4118867

1x
4585481



1x
370526

2x
303426

1x
4587399

1x
345526

1x
4218982

2x
4223986

2x
4270882

1x
4211196

1x
4211160

2x
4211166

2x
4504376

2x
4211222

2x
4211202

4x
4211221

4x
4211197

2x
4211150

4x
4211151

4x
4271949

1x
4243838

1x
4211247



8x
4587002



1x
4504649



1x
4506011



1x
4506014

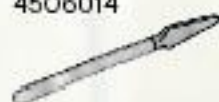

1x
4267358



1x
4540865



12x
4504375



2x
4245566



1x
4586500



2x
4501970



1x
4586290



2x
4586334



2x
4492335



6x
4211564



10x
4211388



7x
4211394



4x
4211393



1x
4211795



2x
4211718



8x
4211614



2x
4211435



1x
4523353



2x
4221600



2x
4563698



1x
4586498



2x
4210690



14x
4211098



2x
4211135



2x
4221745



3x
4558646



1x
4211052



1x
4211065



1x
4210660



2x
4210728



2x
4211115



1x
4210706



Customer Service

Kundenservice

Service Consommateurs

Servicio Al Consumidor

www.lego.com/service or dial



: 00800 5346 5555

: 1-800-422-5346

FREE! GRATIS! GRATUIT!



club
MAGAZINE™

www.LEGOclub.com



00800 5346 5555*



1-866-534-6258 • 1-877-518-5346

US & Canada only

Canada seulement

* Freephone. Mobile charges may apply. * Nummer sans Frais. Les Frais peuvent s'appliquer avec les téléphones cellulaires.
* Gebührenfrei. Kosten für Anrufer aus Mobilfunknetzen können anfallen. * Gratis telefonnummer vanaf vast te lijn.
* Het er ett gratis nummer, när du ringer från Postbetala. * Det är gratis, när du ringer från en Post betala.



**VISIT THE WORLD'S
BIGGEST LEGO® SHOP!**

www.LEGOshop.com

7946



7947



7948



7949



7950





WIN!

Go to www.nielsen.com/LEGO
to fill out a survey for a chance
to win a cool LEGO® Product.
No purchase necessary.
Open to all residents where not prohibited.



www.nielsen.com/LEGO

GEWINNE!

Nimm an der Umfrage auf www.nielsen.com/LEGO teil und hab die Chance ein cooles LEGO® Produkt zu gewinnen! Die Teilnahme am Gewinnspiel führt zu keinerlei Kaufverpflichtungen. Teilnahme in allen nicht ausgeschlossenen Ländern möglich.

WIN!

Ga naar www.nielsen.com/LEGO, vul een enquêteformulier in en maak kans op een cool LEGO® product. Geen aankoopverplichting. Iedereen mag deelnemen, uitgezonderd ingezetenden van landen waar een enquêteverbod geldt.

GAGNE!

Visite www.nielsen.com/LEGO pour répondre à un questionnaire et avoir une chance de gagner un produit LEGO® très cool! Aucune obligation d'achat. Ouvert à tous les résidents des pays autorisés.

当てよう!

www.nielsen.com/LEGO にアクセスして、アンケートにご記入ください。当選者にはレゴ製品を差し上げます。お買い上げの必要はありません。禁止されていない限り、すべての管轄にご利用いただけます。