



PHARAOH'S QUEST

7327



1

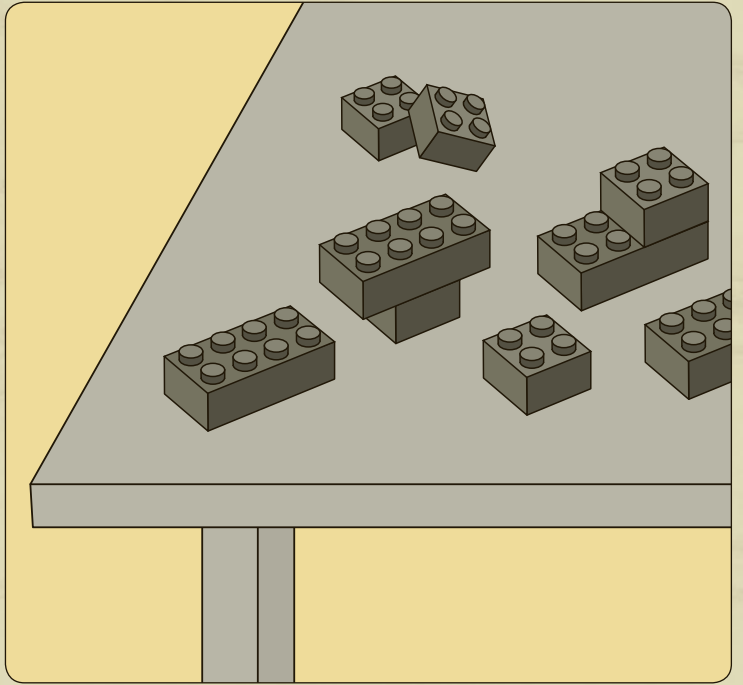
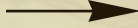
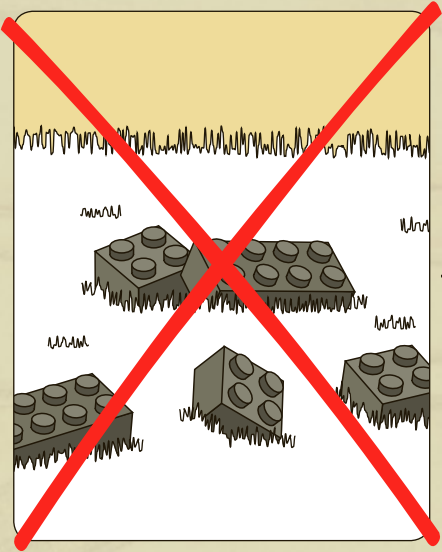

2

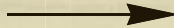



1



3

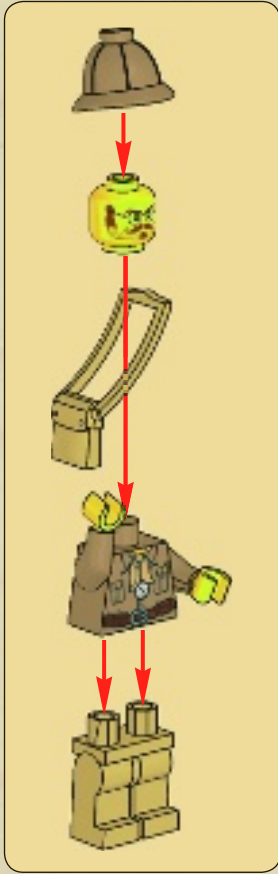

4

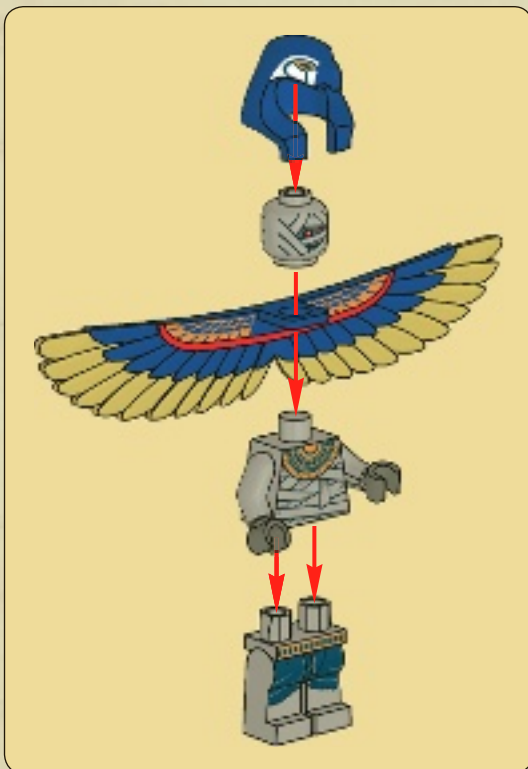

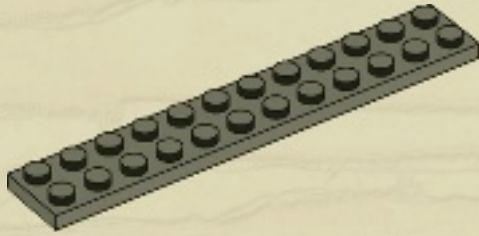
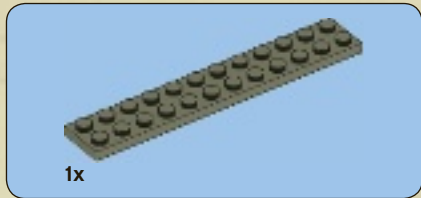
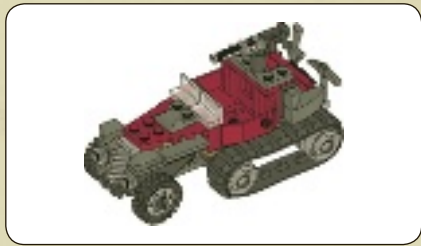

1

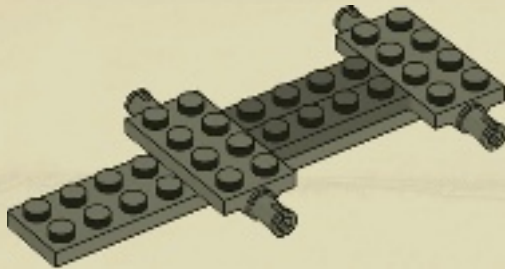
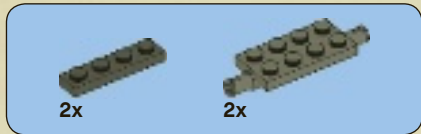

2

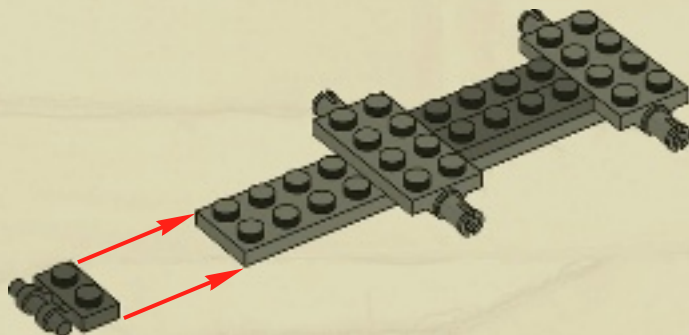
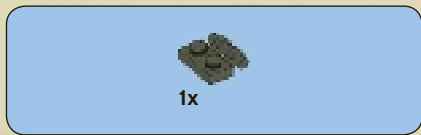

3



4

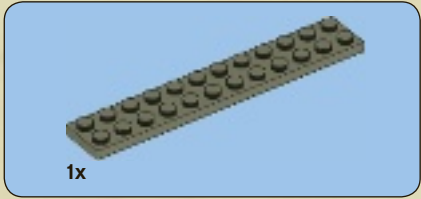
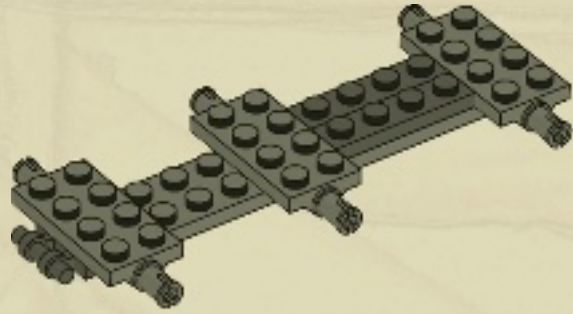

5

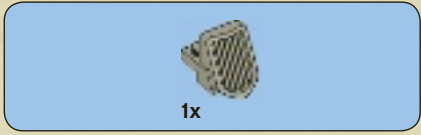
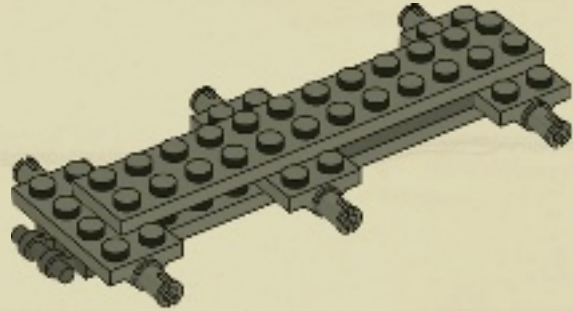

6

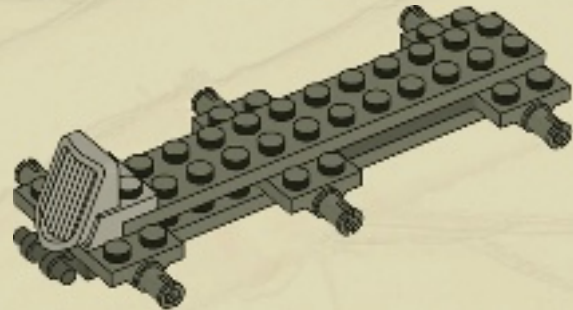



4x

7

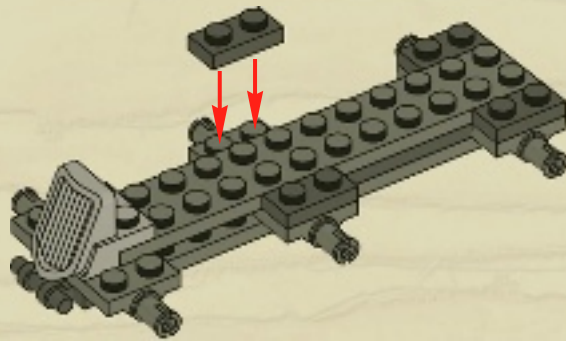

1x



2x



2x

8

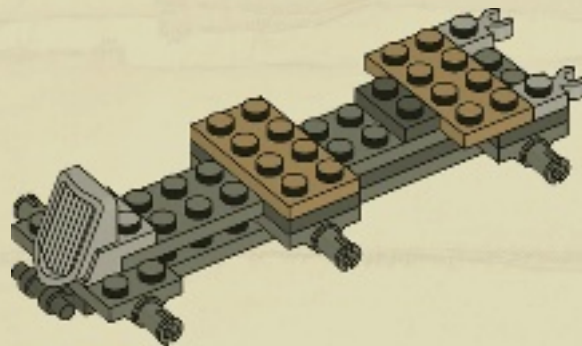

2x



2x

9

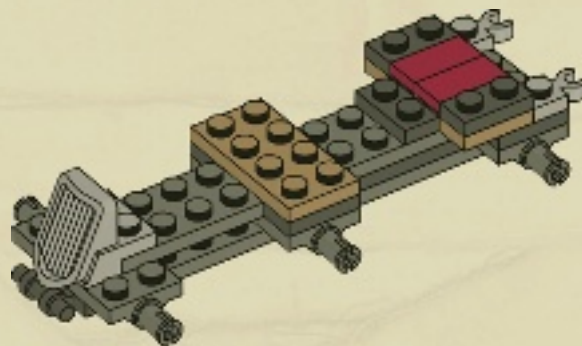



1x



2x

10

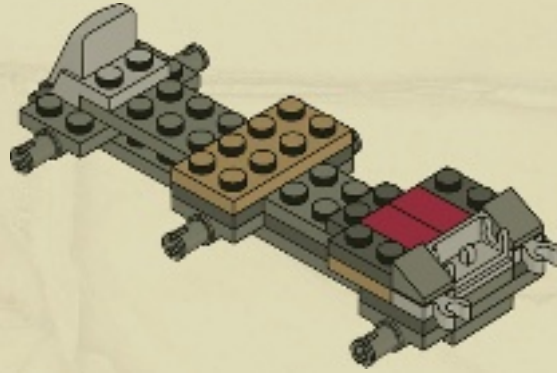

4x

11



2x

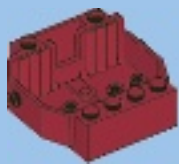
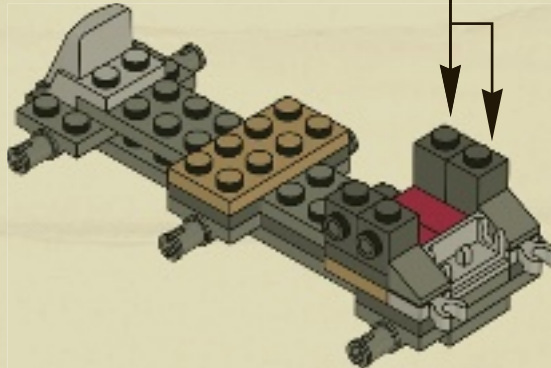

1x

12

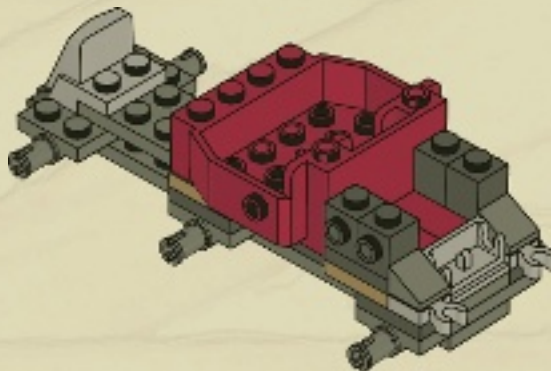



13

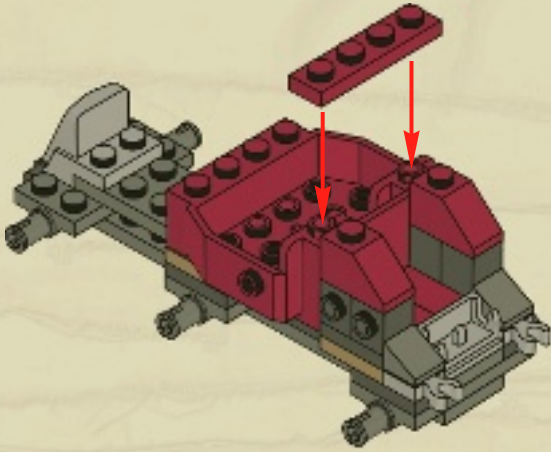

14

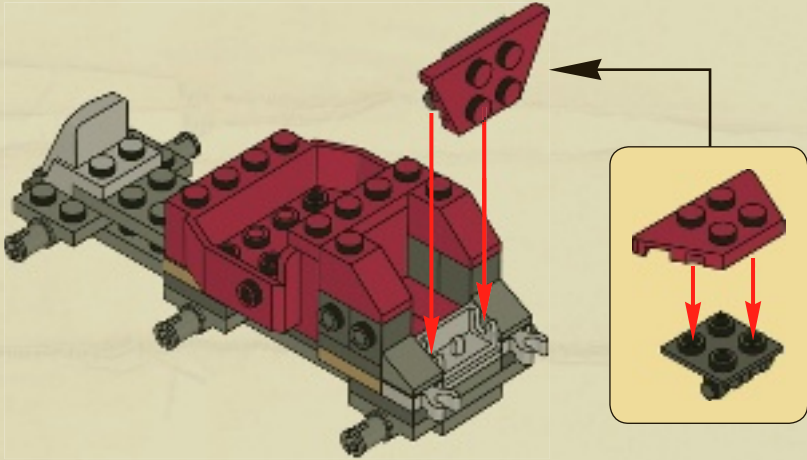

15

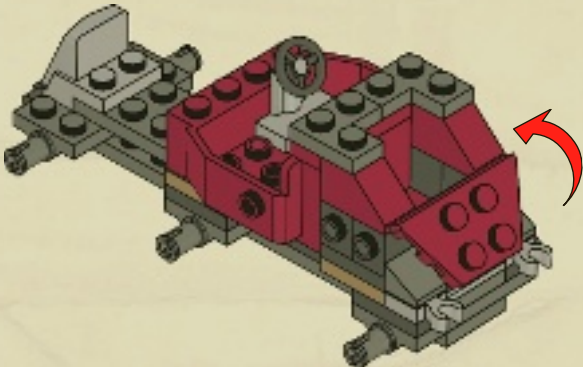



3x

16

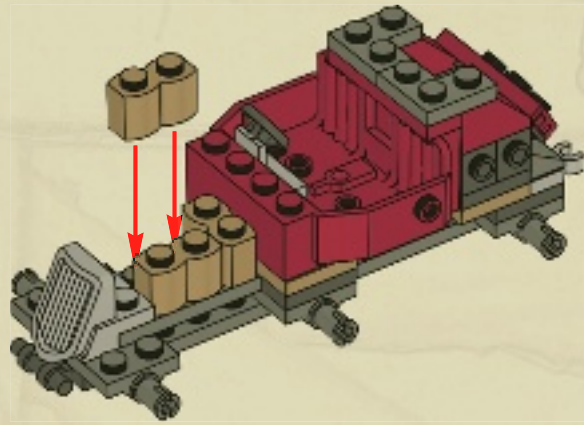

2x

17

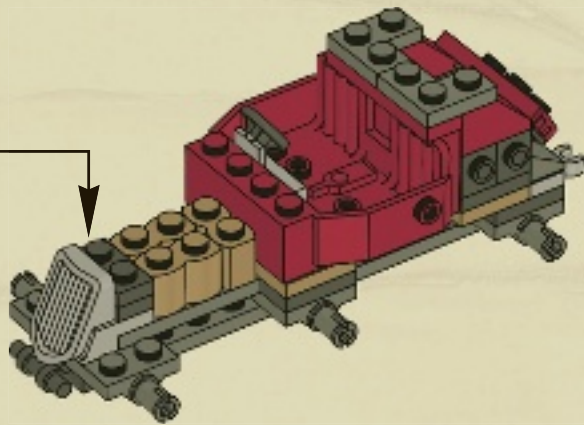
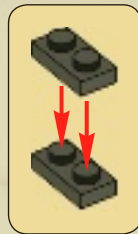

2x



2x

18

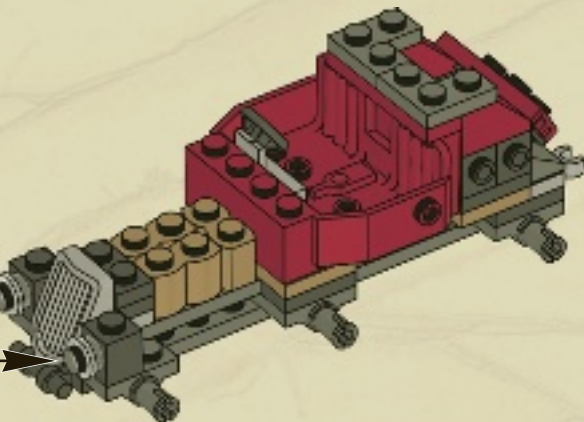
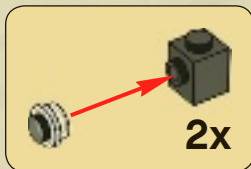



19

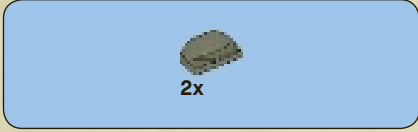
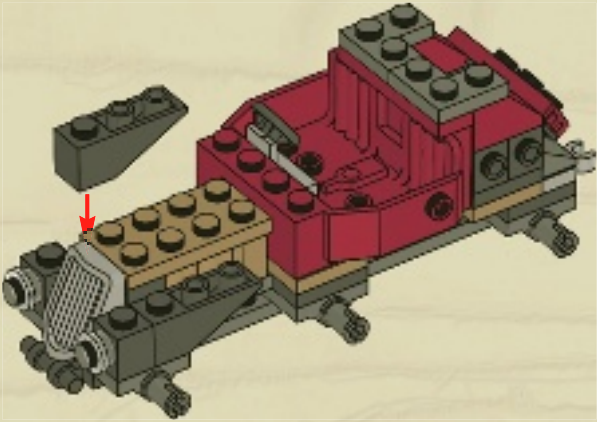

20

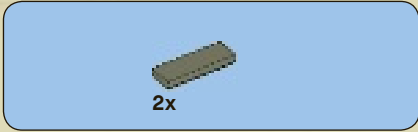
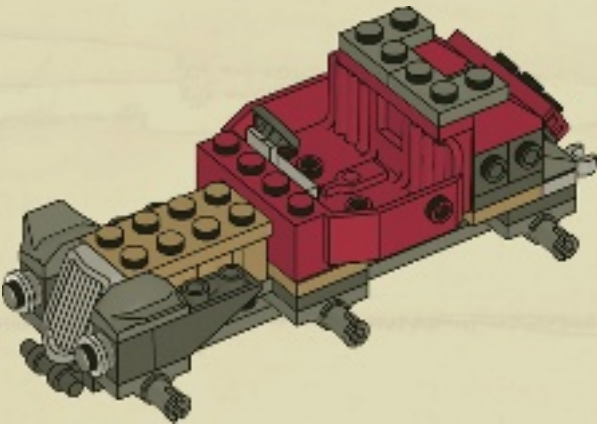

21

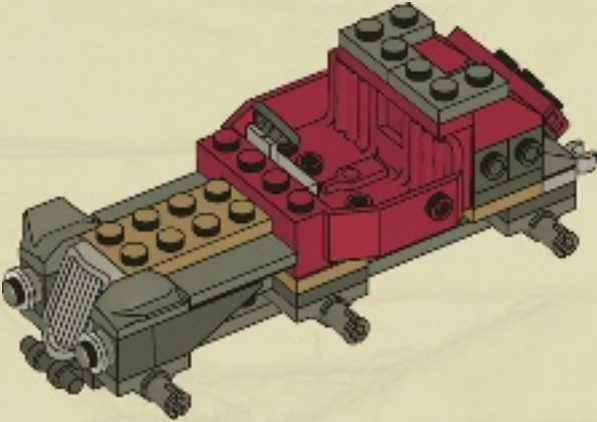



2x



1x

22

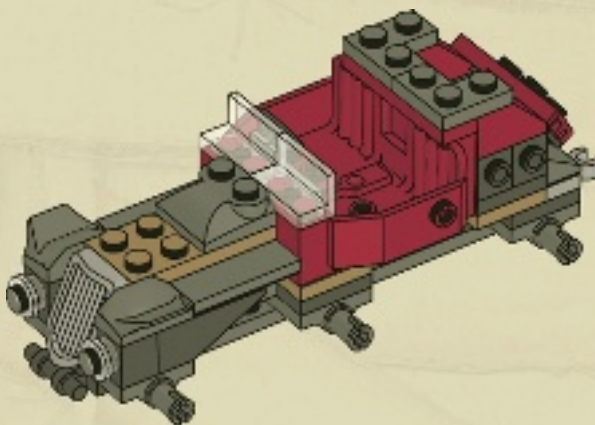

1x

23

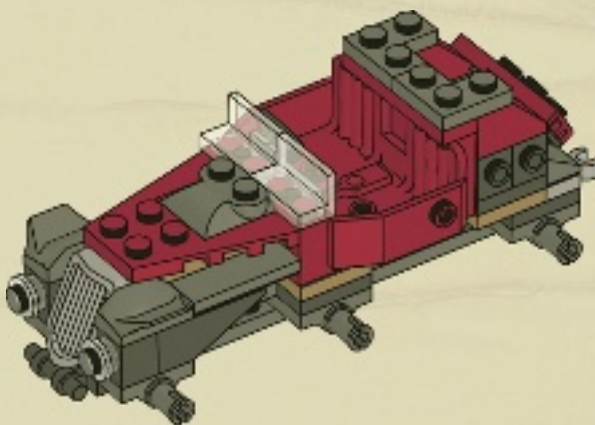

4x



2x



2x

24

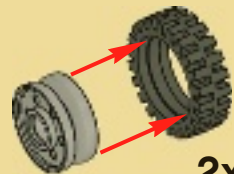
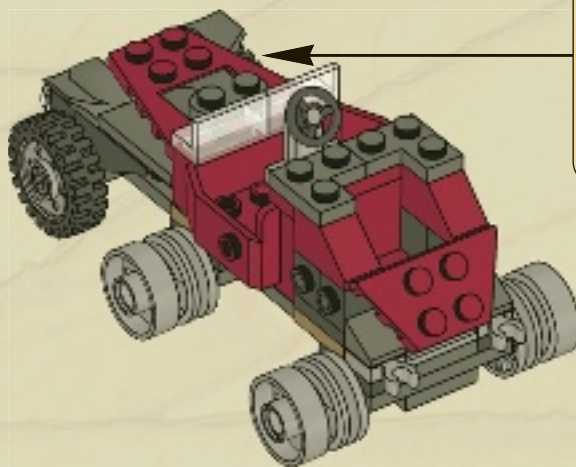

2x

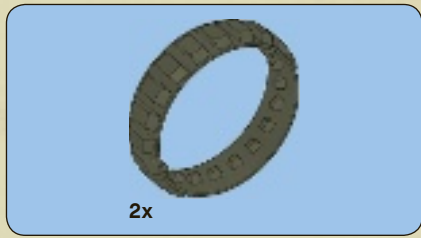

25

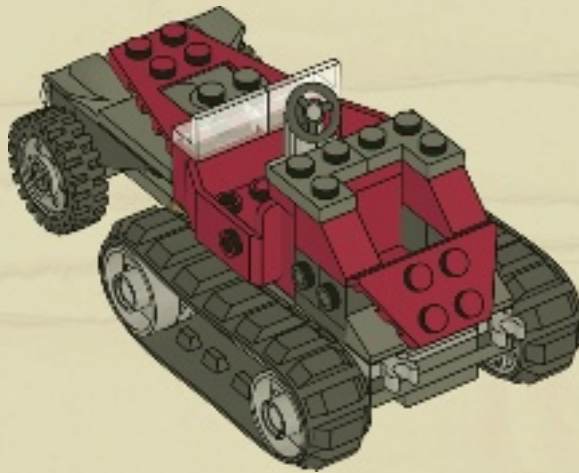

26

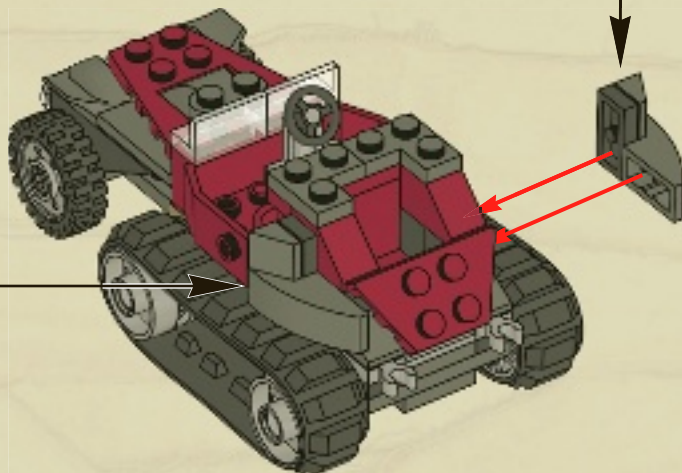
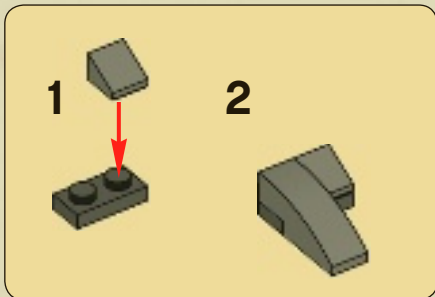
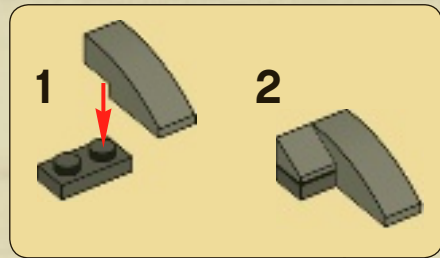



27

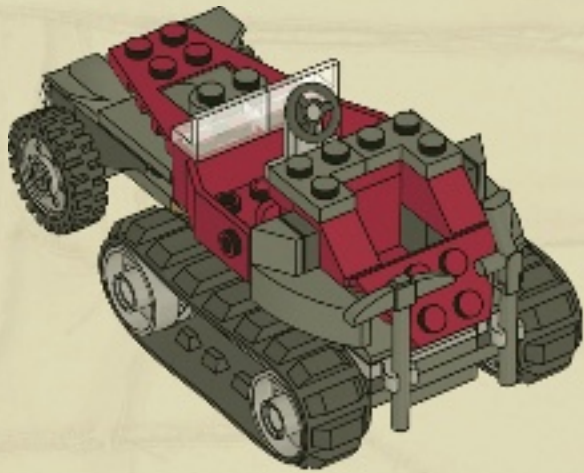

28

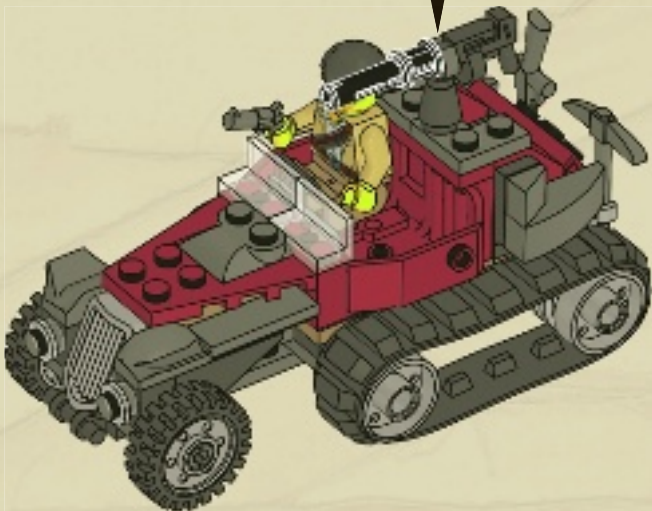

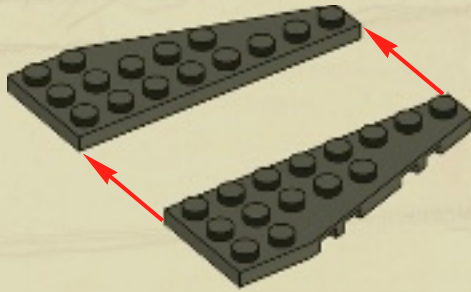
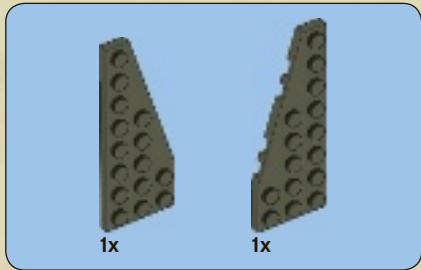
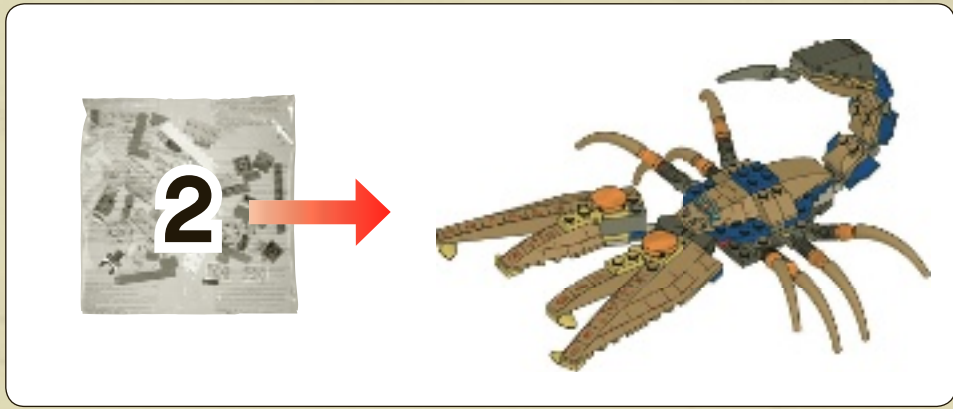

1

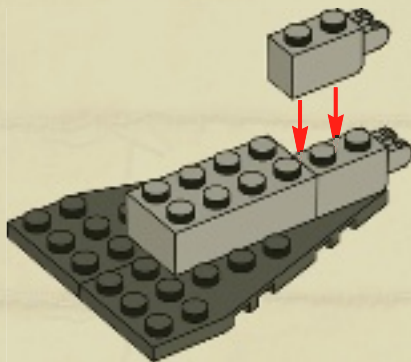

2

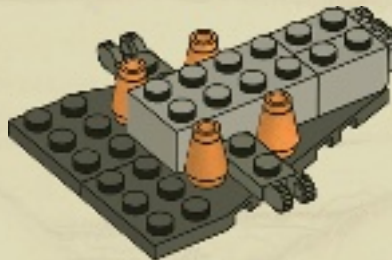
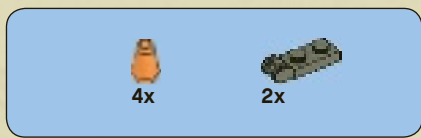

3



4

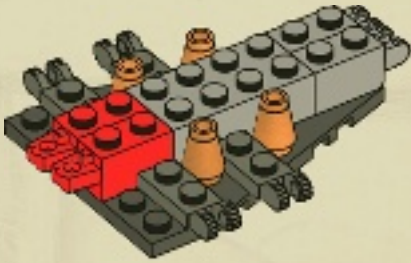

5

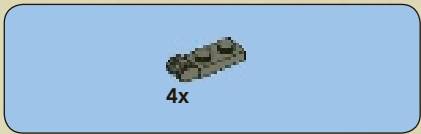
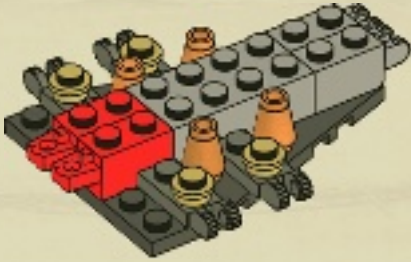

6

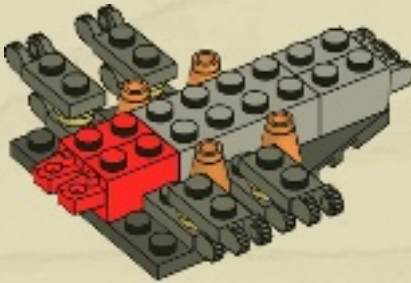



7

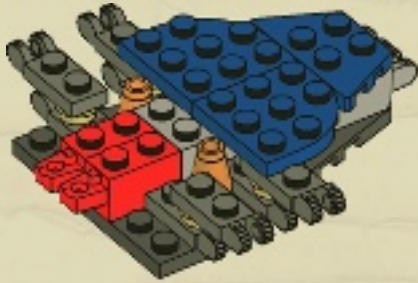

8

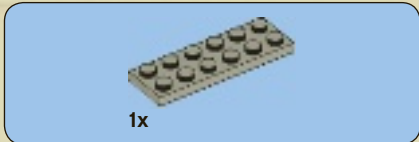
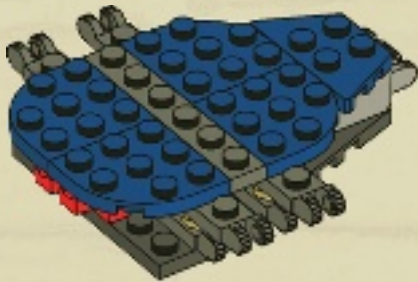

9

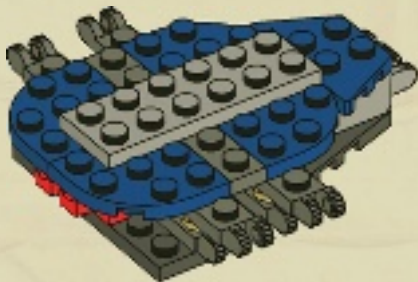



10

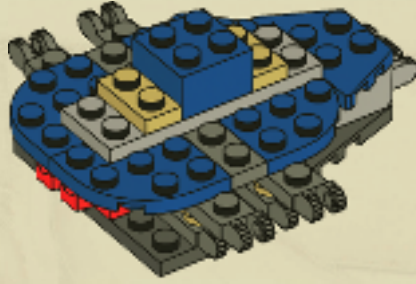

11

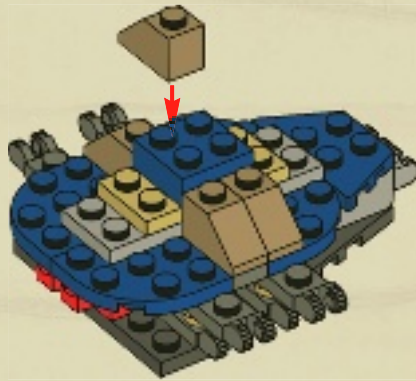

12

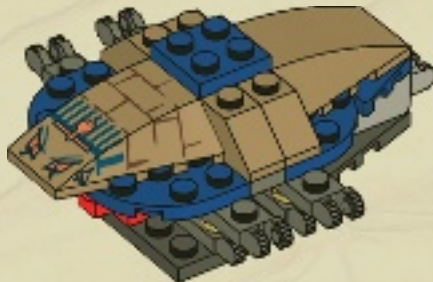

13

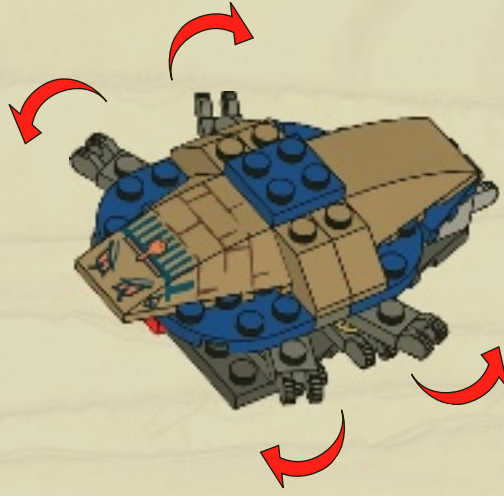

14

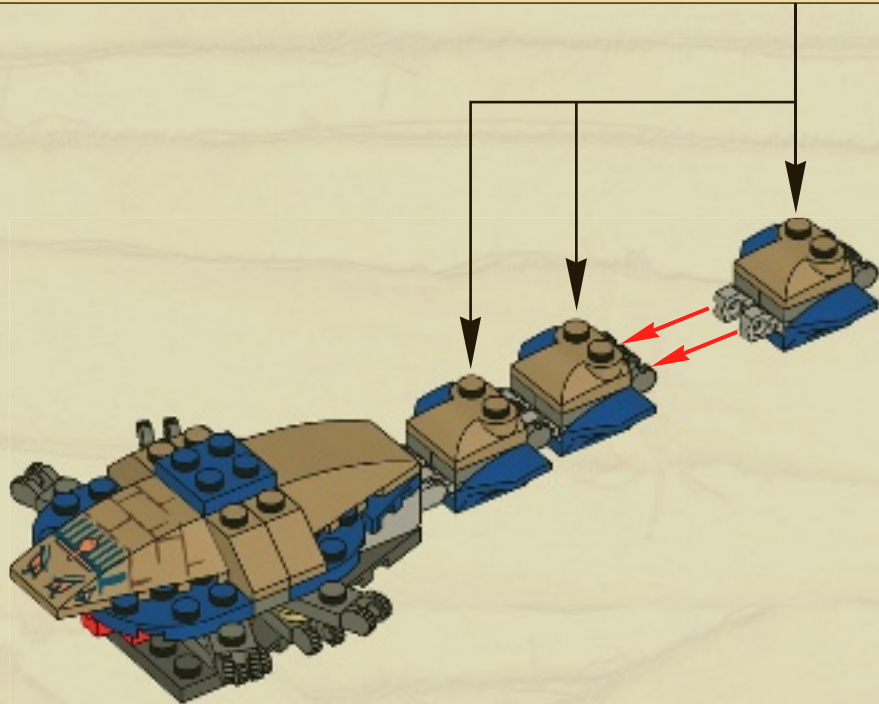
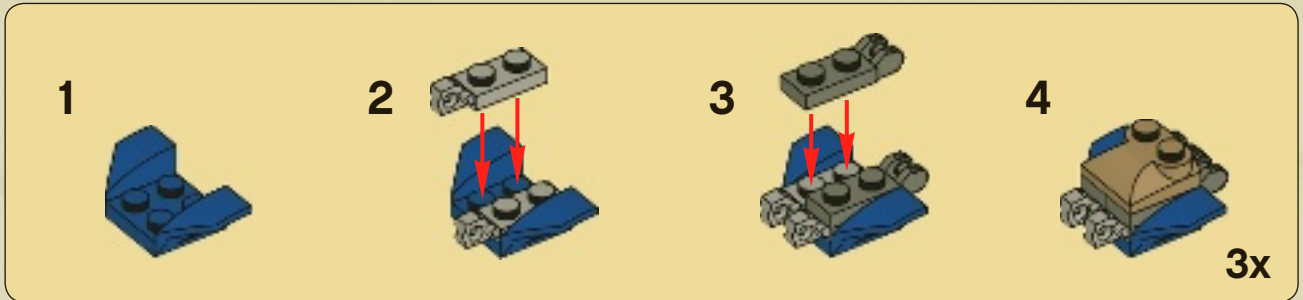

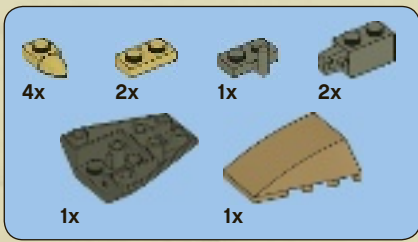

15

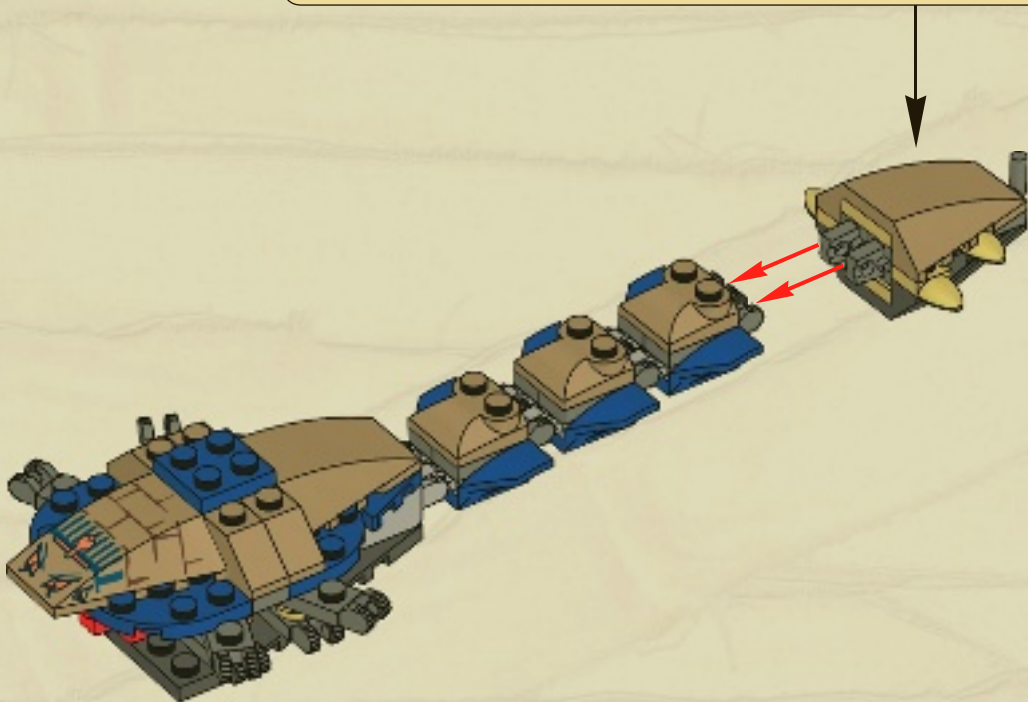
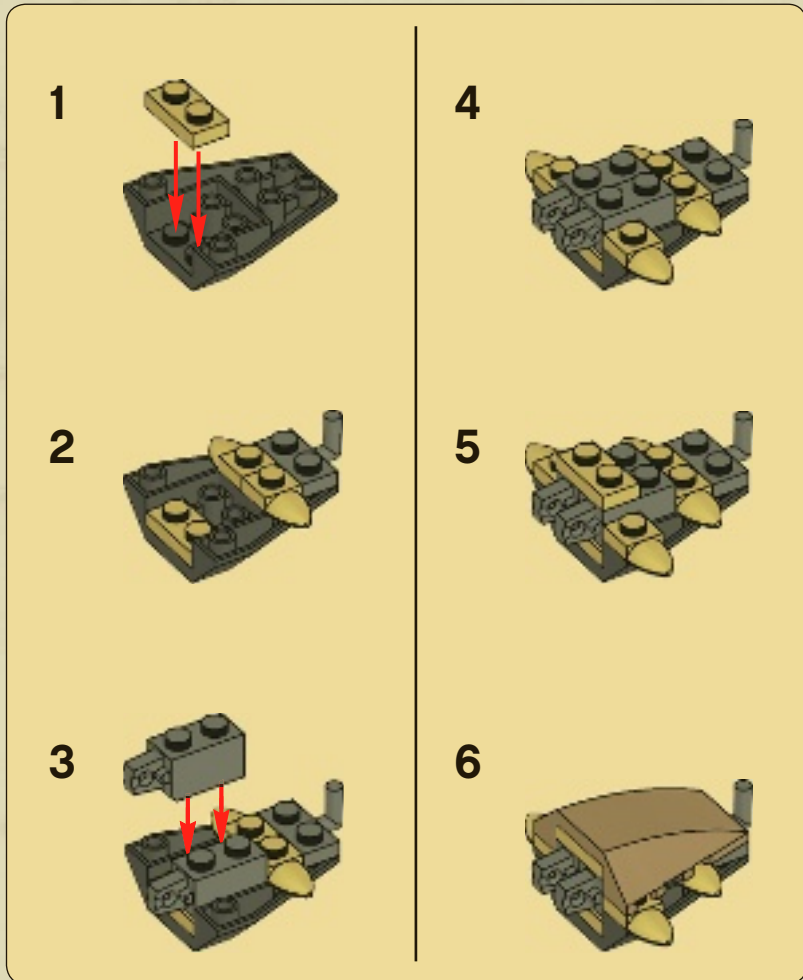



16

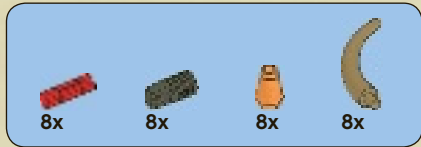
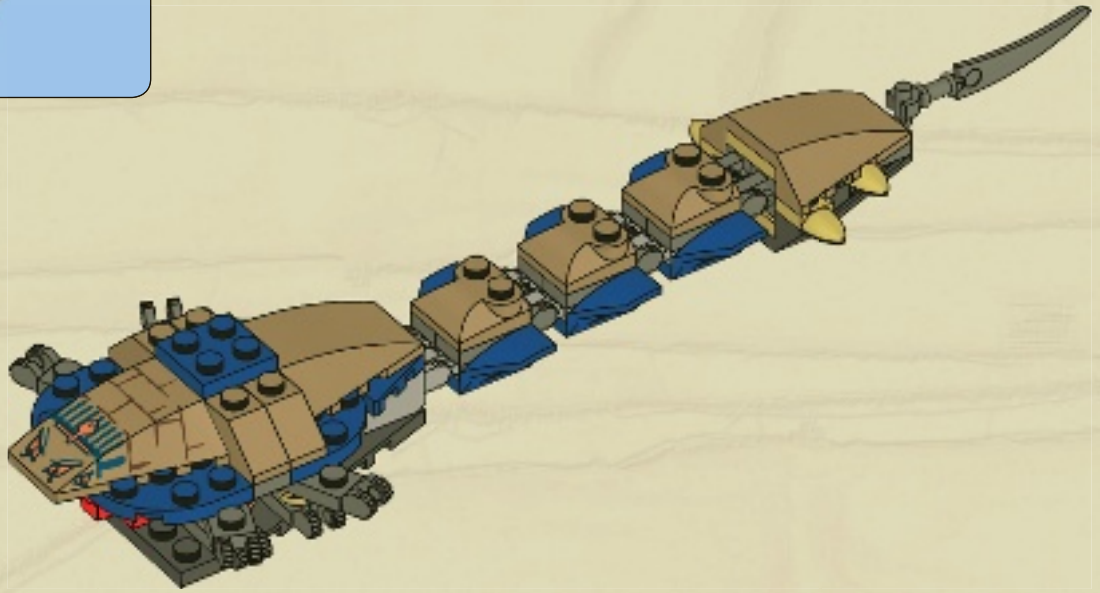

17

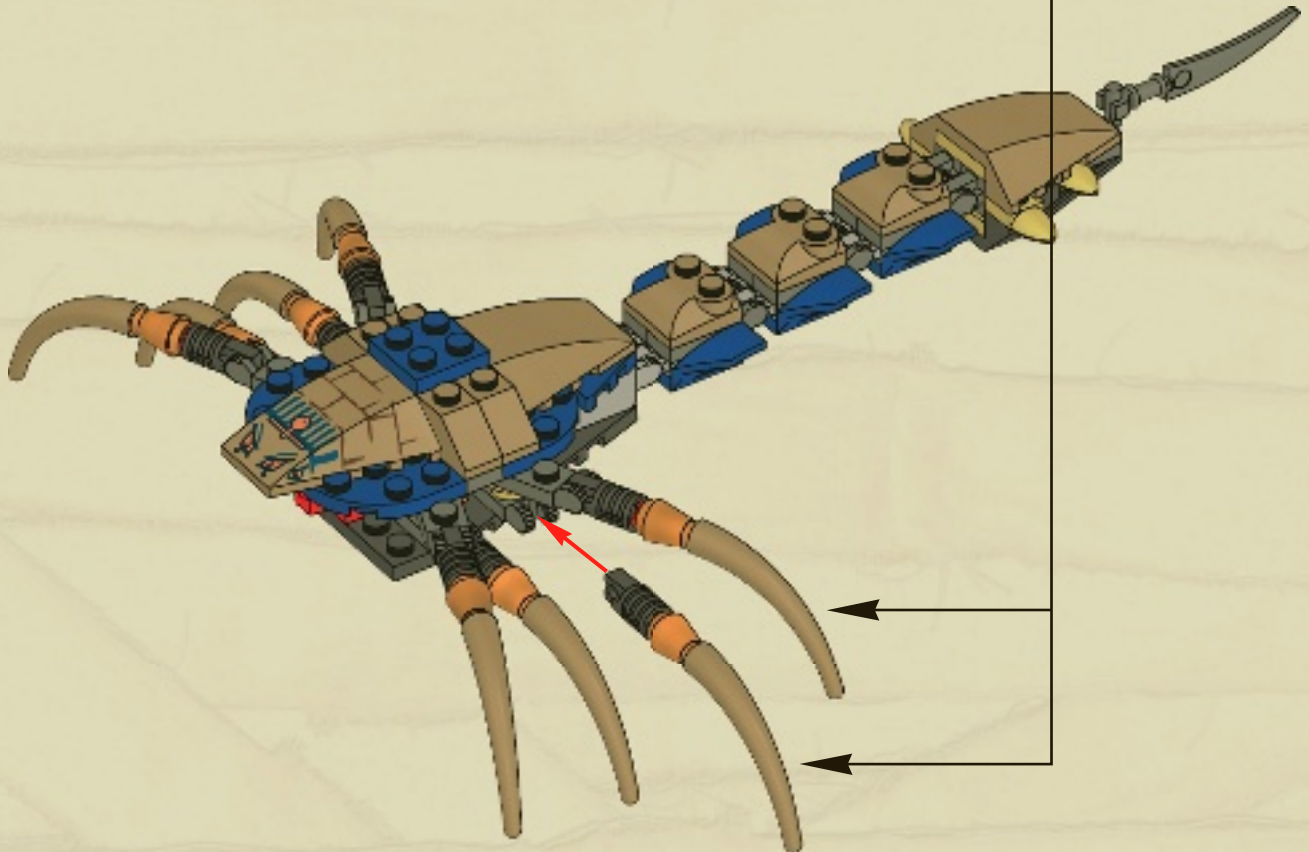



18

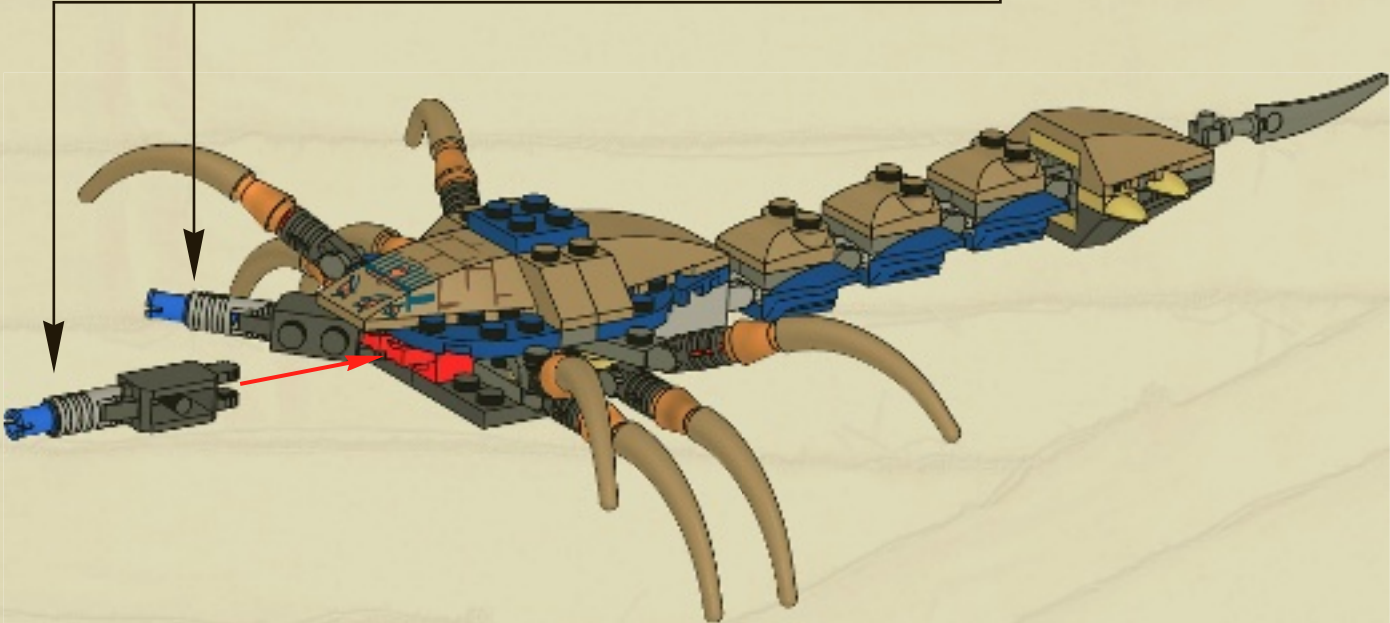

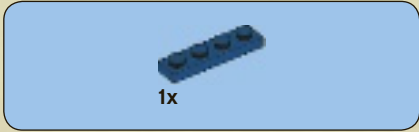
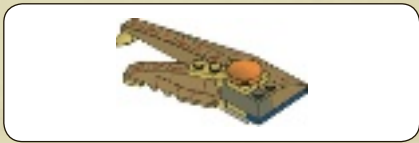

1x

1

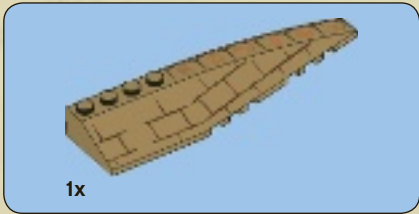

1x

2

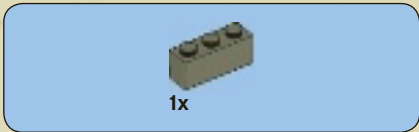
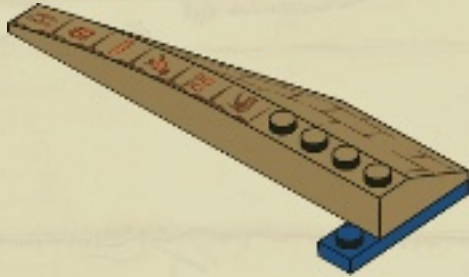

1x

3

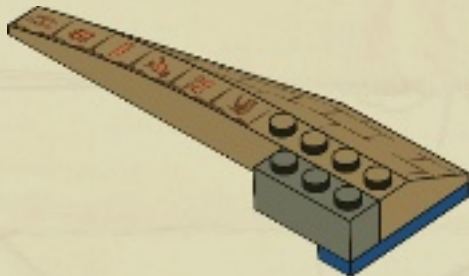

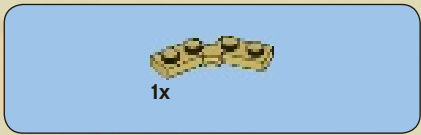

4

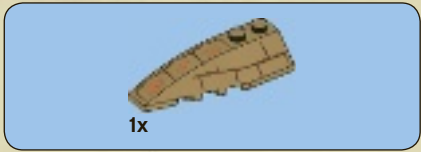
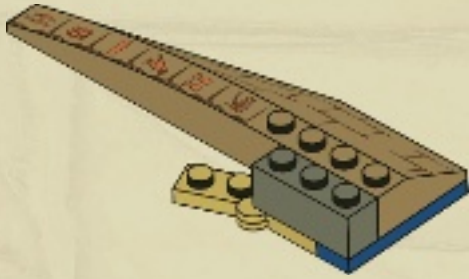

5

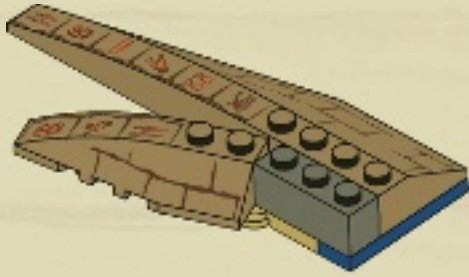

6

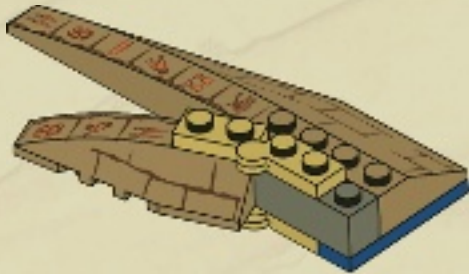



1x

7

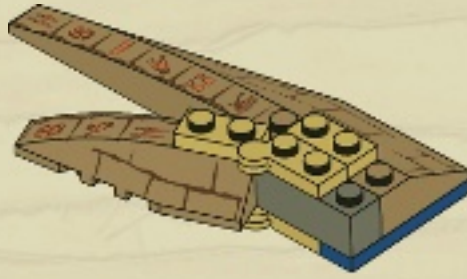

1x

8

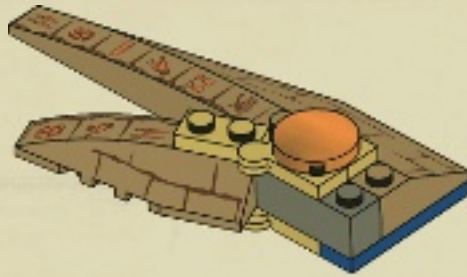

3x



1x

9

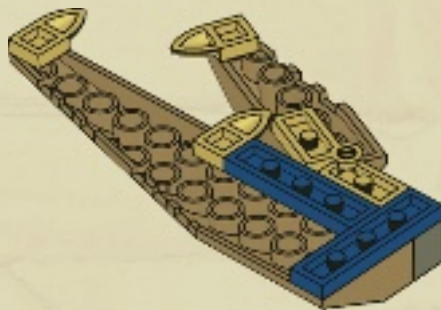
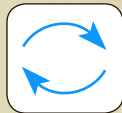



10

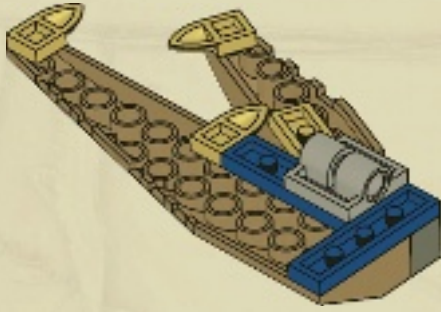

11

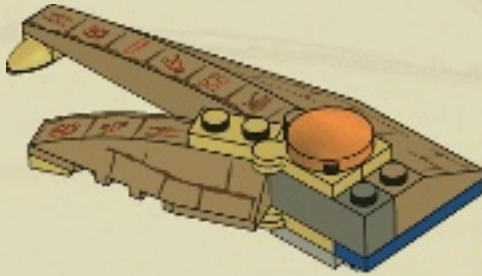
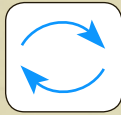

19

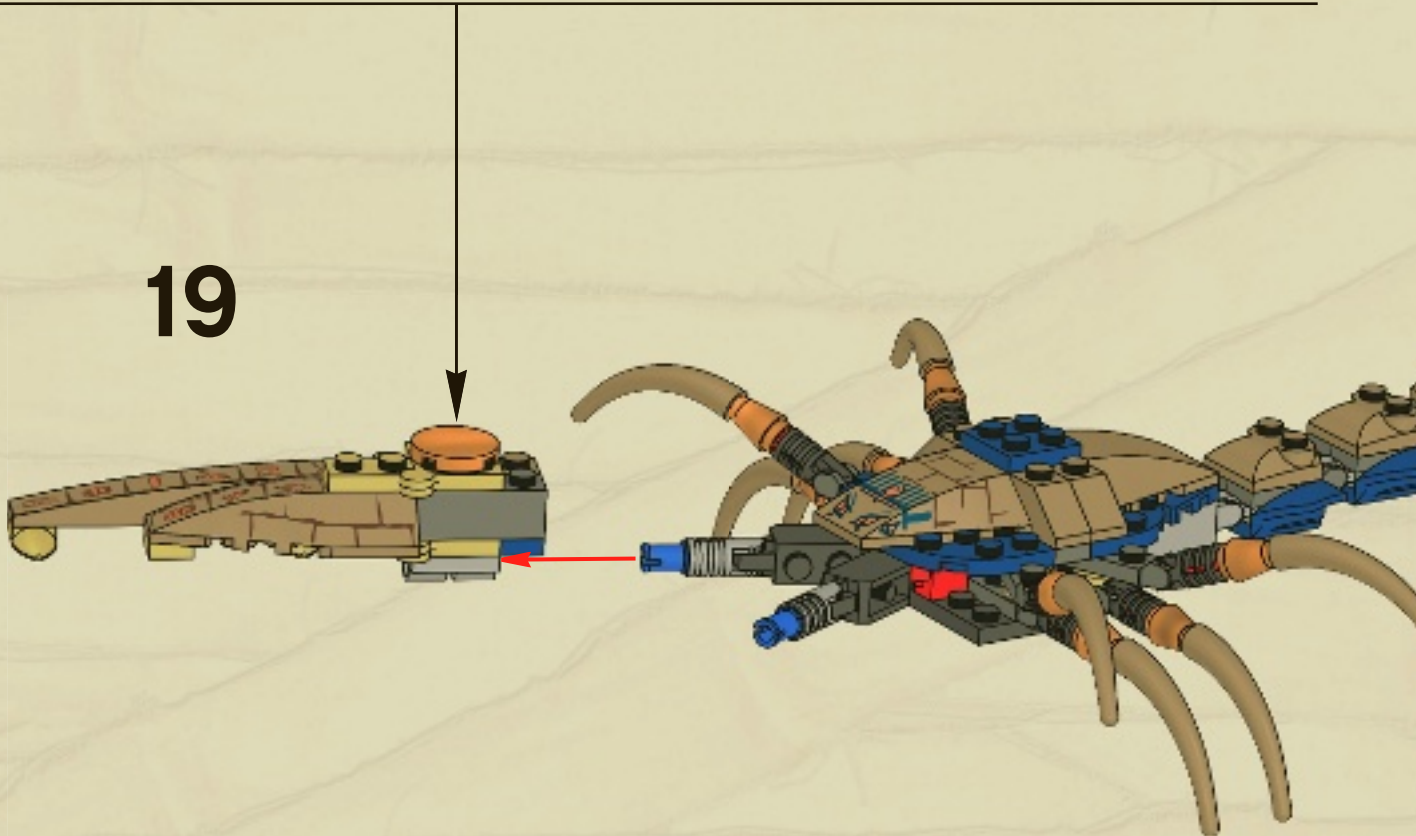

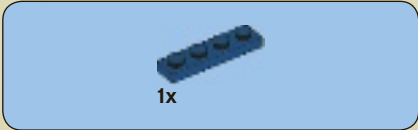

1

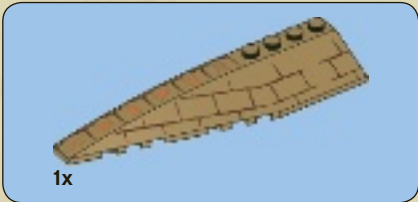

2

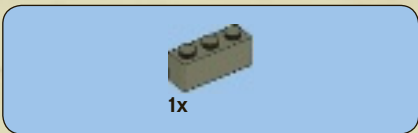
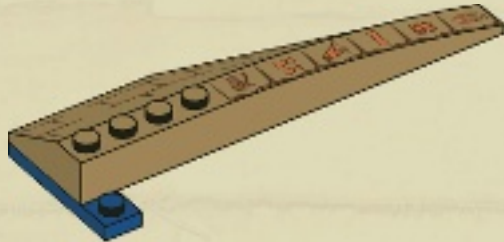

3

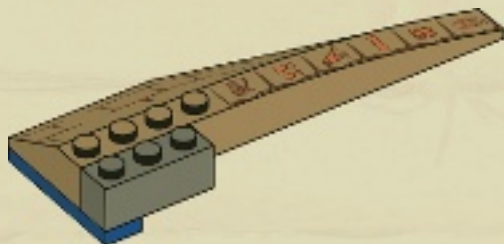

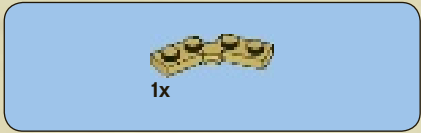

4

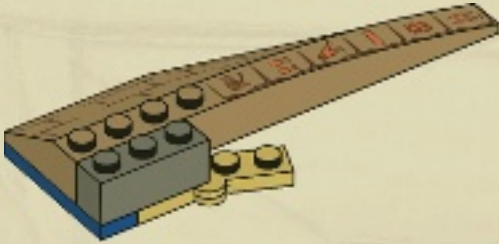

5

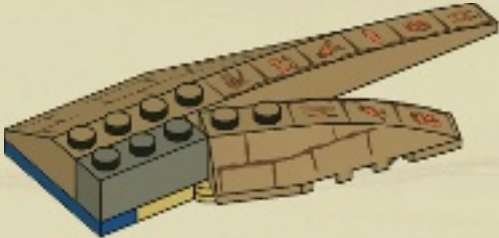

6

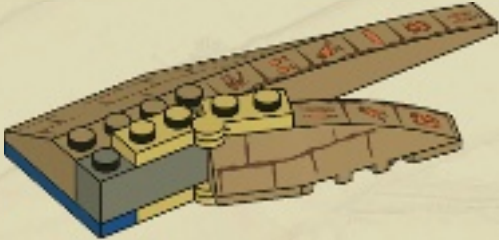



1x

7

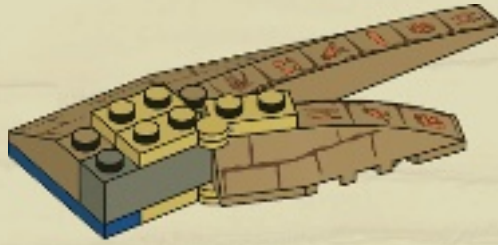

1x

8

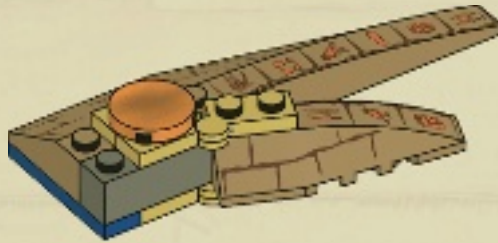

3x



1x

9

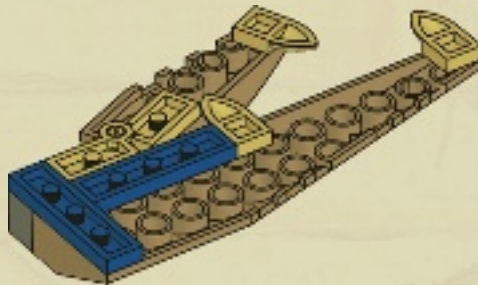



10

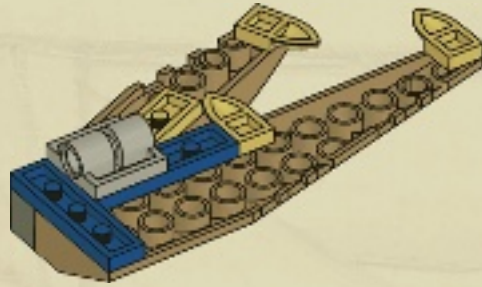

11

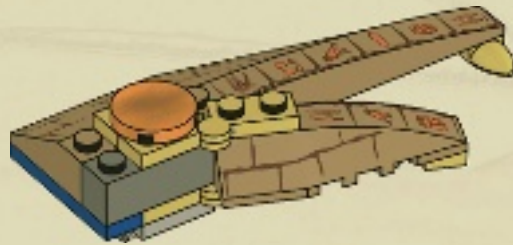

20

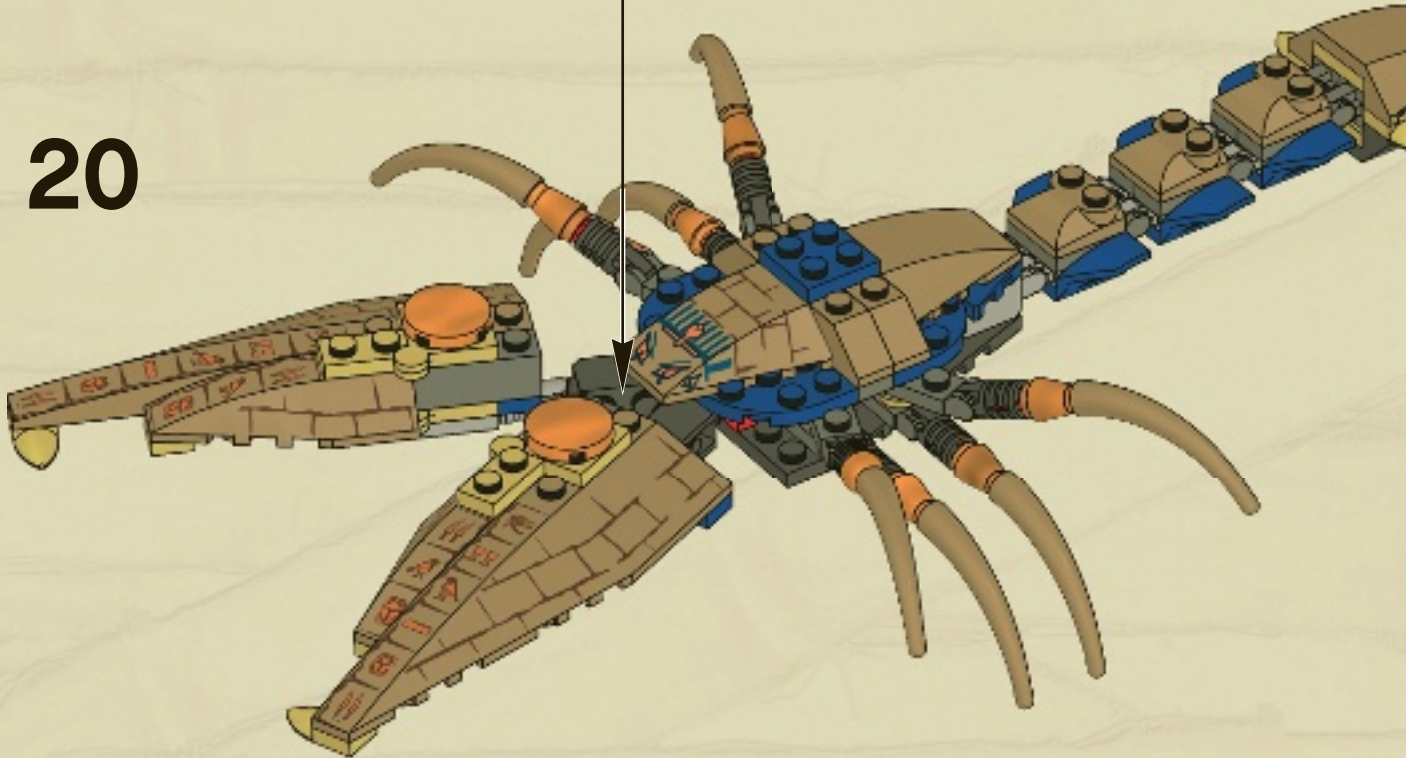

21

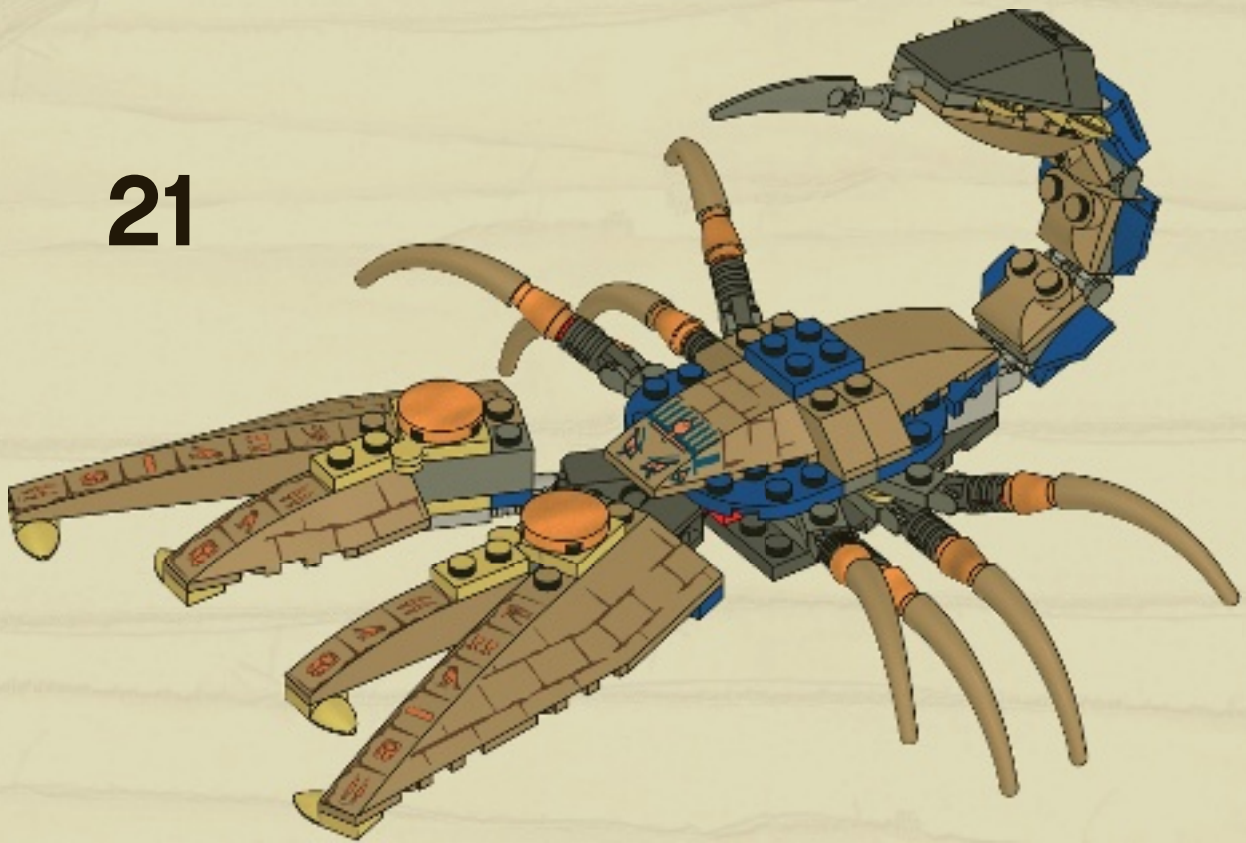

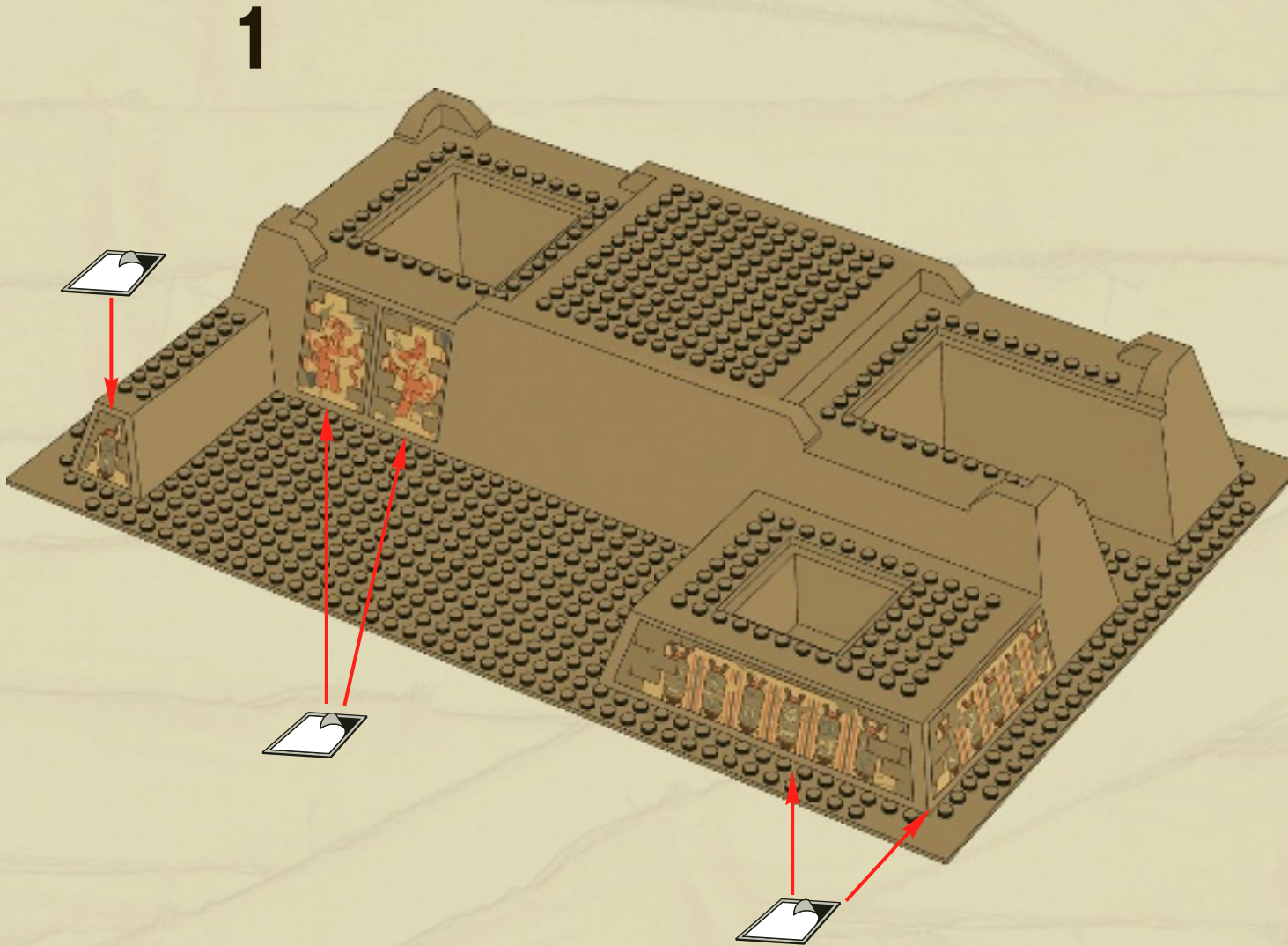
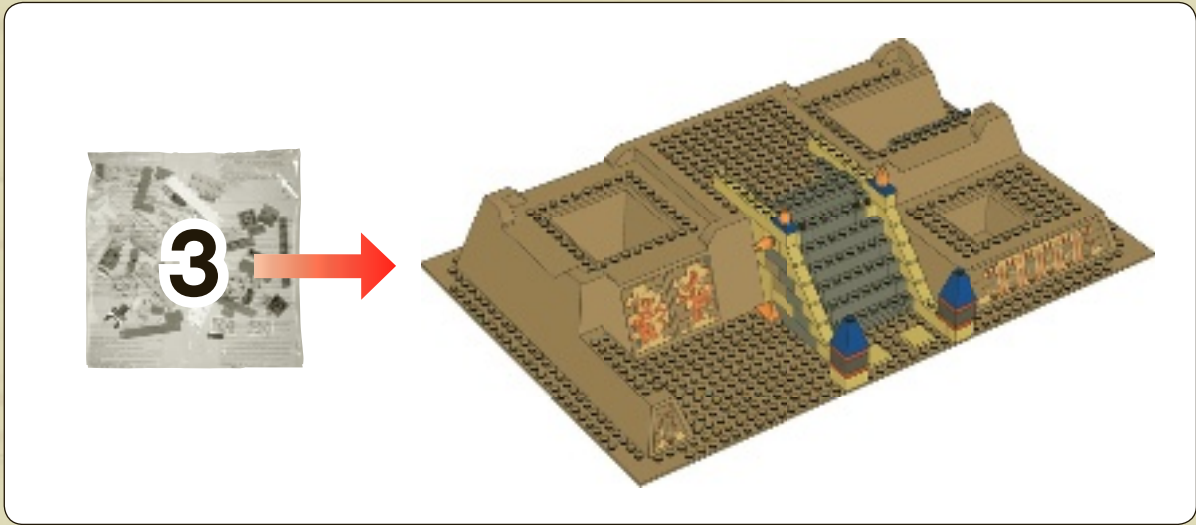

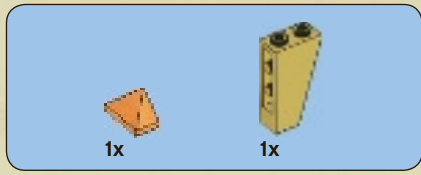

2

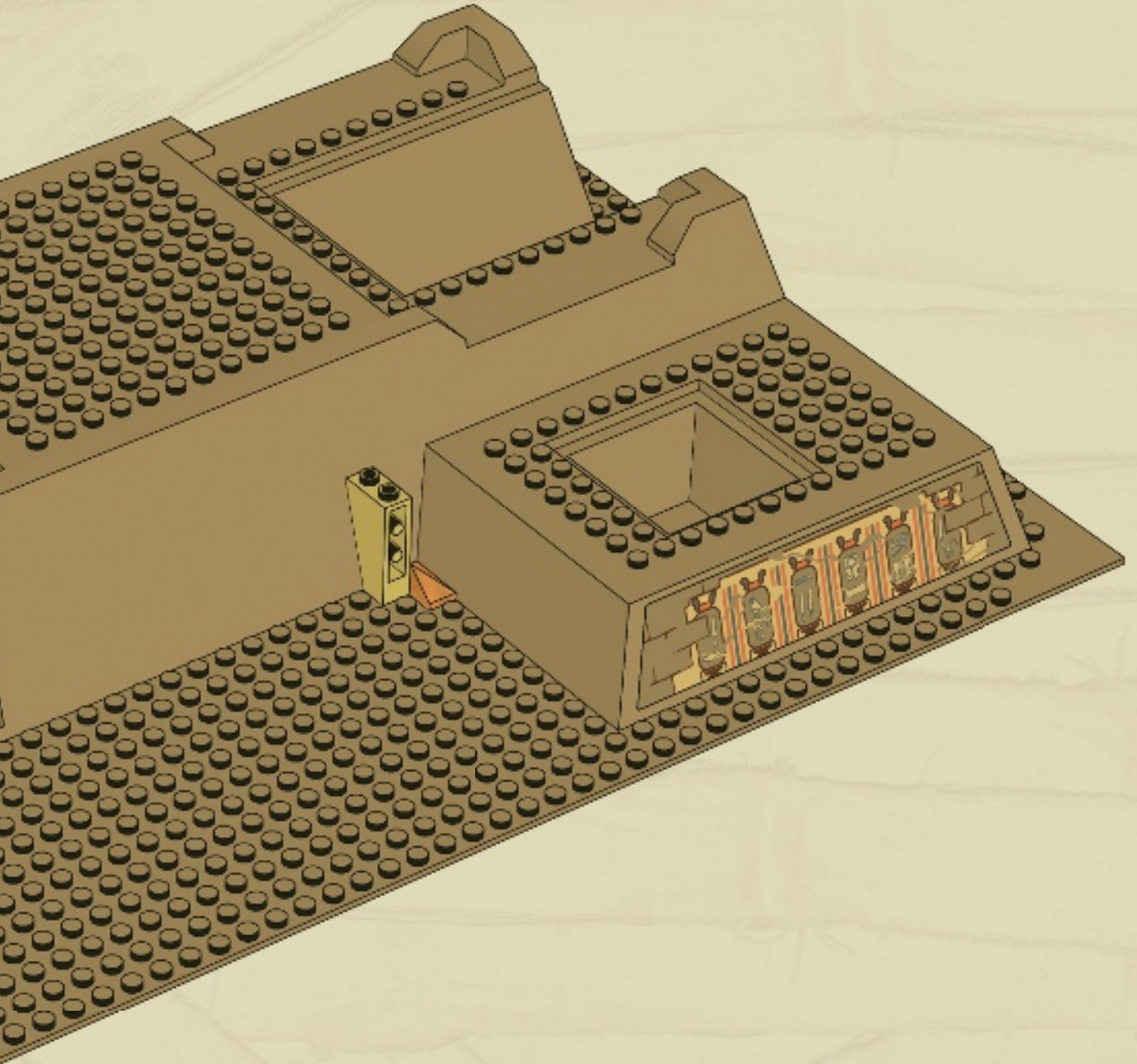

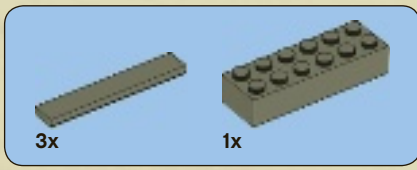

3

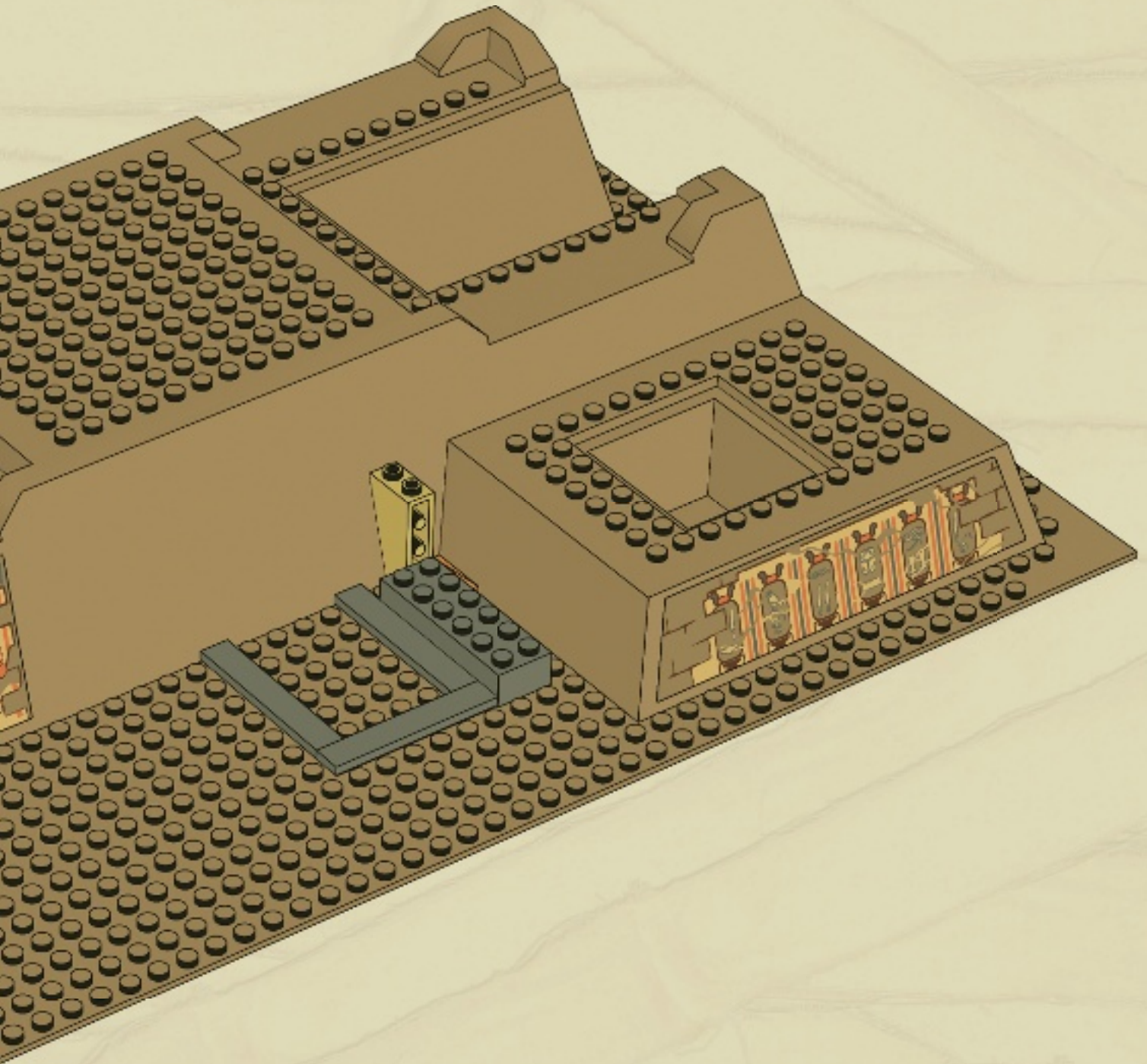

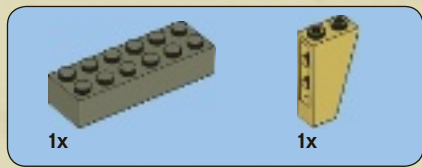

4

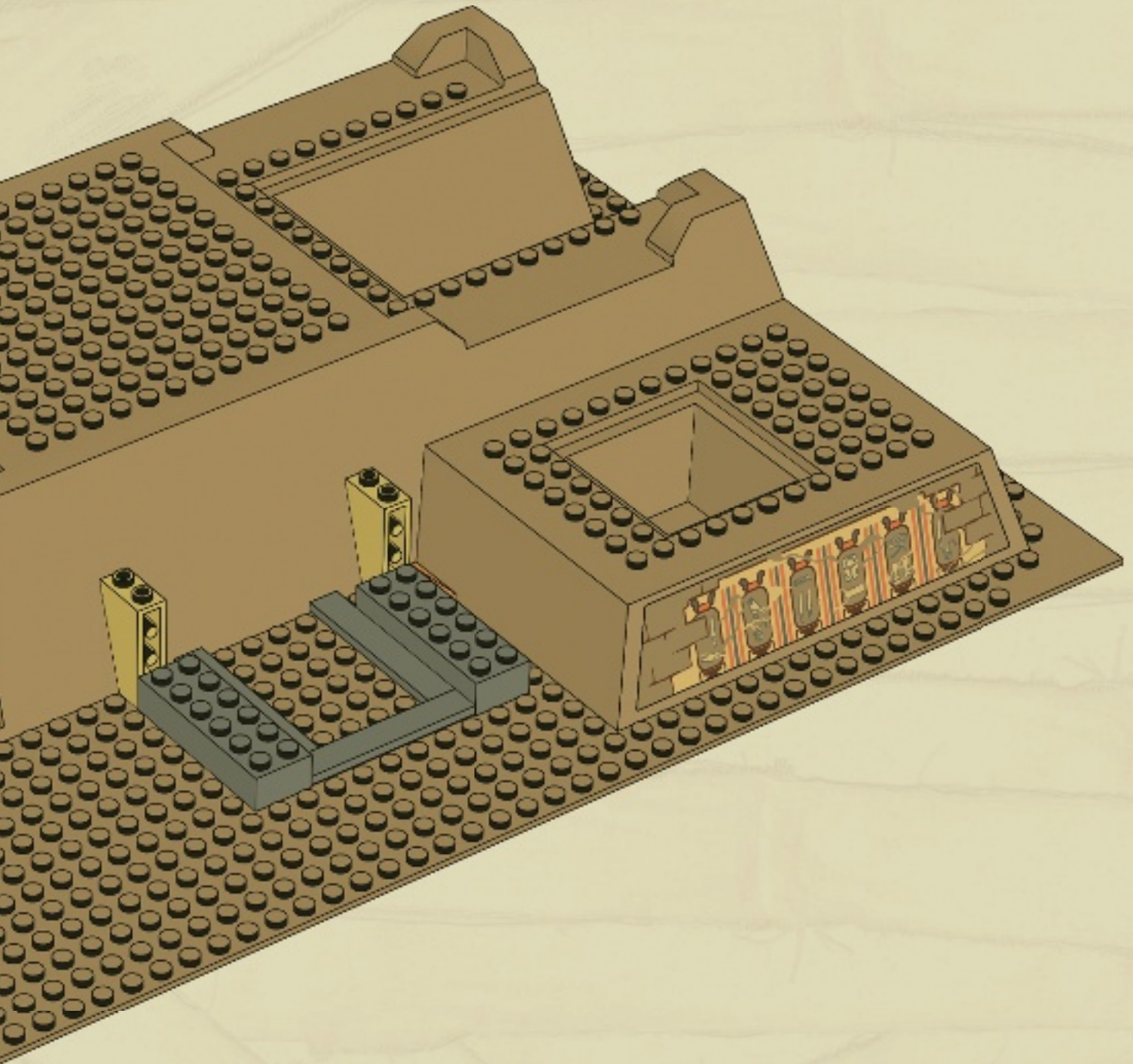

1x



5

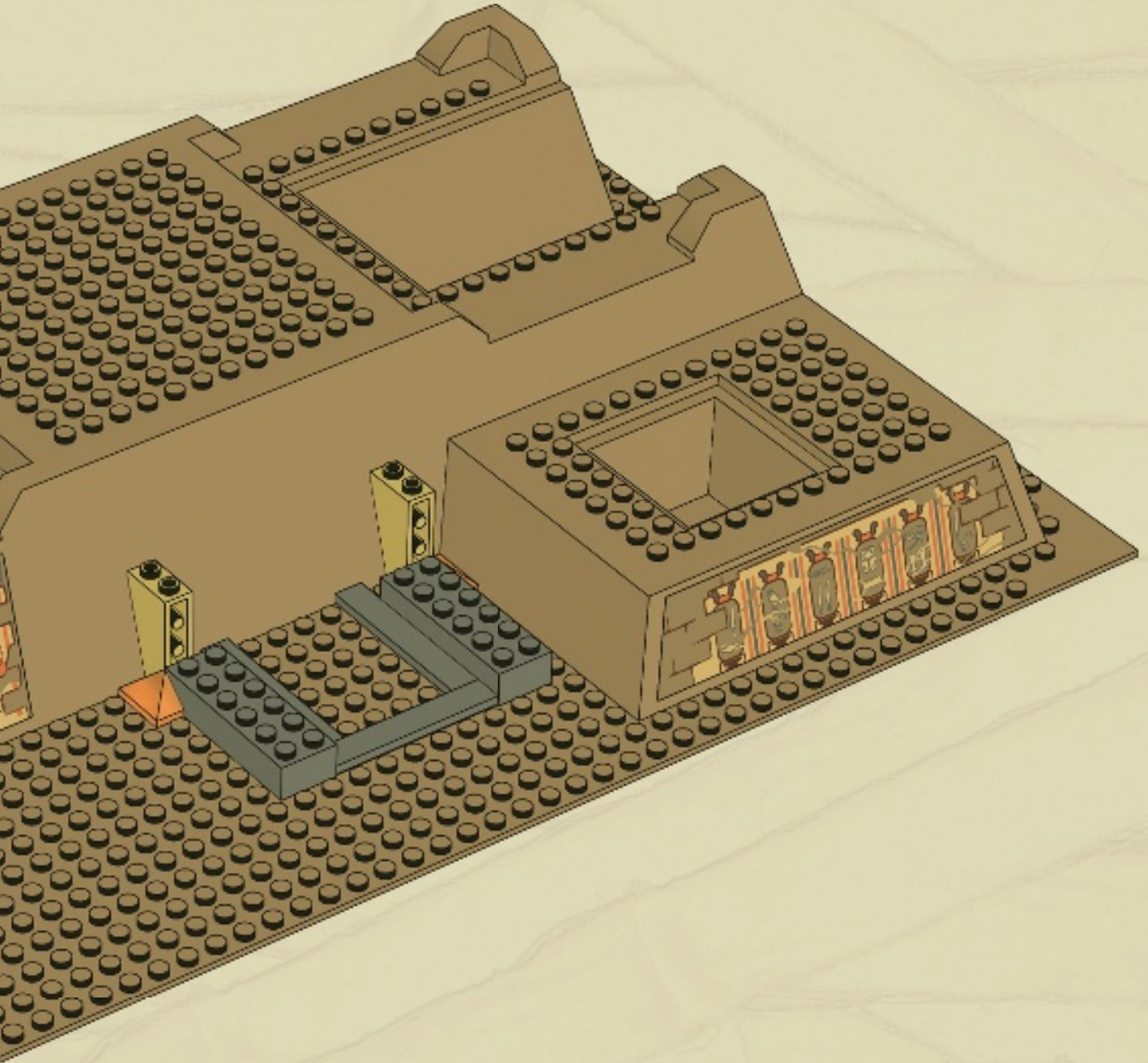



6

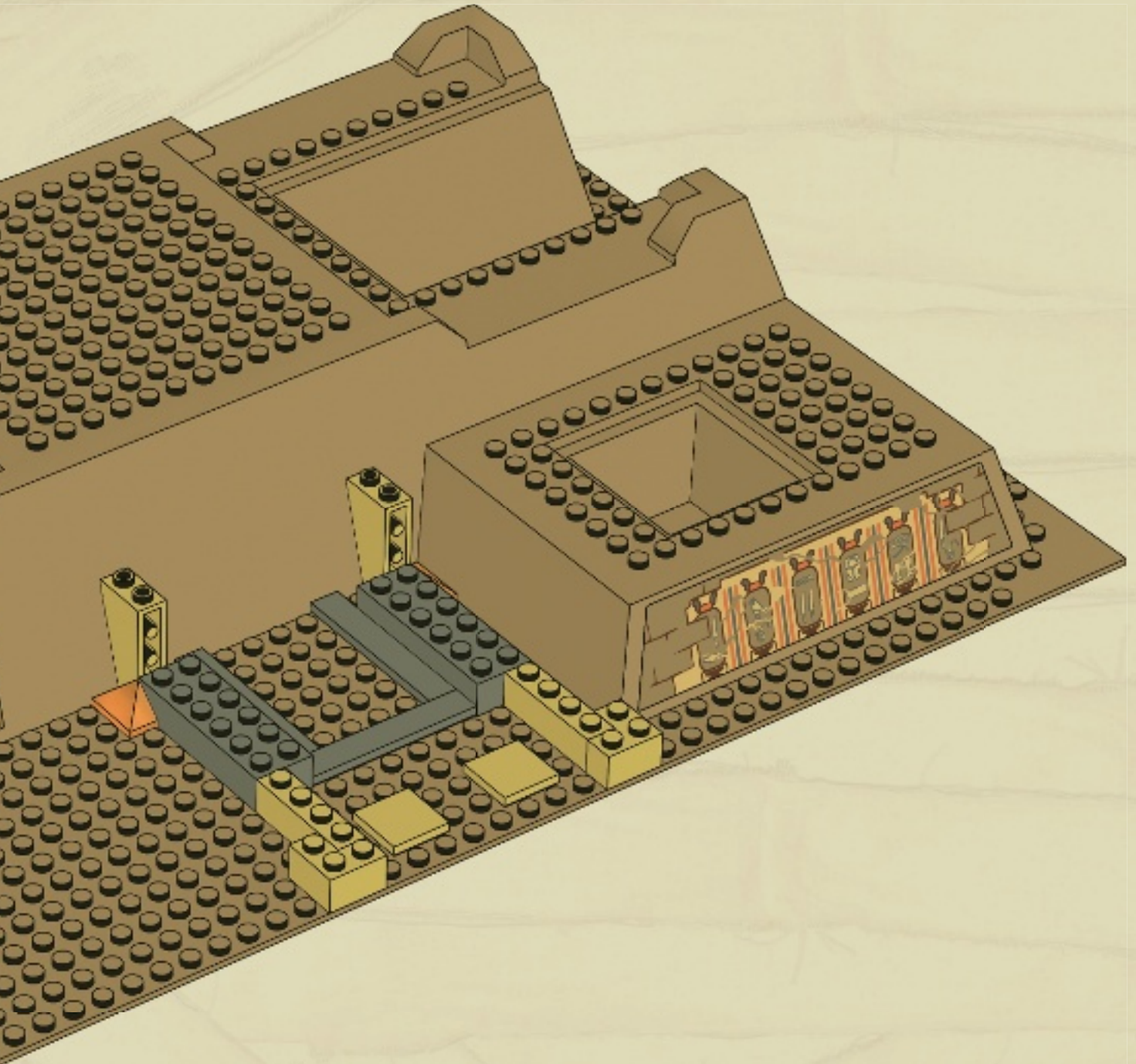

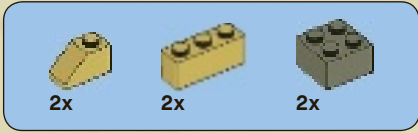

7

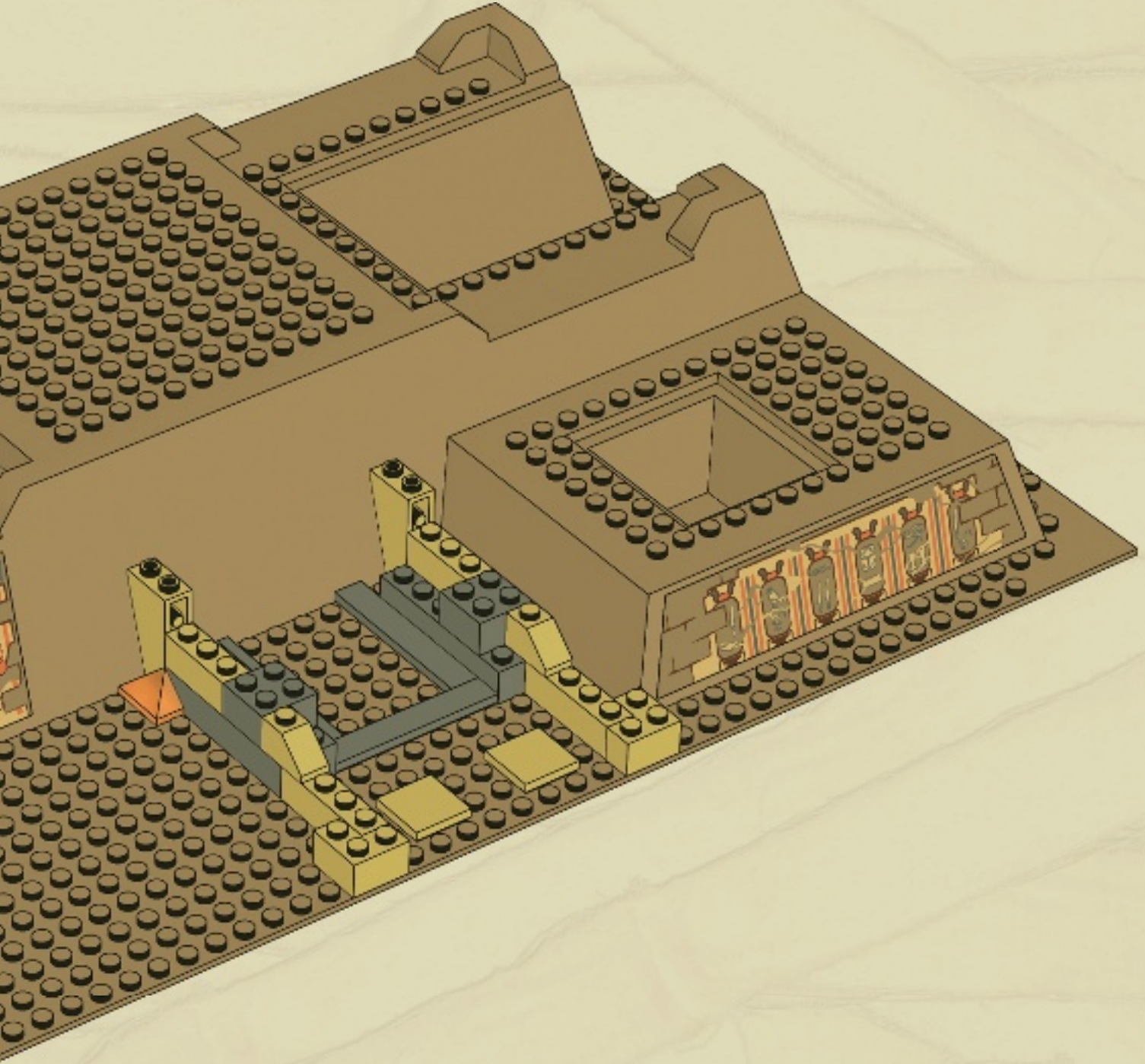



8

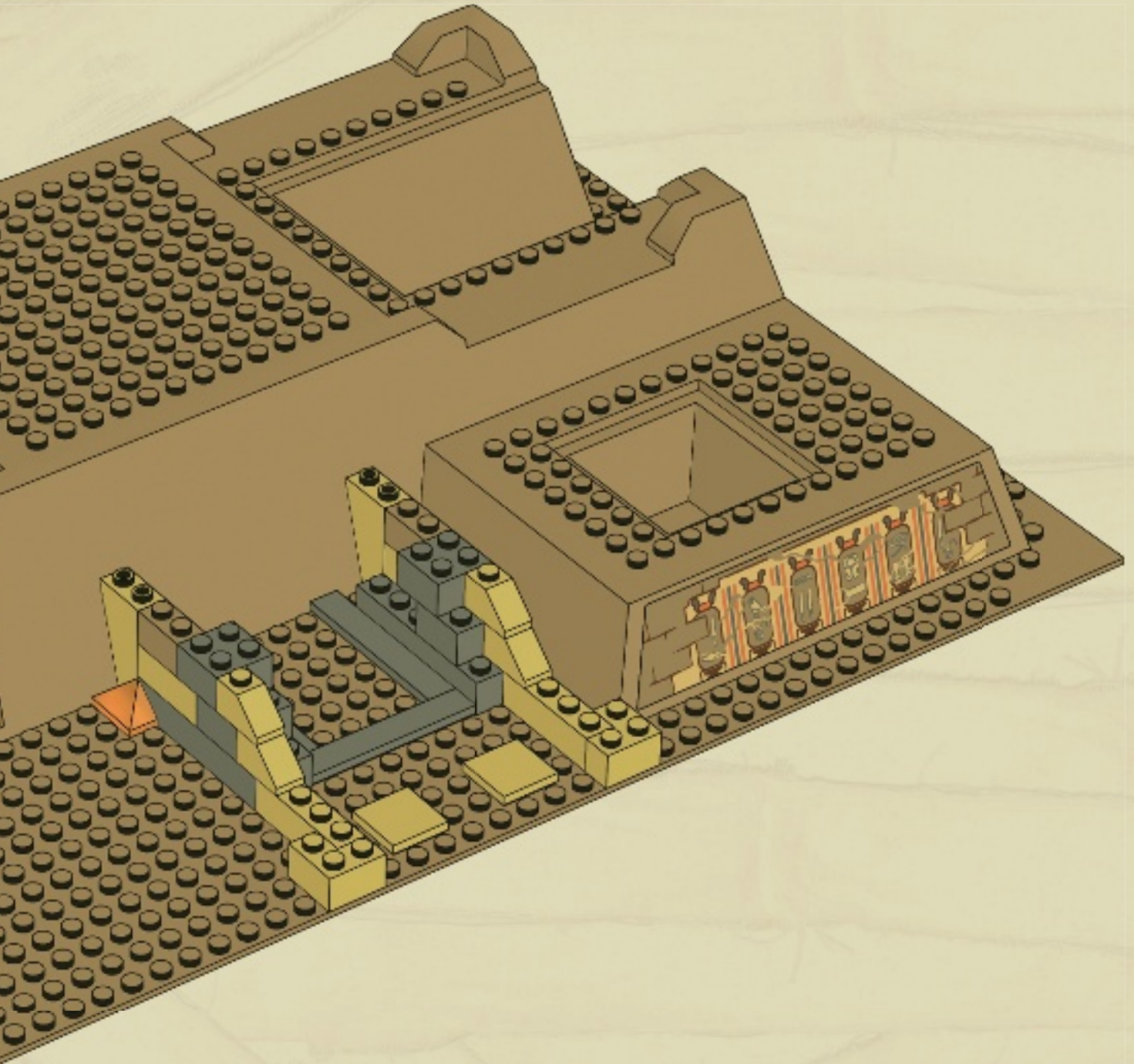



9

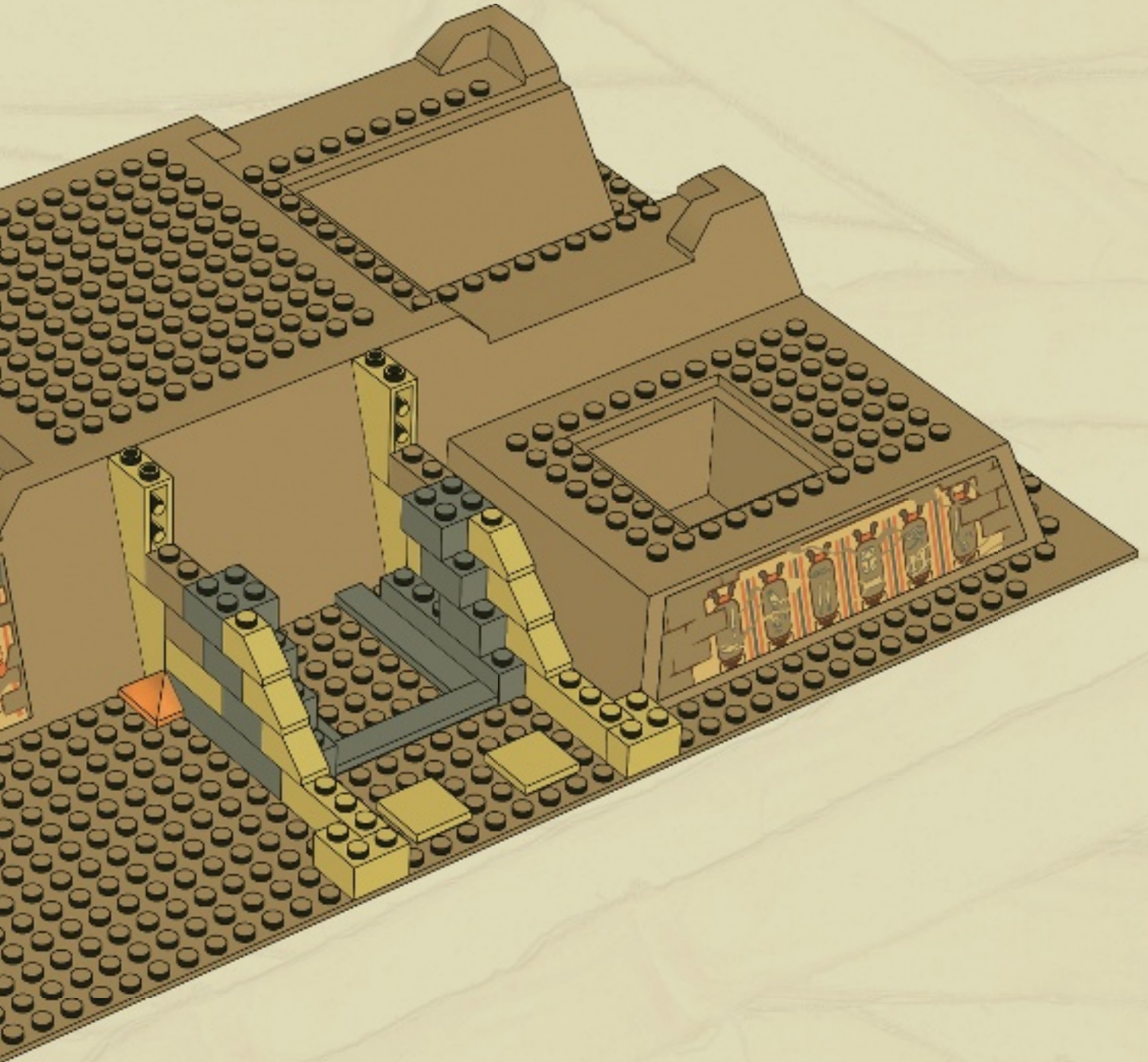

2x  2x 

10

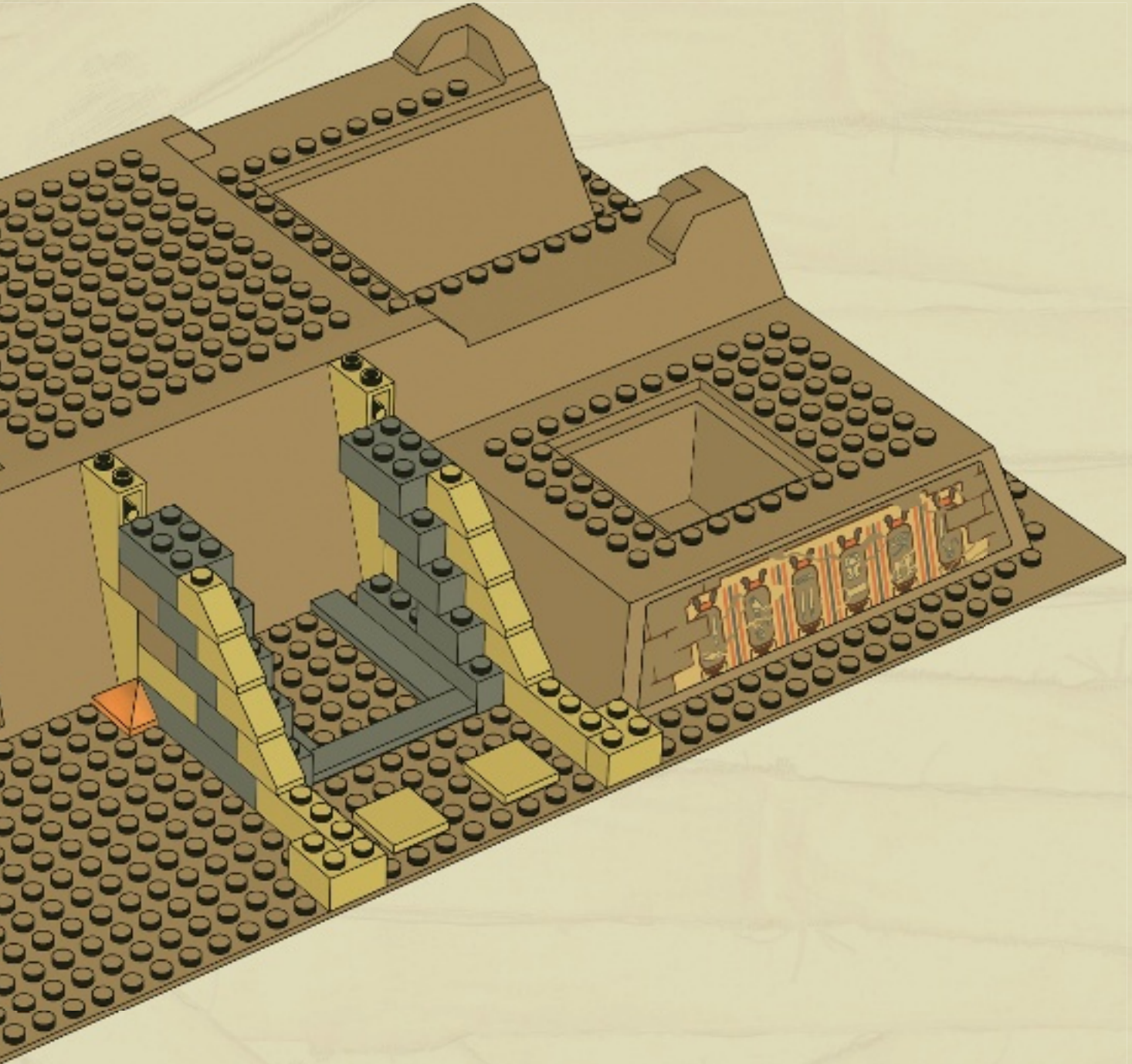



2x



4x

11



4x

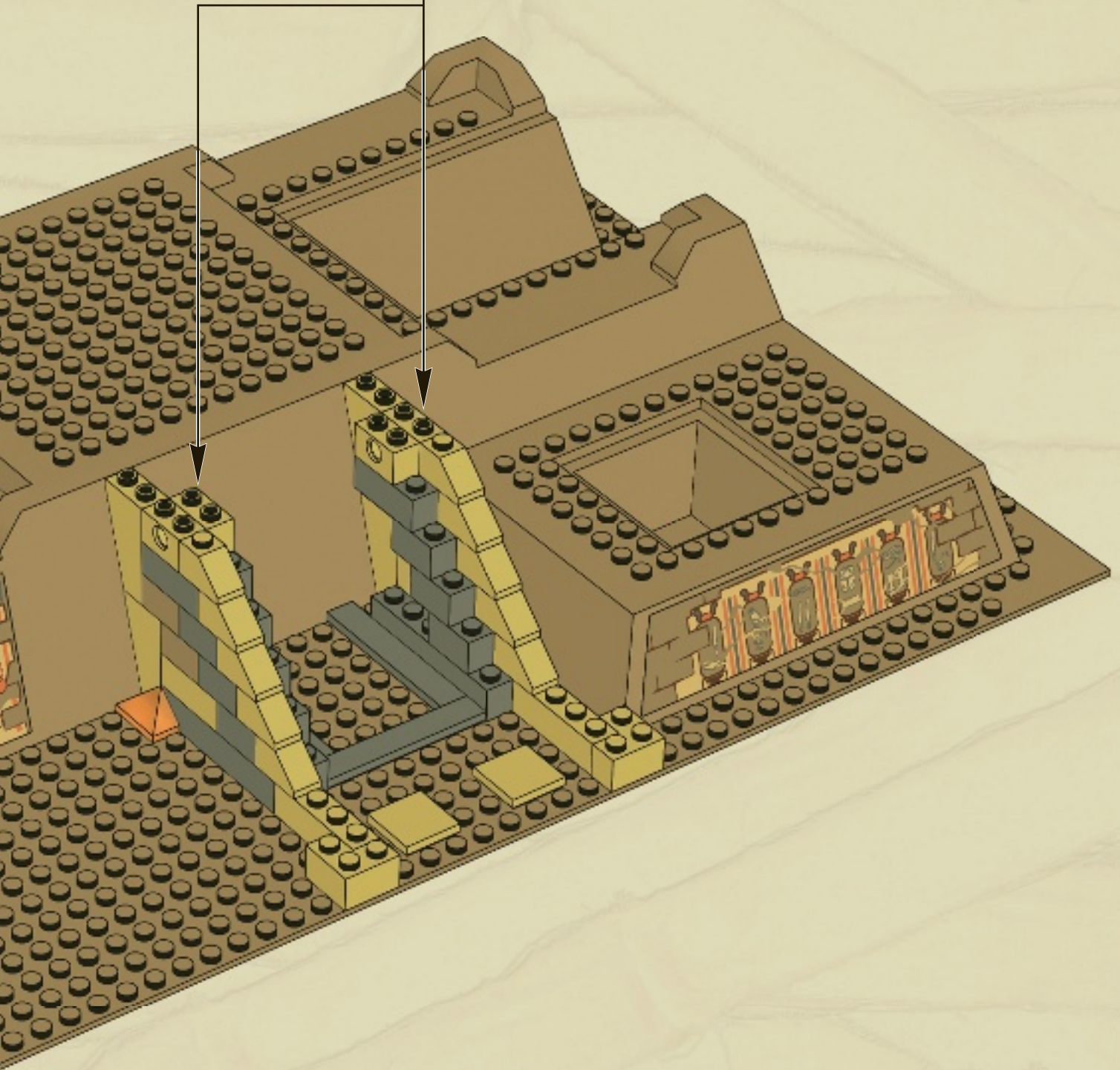

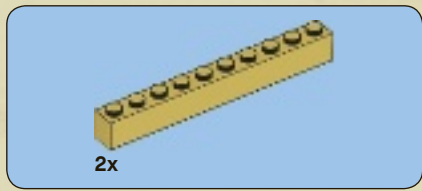

12

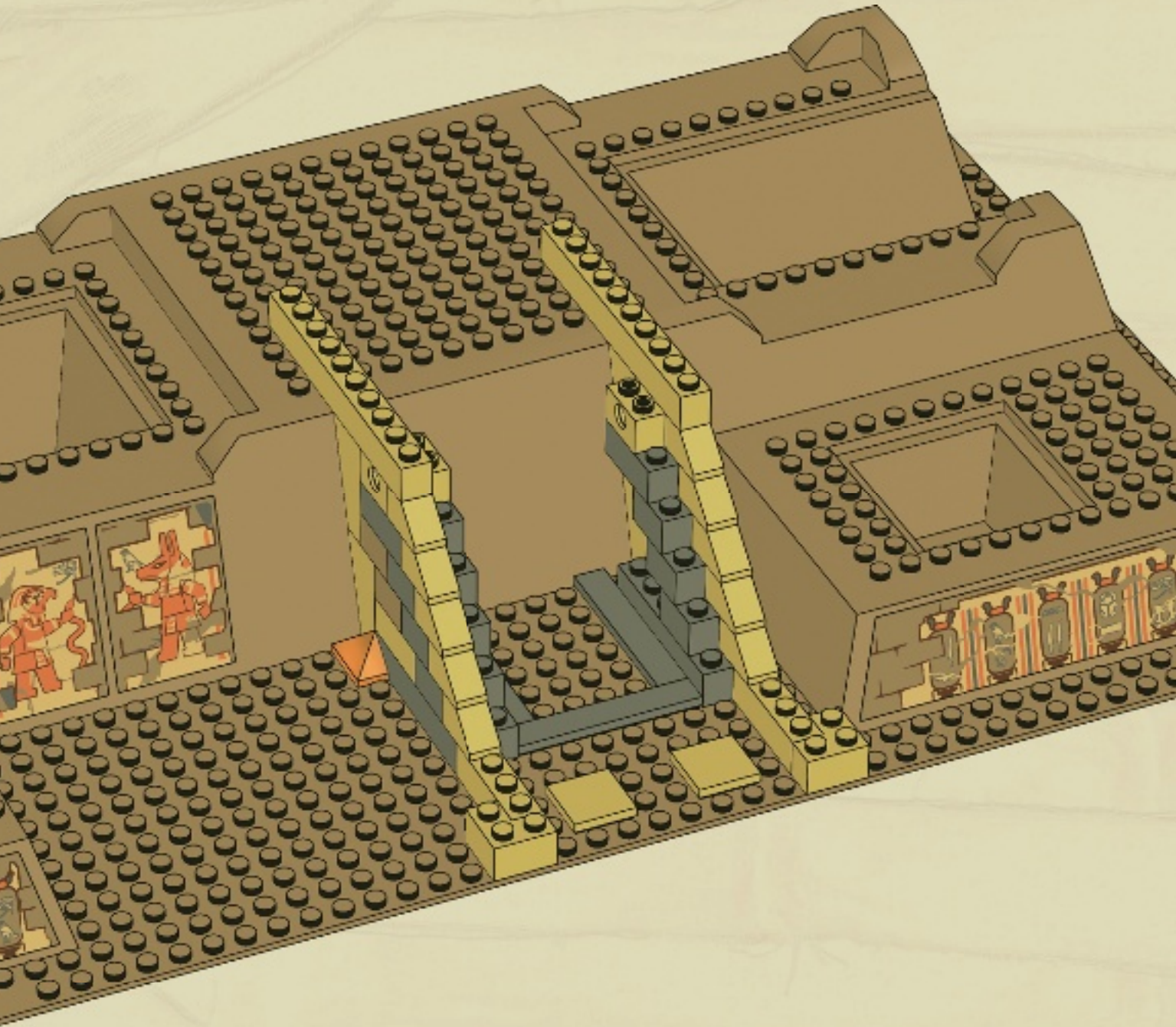

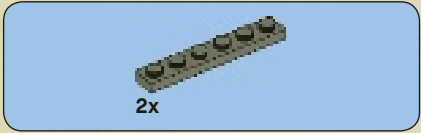

13

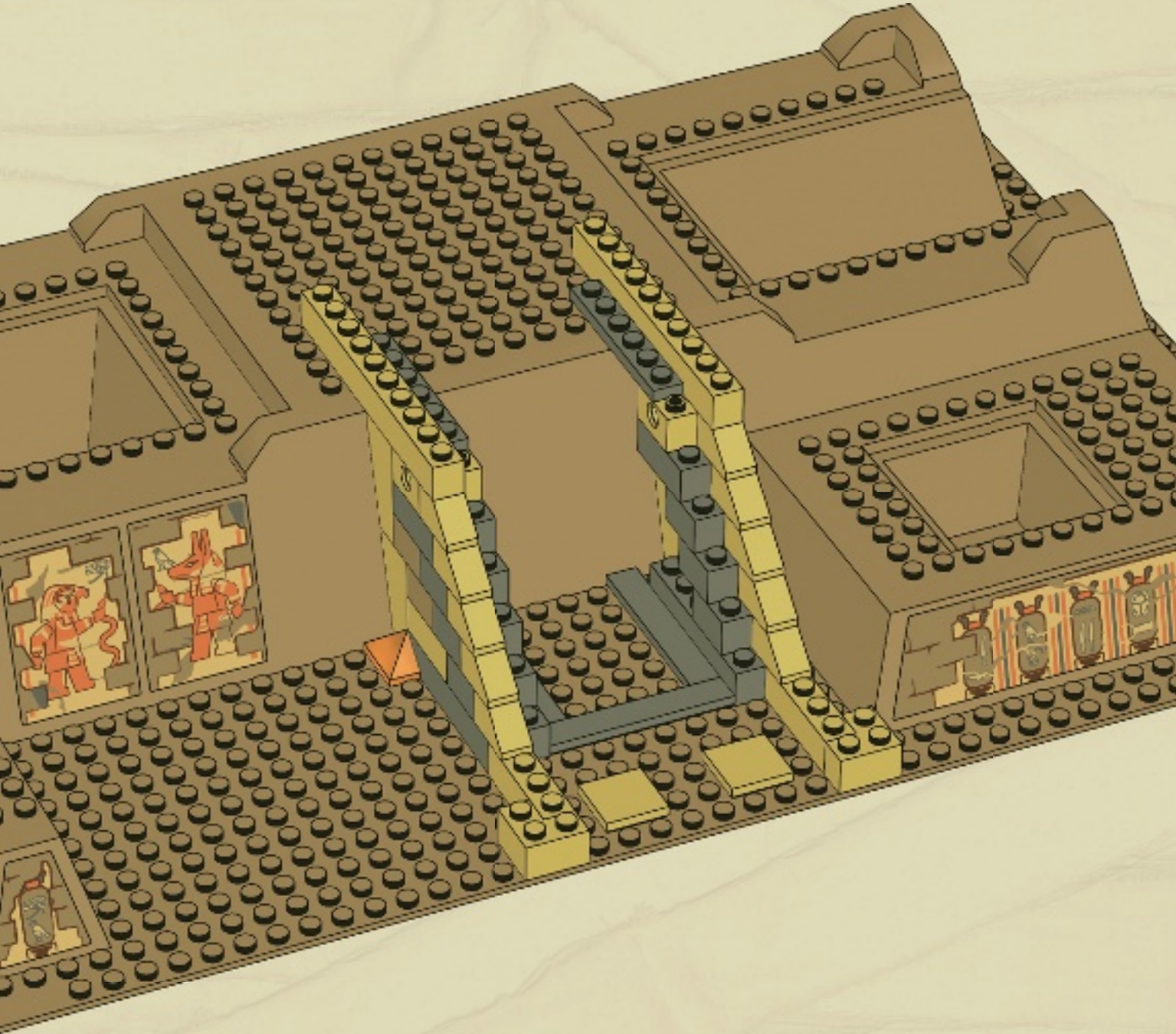

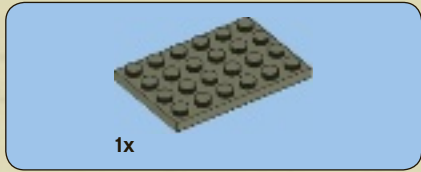

1

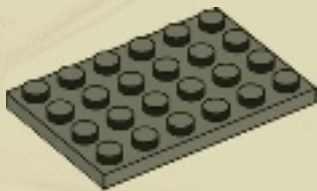

2

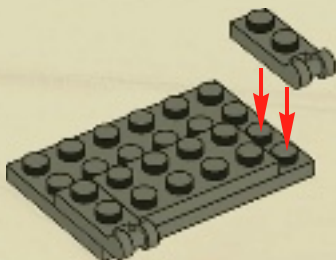

3

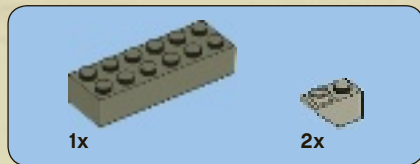
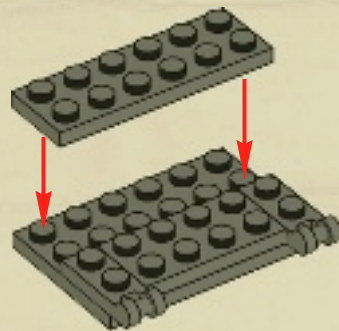

4

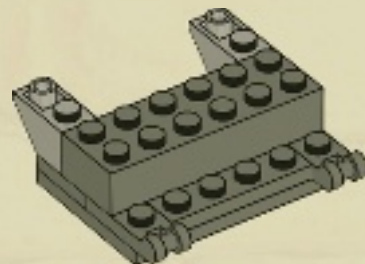

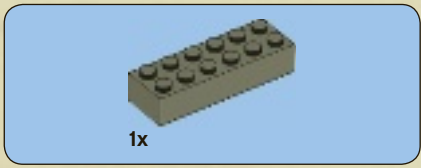

5

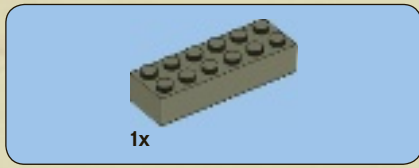
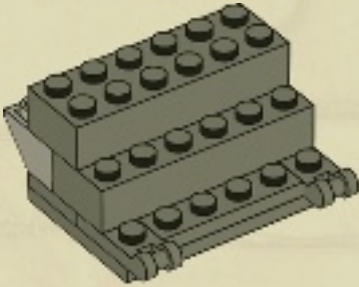

7

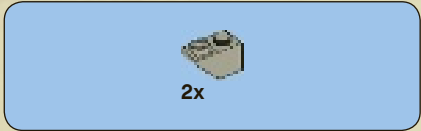
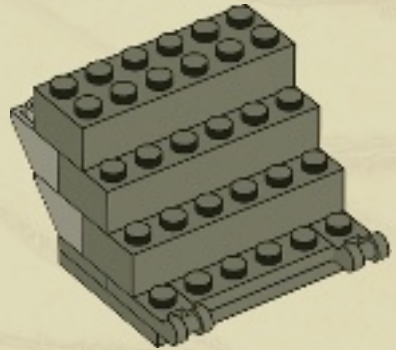

6

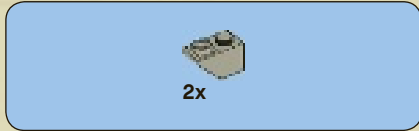
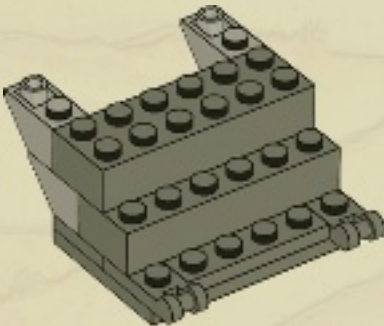

8

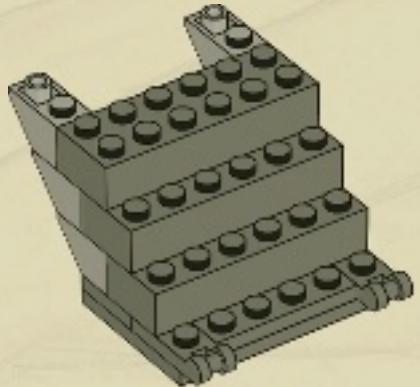

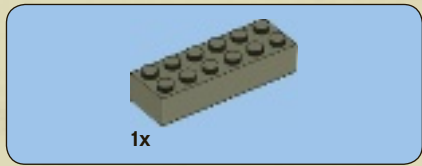

9

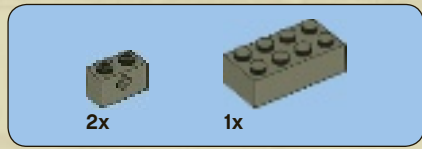
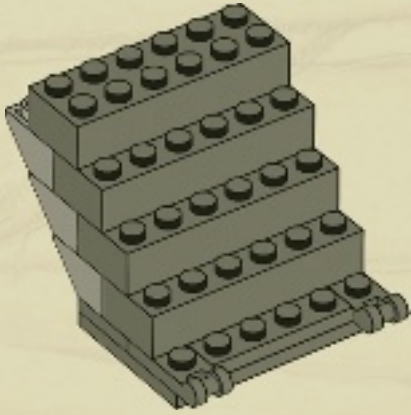

11

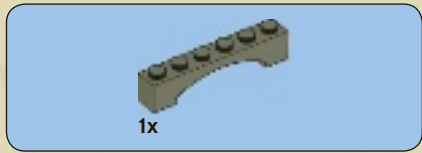
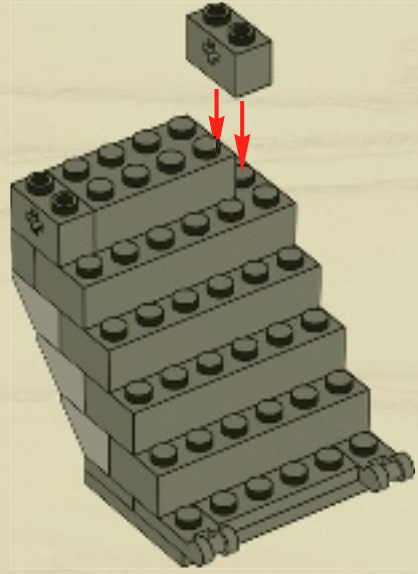

10

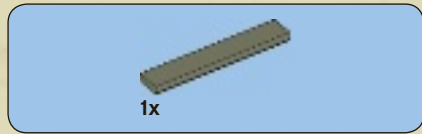
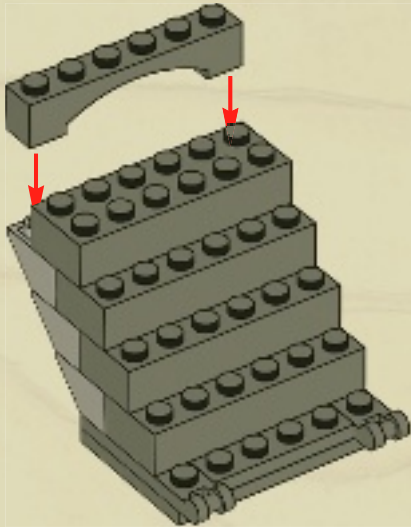

12

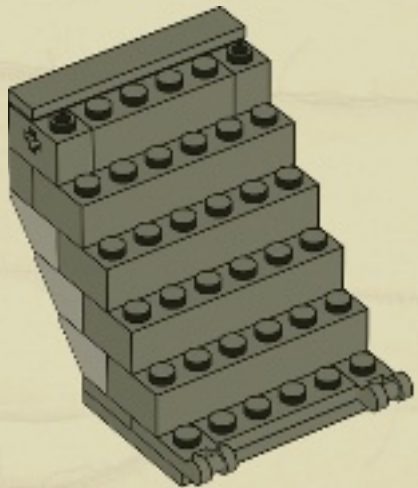



14

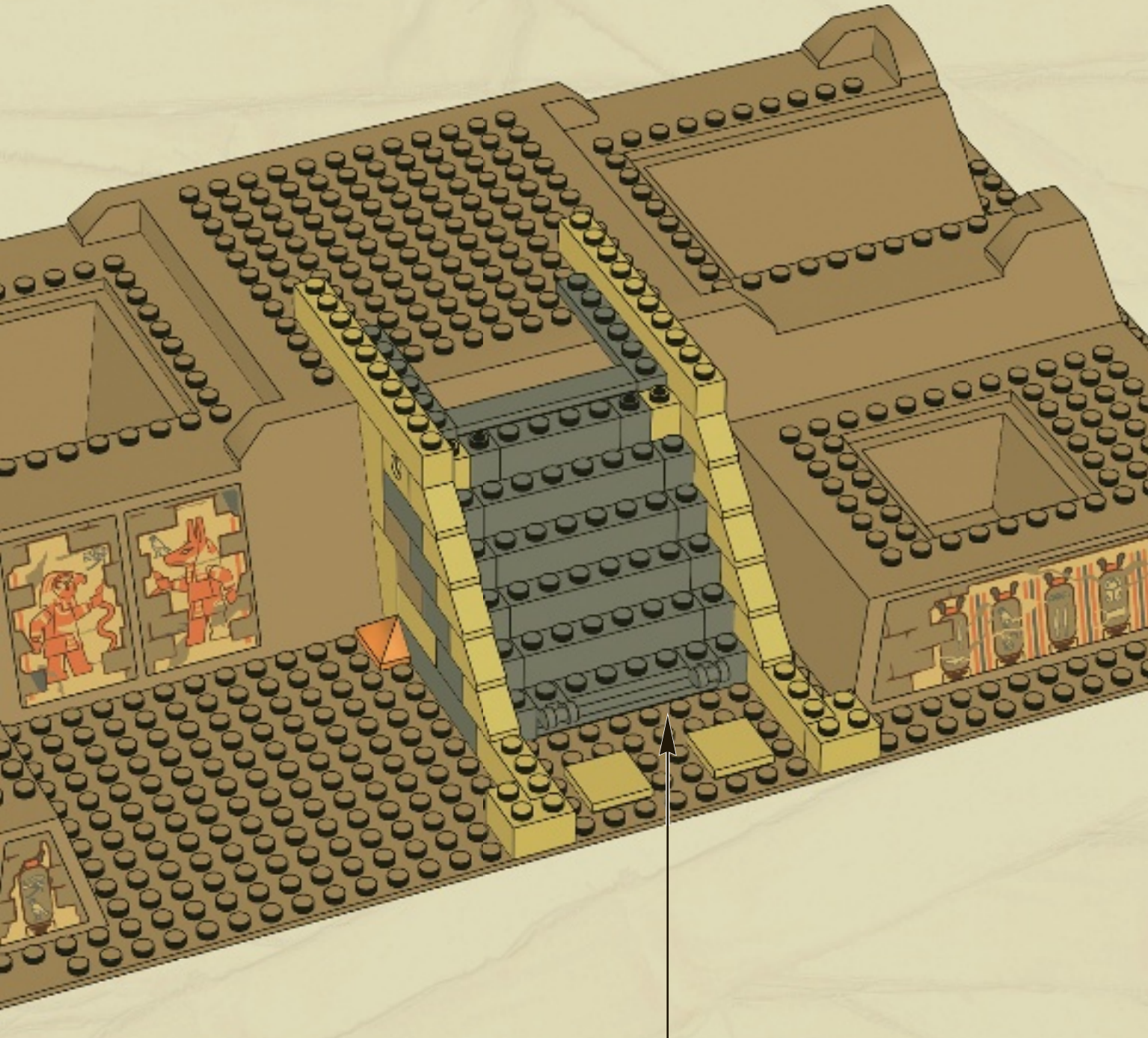

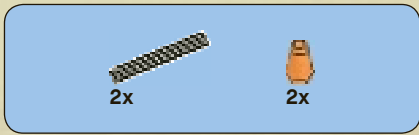

15

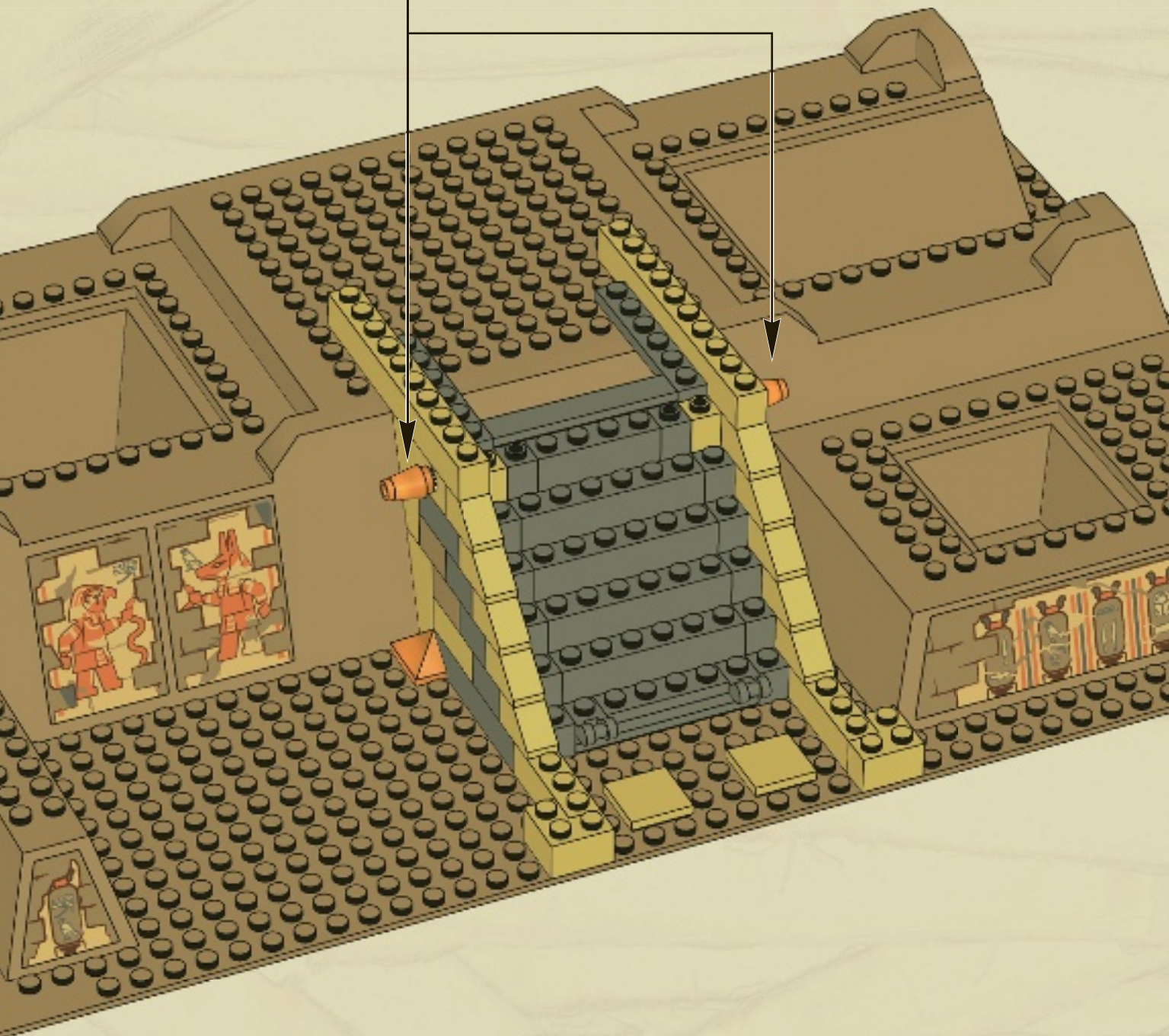
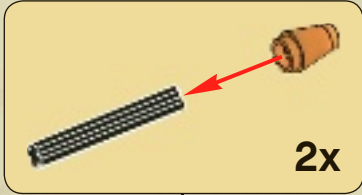
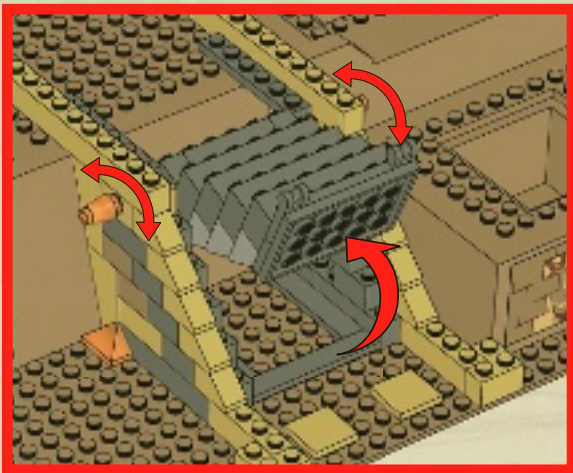

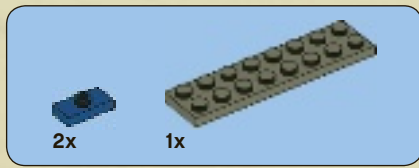

16

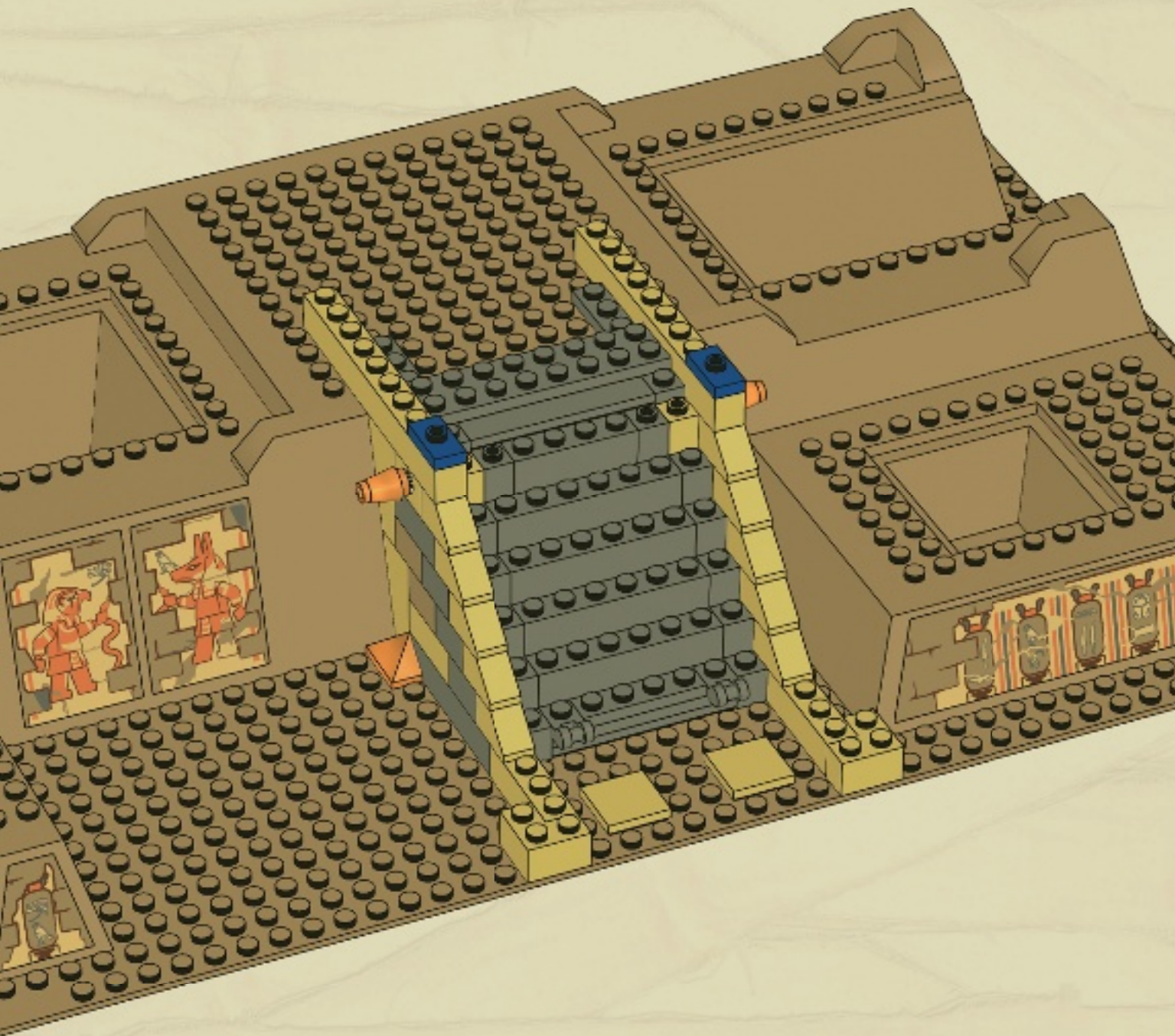



17

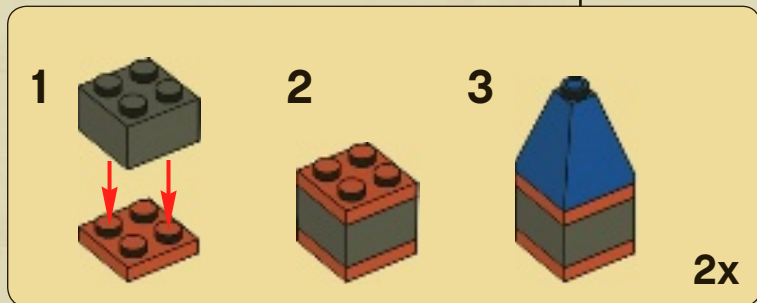
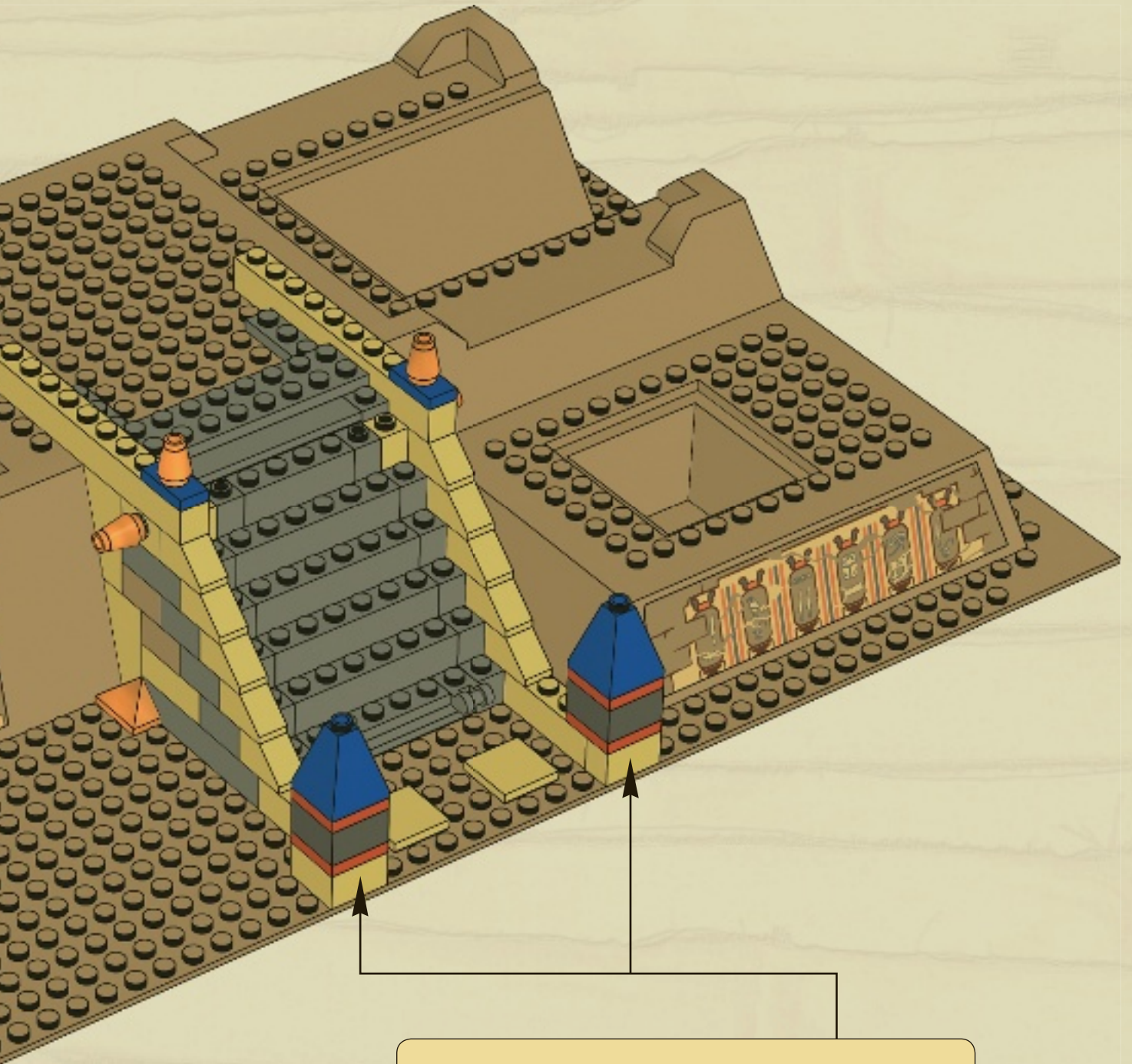

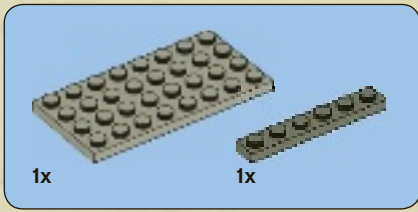

18

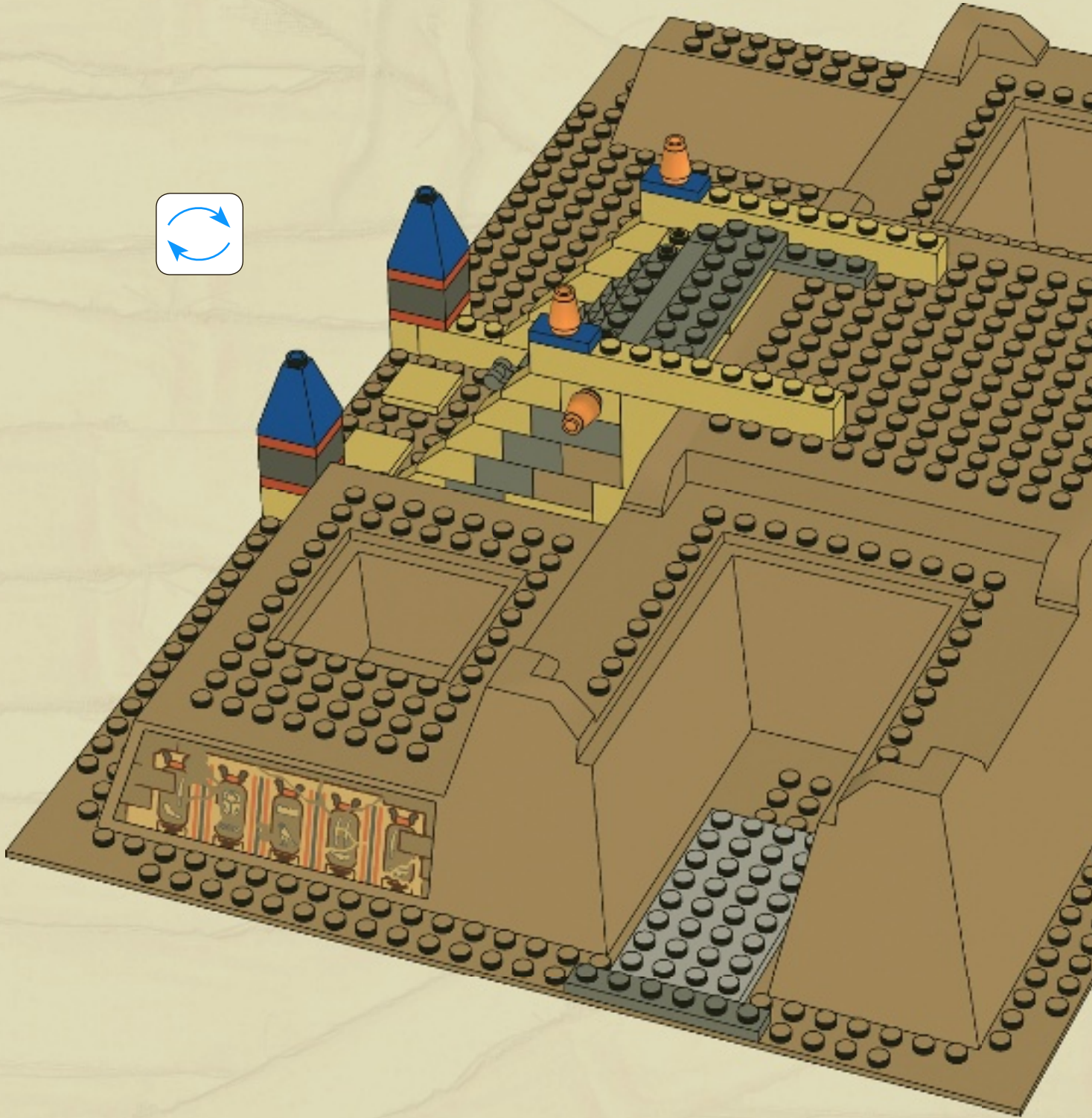

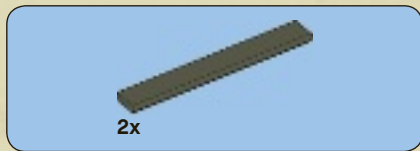

19

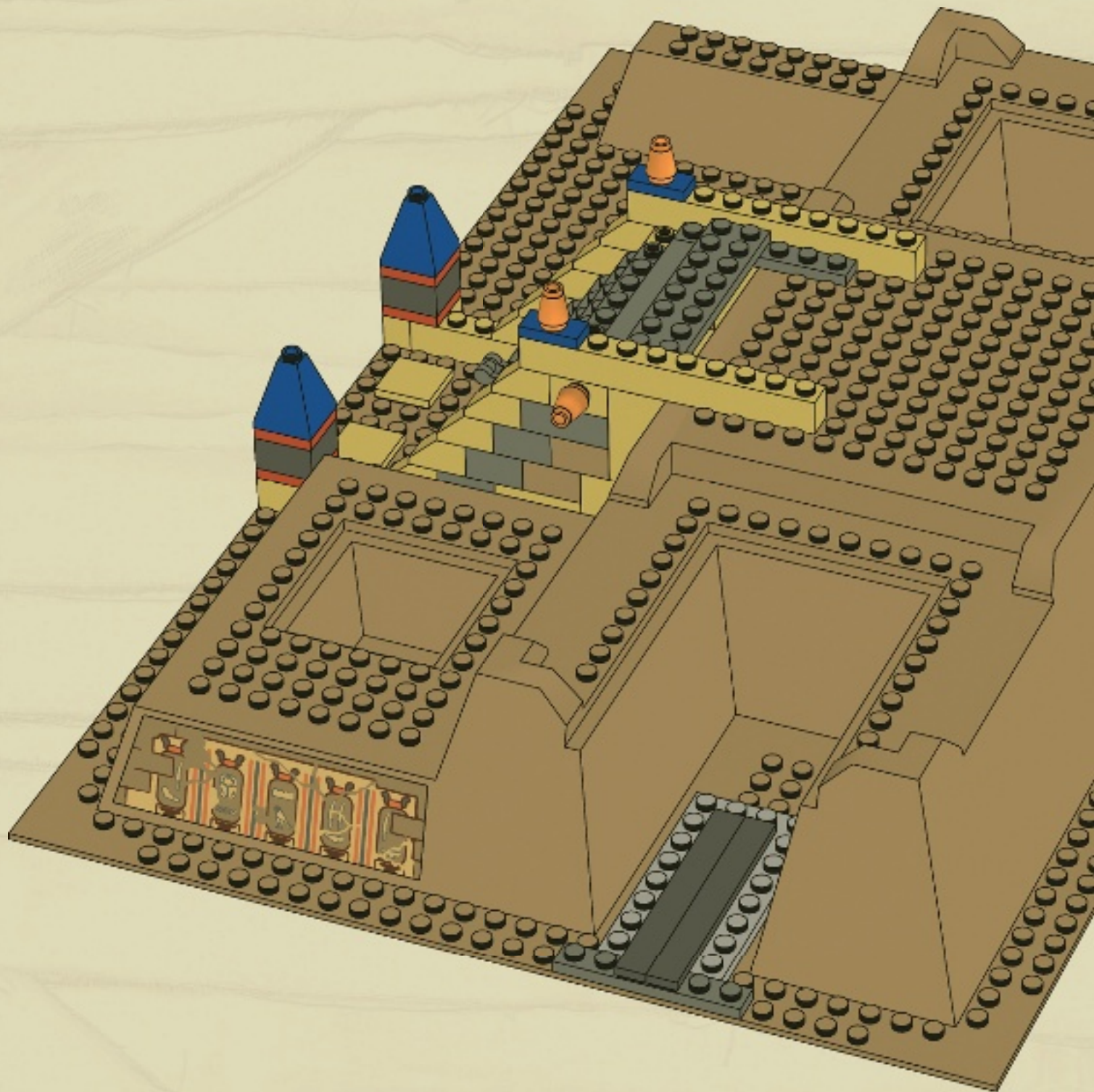

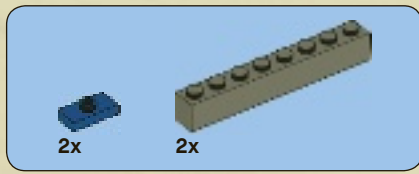

20

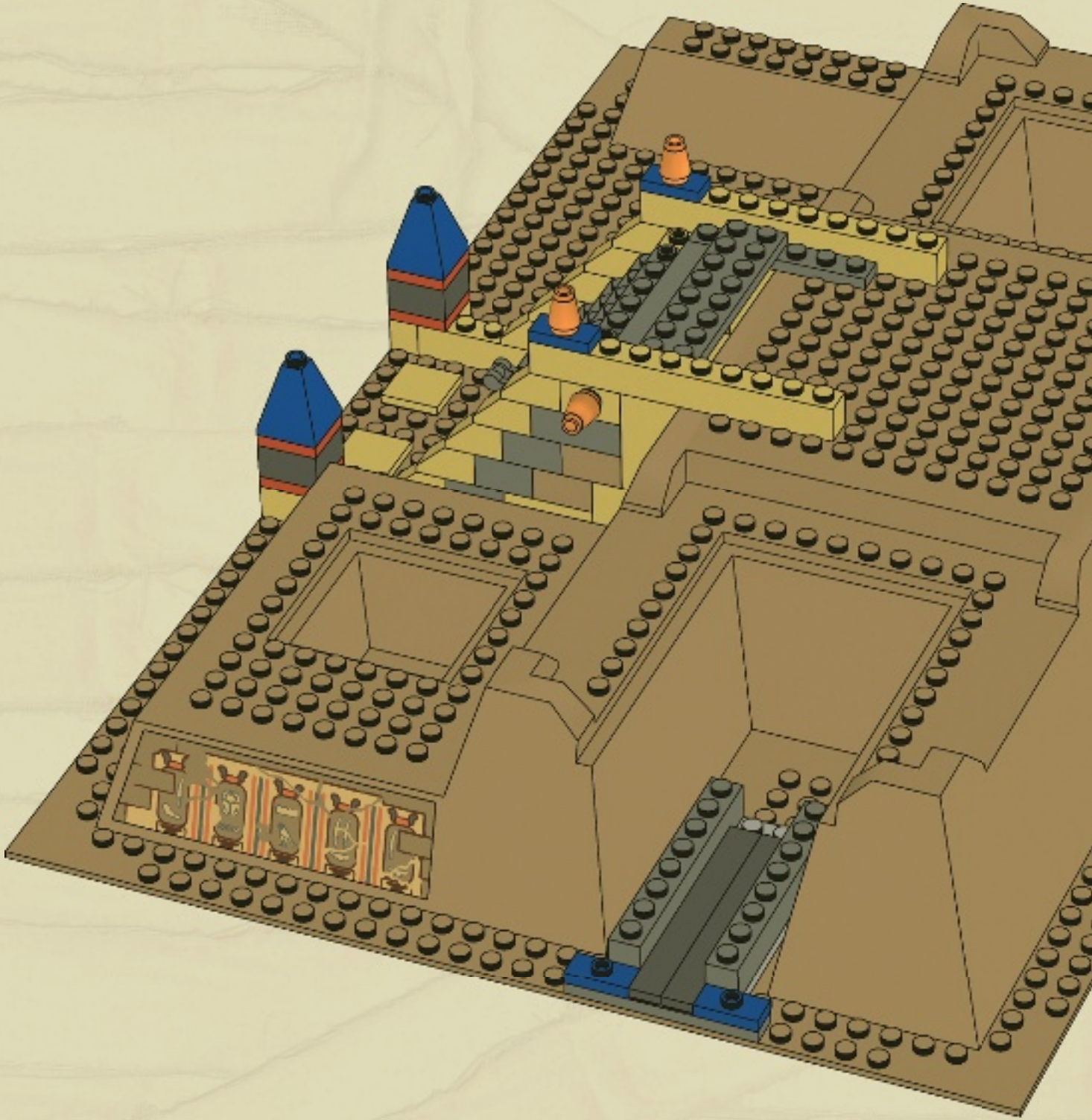

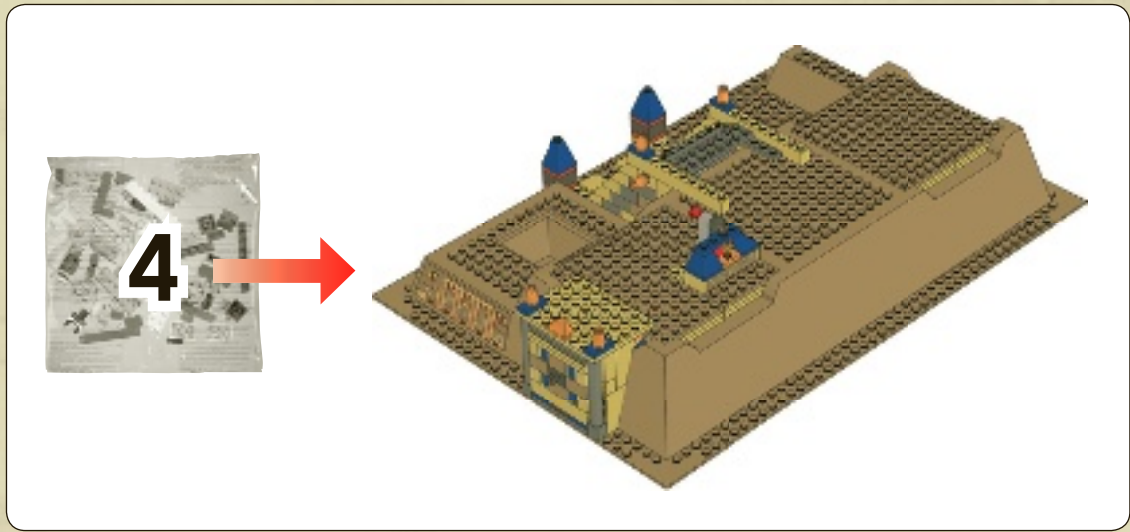

1

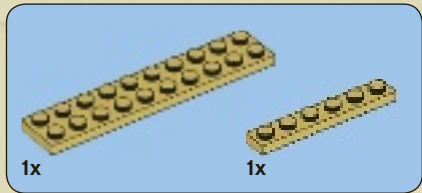
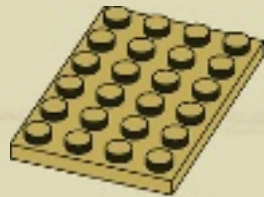

2

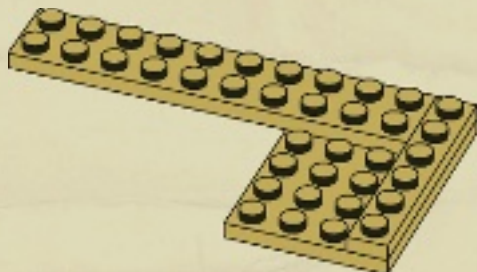

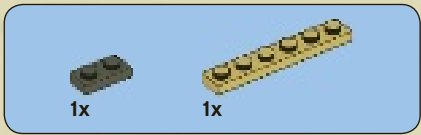

3

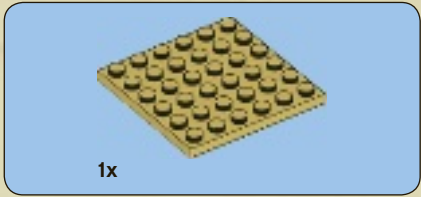
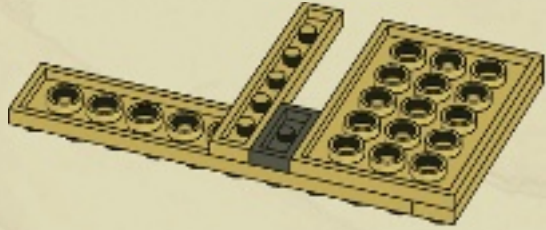
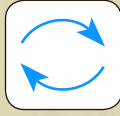

4

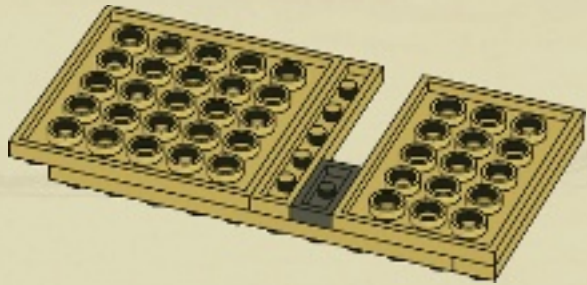

5

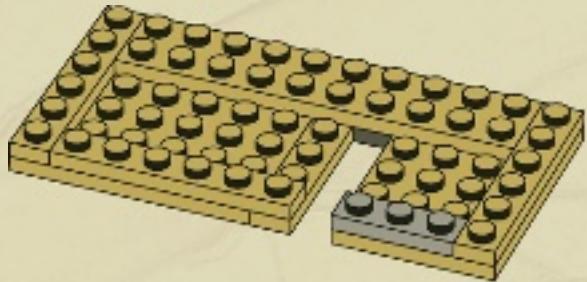
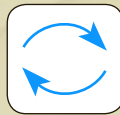

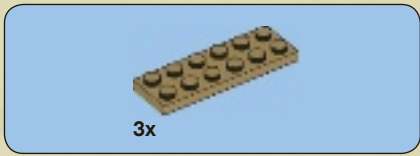

6

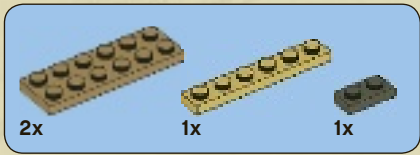
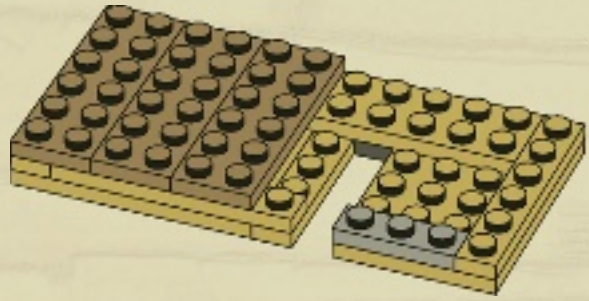

7

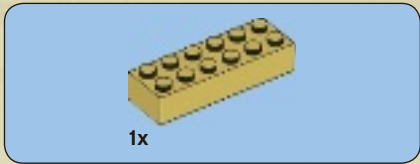
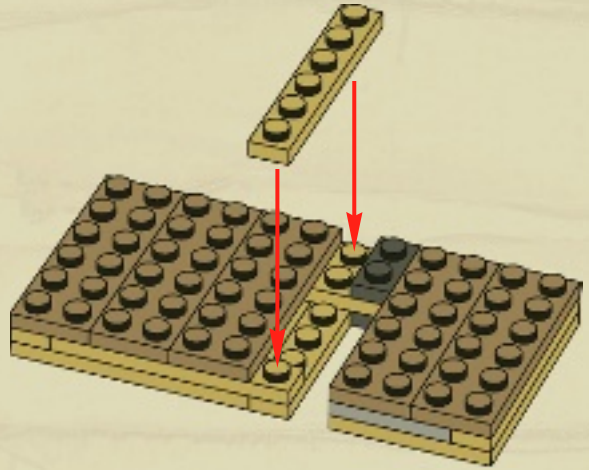

8

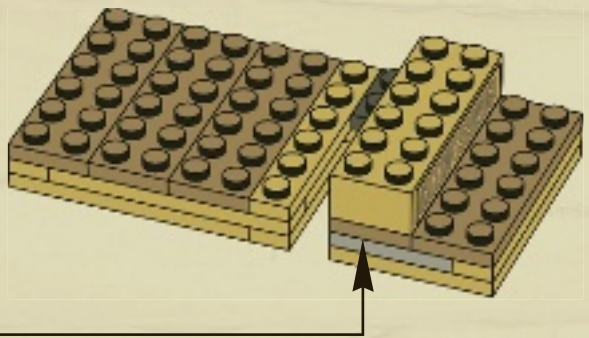
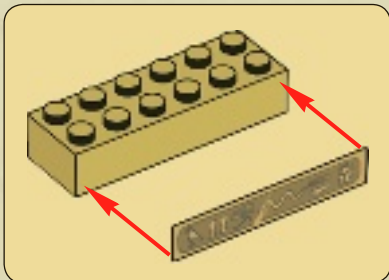



9

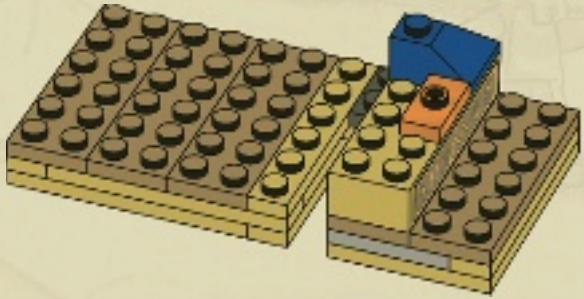

21

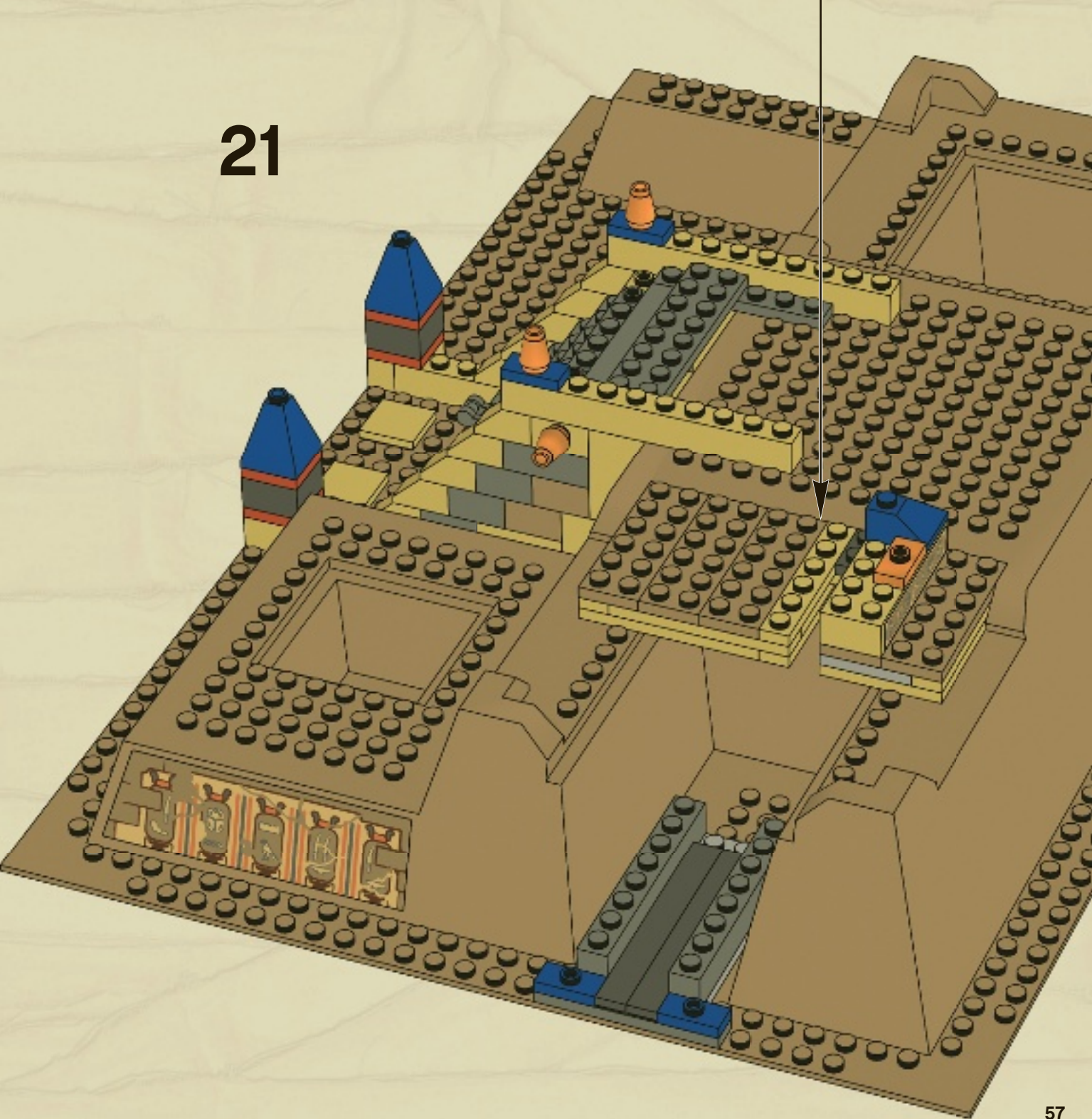



22

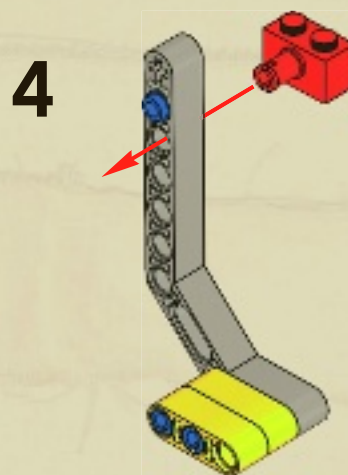
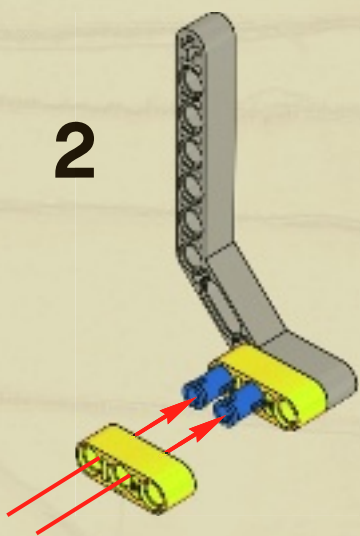
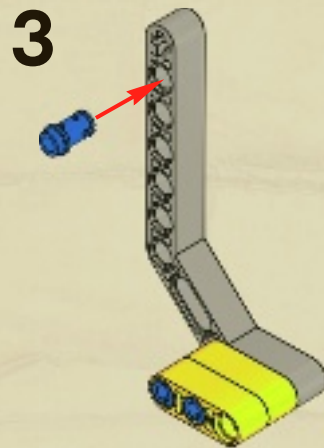
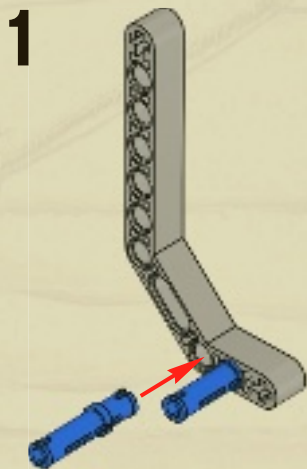

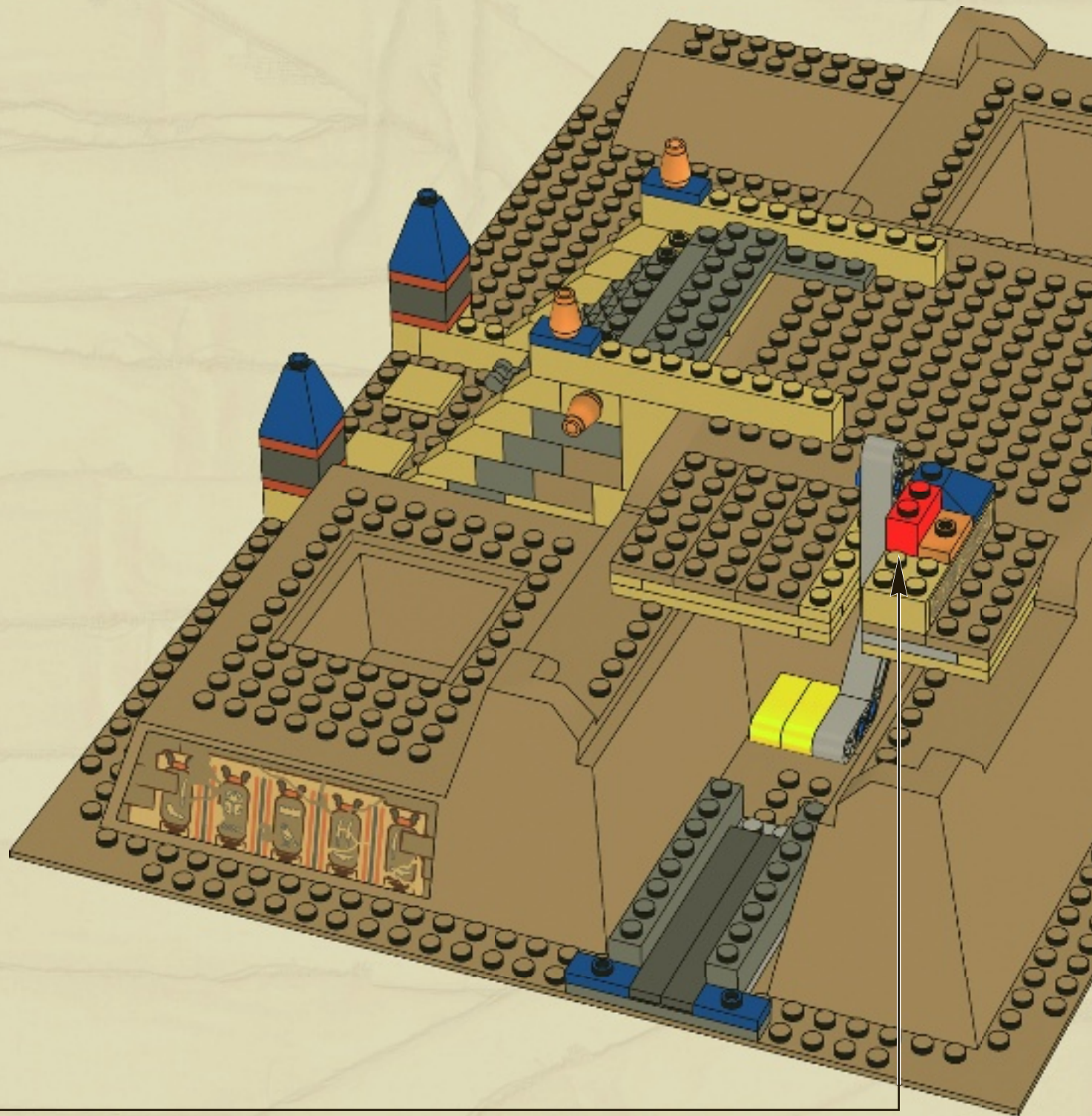



1x

23

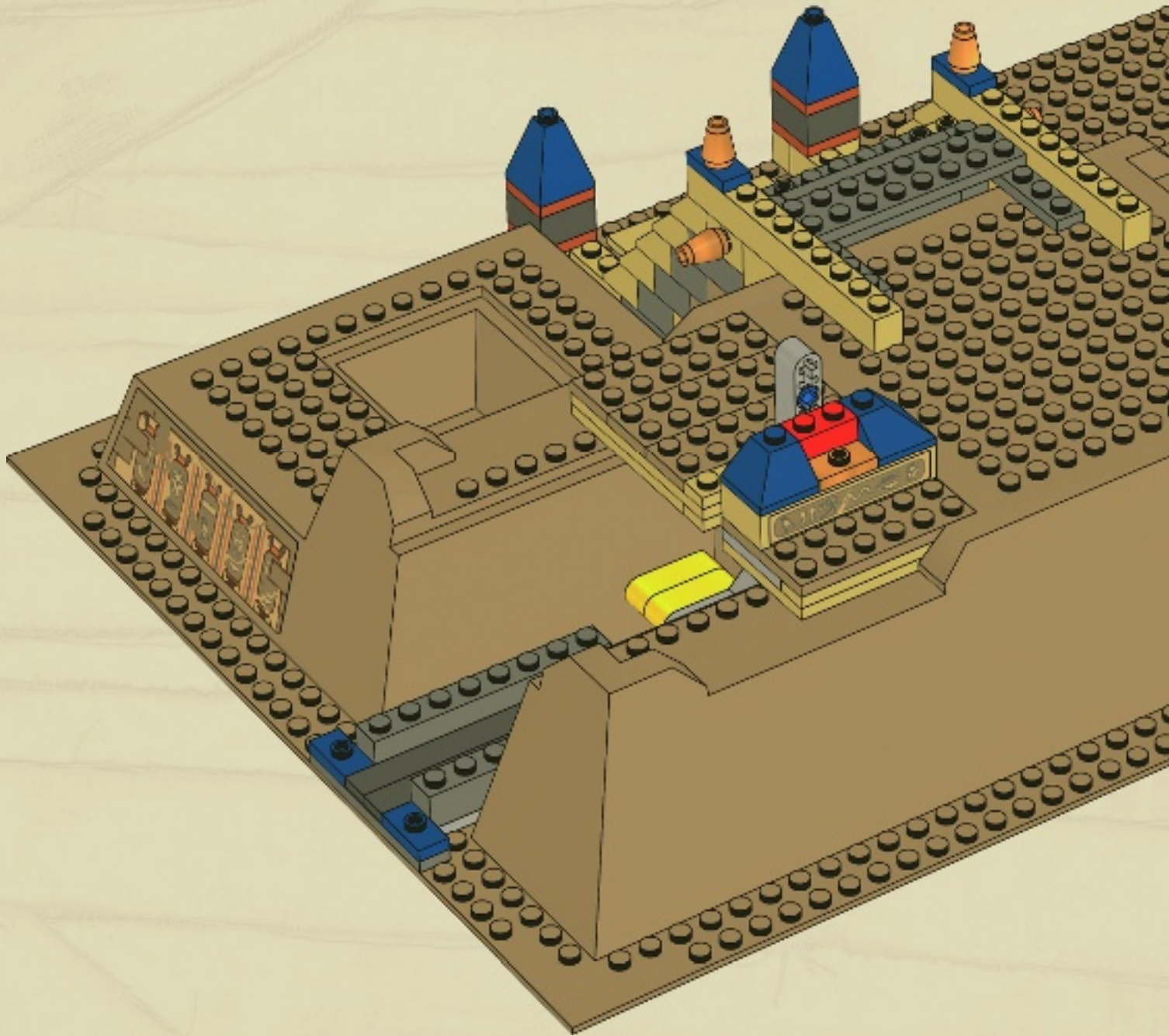



1x



1x

24

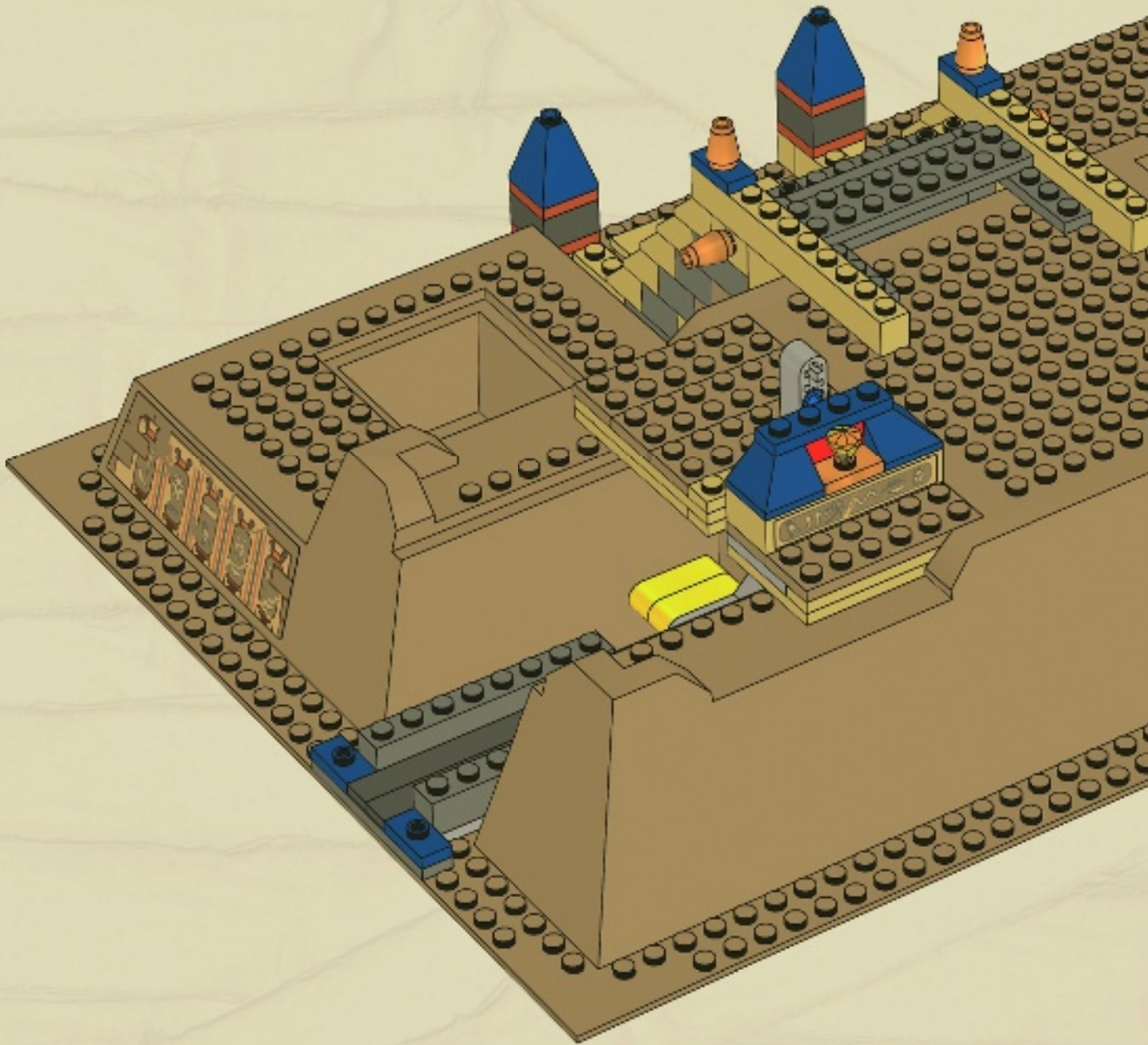

1x  1x 

25

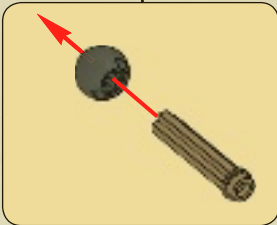
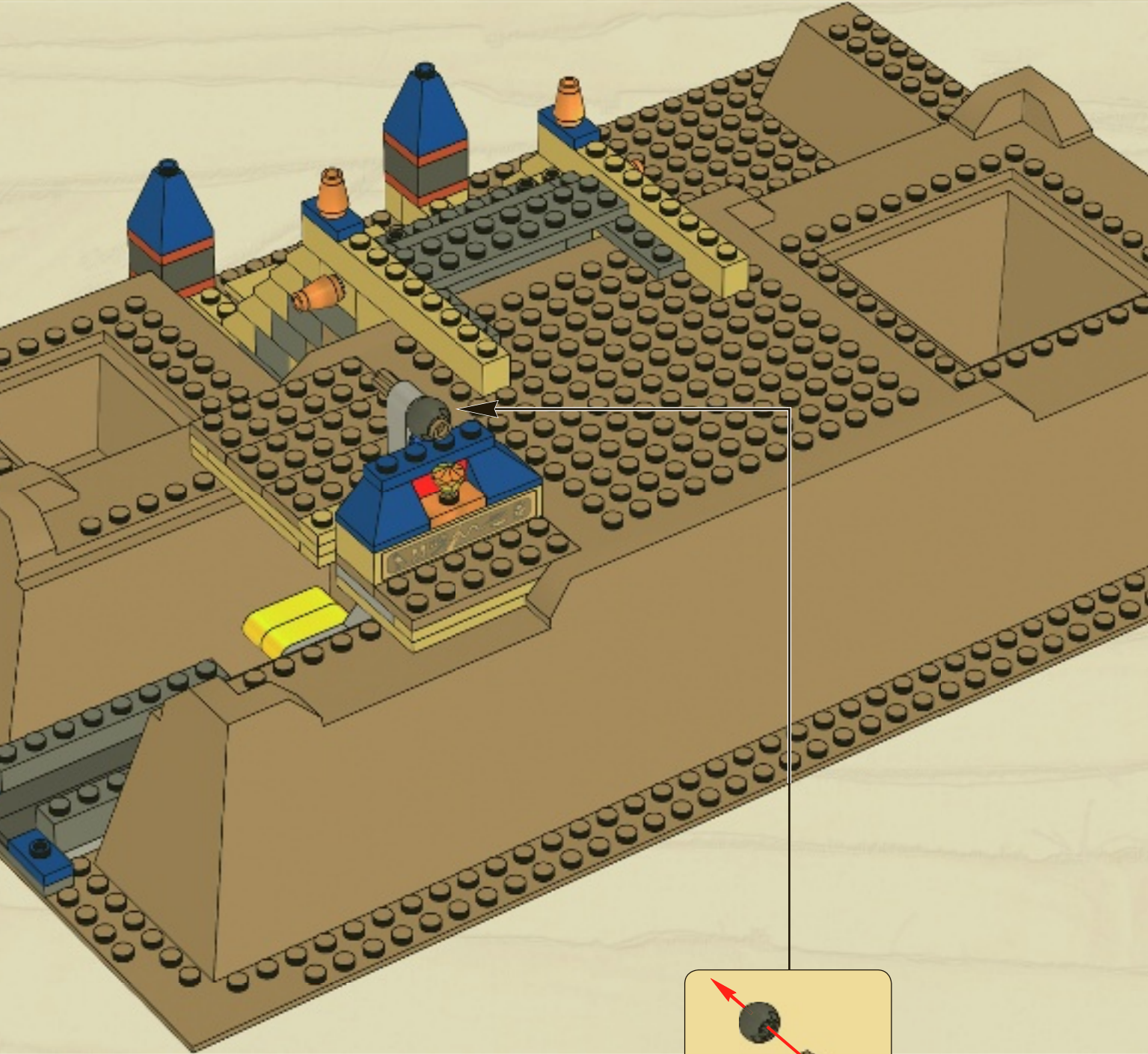

1x

26

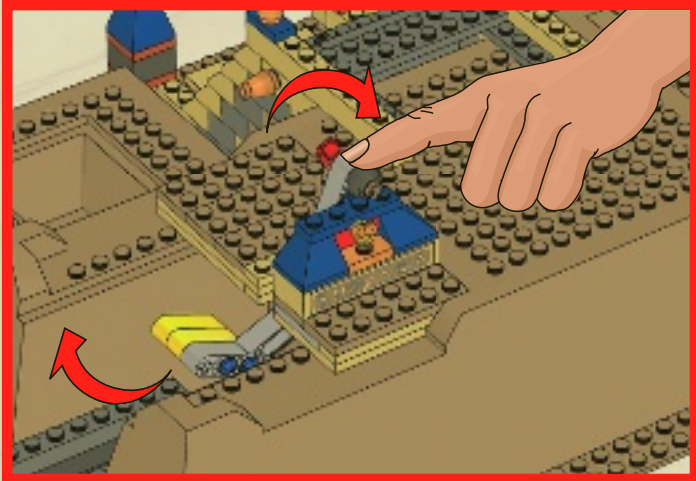
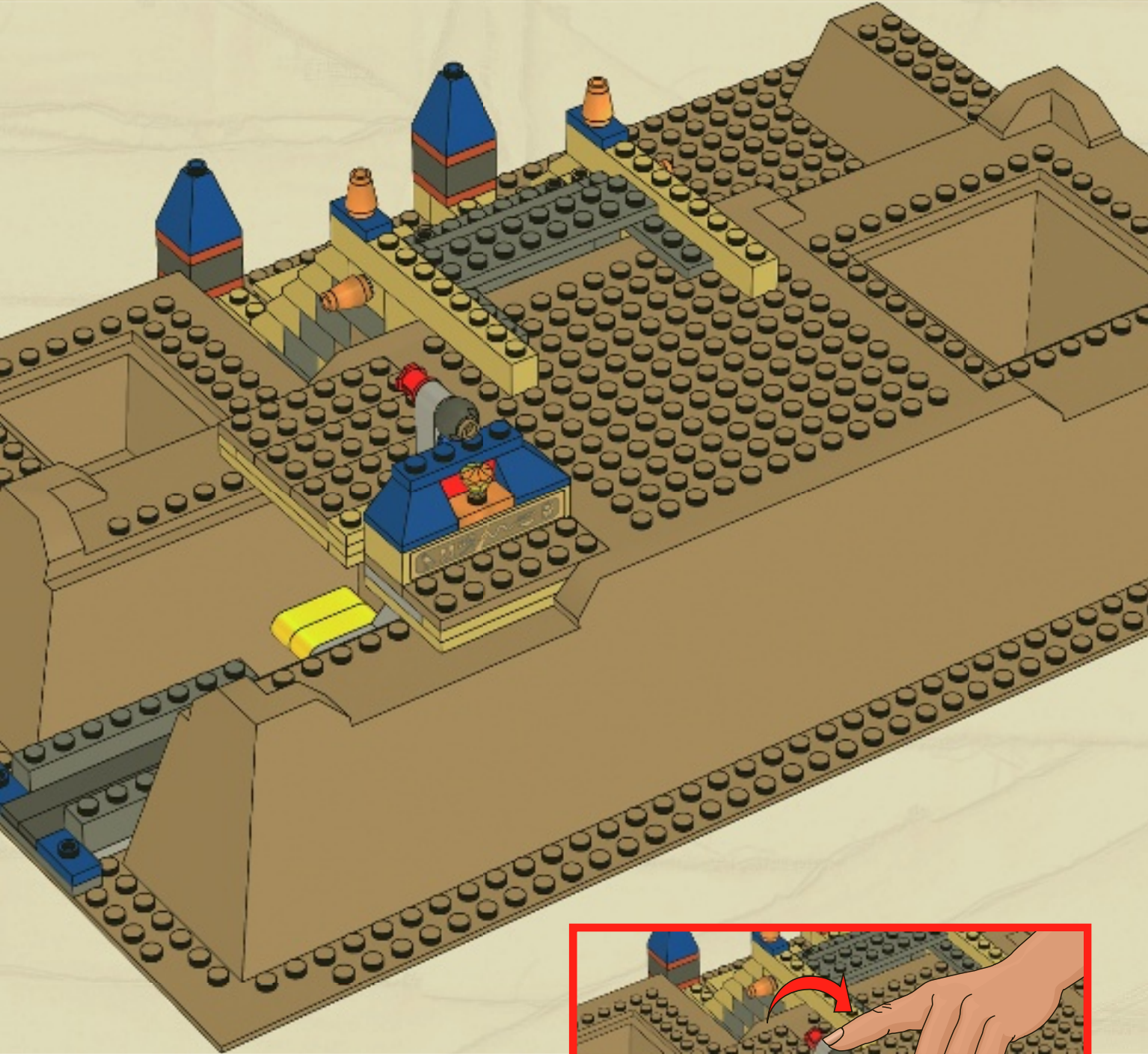



27

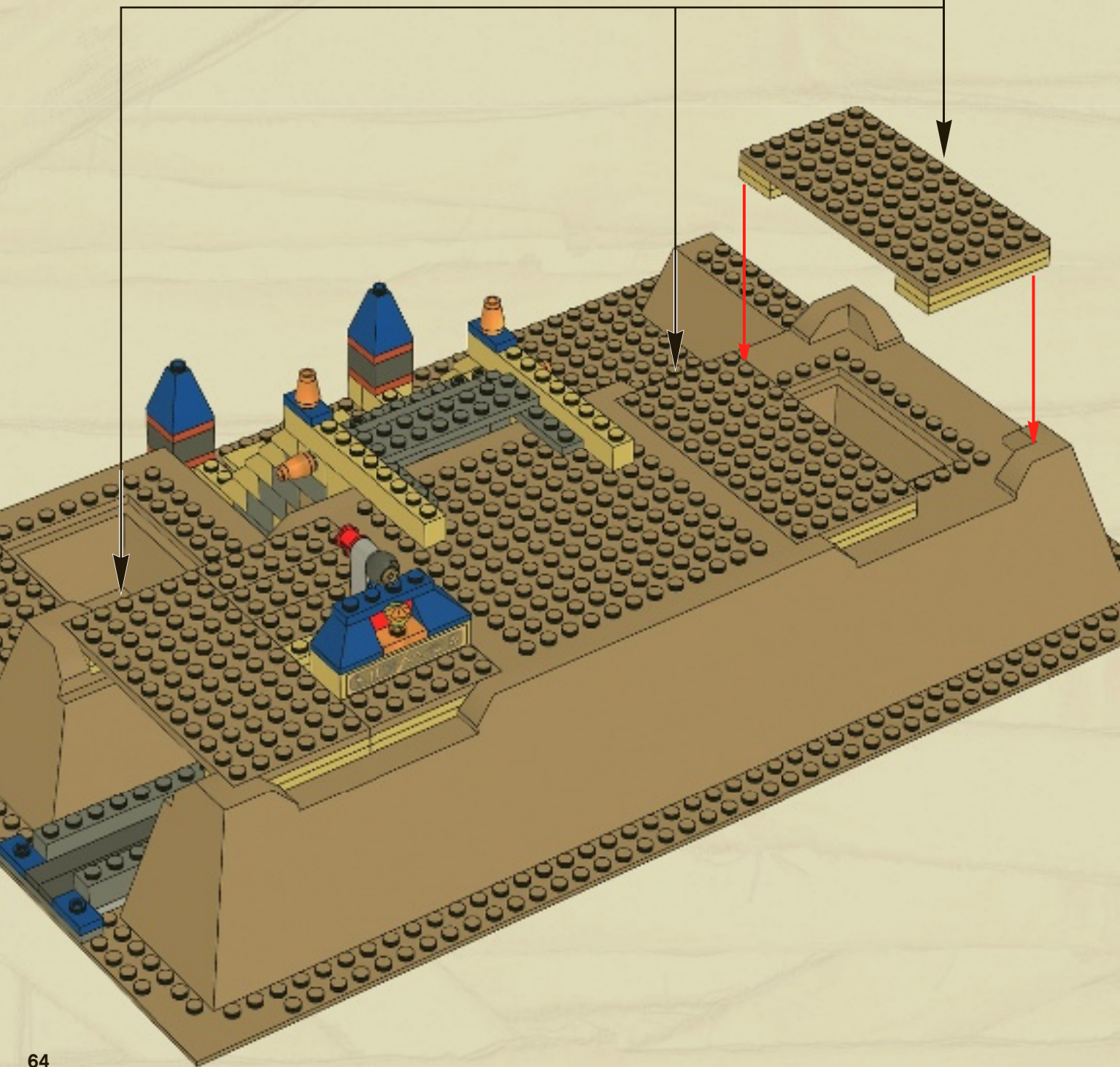
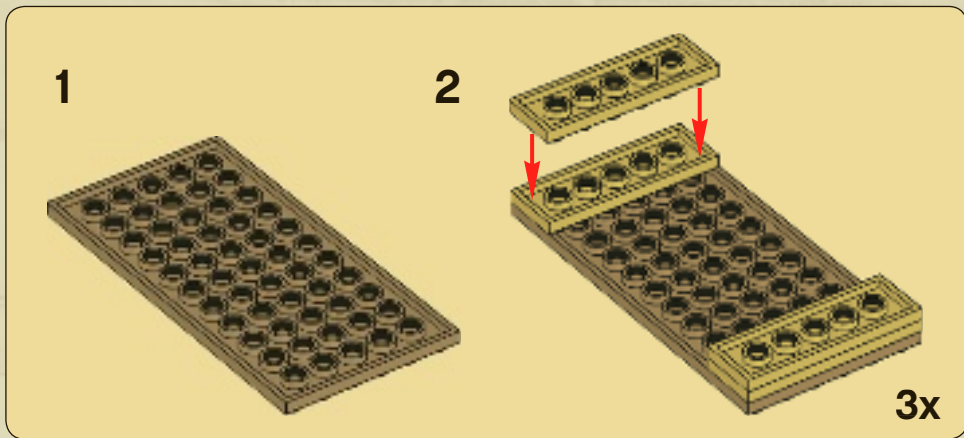



2x

28

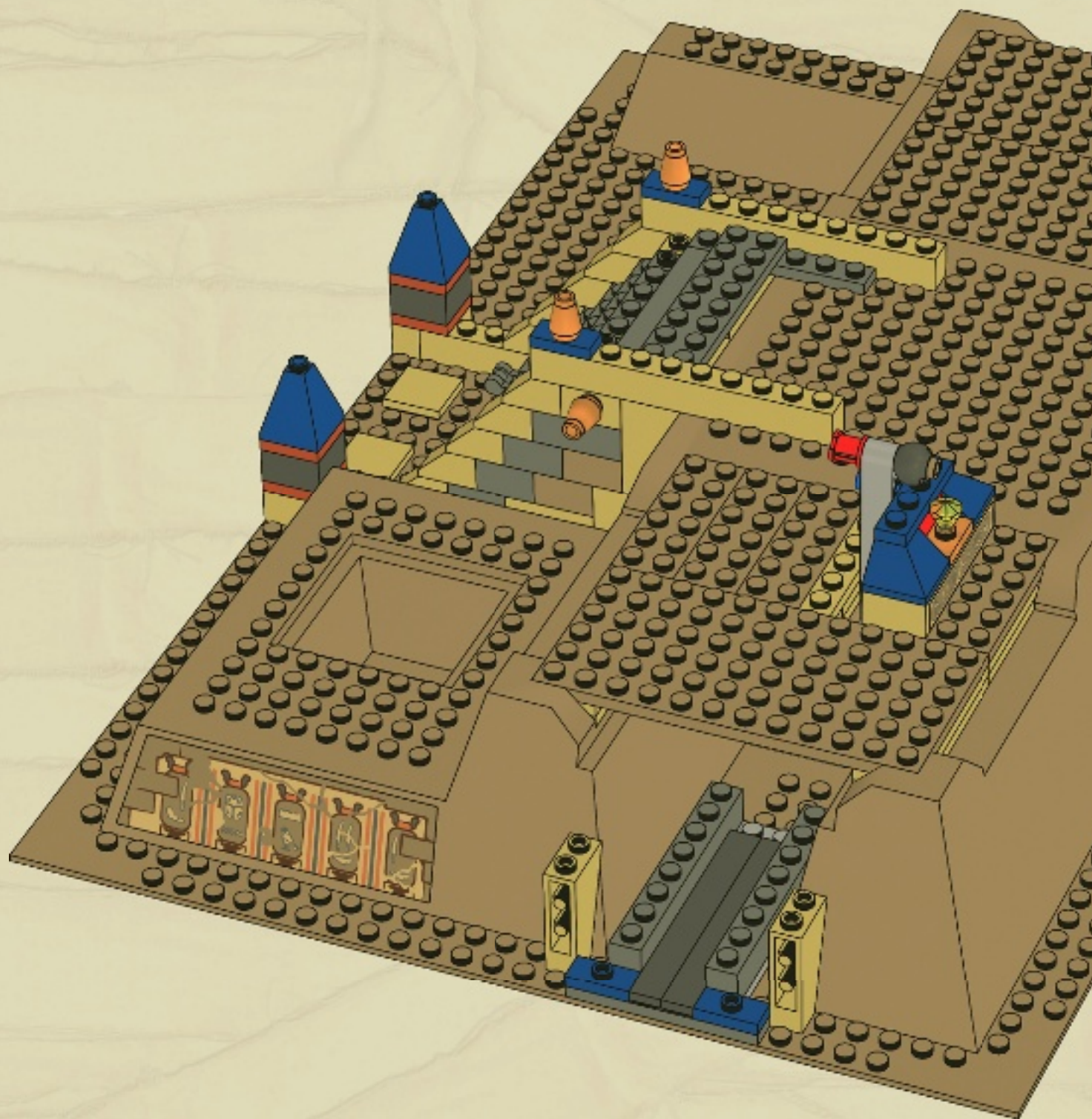

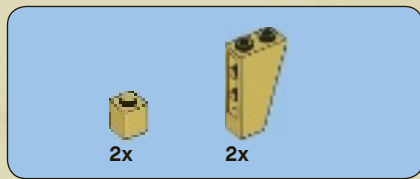

29

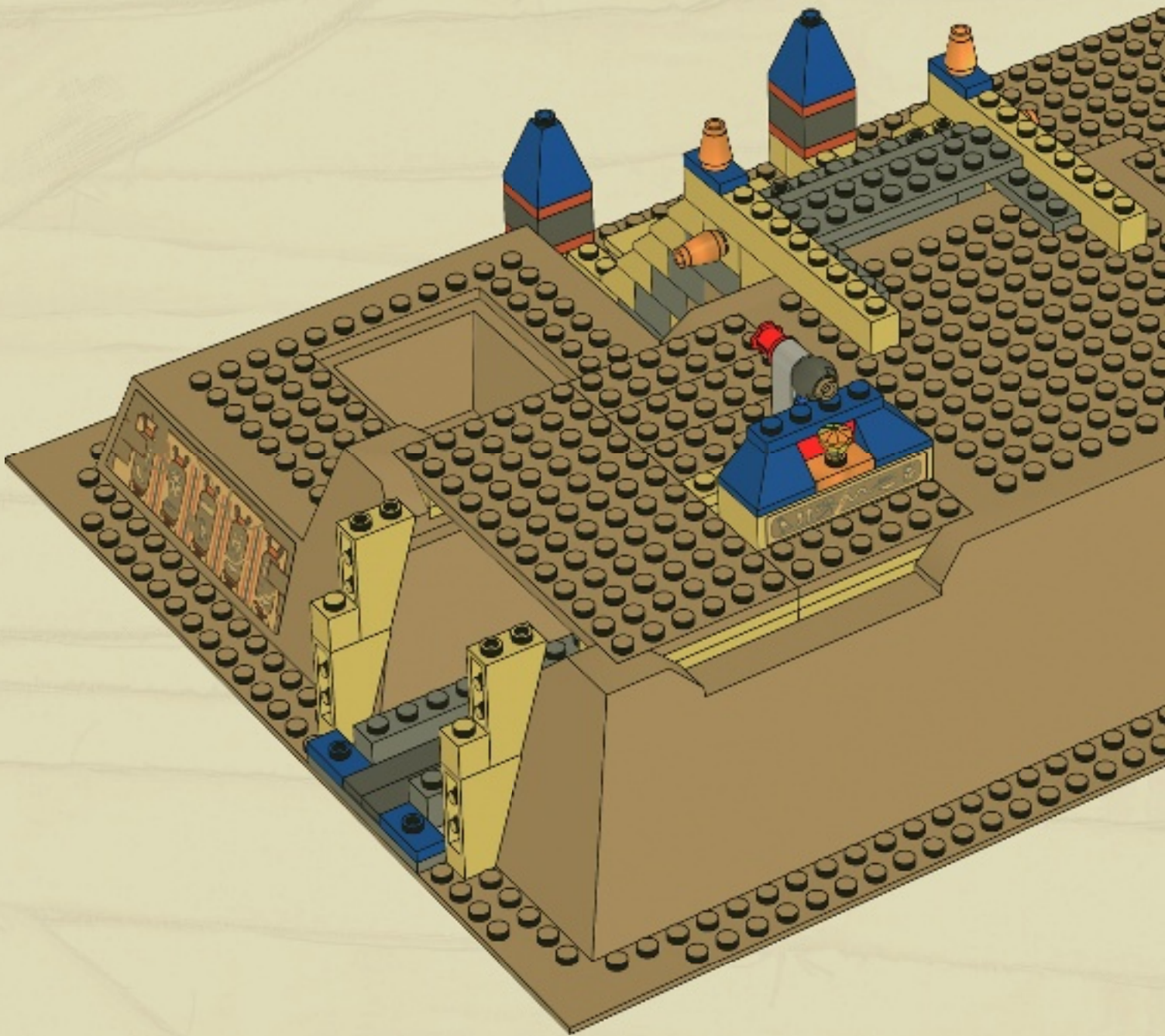

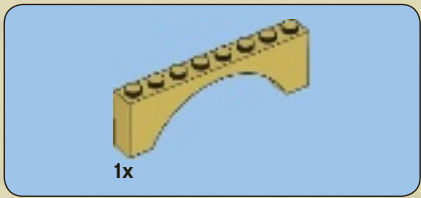

30

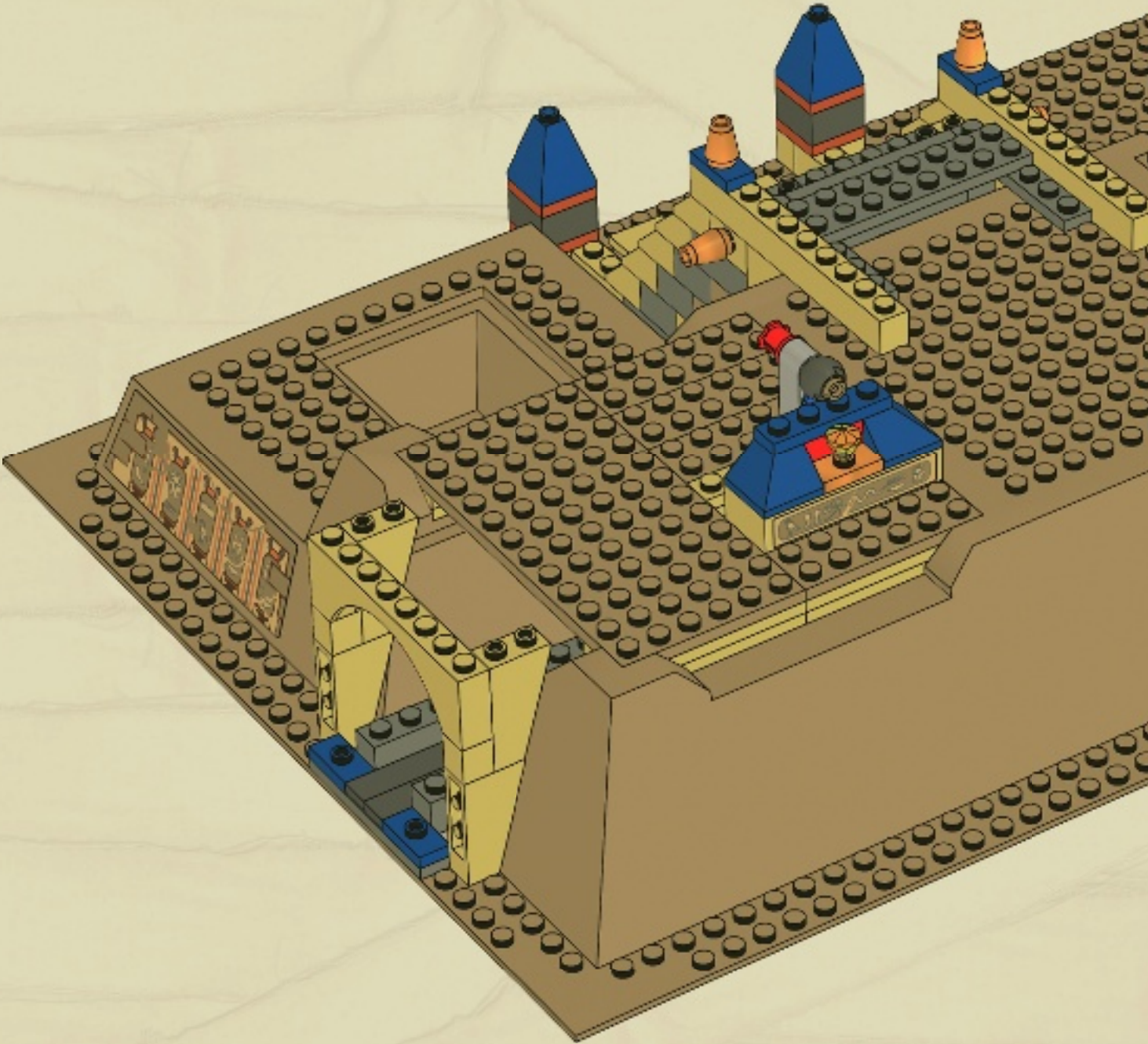

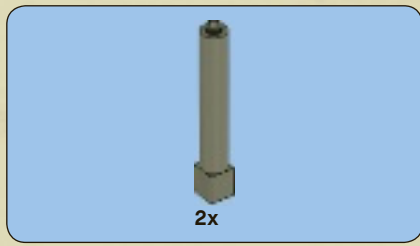

31

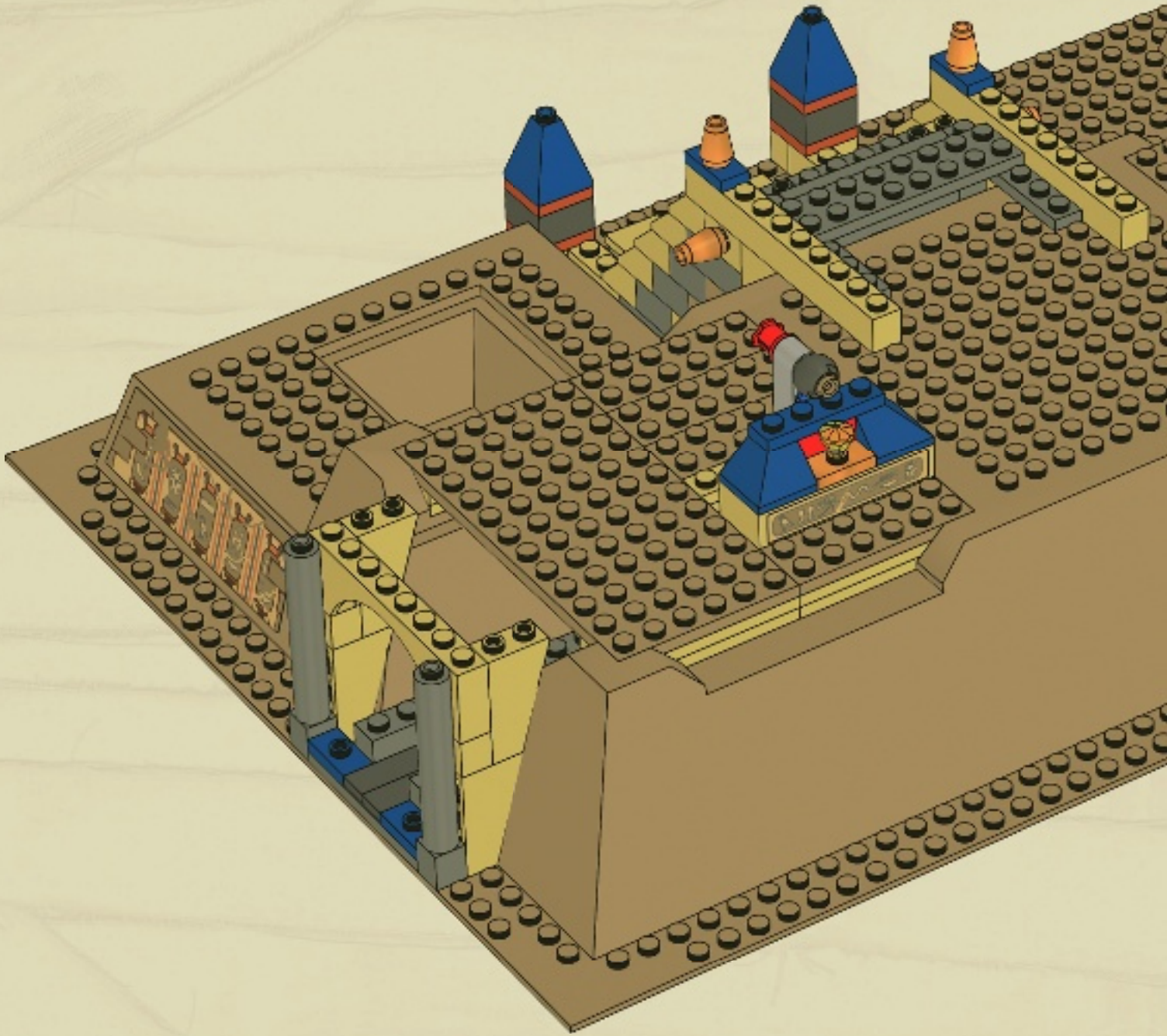

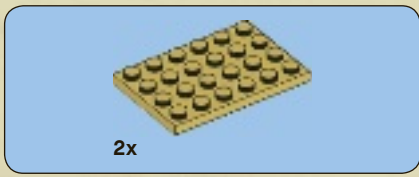

32

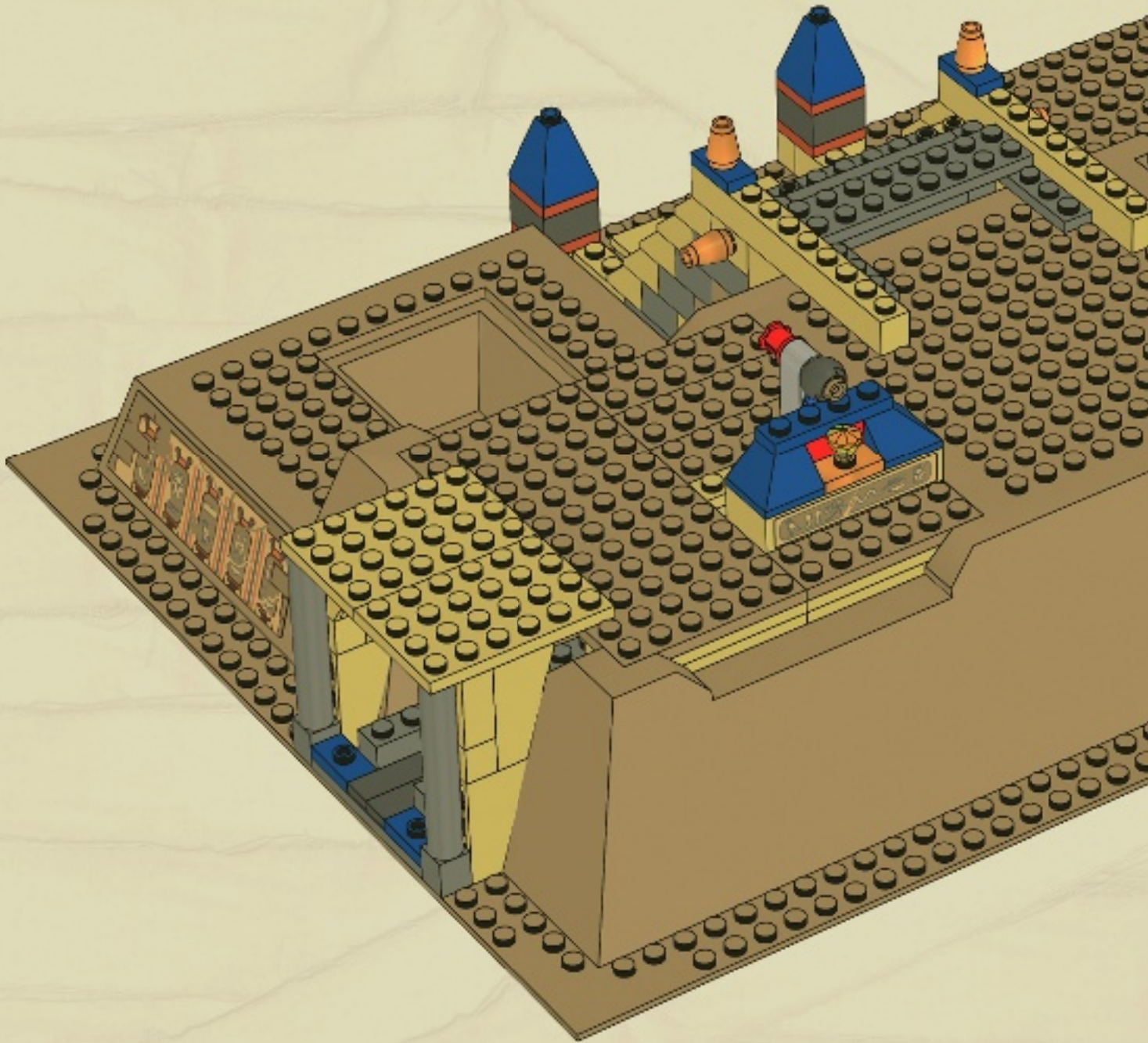

2x 1x 2x

33

2x

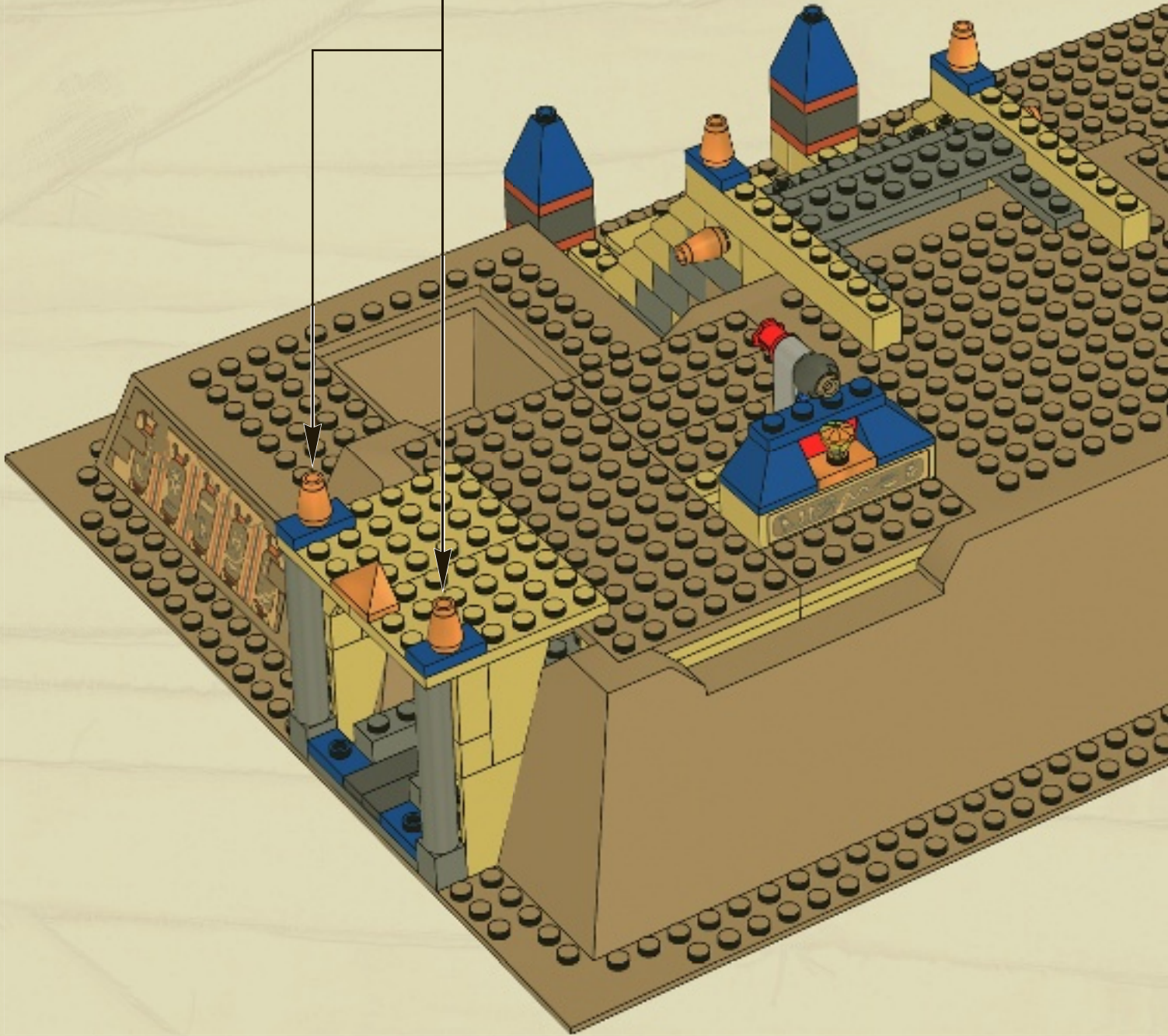

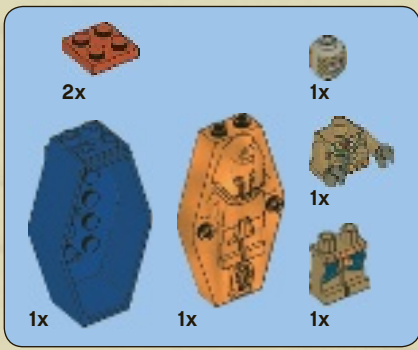

34

1

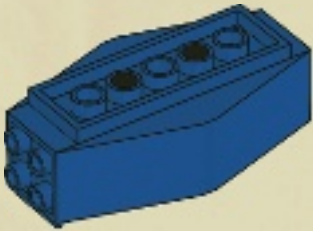

2

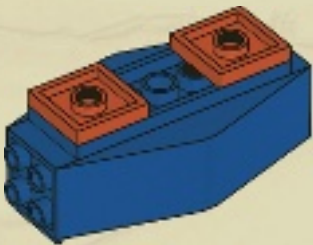

3

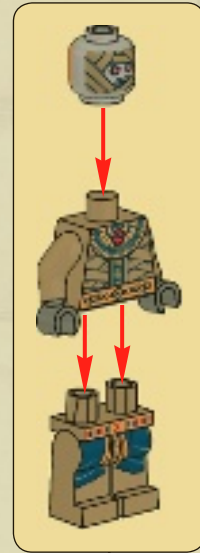
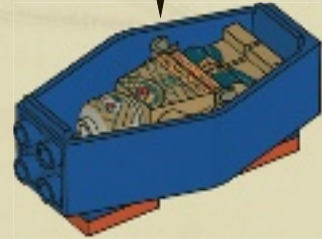
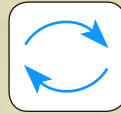

4

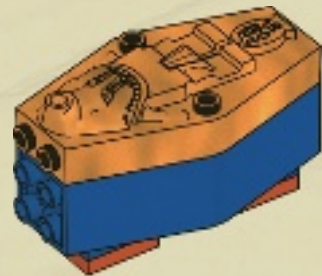

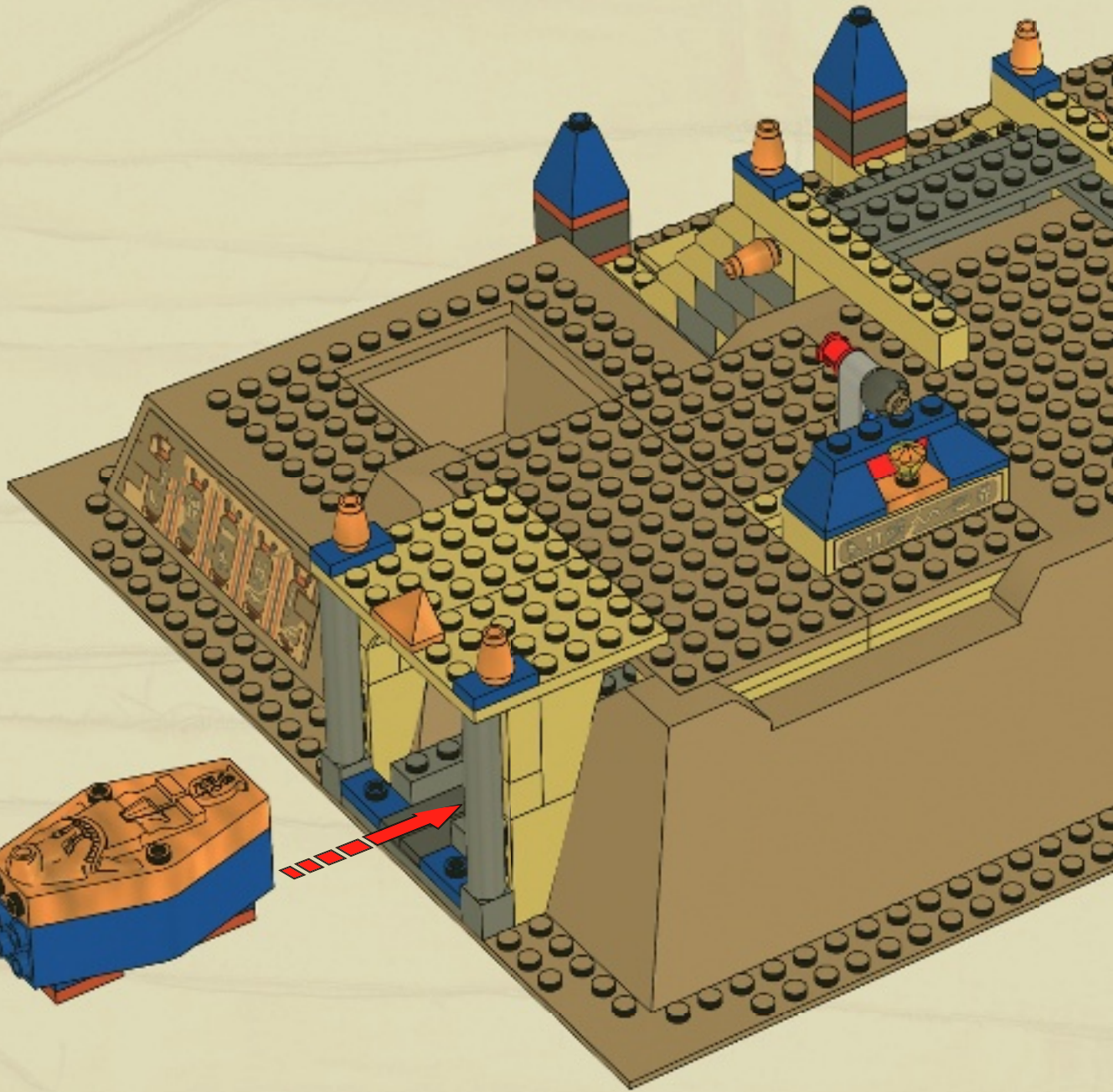



3

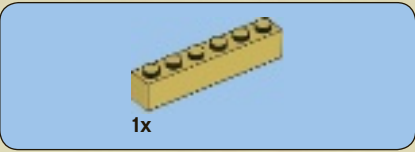
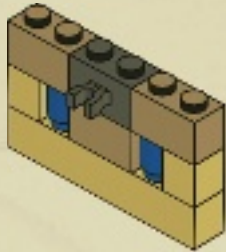

1

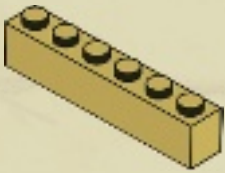

4

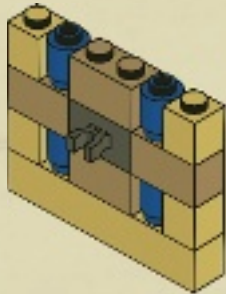

2

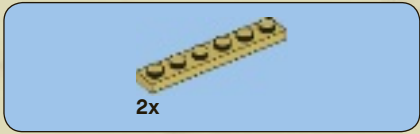
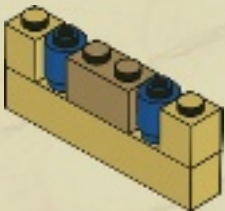

5

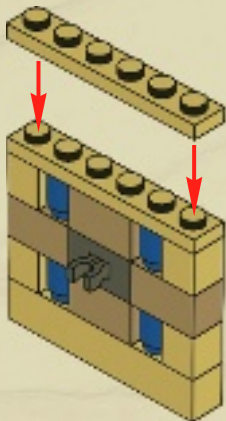

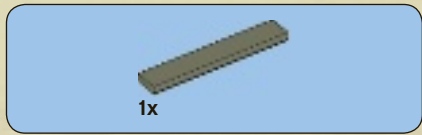

6

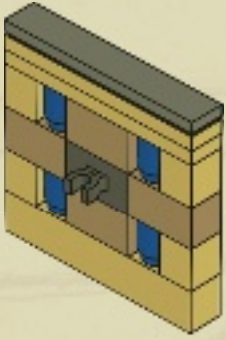

35

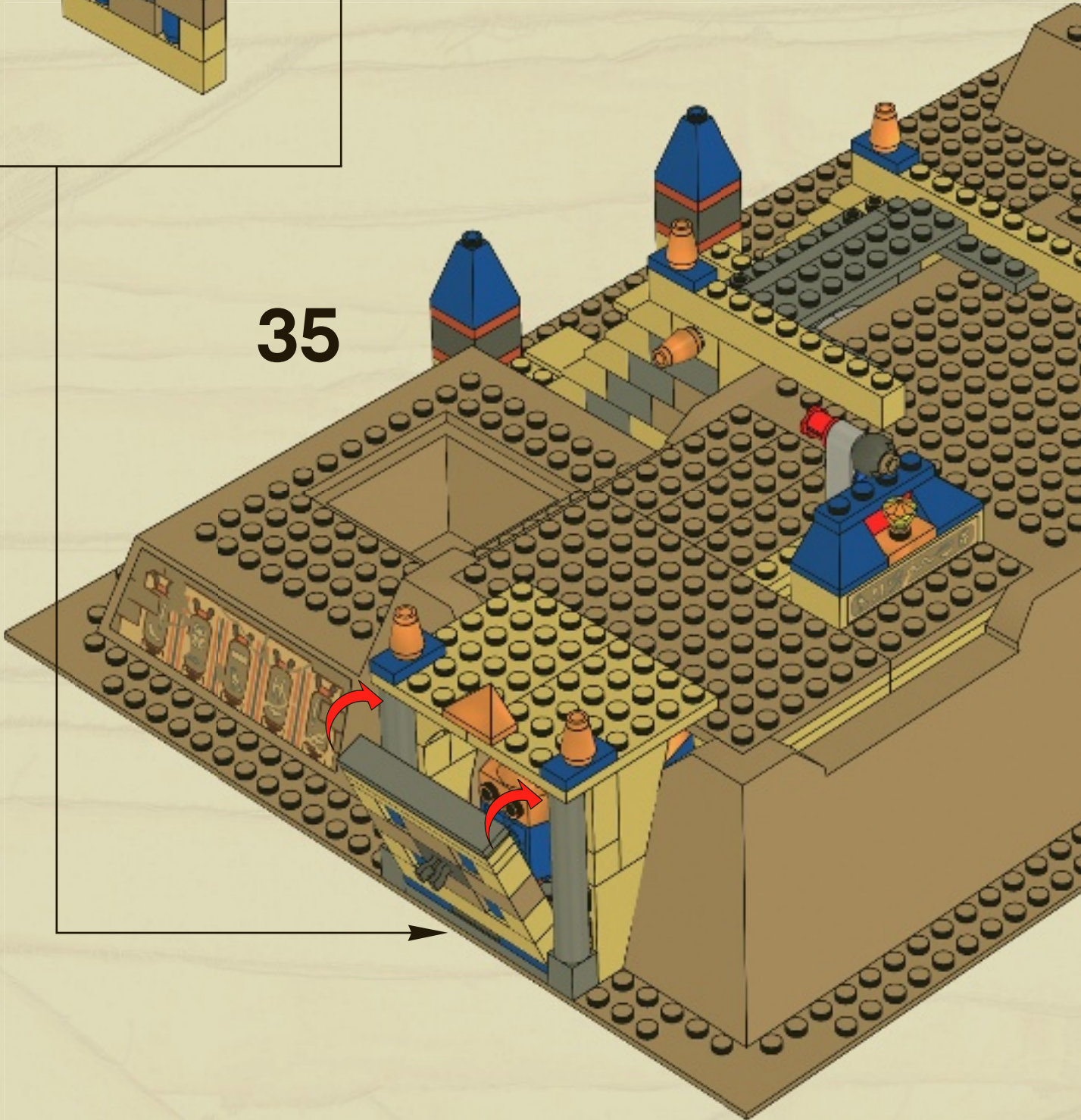

1

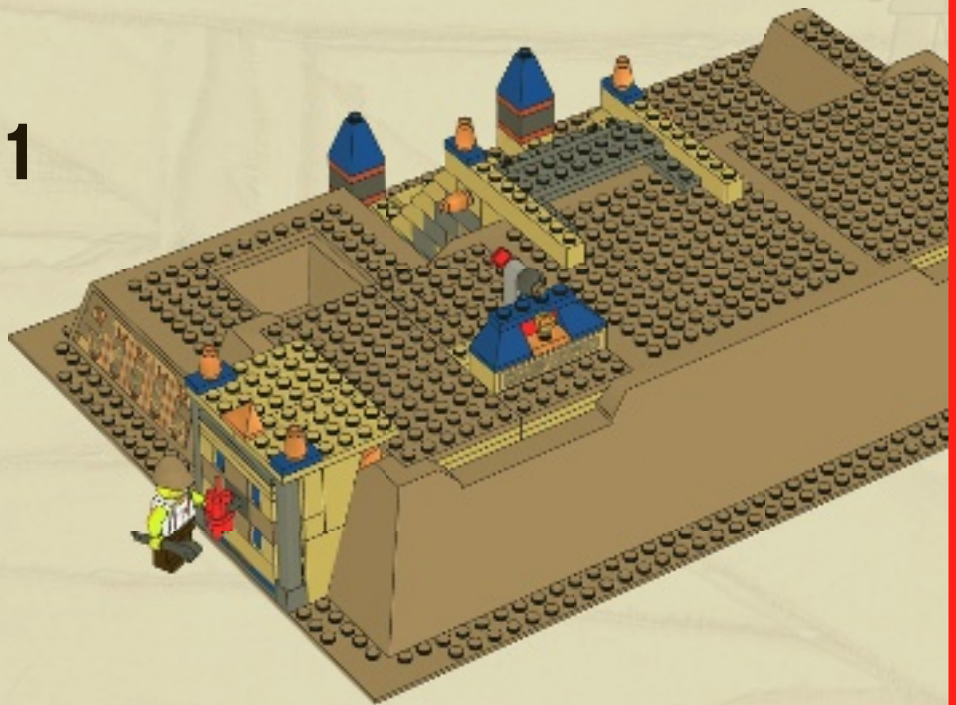

2

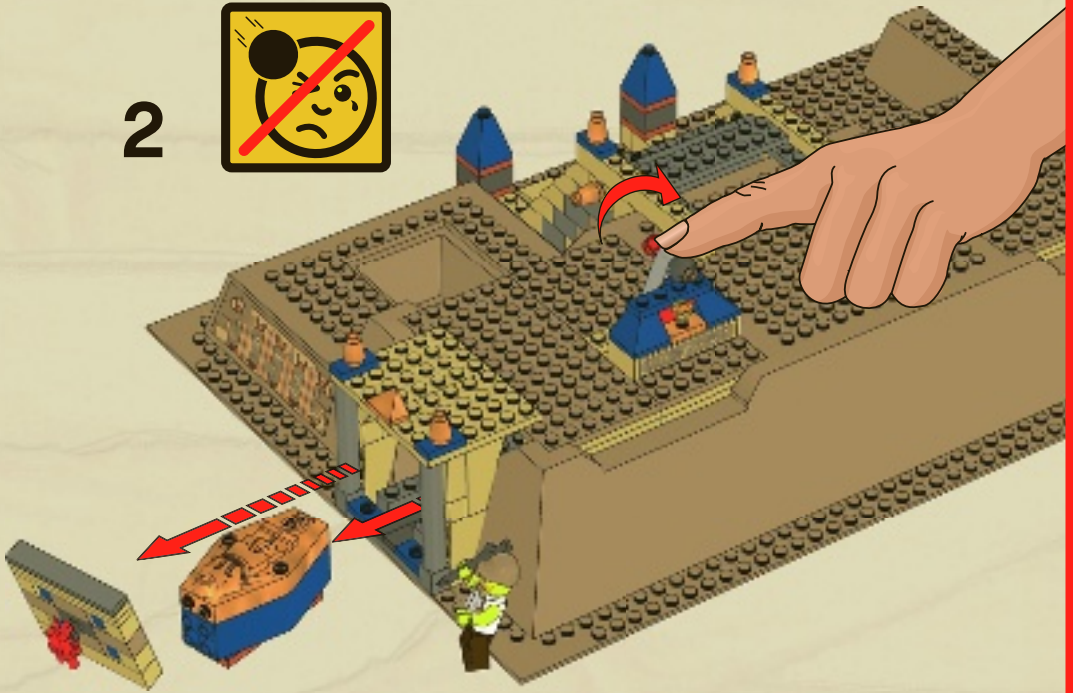



PHARAOH'S QUEST





PHARAOH'S QUEST

7327



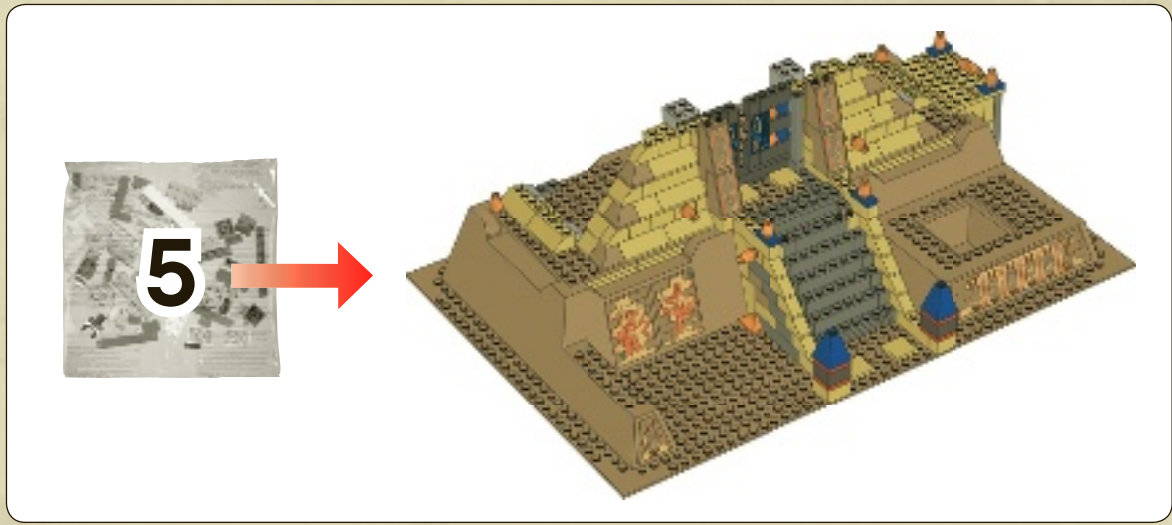

36

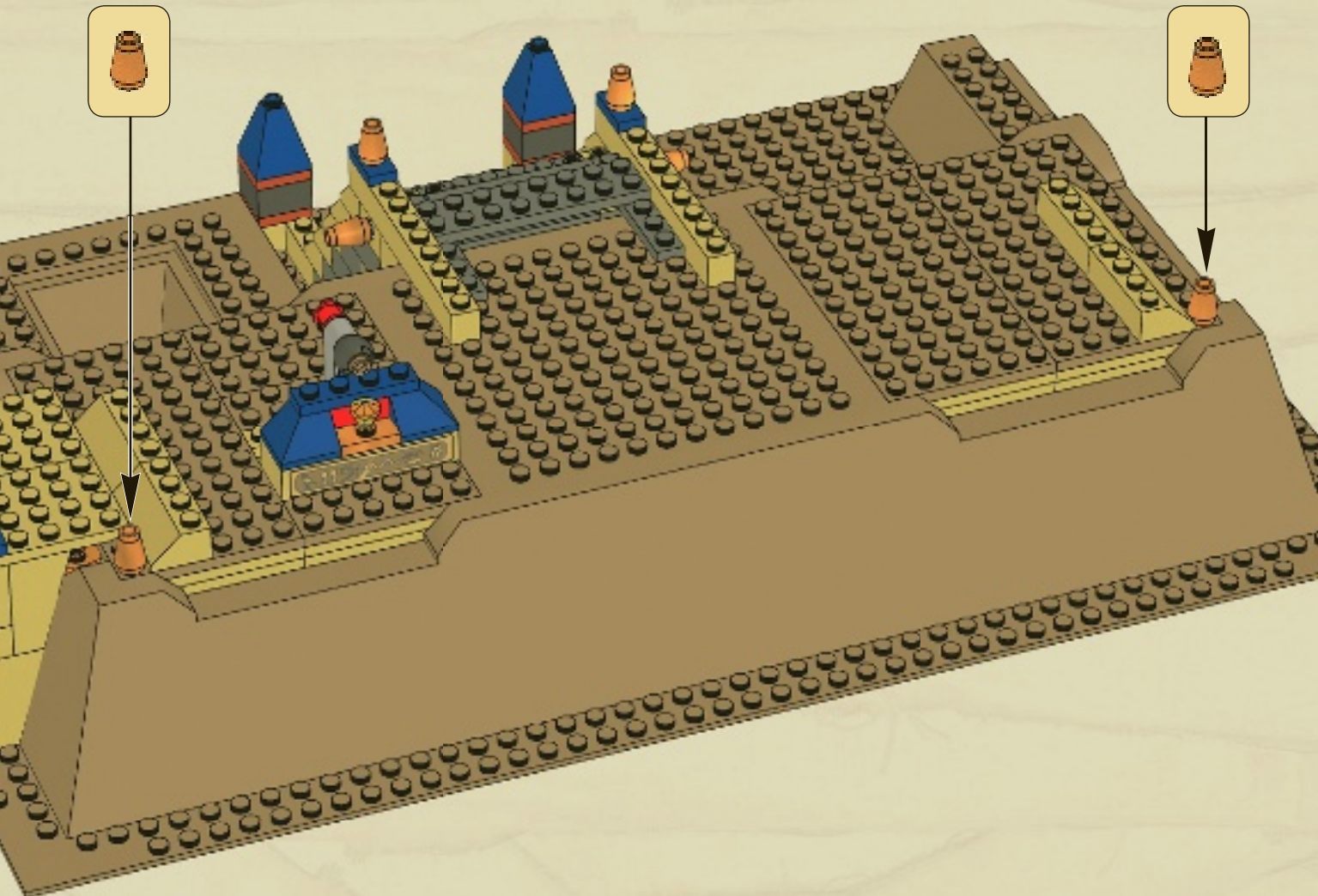

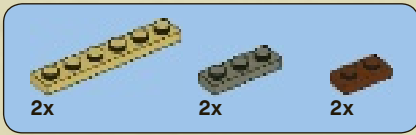

37

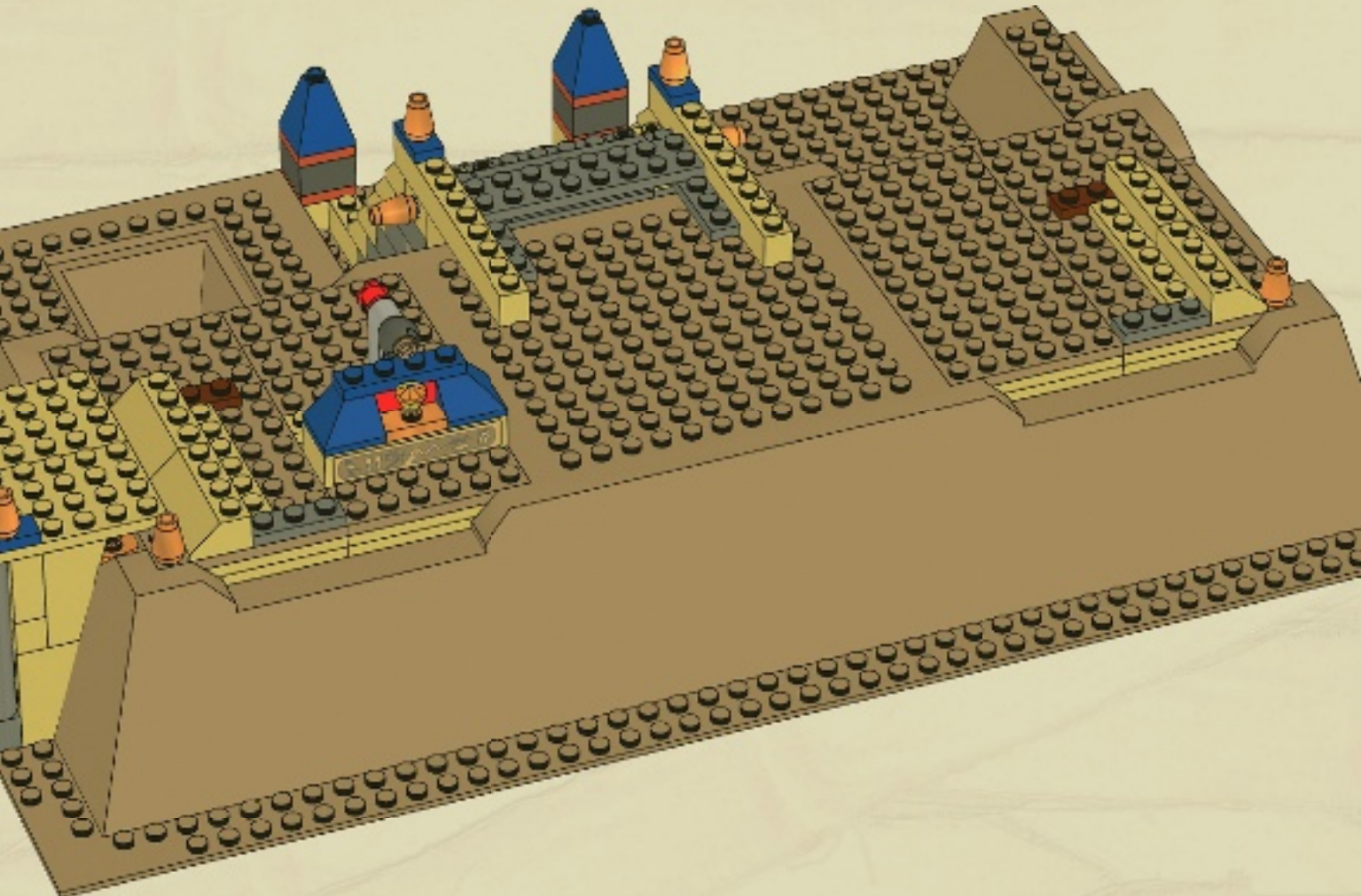



4x

38

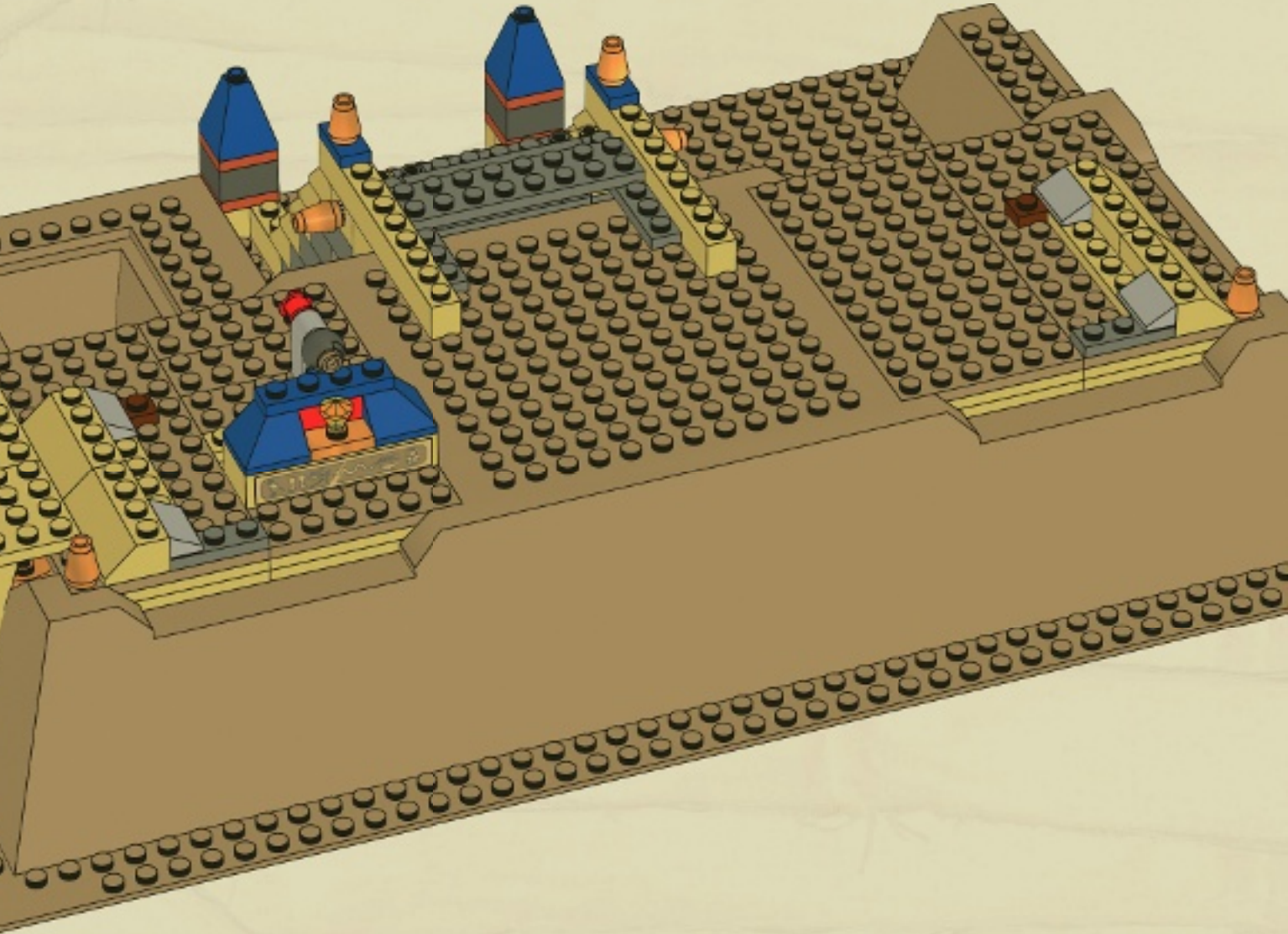

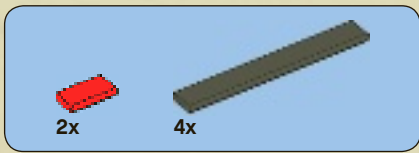

39

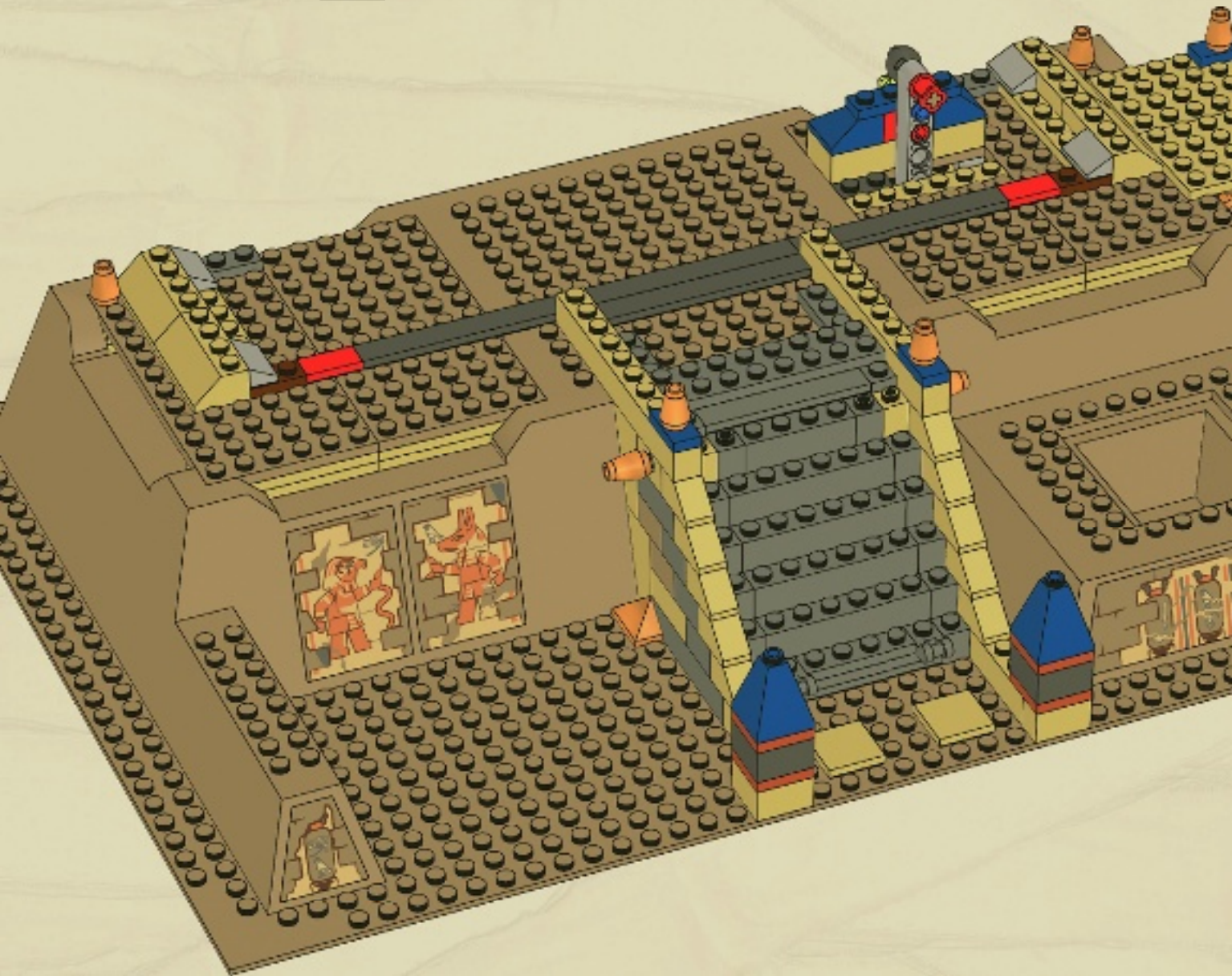

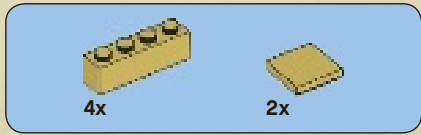

40

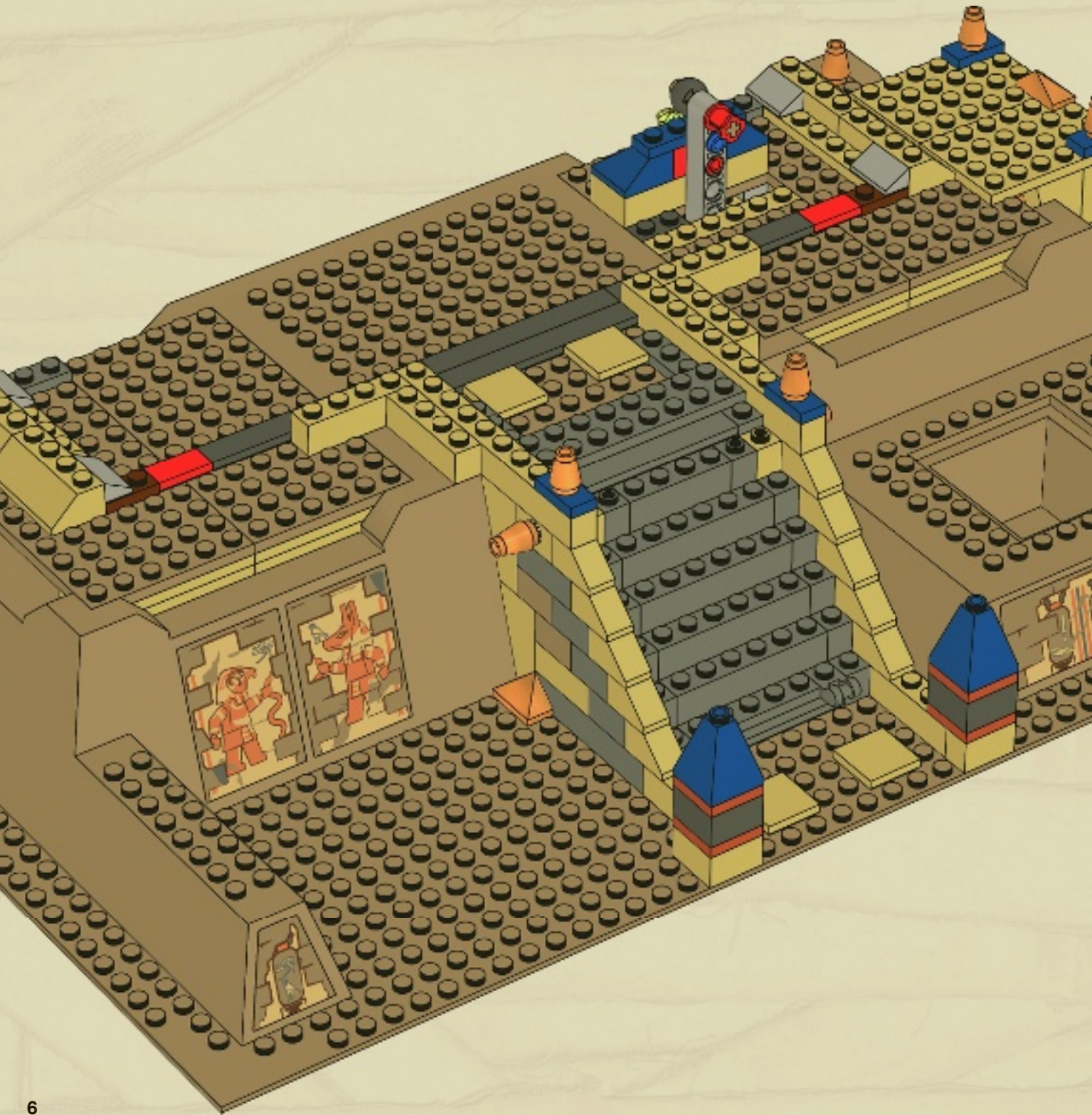

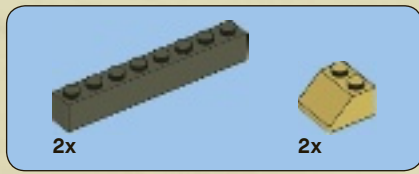

41



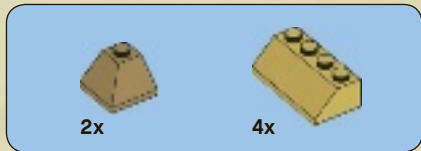

42





2x



2x

43

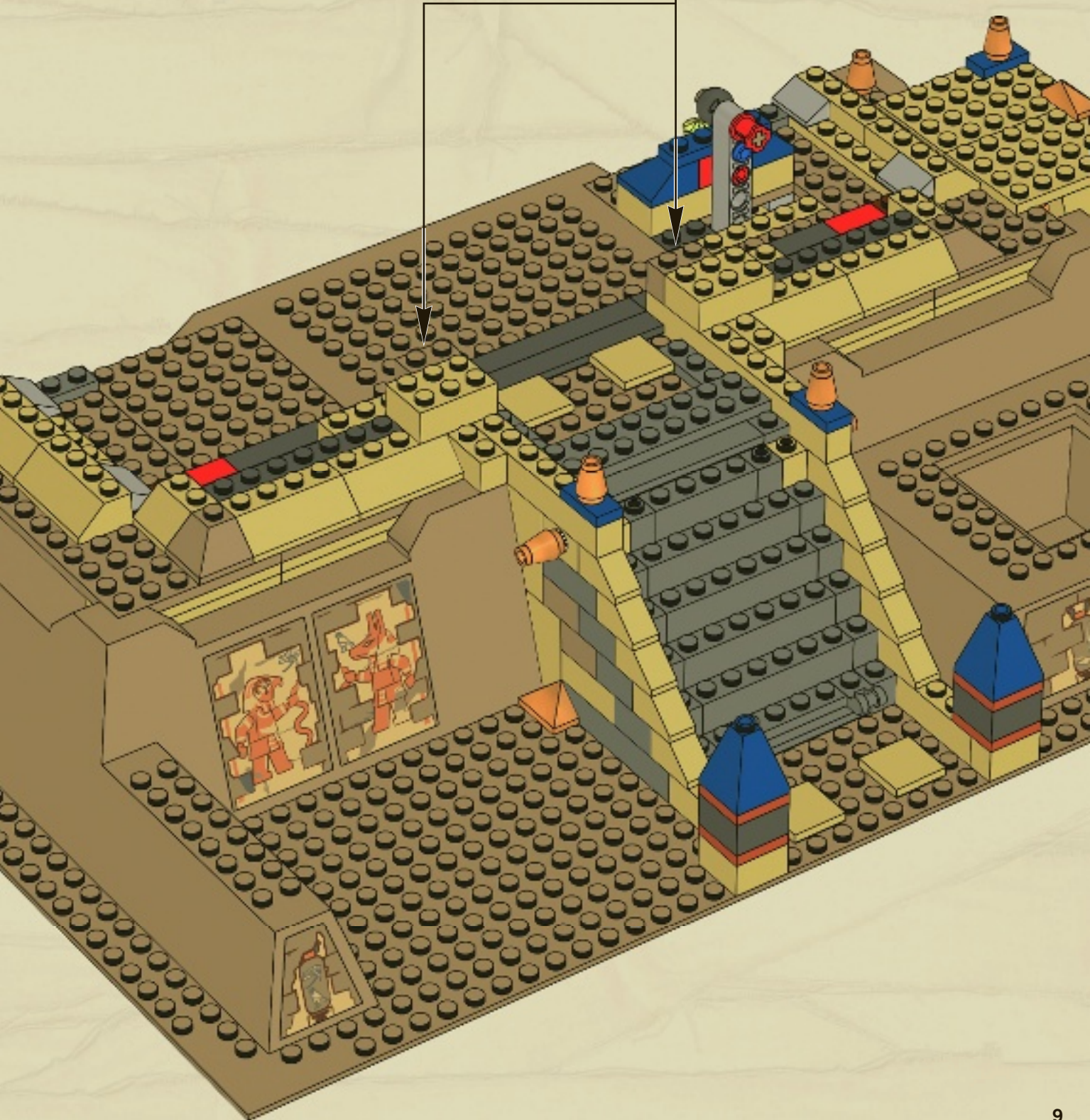
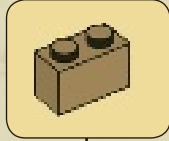



6x

44

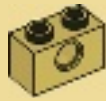

3x

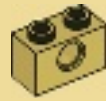

3x

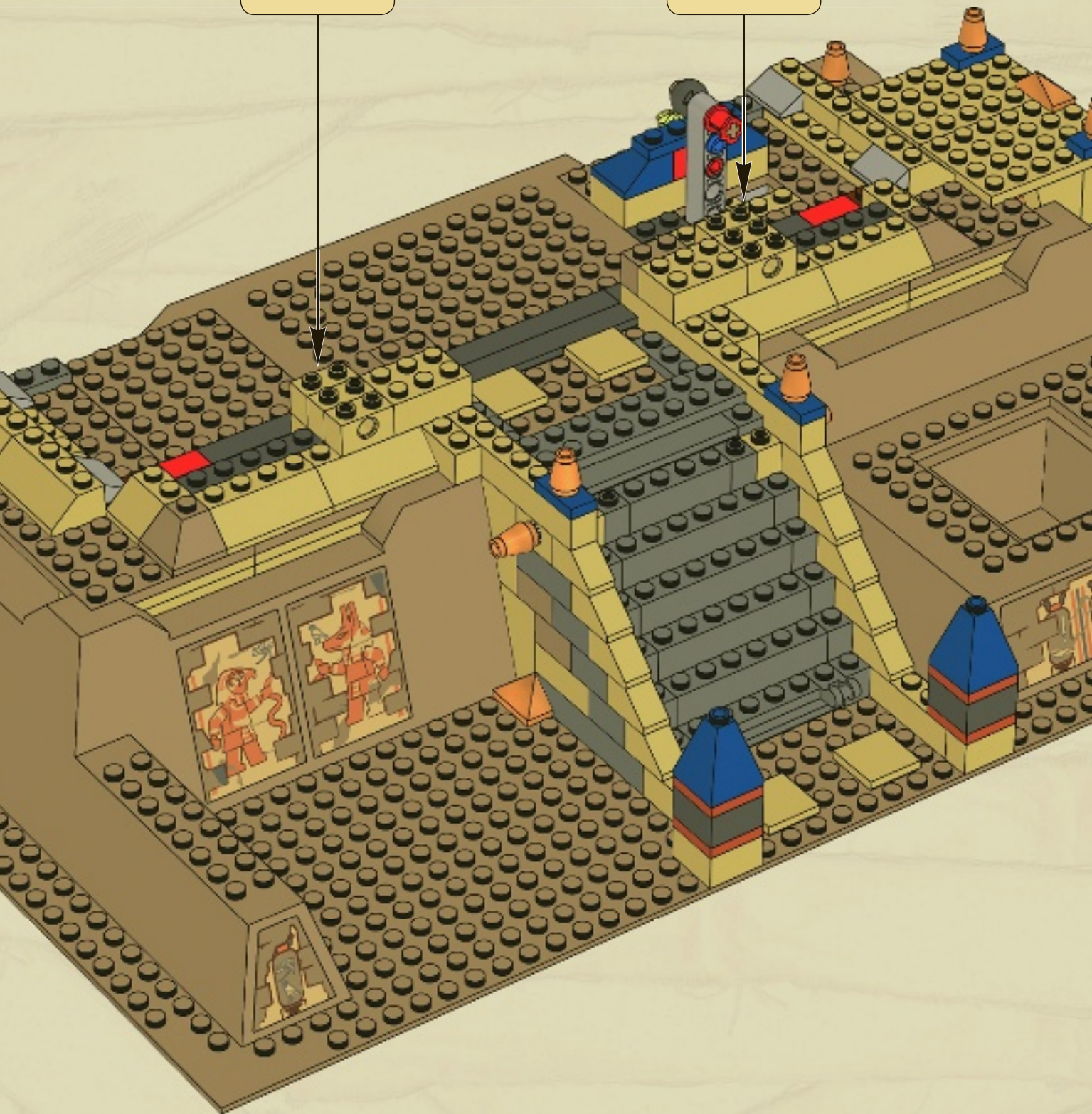

2x 2x 2x

45



2x



46

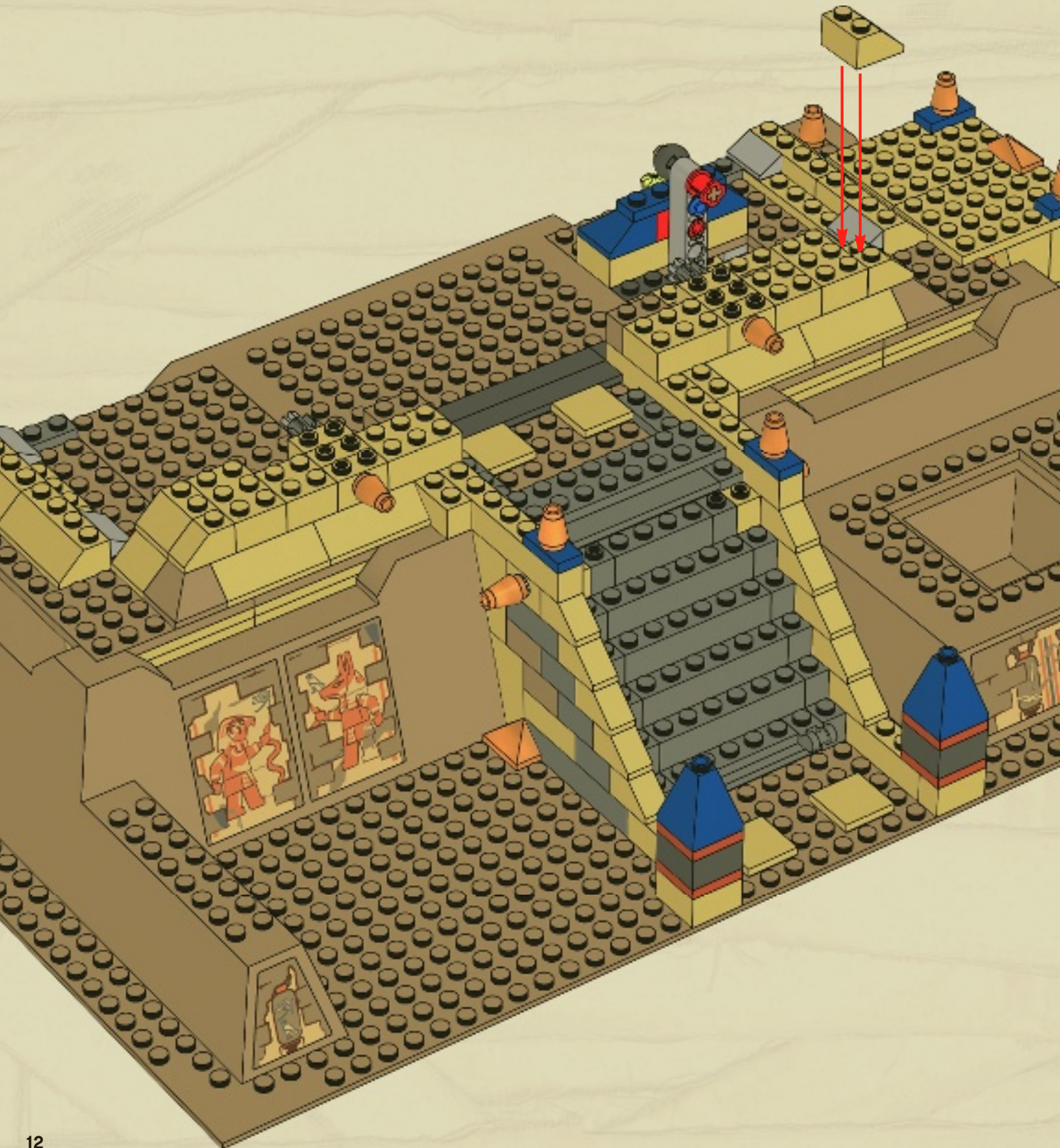

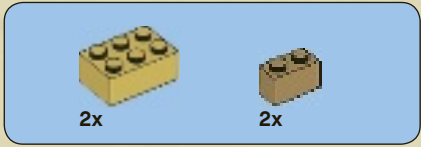

47

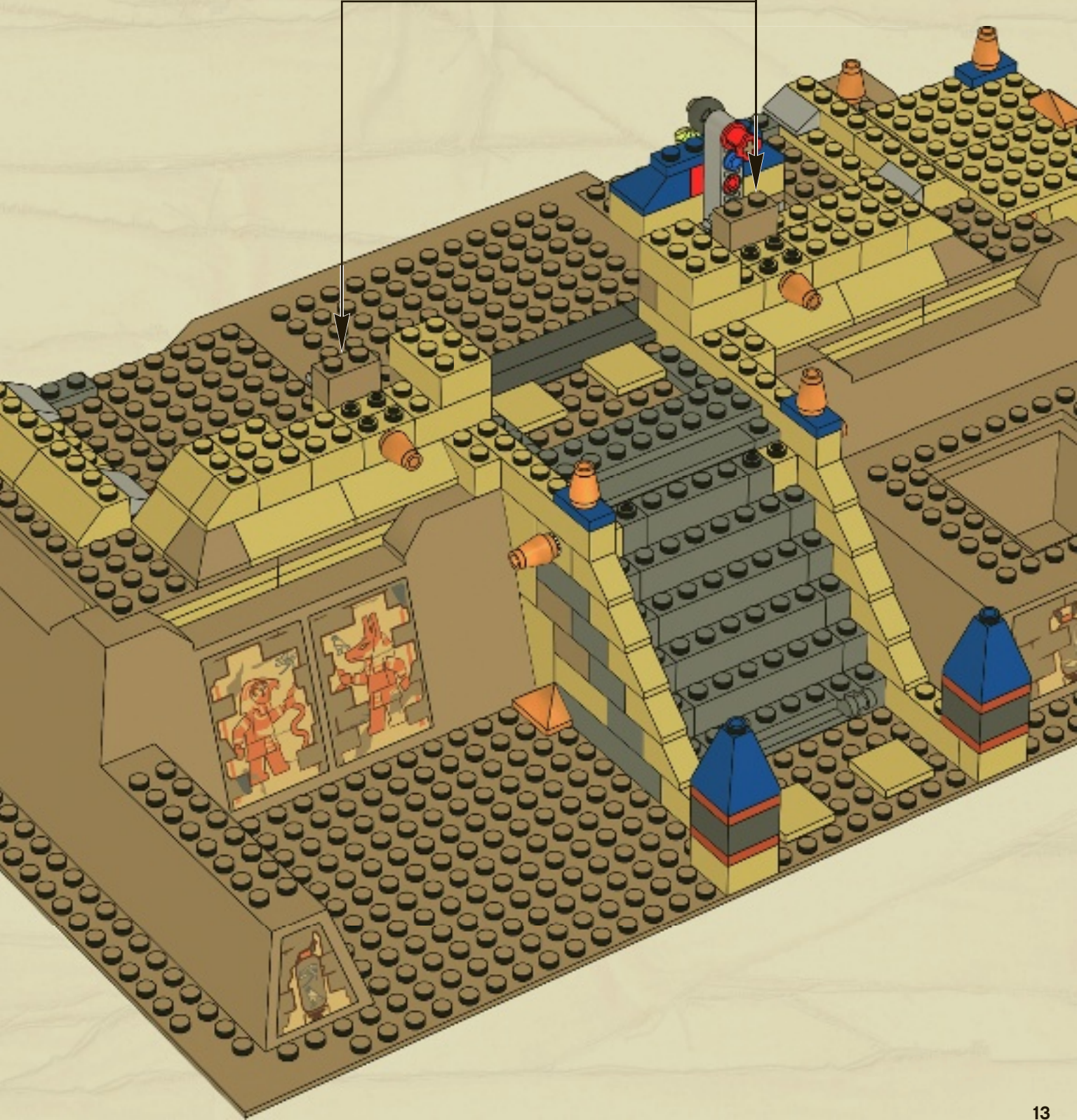
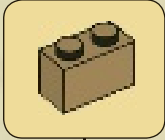

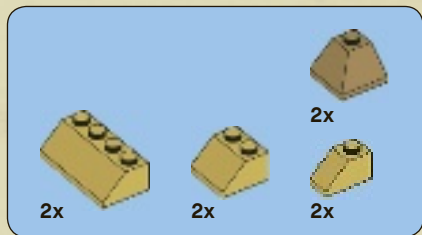

48

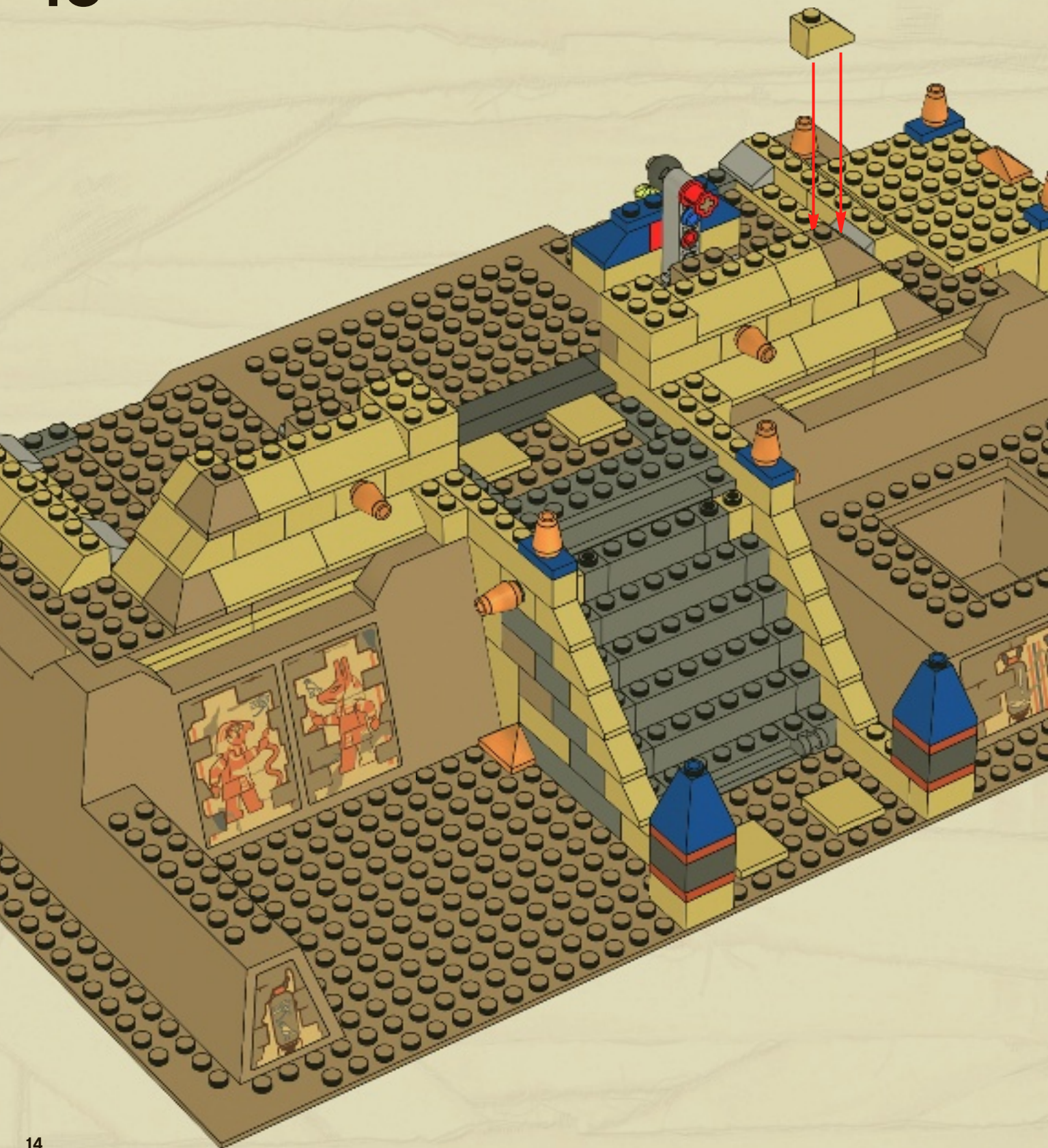

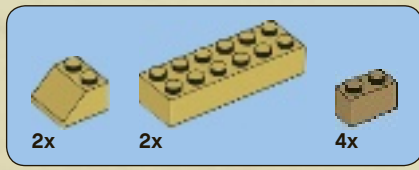

49

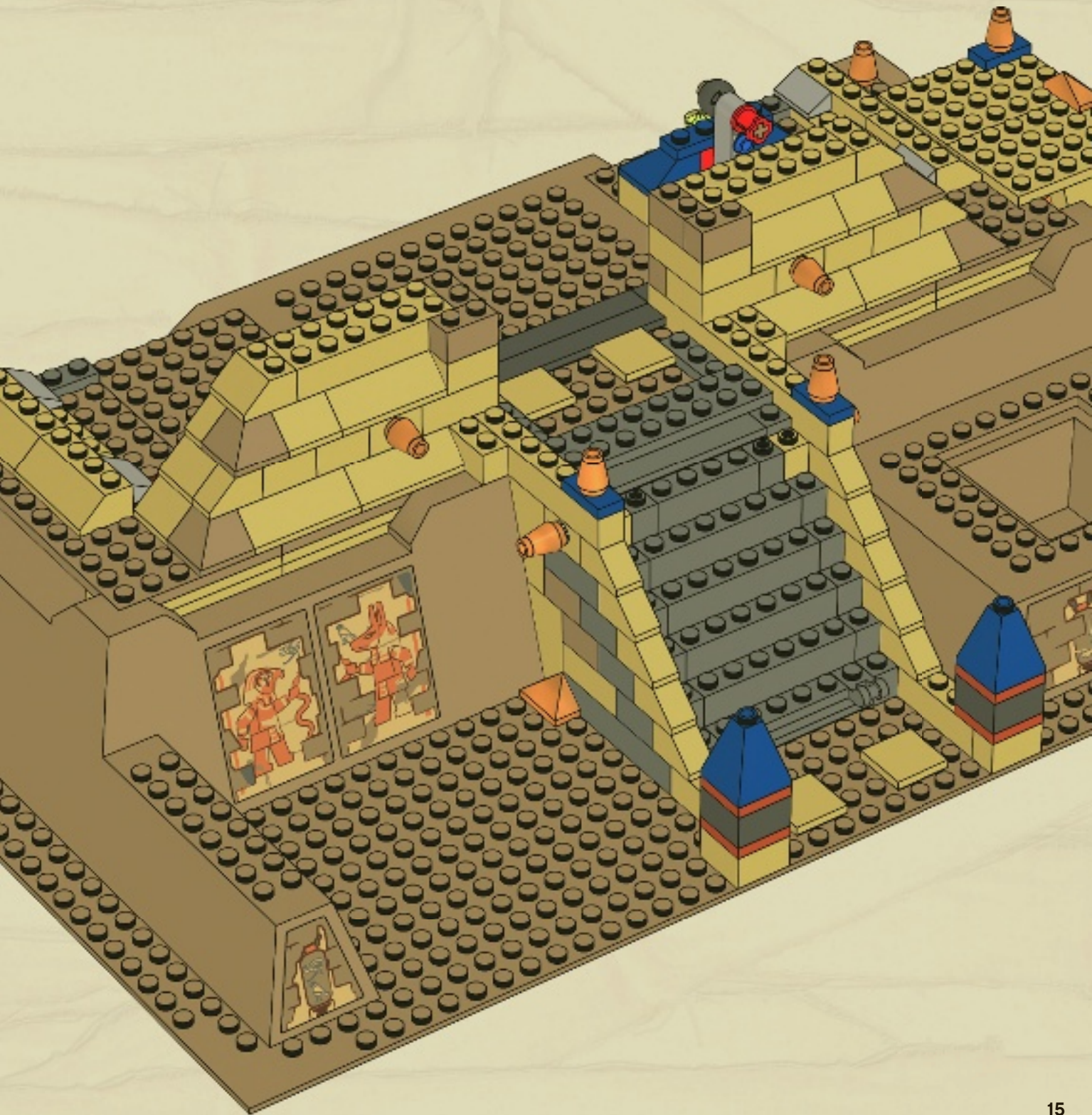

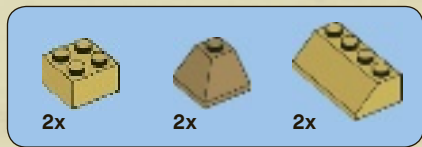

50



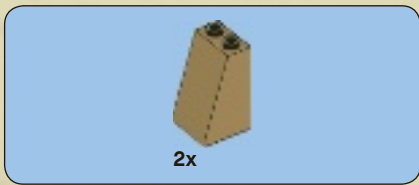

51

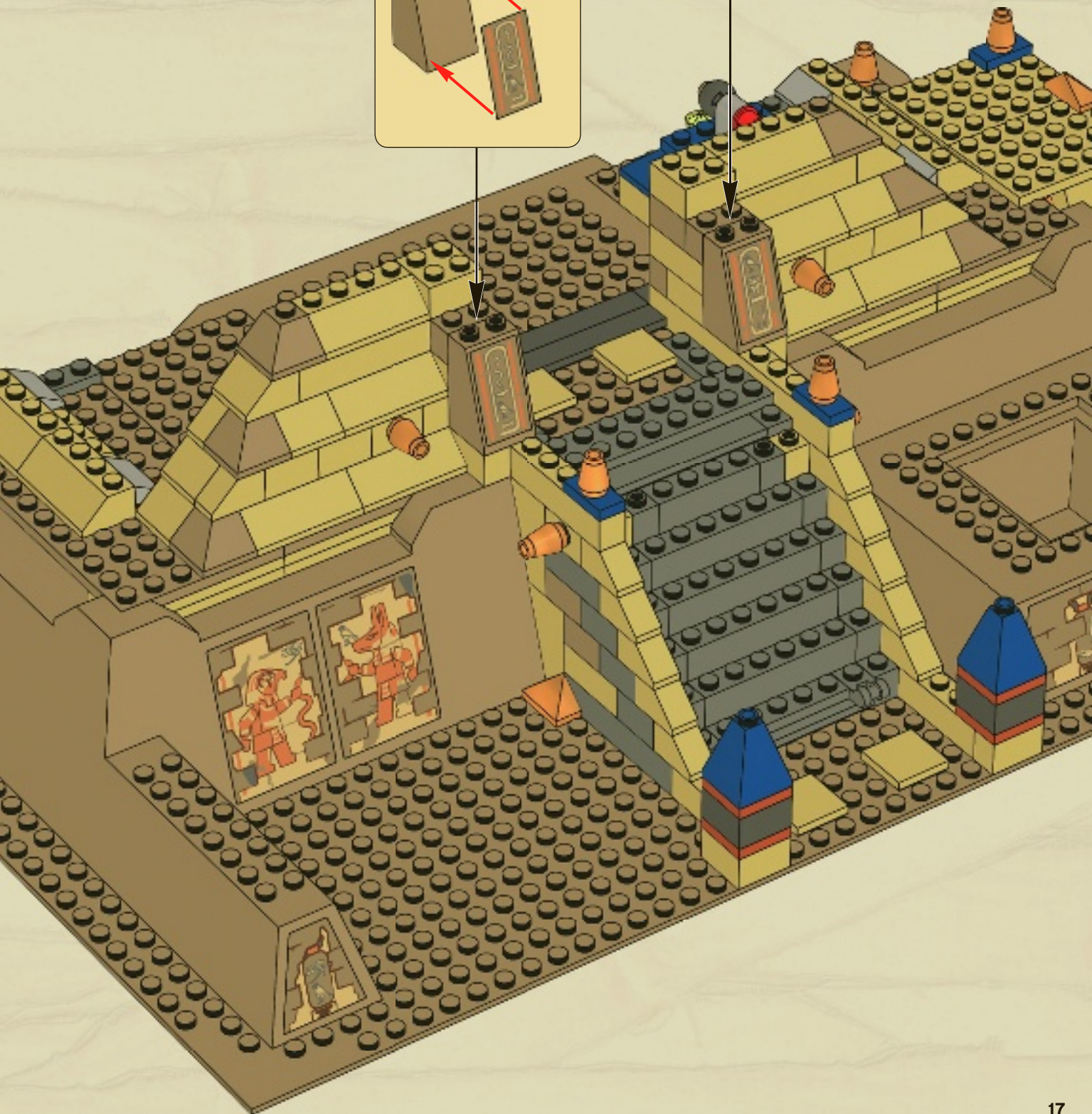
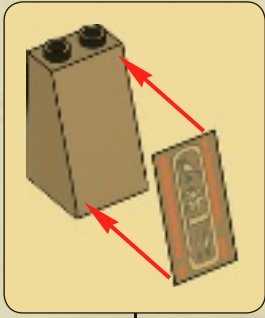

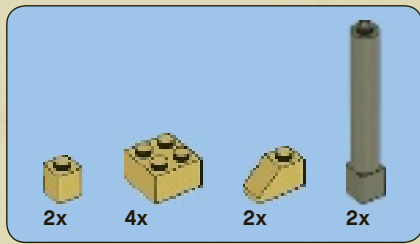

52

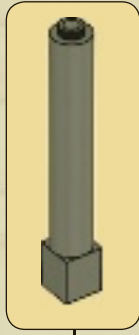

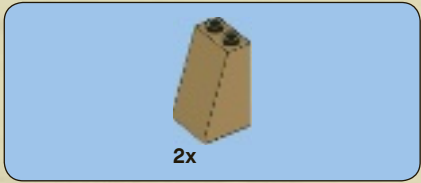

53

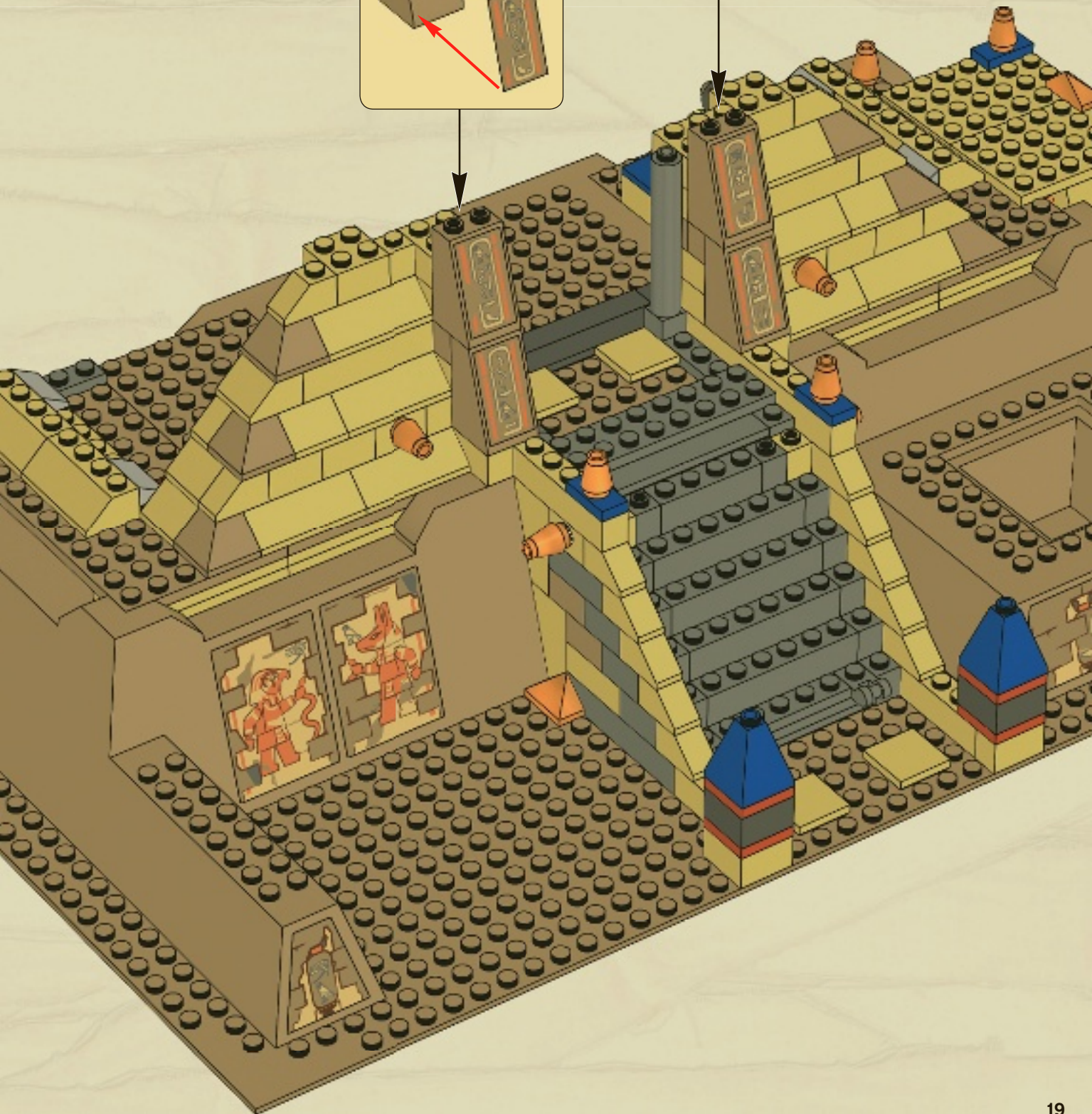
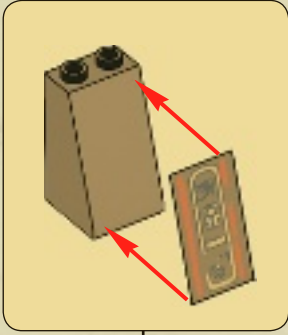
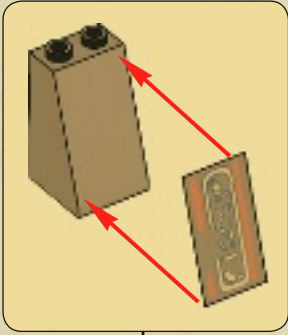

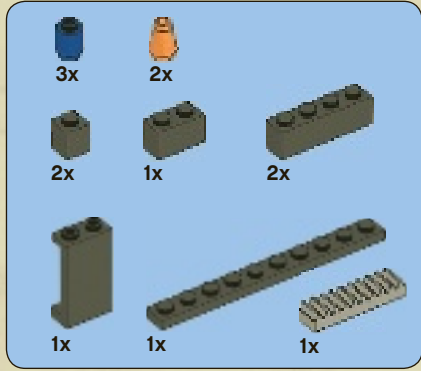
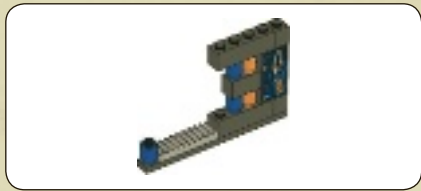

54

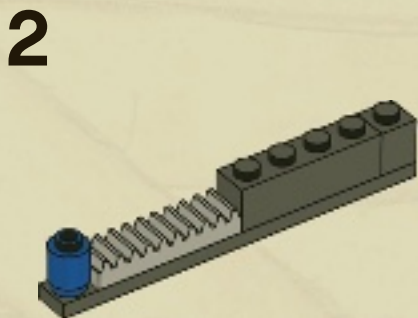
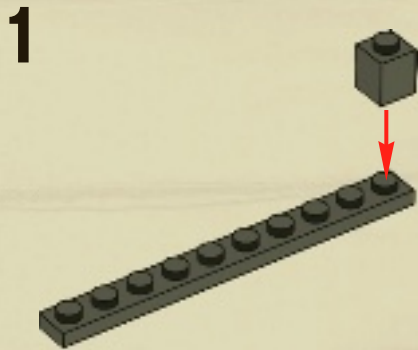

3

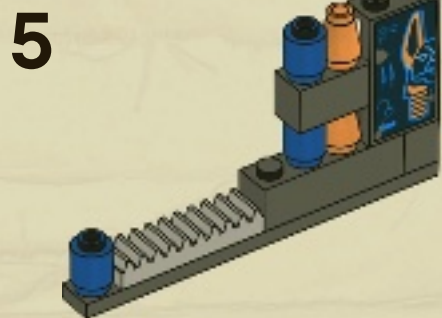
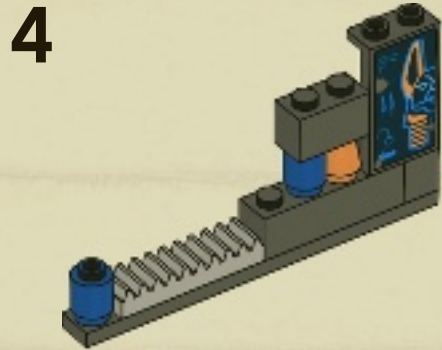
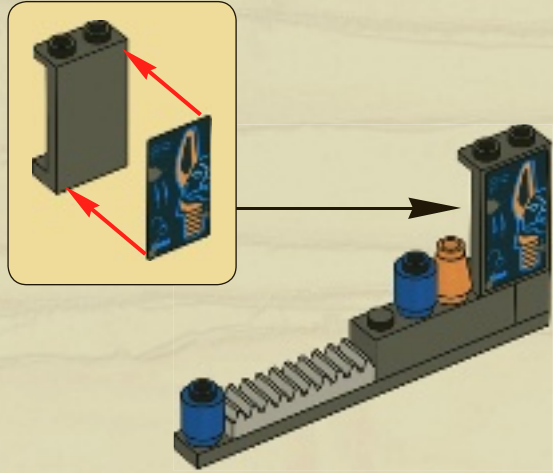

6

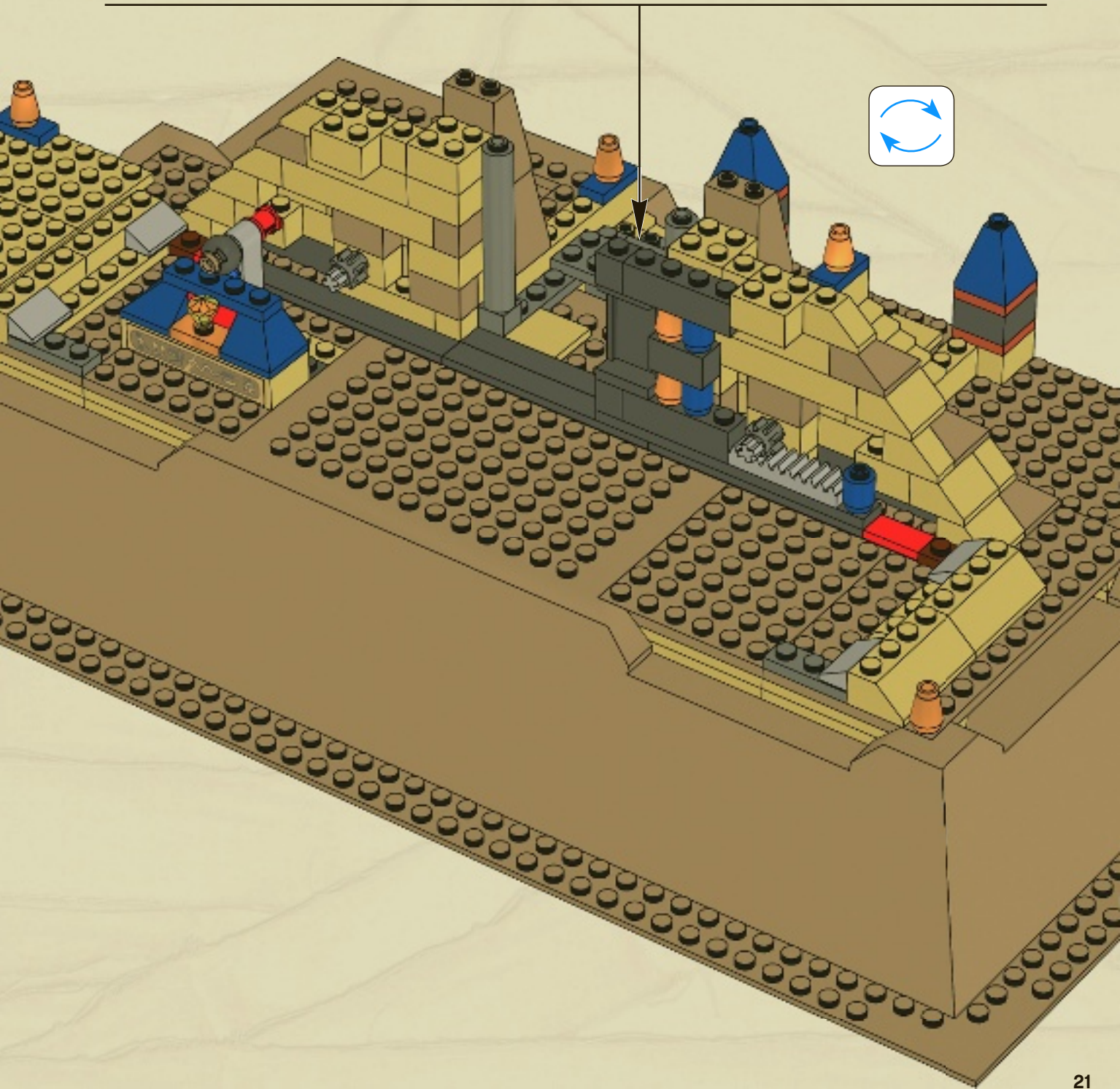
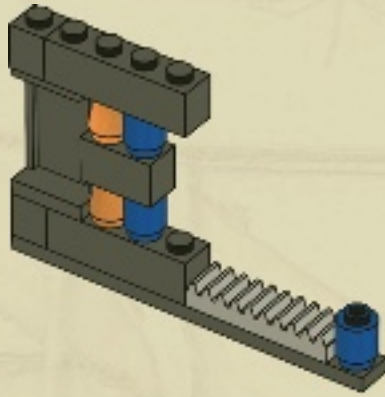



1x

55

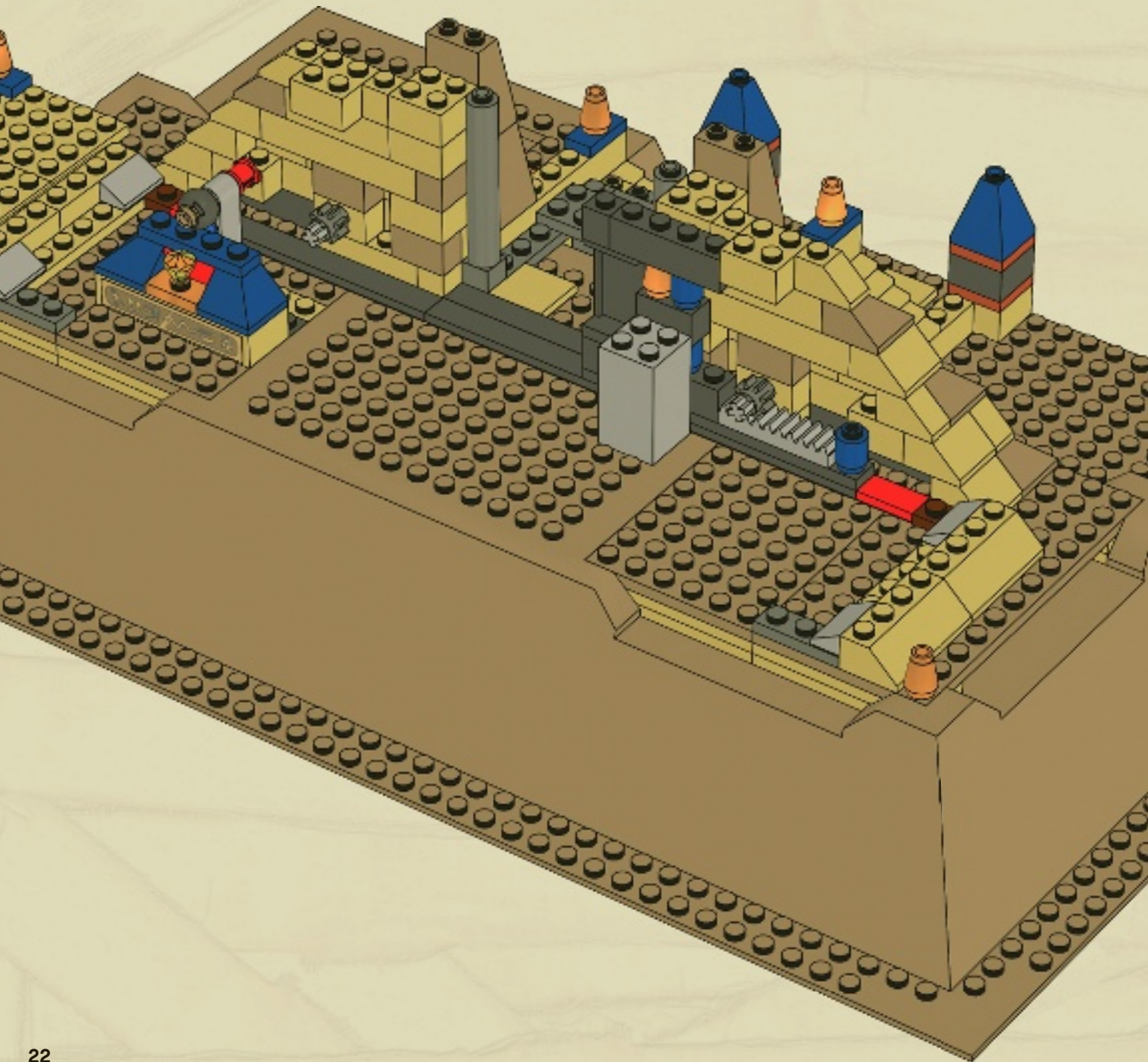

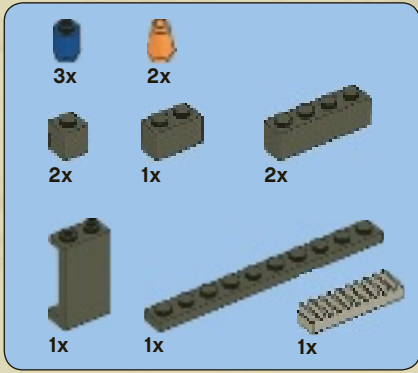
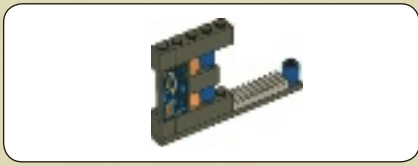

56

1



2

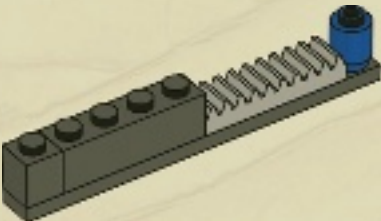

3

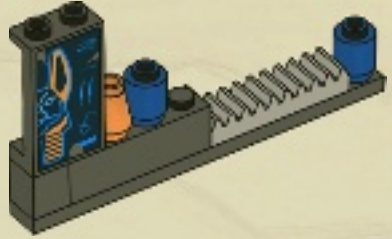

4

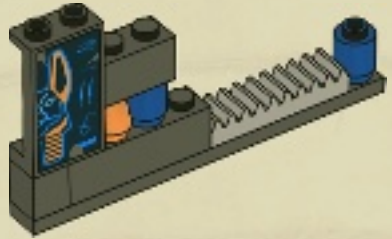

5

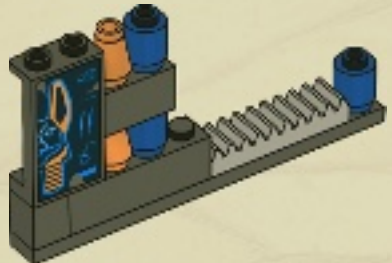

6

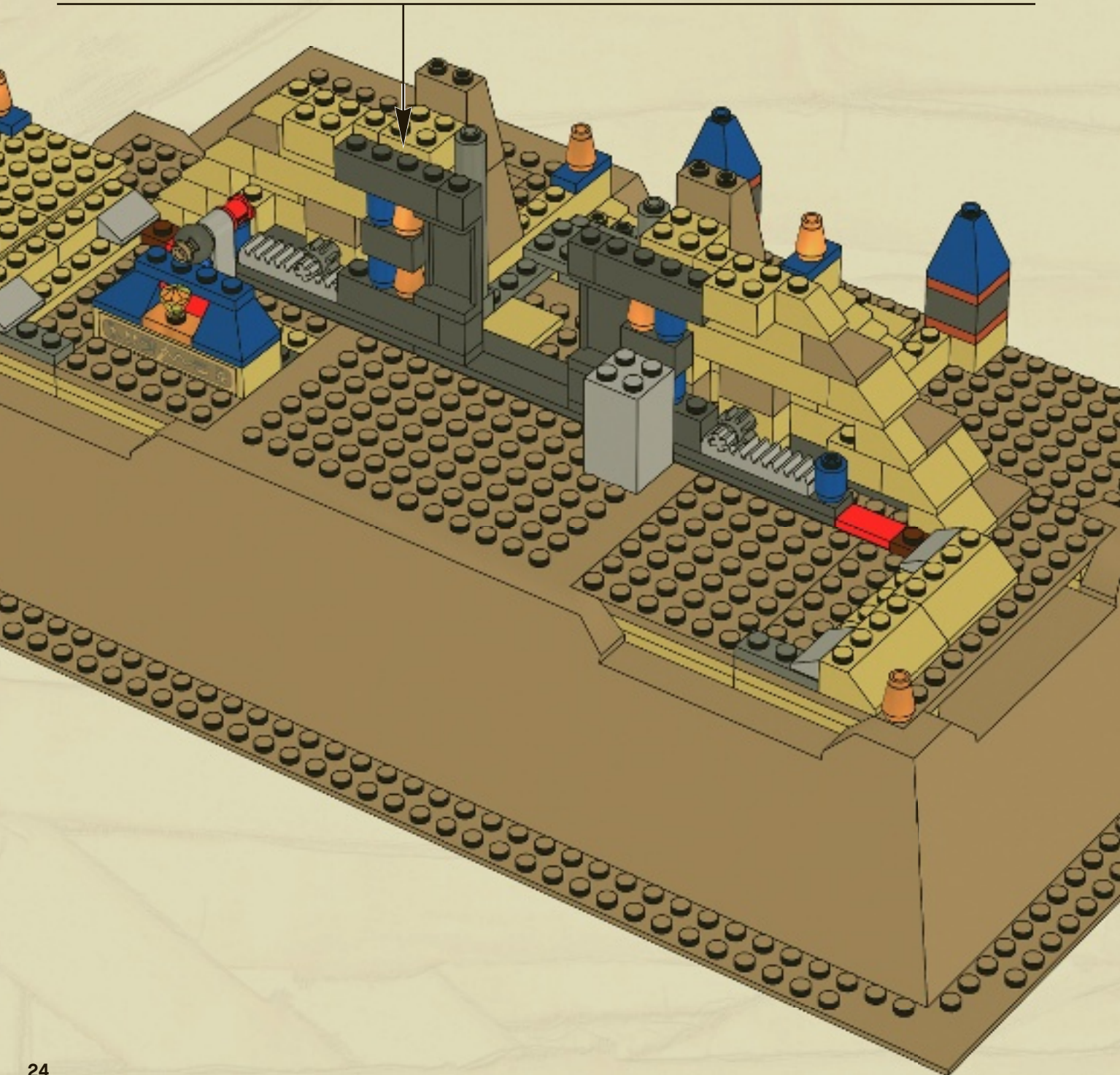
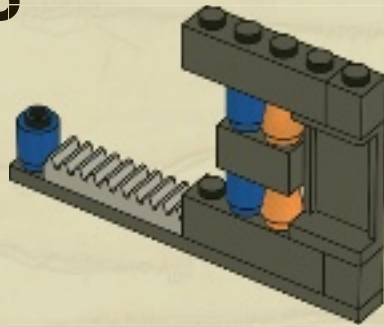

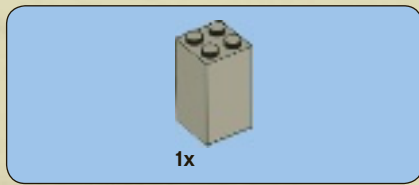

57

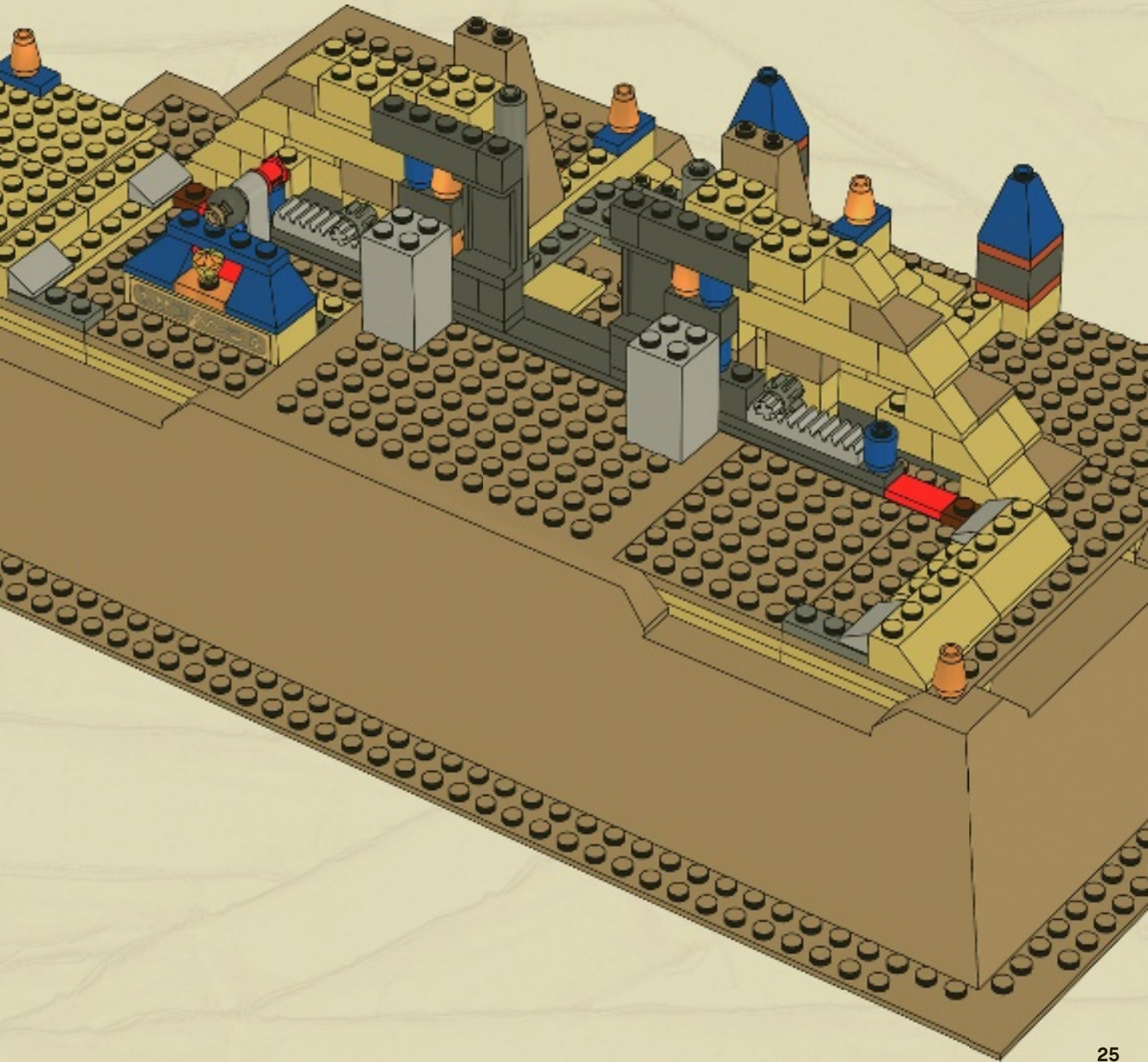



58

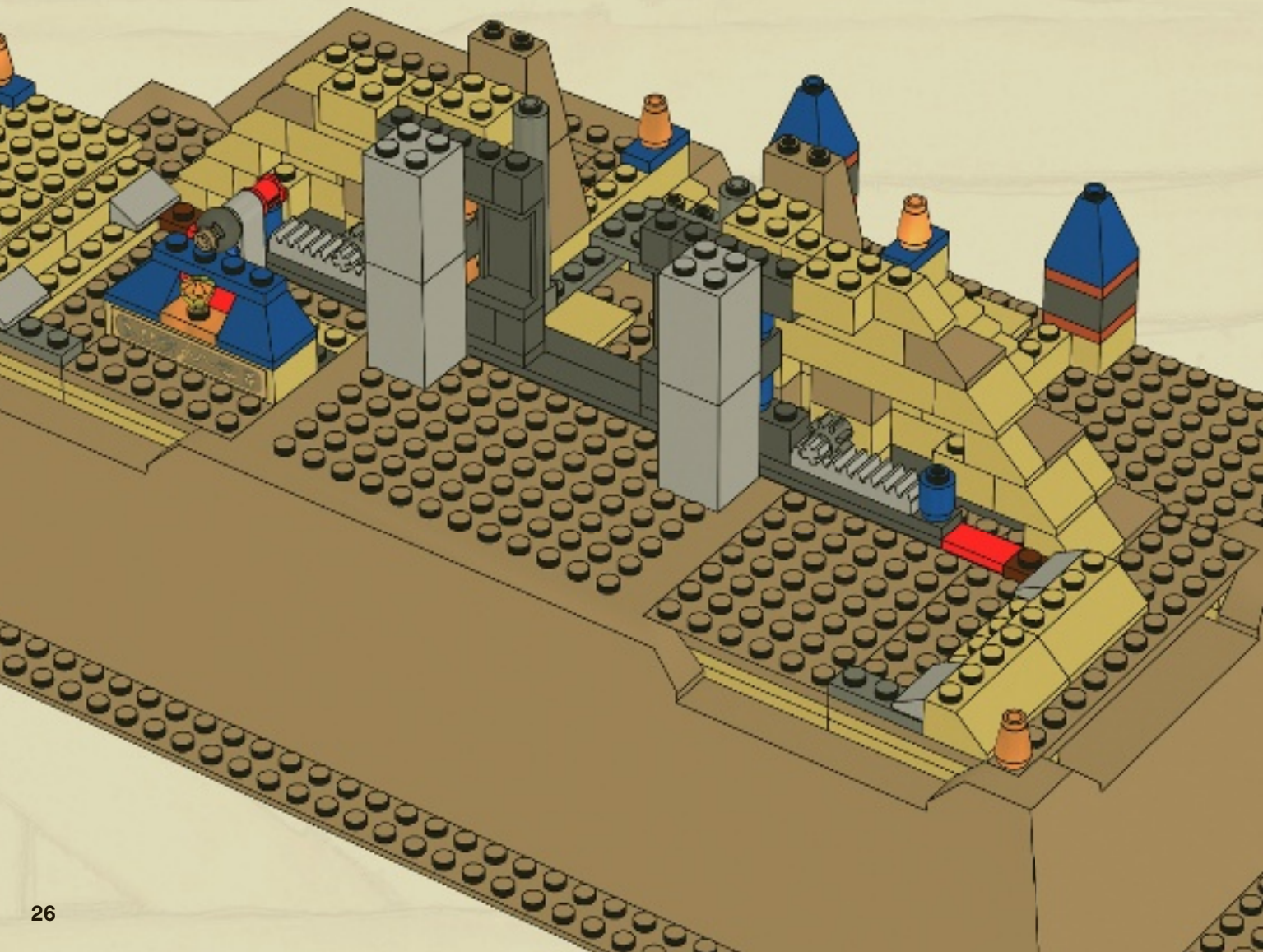
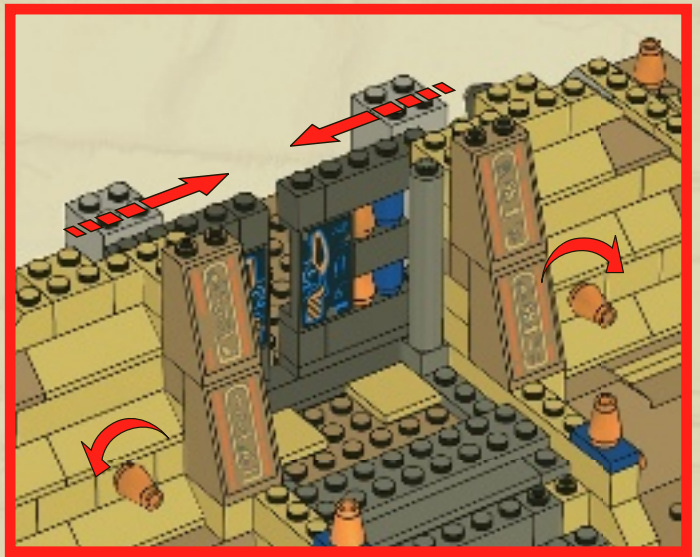

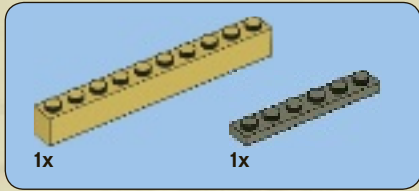

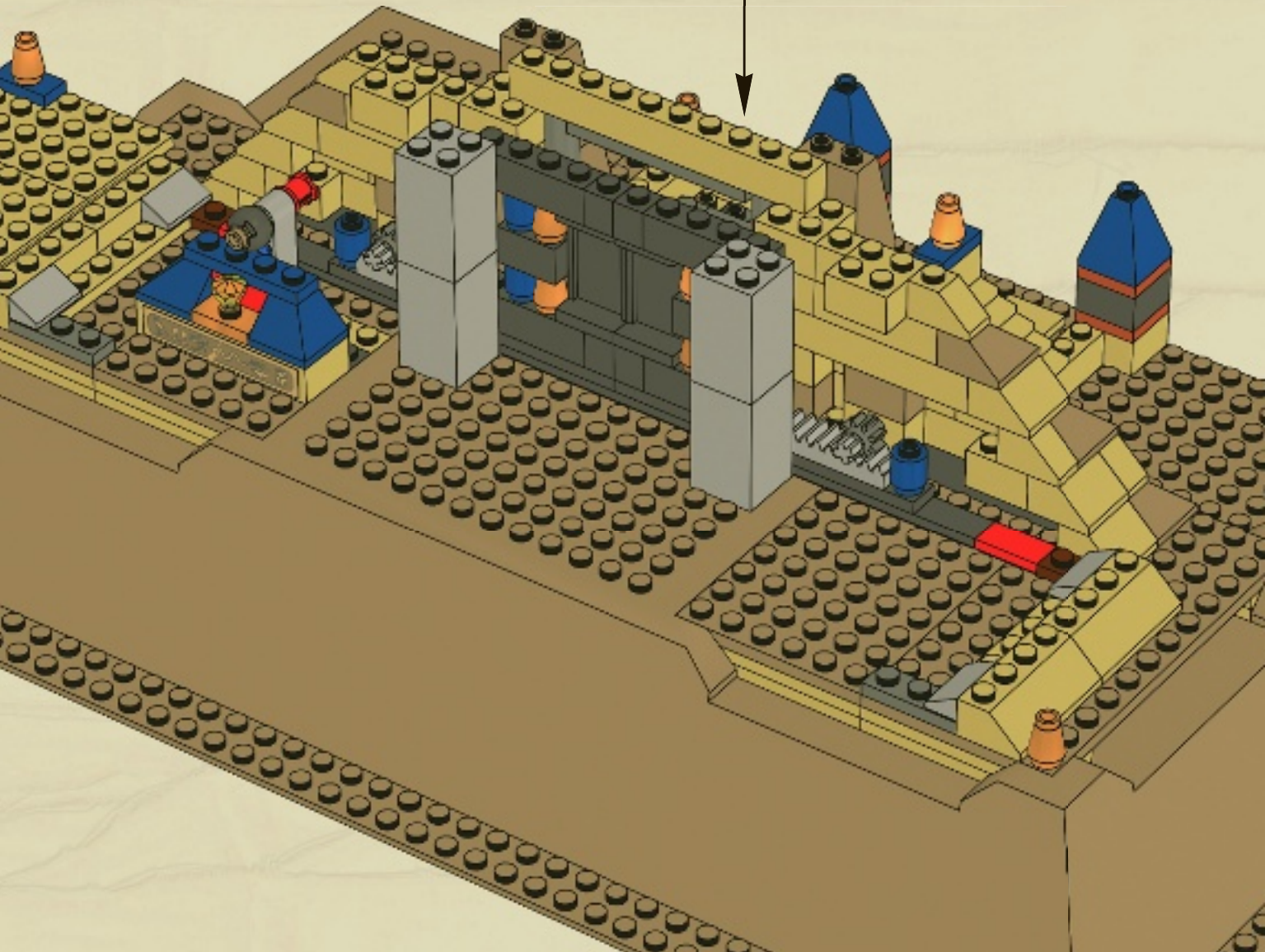
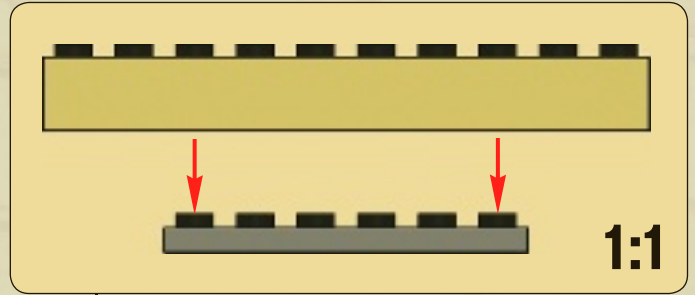

59

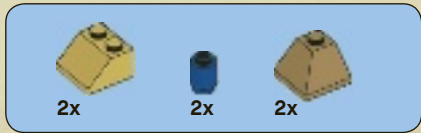

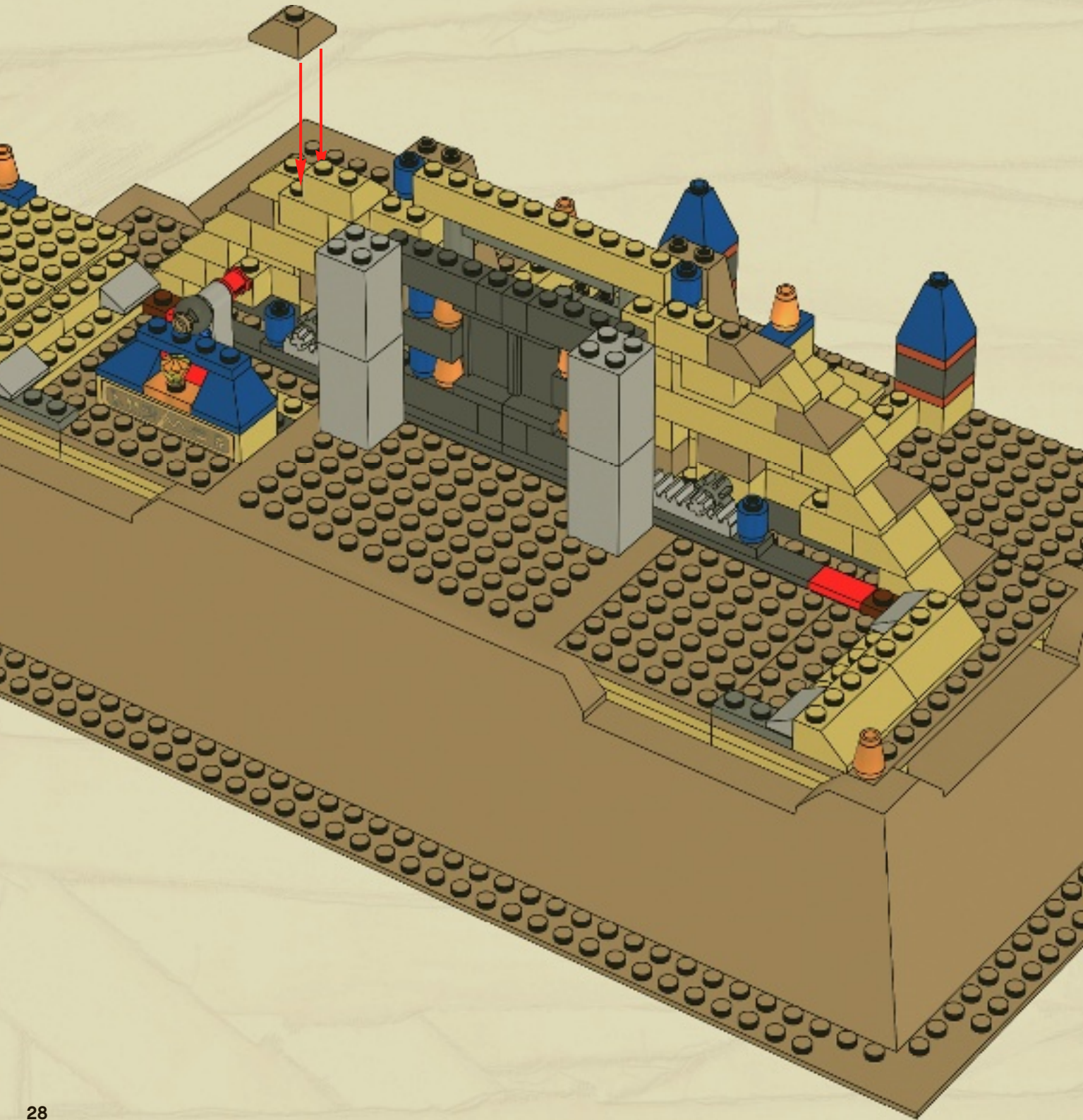

60



1x  2x 

61

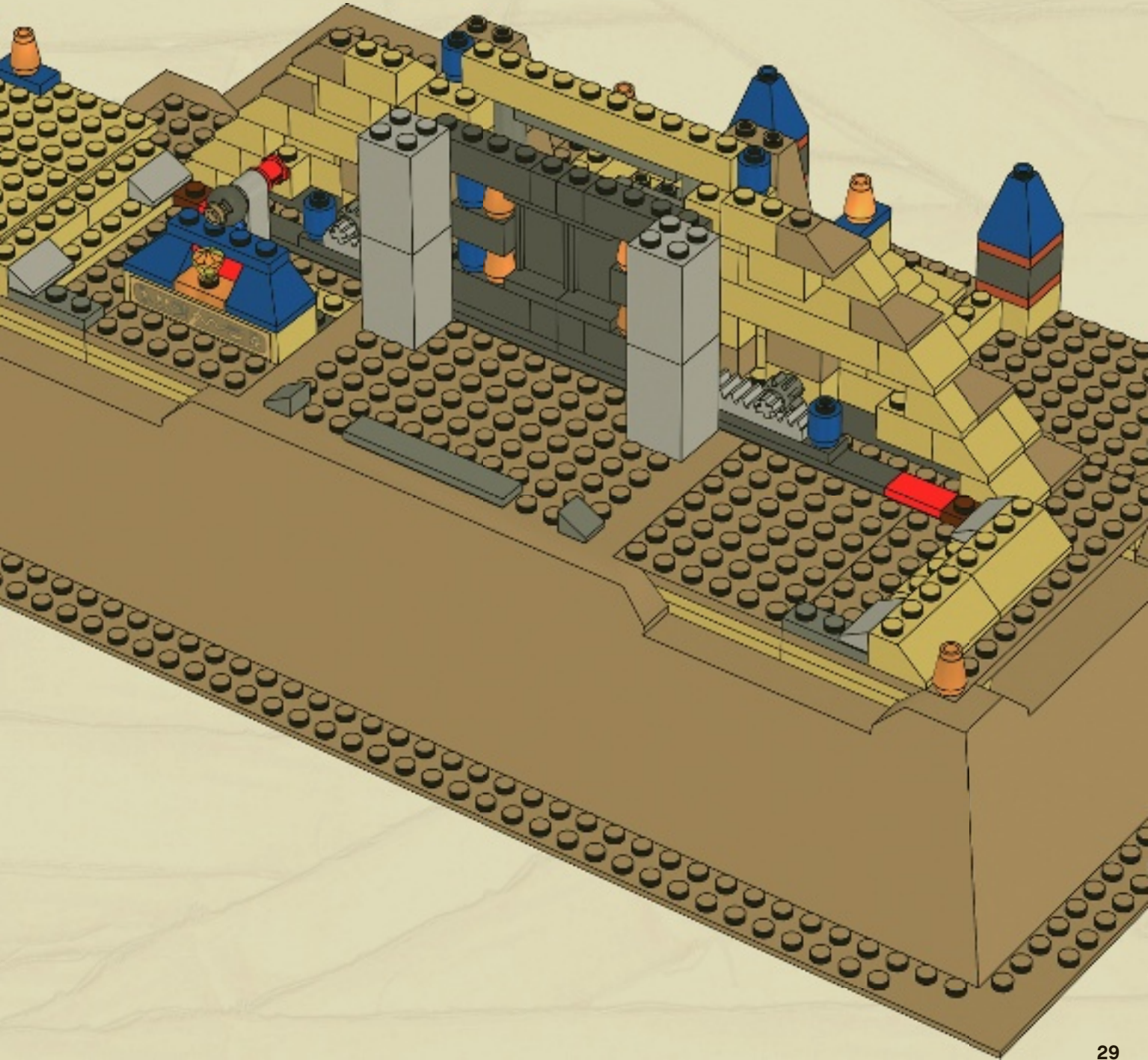

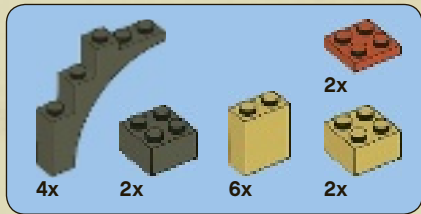

62

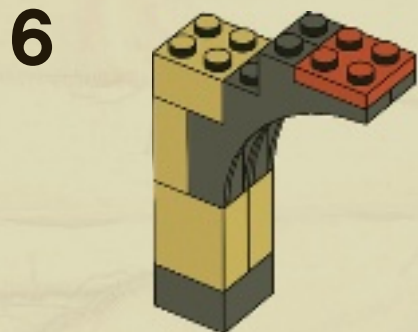

2x

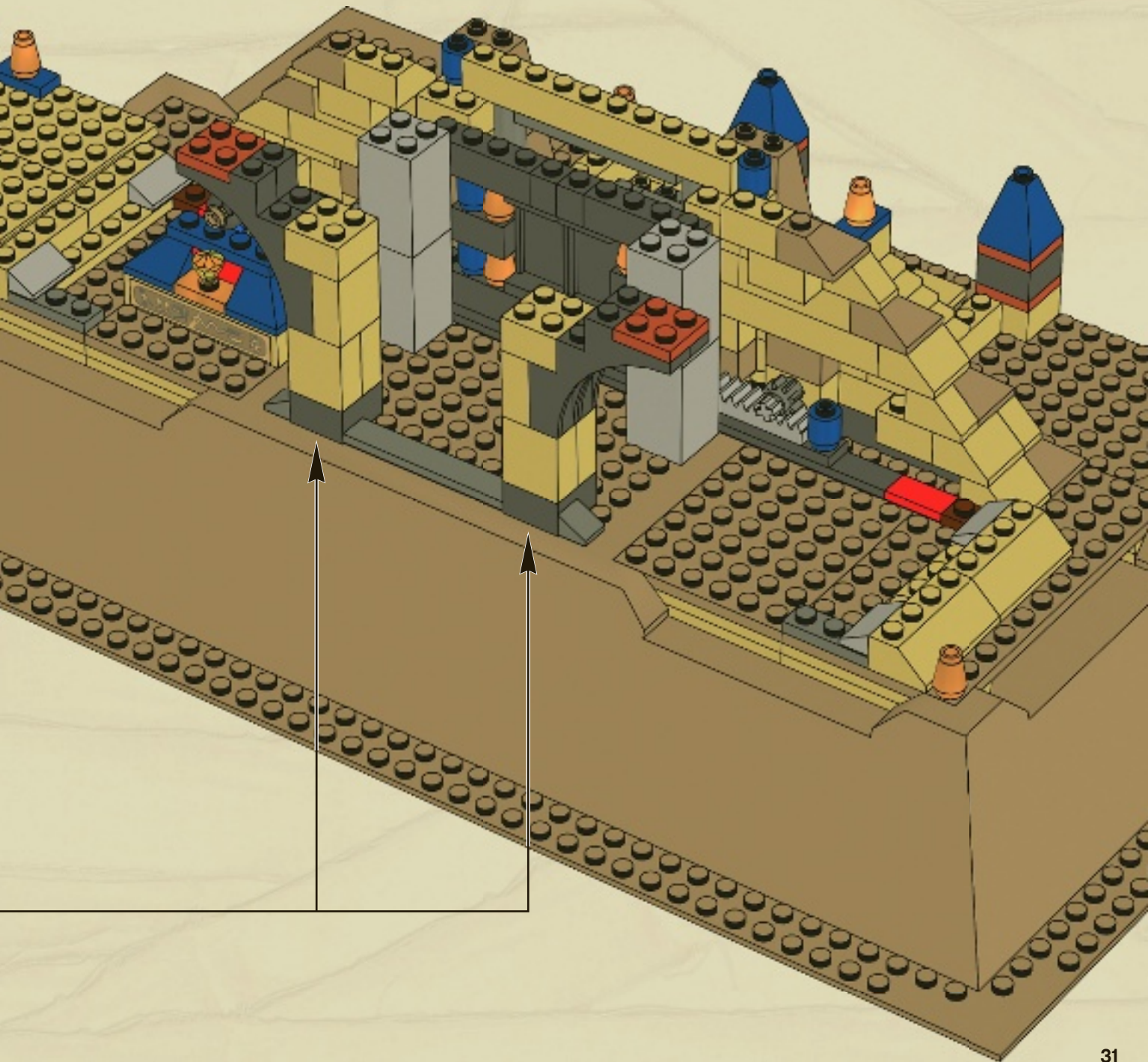



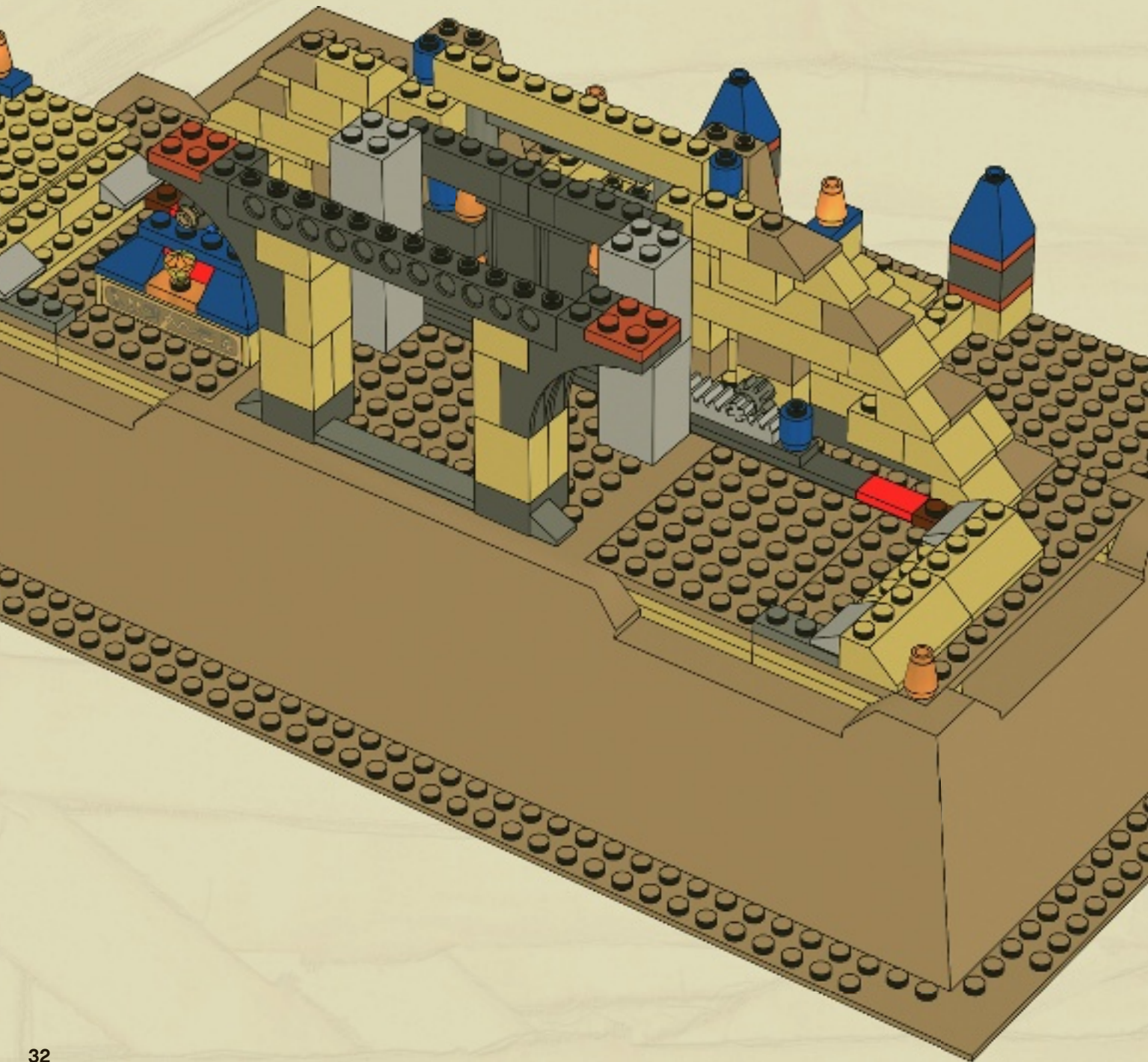

63

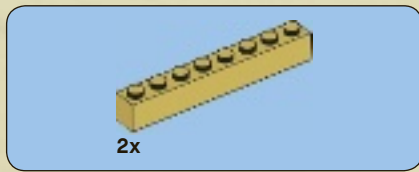

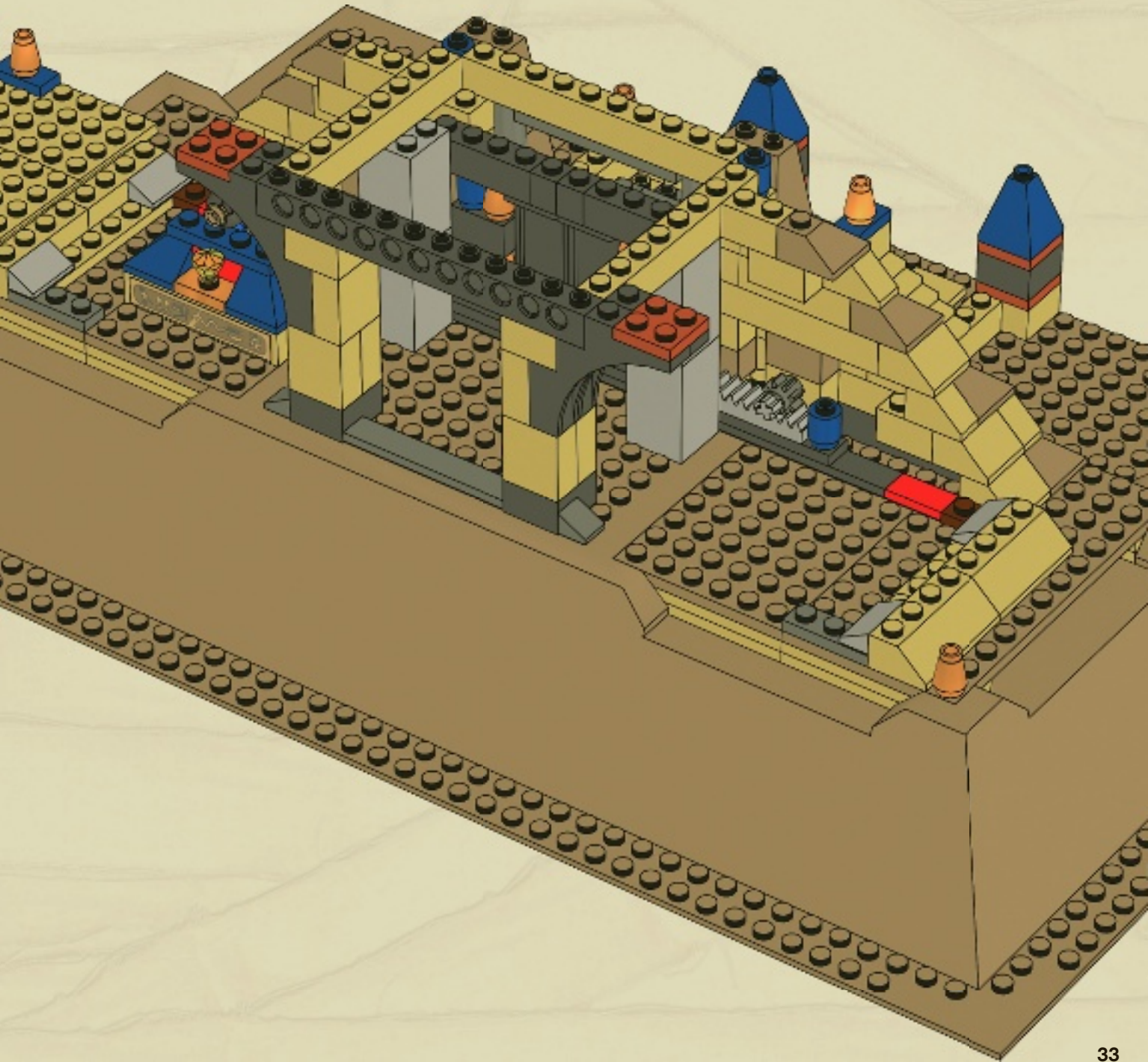

64



4x  2x 

65

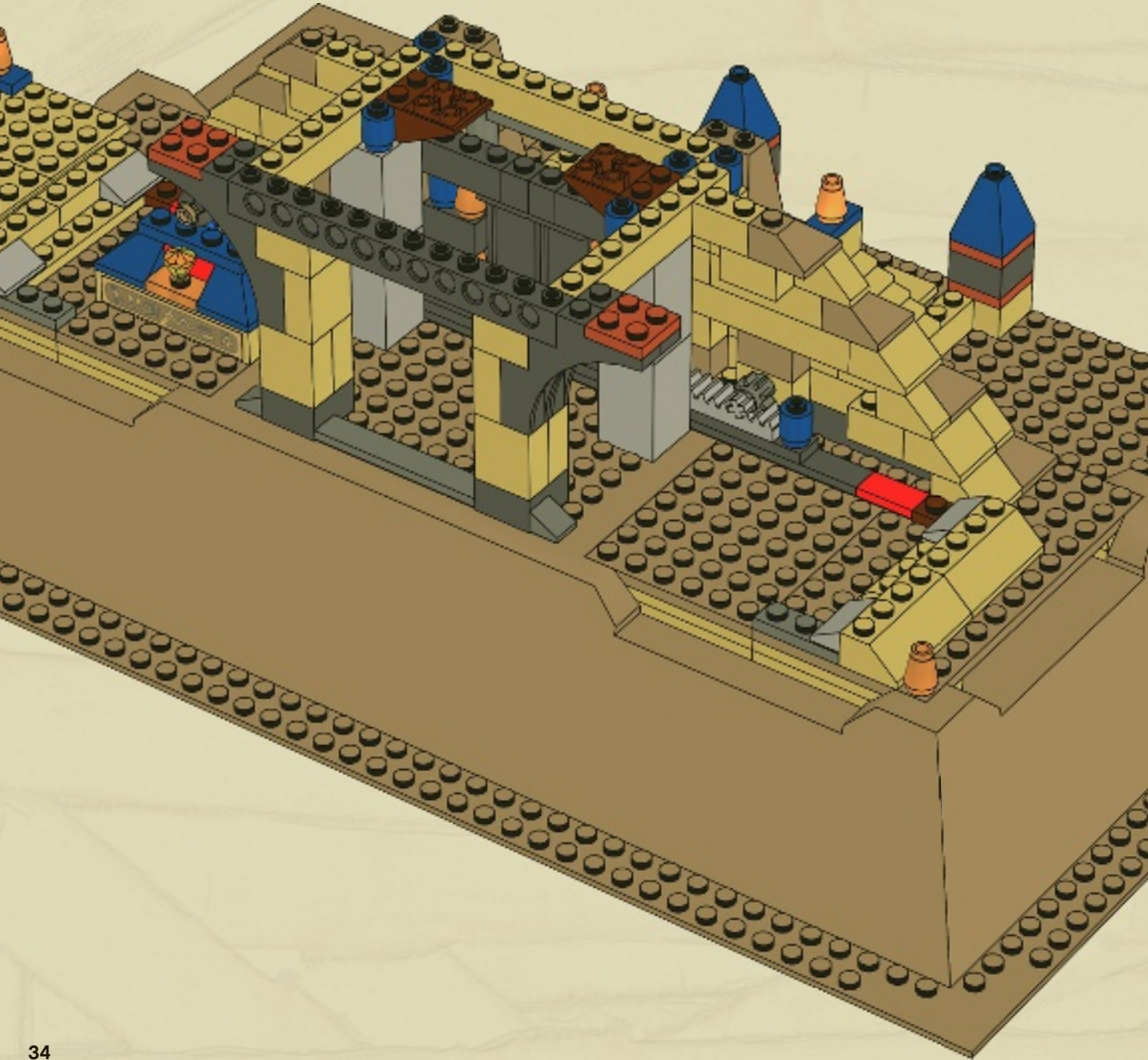

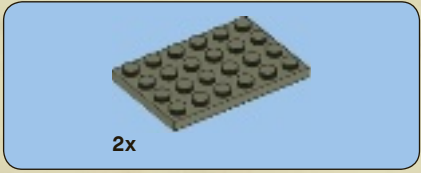

66

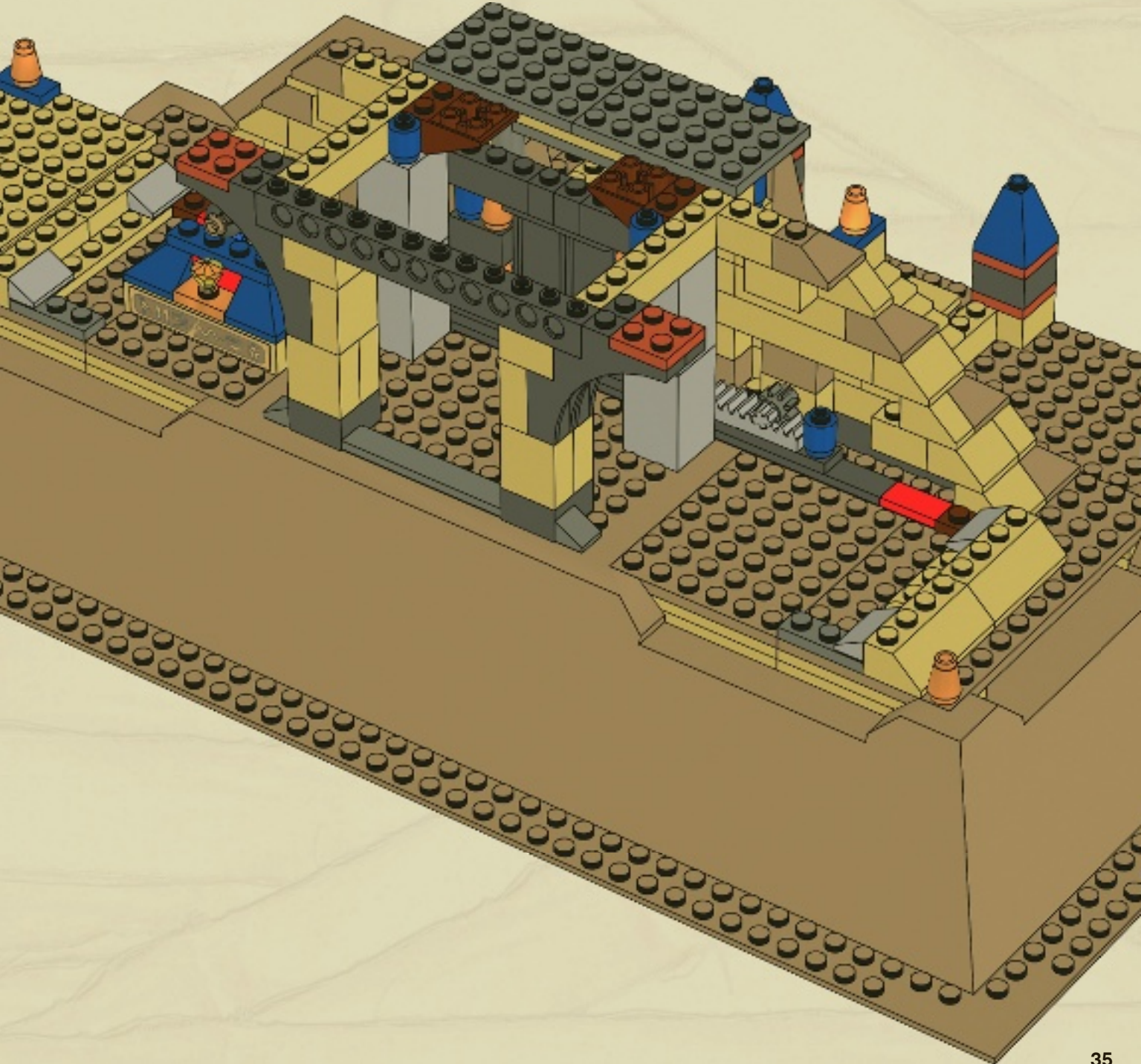

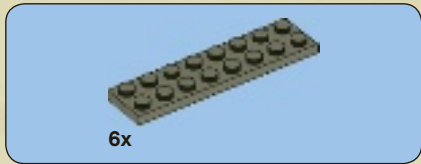

67

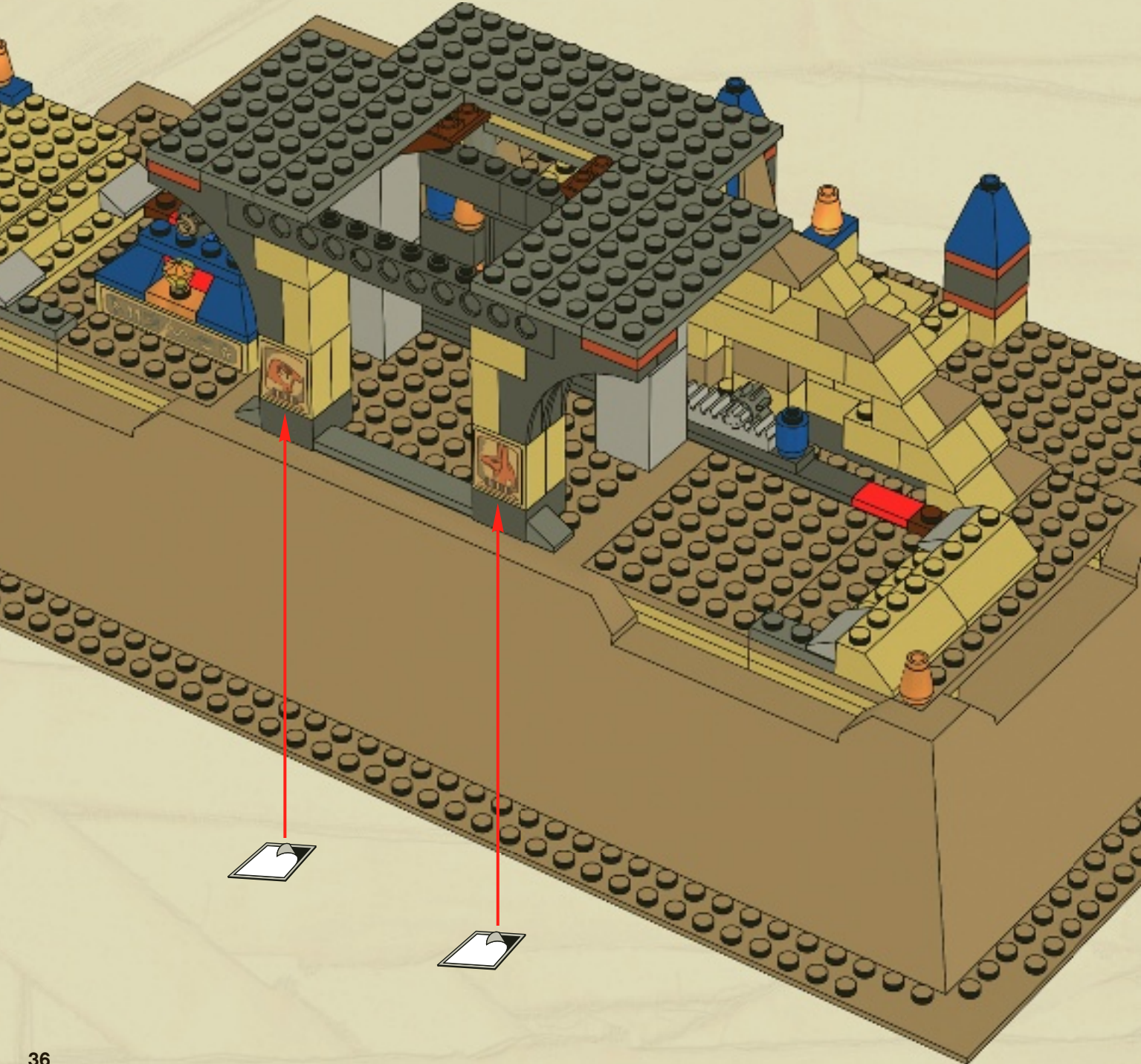

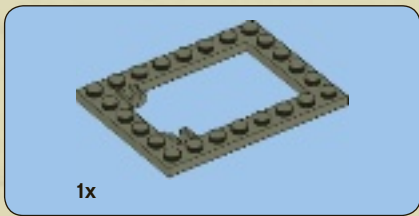

68

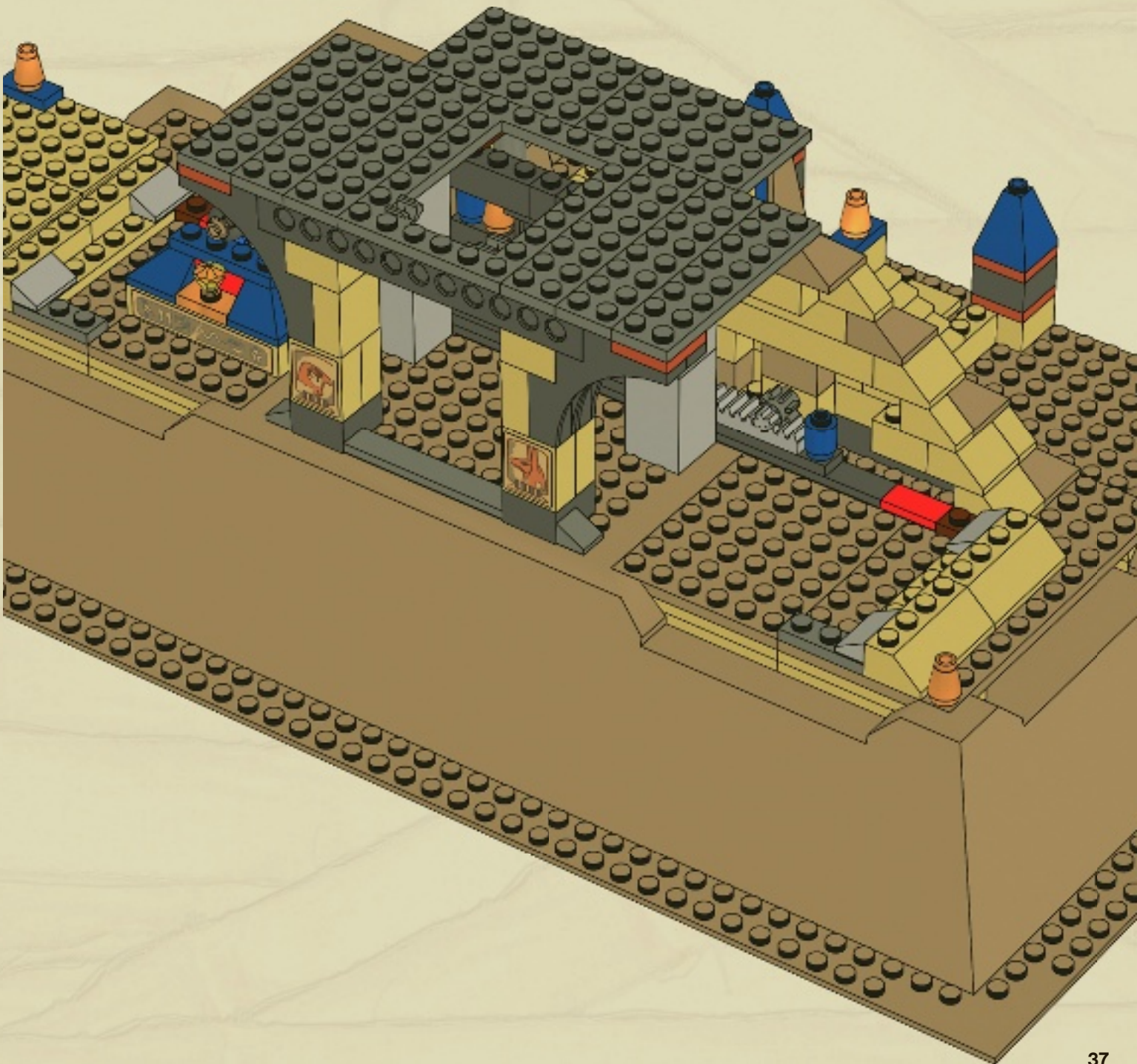



69

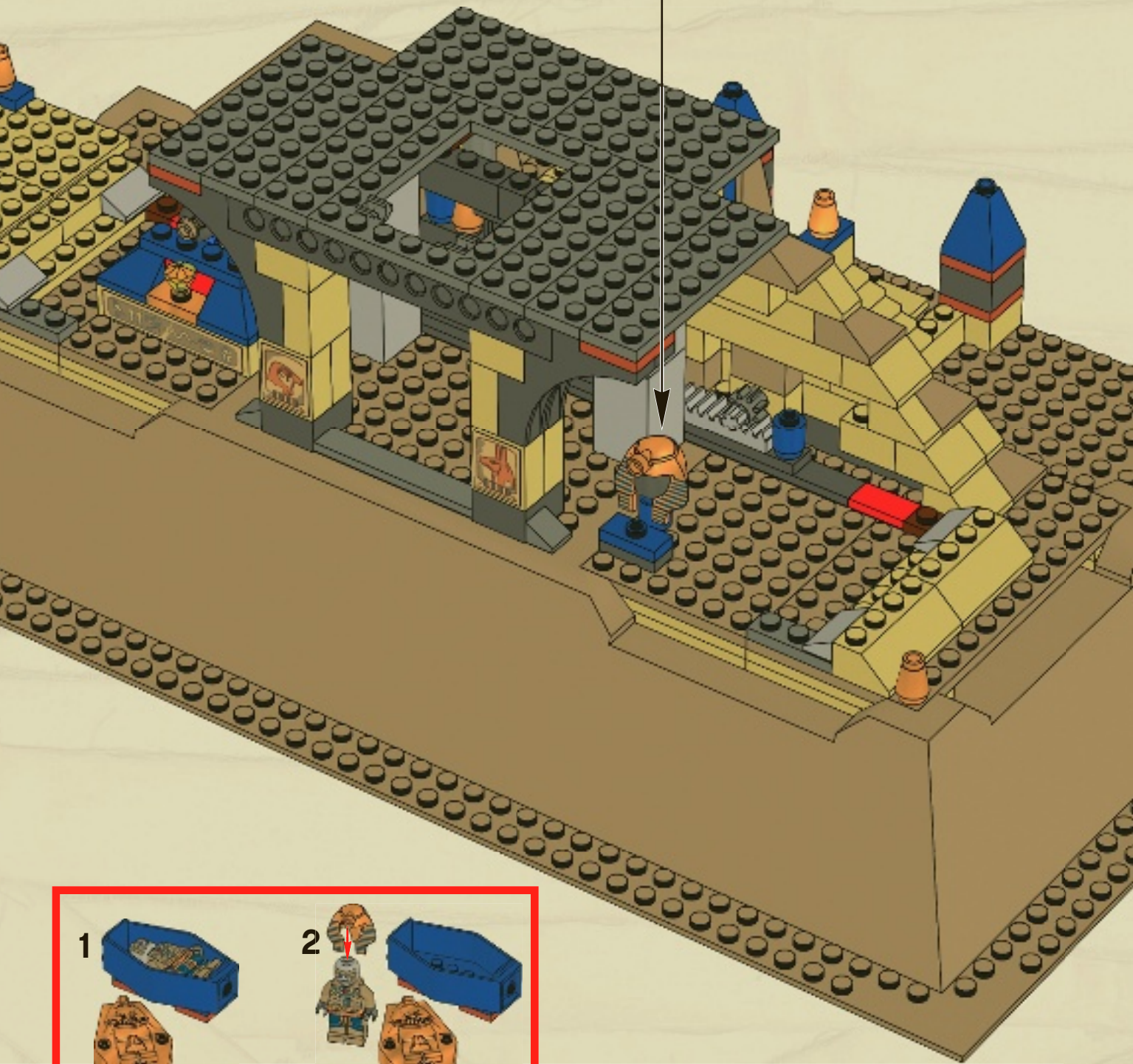
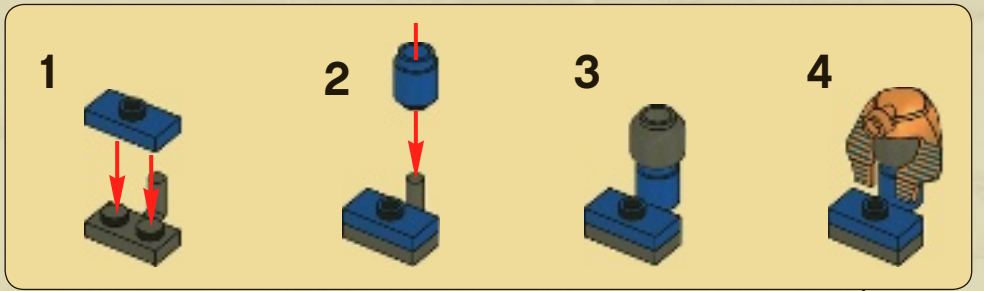

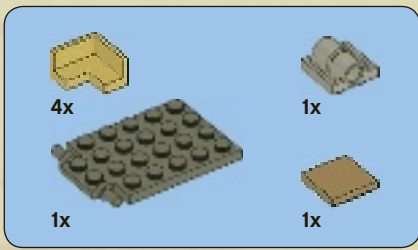

70

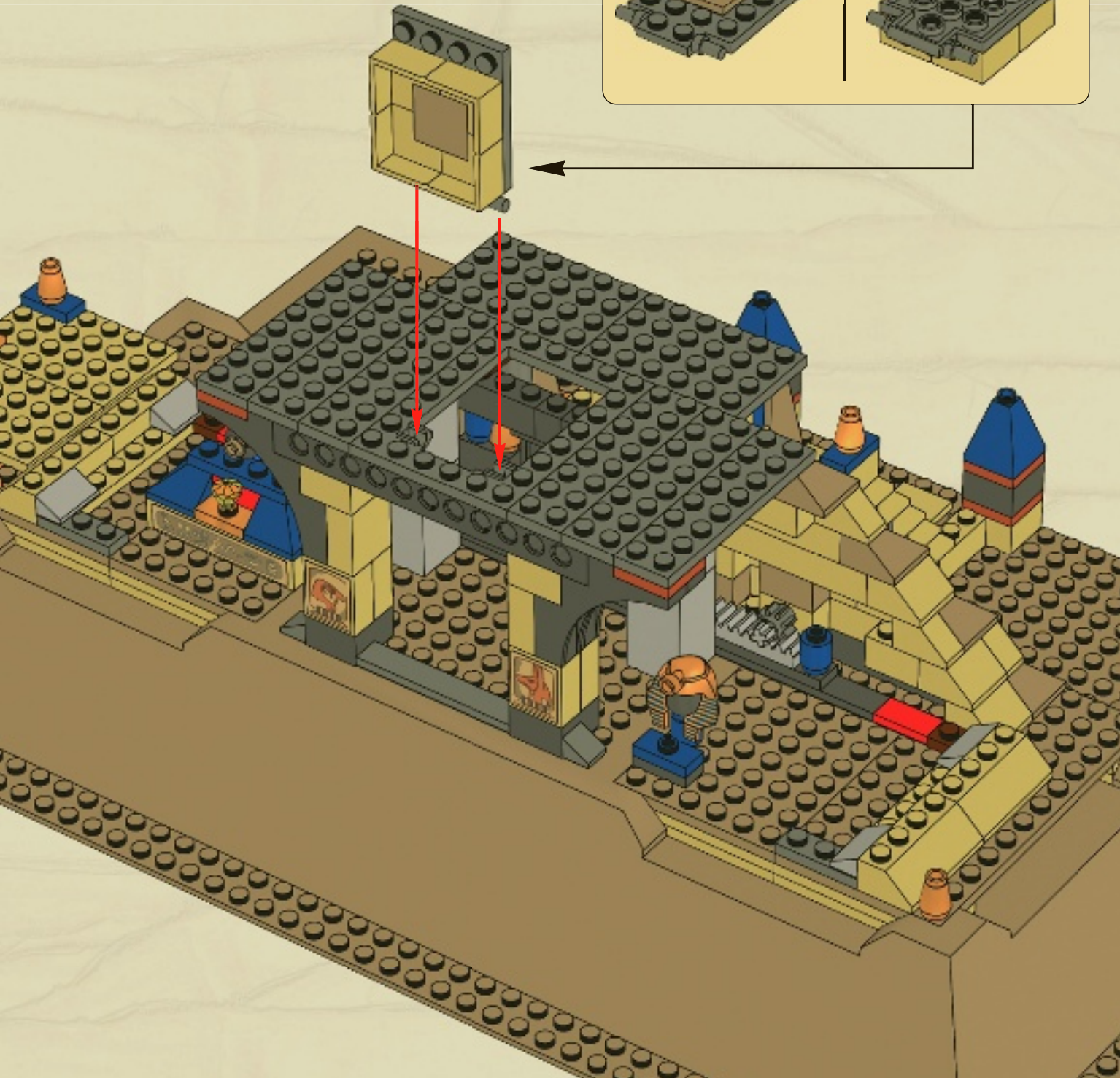
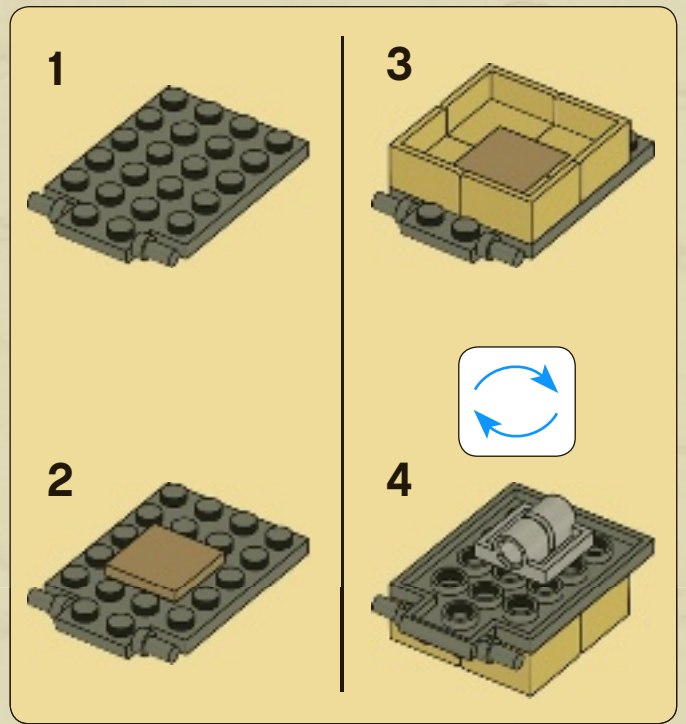

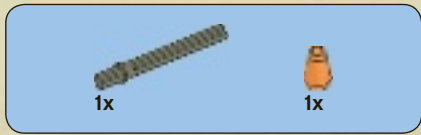

71

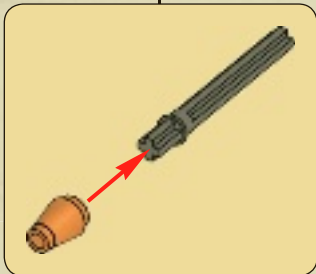
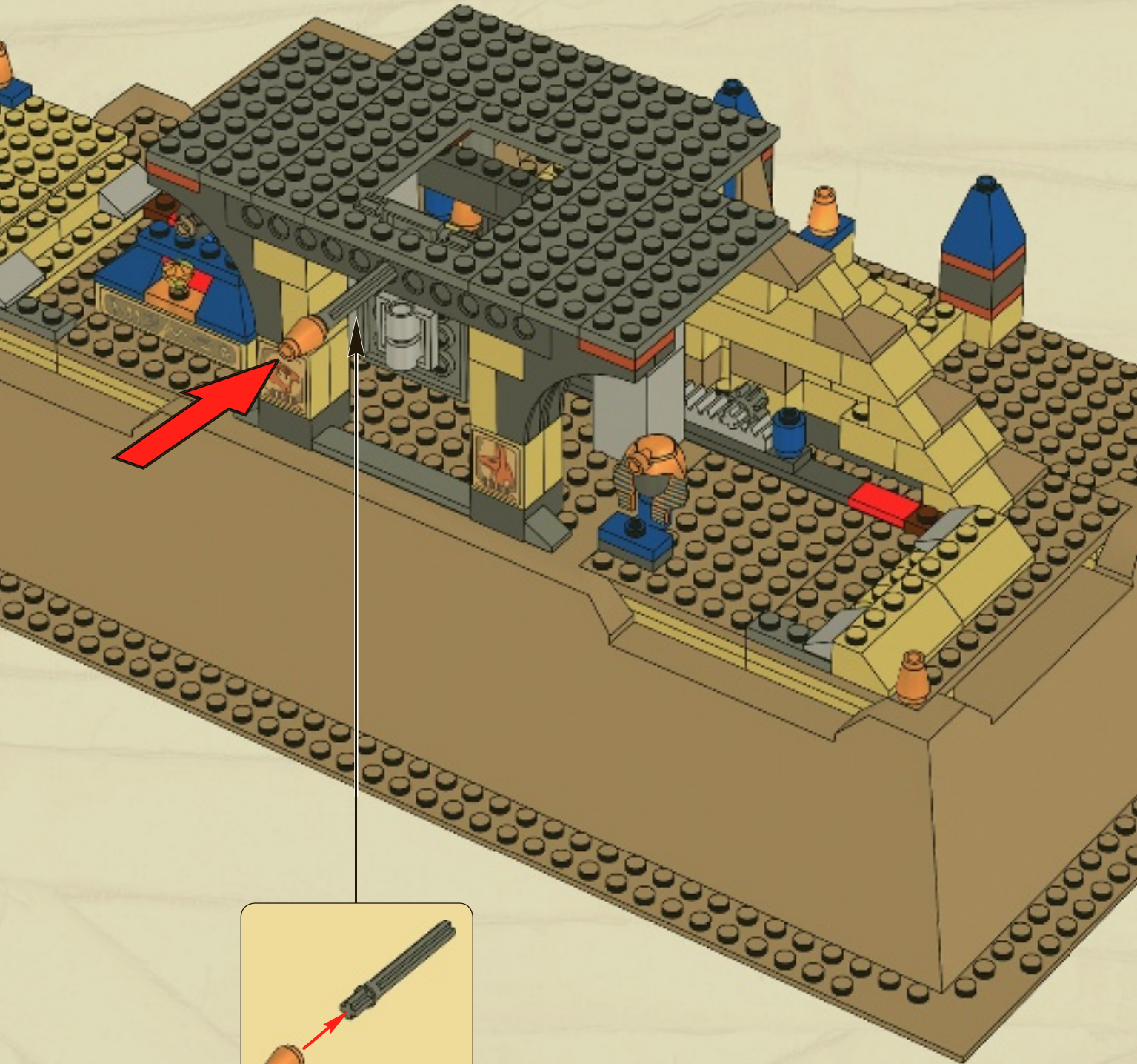

3x

72

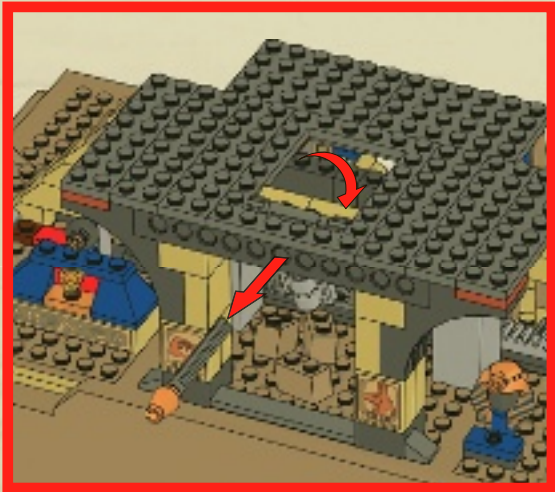
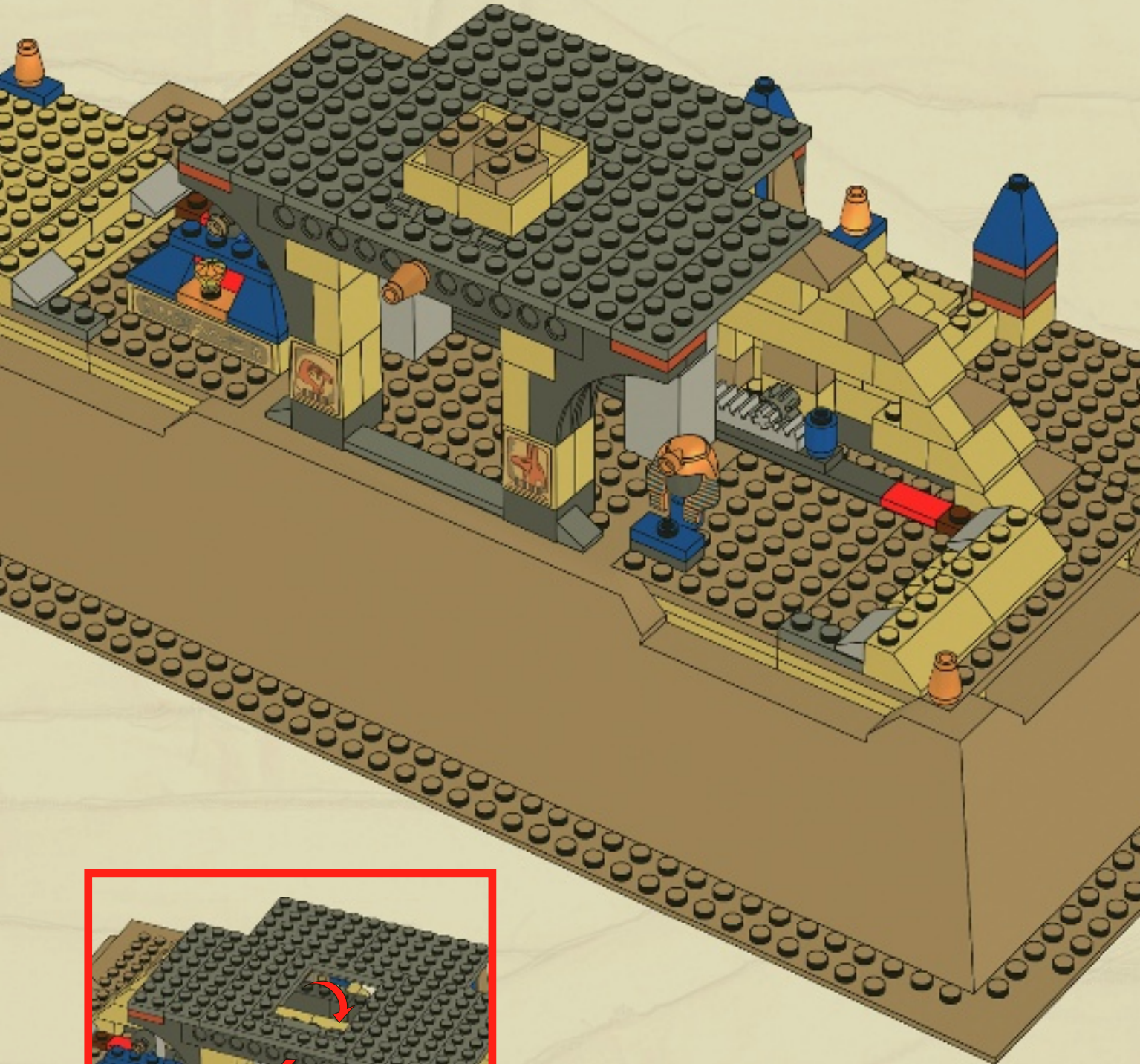

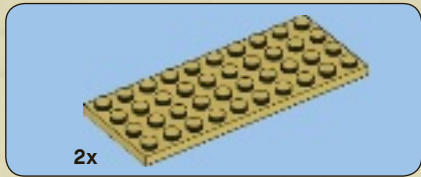

1

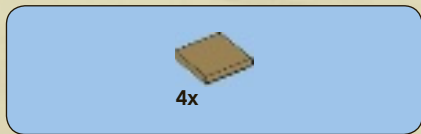
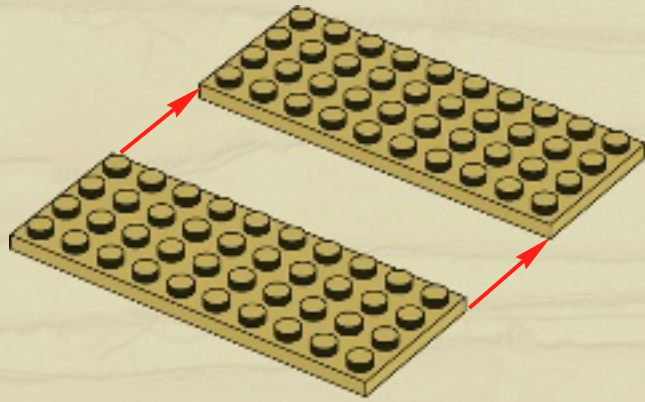

2

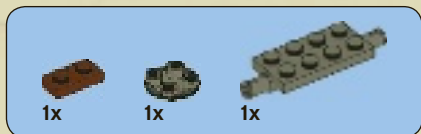
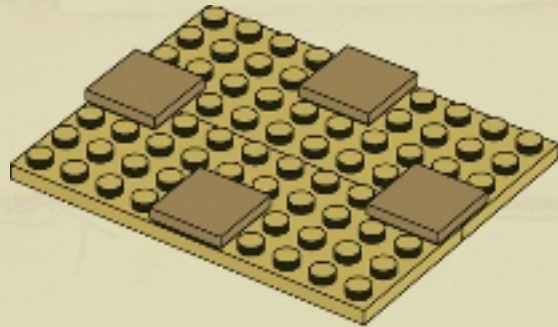

3

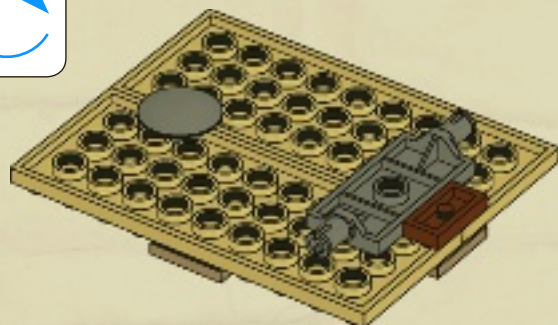
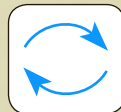



4

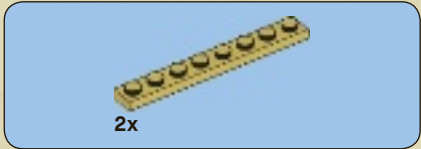
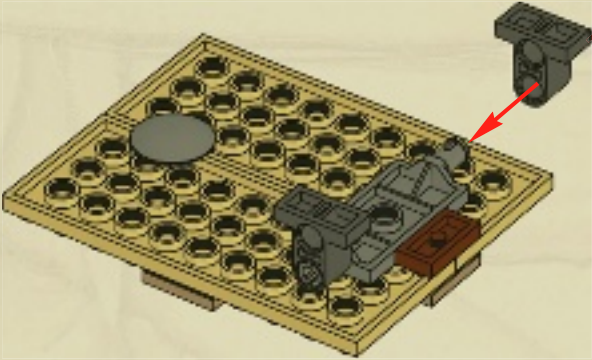

5

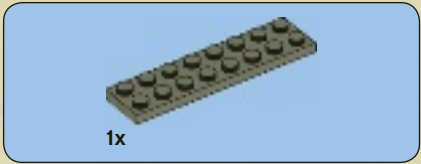
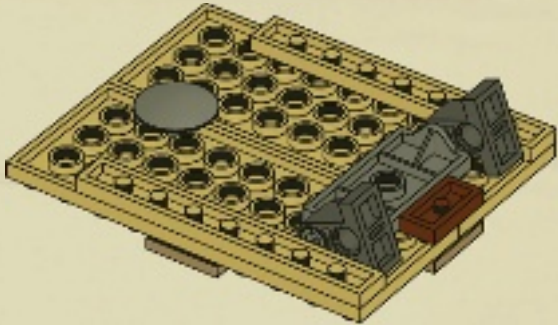

6

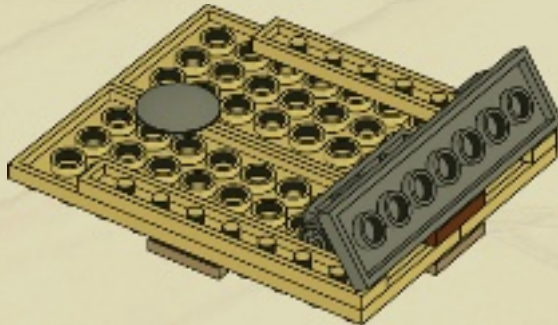

7

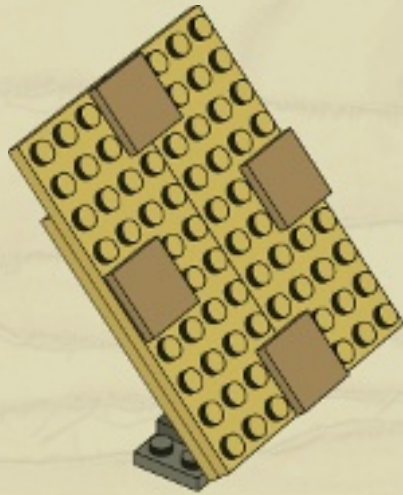
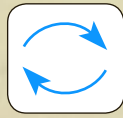

2x

73

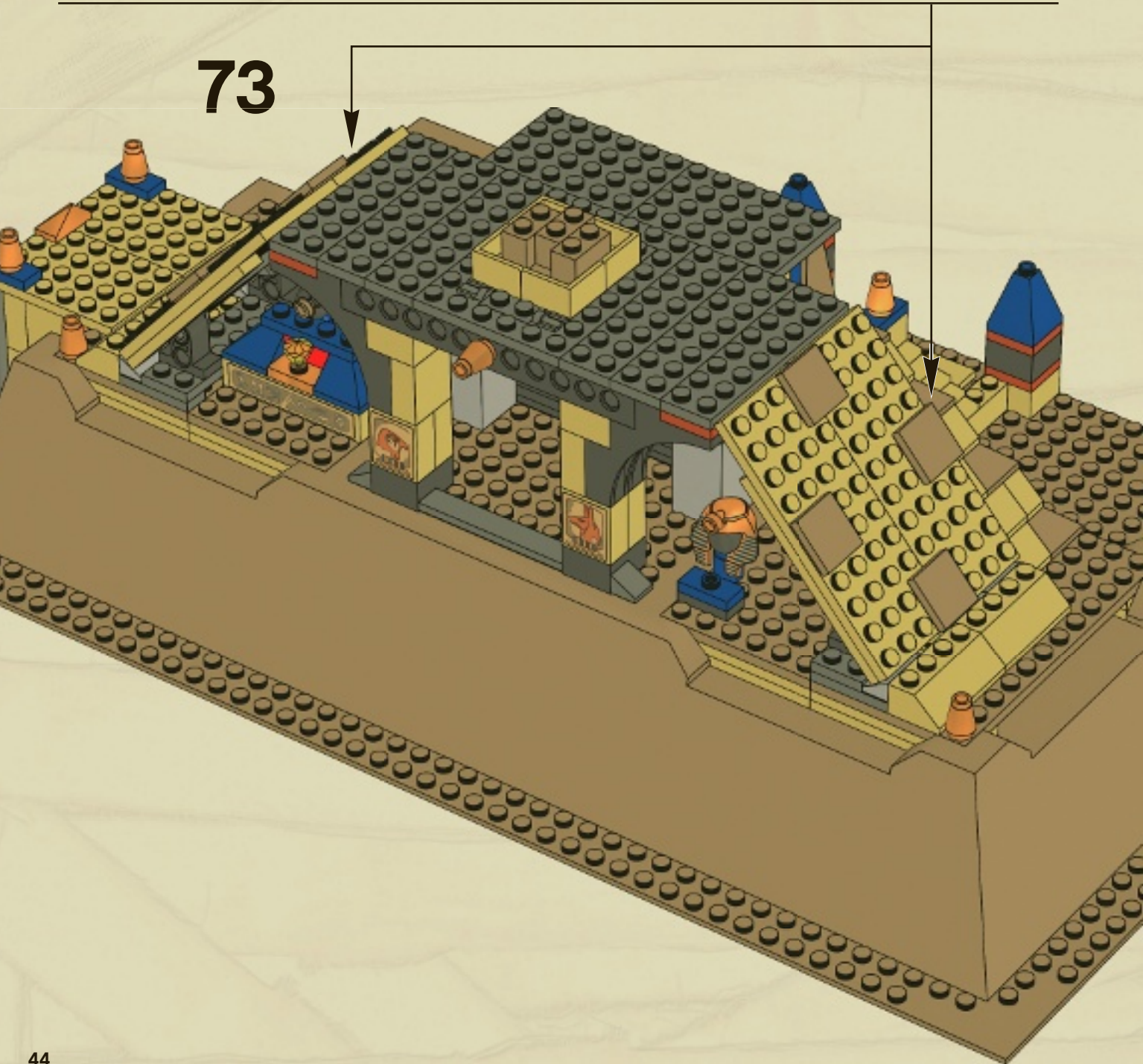

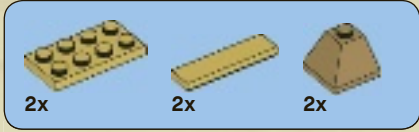

74





75

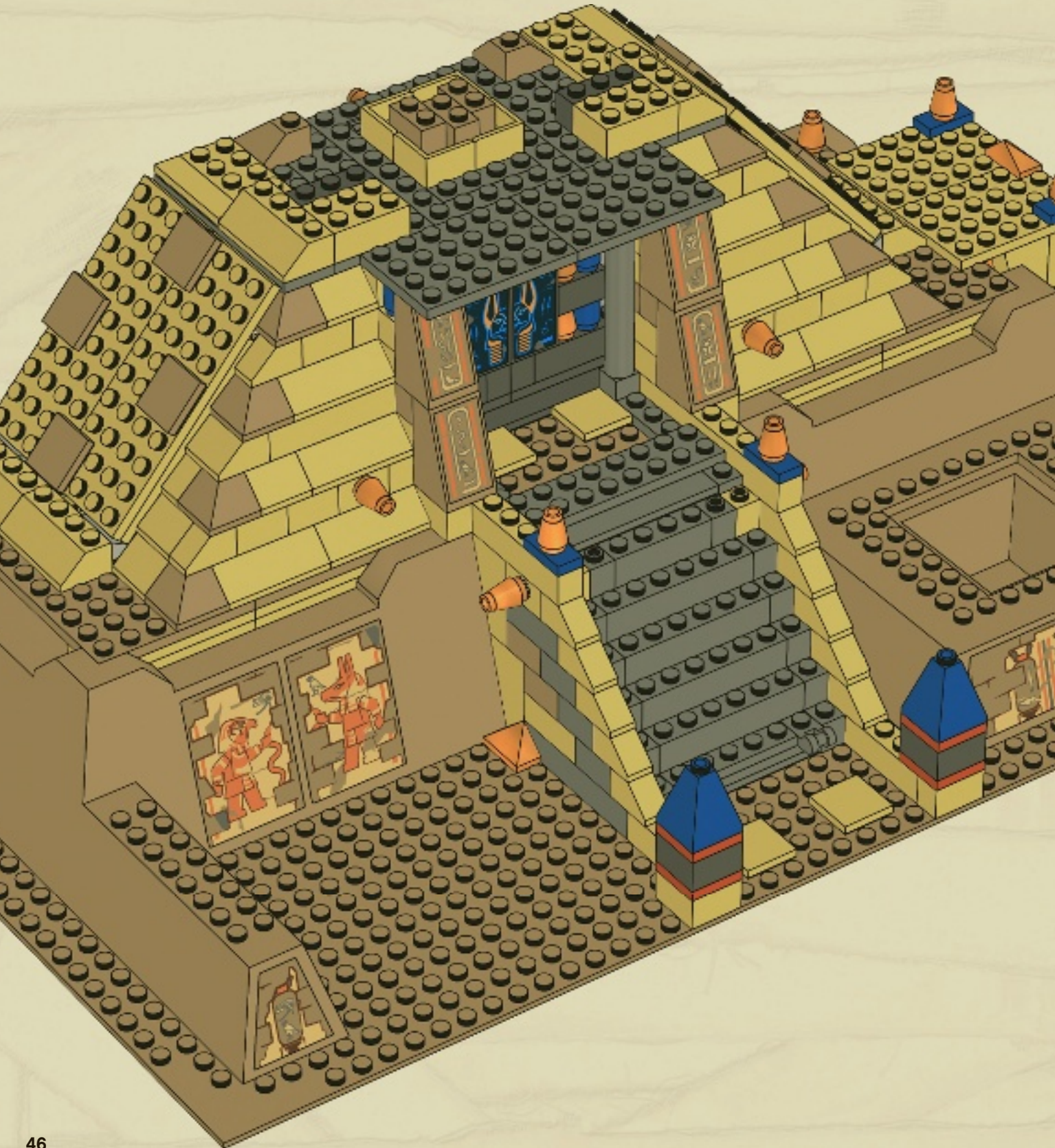

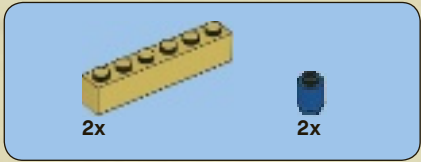

76

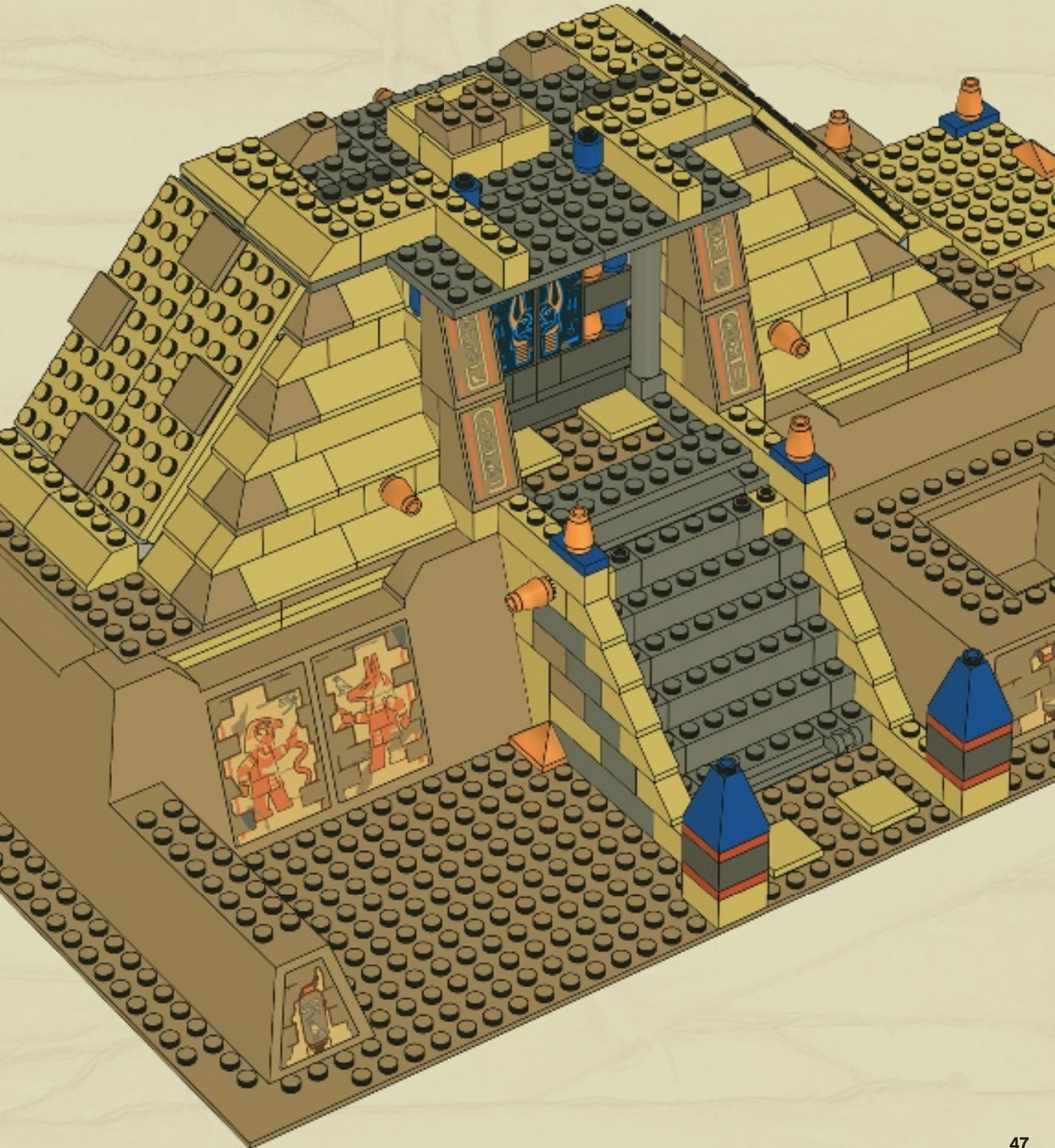



77

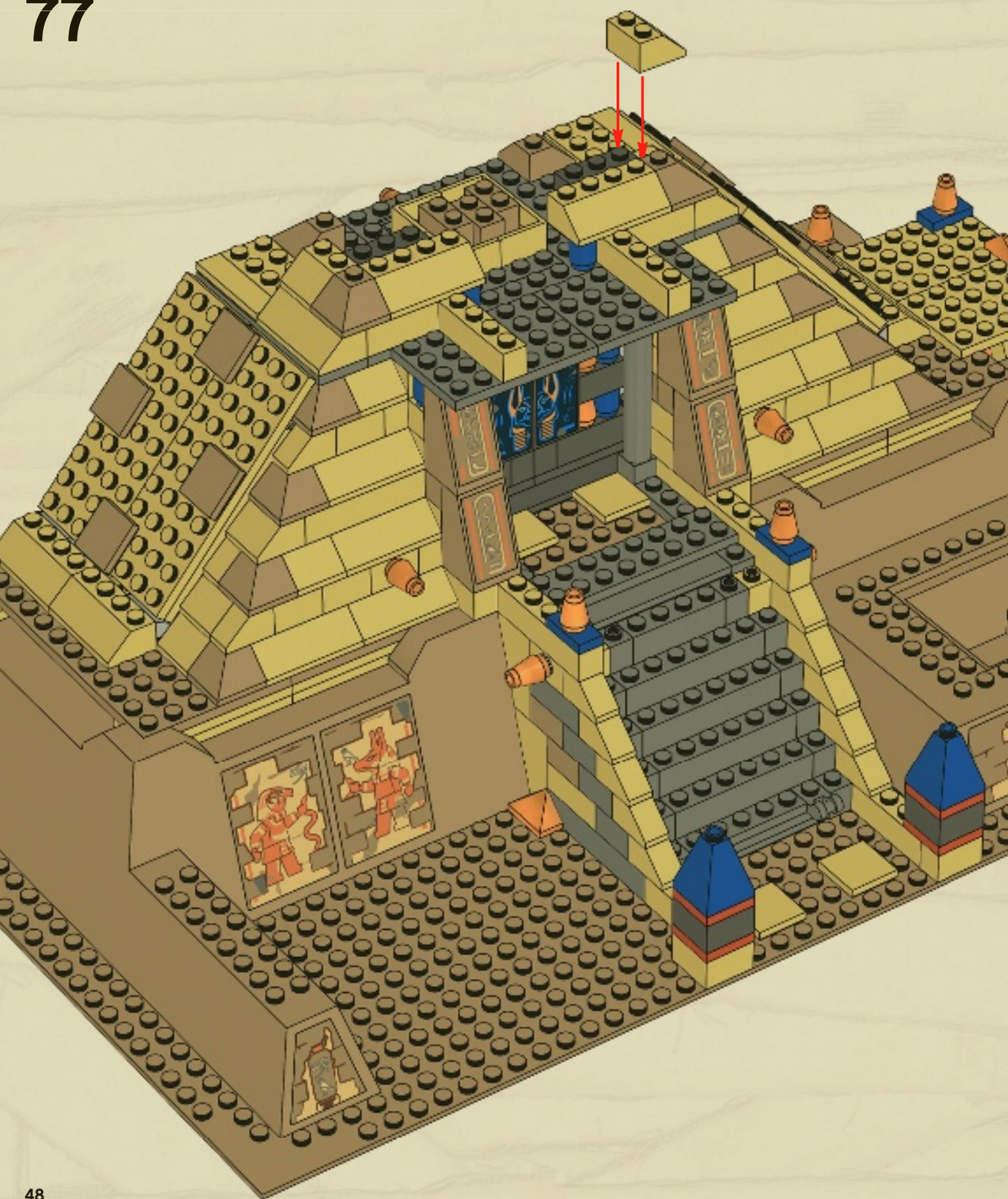

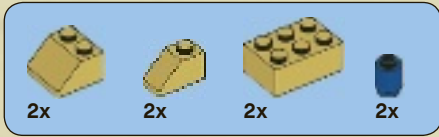

78

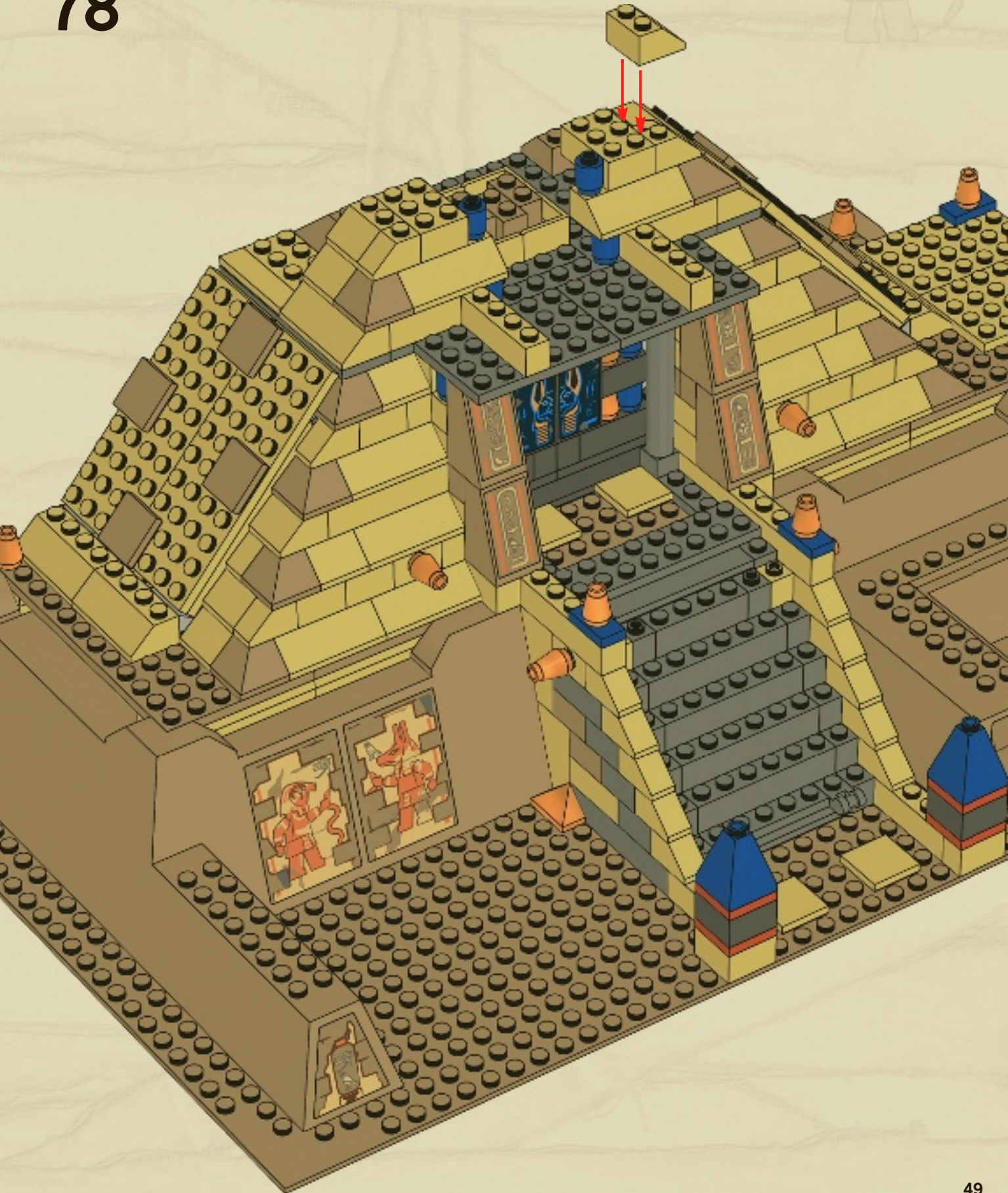

2x 2x 2x

79



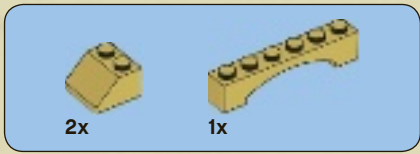

80

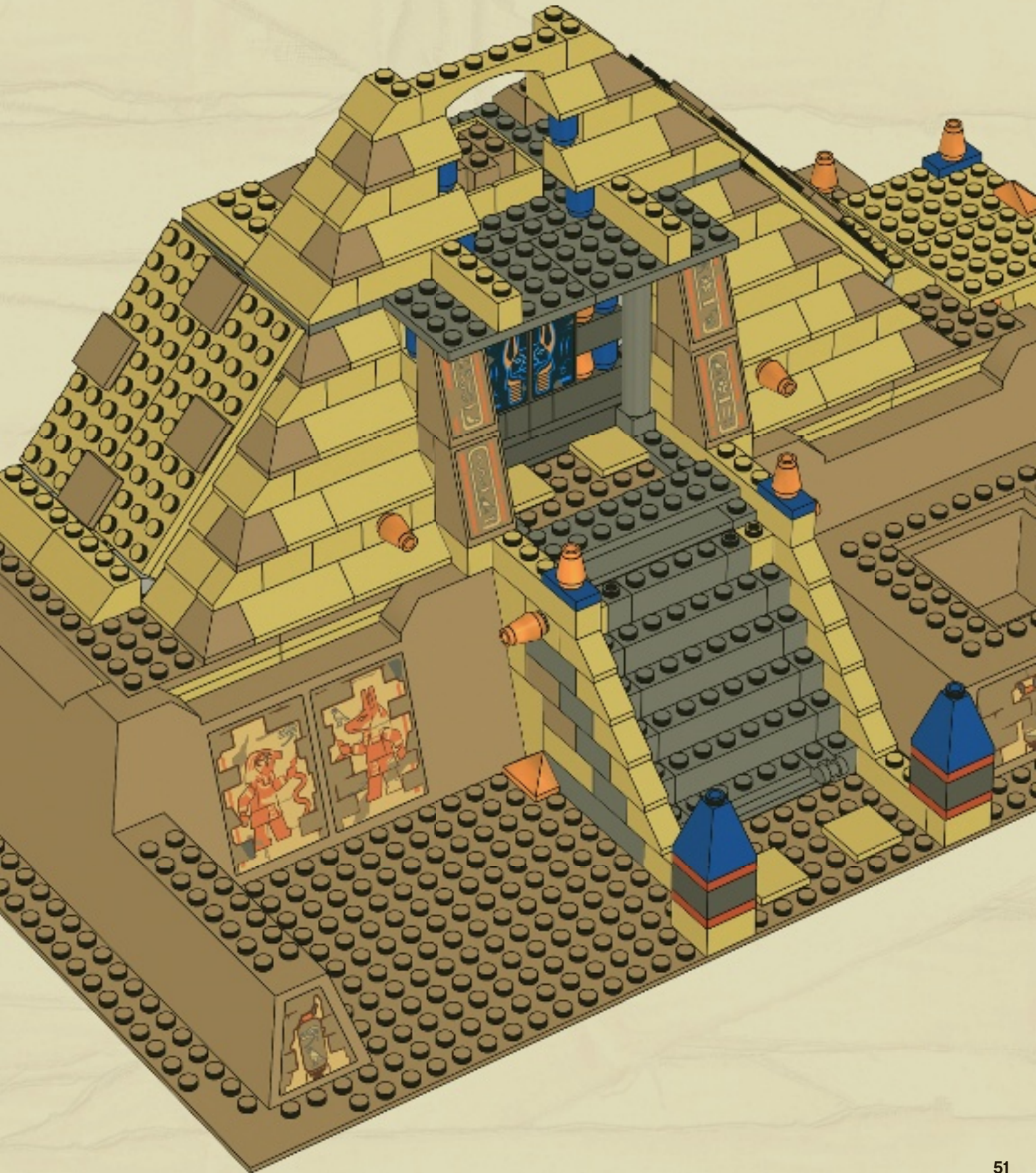

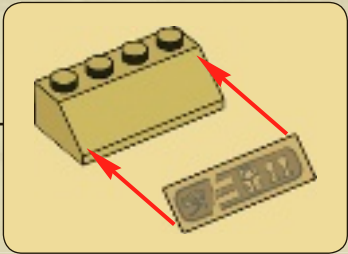
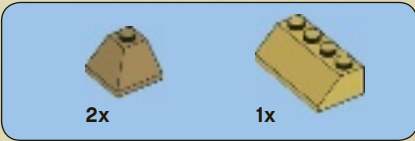

81





82



2x 2x

83

2x



2x

84

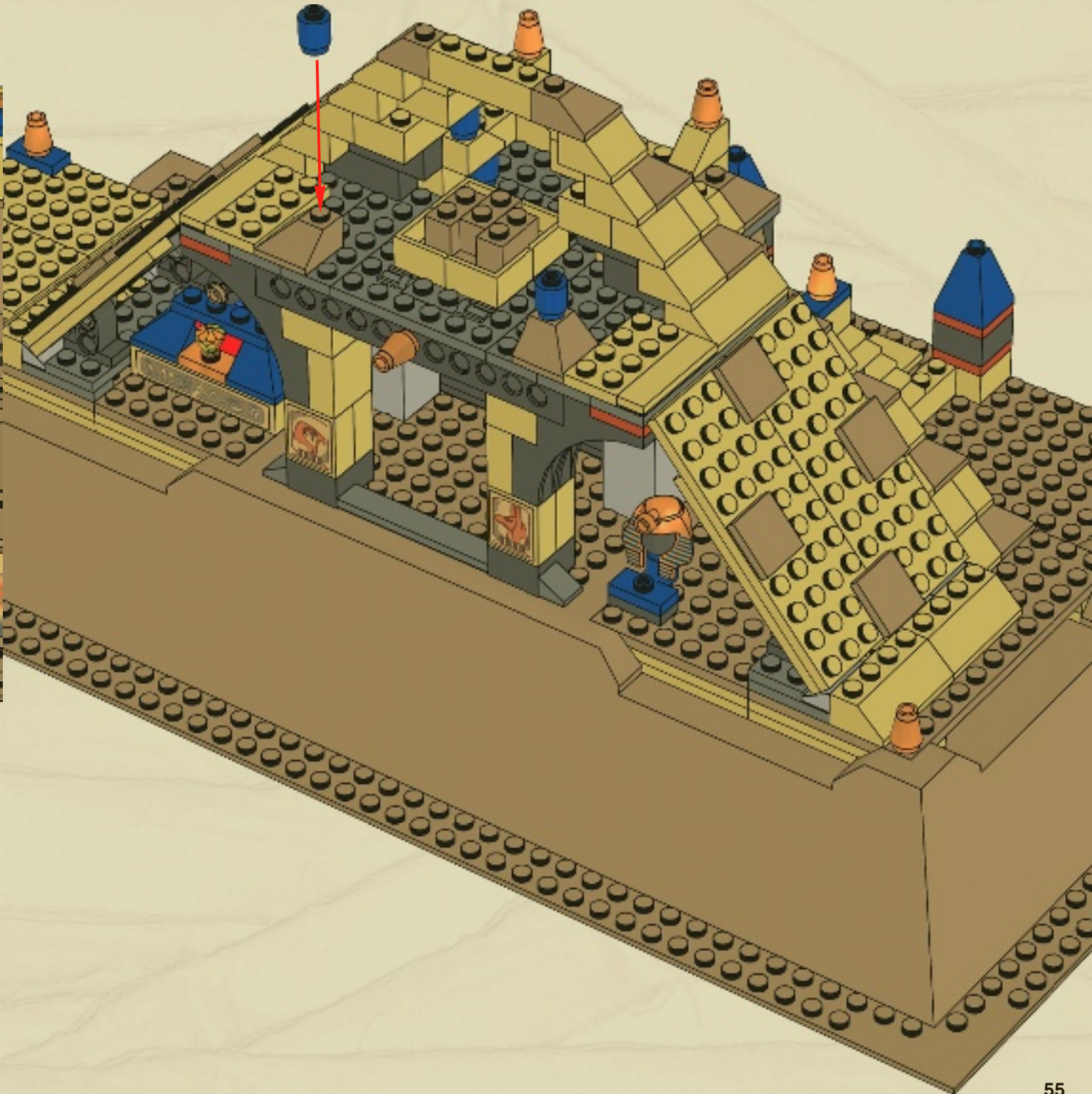

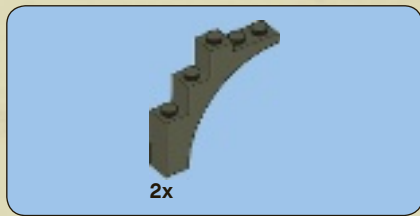

85

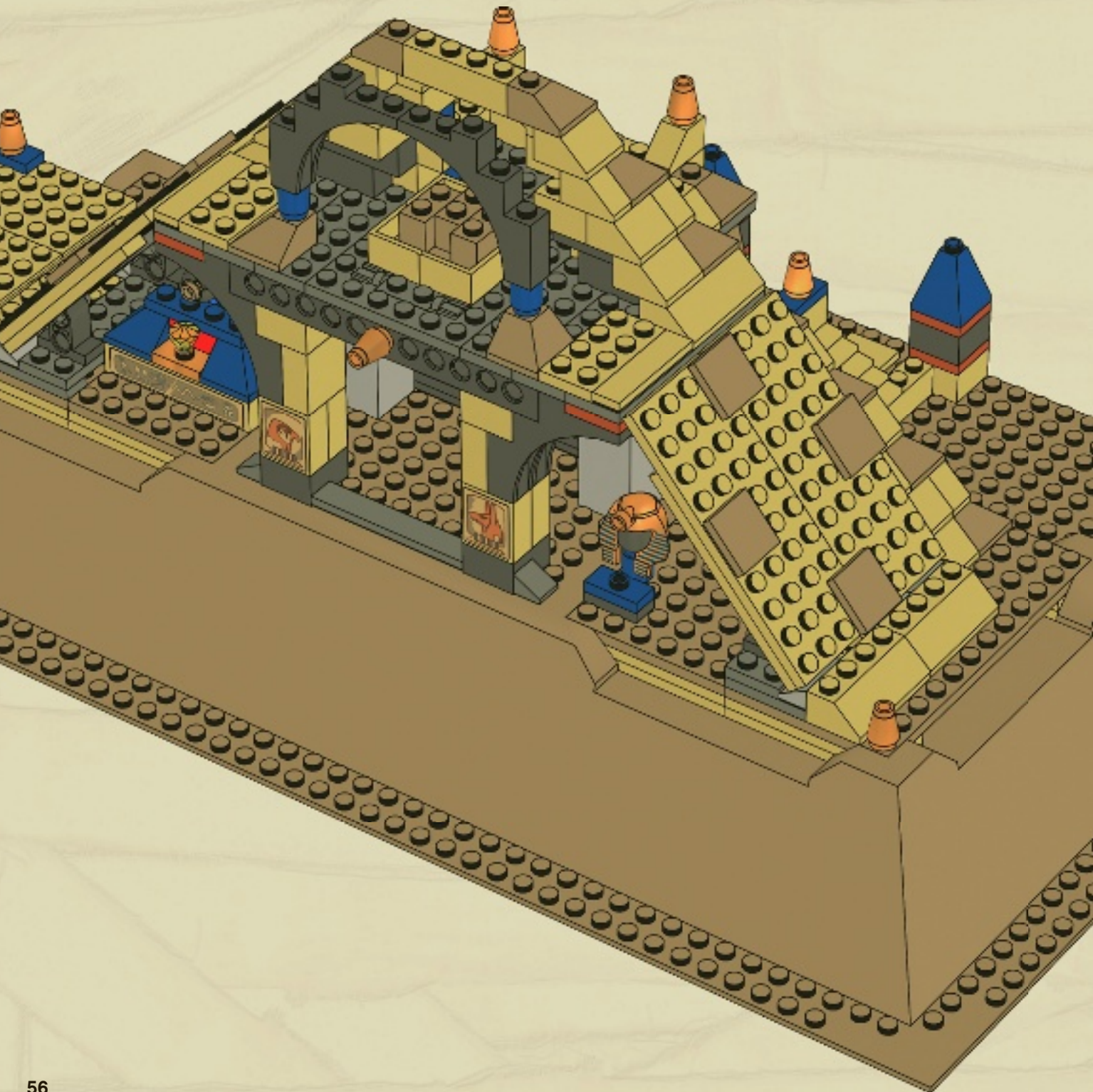



1x

86

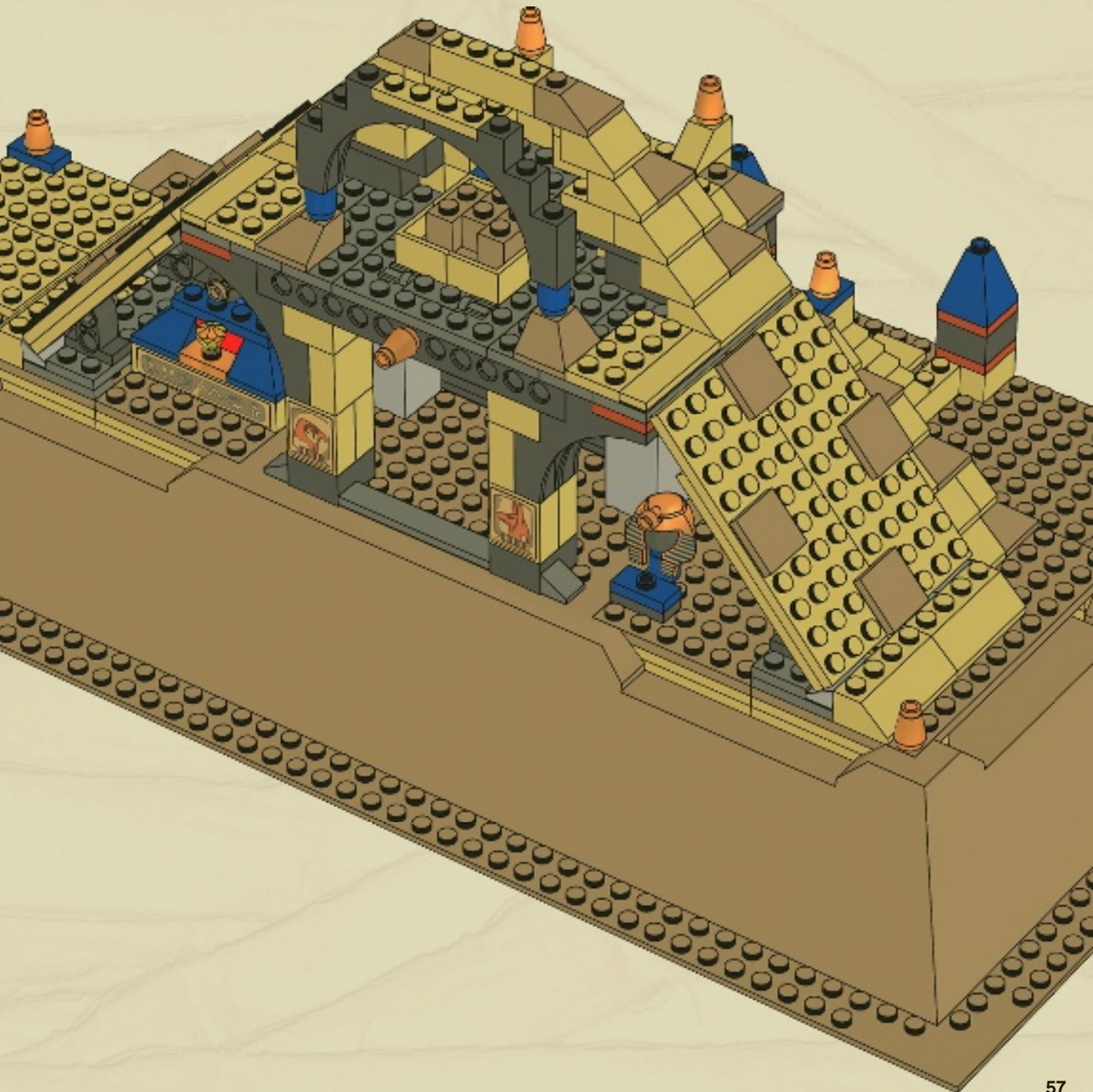

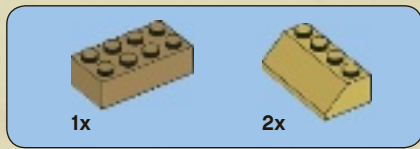

87

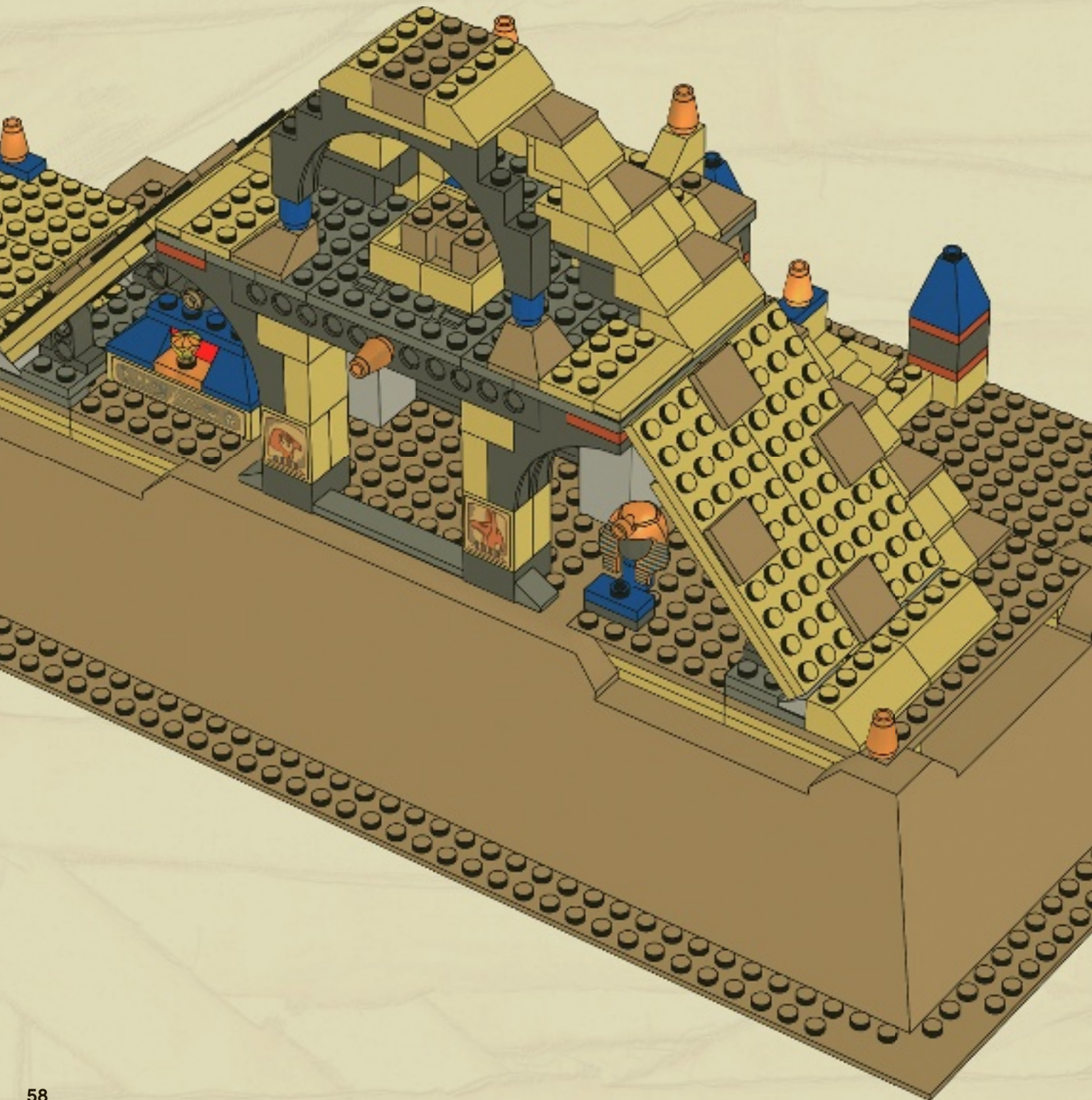



2x

88

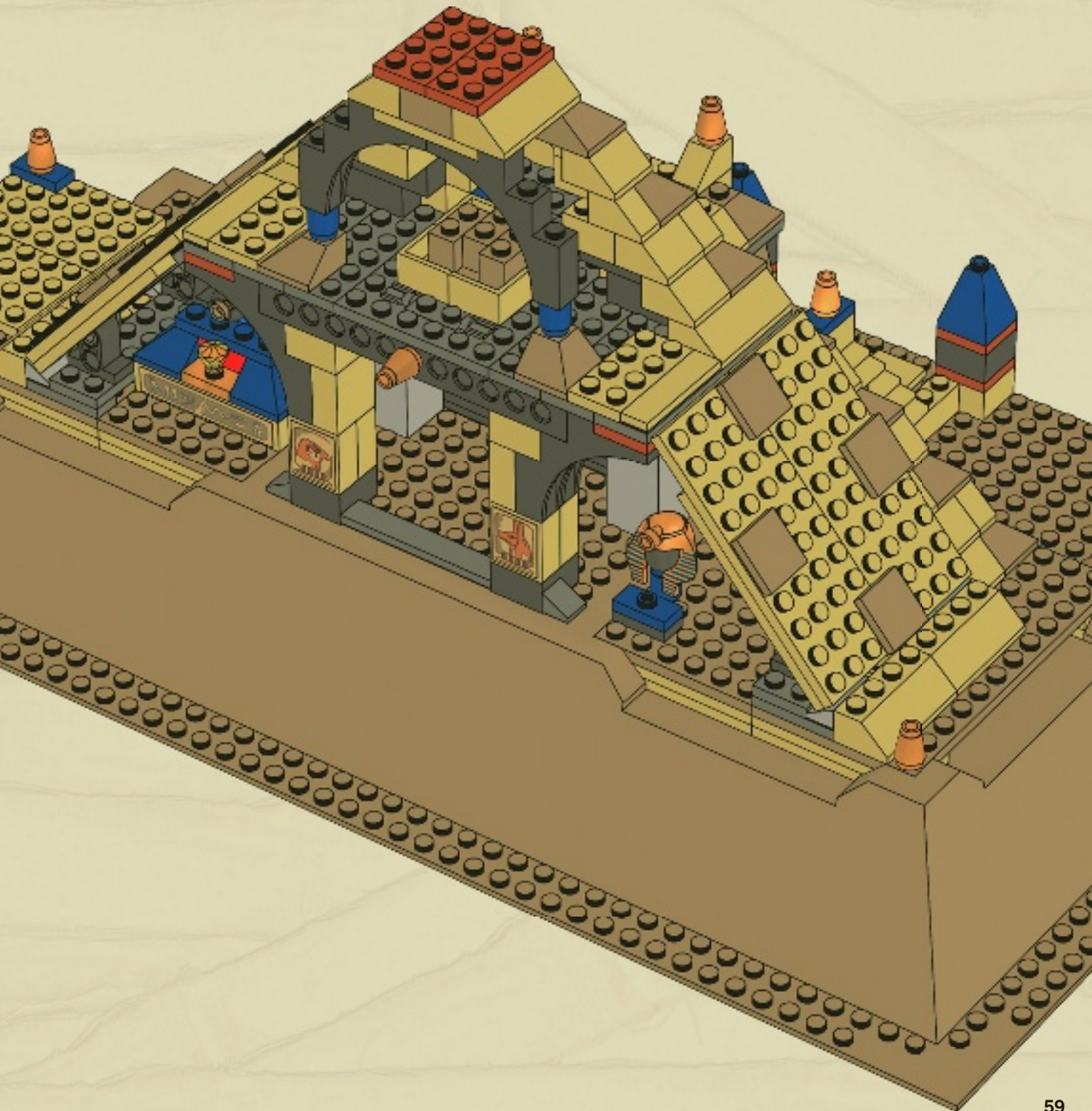



4x

89

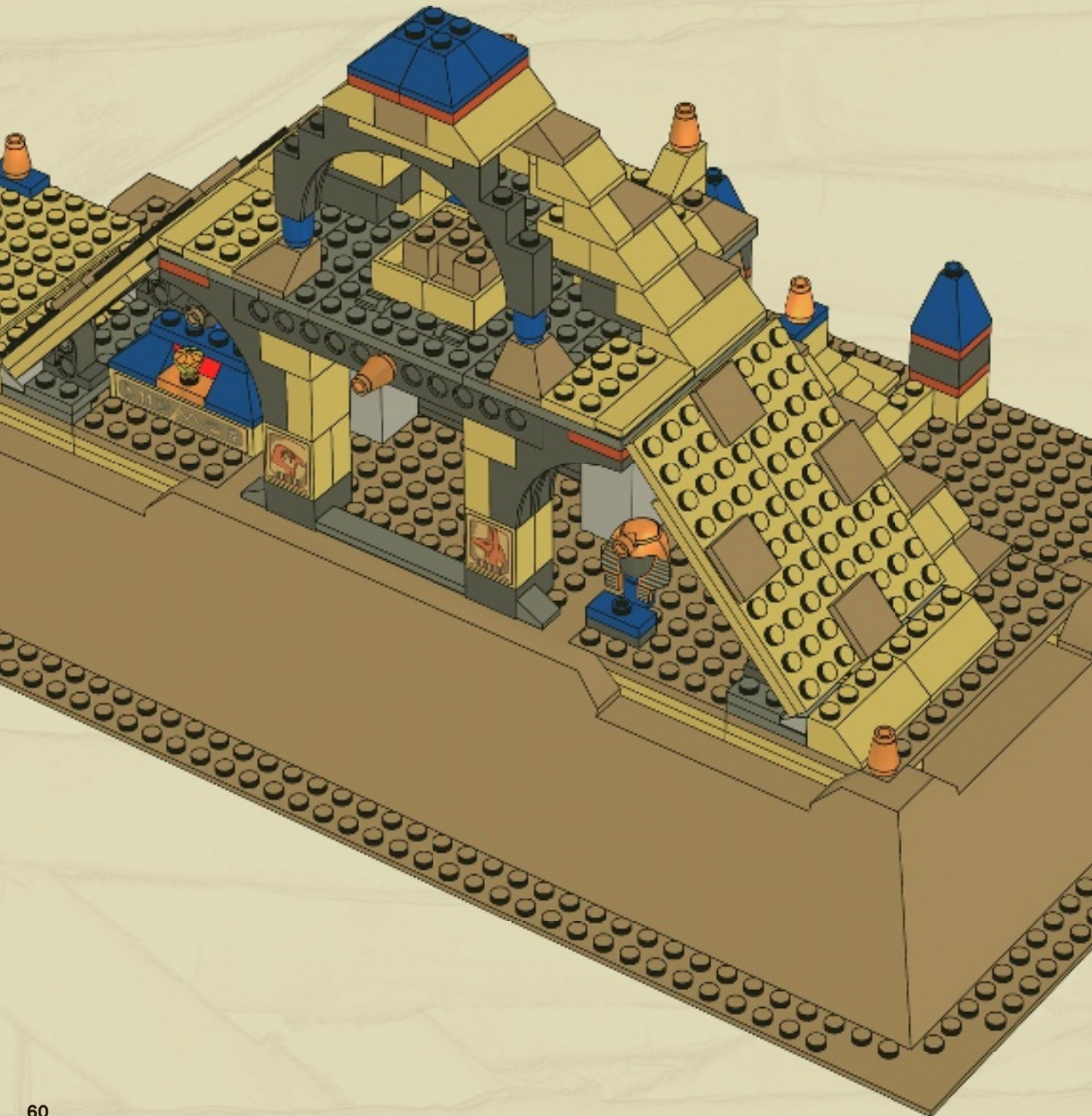



2x

90

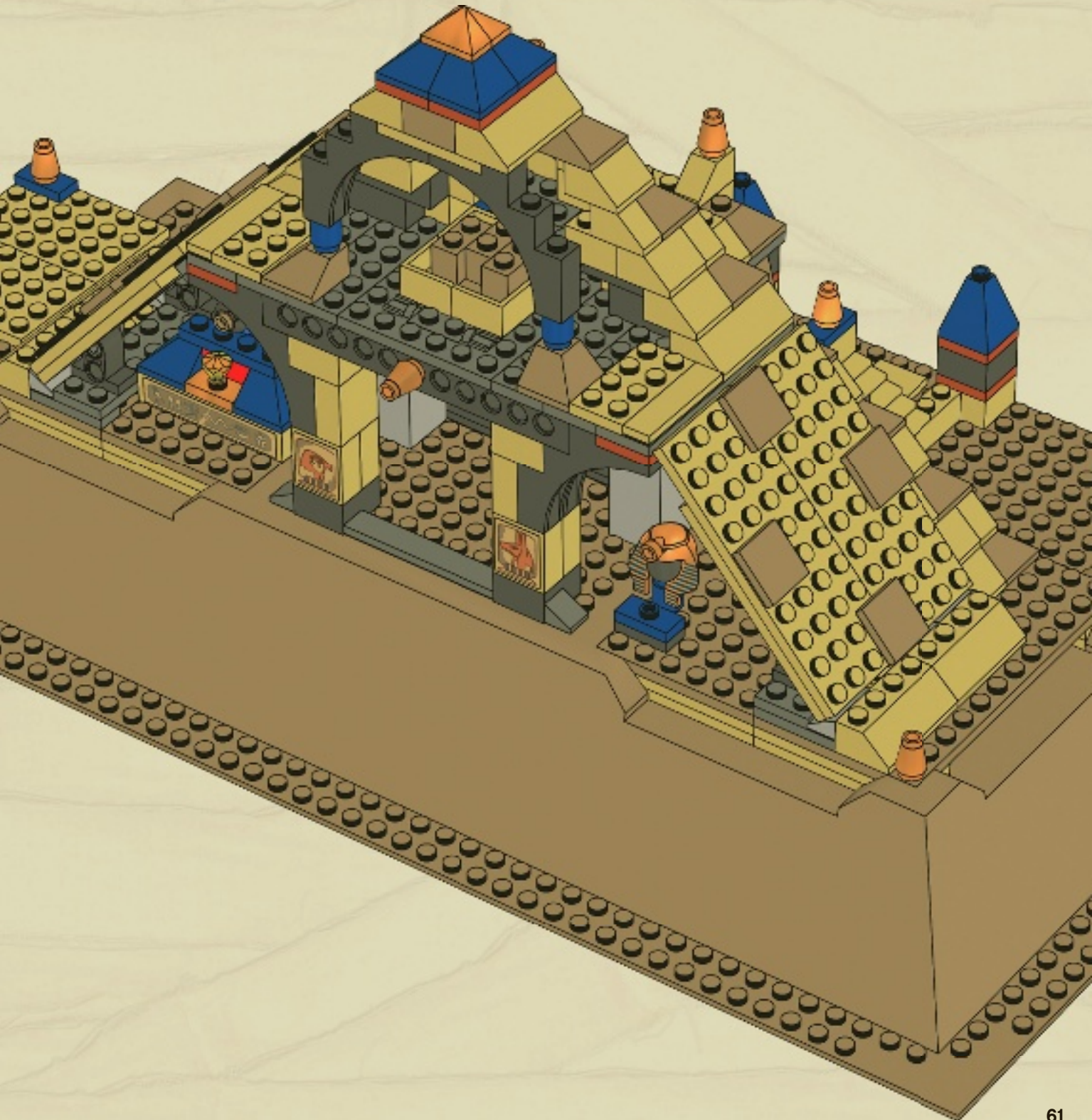



1

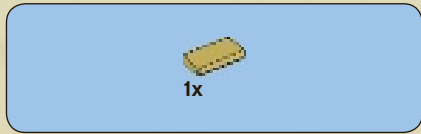
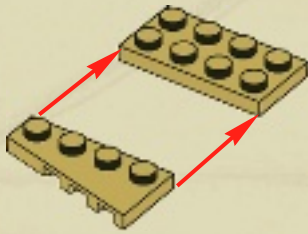

2

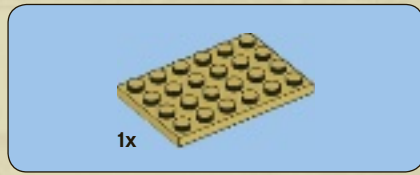
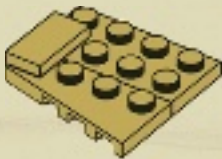

3

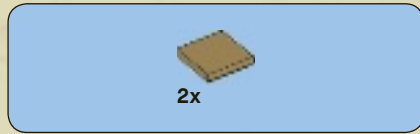
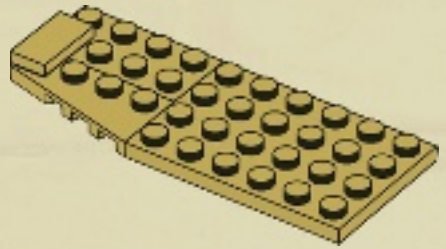

4

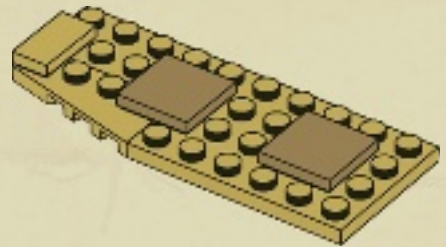



5

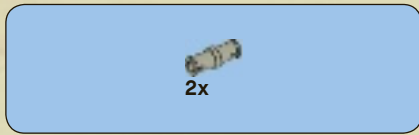
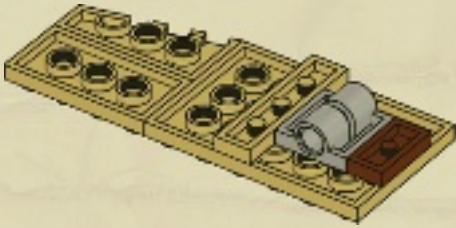

7

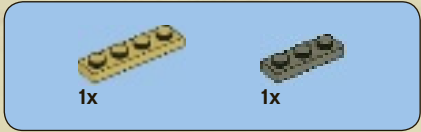
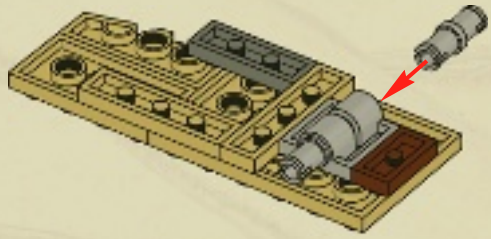

6

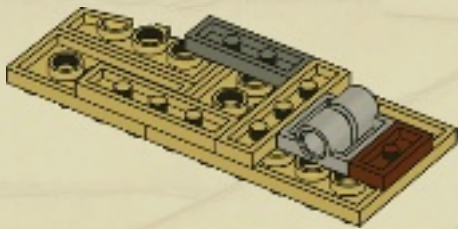

8

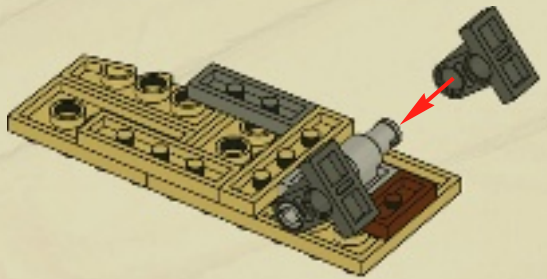

9

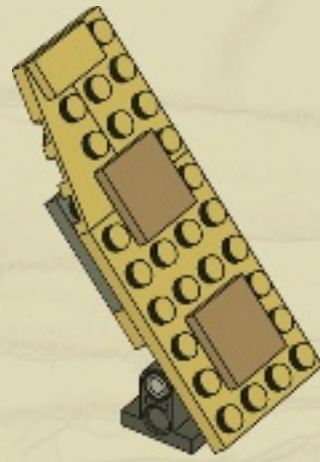
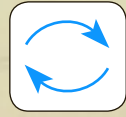

91

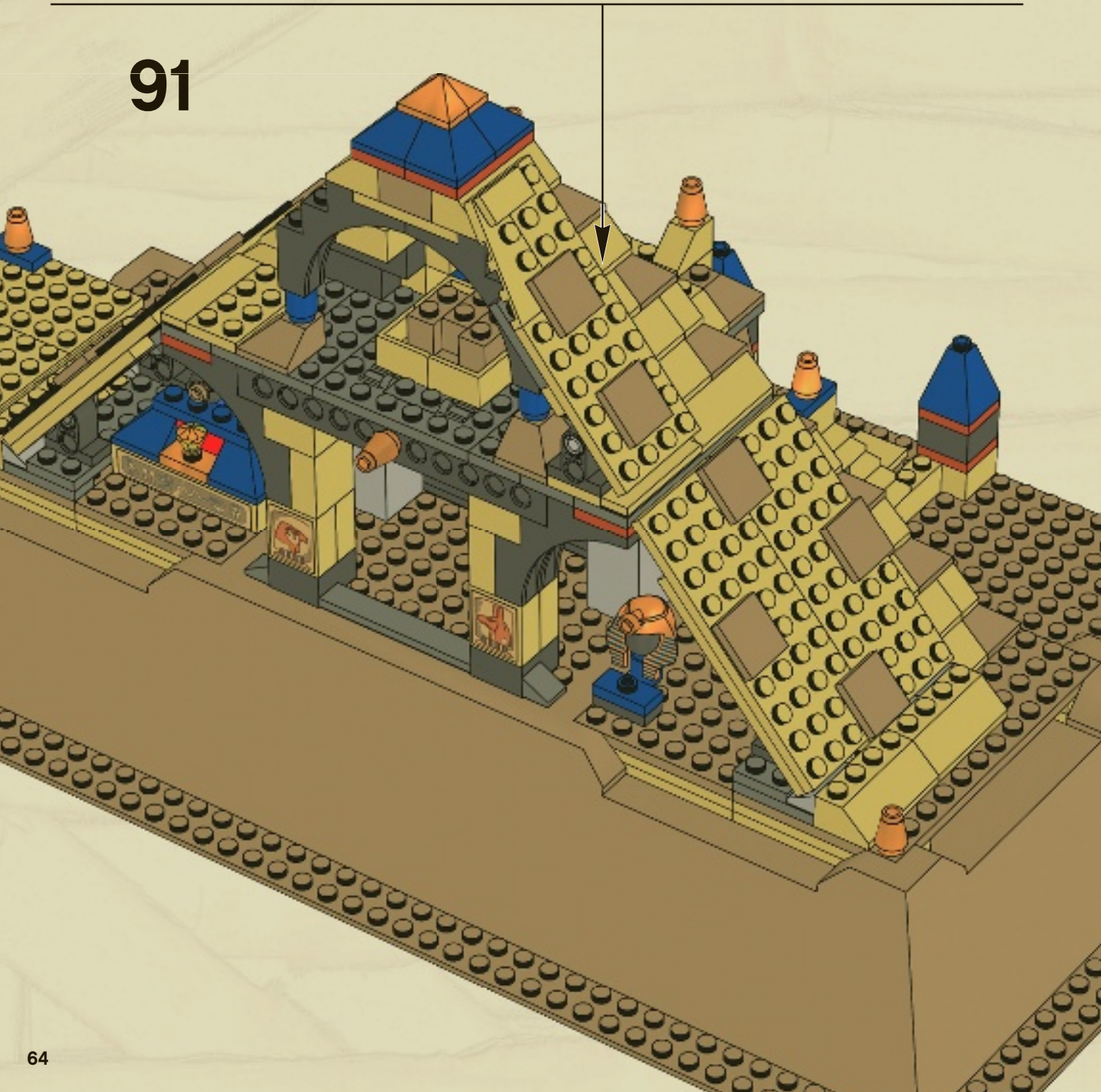

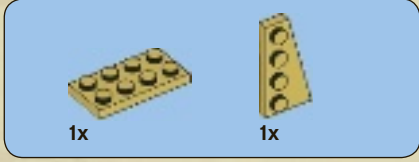

1

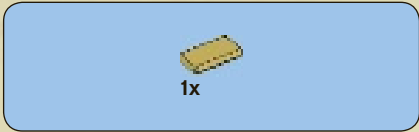
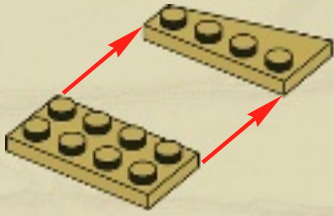

2

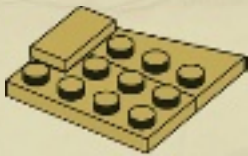

3

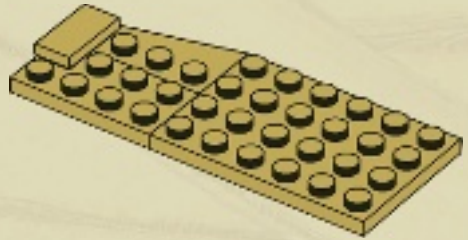

4

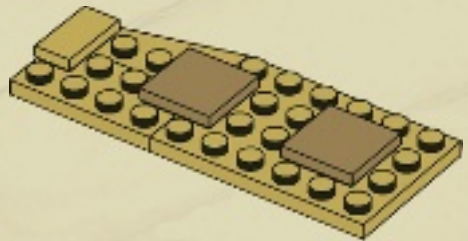



5

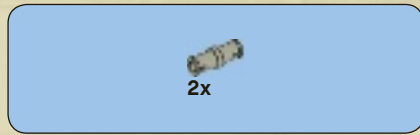
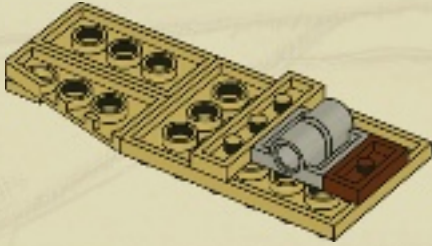

7

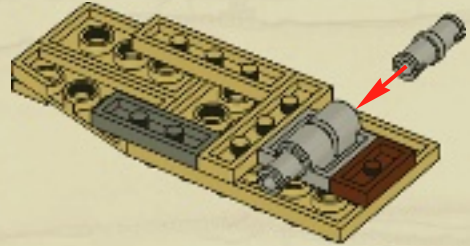

6

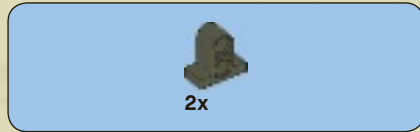
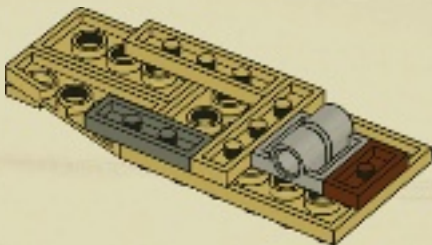

8

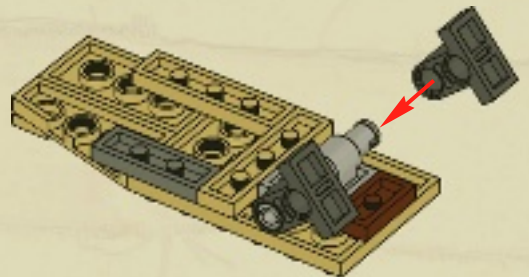

9

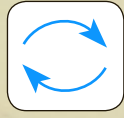

92

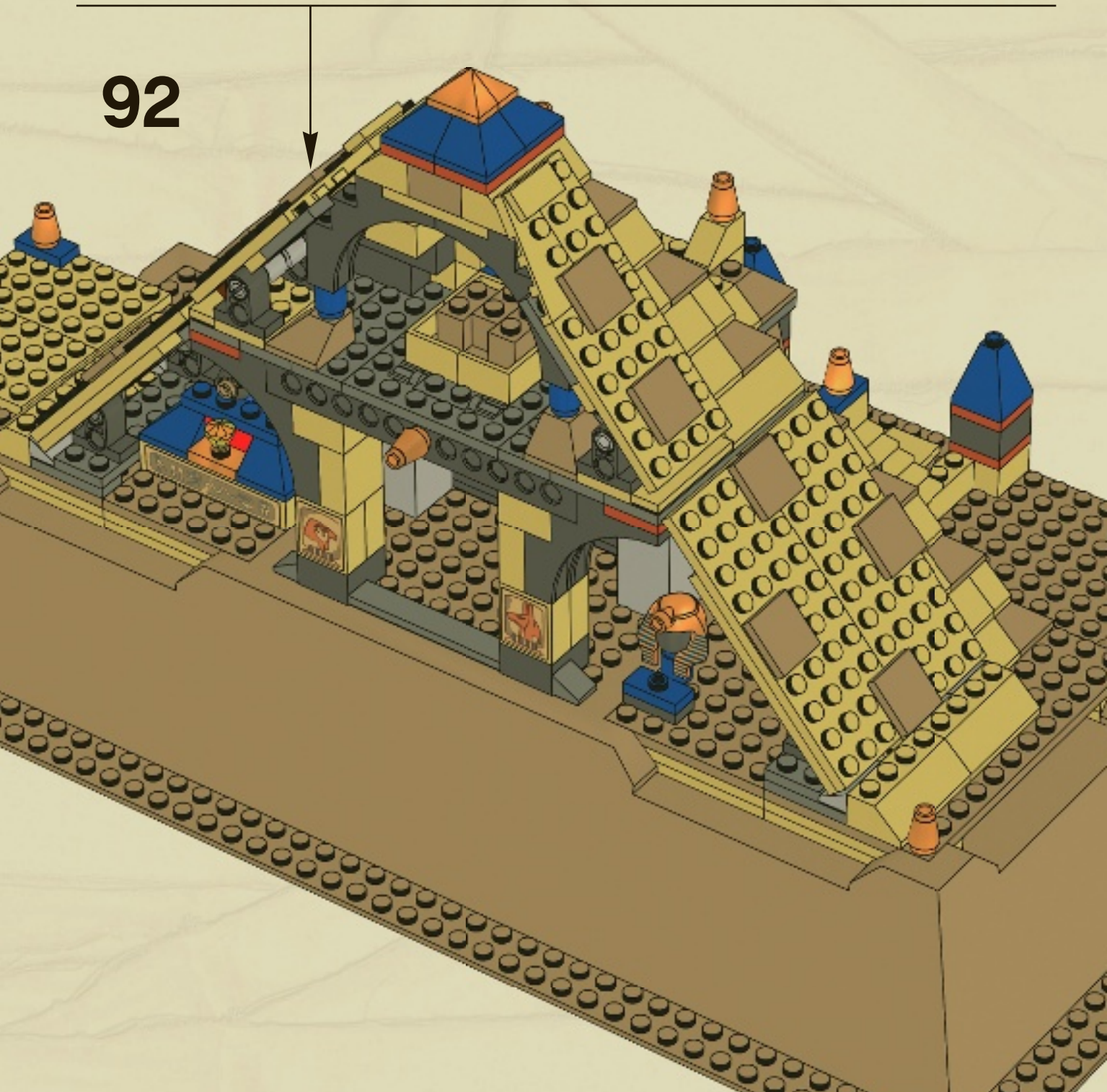



93

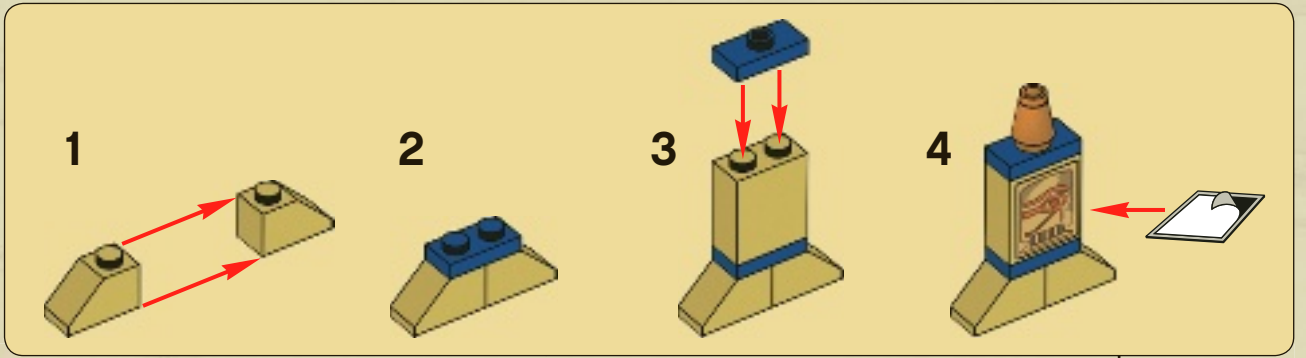



1x



3x

94

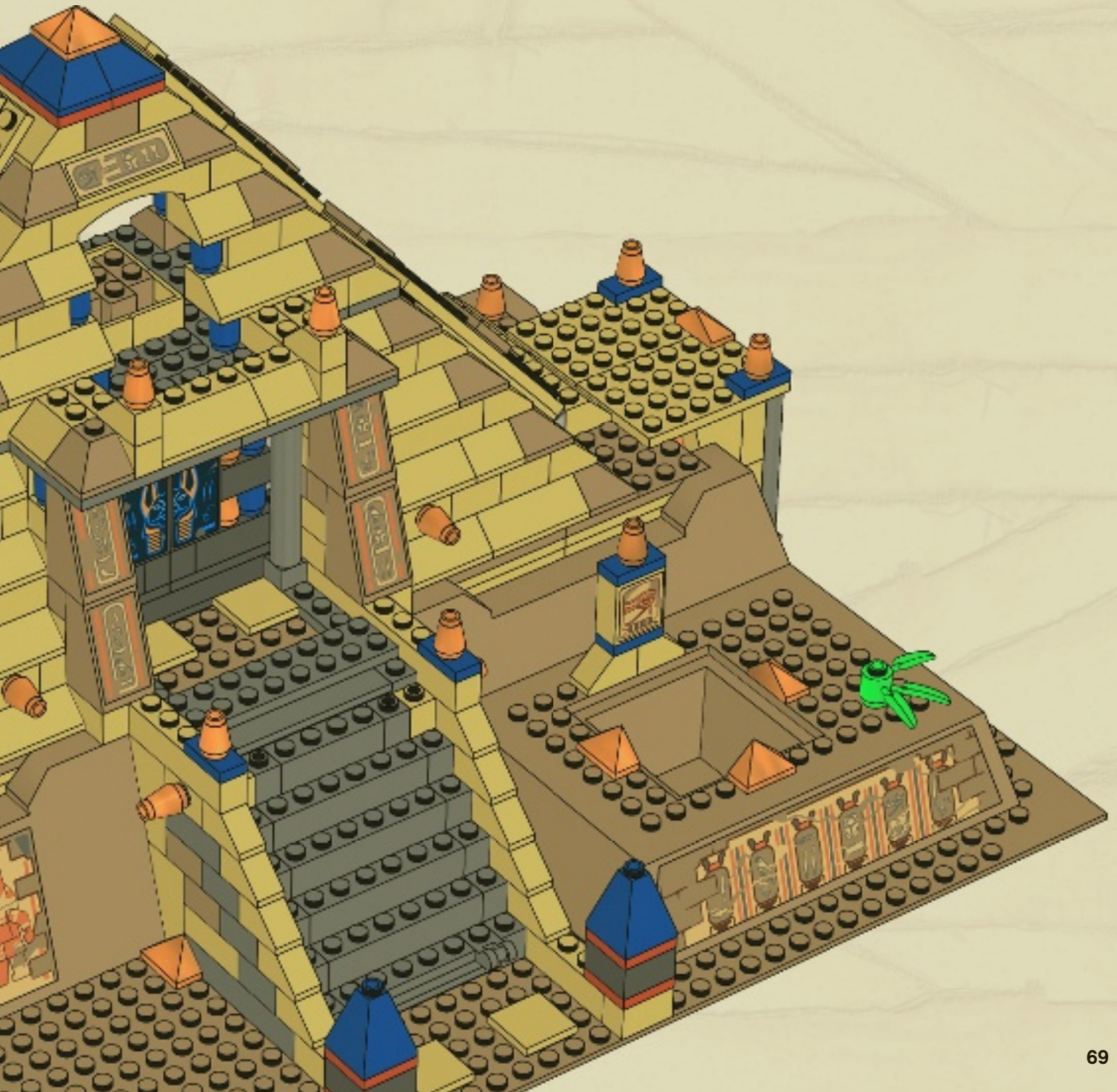



4x

95

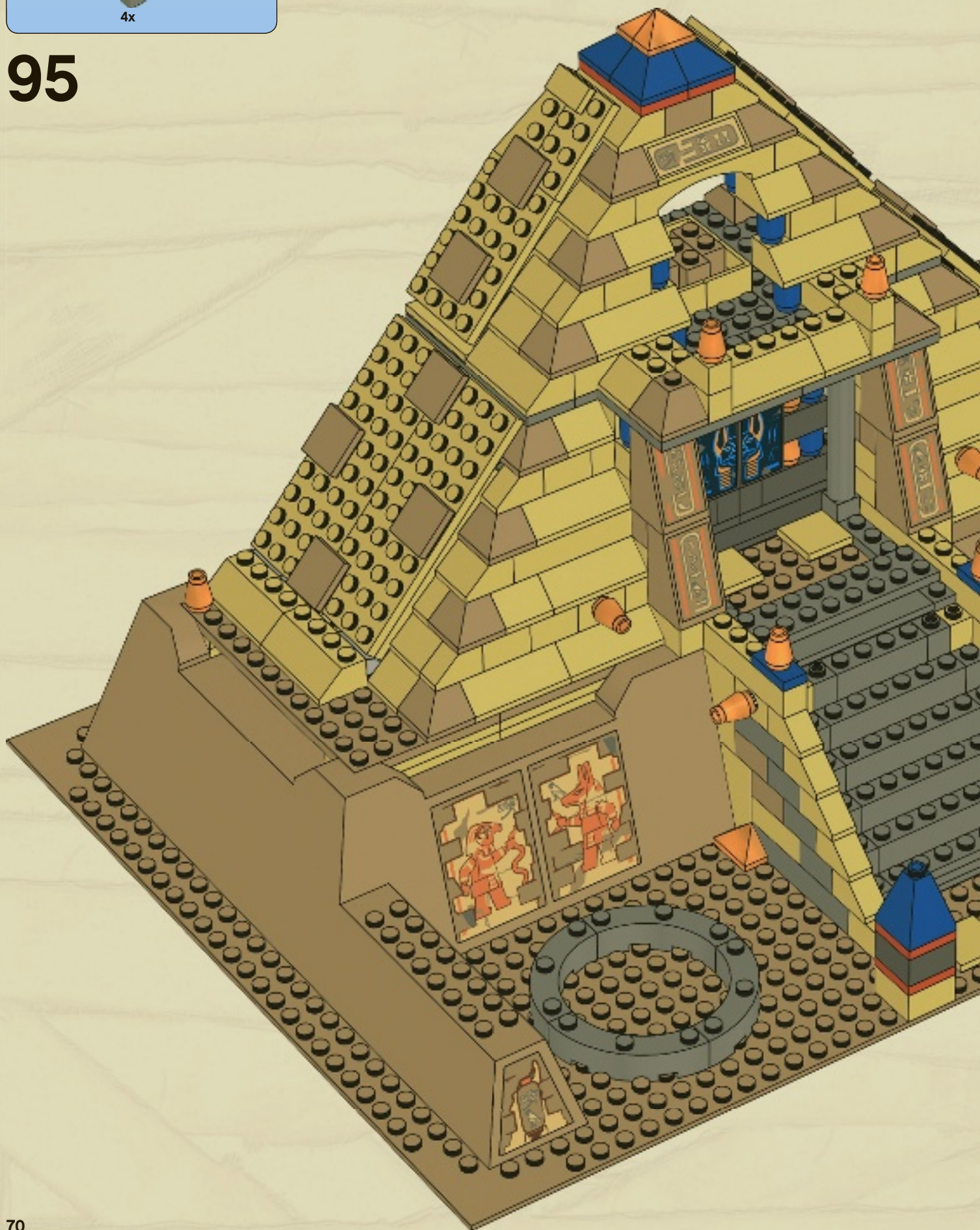



1x



4x

96

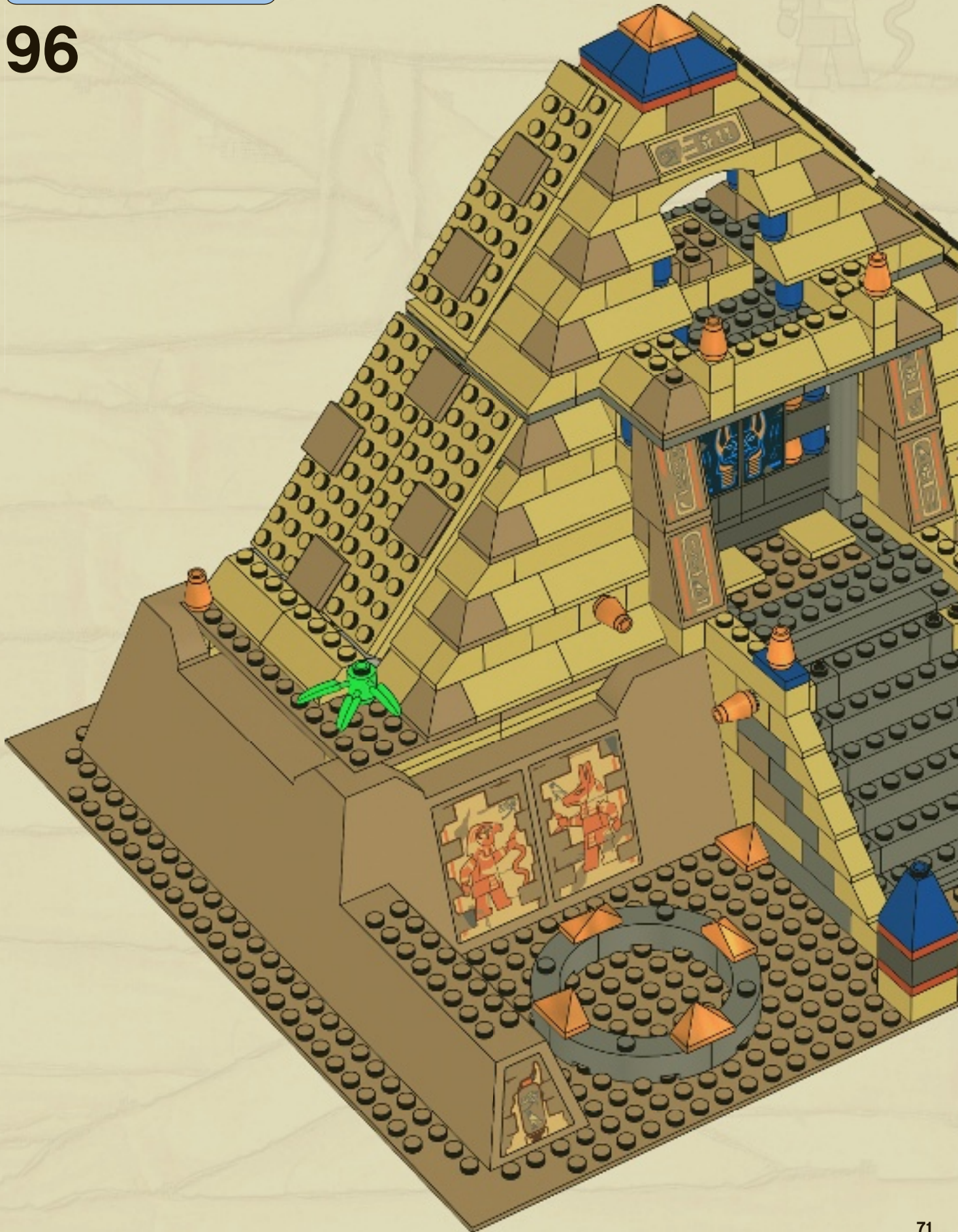

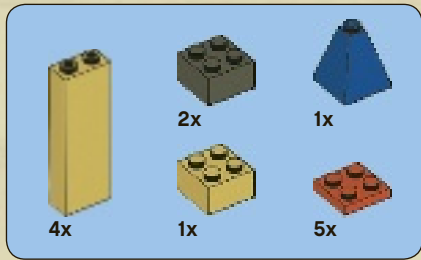

97

1

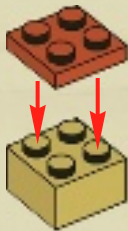

2

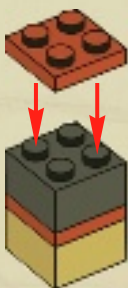

3



4

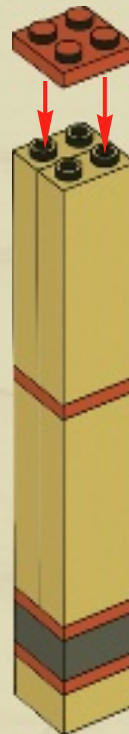



5

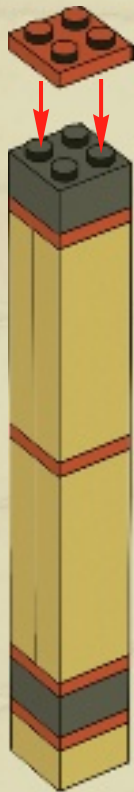

6

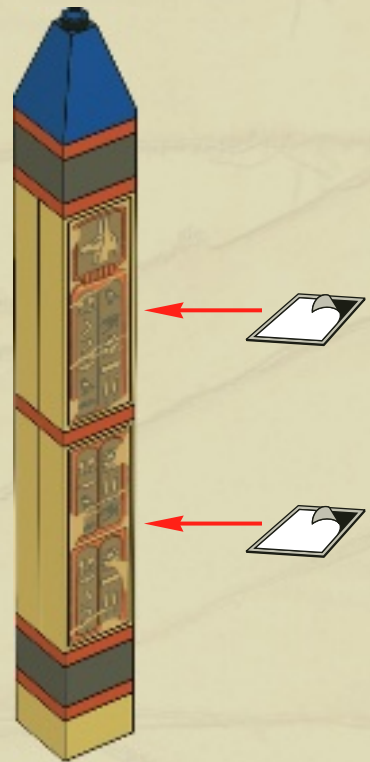



1x
2x
3x
1x

98



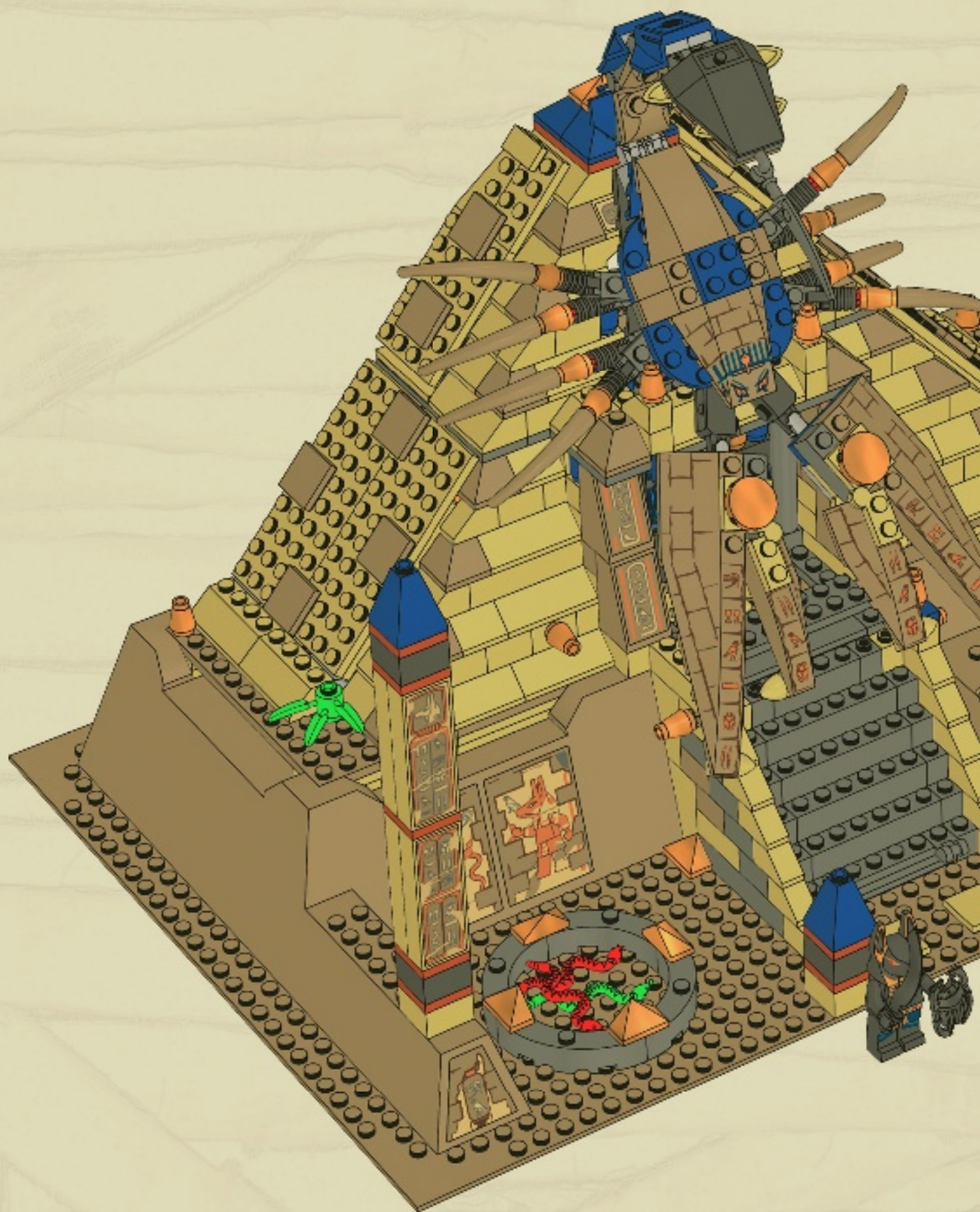

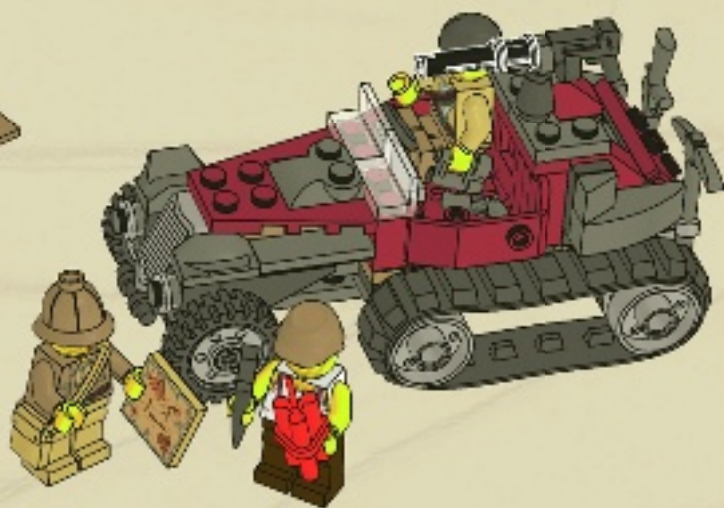

7325

7307

7326





7327

7305

7306



1x
4613468

8x
4113915

1x
4618876

7x
4159279

1x
4545384

1x
4616490

2x
4609477

4x
300526

2x
4180576

1x
4124096

1x
4286267

1x
4566927

8x
4611758

1x
4596319

11x
4114306

4x
4114064

4x
4593748

1x
4107623

2x
300426

6x
300326

2x
4614788

6x
416226

1x
4140801

2x
370526

2x
4114348

1x
4614288

1x
4614571

2x
4124455

2x
4162465

2x
4114026

6x
4113917

1x
4107623

1x
4613488

4x
362226

4x
301026

2x
447726

1x
389526

1x
4249063

13x
4615606

1x
4524098

1x
4613597

10x
4159739

6x
4113916

4x
4185177

1x
4614253

4x
4227507

4x
4161734

2x
300826

6x
4558954

8x
4158848

1x
4140588

2x
4535928

2x
3005740

1x
4613601

13x
4507045

3x
4112962

3x
4181134

2x
4550324

5x
4113233

20x
4614739

8x
4616212

1x
4118624

2x
4167106

1x
4251393

2x
4113106

1x
4128576

3x
4267874

5x
4550329

2x
4159774

3x
4166138

9x
4124067

12x
4113993

1x
4550632

10x
4224793

1x
4529236

1x
4569733

1x
4251394

1x
245821

2x
4507196

1x
4522668

3x
4614858

1x
4249019

4x
4114324

10x
4205107

2x
428726

1x
4550004

2x
4613611

2x
4613604

2x
4538780

2x
4114052

19x
4521914

1x
4247145

4x
4609328

5x
4114001

24x
4121972

1x
4613585

1x
4613418

6x
4519925

13x
302326

1x
362626

1x
4526110

1x
4227155

8x
4142865

3x
4520257

4x
4530678

1x
4125217

21x
4114322

1x
4613411

2x
4153707

2x
371026

2x
4541455

1x
400626

1x
4549989

1x
4143005

2x
4206482

2x
4514553

4x
4613790

18x
4613007

Customer Service
Kundenservice
Service Consommateurs
Servicio Al Consumidor
www.lego.com/service or dial

00800 5346 5555 :

1-800-422-5346 :

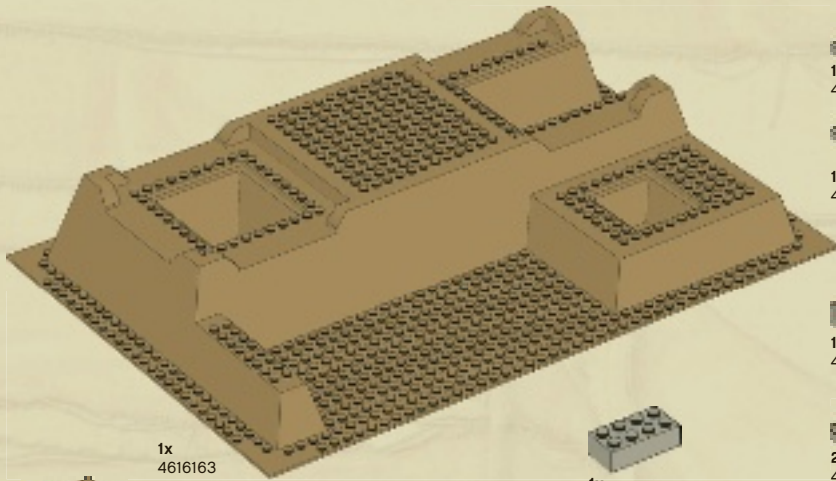

1x 4616163

- 1x 4226995
- 1x 4523369
- 1x 4211469
- 2x 4211450
- 1x 4234240
- 4x 4211807
- 2x 4211639
- 4x 4211650
- 6x 4211060
- 2x 4211104
- 2x 4211105
- 1x 4211085
- 6x 4210875
- 2x 4211099
- 2x 4210935
- 2x 4210723
- 4x 4180811
- 4x 4535931
- 2x 4246896
- 1x 4620760
- 2x 4210635
- 2x 4568734
- 4x 4211133
- 1x 4211065
- 5x 4211056
- 6x 4210651
- 1x 4211002
- 3x 4211115
- 9x 4210997
- 2x 4211067
- 1x 4611703
- 14x 4210884
- 2x 4521187
- 5x 4509884
- 1x 4595710
- 1x 4595708
- 6x 4504378
- 2x 4514559
- 2x 4278274
- 1x 4211029
- 1x 4211051
- 1x 4211007
- 1x 4523773
- 1x 4509194
- 2x 4218750
- 1x 4218696
- 1x 4289542
- 1x 4508553
- 1x 4529672
- 30x 4529247
- 12x 4295174
- 1x 4523157
- 2x 4579099
- 1x 4614590
- 2x 4610904
- 2x 4610956



1x 4614200



1x 4613281



1x 4613280



1x 4613274



1x 4613275



3x 4266897



1x 4613269



2x 4541526



2x 4539090



1x 4539061



1x 4541544

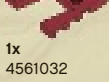

1x 4561032



1x 70501



1x 4612822



8x 4186627



3x 4613003



4x 4614554



1x 4613335



1x 4614793



1x 4609504



1x 4296785



23x 4177741



6x 4196736



3x 4614791



1x 4528981



5x 4502089

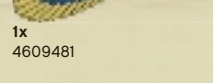

1x 4609481



1x 4211385



2x 4211694



4x 4568637



6x 4211437



1x 4211429

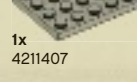

1x 4211452

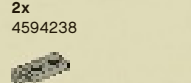

1x 4211407



2x 4594238



6x 4211803



5x 4211376



1x 4613494



1x 4613454



1x 4613425



1x 4613588

2x 4499259

4x 4299119

2x 4222047

LEGO® Glyphs

 A	 B	 C	 D	 E	 F	
 G	 H	 I	 J	 K	 L	 M
 N	 O	 P	 Q	 R	 S	 T
 U	 V	 W	 X	 Y	 Z	



Solve the code above and enter pharaohsquest.LEGO.com
 Déchiffre le code ci-dessus et viens sur pharaohsquest.LEGO.com
 Entschlüssel den Code und gib das Lösungswort auf PharaohsQuest.LEGO.de ein.
 Déchiffre le code ci-dessus et entre dans pharaohsquest.LEGO.com
 Resuelve el jeroglífico y visita pharaohsquest.LEGO.com
 Decifra o código acima e entra em pharaohsquest.LEGO.com
 Fejtsd meg a fenti kódot, és lépj be a pharaohsquest.LEGO.com oldalra.



pharaohsquest.LEGO.com



www.LEGOclub.com

LEGO club™

FREE! GRATIS! GRATUIT!



LEGO® Club Magazine



LEGO® Club Email

VISIT THE WORLD'S
BIGGEST LEGO® SHOP!
www.LEGOshop.com

GO TO
www.LEGOclub.com

00800 5346 5555*

1-866-534-6258 • 1-877-518-5346

US & Canada only

Canada seulement



* Freephone. Mobile charges may apply. * Numéro sans frais. Des frais peuvent s'appliquer avec les téléphones cellulaires. * Gebührenfrei. Kosten für Anrufe aus Mobilfunknetzen können abweichen. * Gratis telefoonnummer vanaf vaste lijn. * Det er et gratis nummer, når du ringer fra fasttelefon. * Det är gratis, när du ringer från en fast telefon. * Numéro sans frais. Des frais peuvent s'appliquer avec les téléphones portables.



WIN!

Go to www.LEGOsurvey.com/product to fill out a survey for a chance to win a cool LEGO® Product. No purchase necessary. Open to all residents where not prohibited.

 www.LEGO.com



www.LEGOsurvey.com/product

GEWINNE!

Nimm an der Umfrage auf www.LEGOsurvey.com/product teil und hab die Chance ein cooles LEGO® Produkt zu gewinnen!

Die Teilnahme am Gewinnspiel führt zu keinerlei Kaufverpflichtungen. Teilnahme in allen nicht ausgeschlossenen Ländern möglich.

4624533 / 4624540

WIN!

Ga naar www.LEGOsurvey.com/product, vul een enquêteformulier in en maak kans op een cool LEGO® product.

Geen aankoopverplichting. Iedereen mag deelnemen, uitgezonderd ingezetenden van landen waar een enquêteverbod geldt.

GAGNE !

Visite www.LEGOsurvey.com/product pour répondre à un questionnaire et avoir une chance de gagner un produit LEGO® très cool !

Aucune obligation d'achat. Ouvert à tous les résidents des pays autorisés.

当てよう!

www.LEGOsurvey.com/product にアクセスして、アンケートにご記入ください。当選者にはレゴ製品を差し上げます。

お買い上げの必要はありません。禁止されていない限り、すべての皆様にご利用いただけます。