

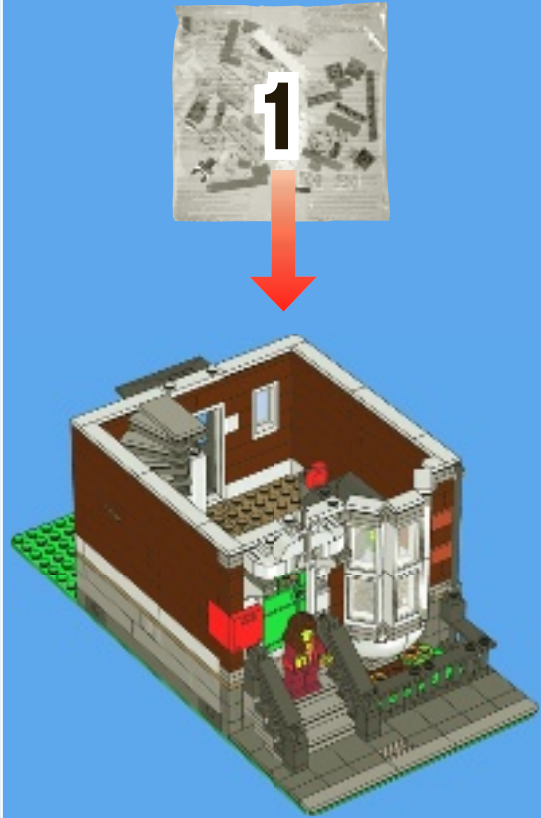

10218

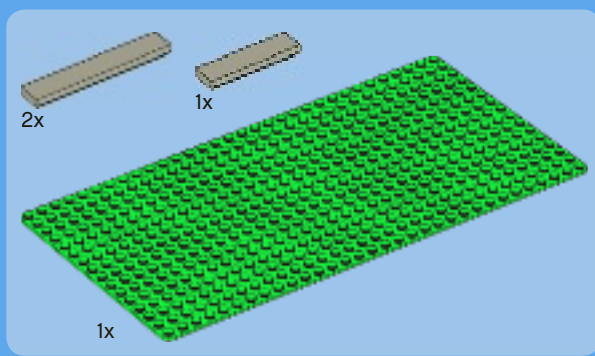





1

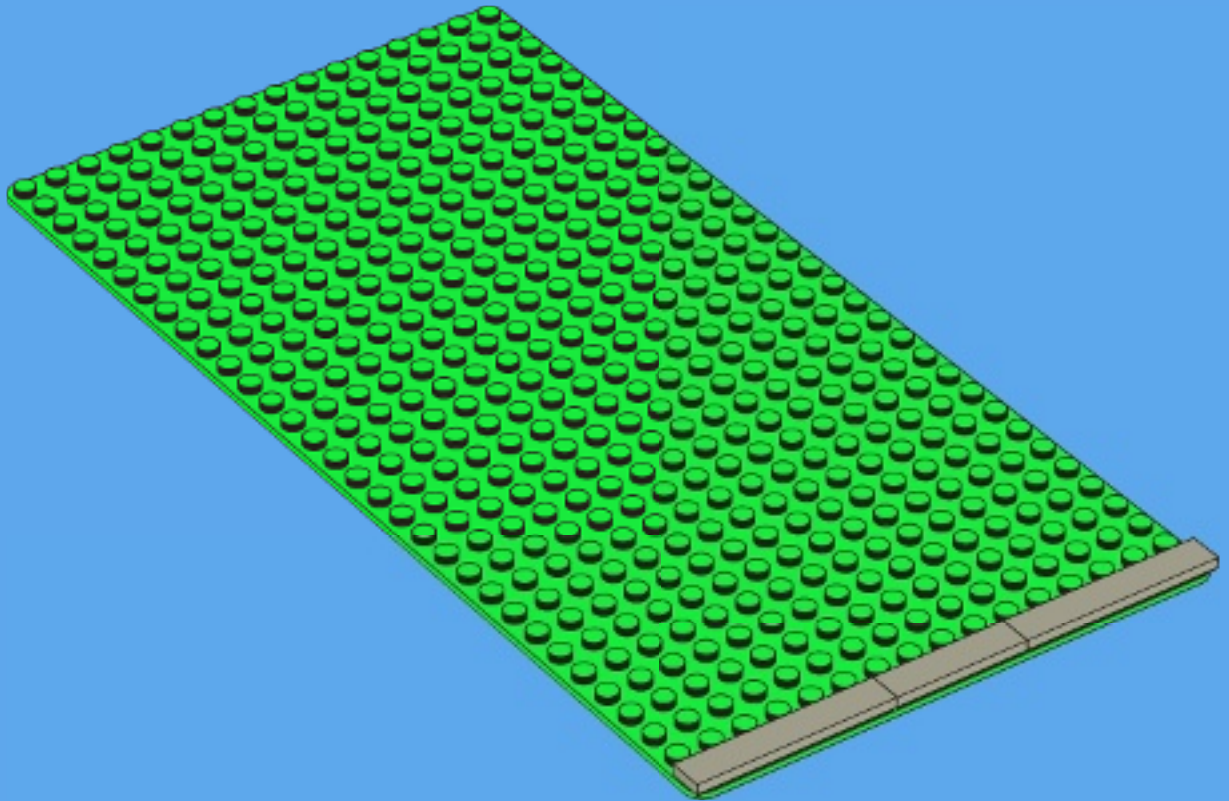

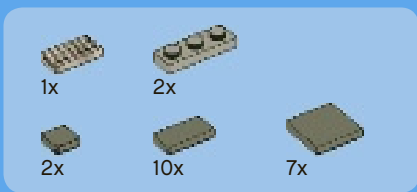

2

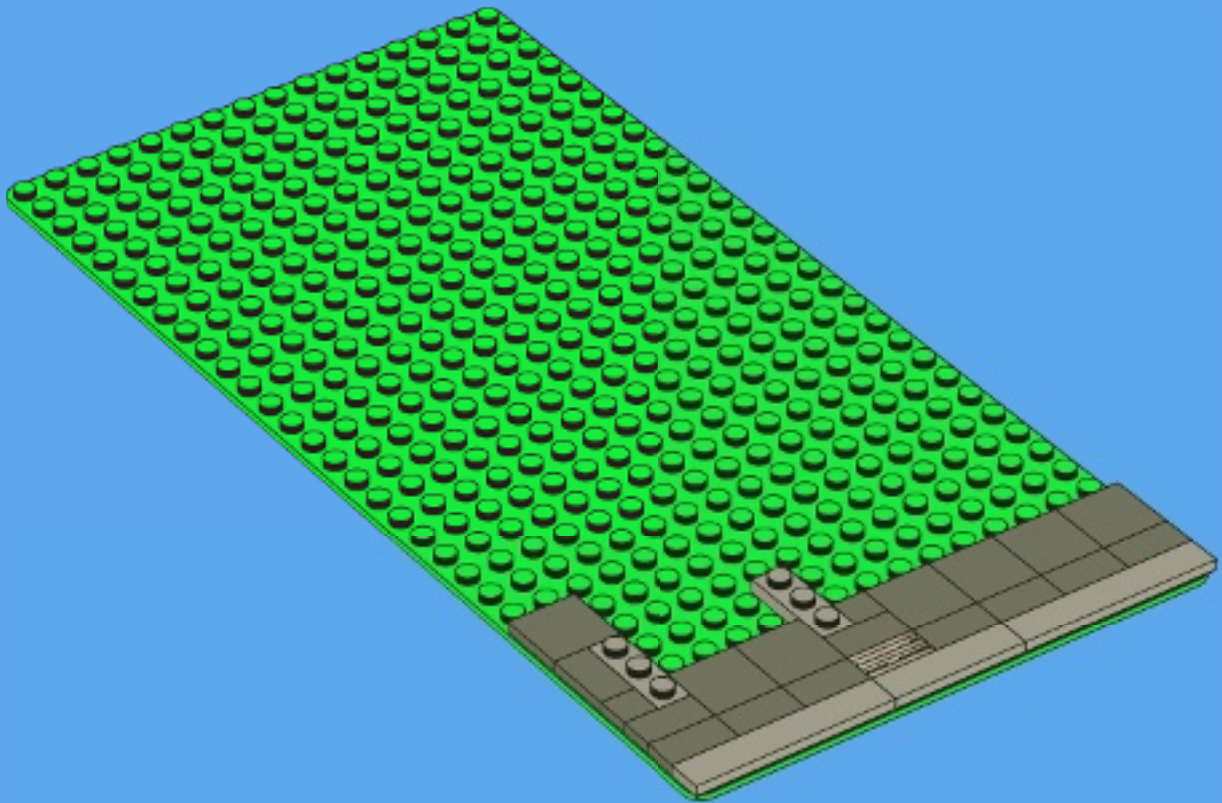

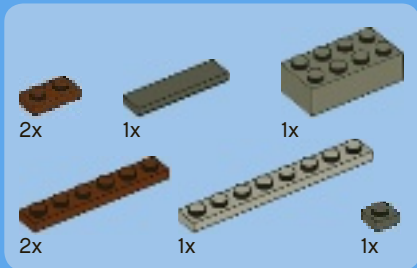

3

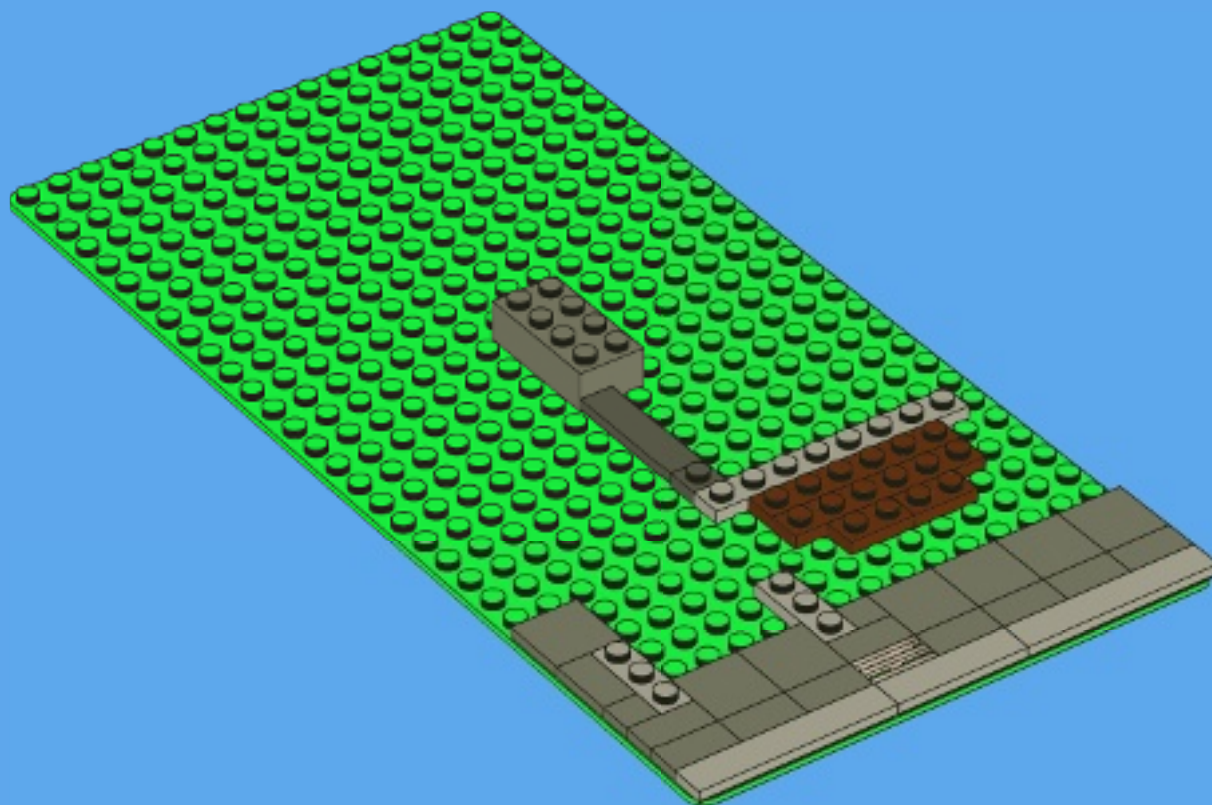

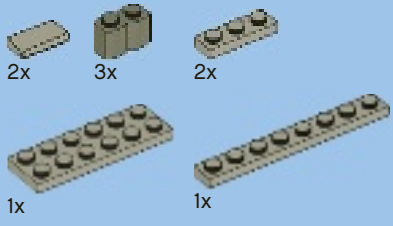

4

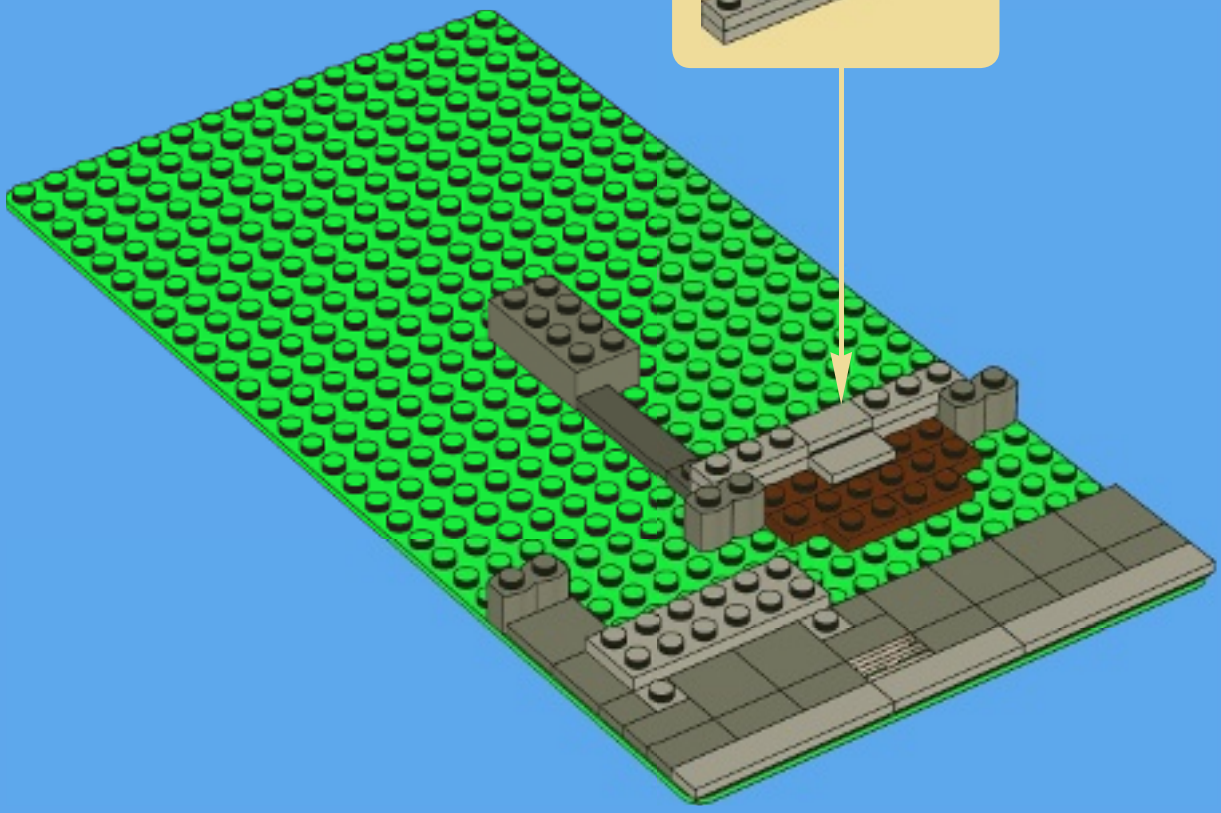
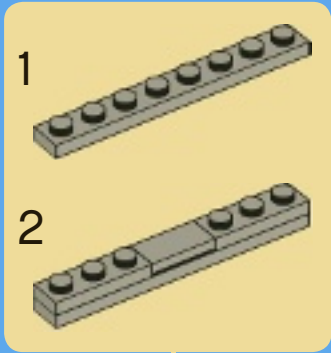

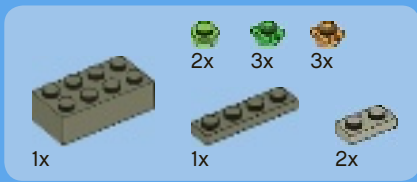

5

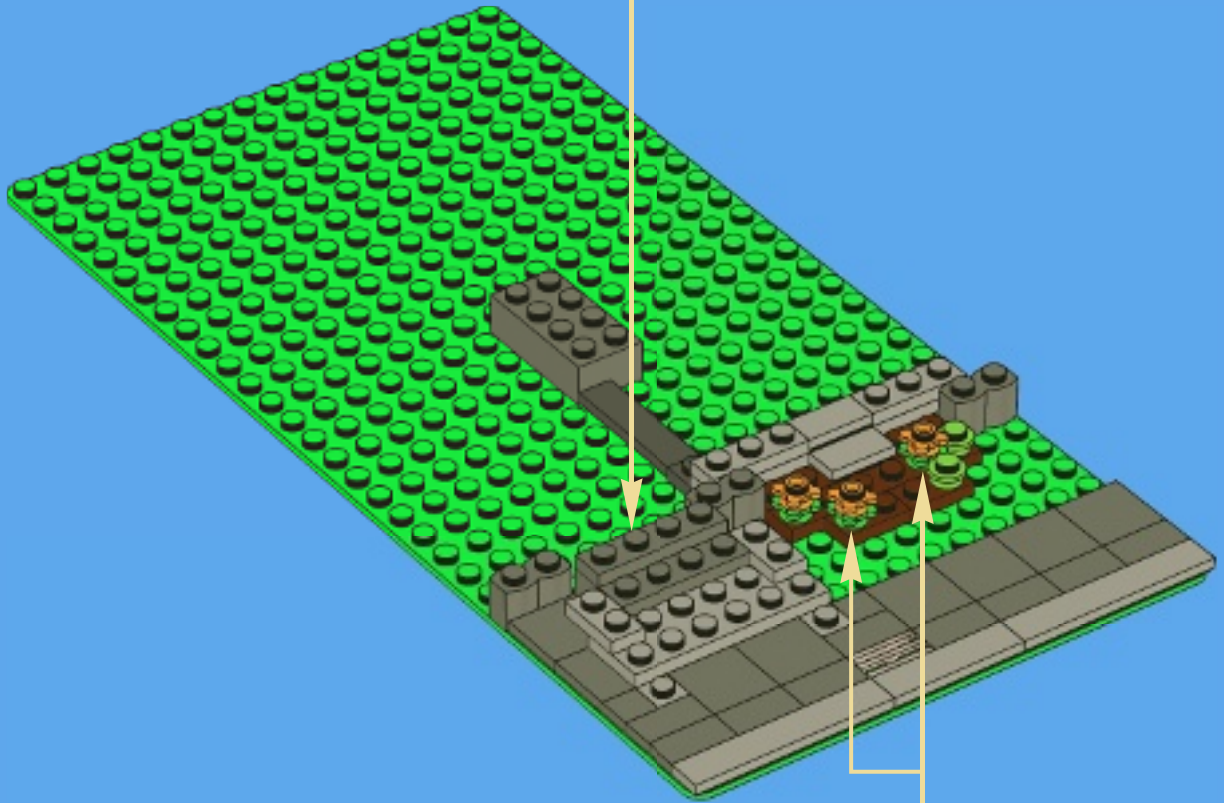
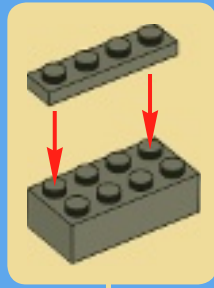

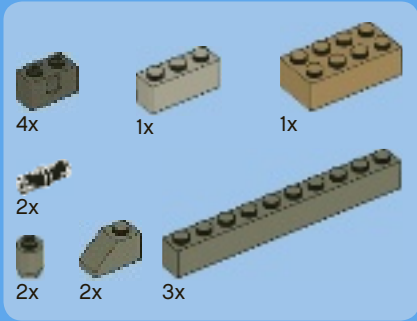

6

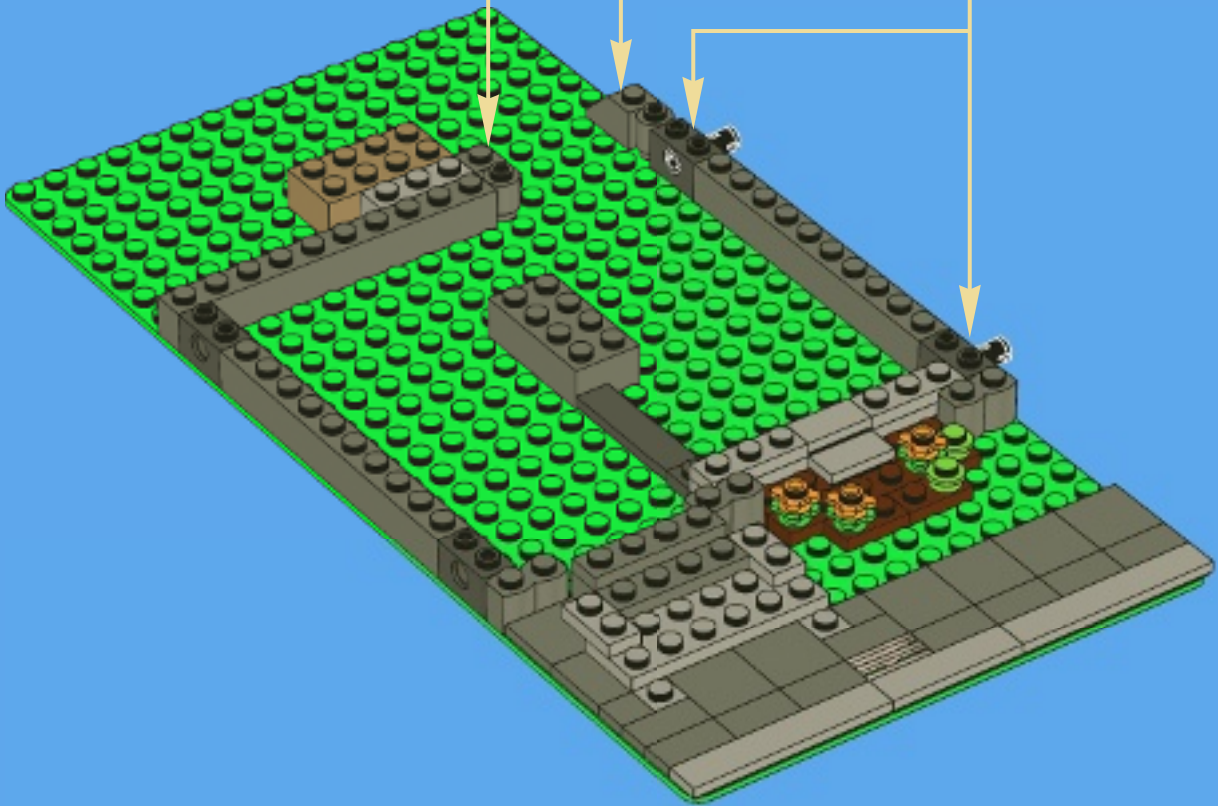
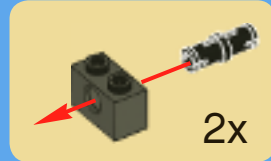
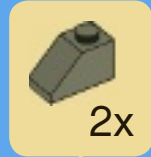



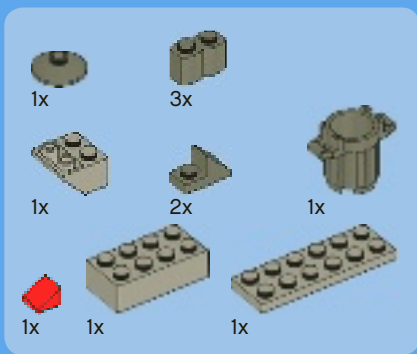

7

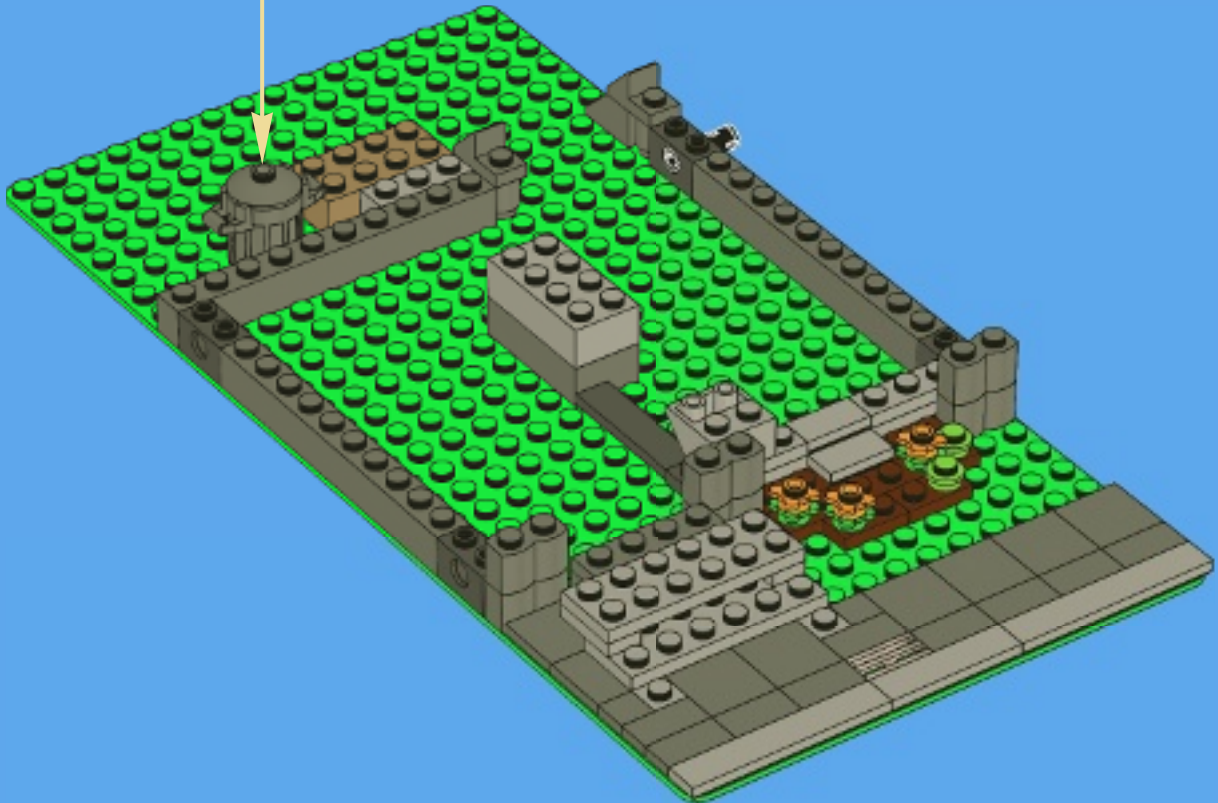
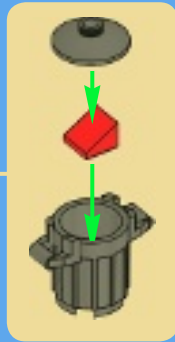



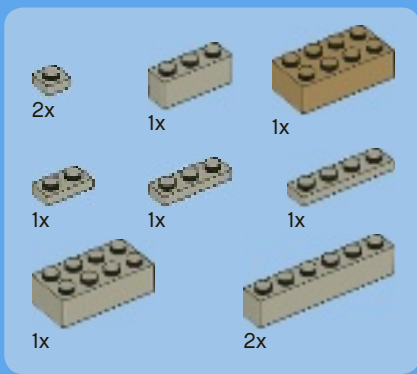

9

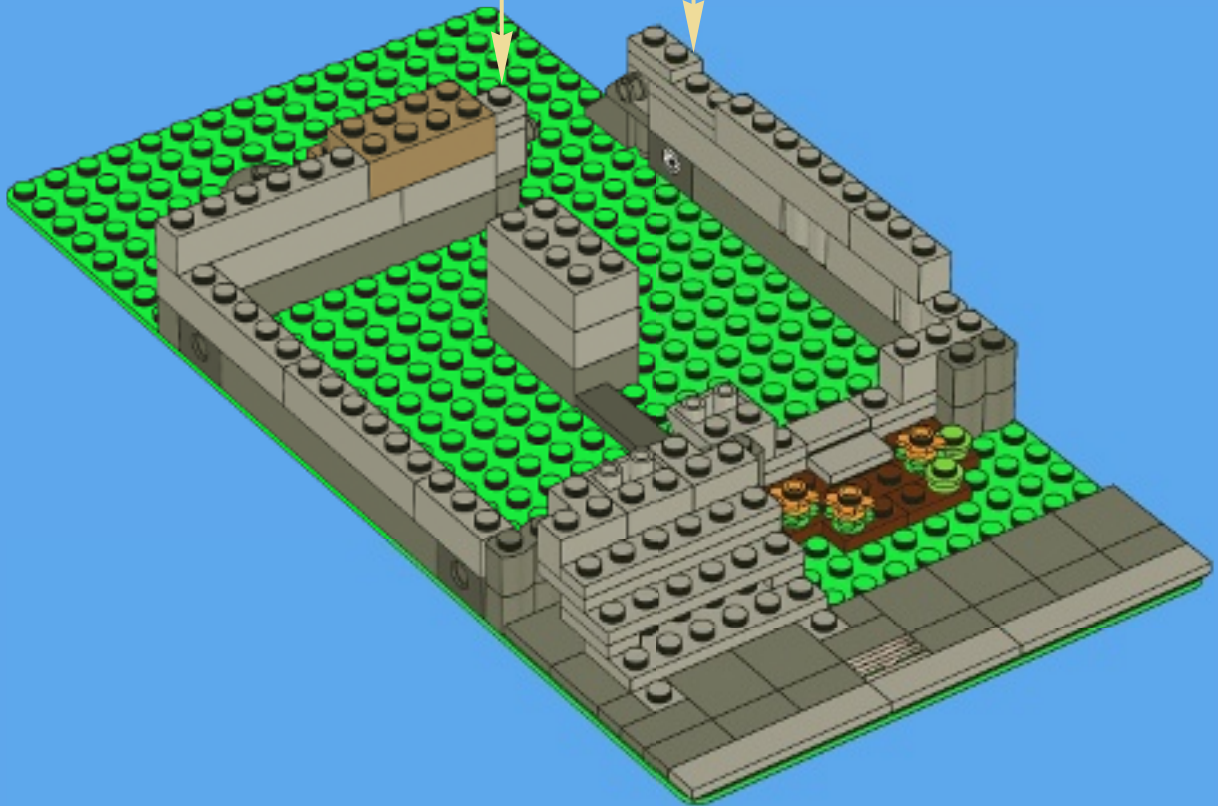
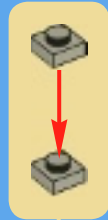
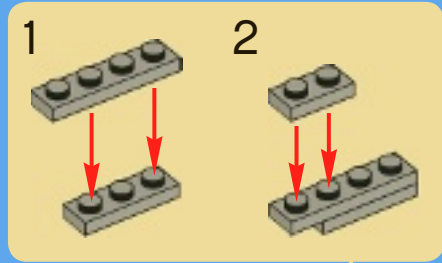

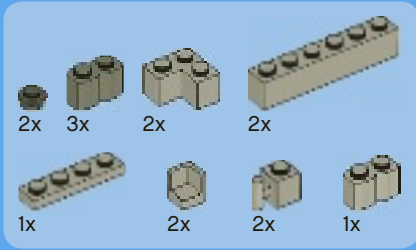

# 10

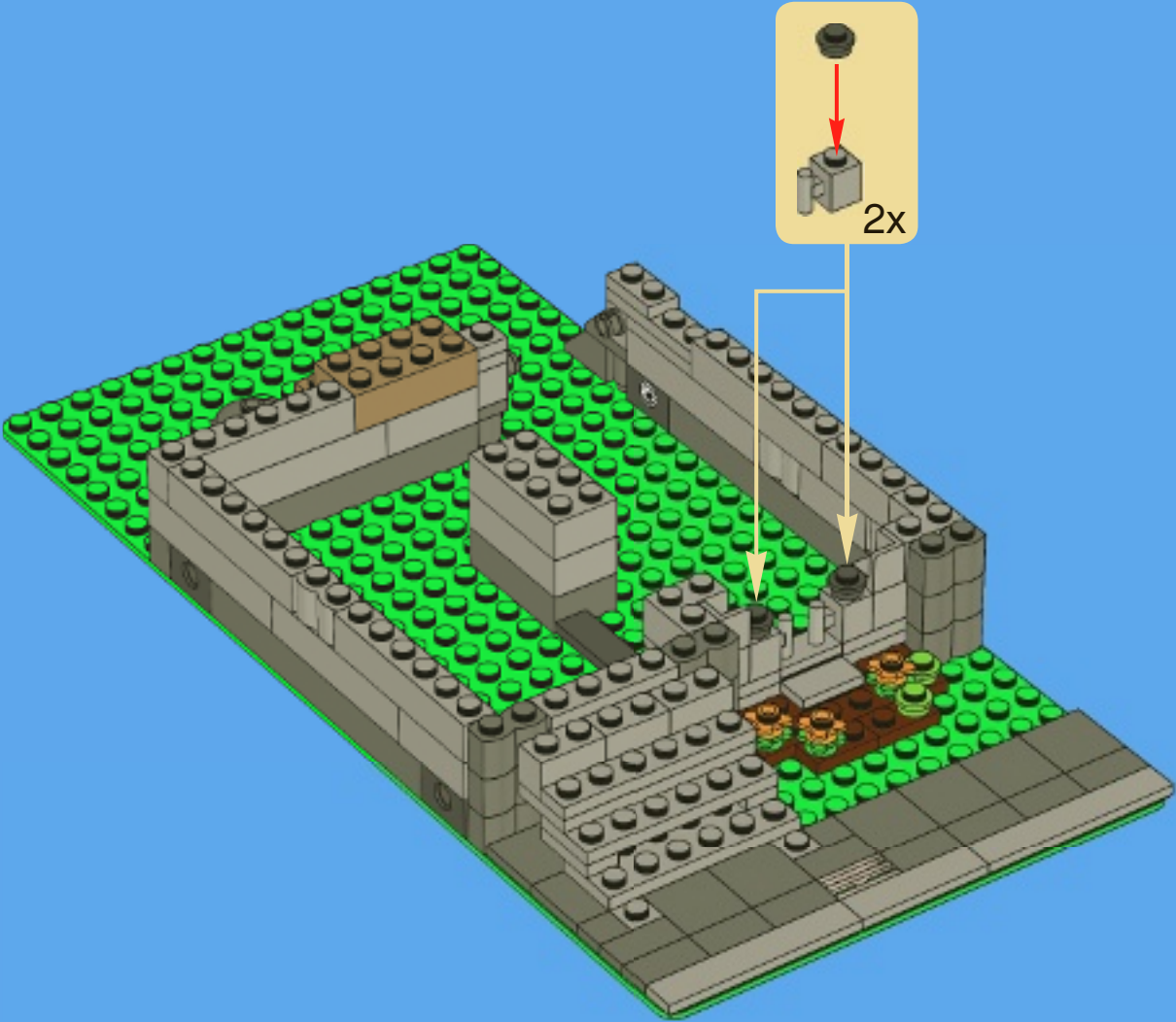

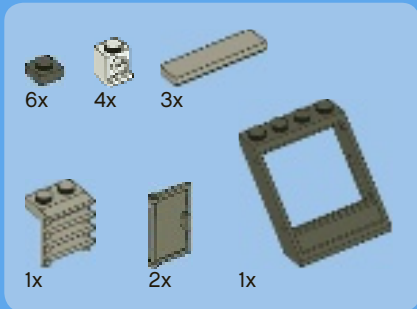

11

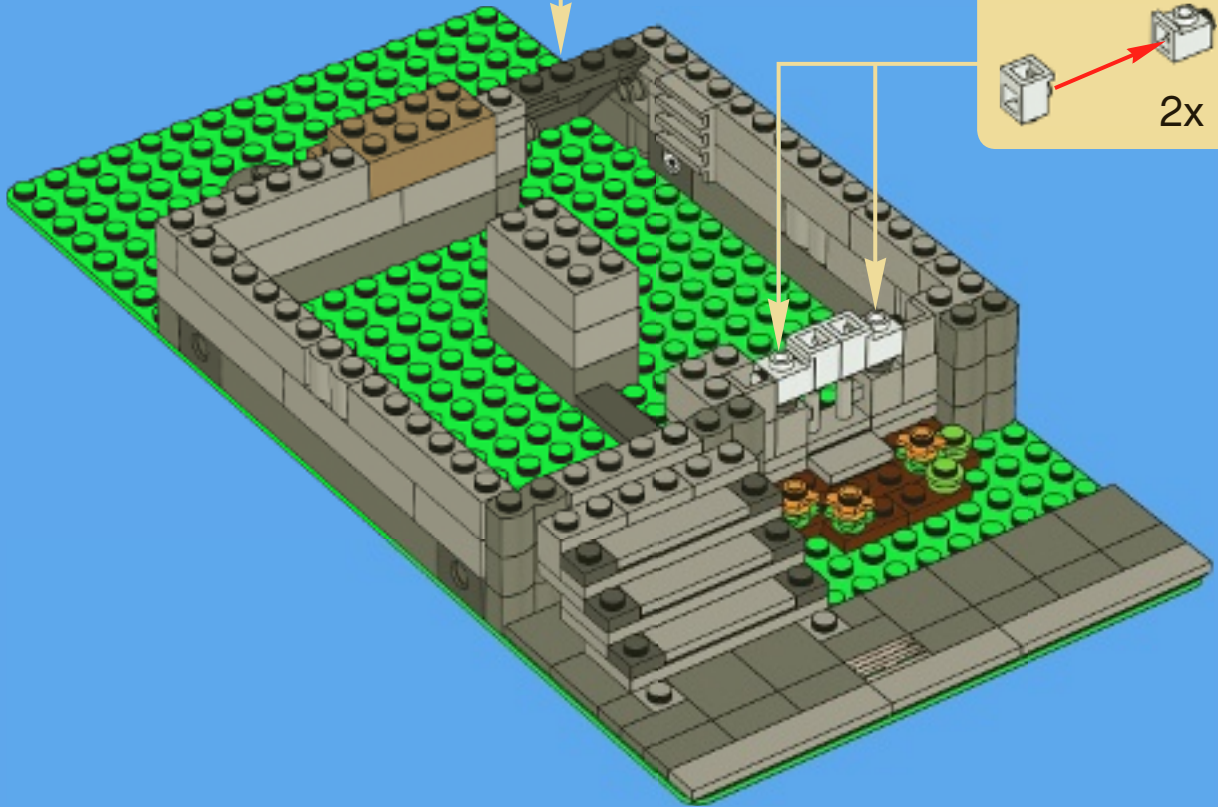
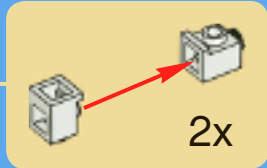
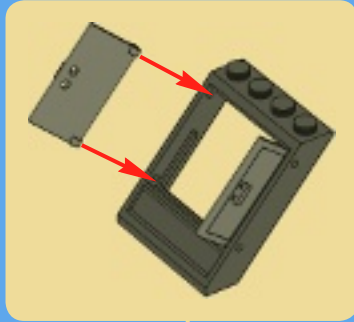

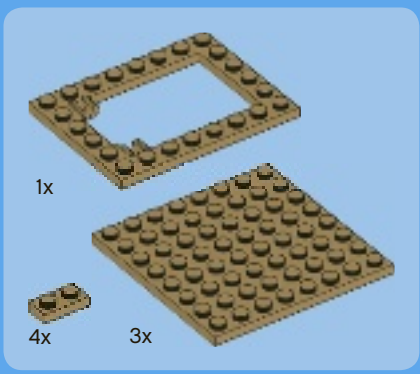

12

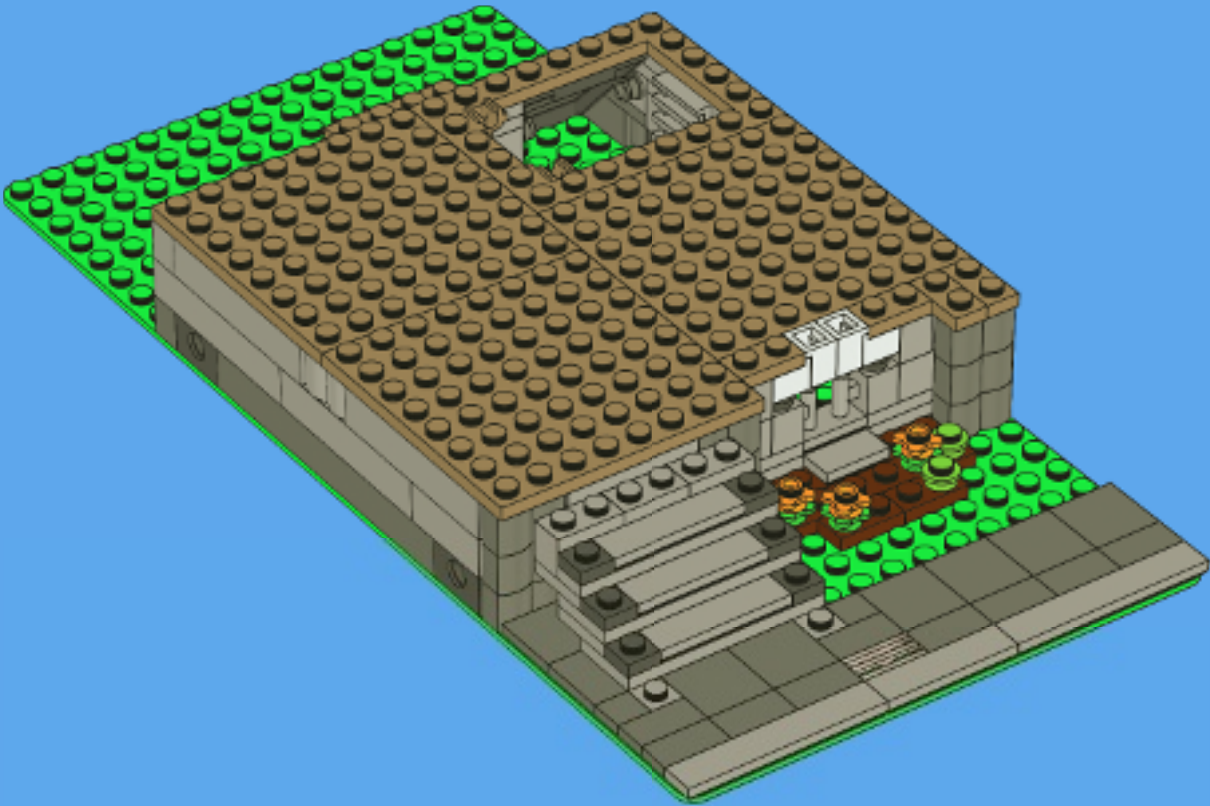

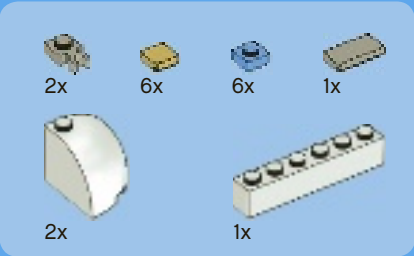

# 13

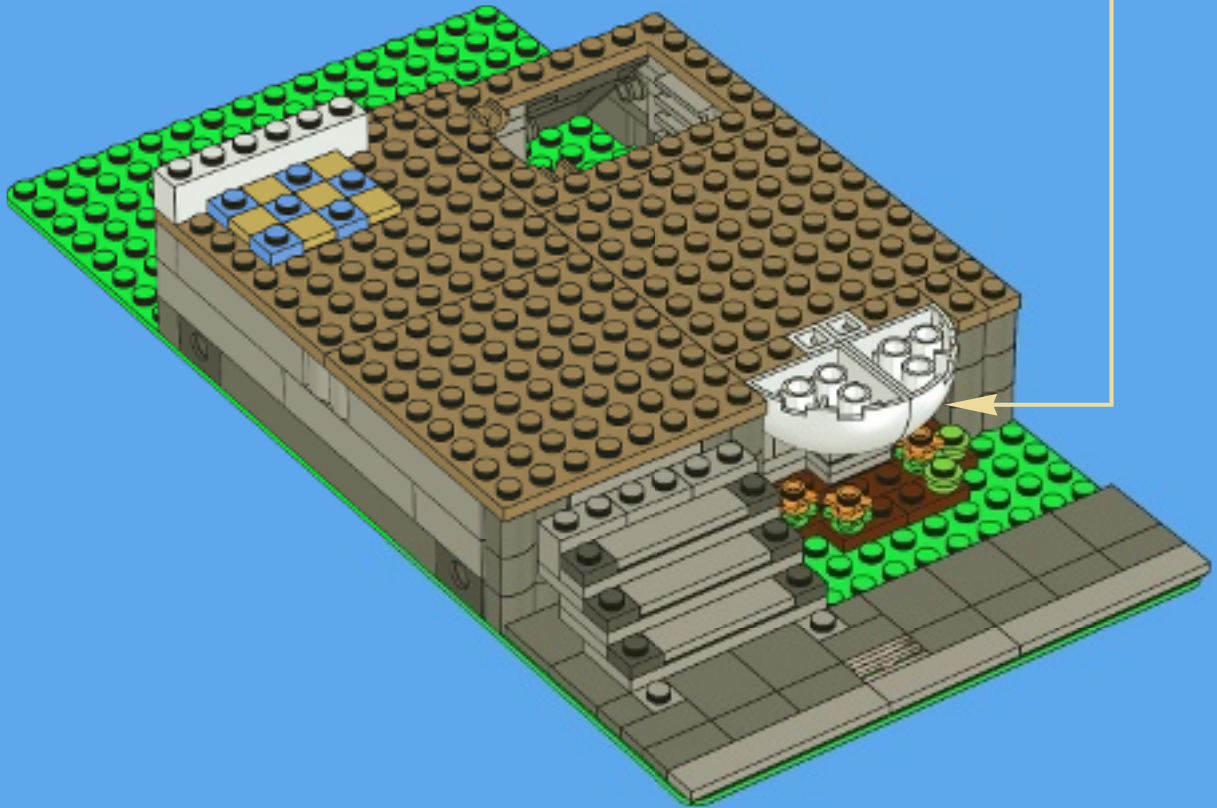
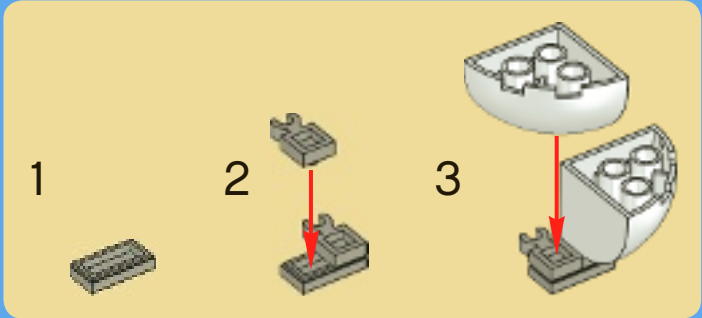





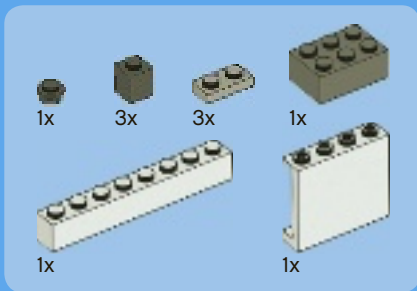

15

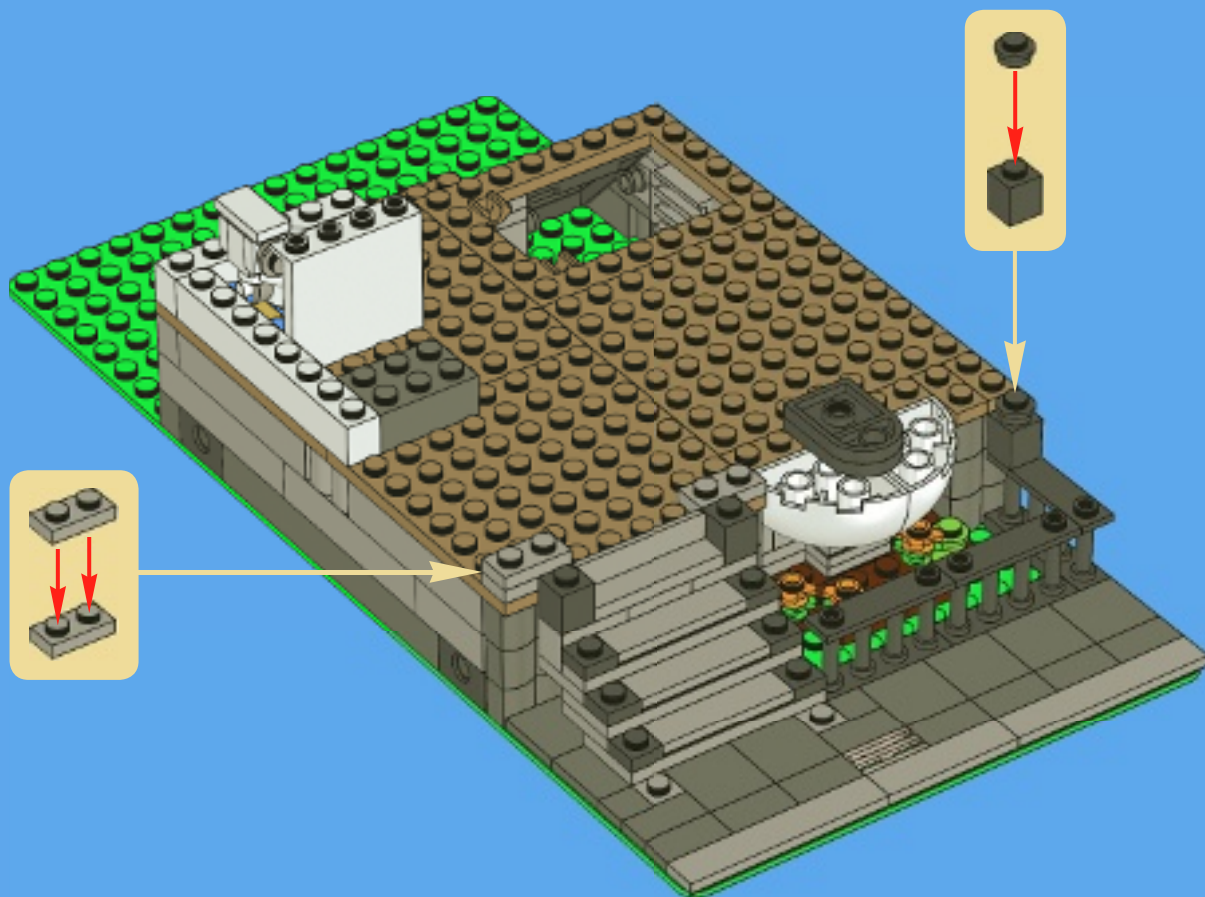

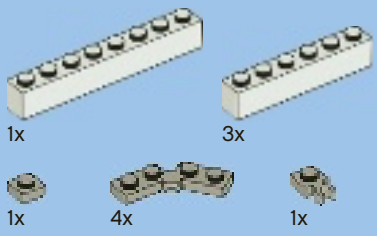

# 16

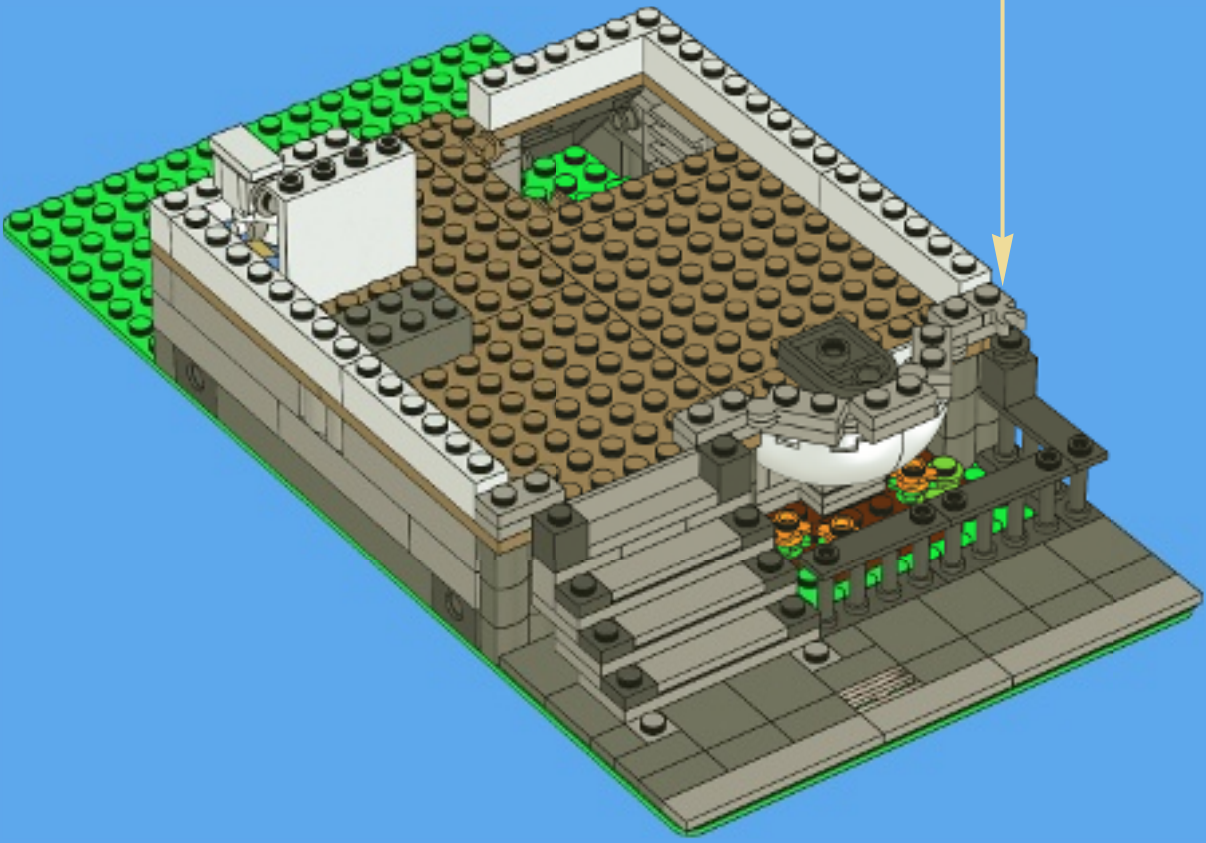
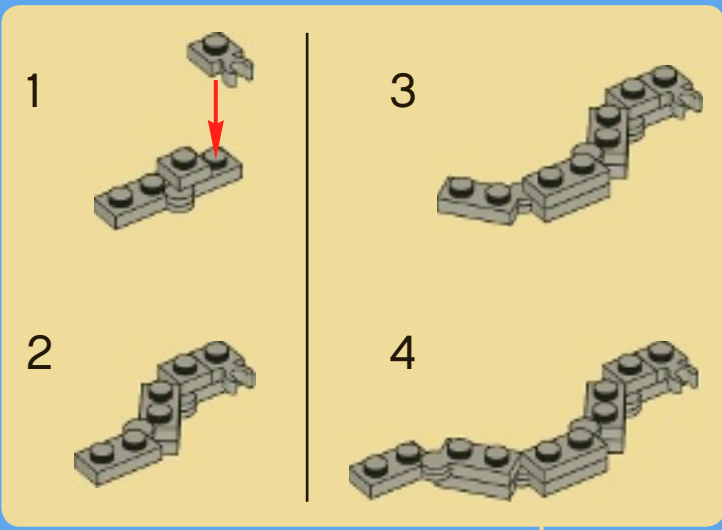



3x



1x



1x



6x



2x



4x

# 17

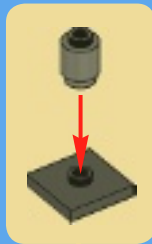

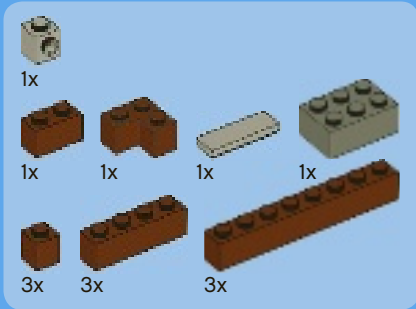

# 18



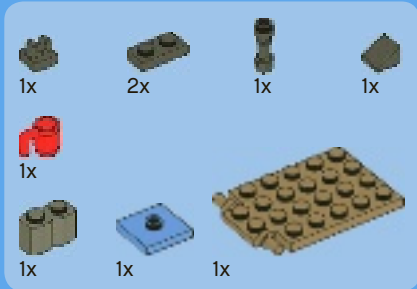

# 19

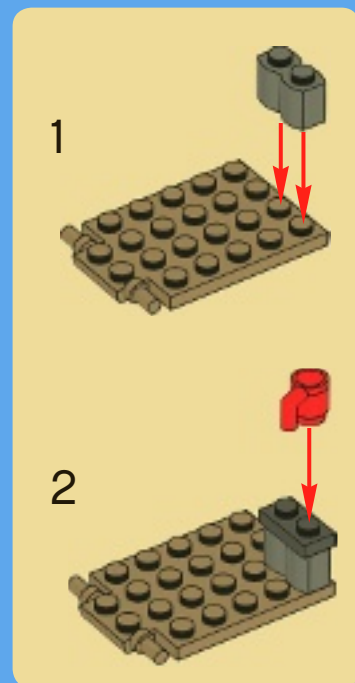
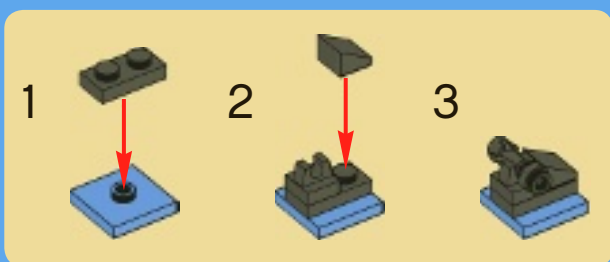



1

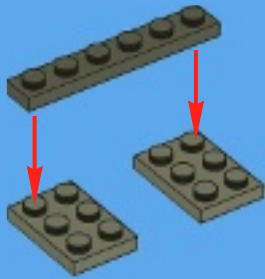

2

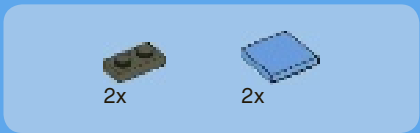
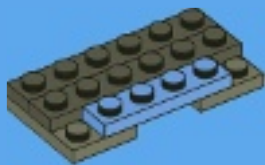

3

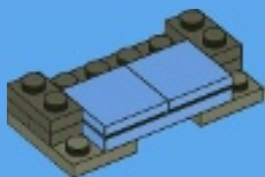

4

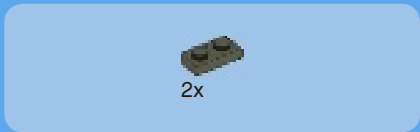
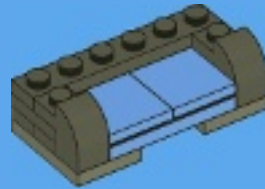

5

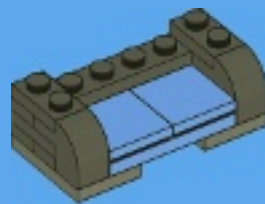

6





1x



2x

7

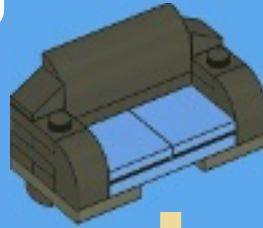

20



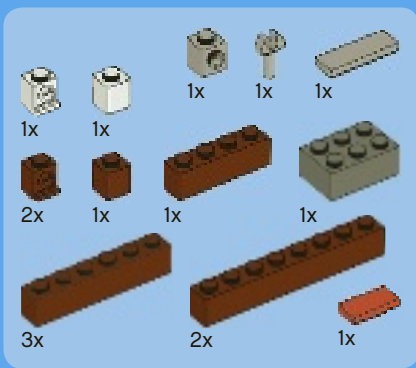

# 21

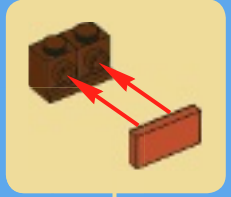
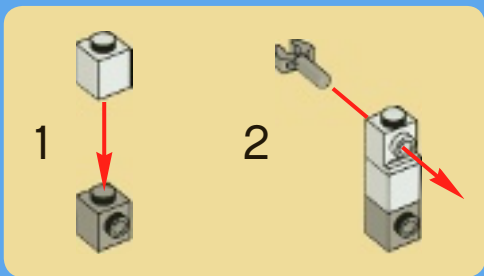



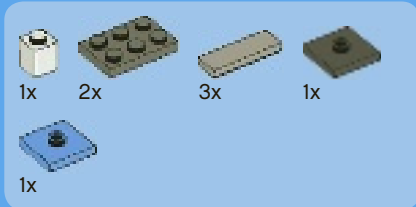

# 22

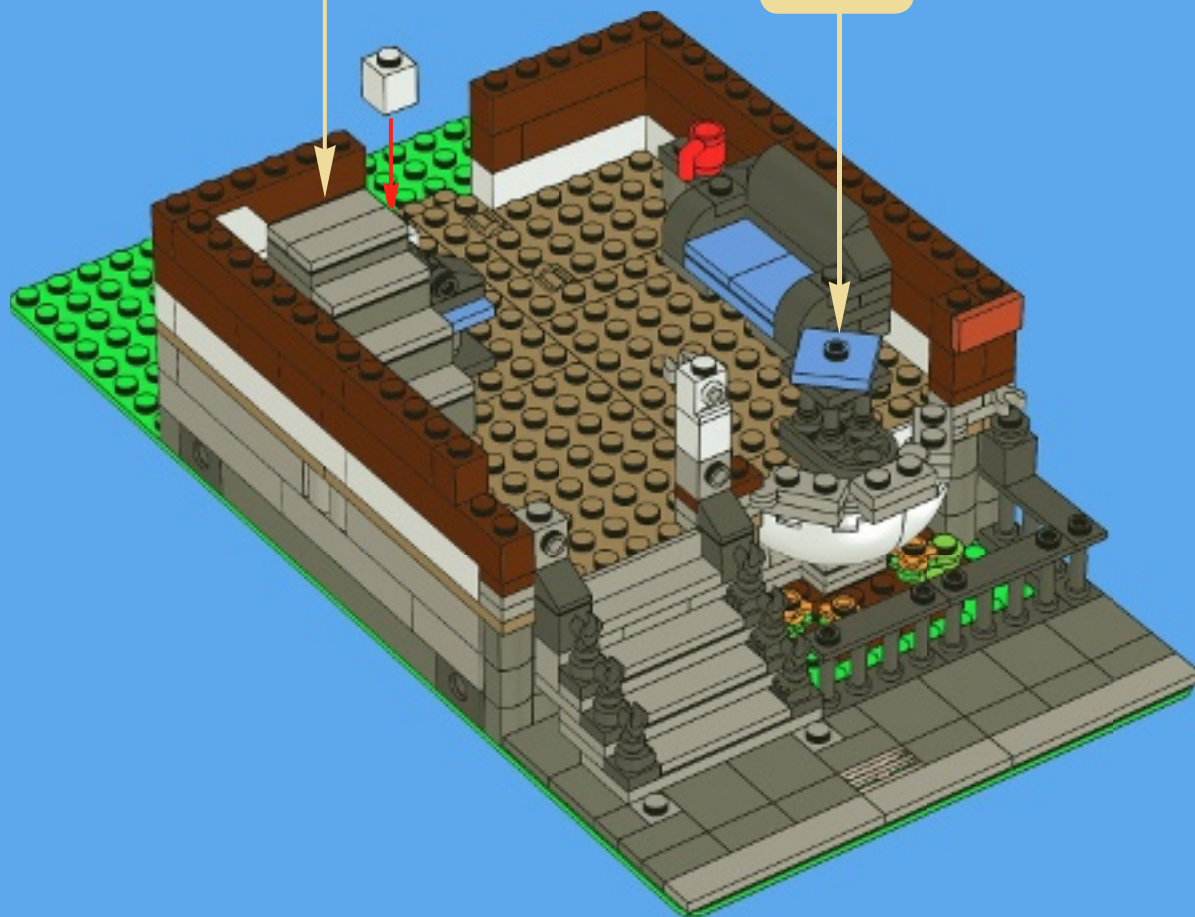
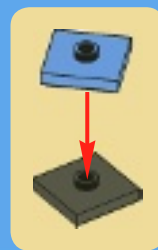
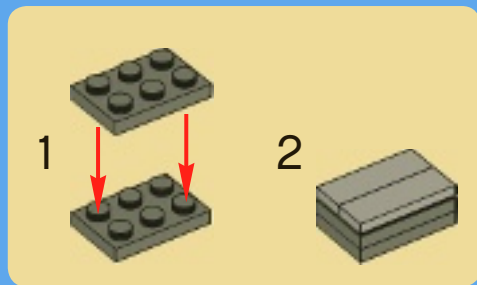

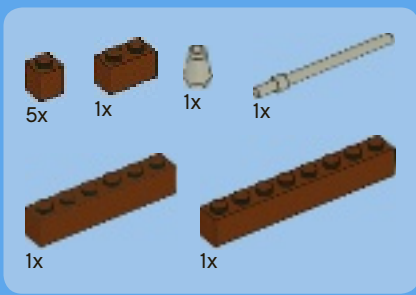

23

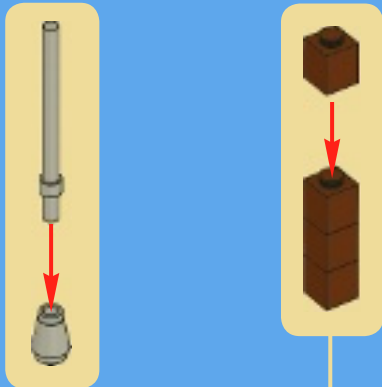

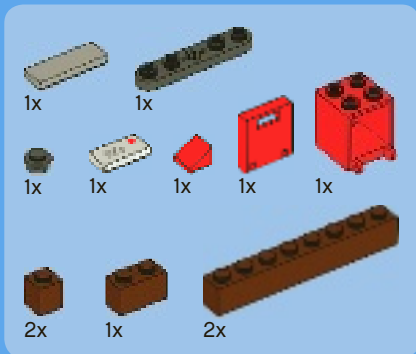

# 24

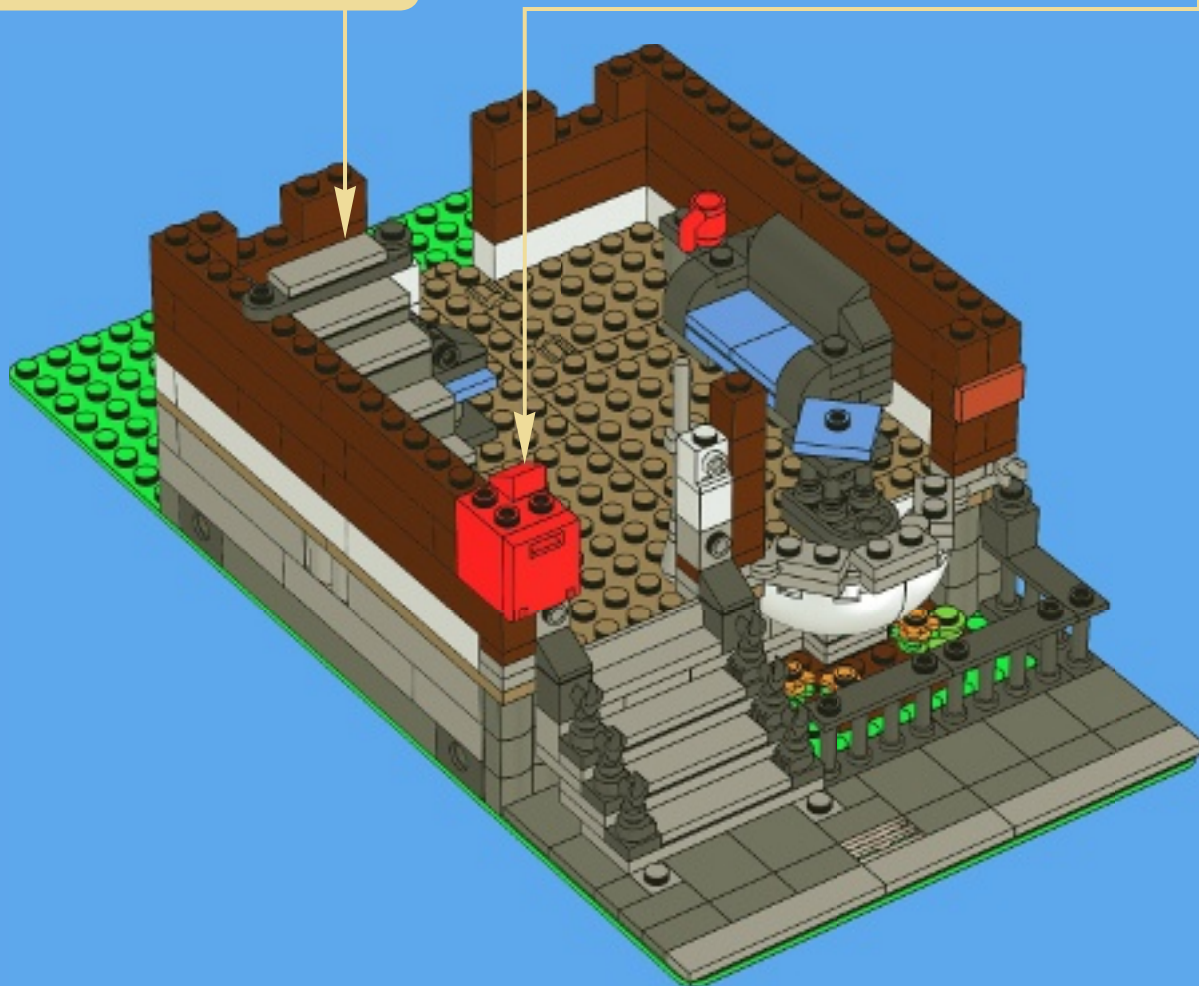
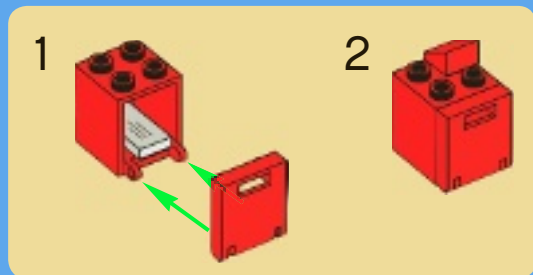
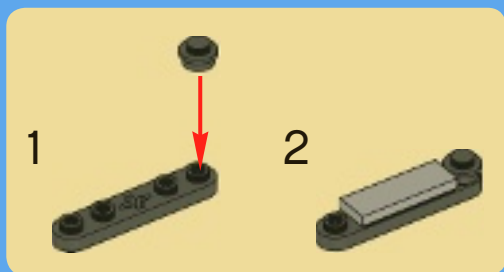

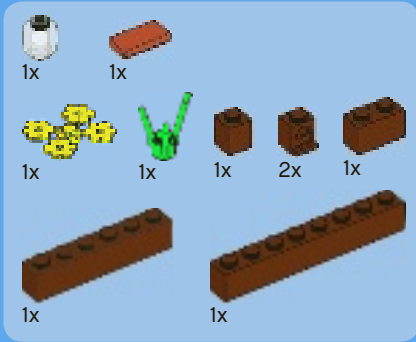

25

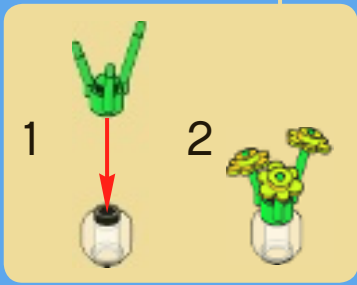
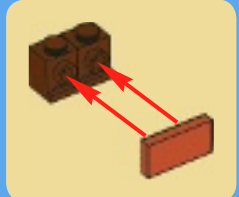
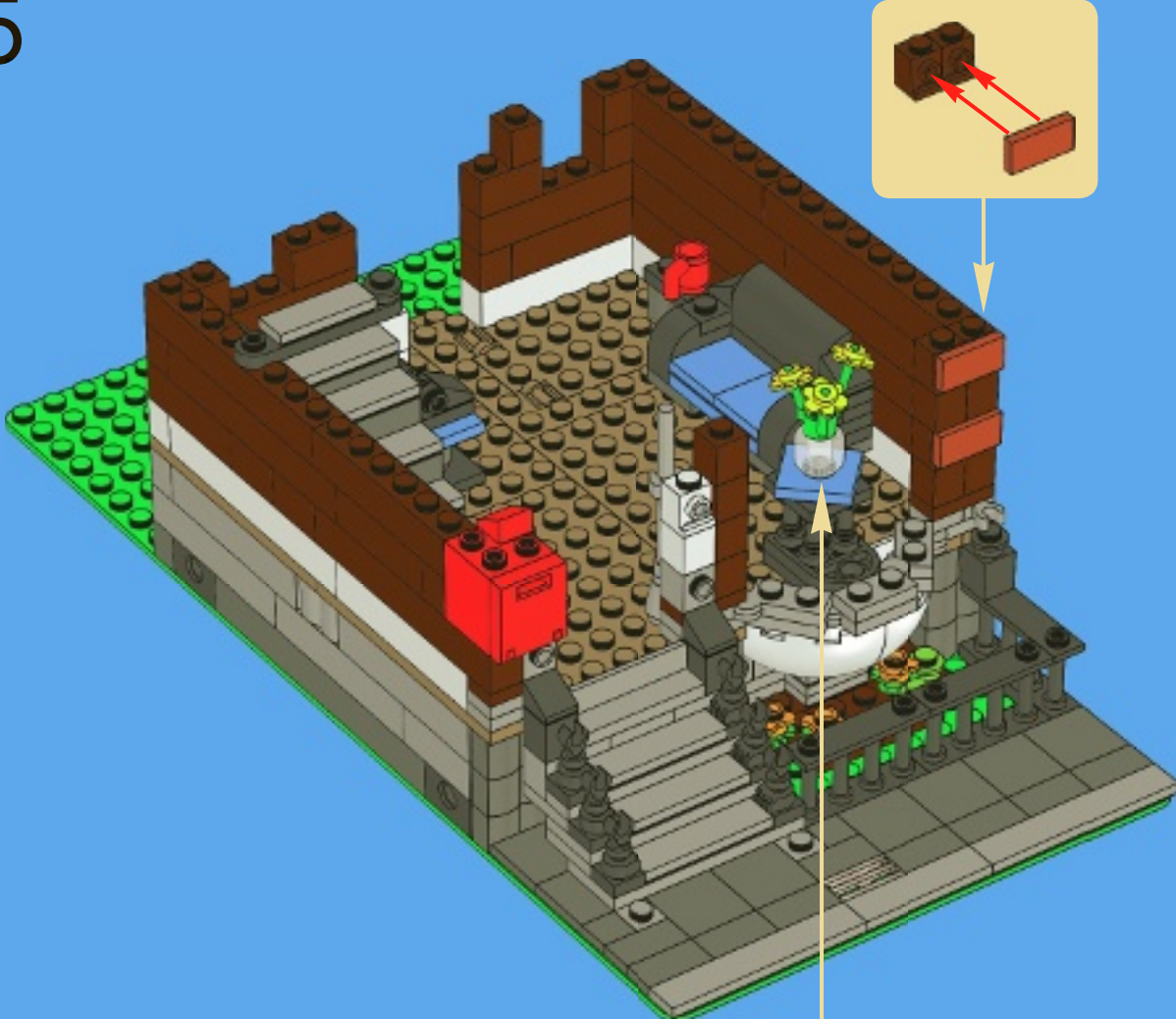



26

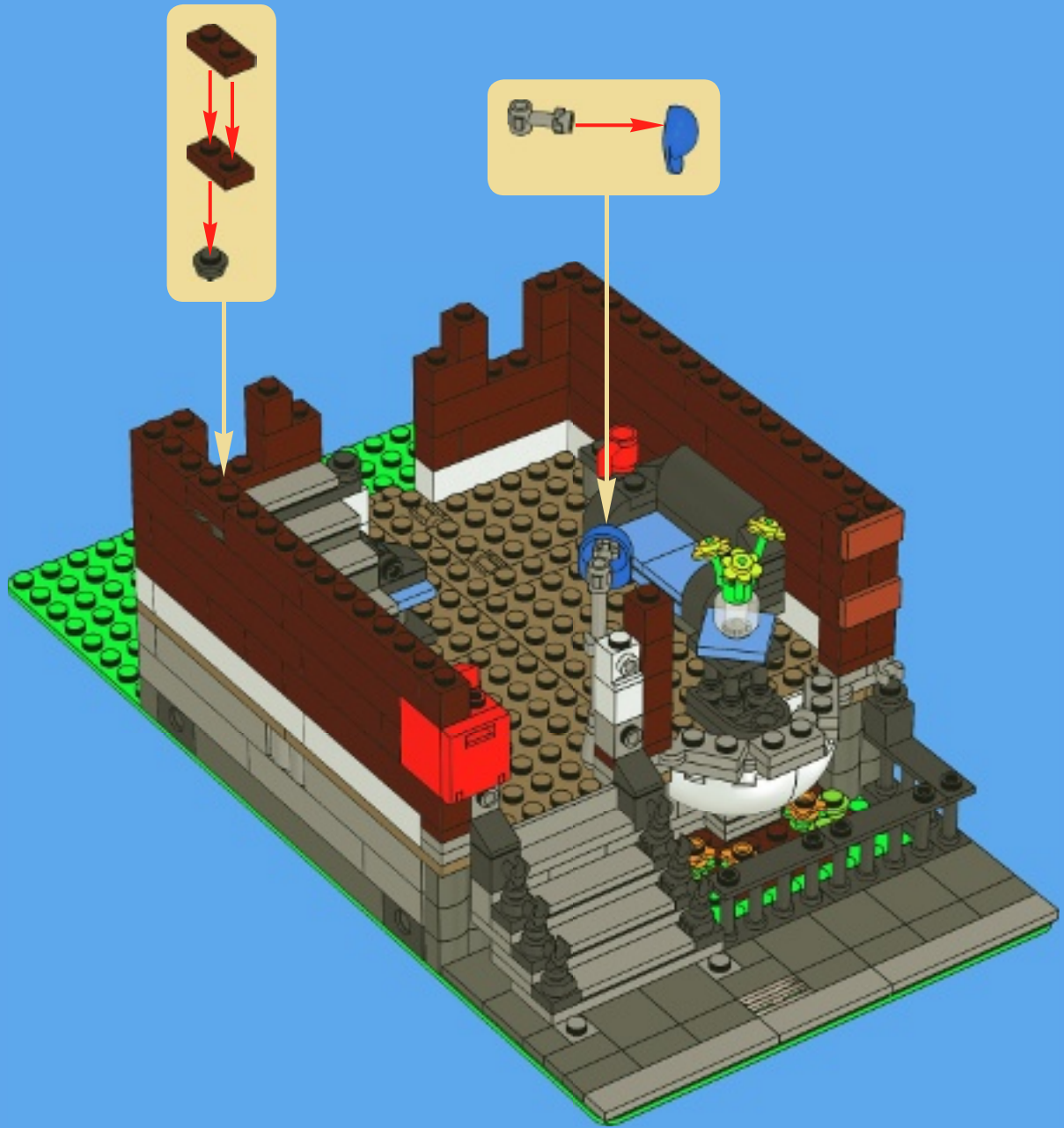



2x



2x



4x

# 27

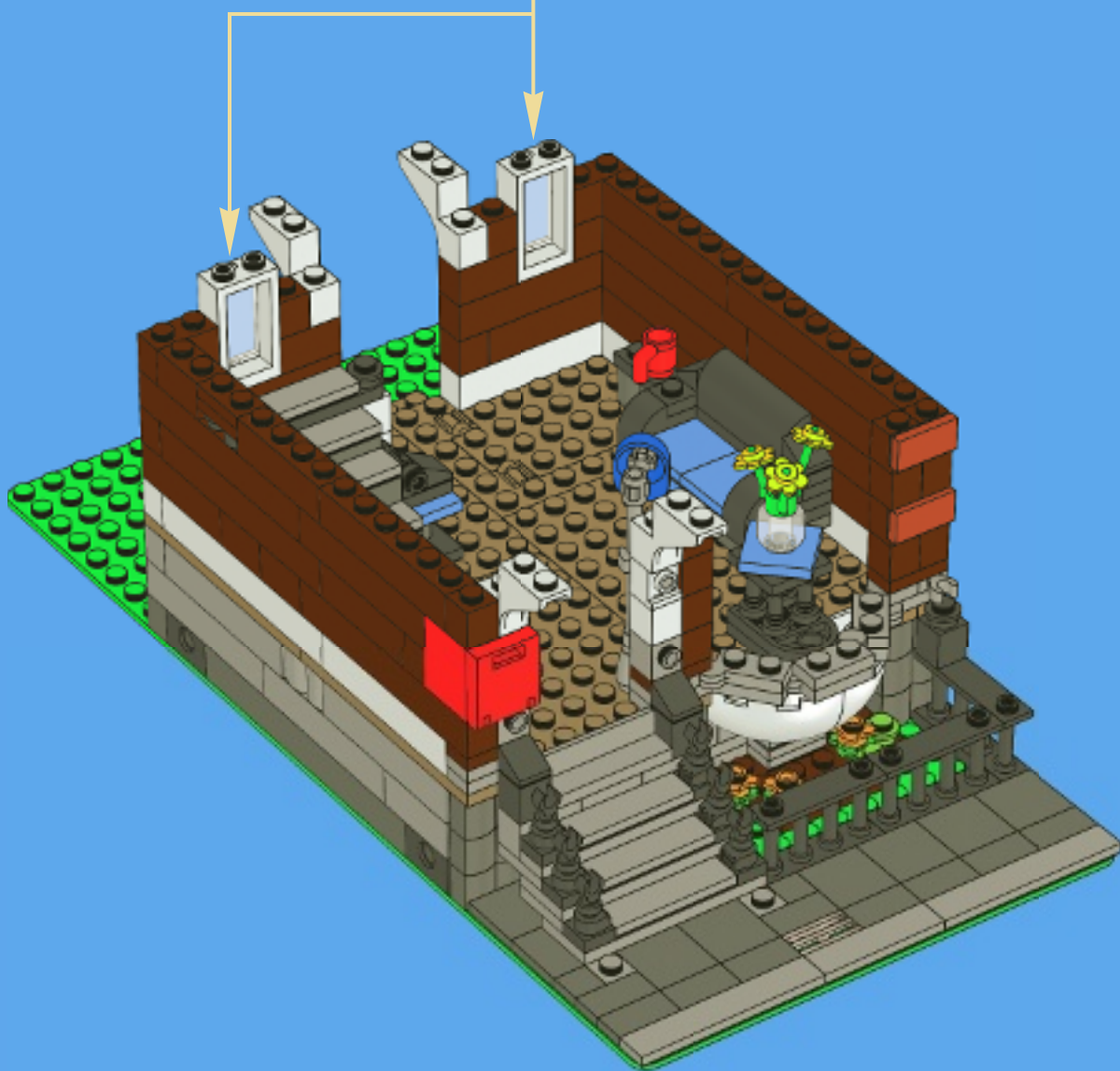
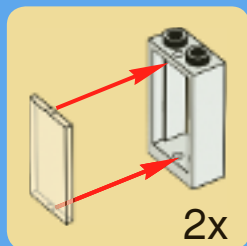

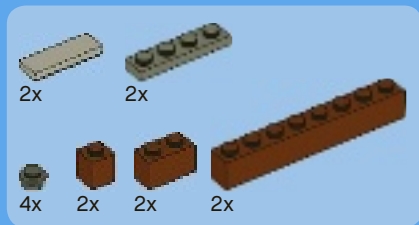

# 28

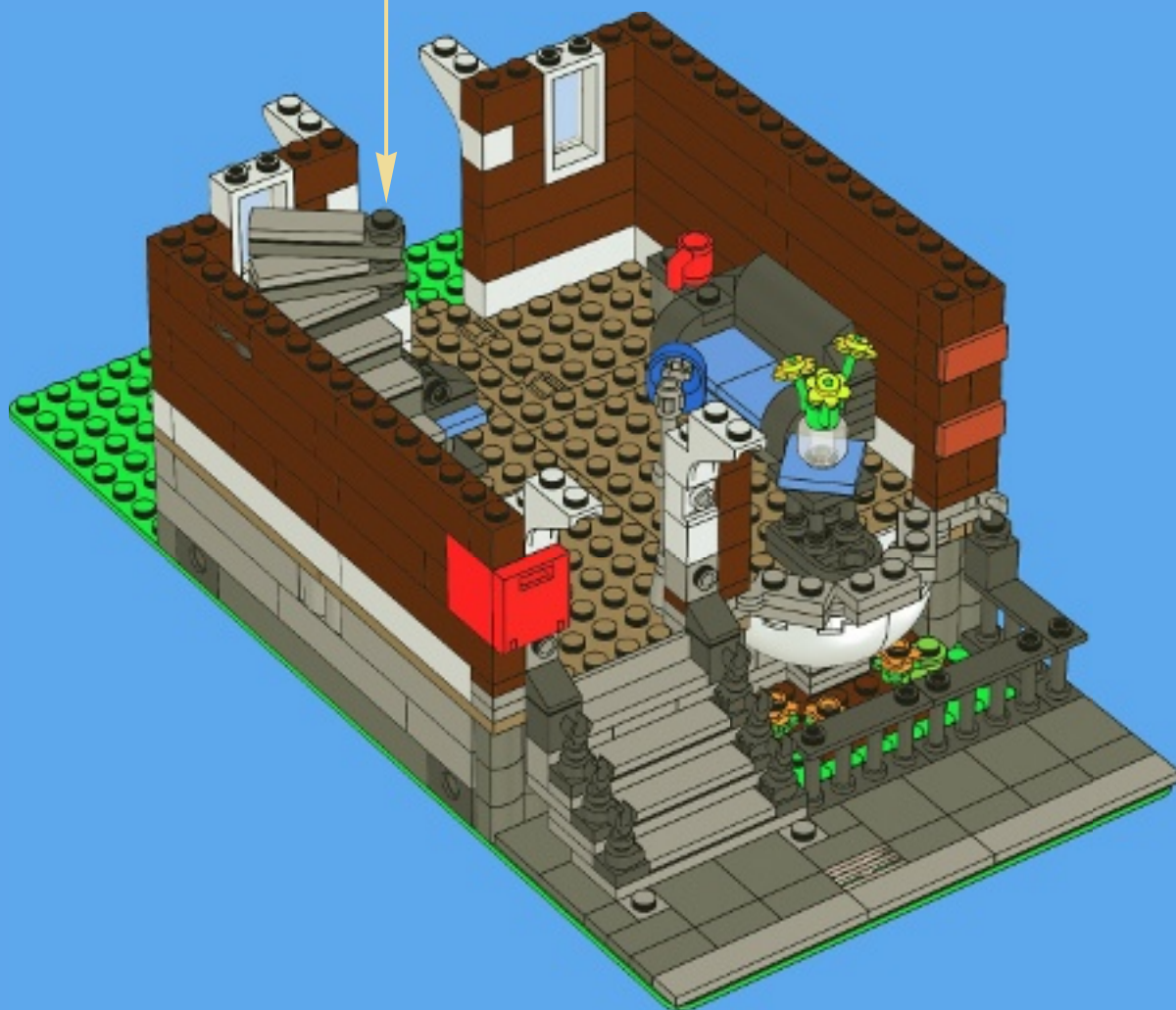
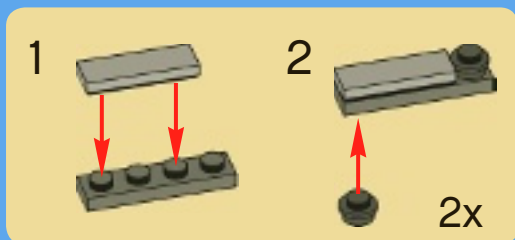

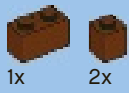

1x 2x

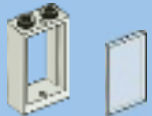

6x 6x



2x

# 29

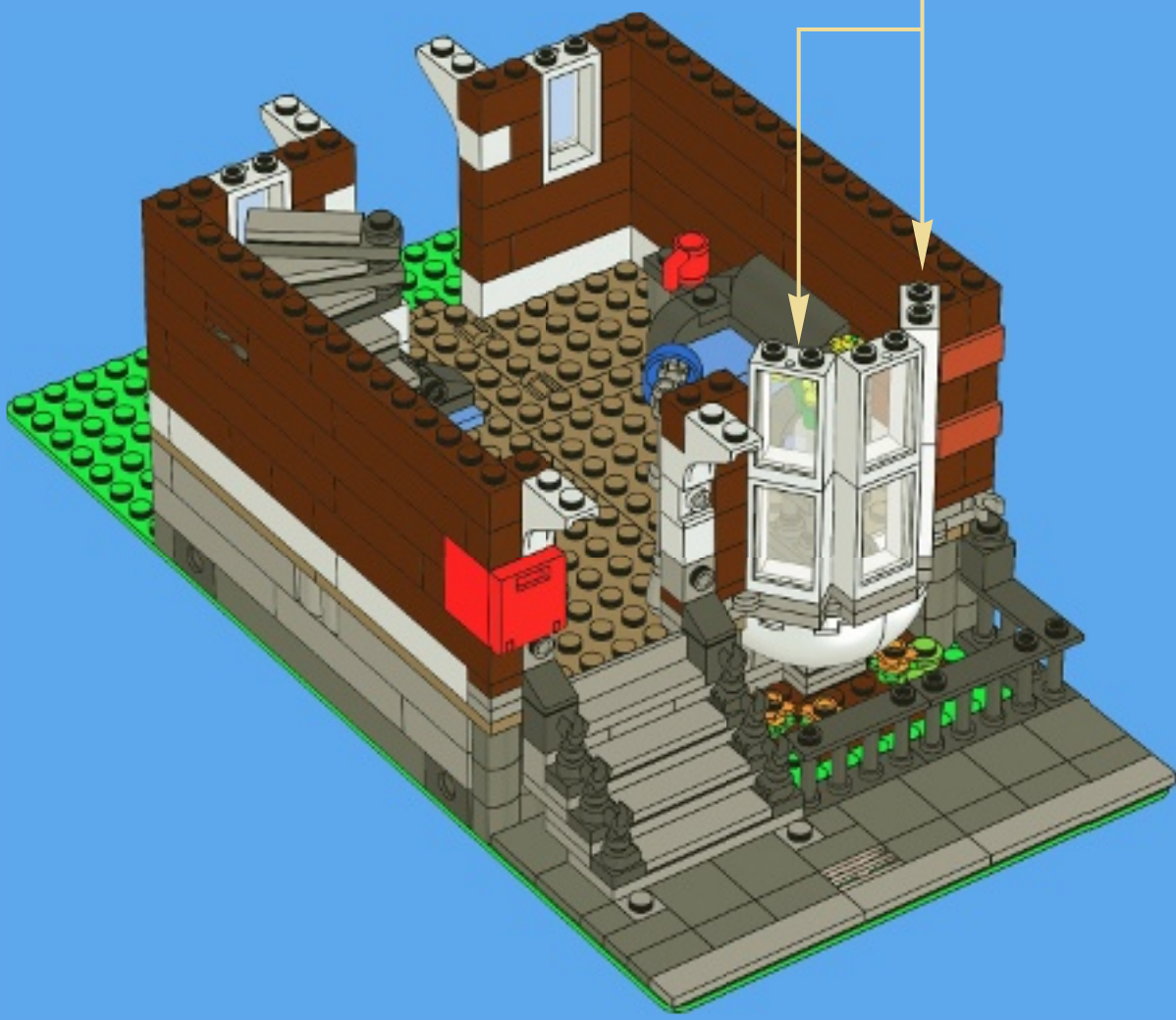
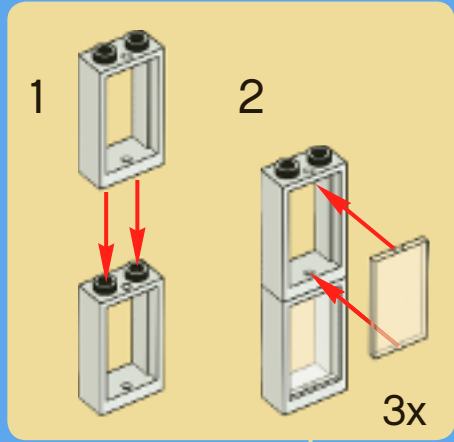



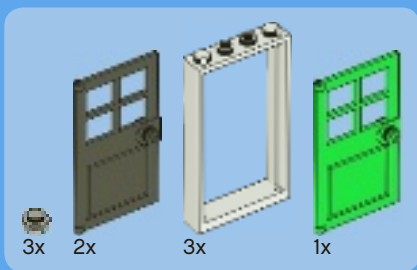

# 30

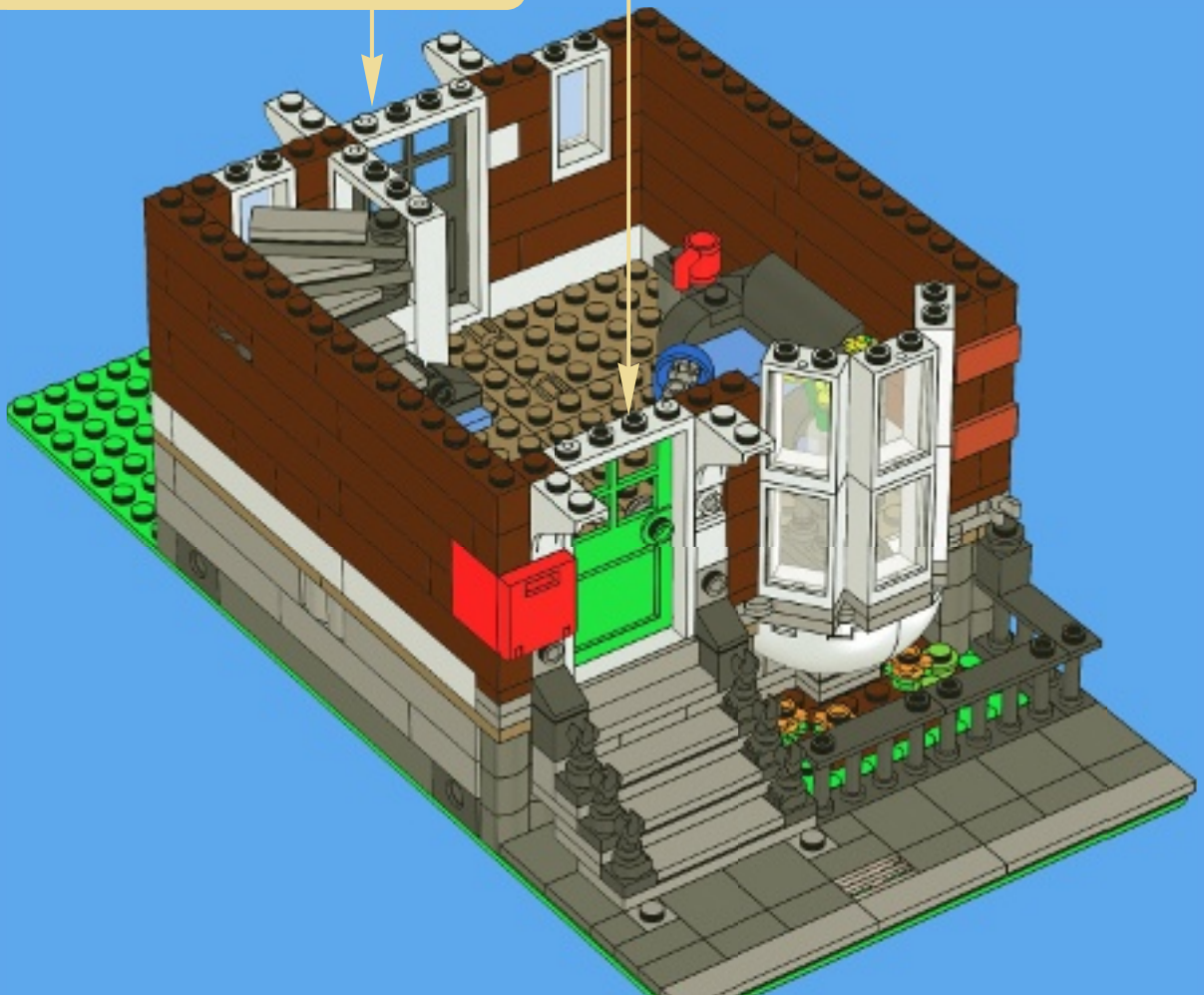
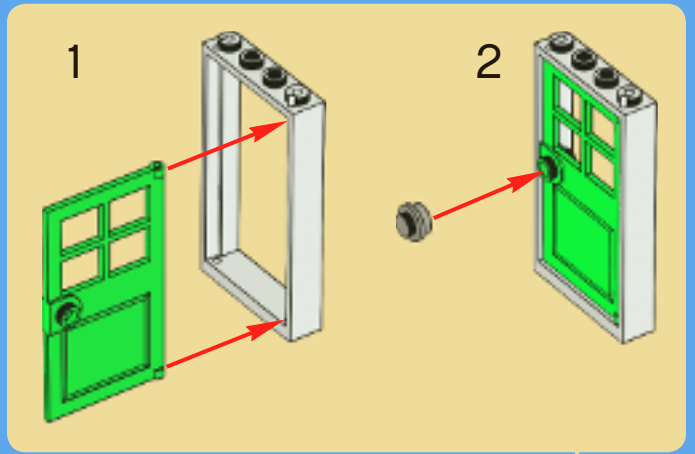
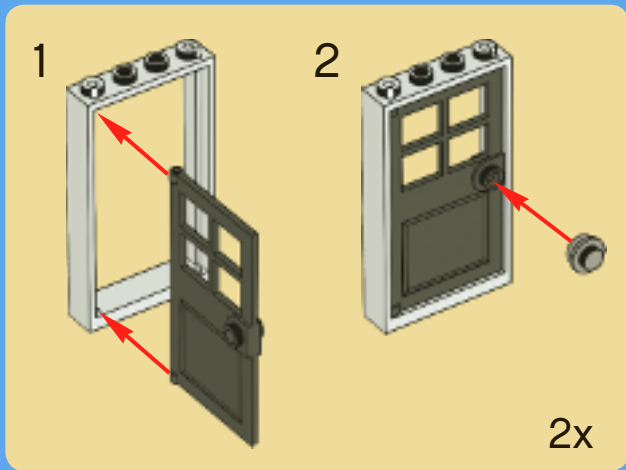

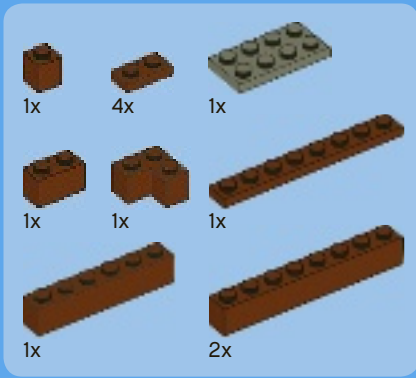

# 31

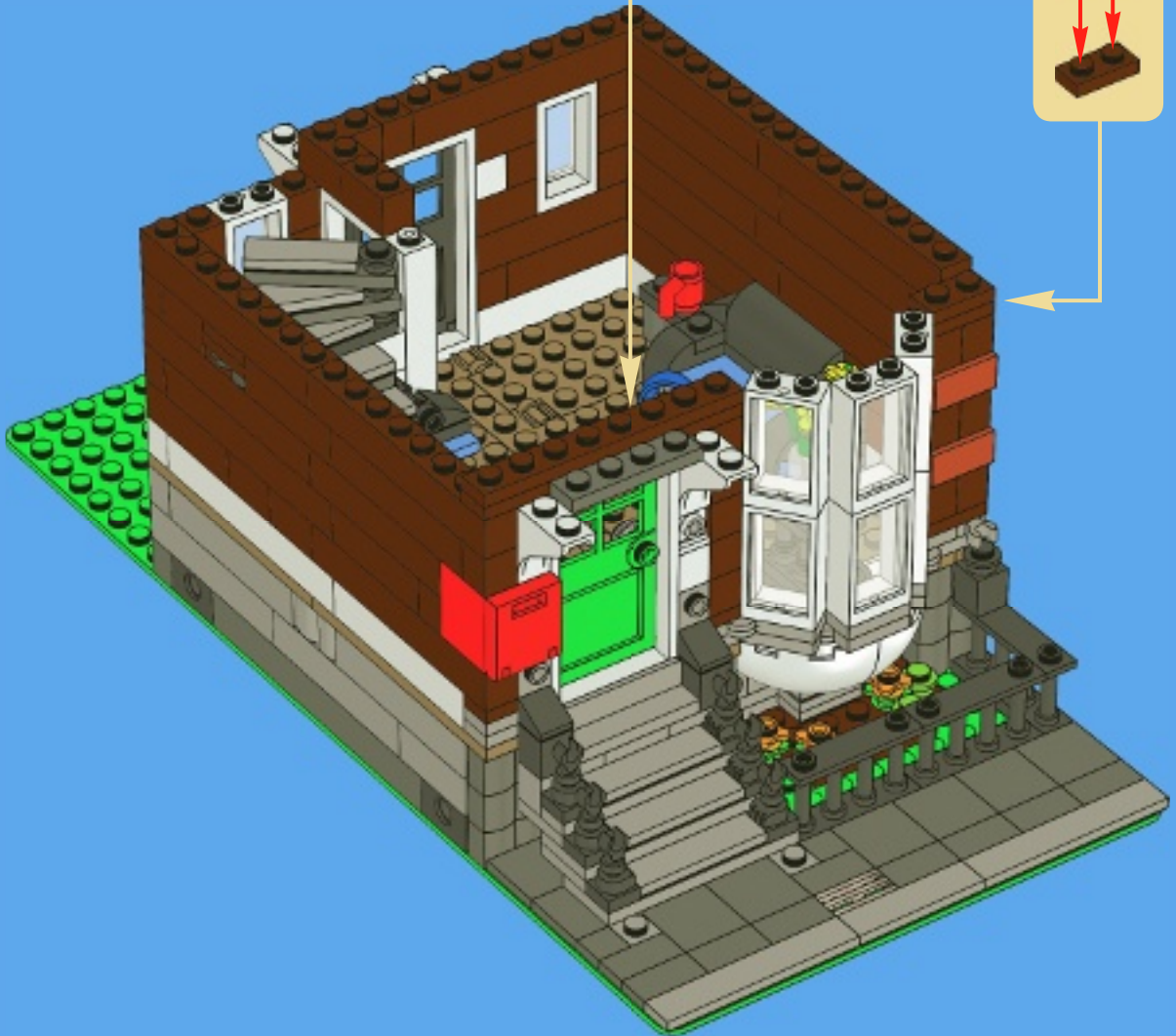
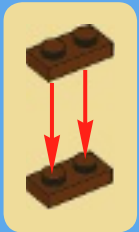

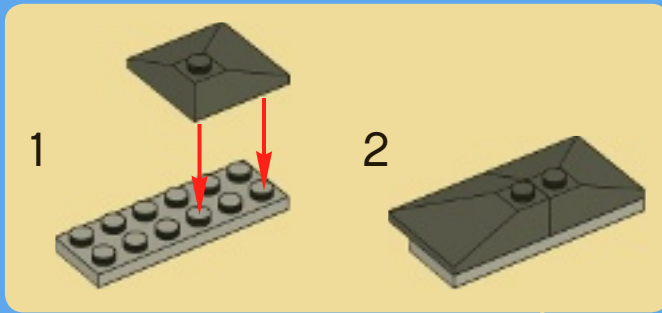
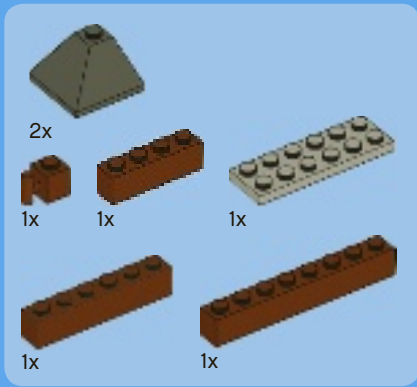

32

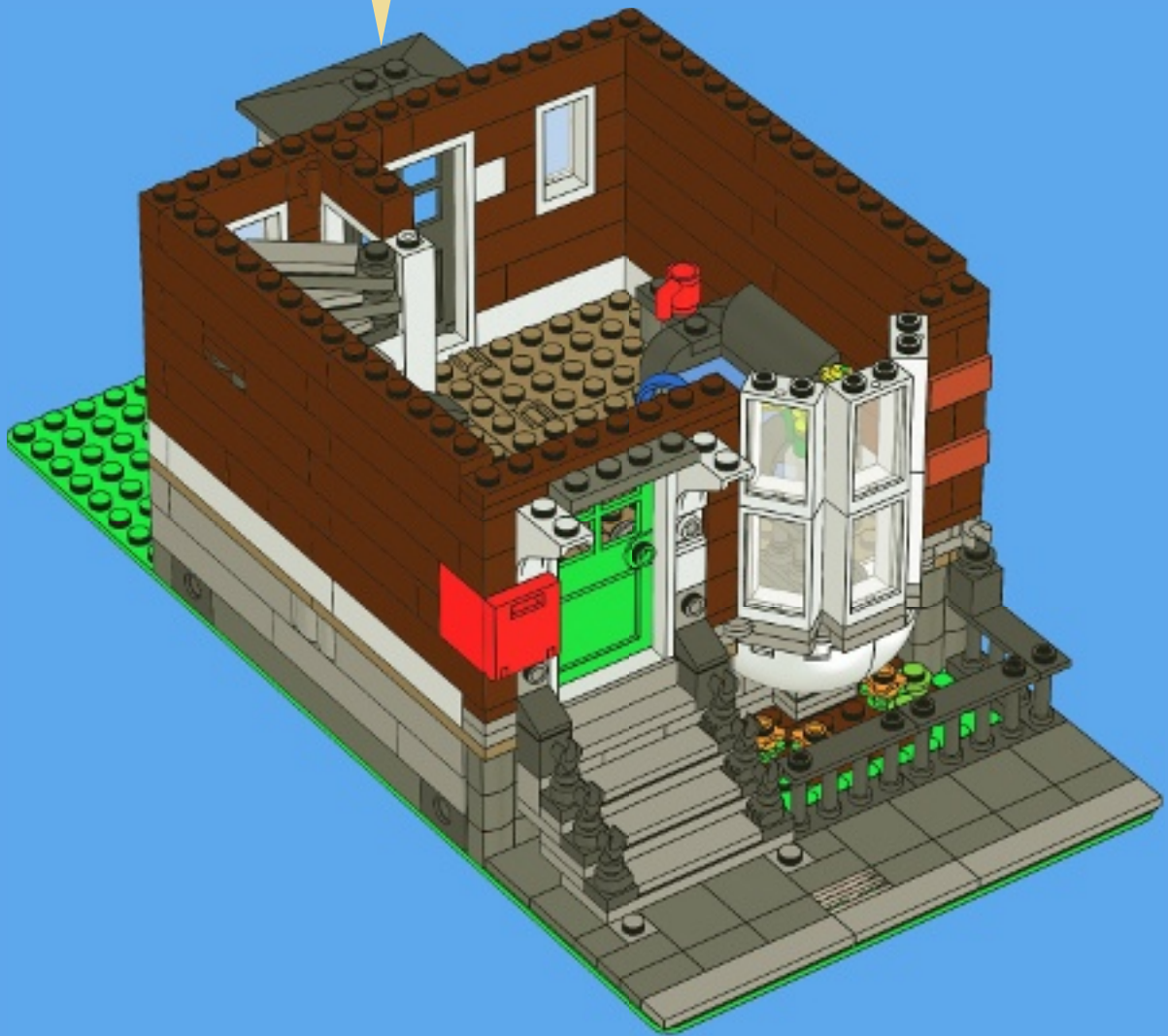

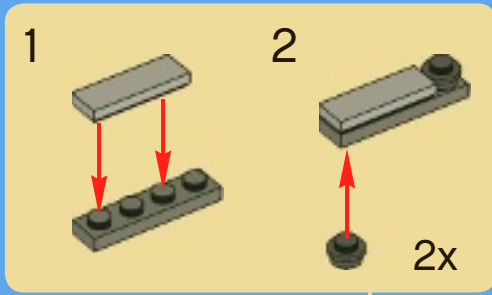
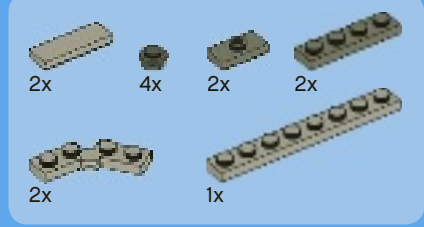

33

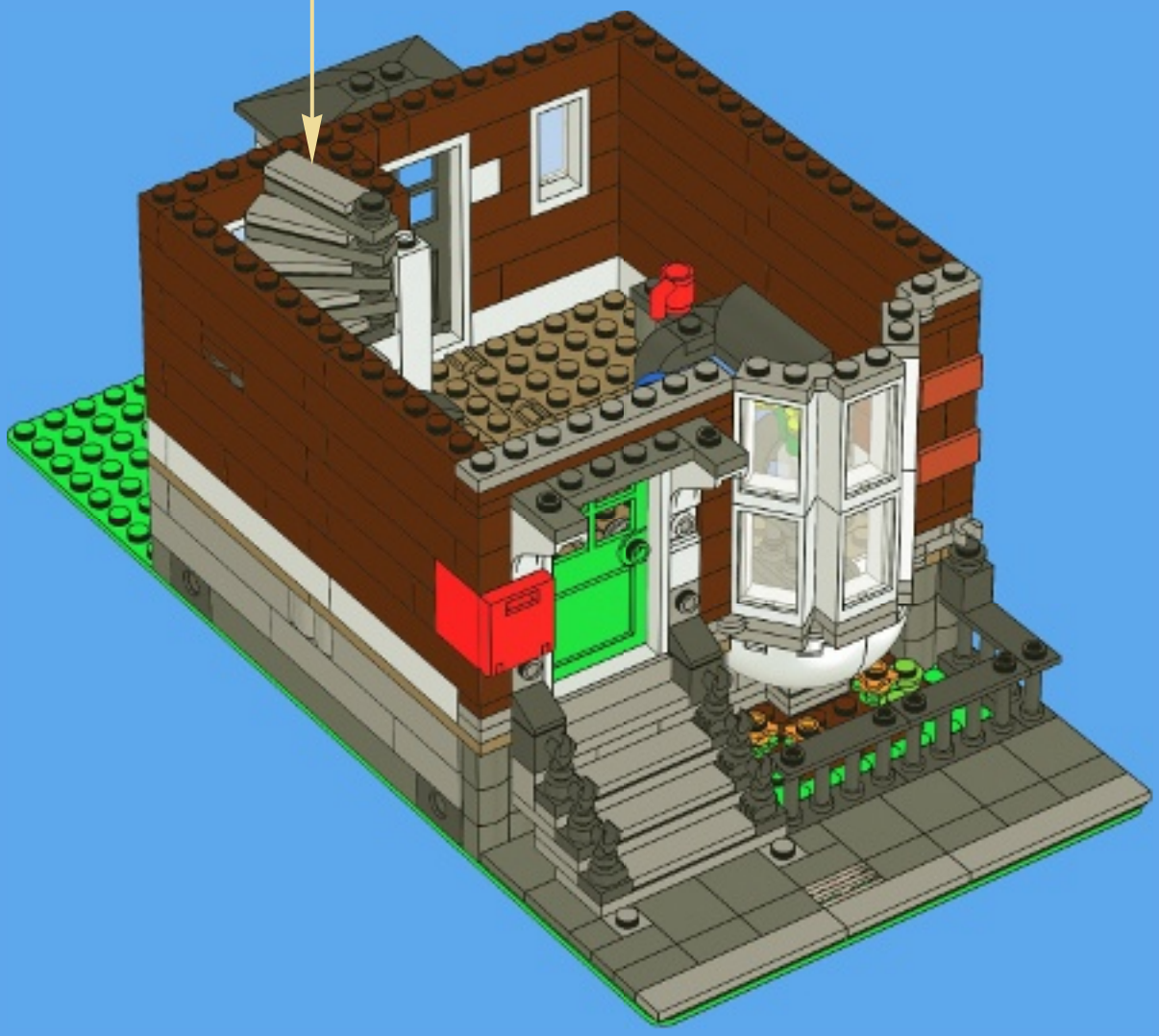



34

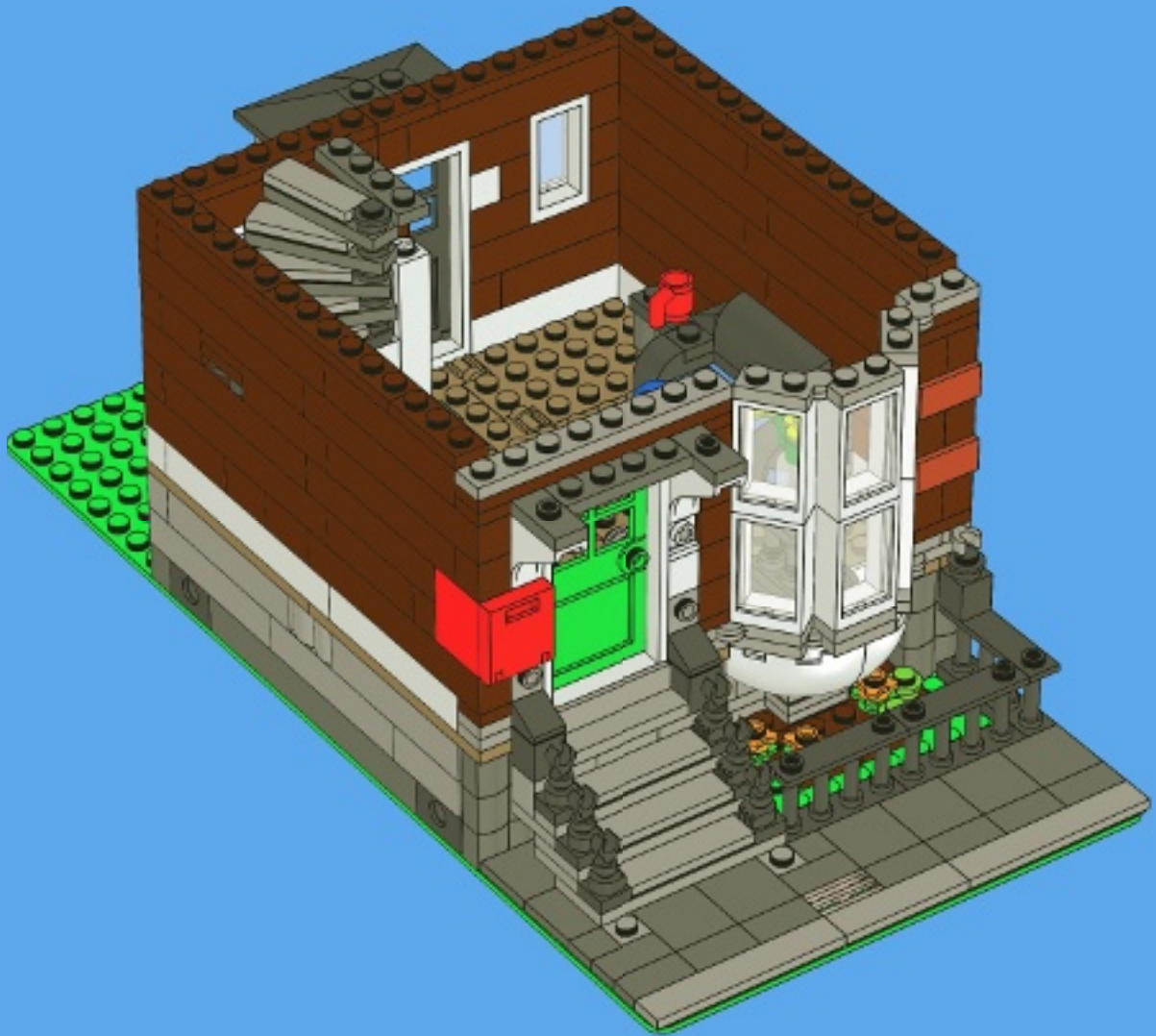

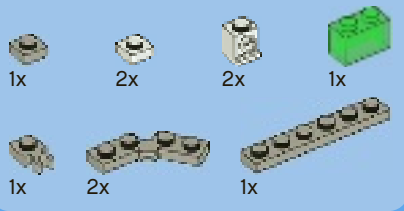

# 35

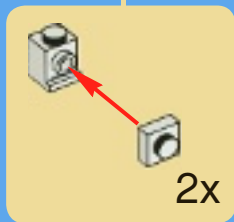
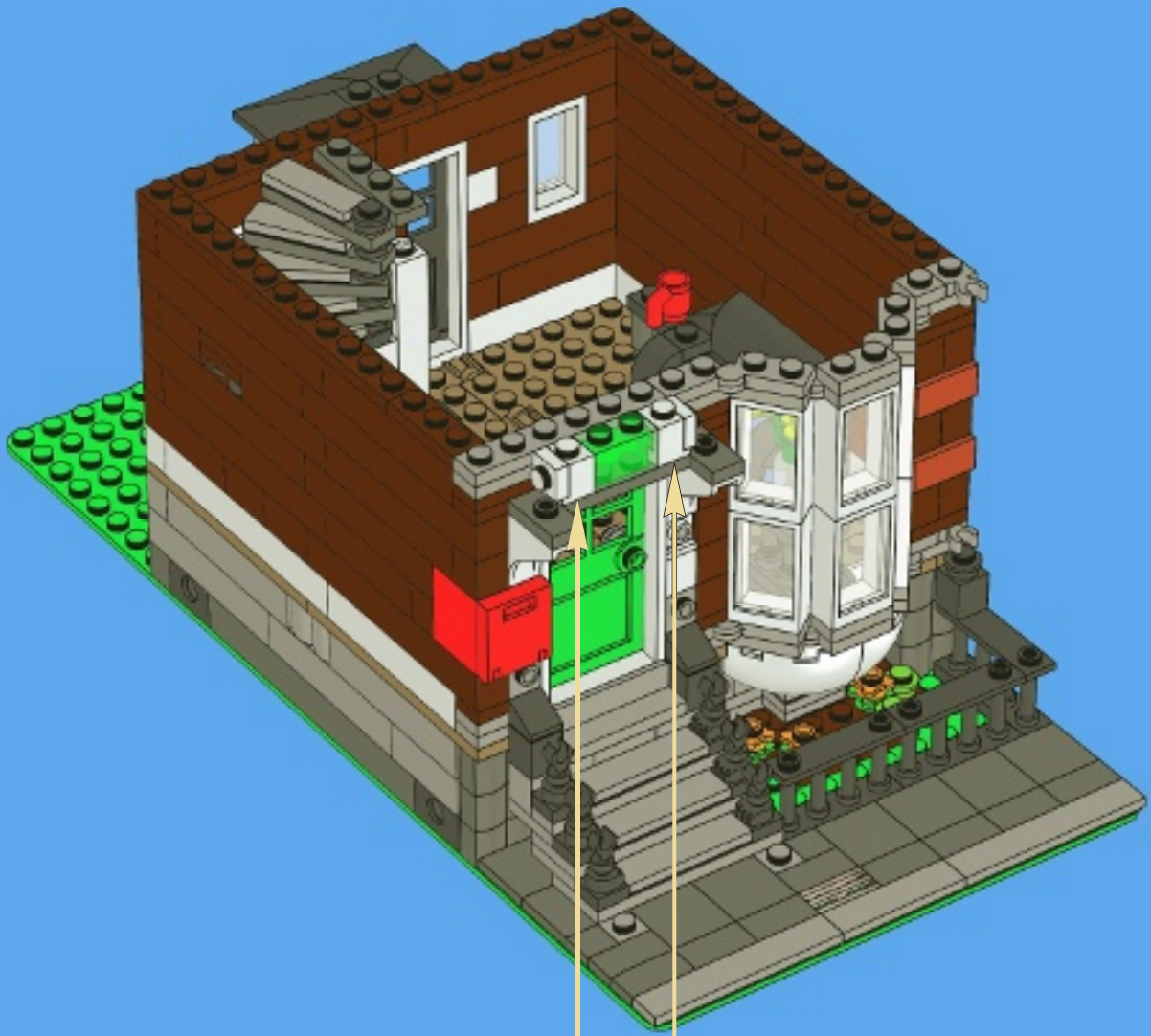

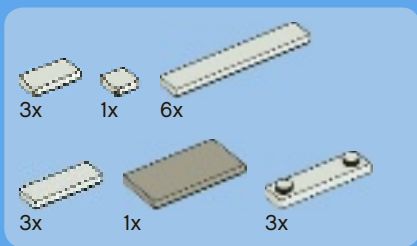

36

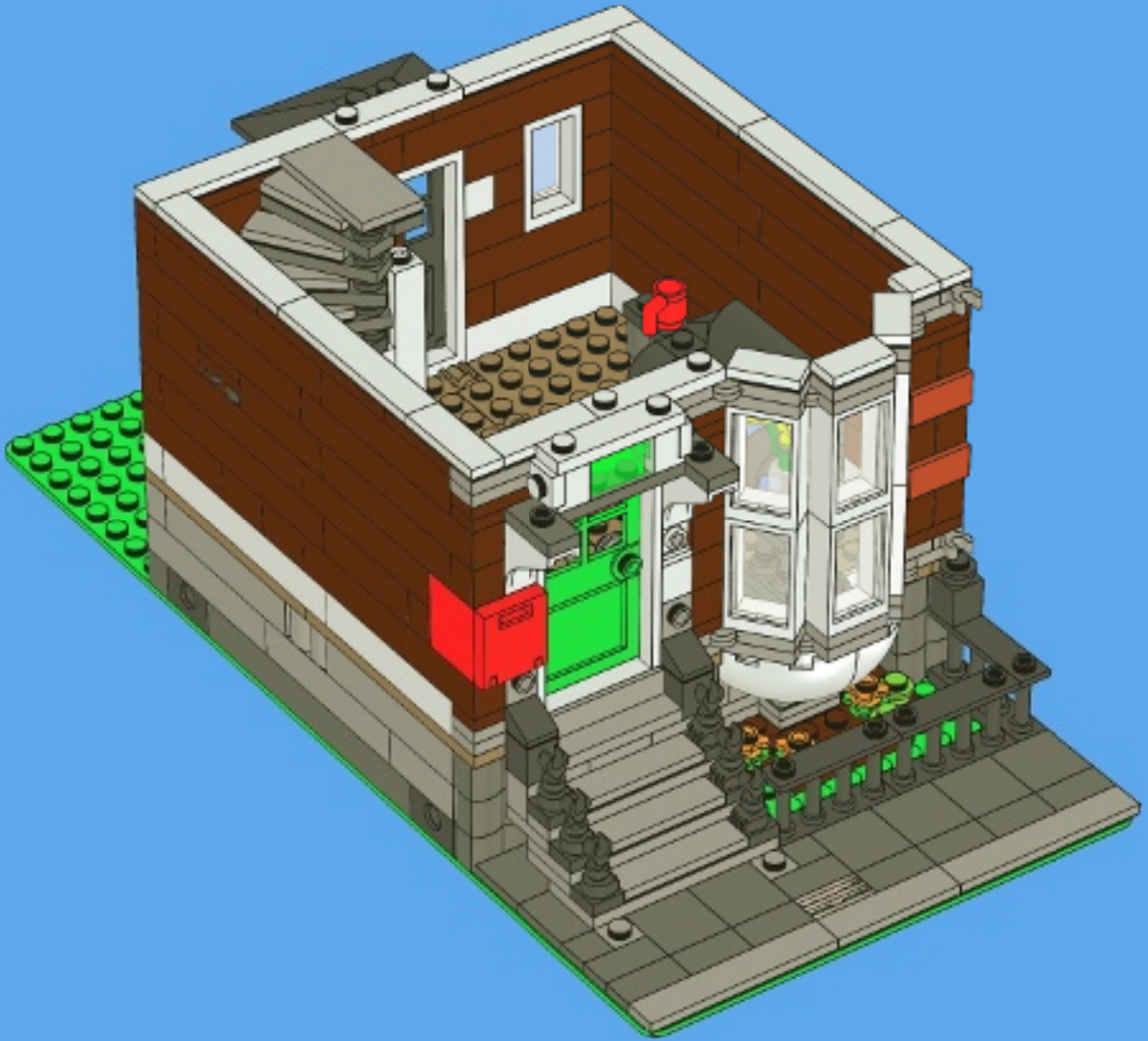

2x

4x

2x

# 37

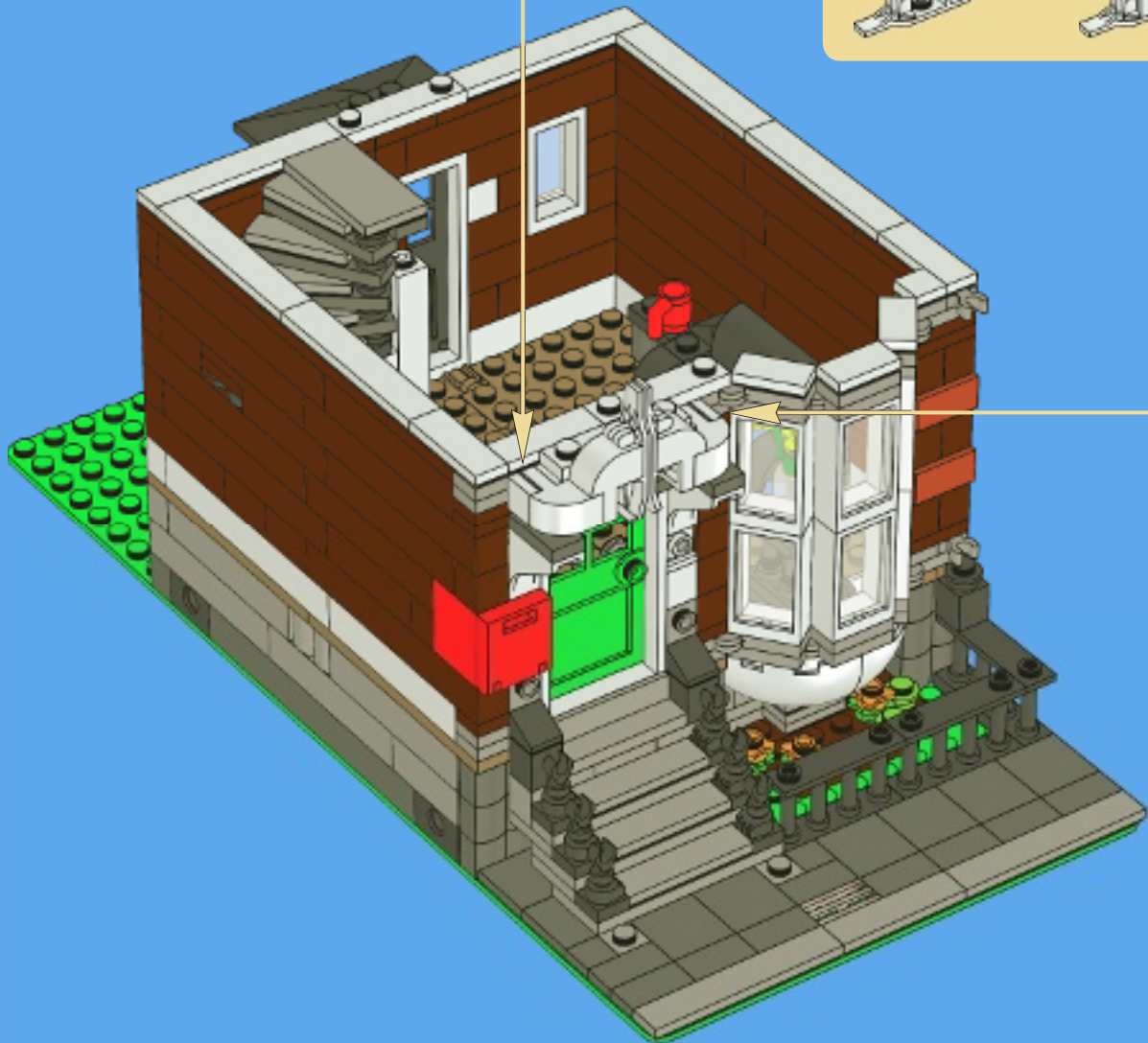
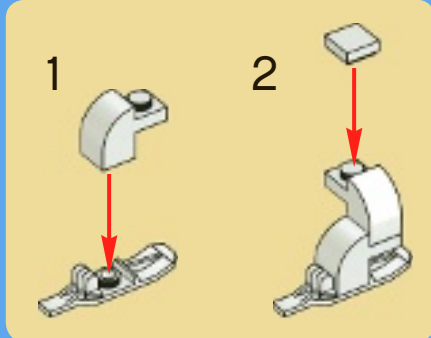
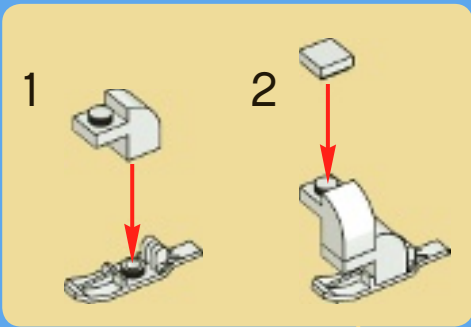



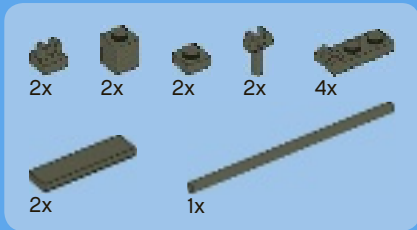

38

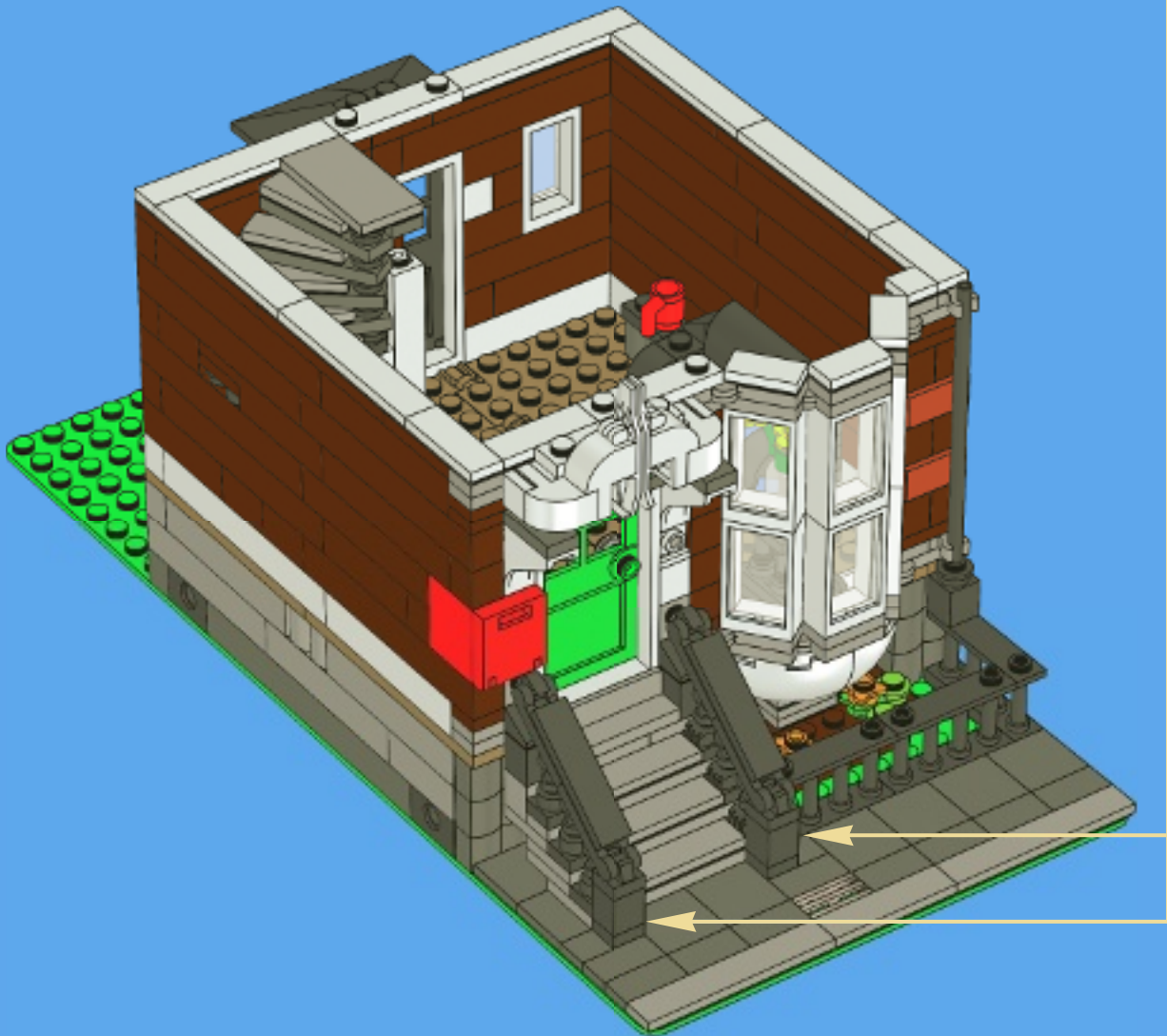
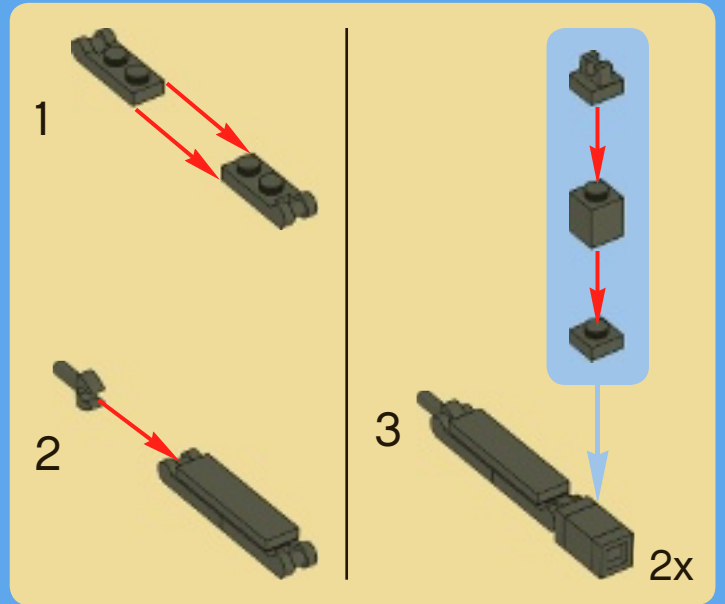

39

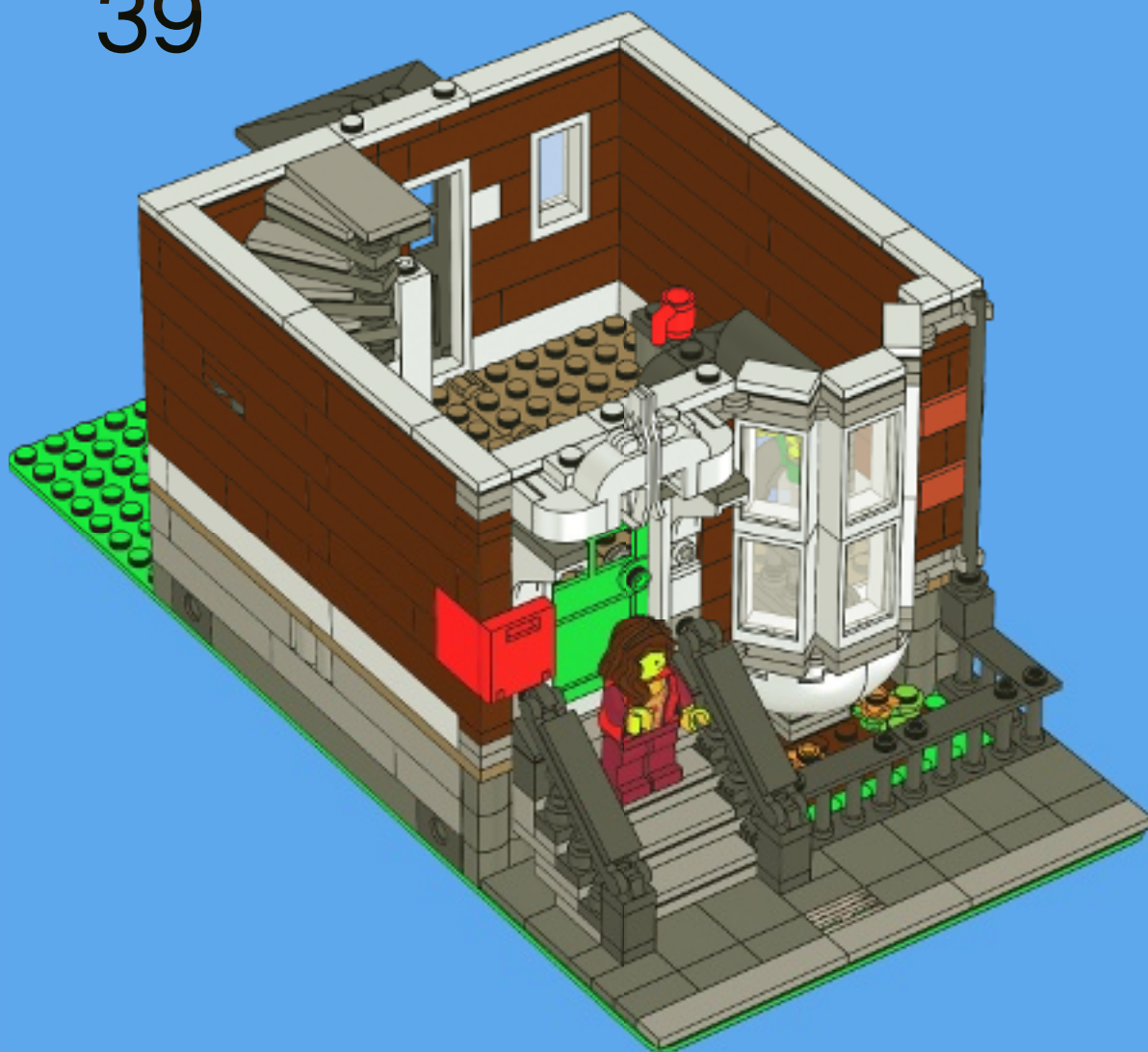

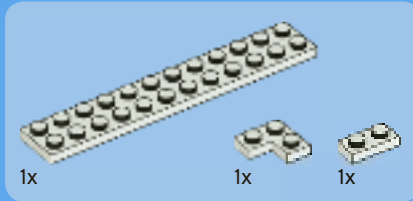
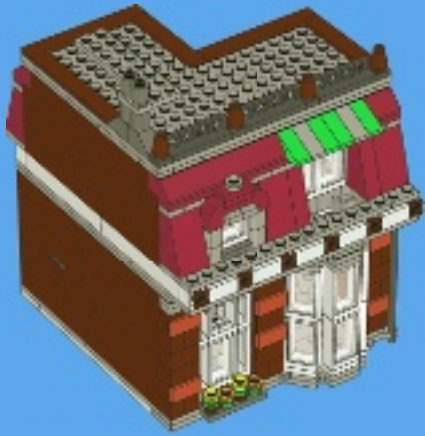

1

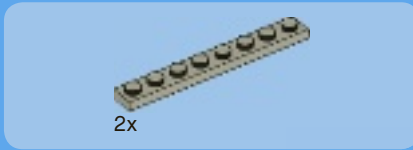
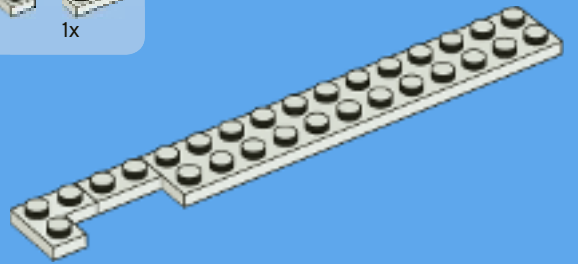

2

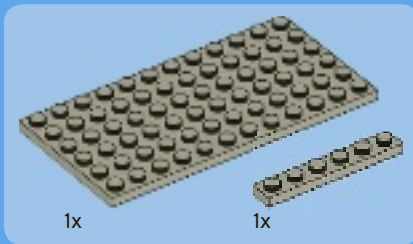
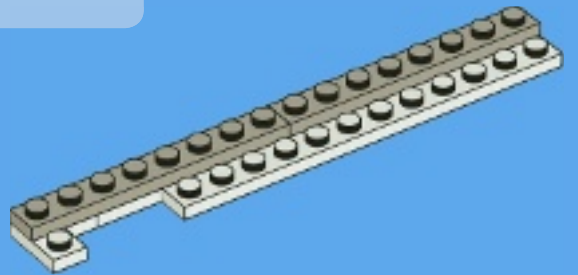

3

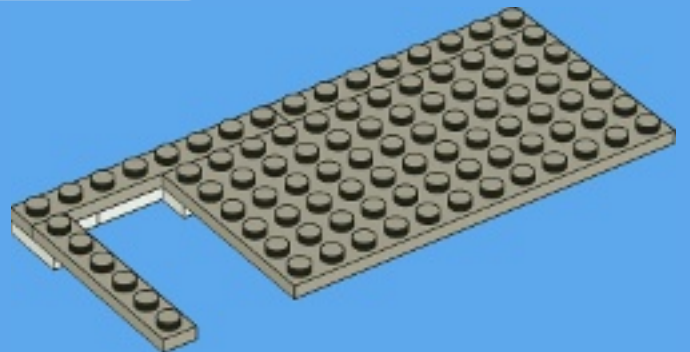

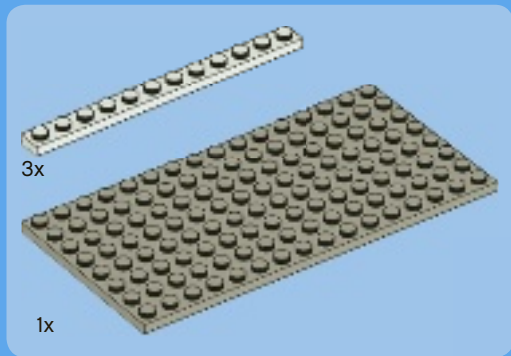

4

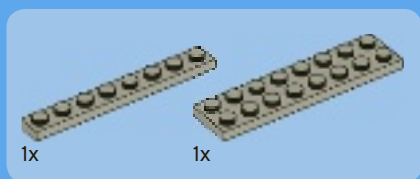
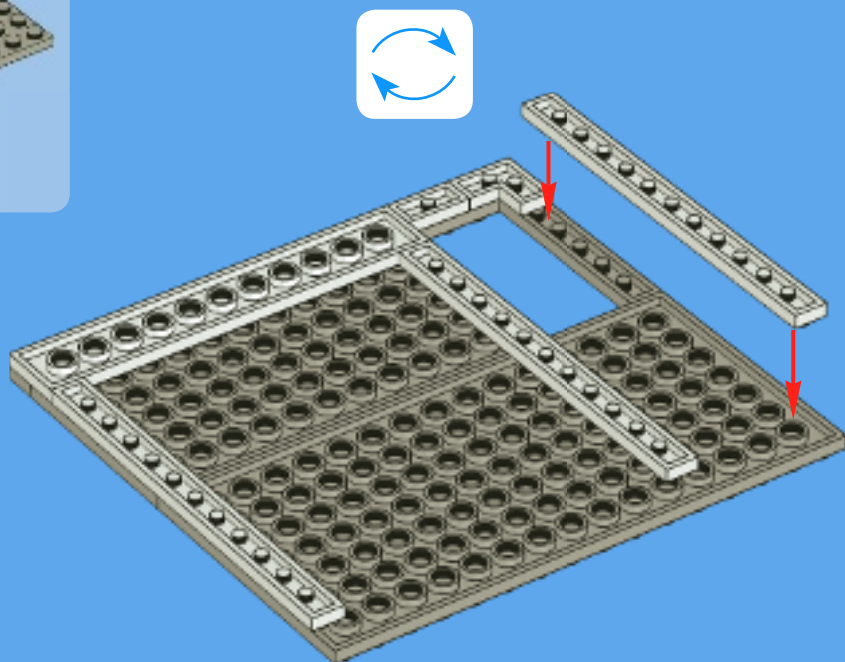

5

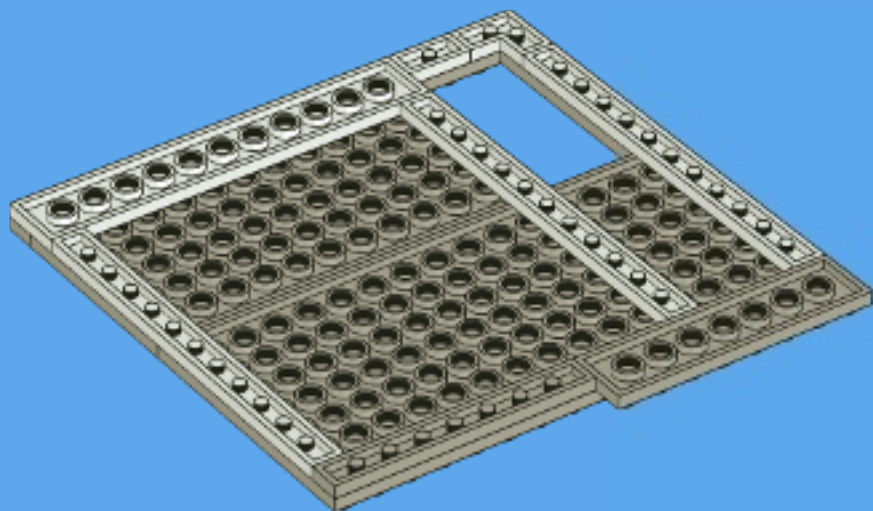

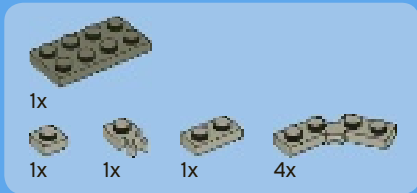

6

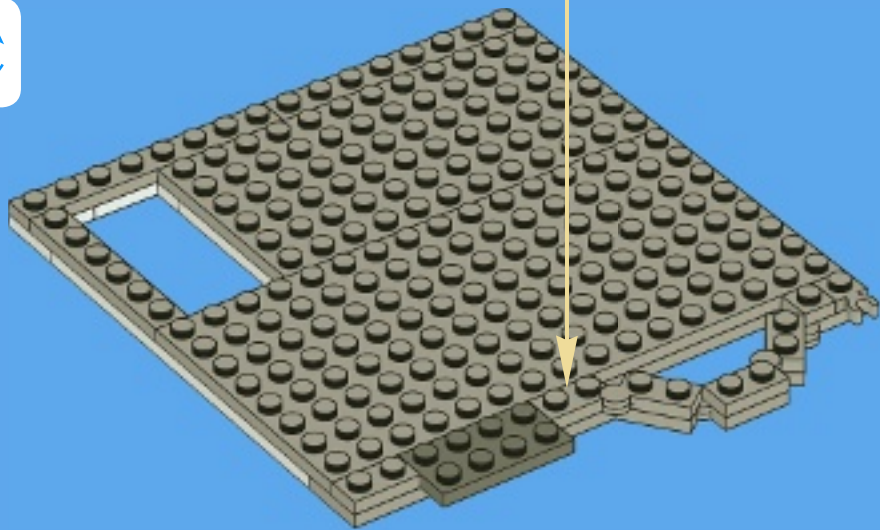
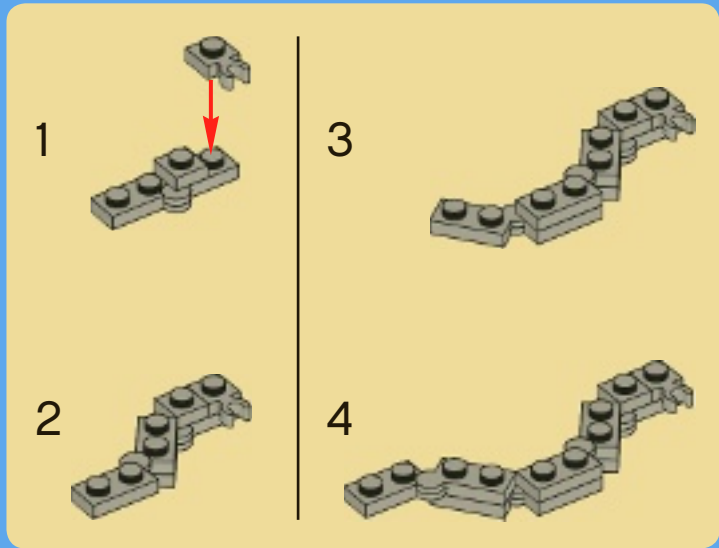

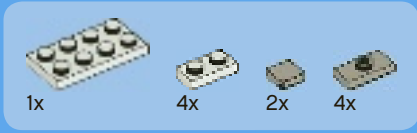

7



8

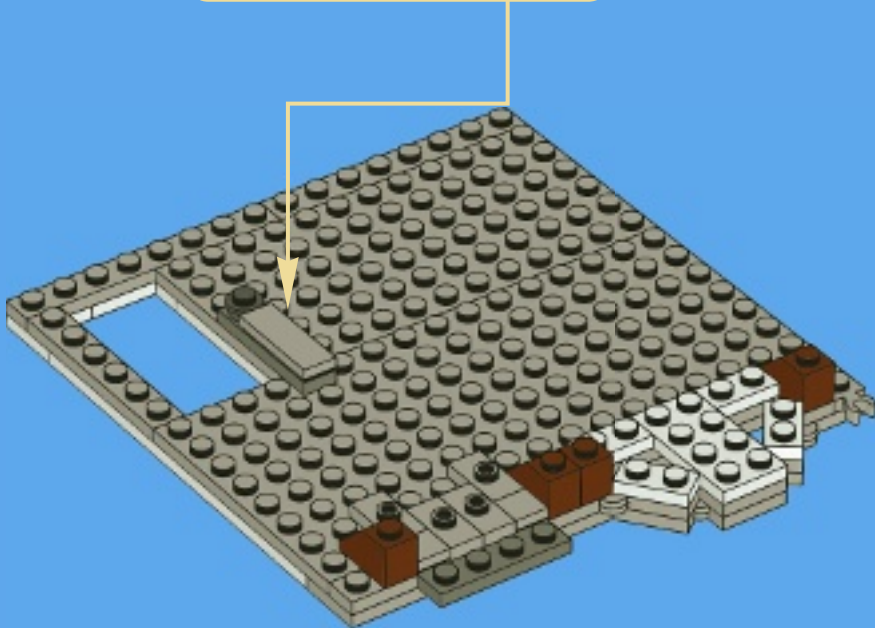
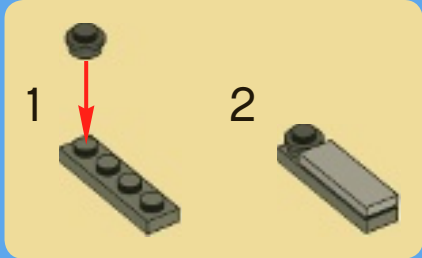

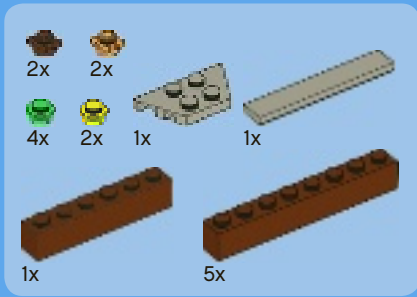

9



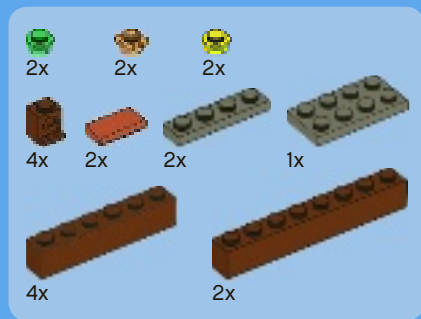

# 10

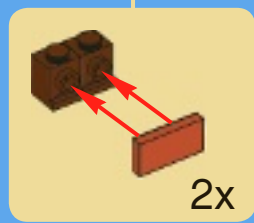
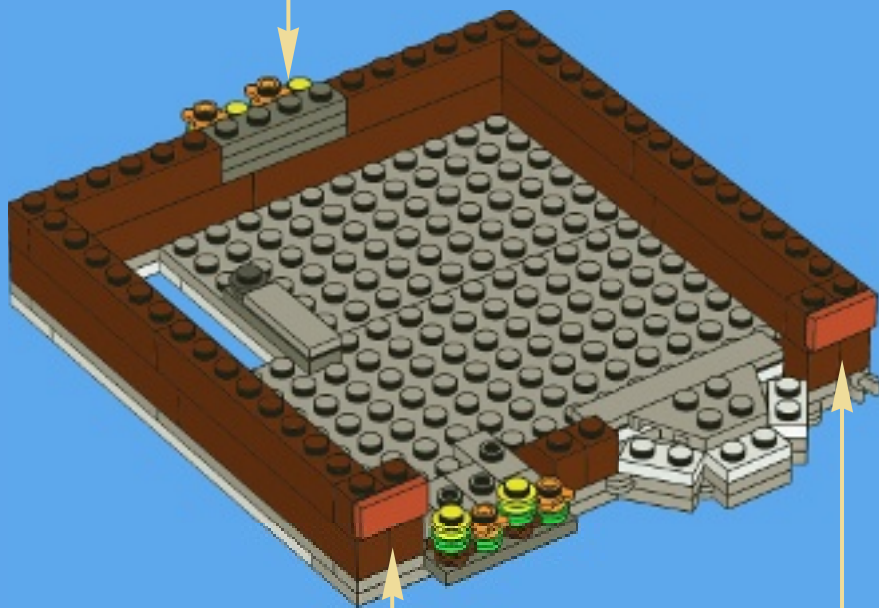



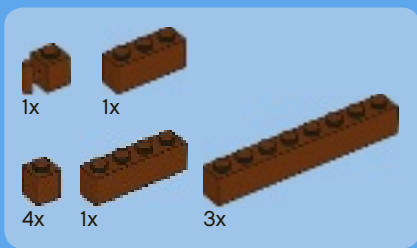

11



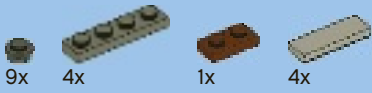

# 12

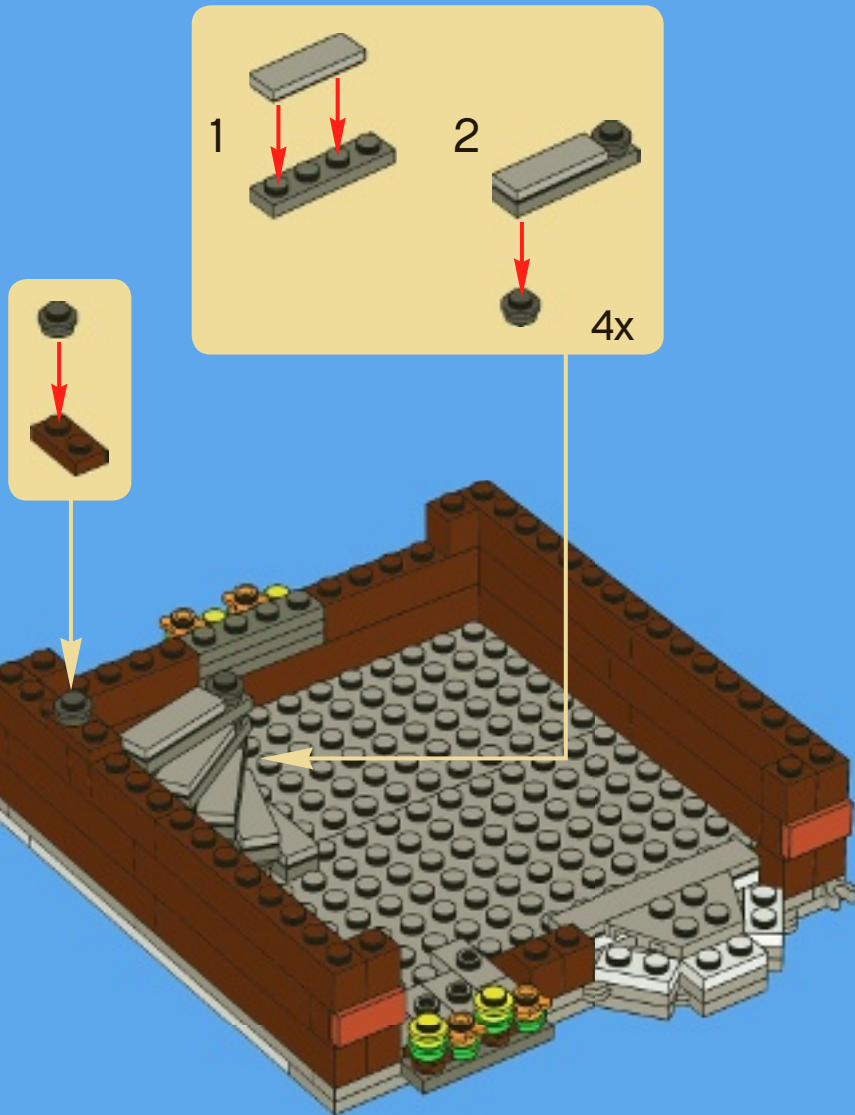

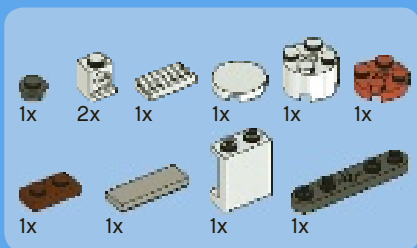

# 13

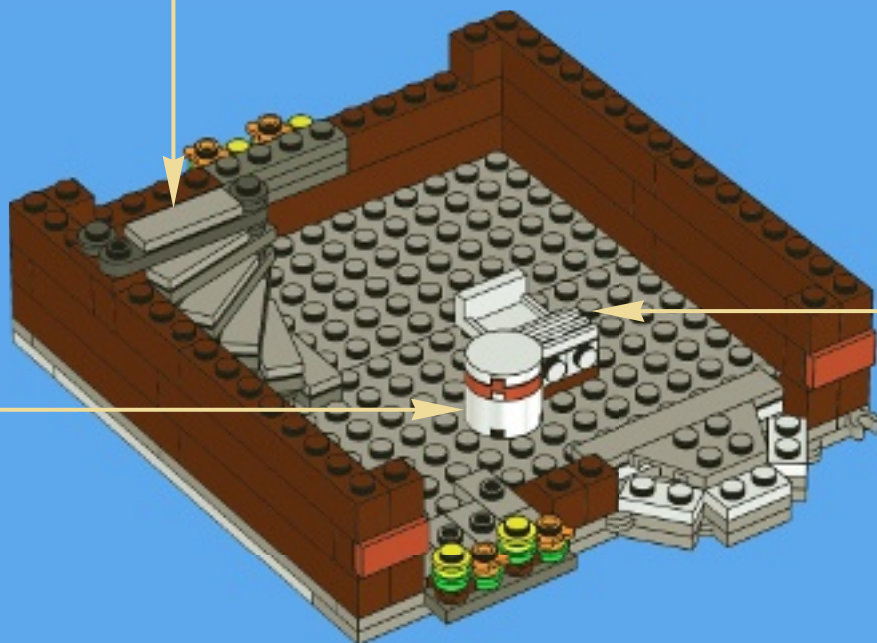
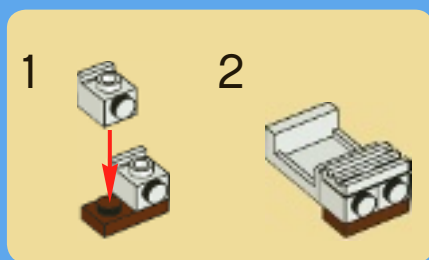
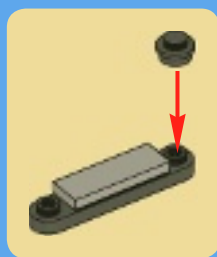

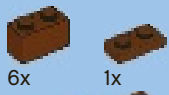

6x

1x



1x



2x

# 14



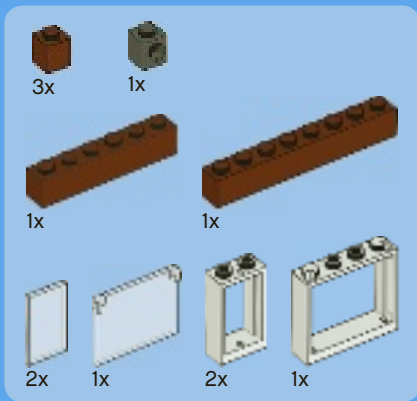

15

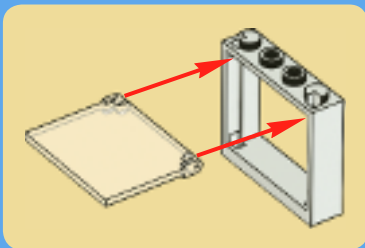
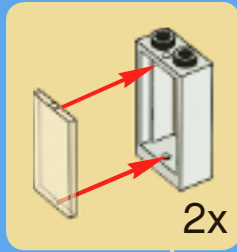

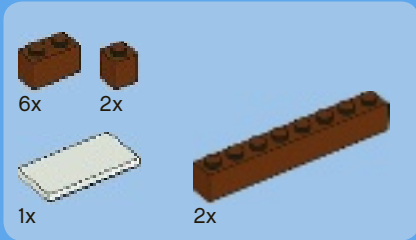

16

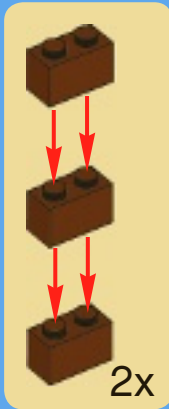

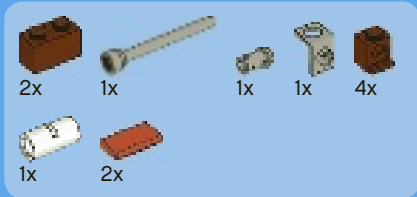

# 17

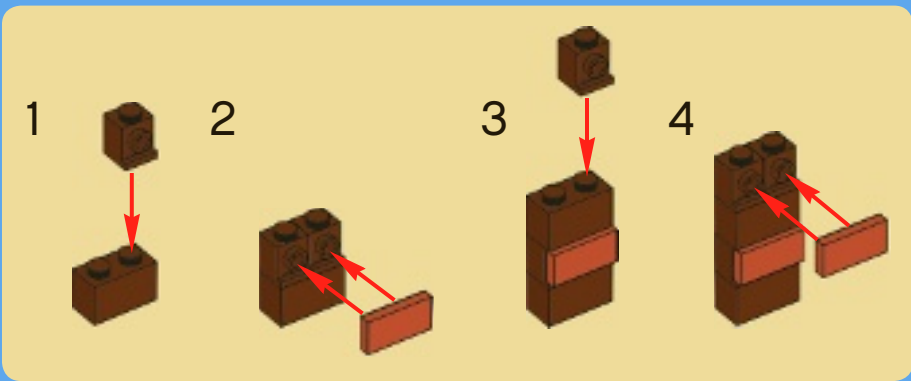
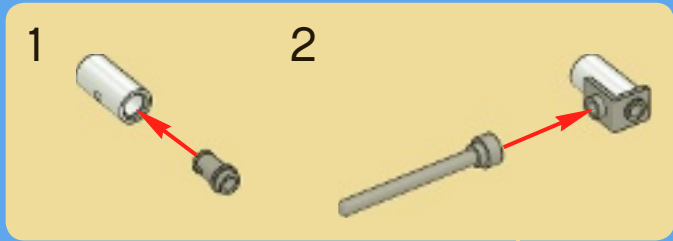

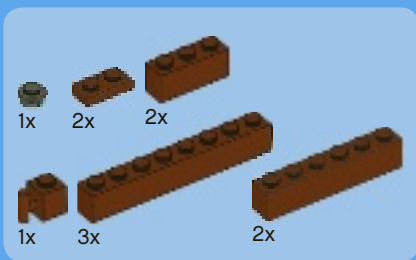

# 18

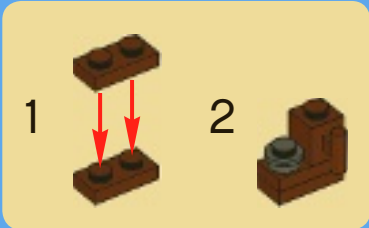





19

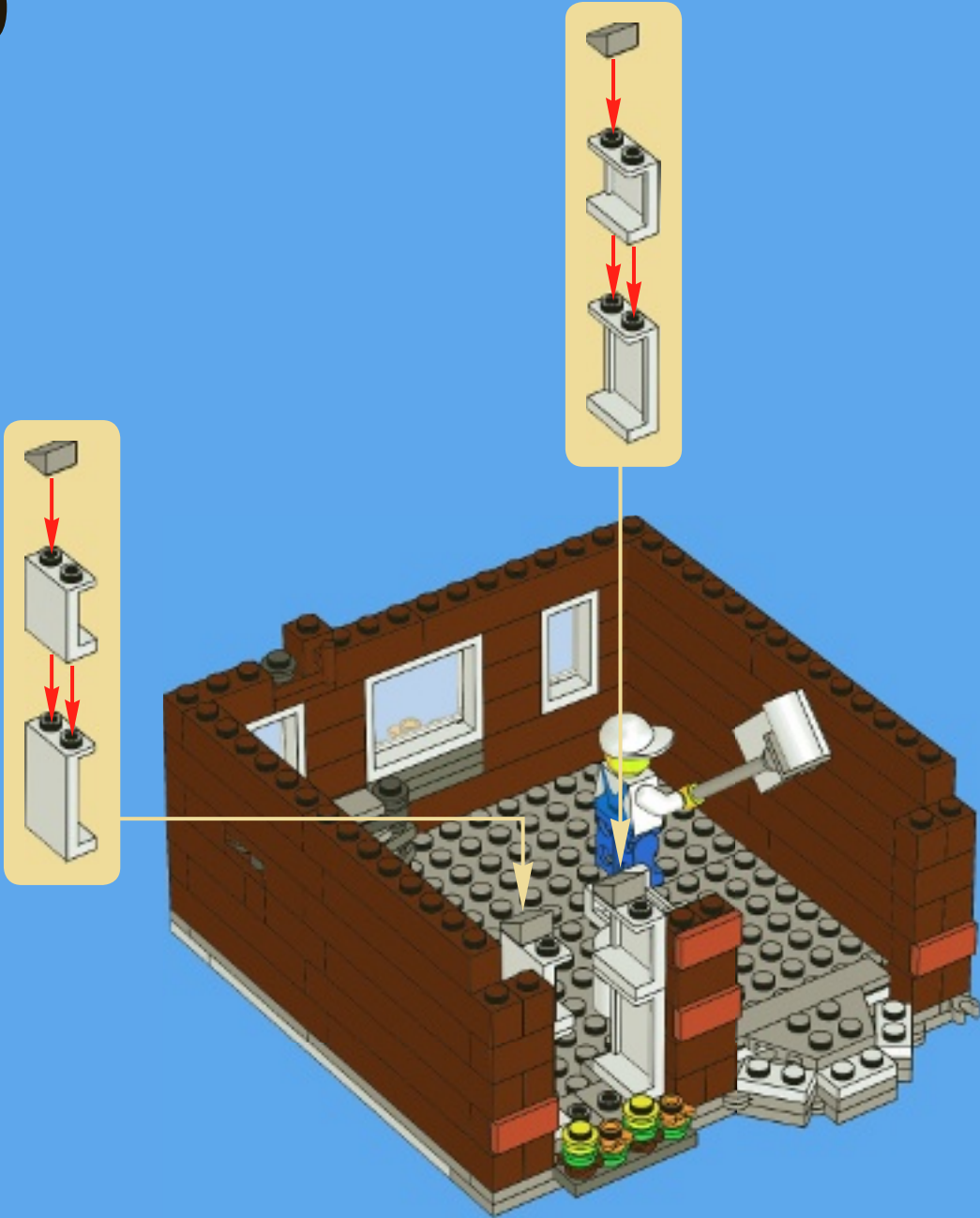



1x



7x



7x

# 20

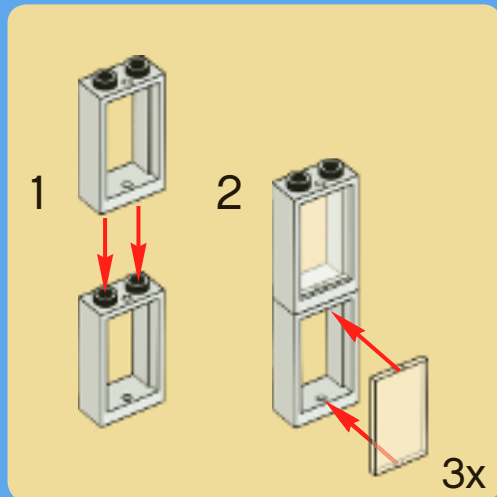
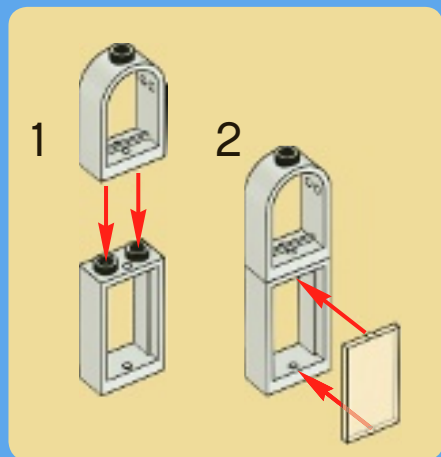



# 21

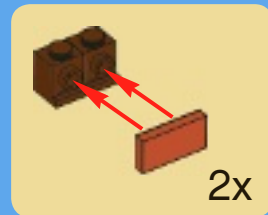
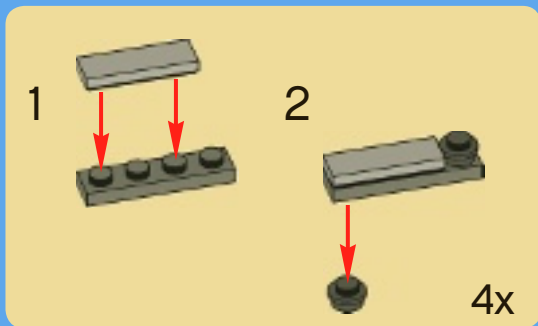

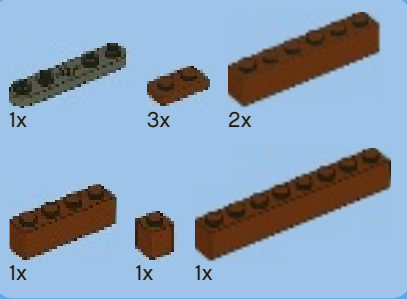

22



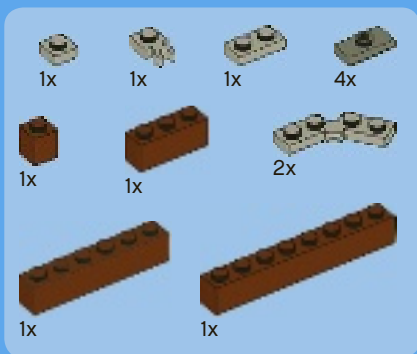

# 23





1x



2x

# 24



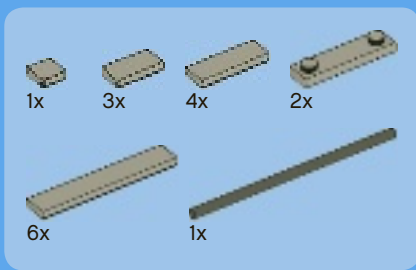

25



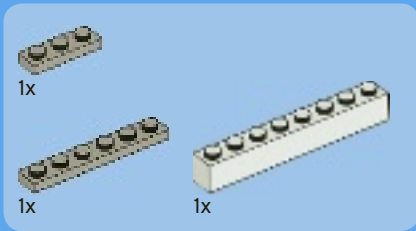

1

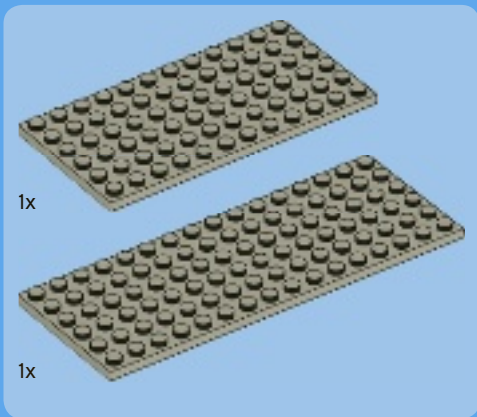
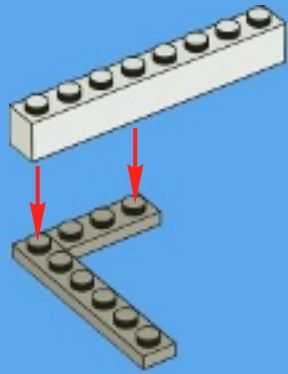

2

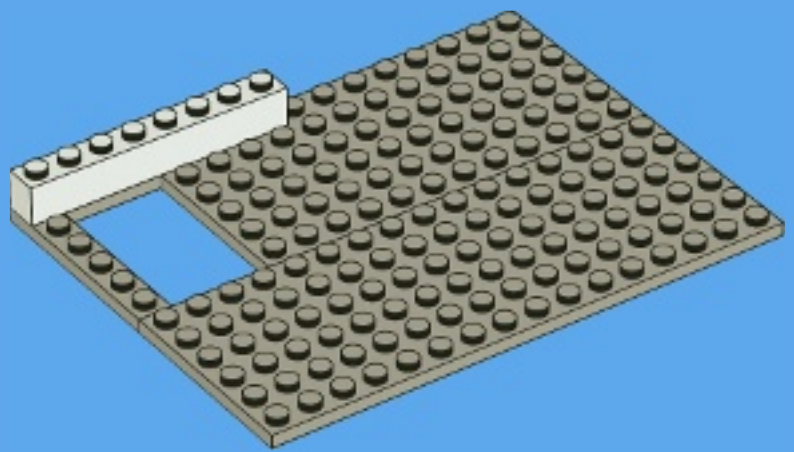



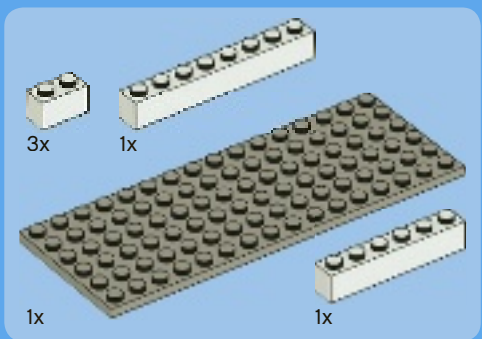

3

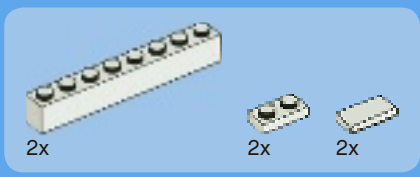
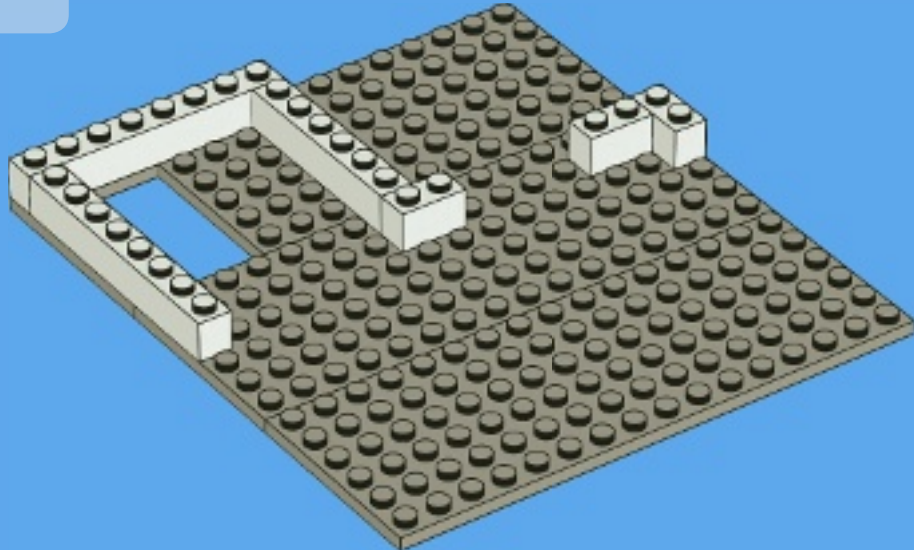

4

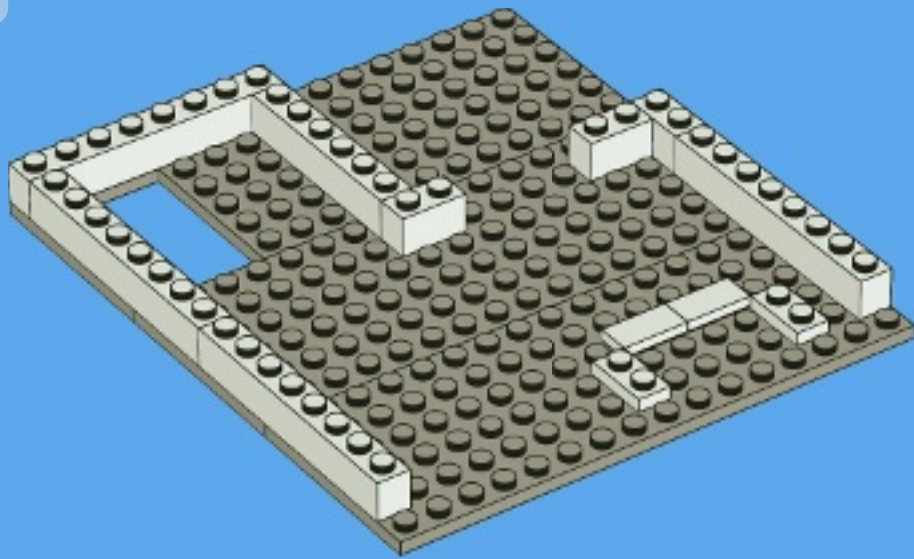

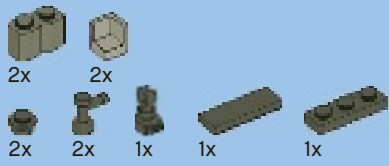

5

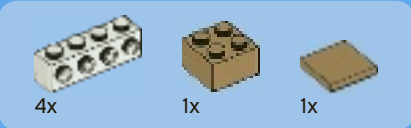
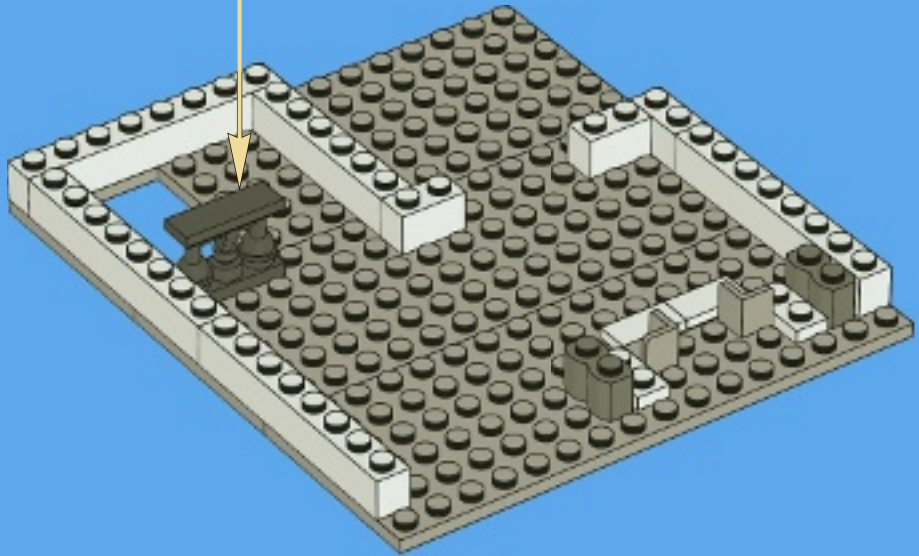

6

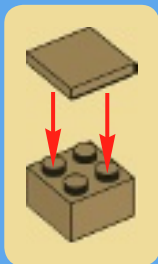

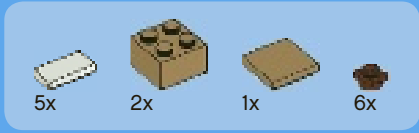



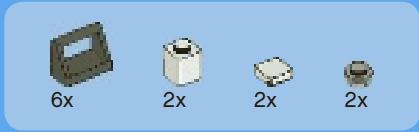
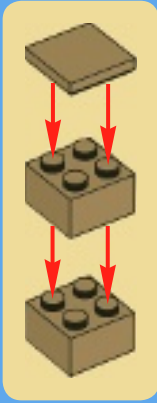

7

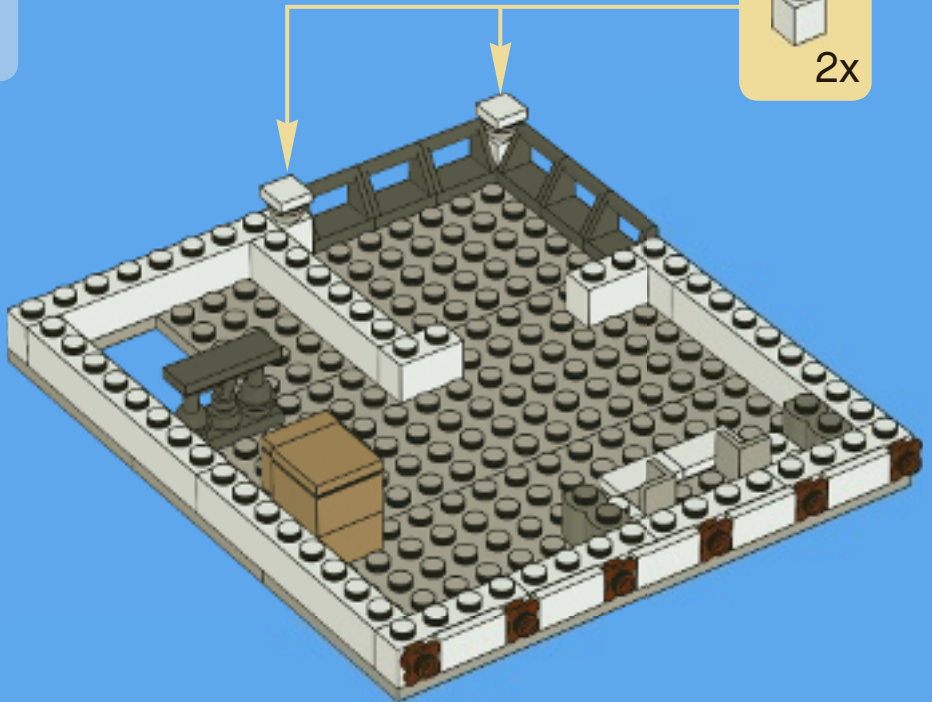
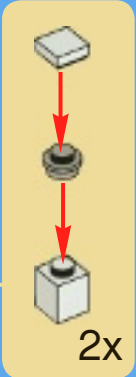

8



- 2x 
- 2x 
- 2x 
- 2x 
- 2x 

- 1x 
- 1x 
- 2x 
- 6x 

# 9

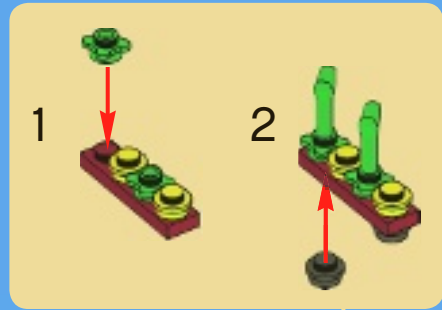

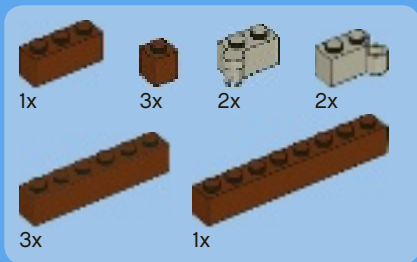

10

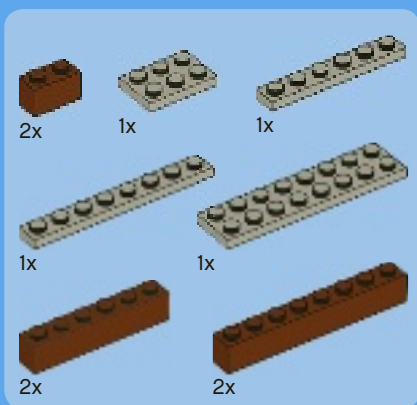
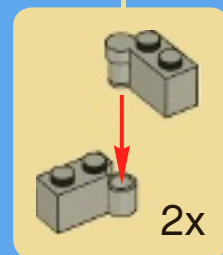

11



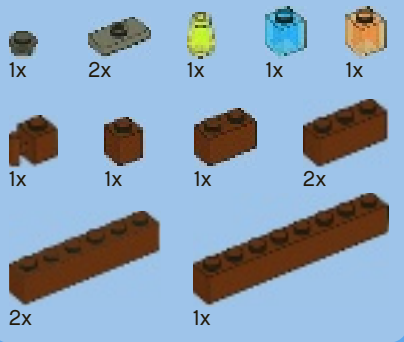

12



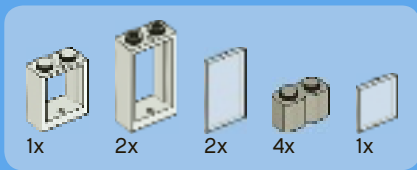

13

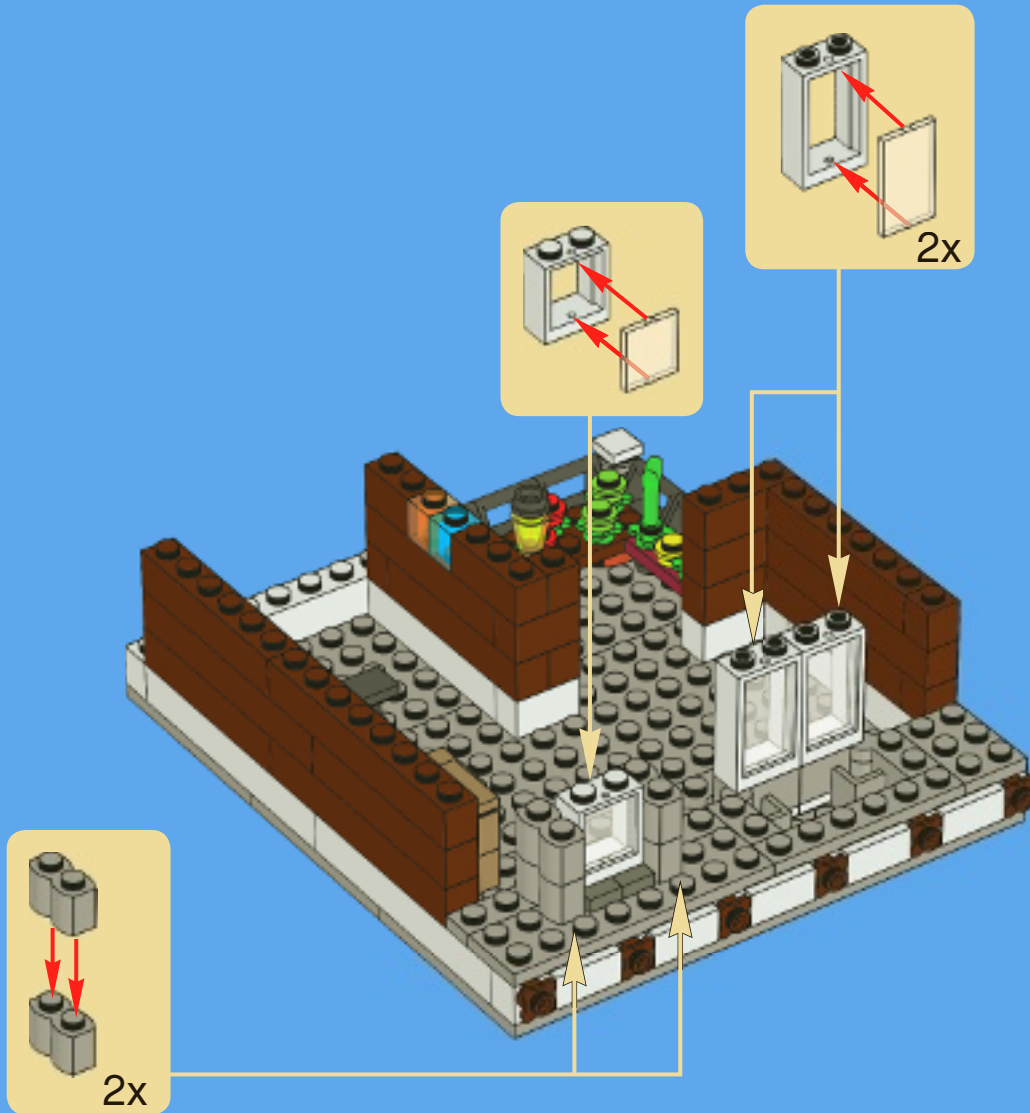

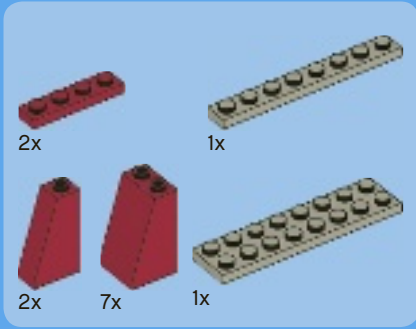

# 14

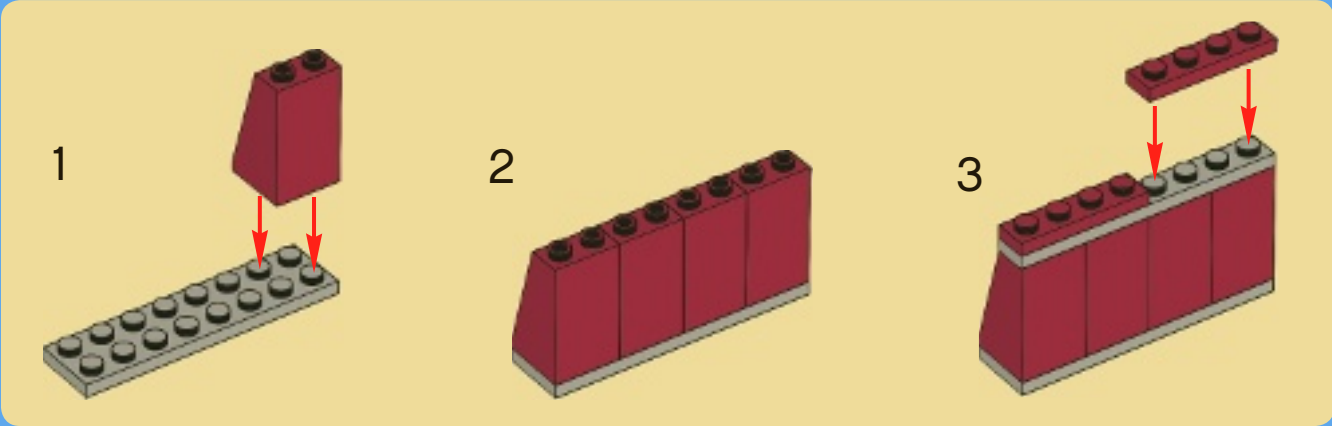





15



16





17

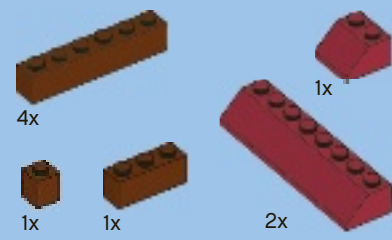
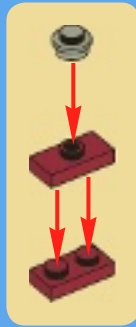

18



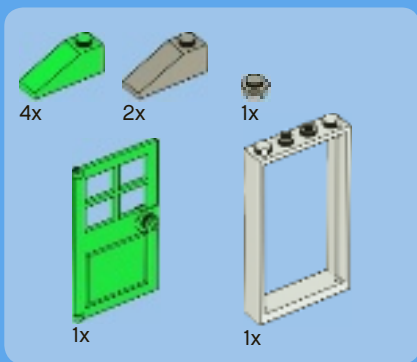

19

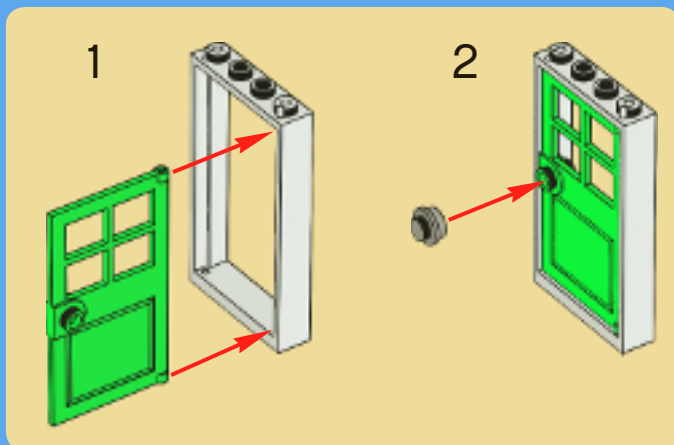



6x



2x



2x



5x

# 20

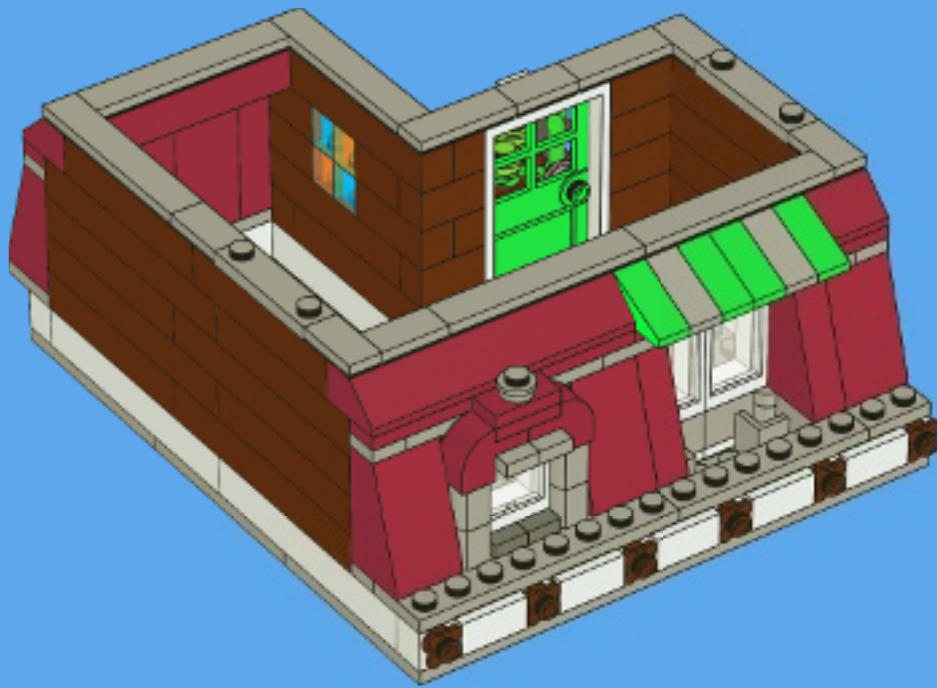

21



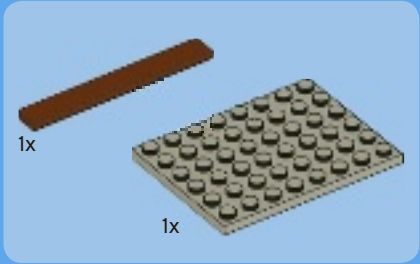
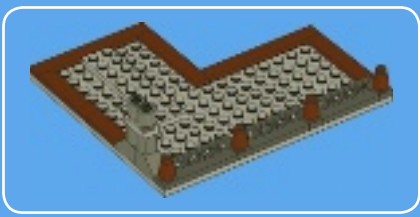

1

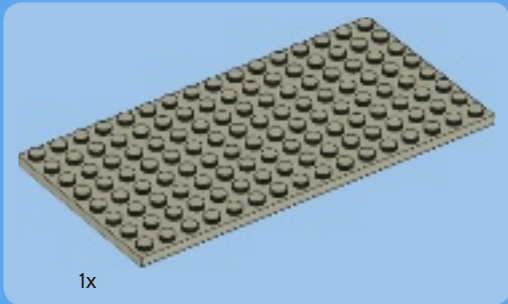
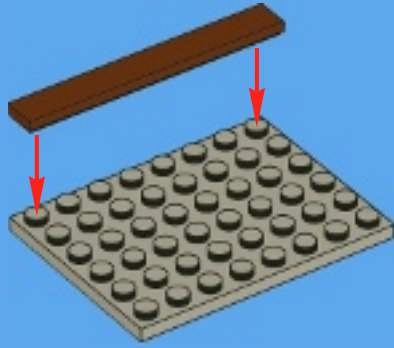

2

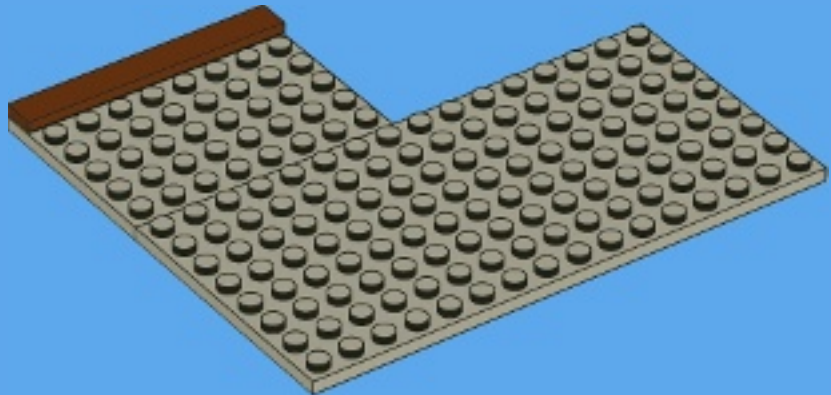

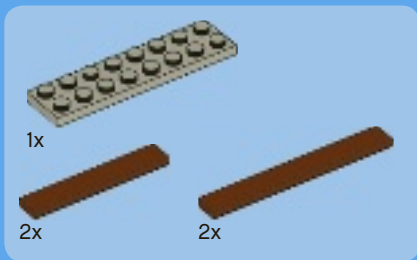

3

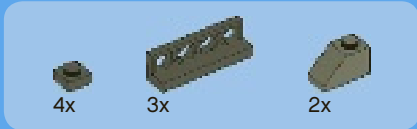
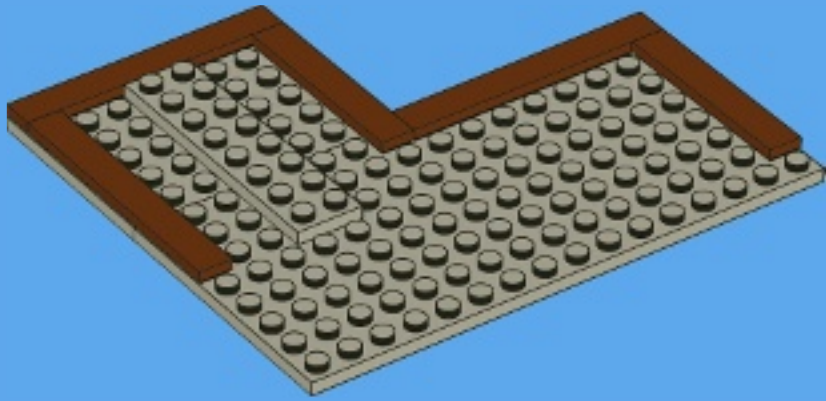

4

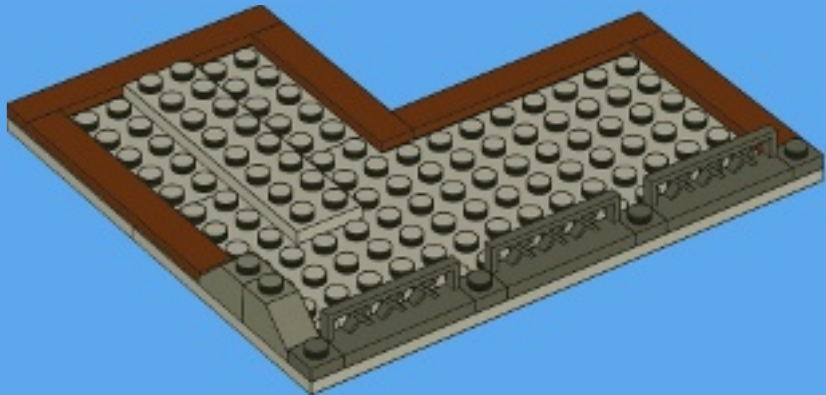



2x



1x



1x



4x

5

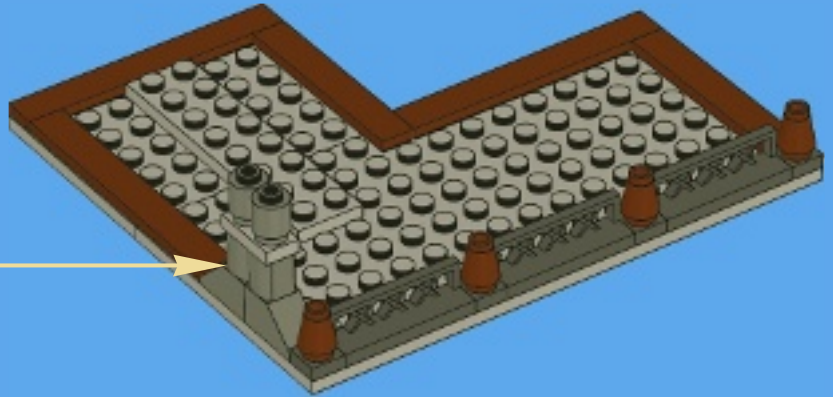
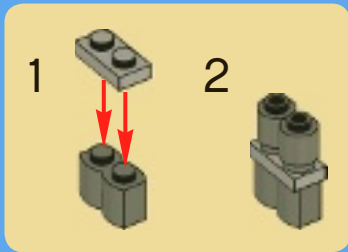

22

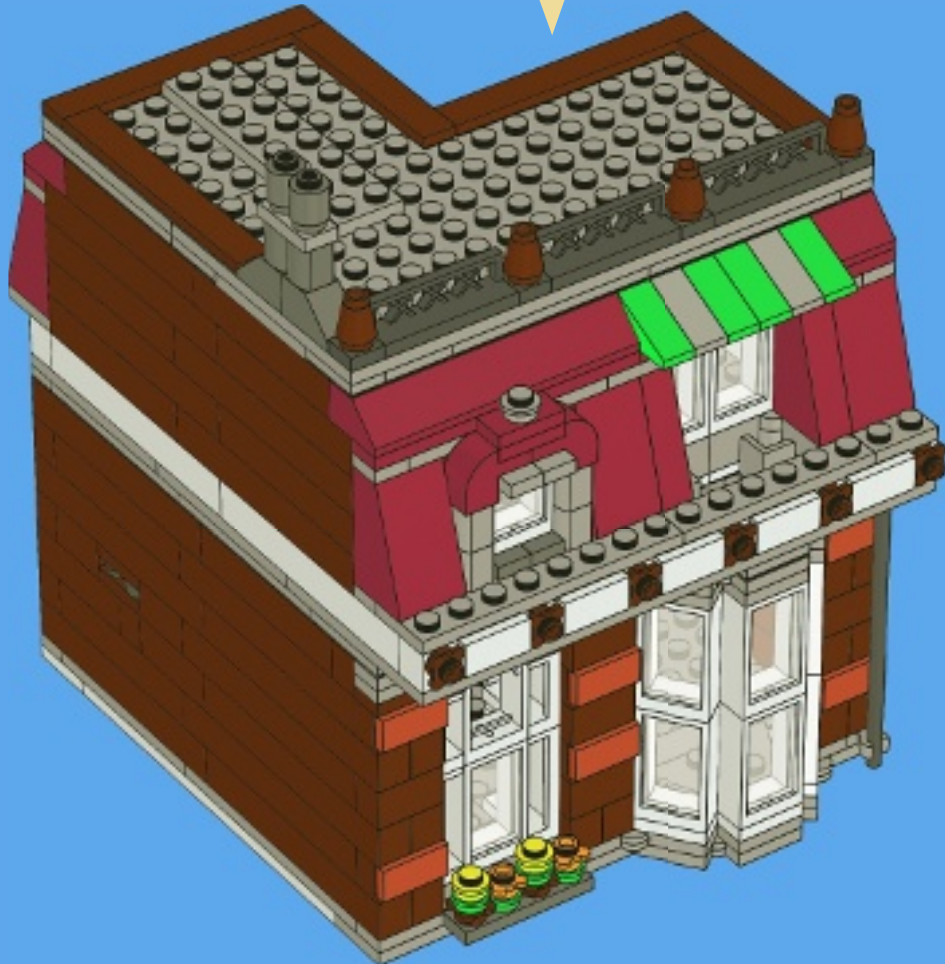



23



10197

10218

10211



10214



10219





10218



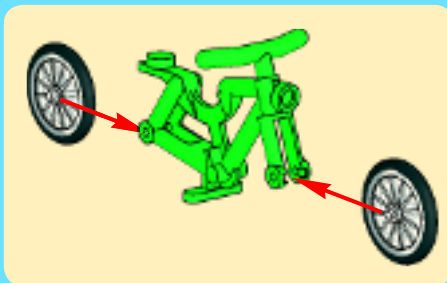

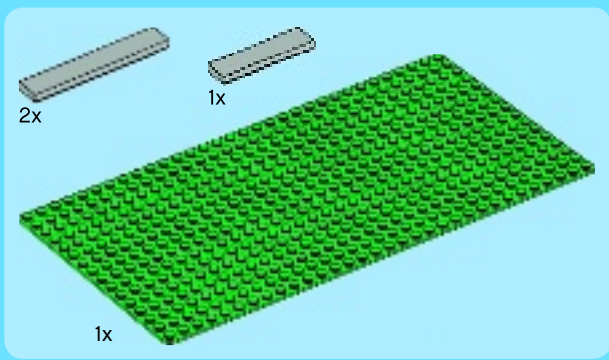

1

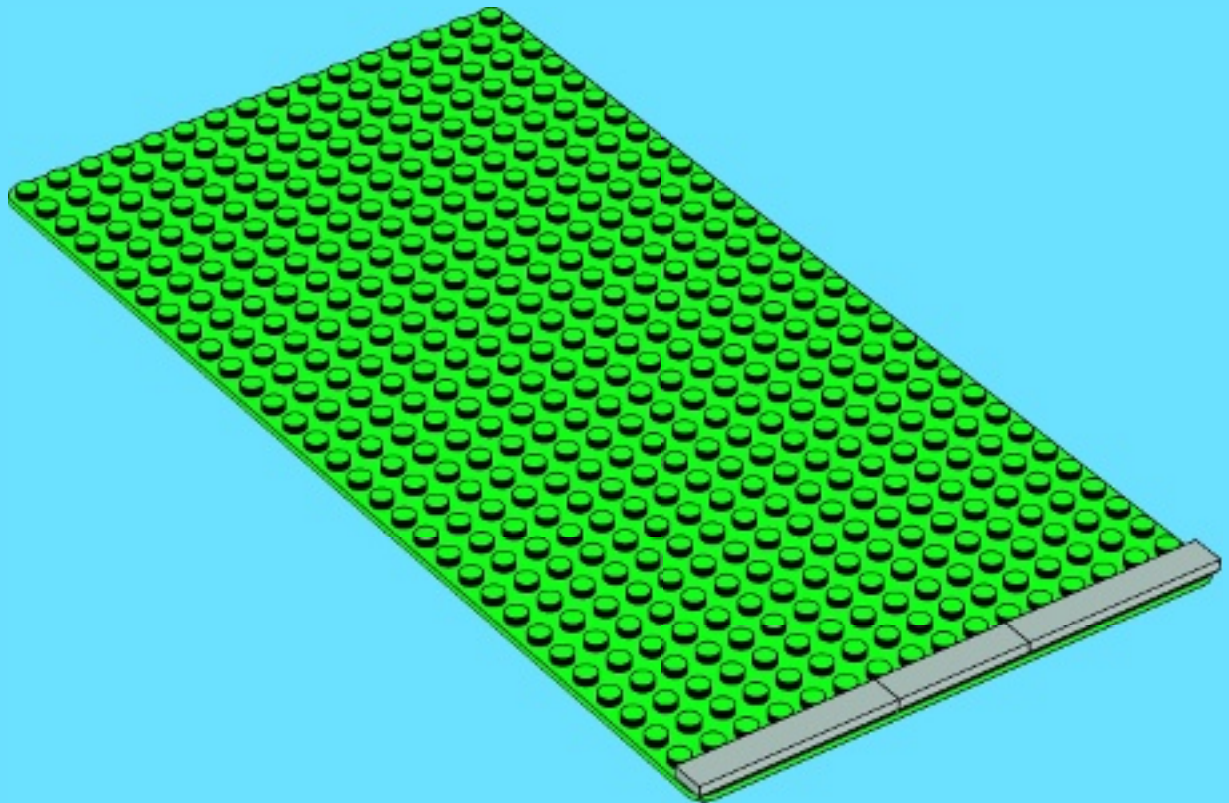



7x



10x



1x

# 2

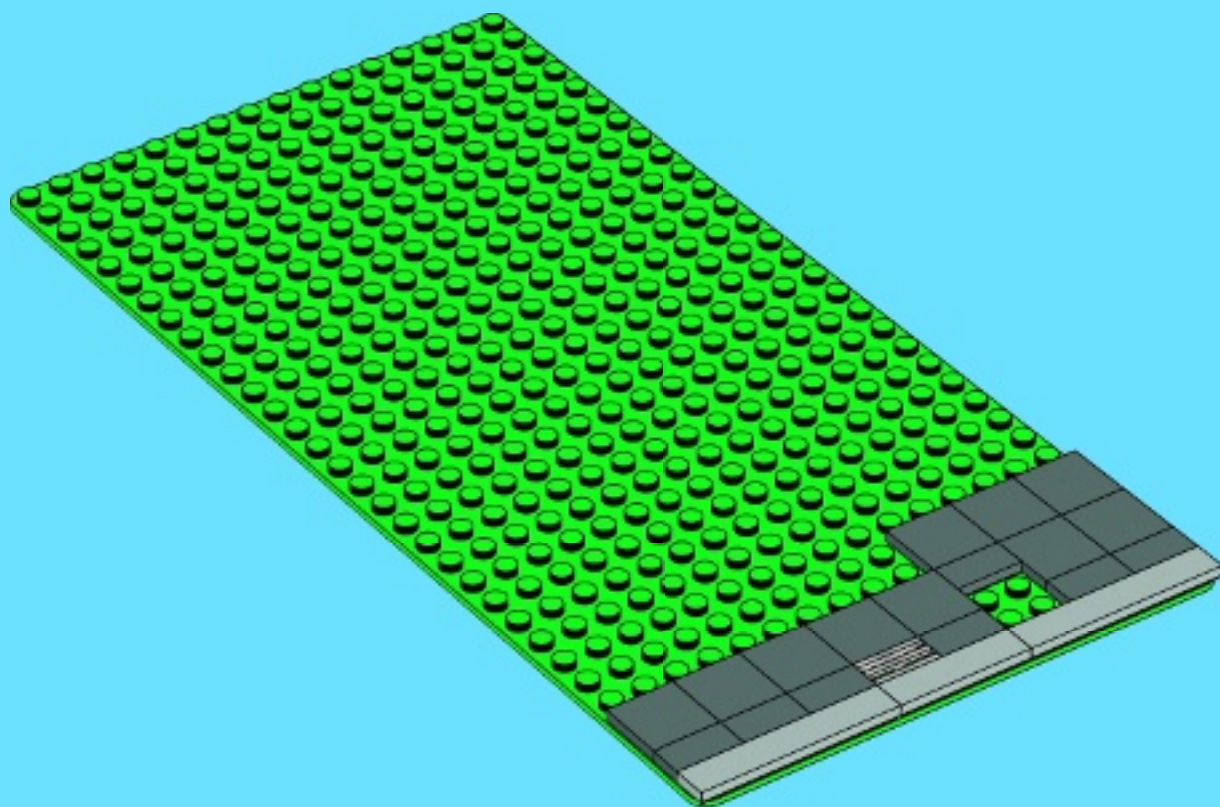



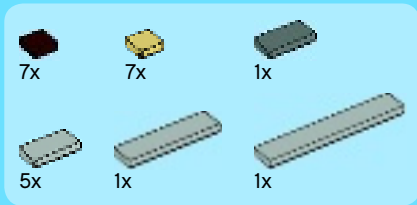

3

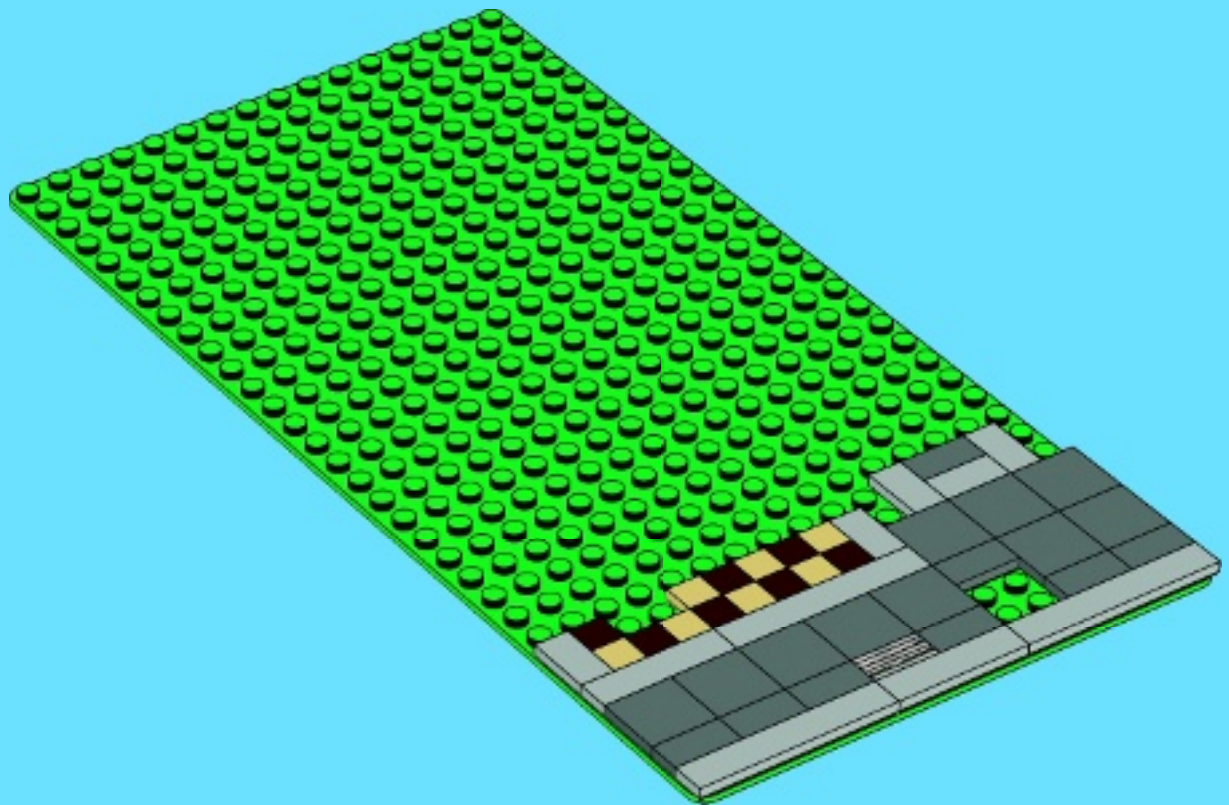

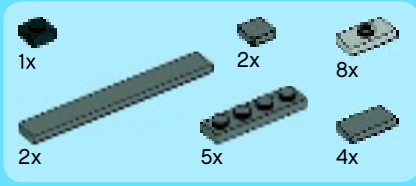

4

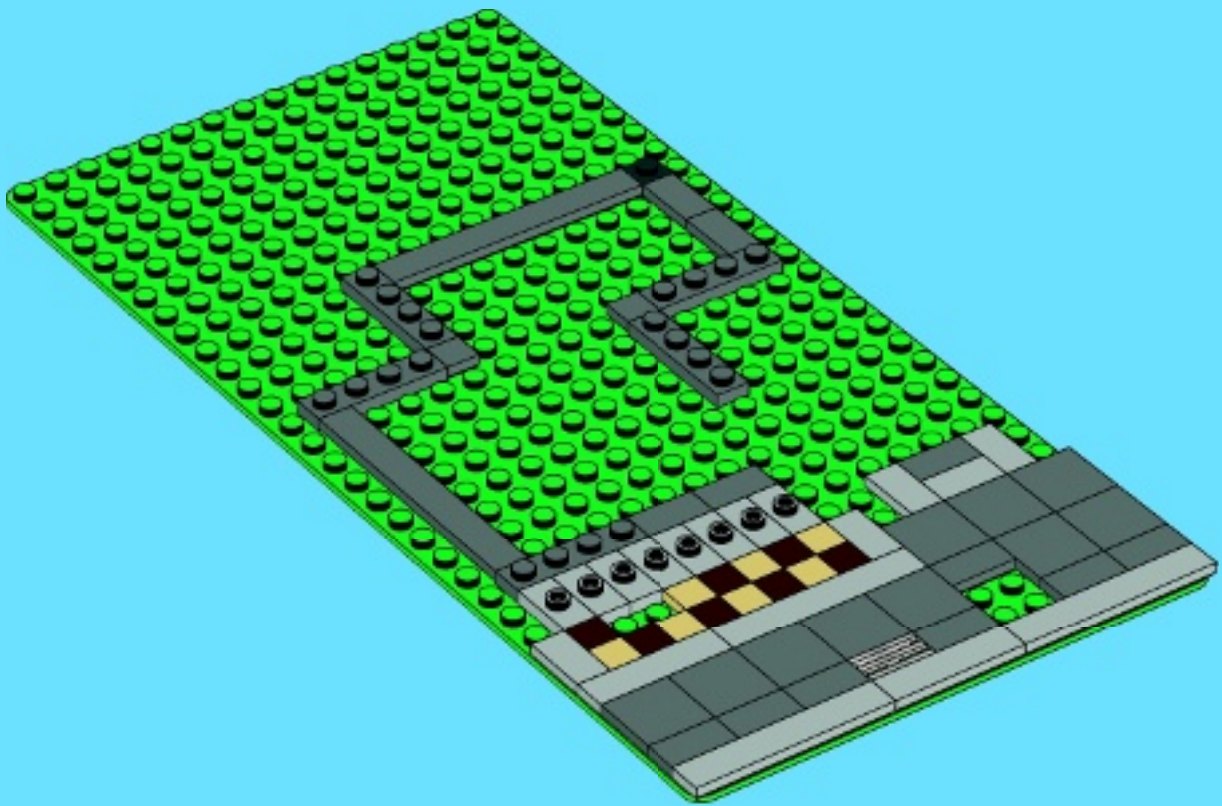



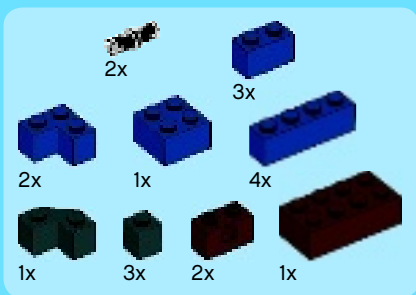

6

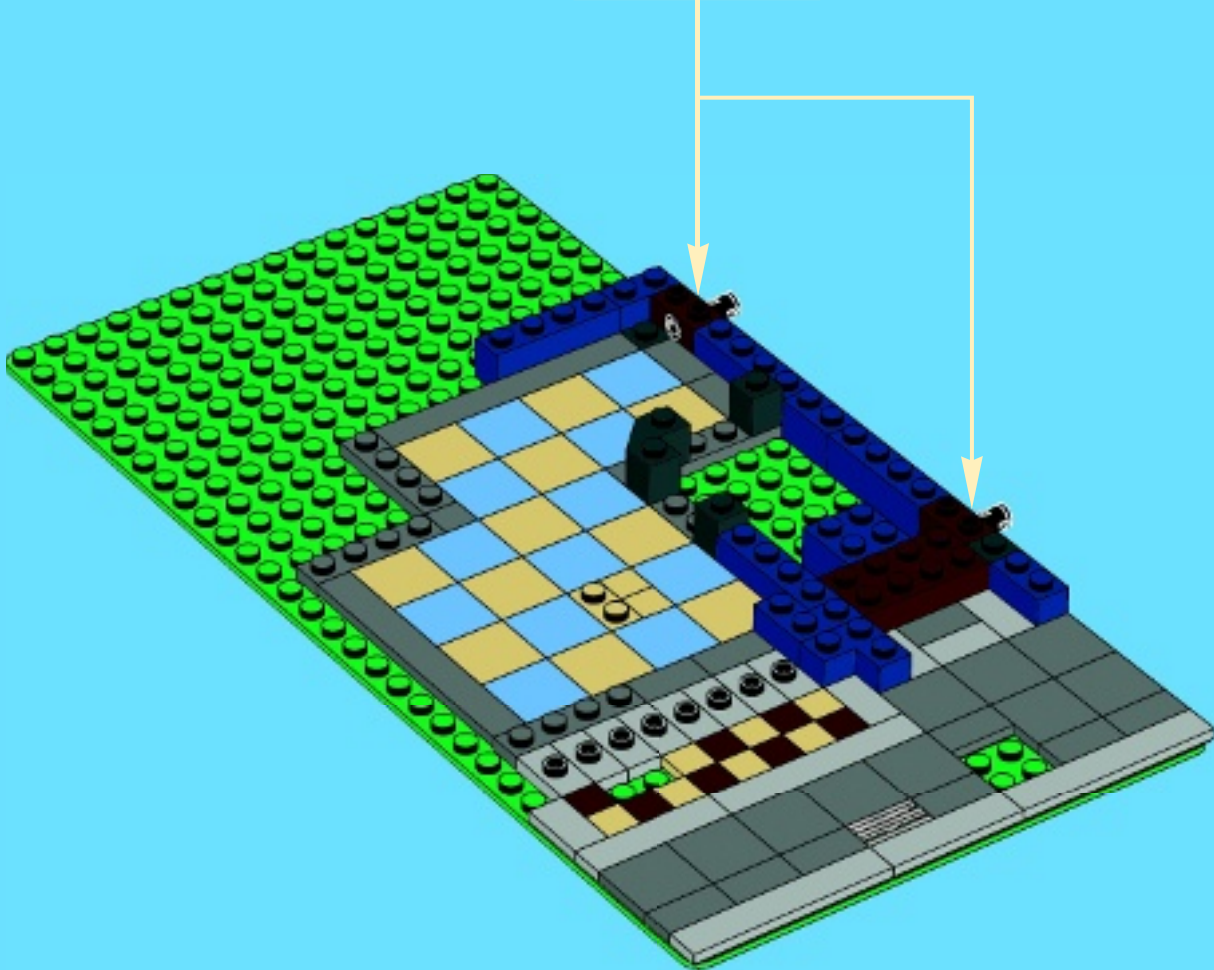
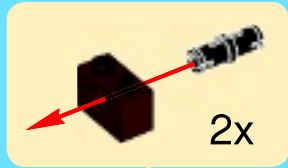

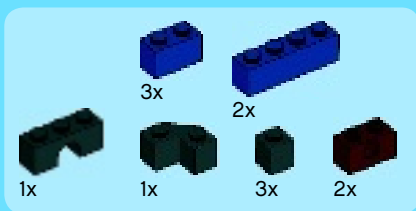

7

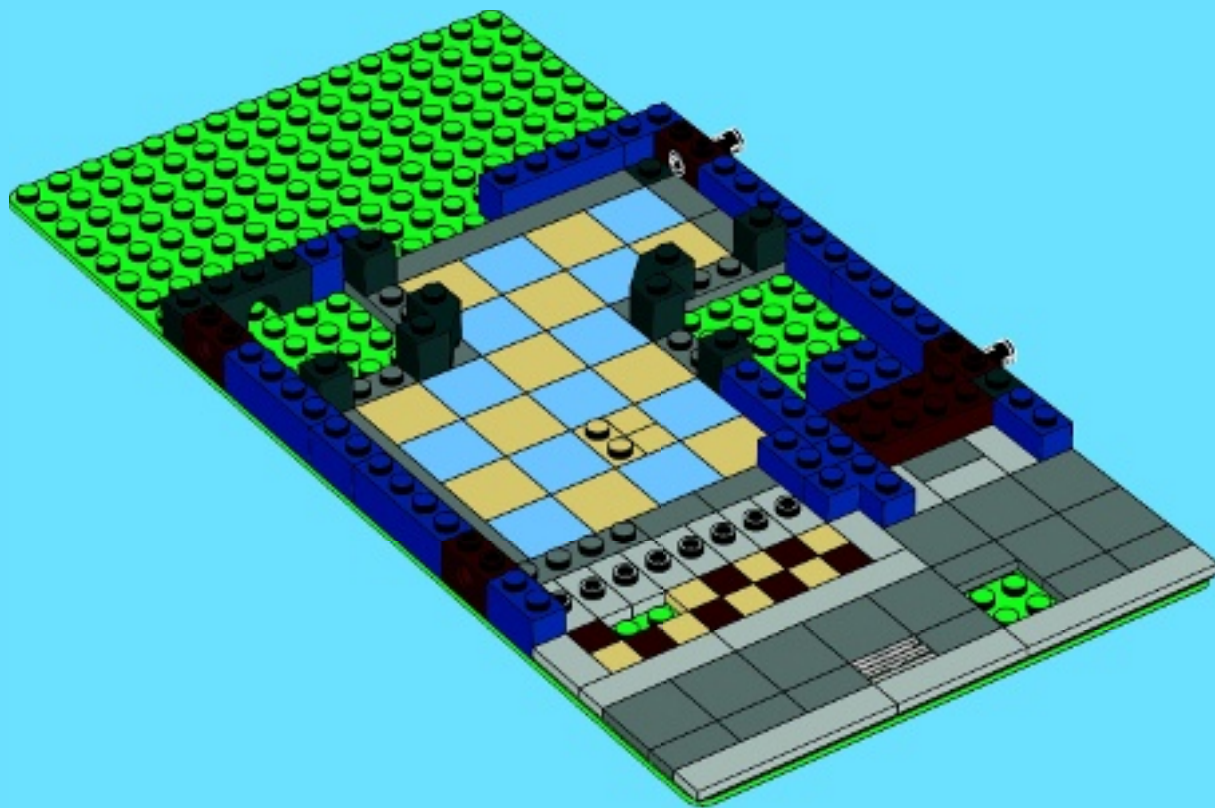



8

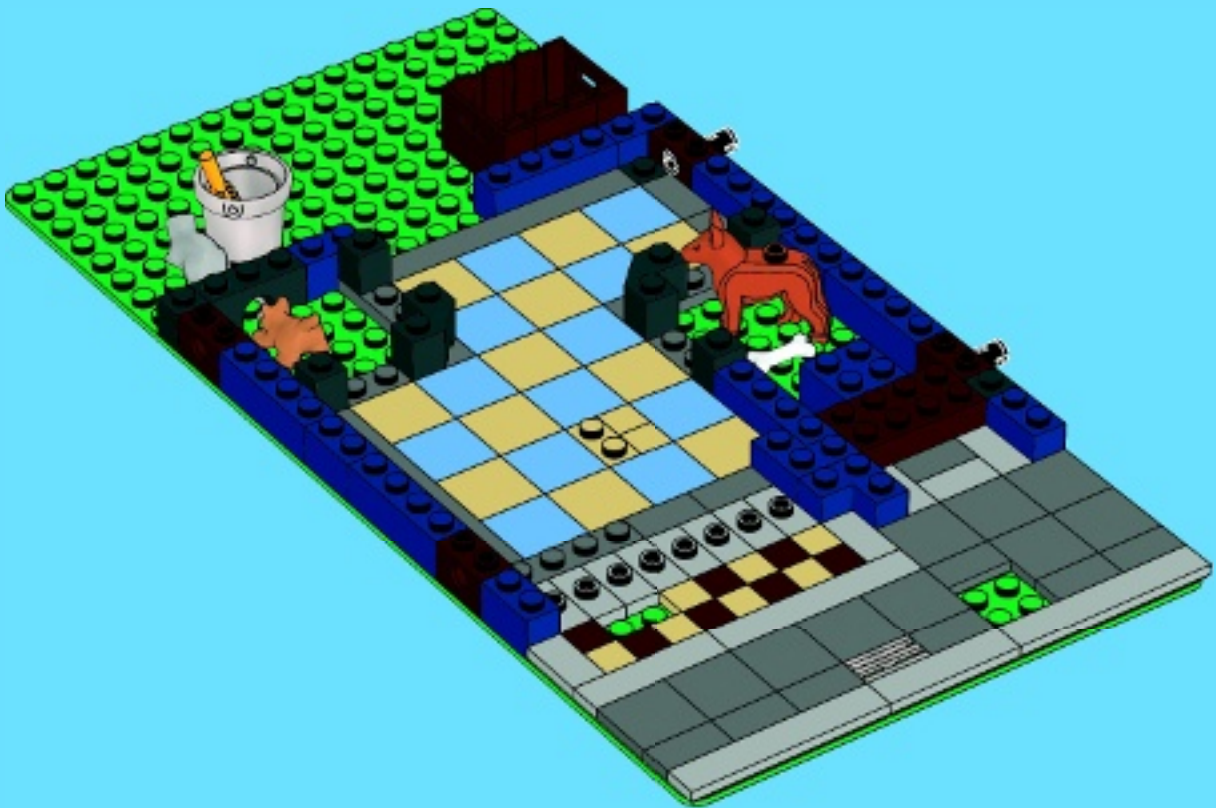

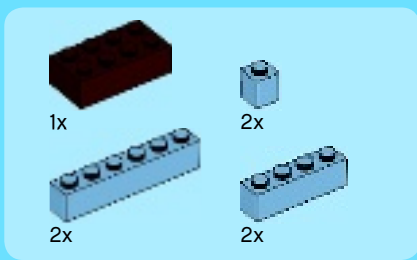

9

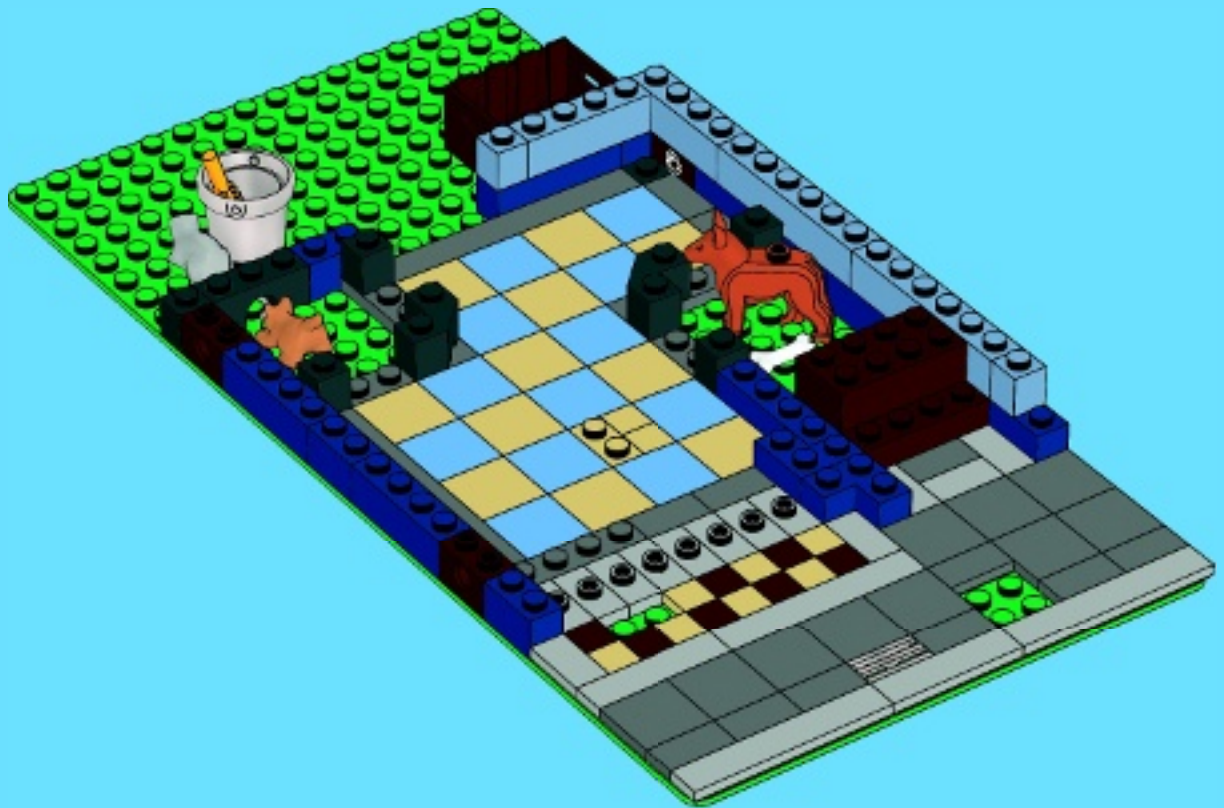



1x



2x



3x



1x

# 10

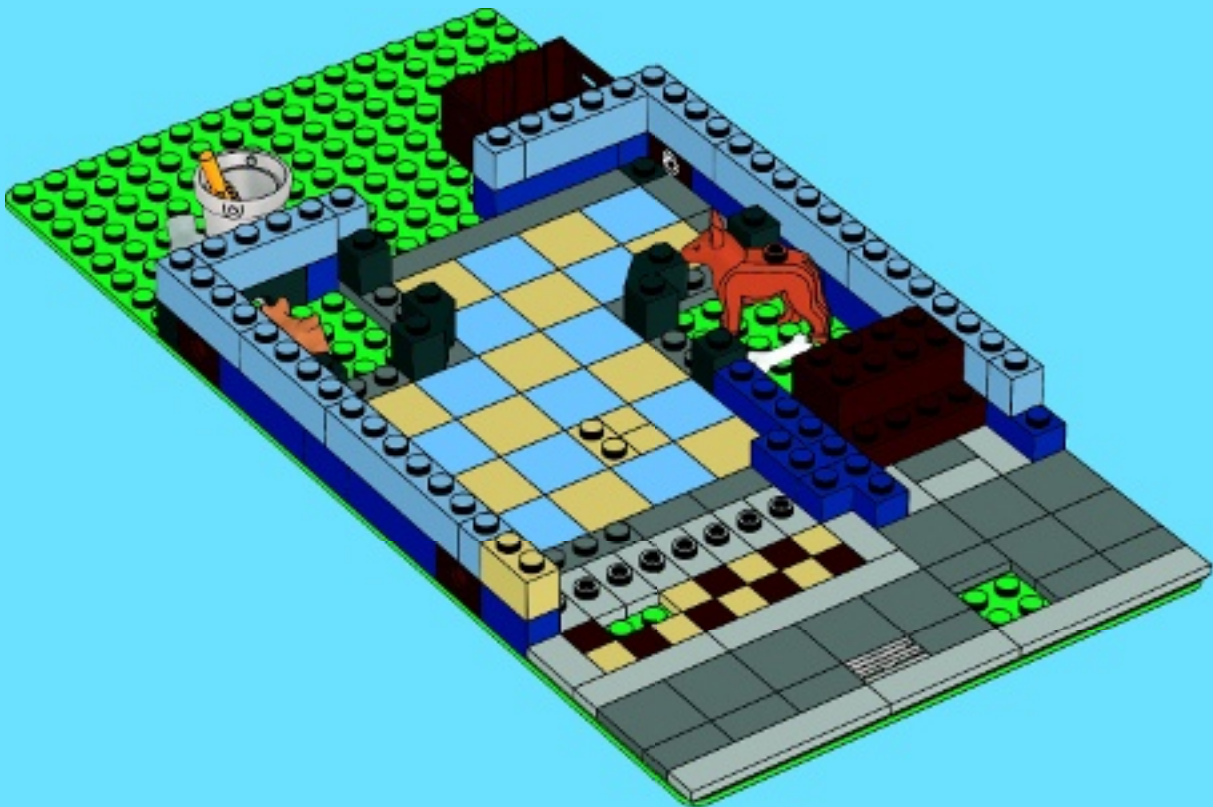



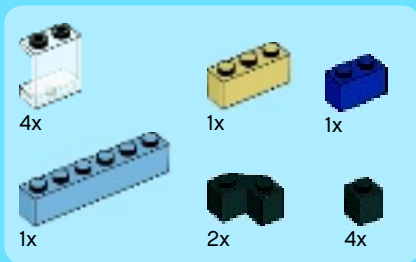

11

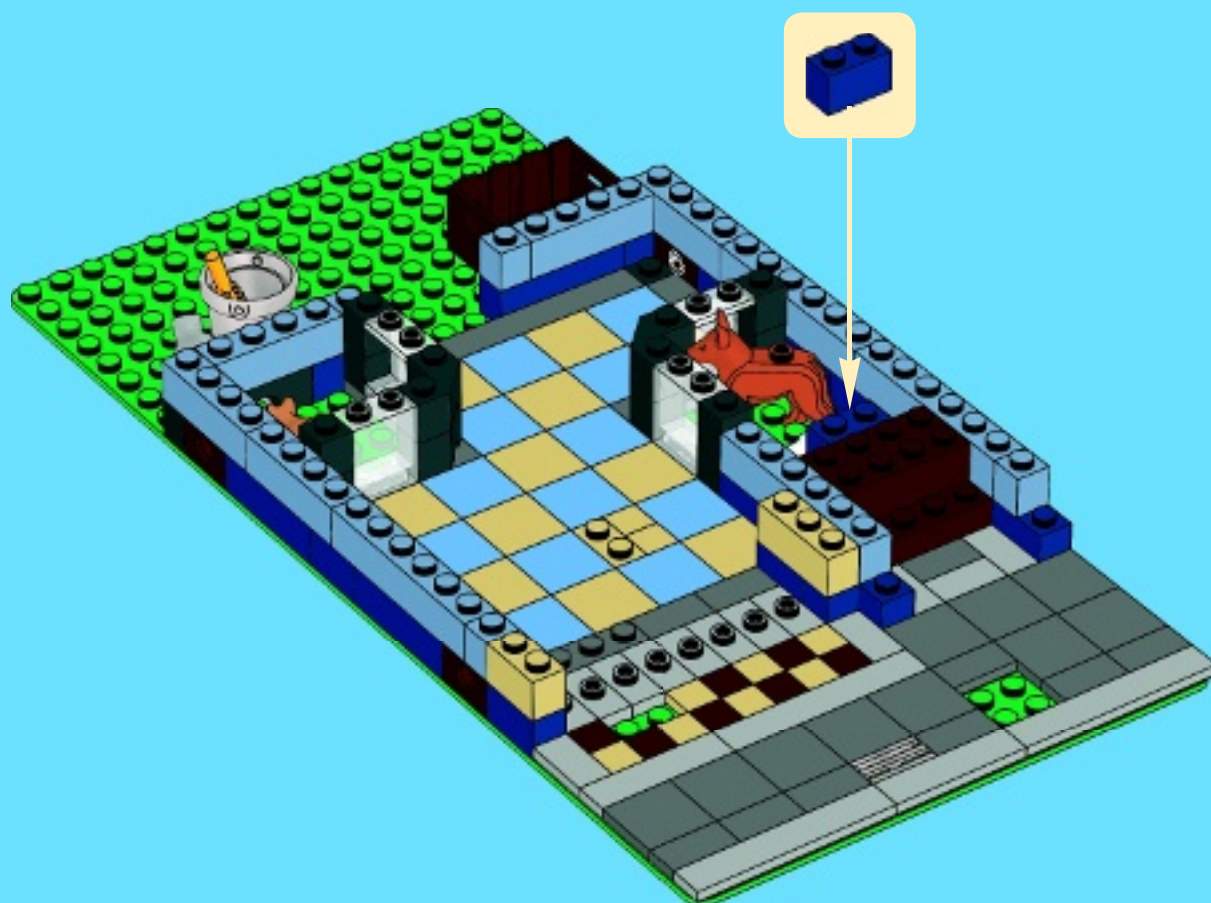

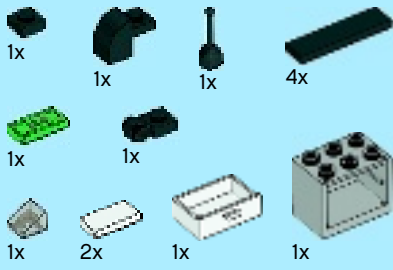

12

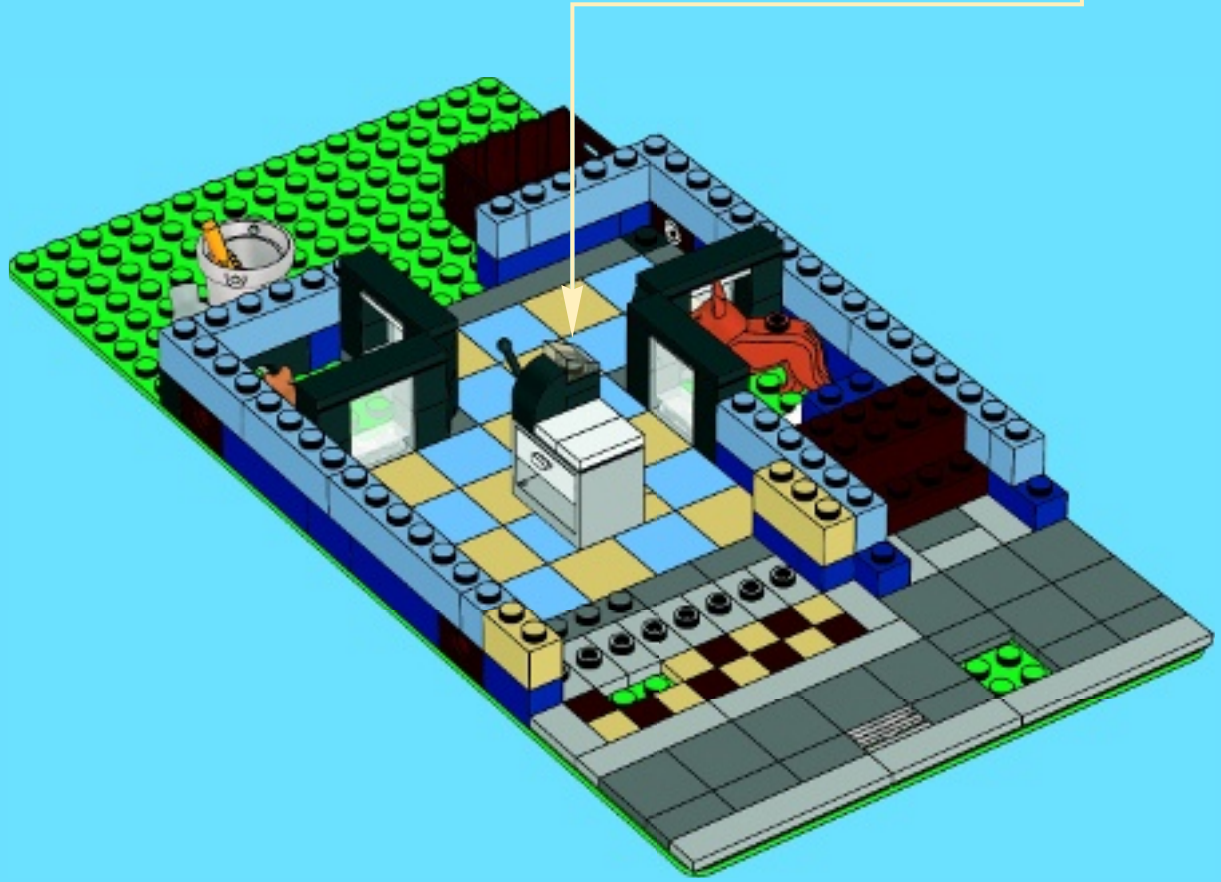
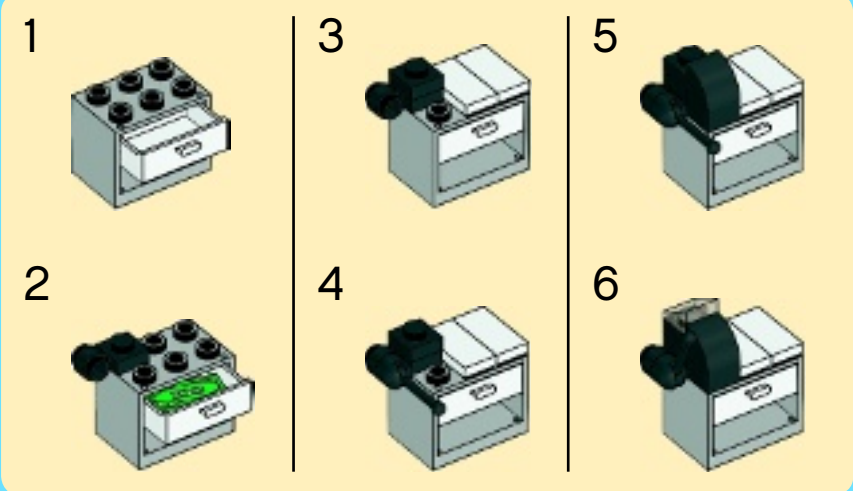

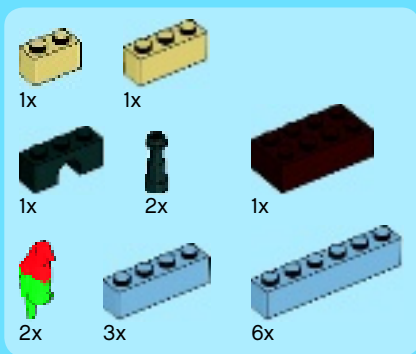

# 13

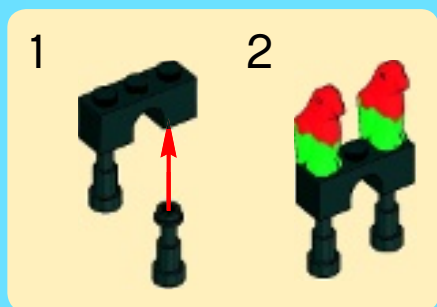
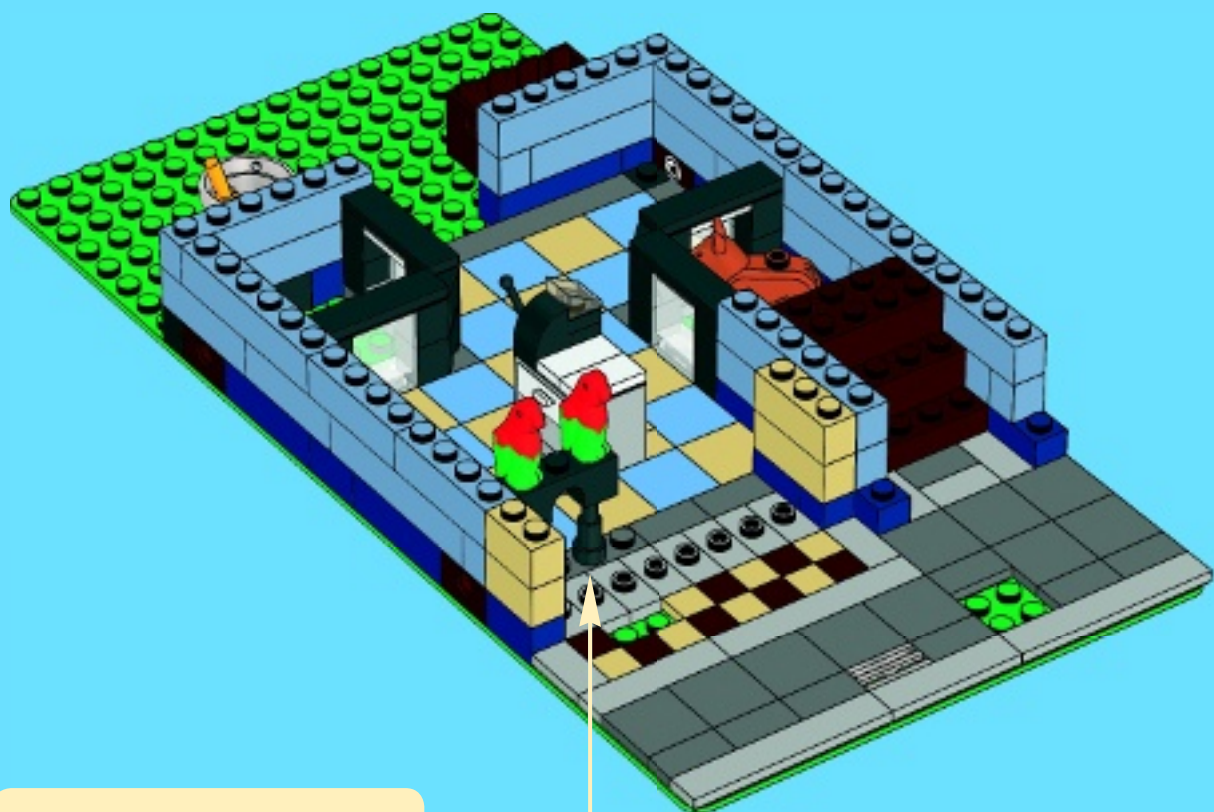

# 14

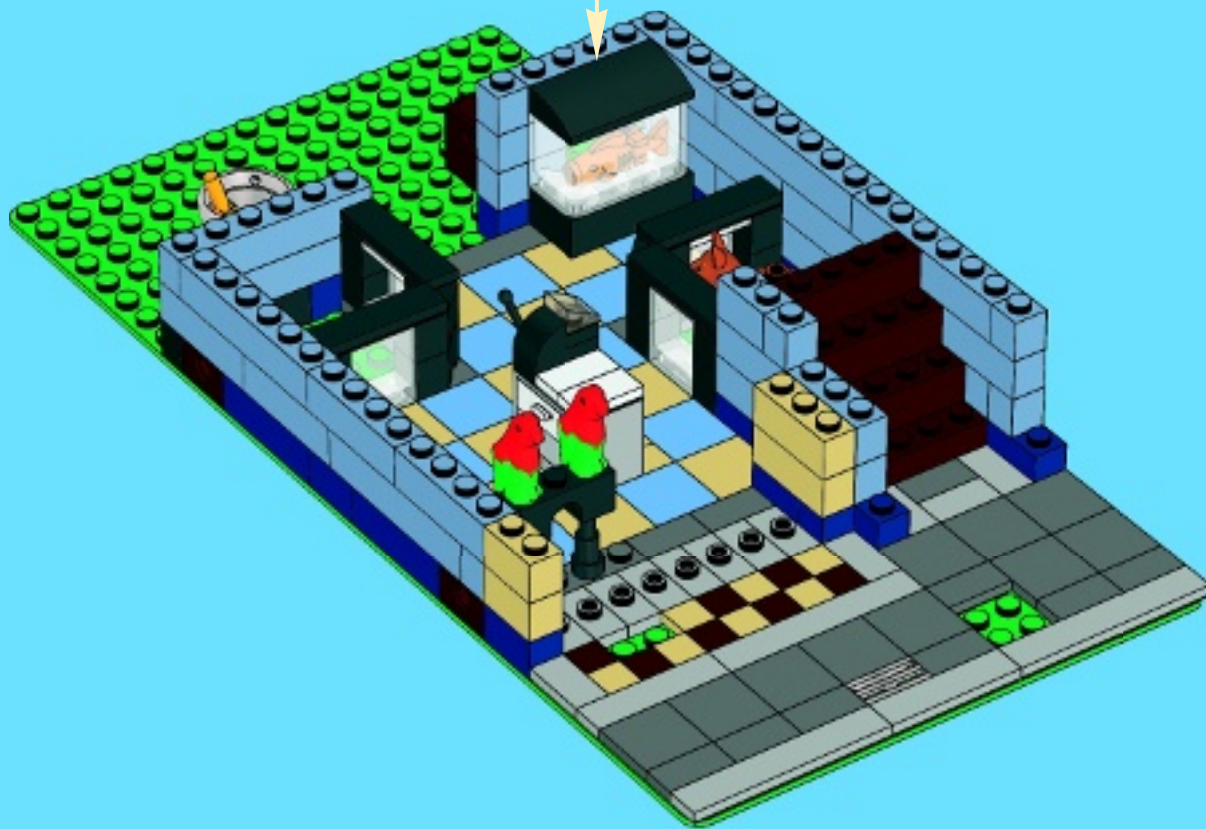
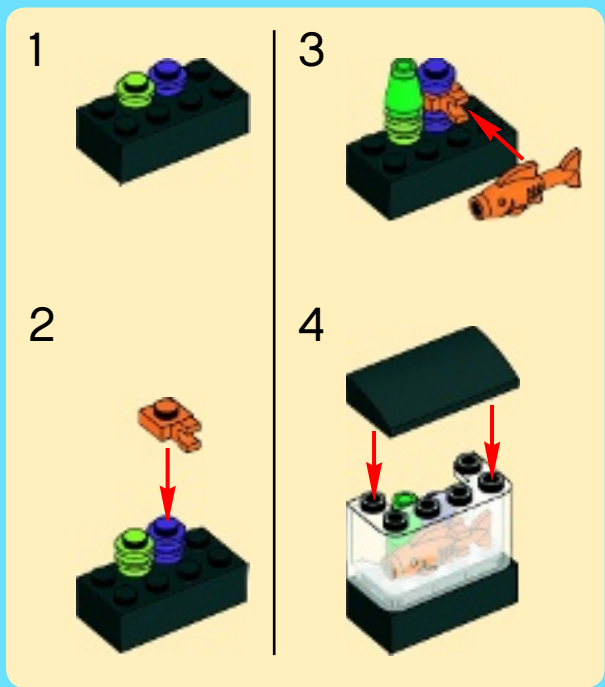
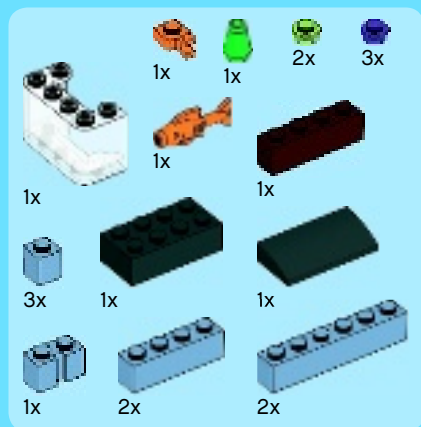

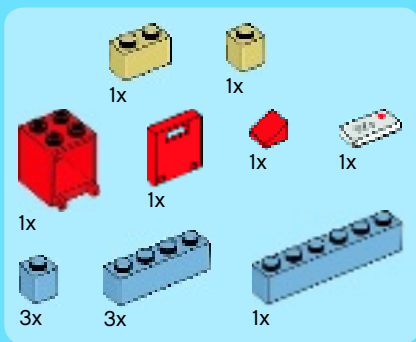

15

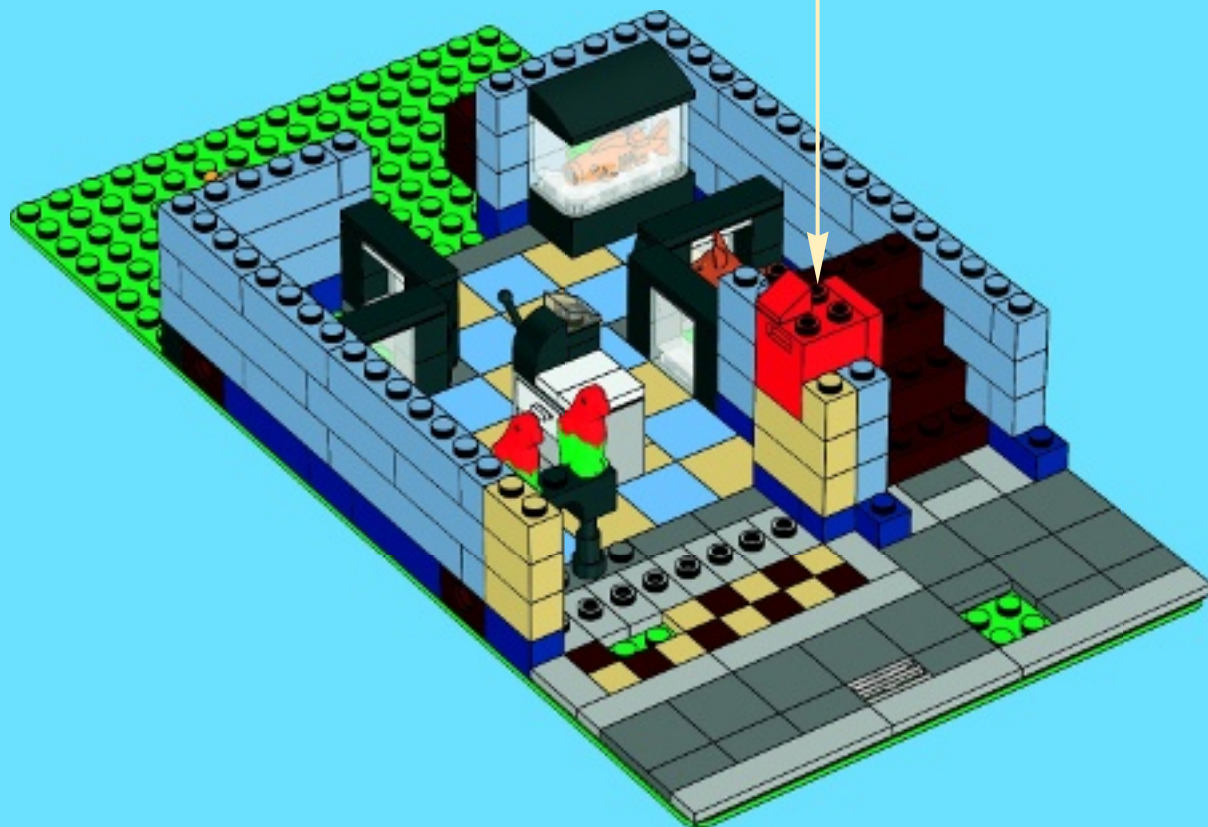
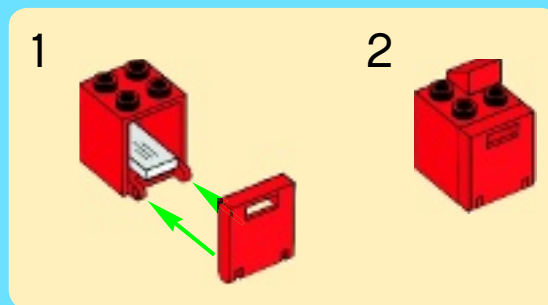



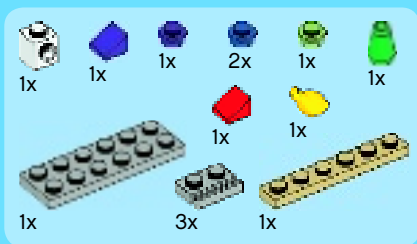

17

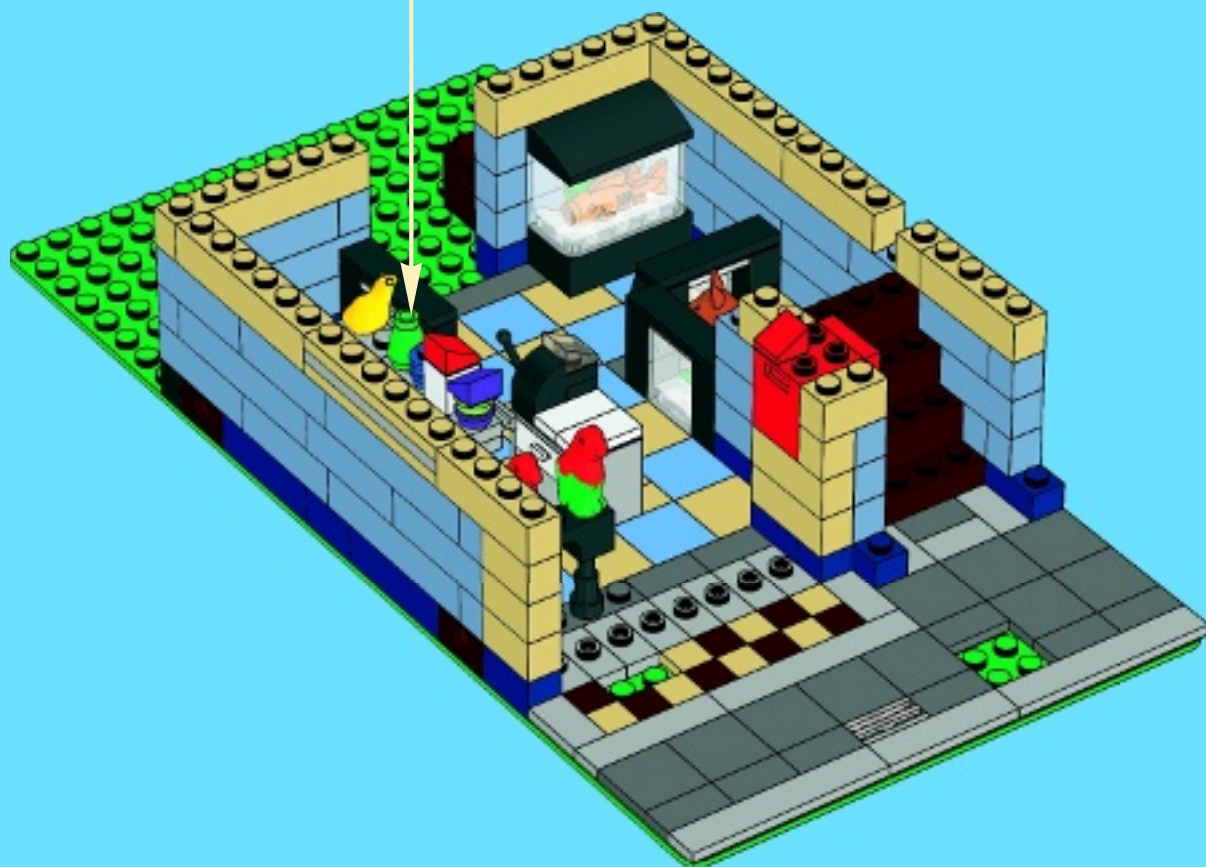
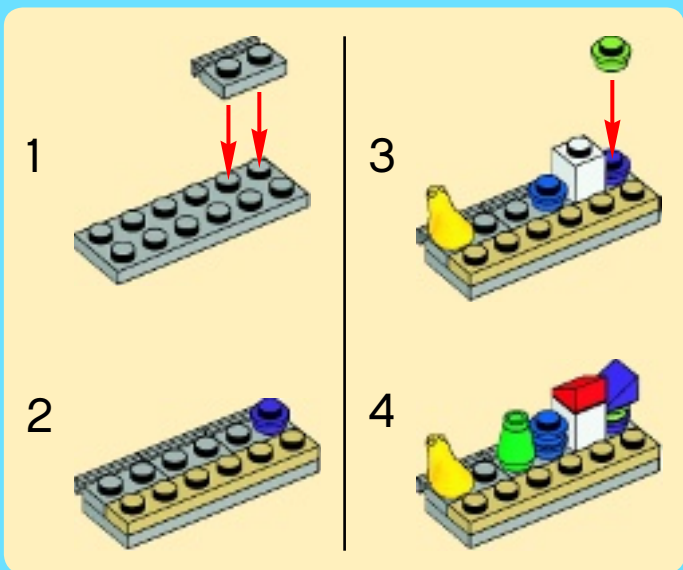

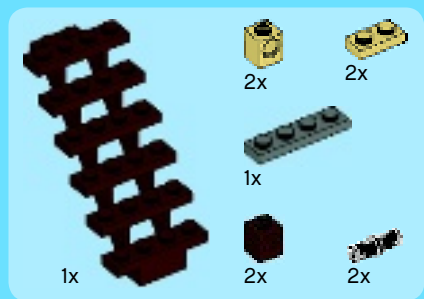

18

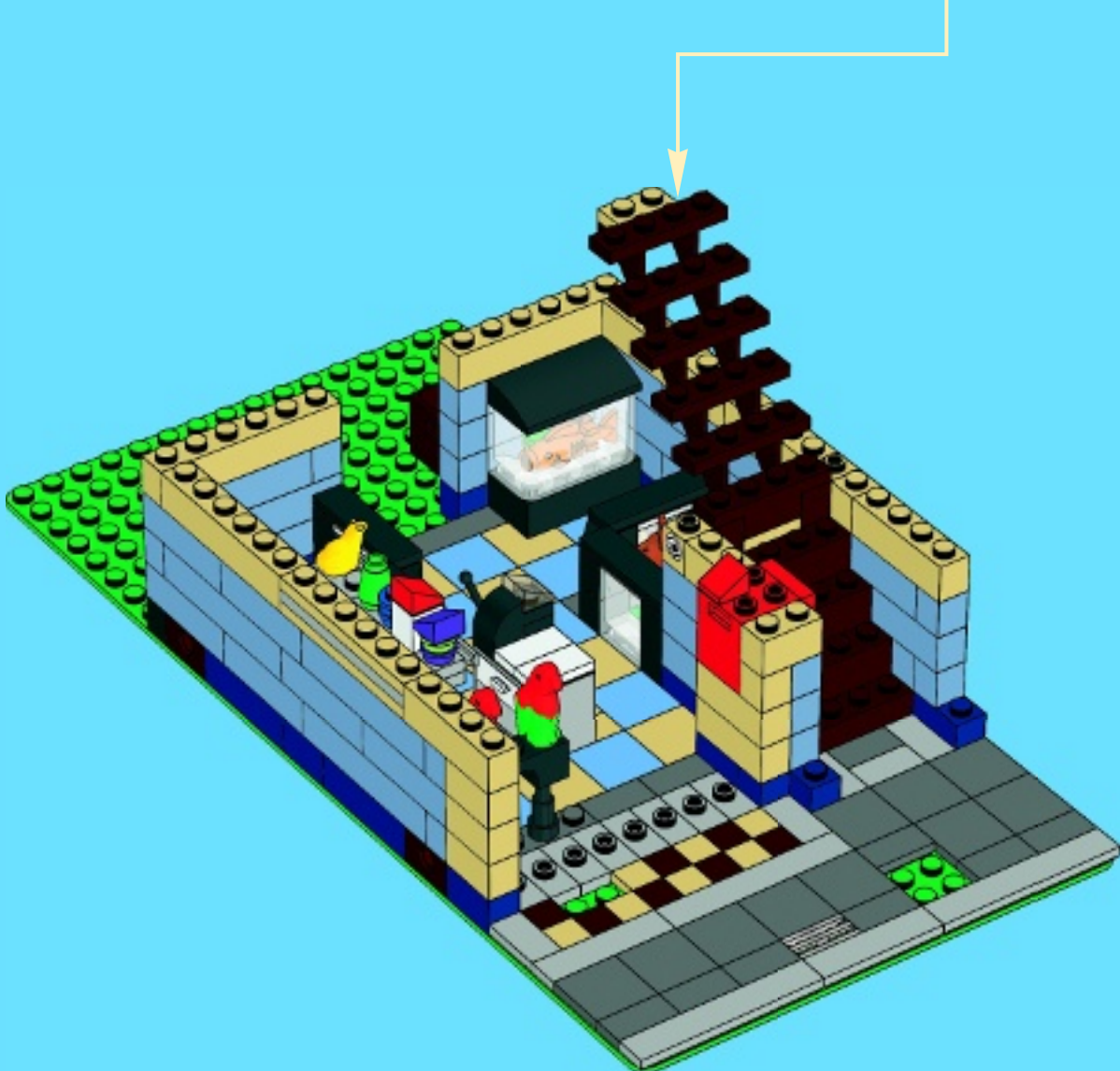
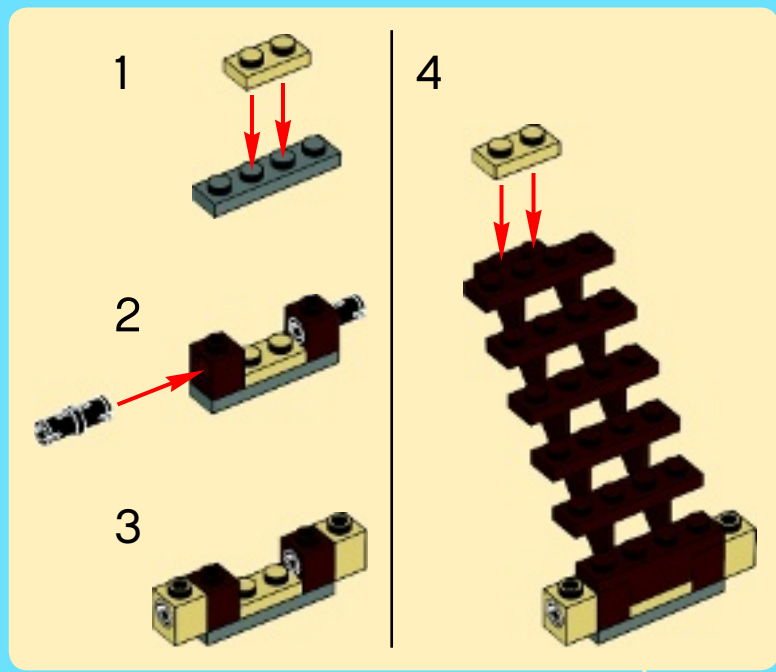



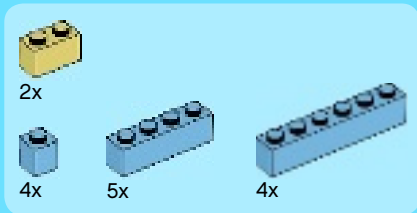

19

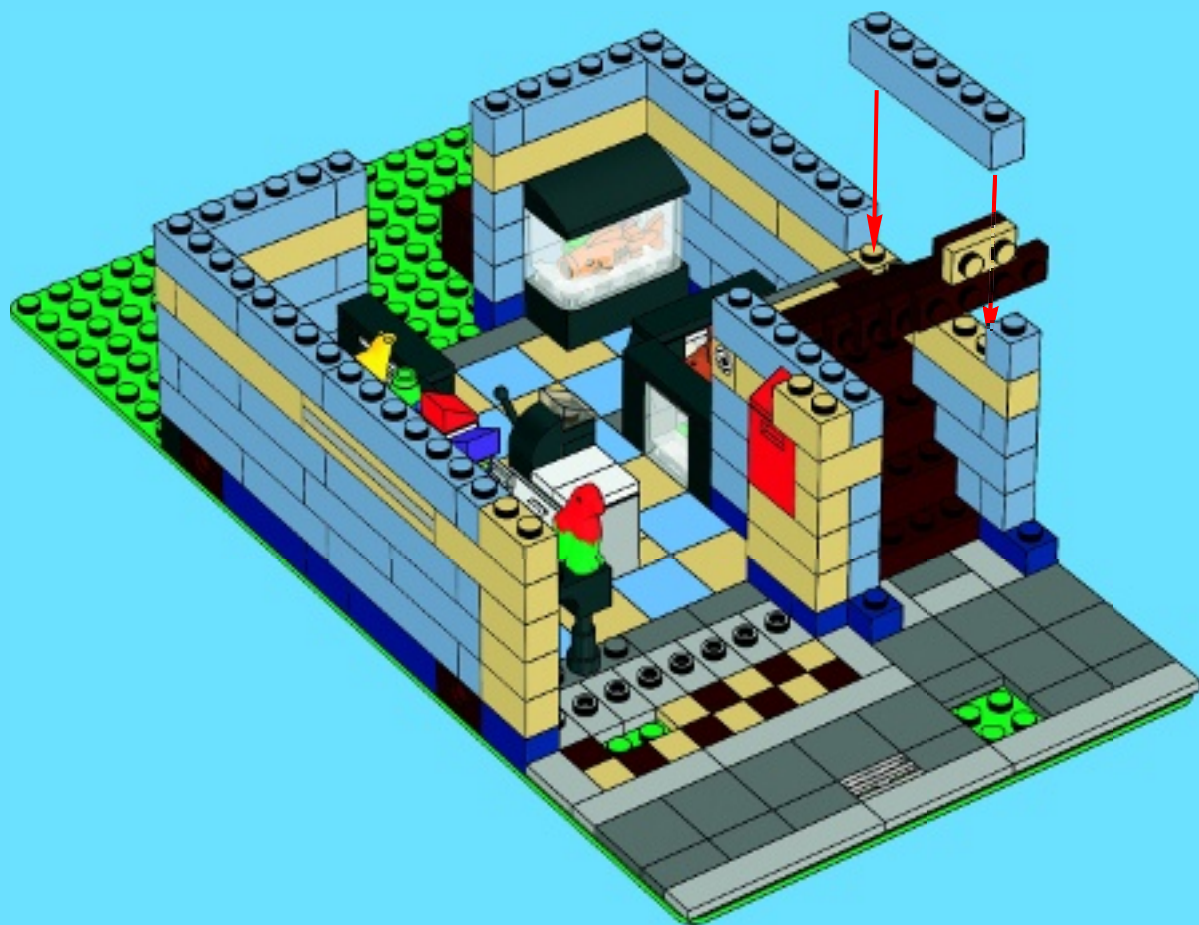

20

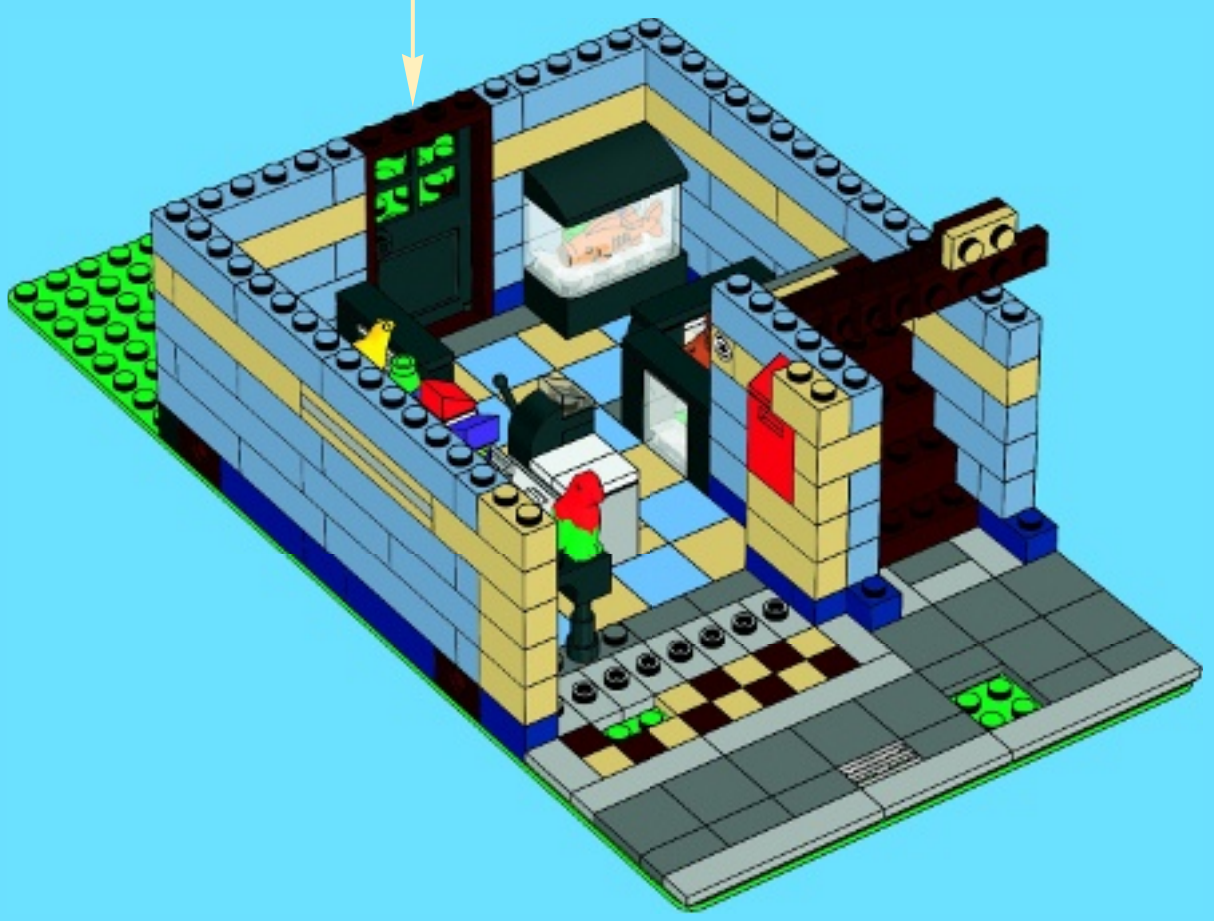
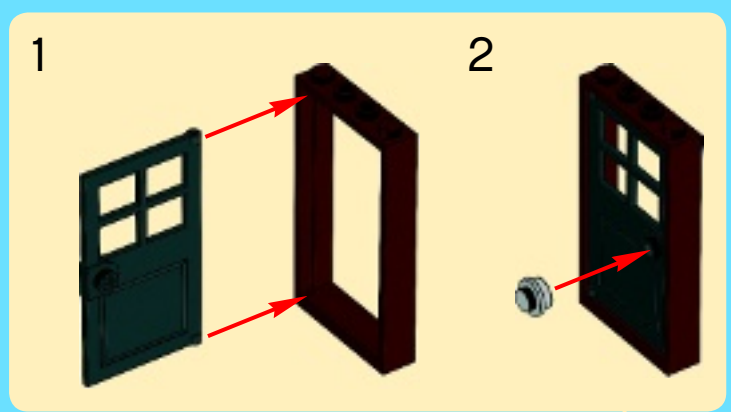
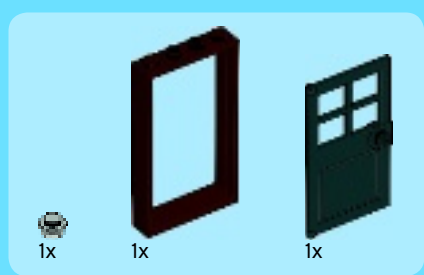

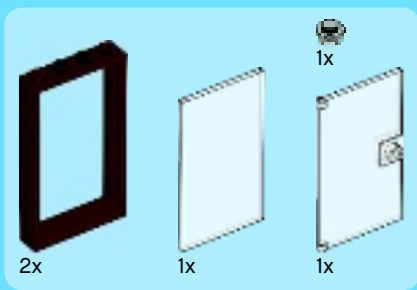

21

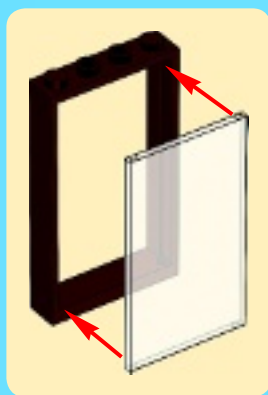
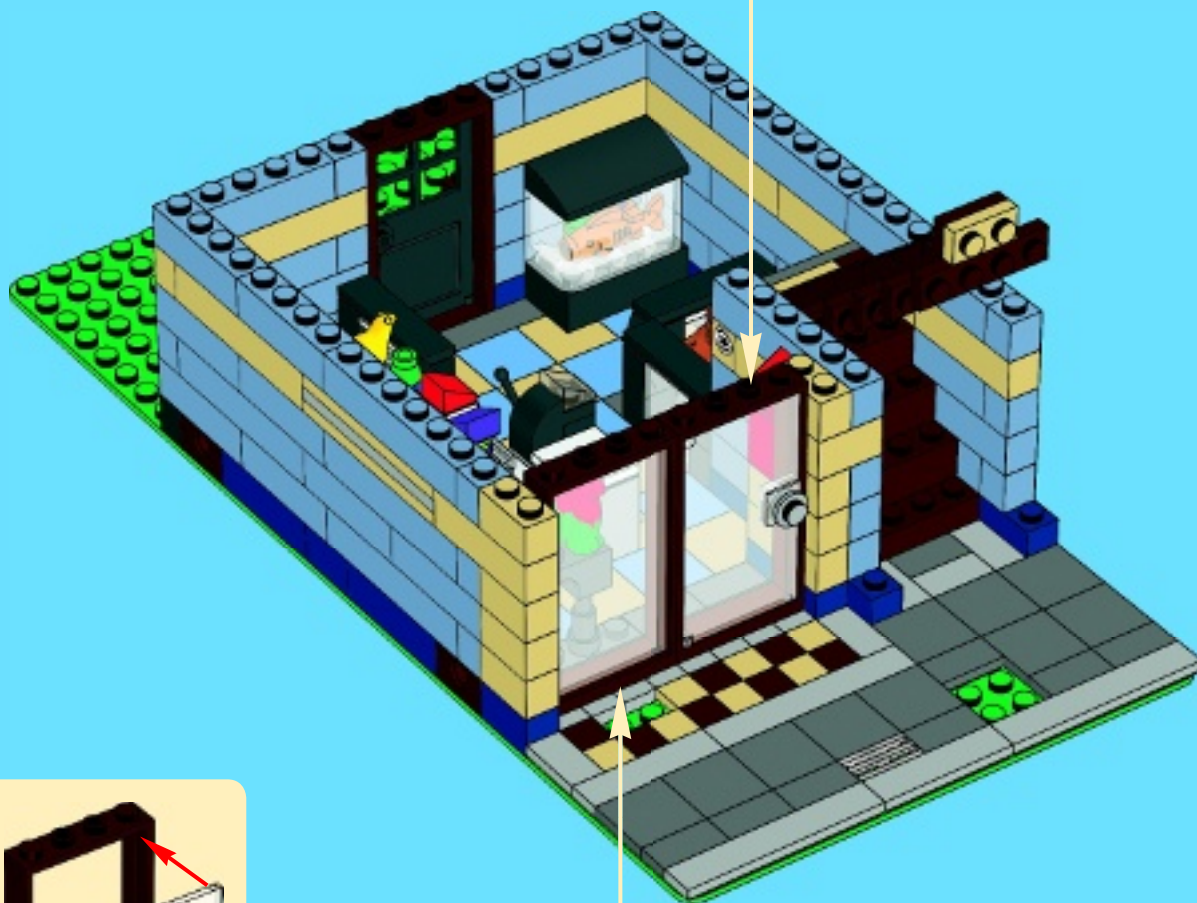
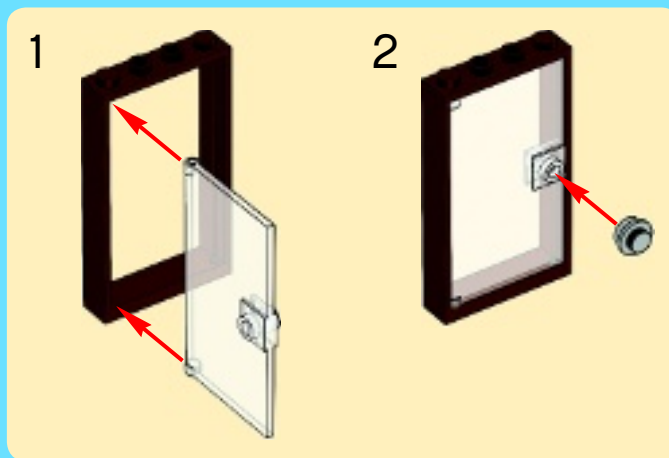

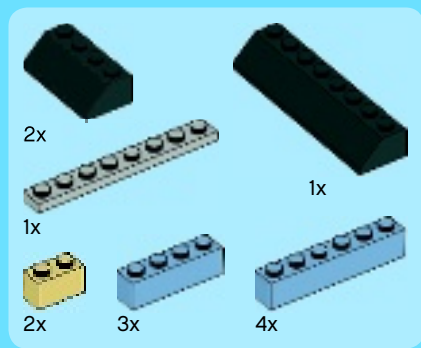

22

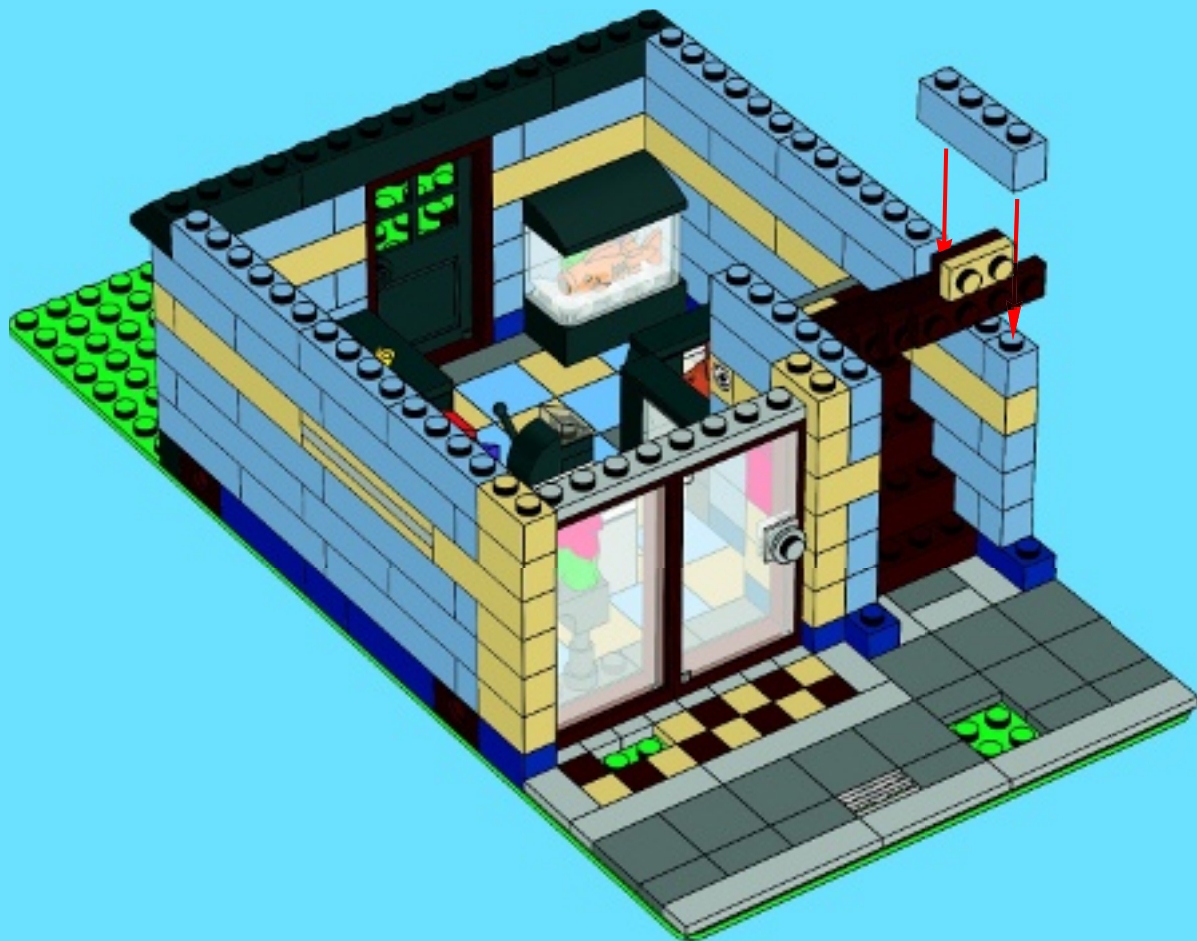



23

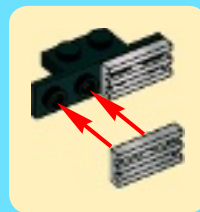

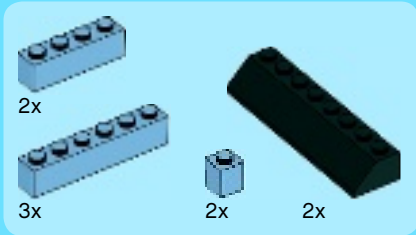

24



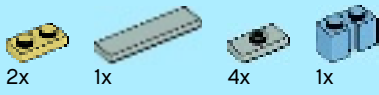

25

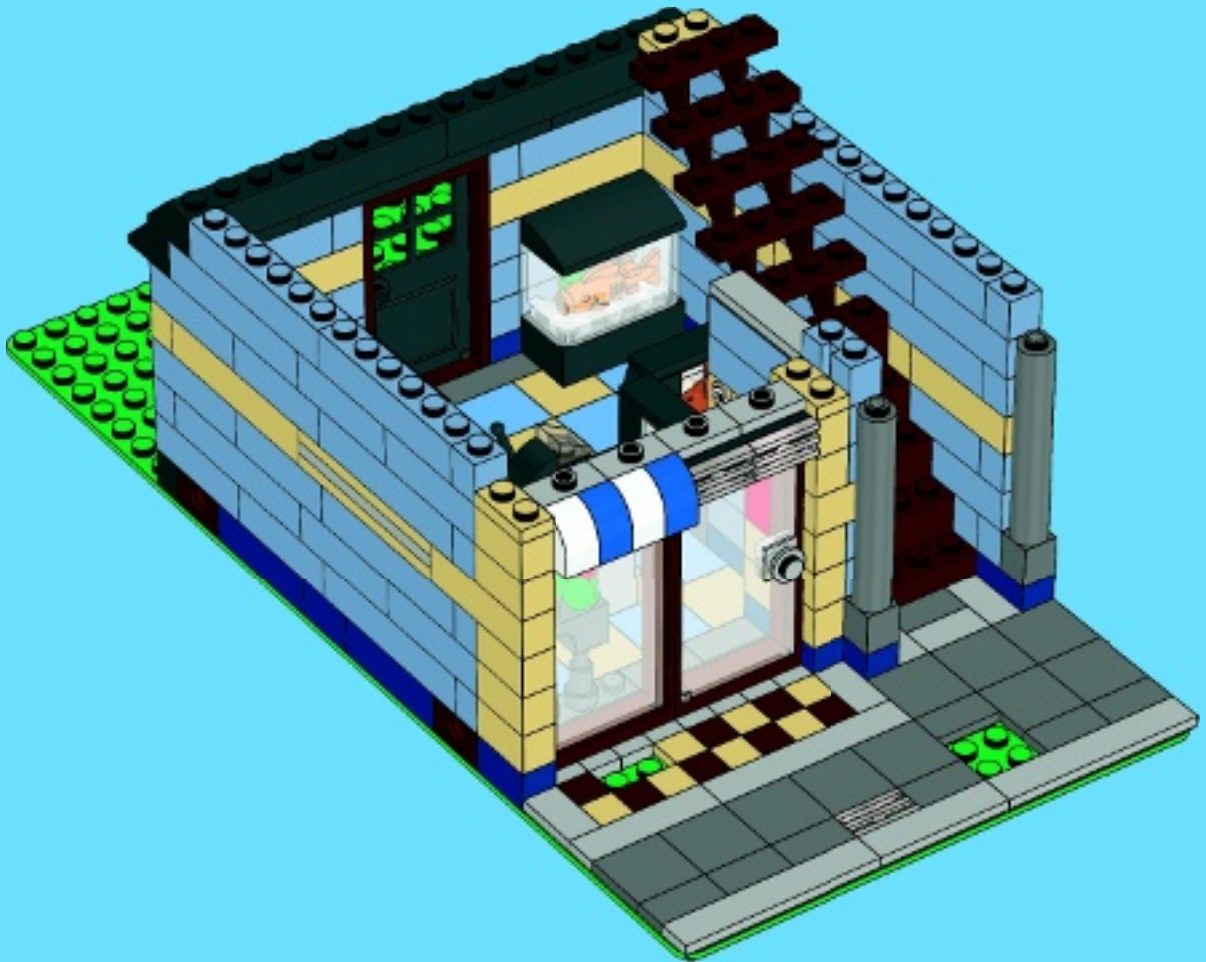

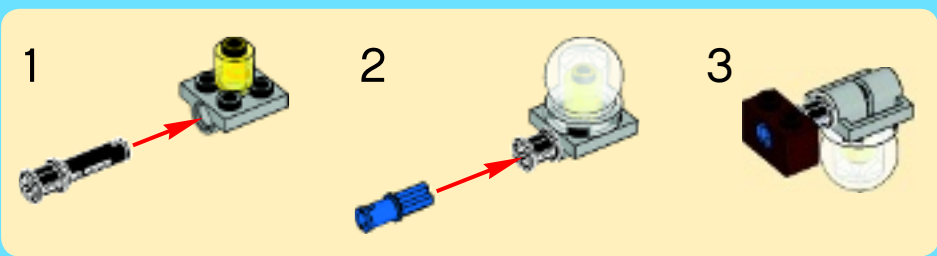
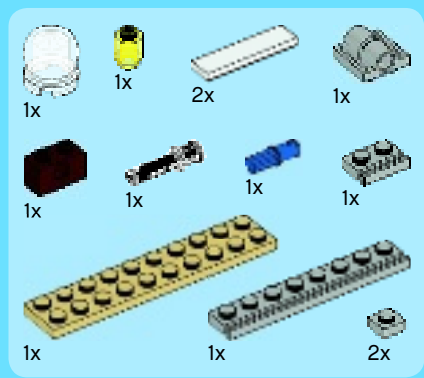

26

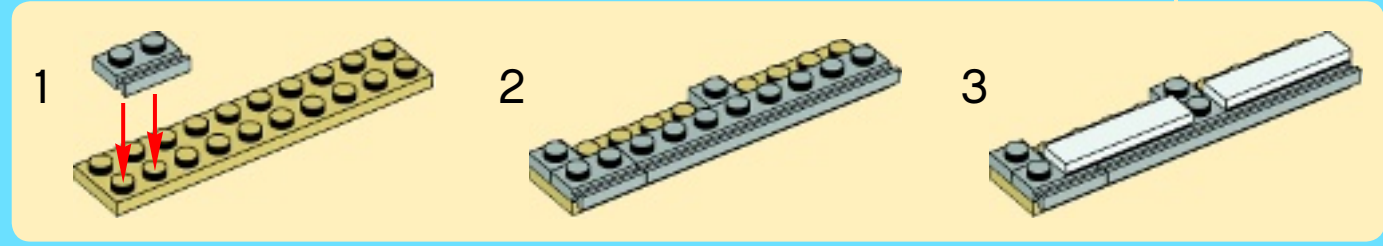
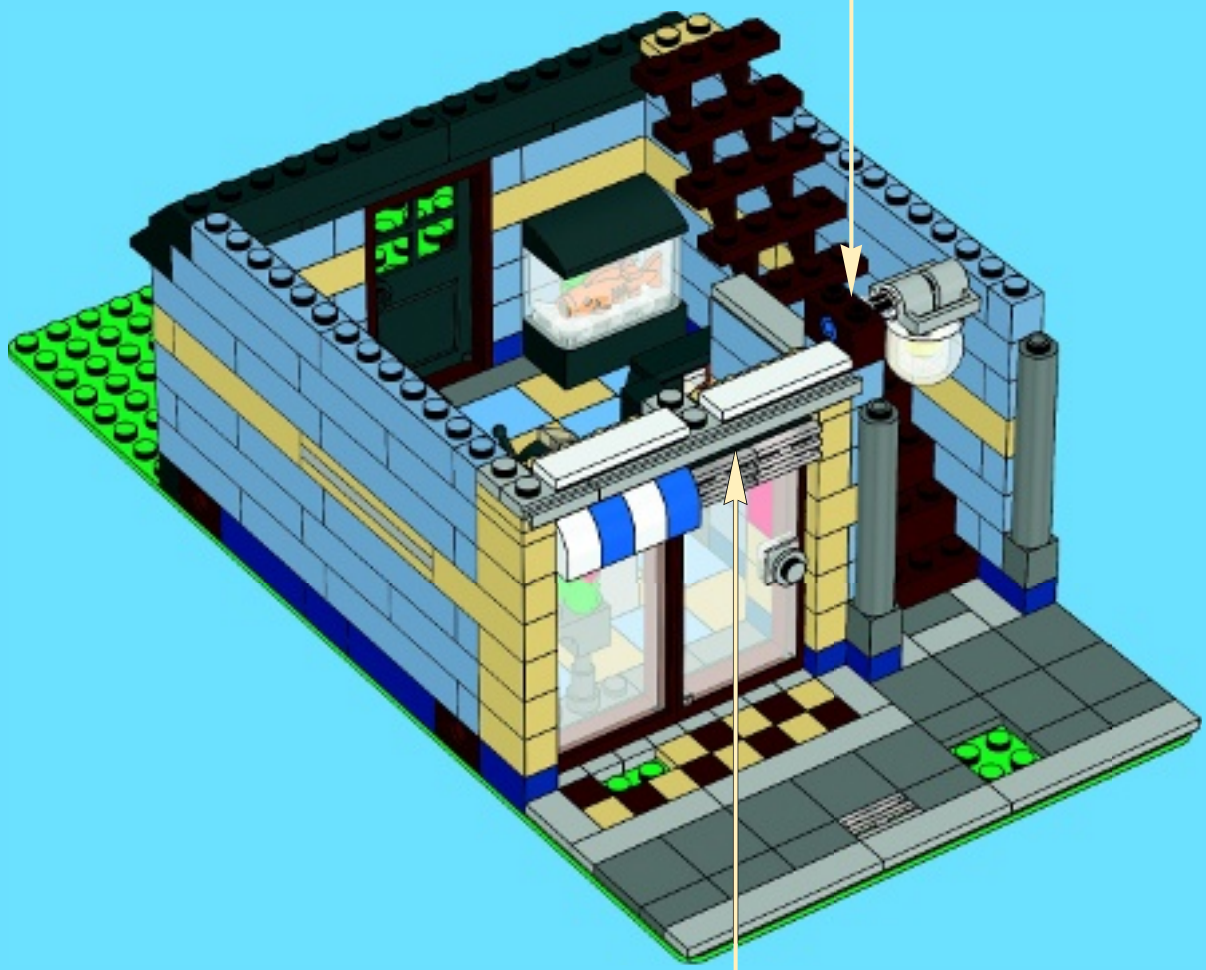



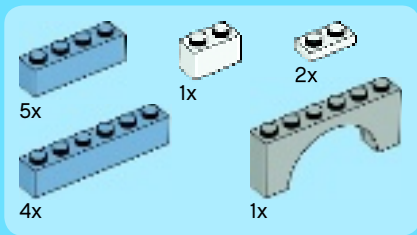

27

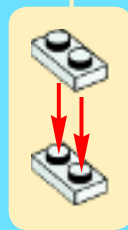
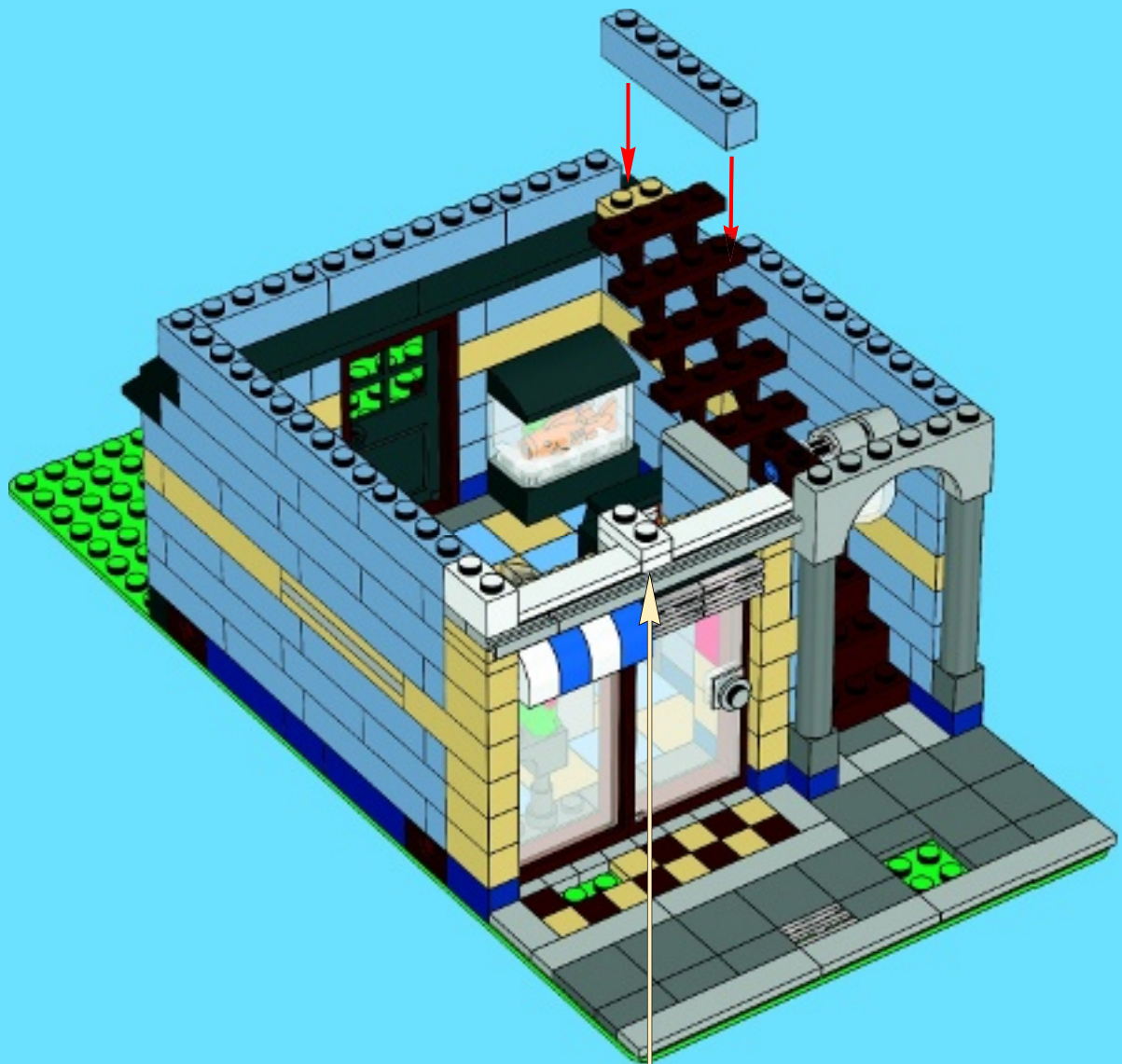

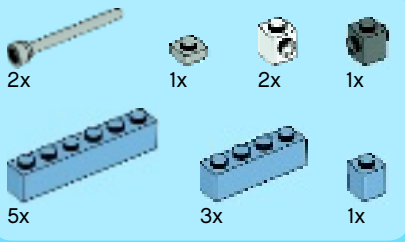

28

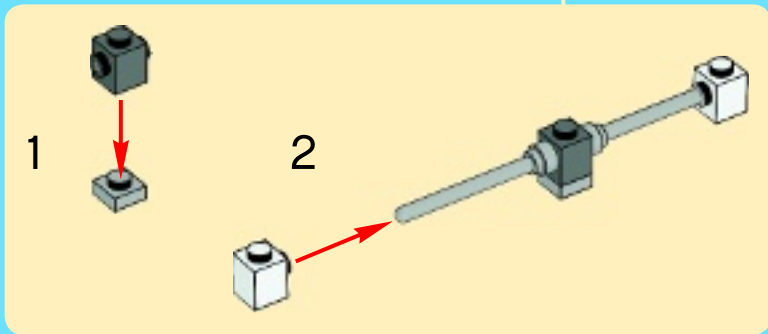
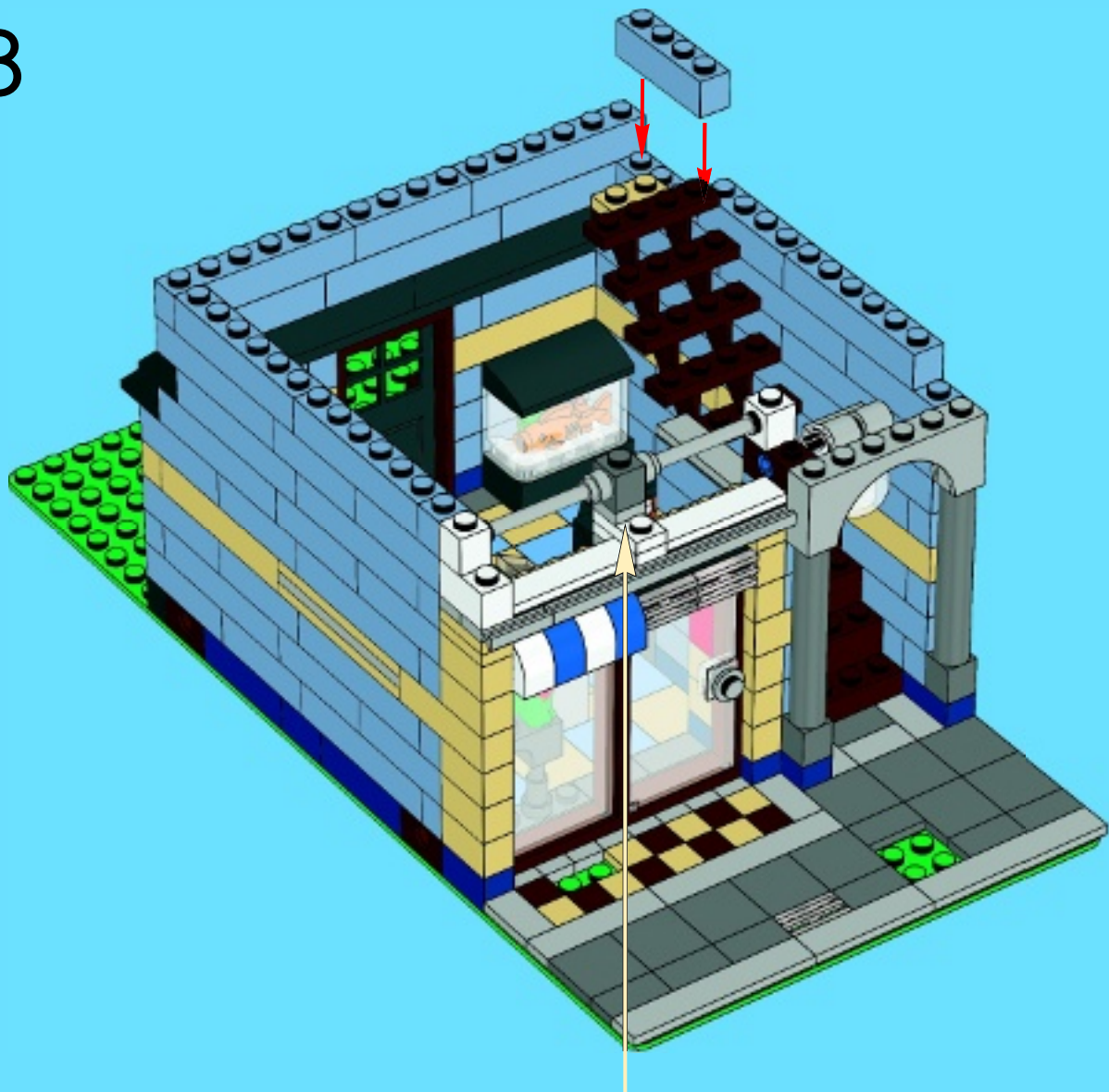

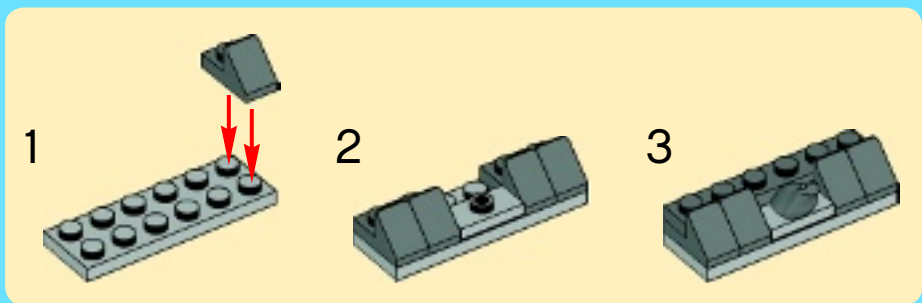
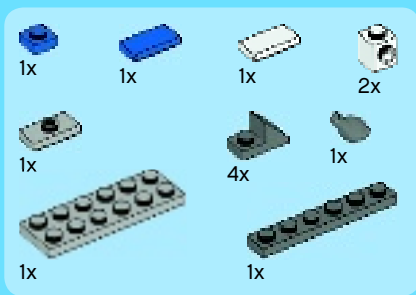

29

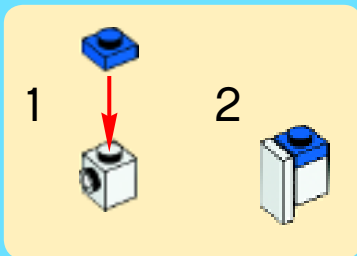
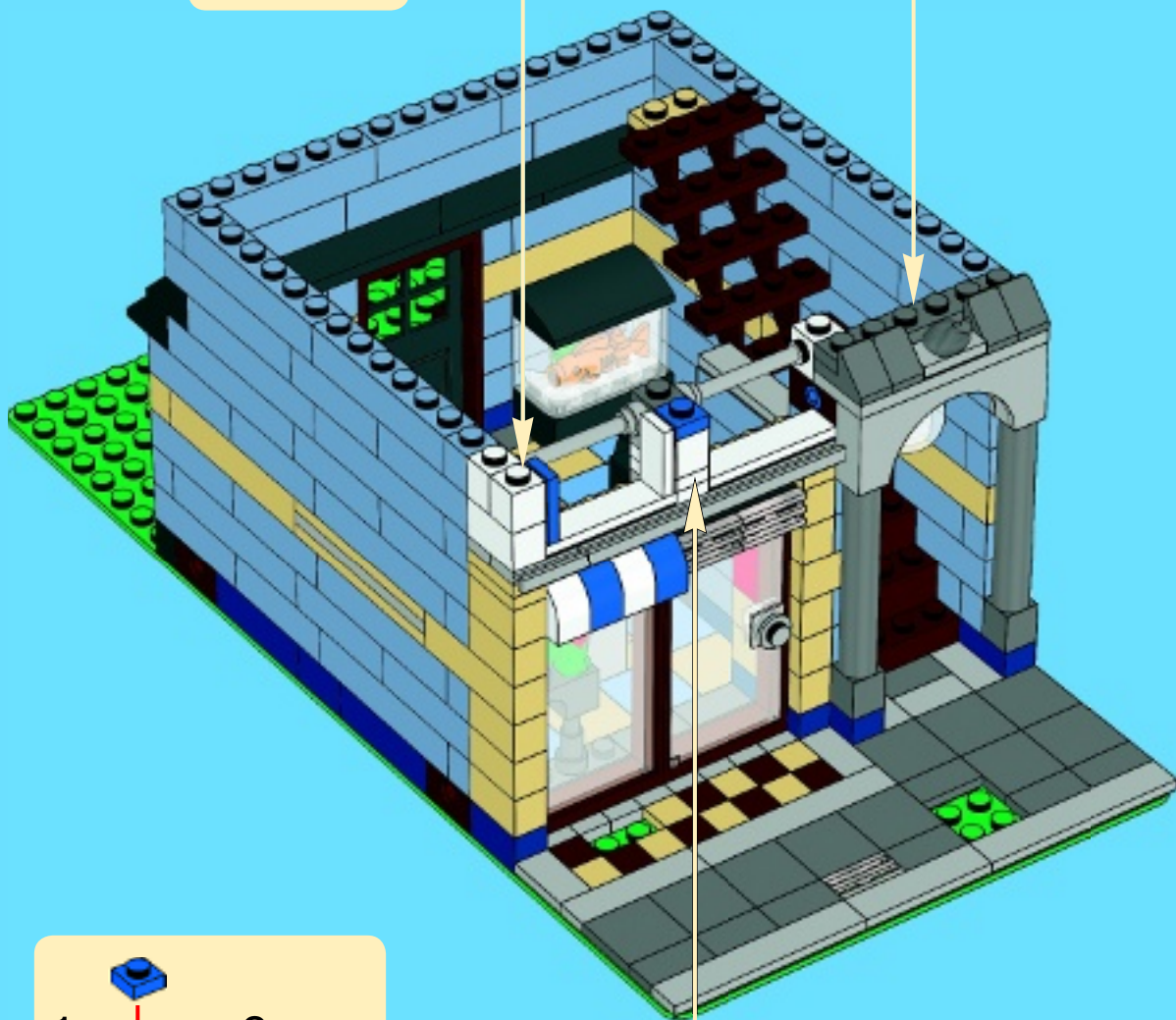
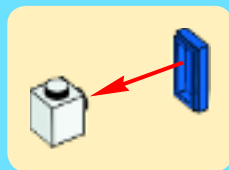



1x



1x



1x



1x



3x



1x

# 30

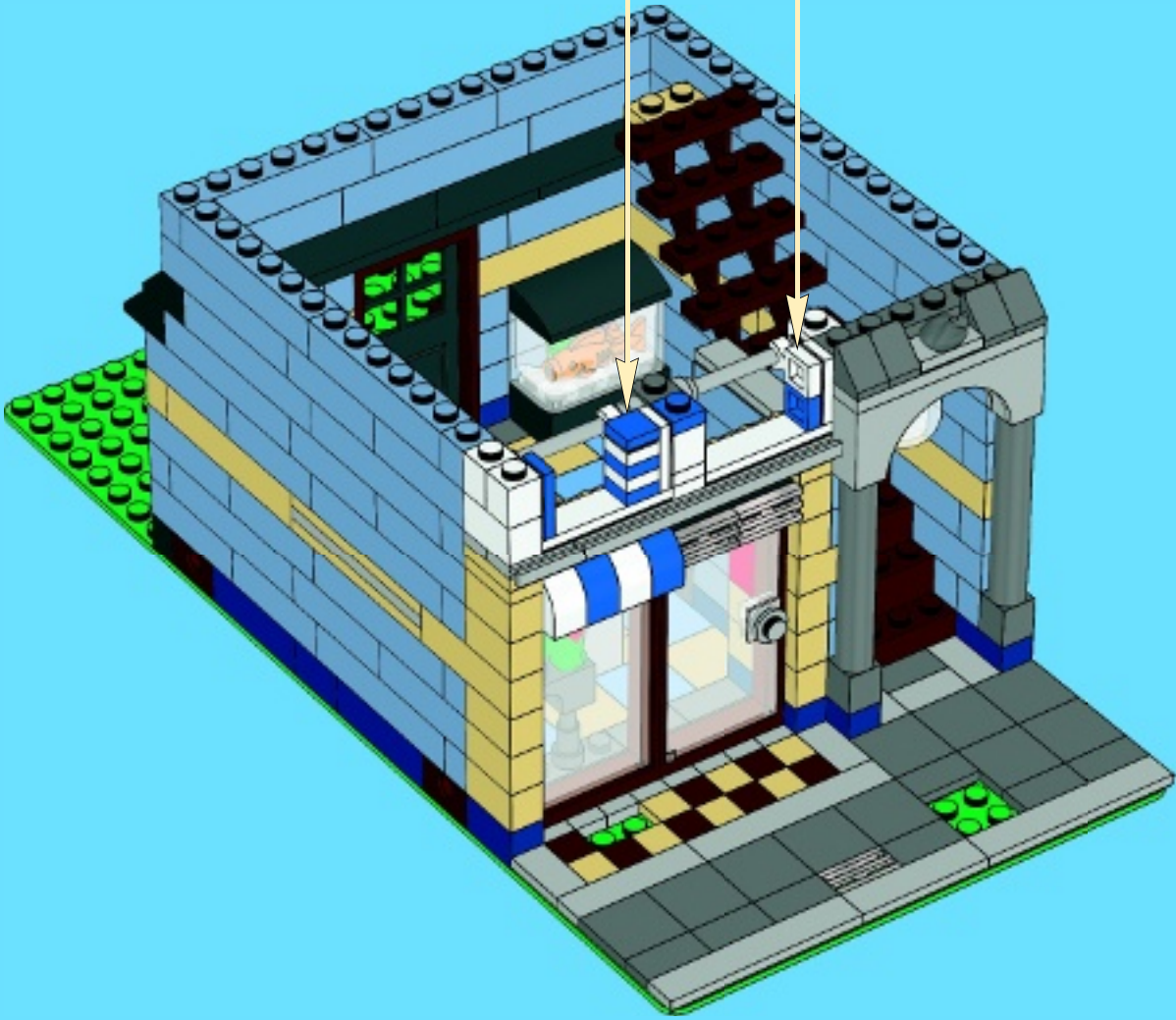
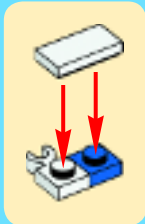
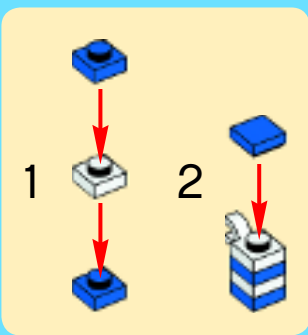

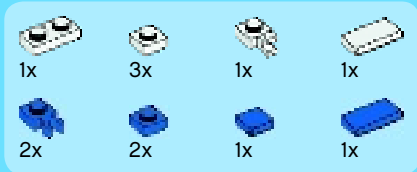

# 31

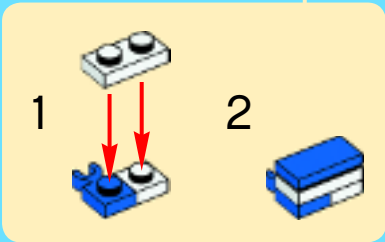
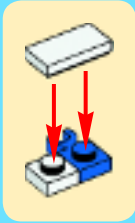
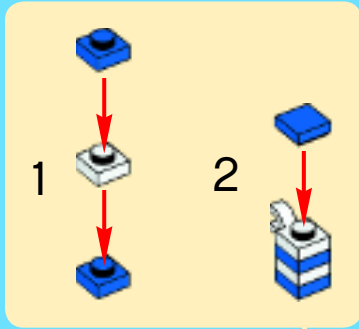



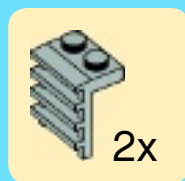
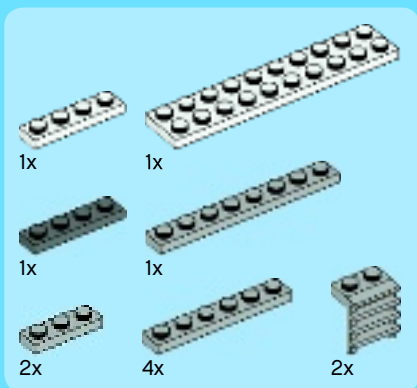

33







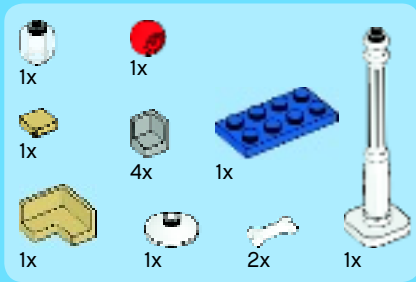

35

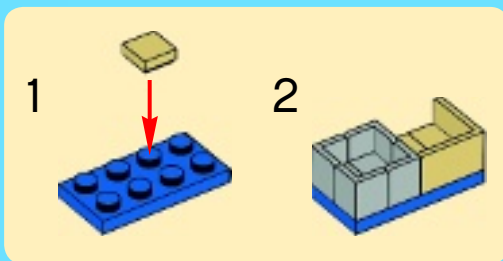
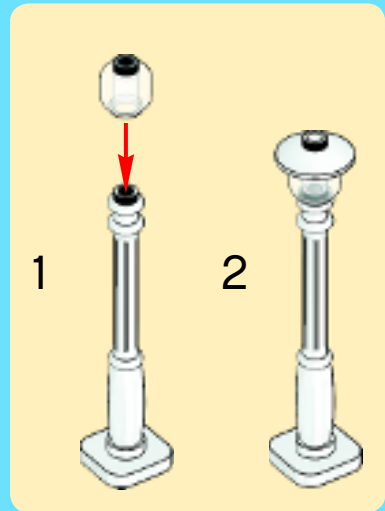

36

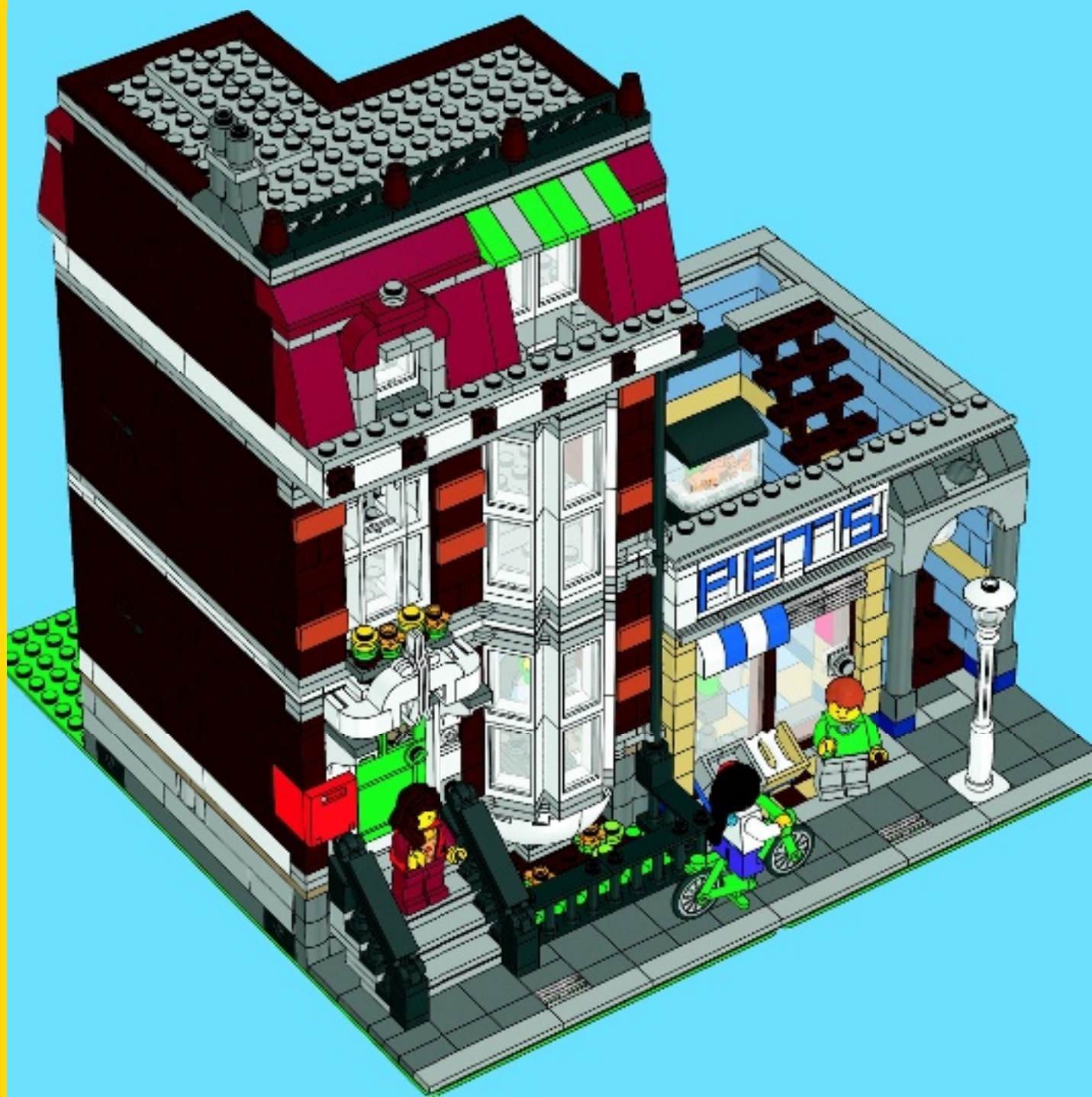



4

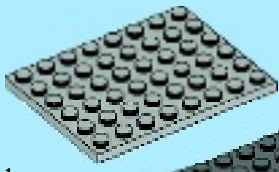
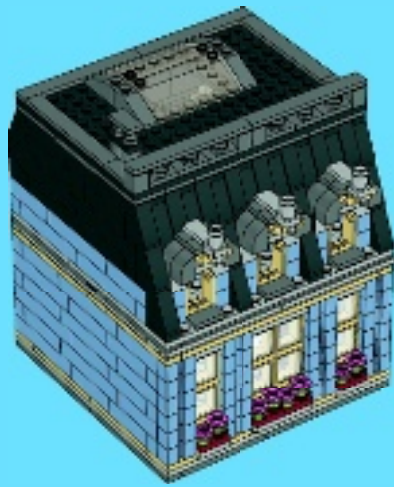

1x

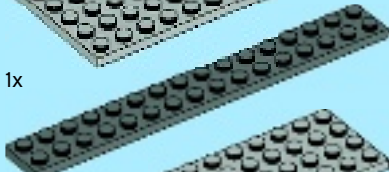

1x

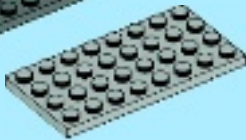

1x

1

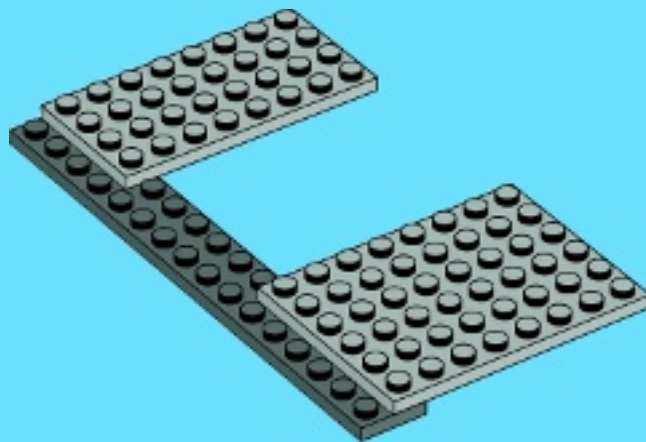



1x

# 2

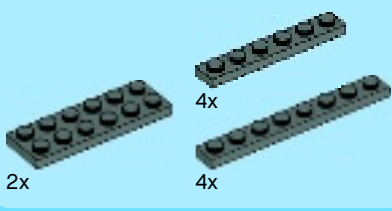
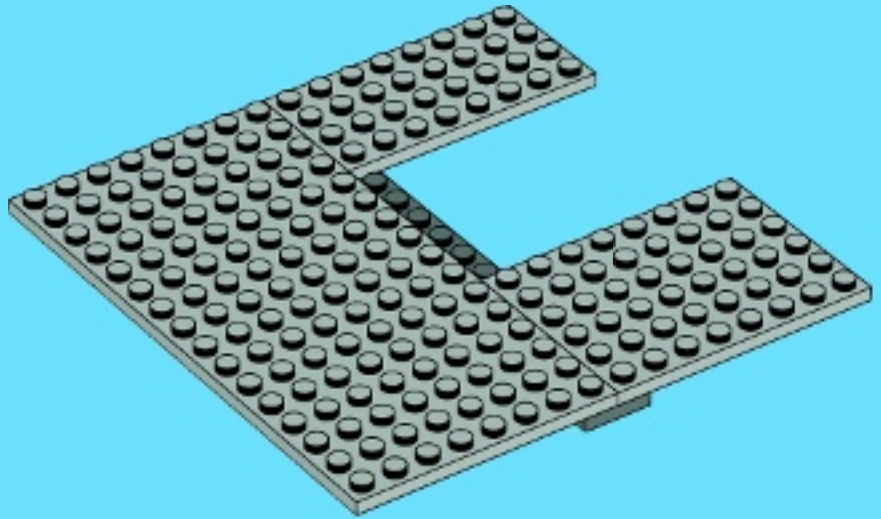

2x

4x

4x



# 3

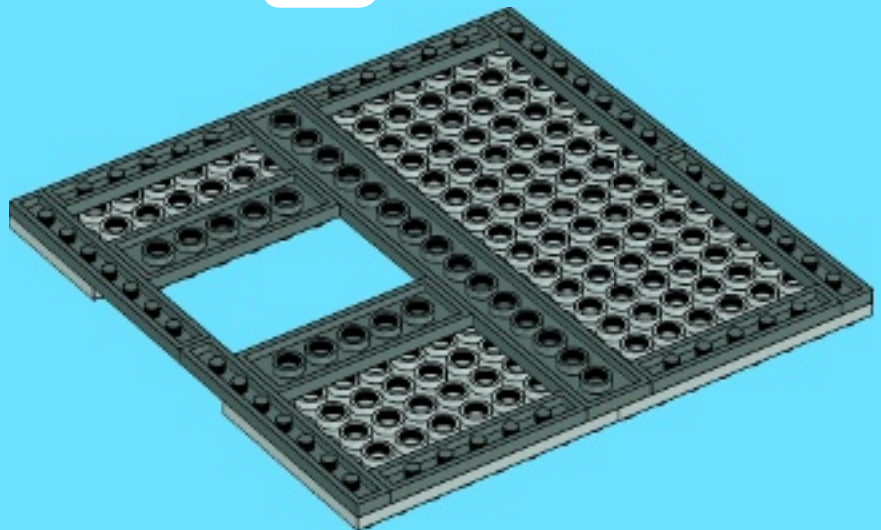

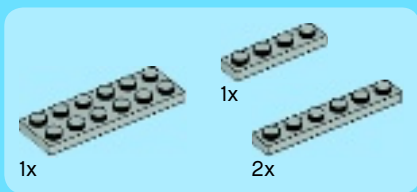

4

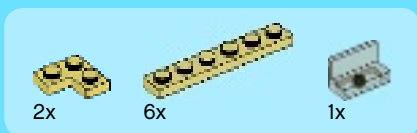
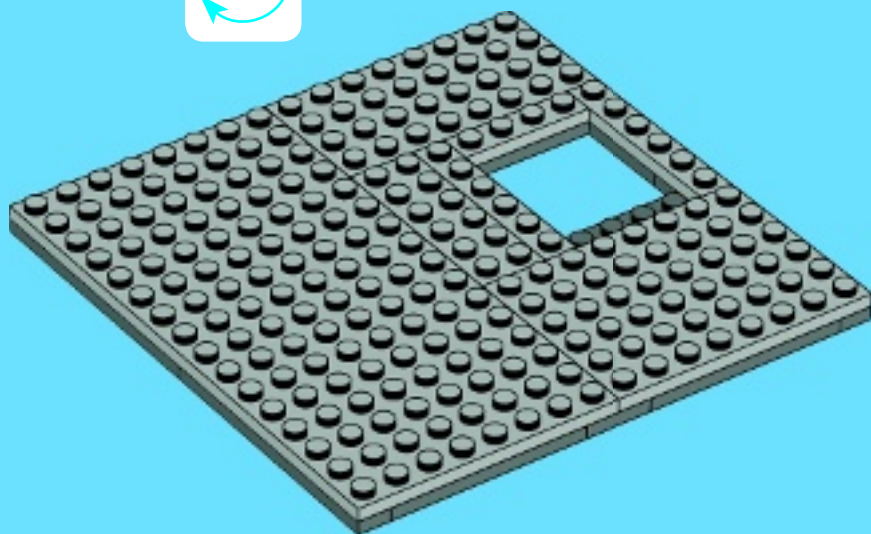

5

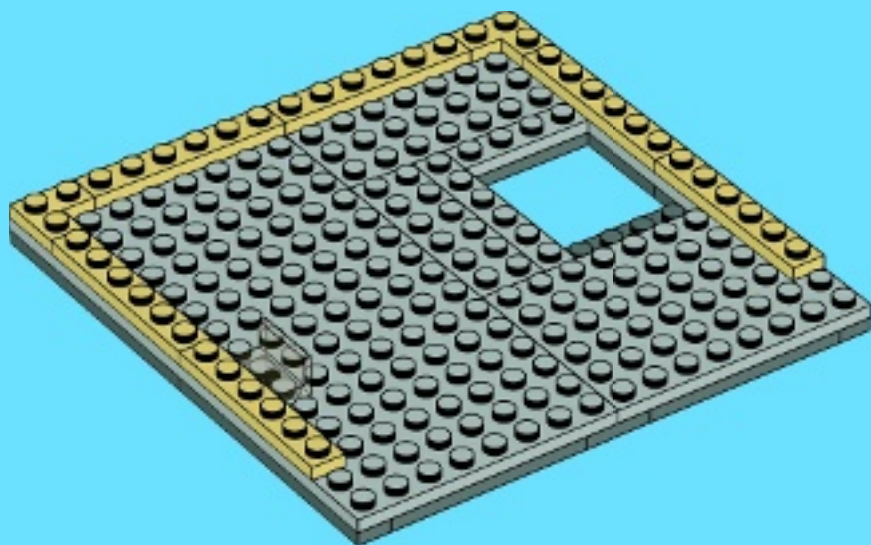

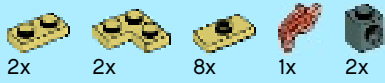

6

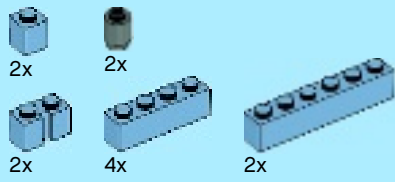
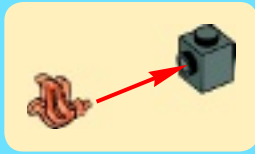
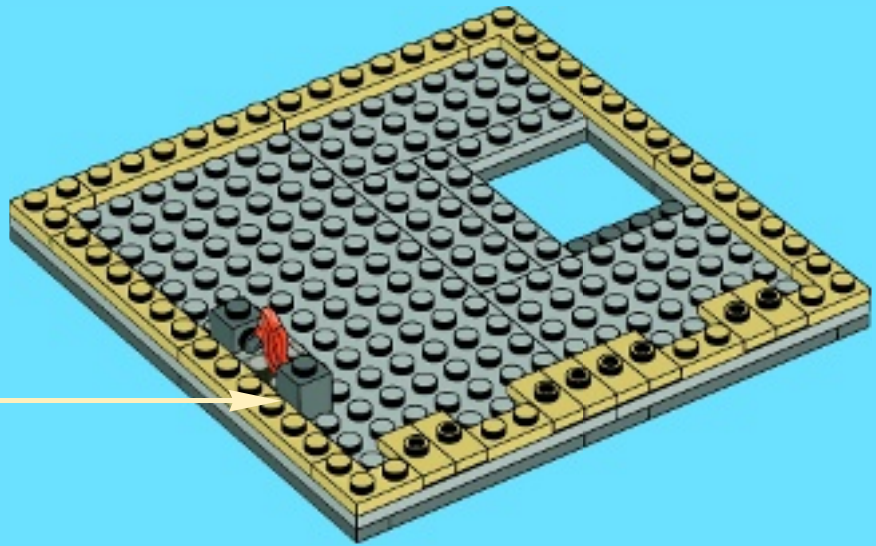

7

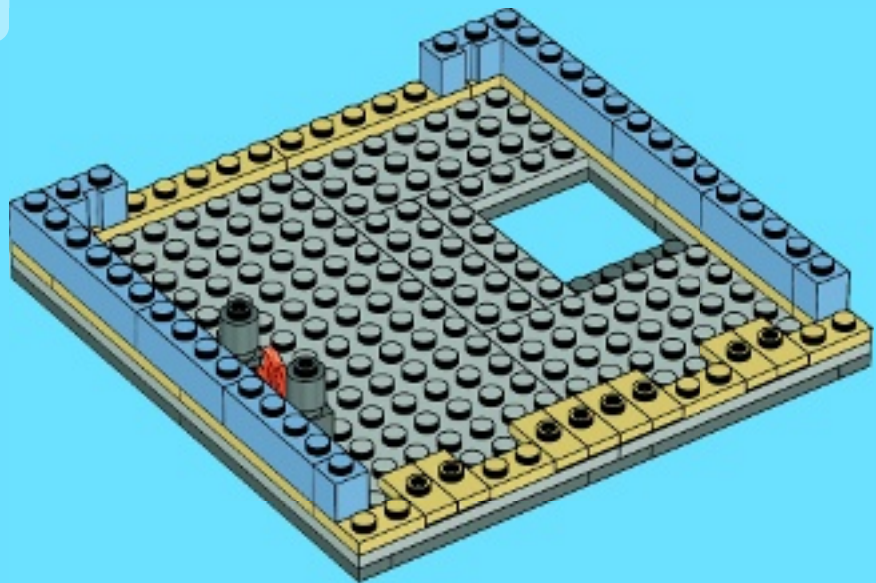

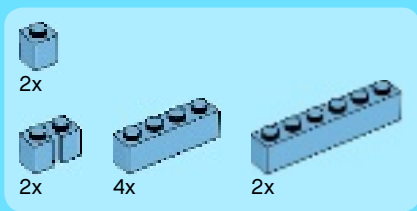

8

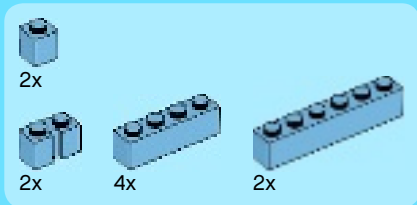
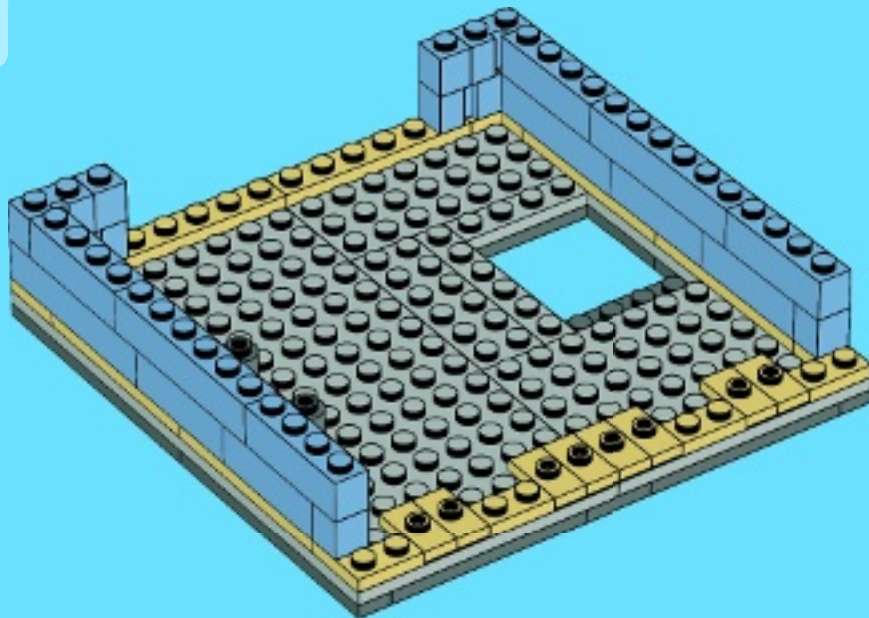

9

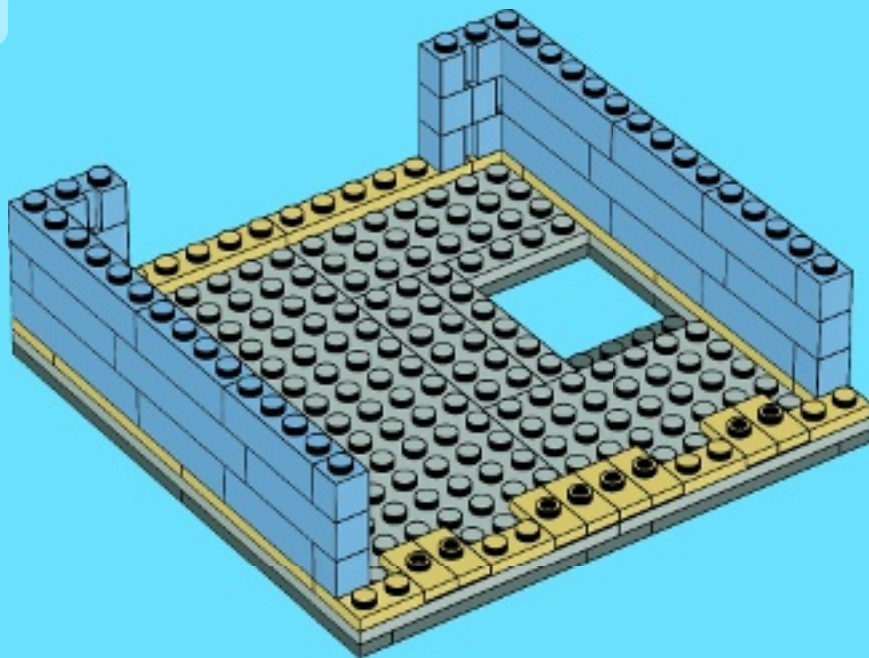



10

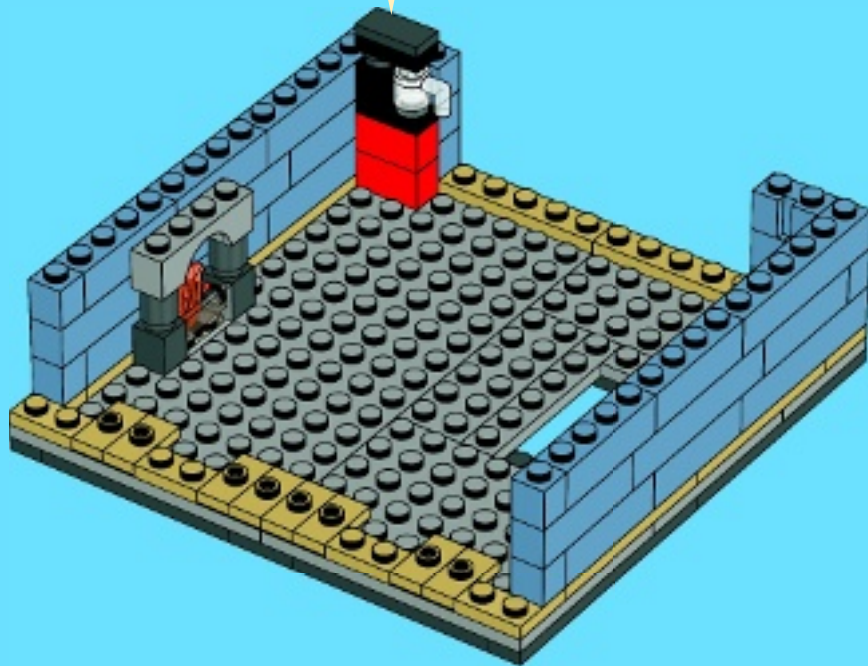
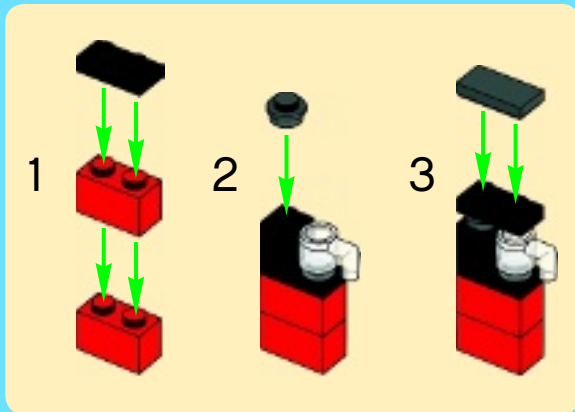





# 11

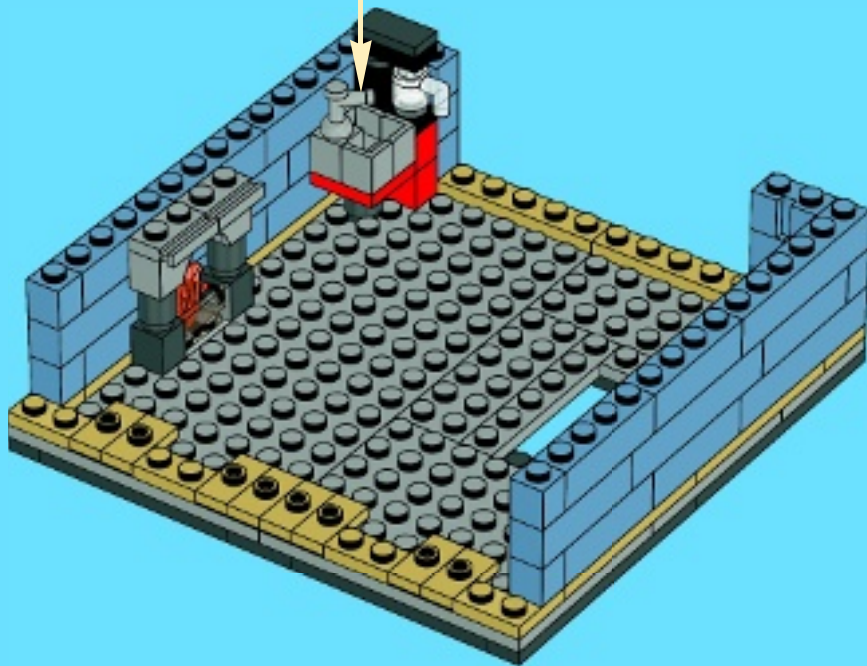
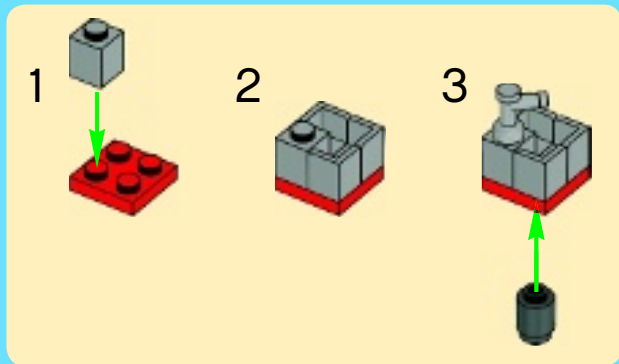

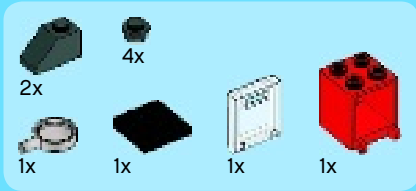

# 12

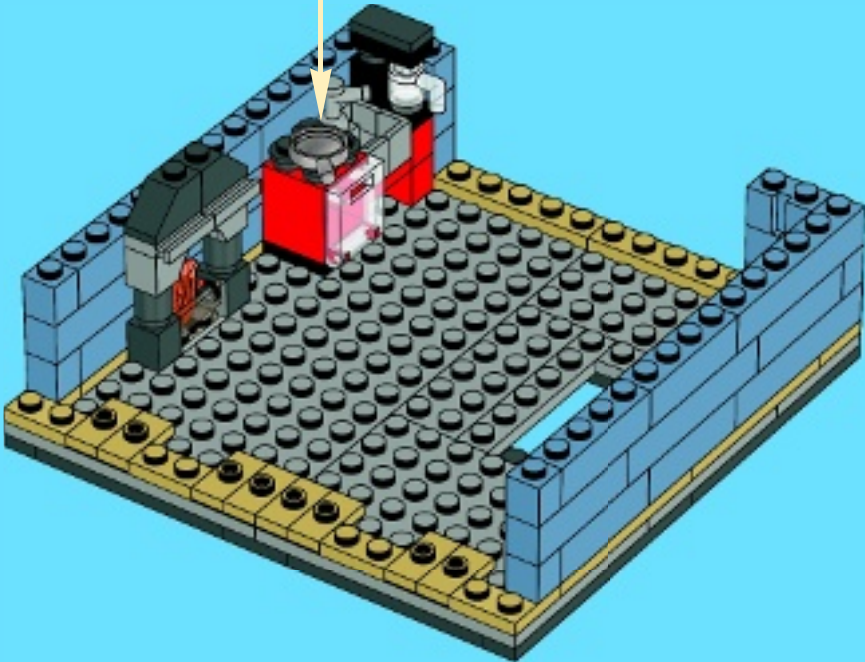
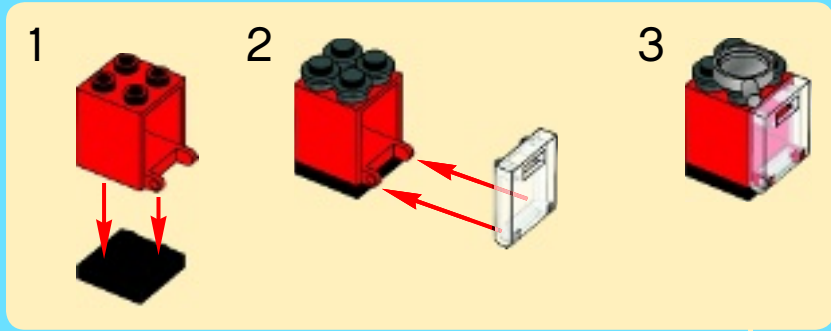

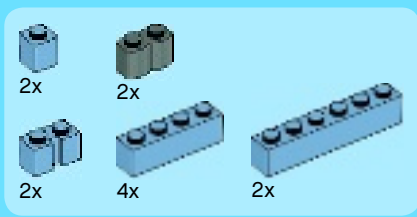

# 13

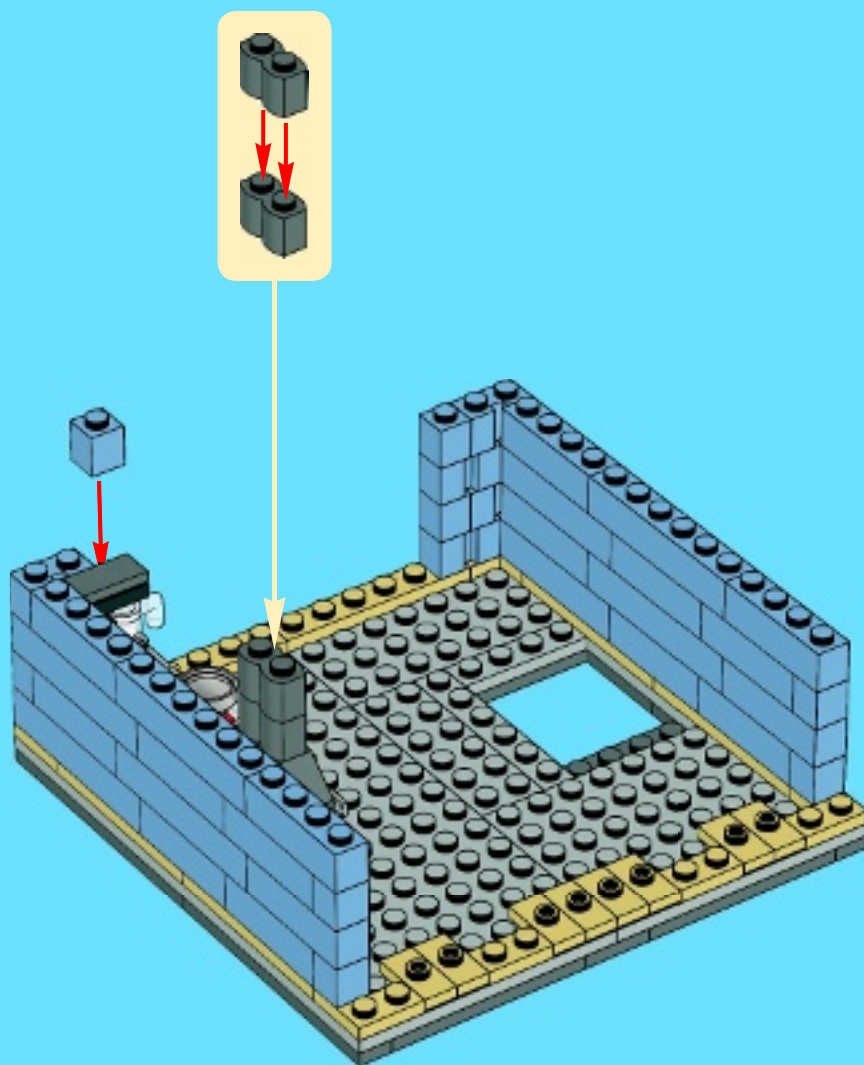

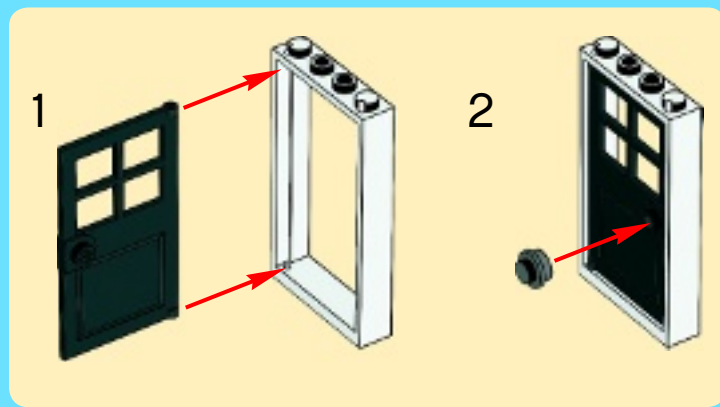
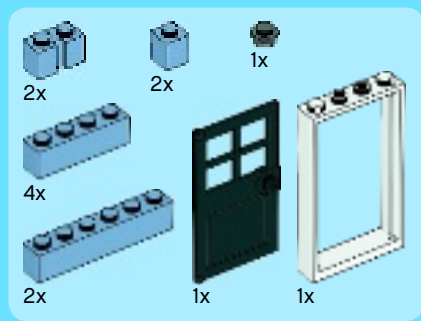

14

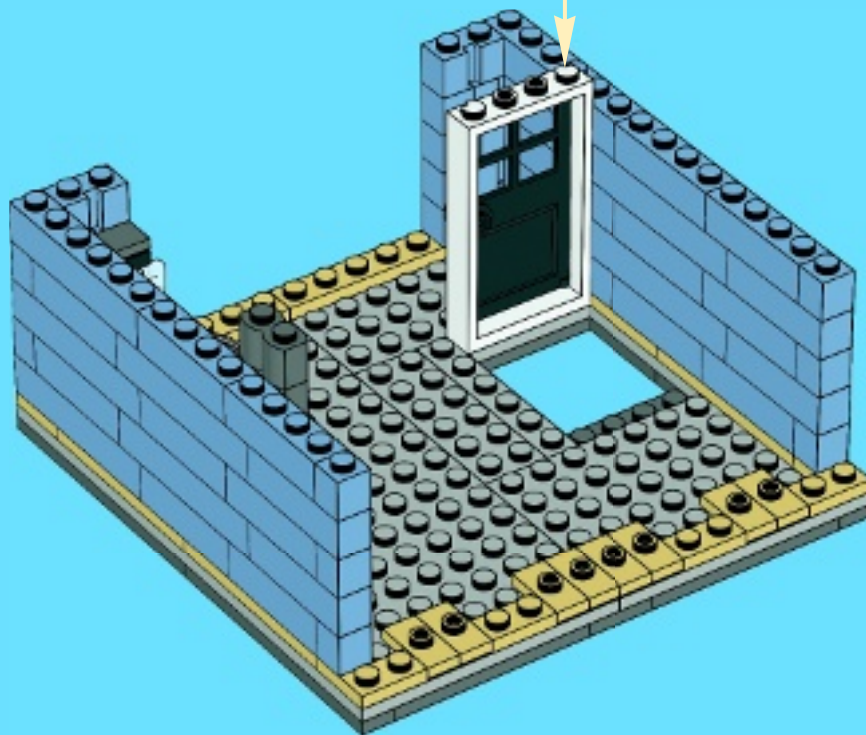

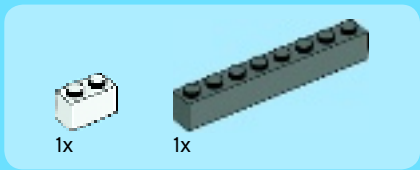
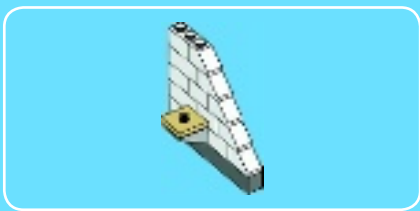

1

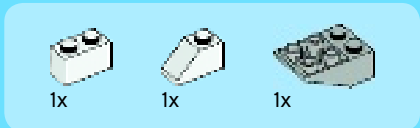
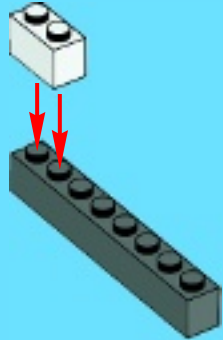

2

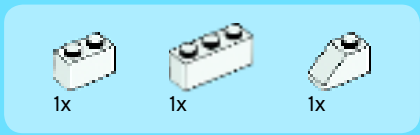

3

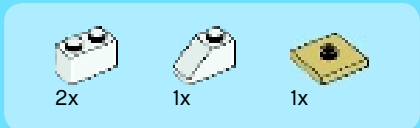
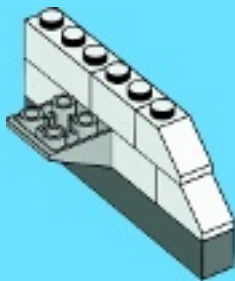

4

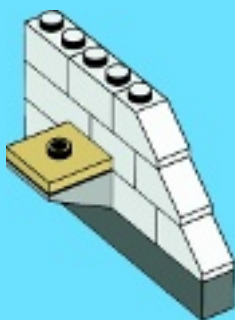



1x



1x

5

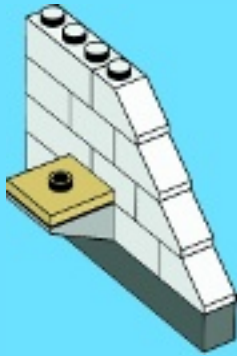

1x



1x

6



15

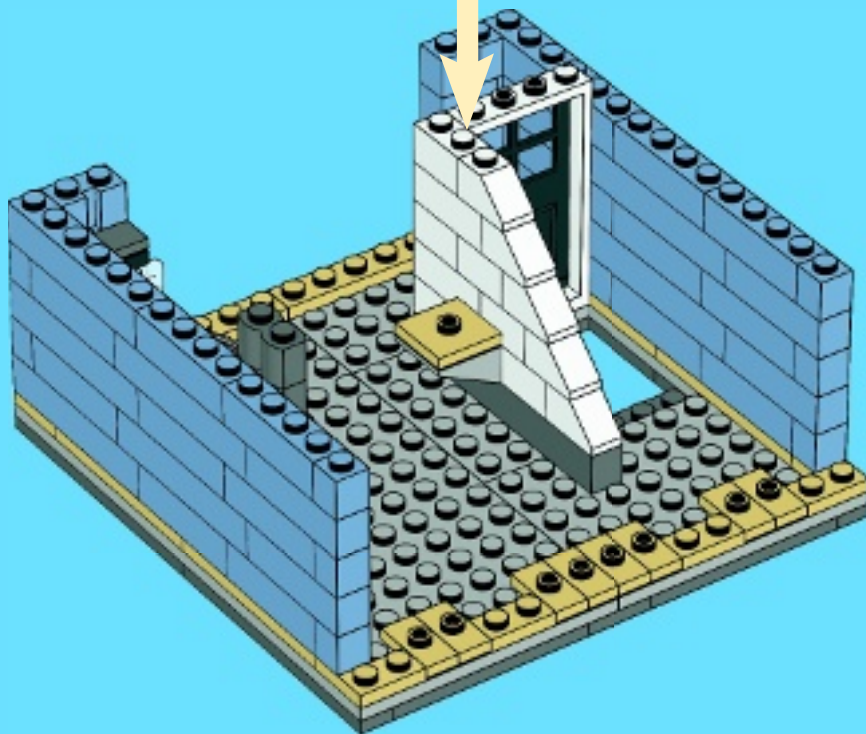

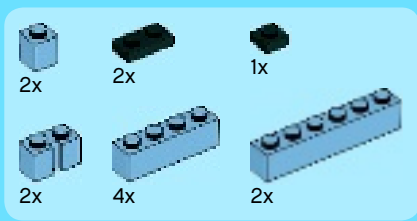

16

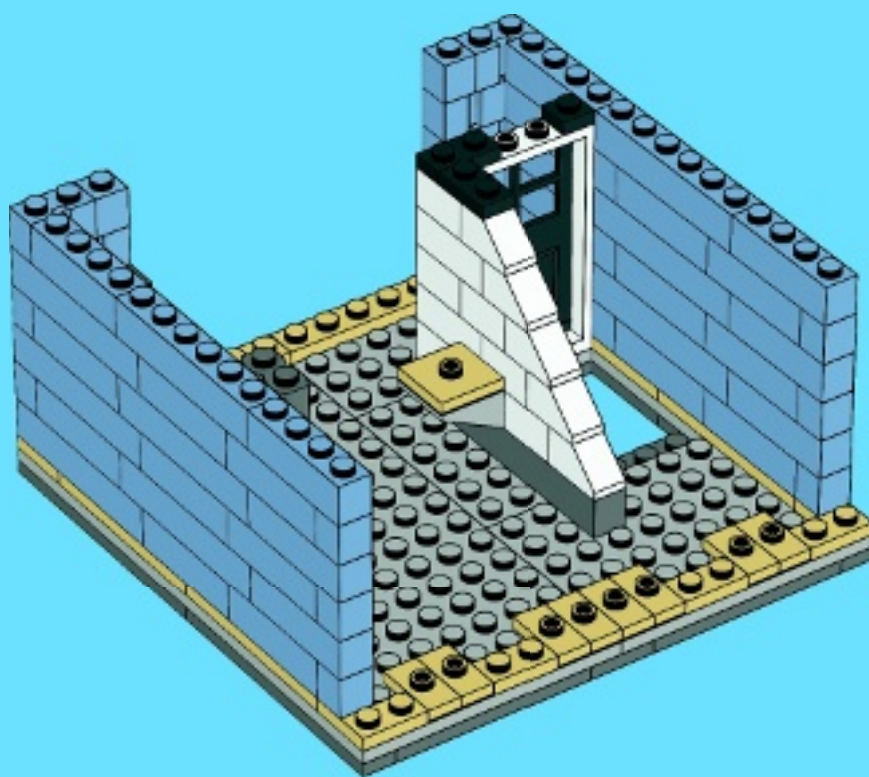

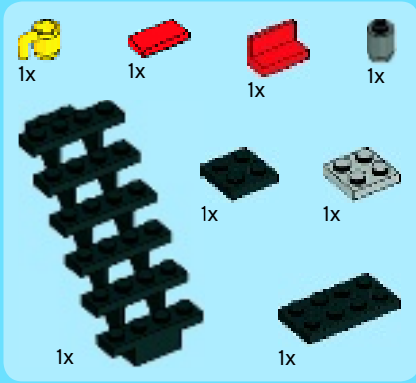

17

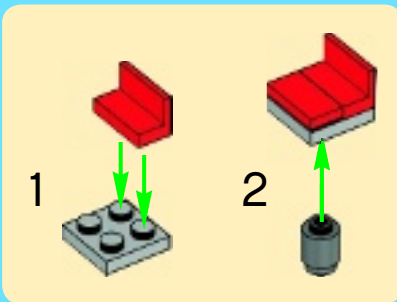
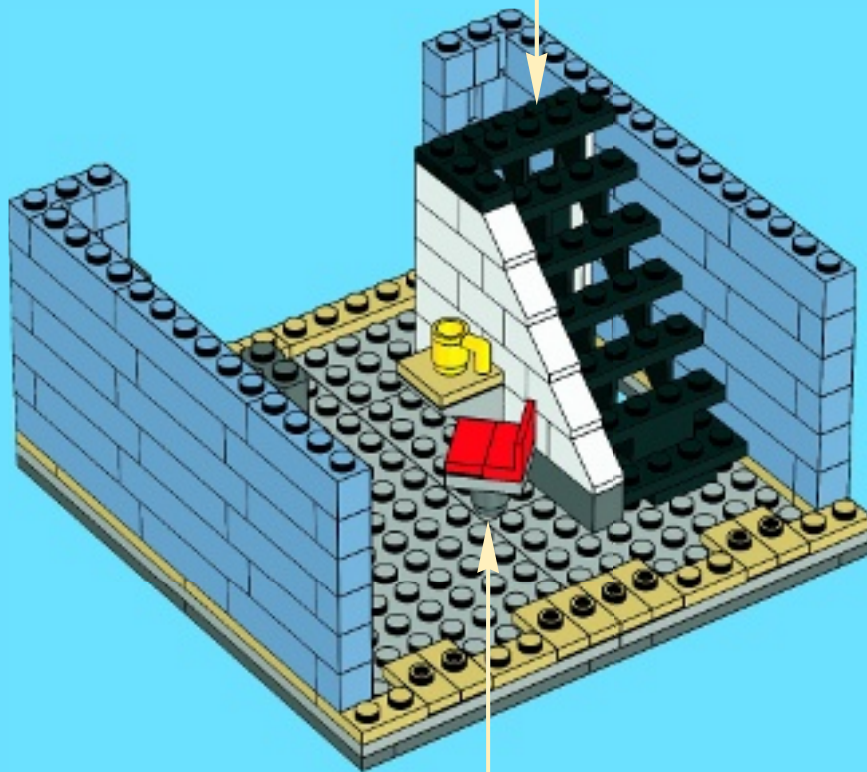
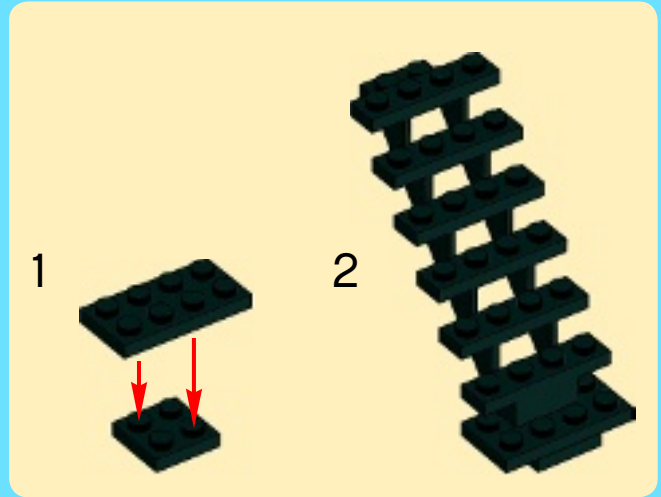





30x

# 18

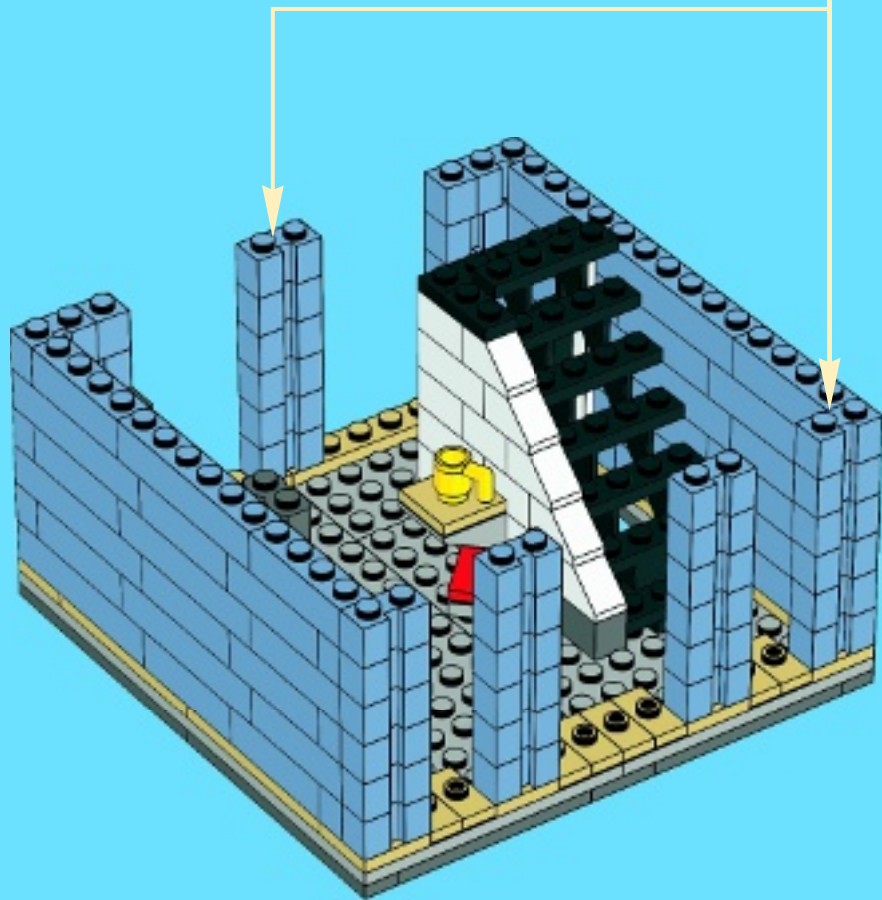
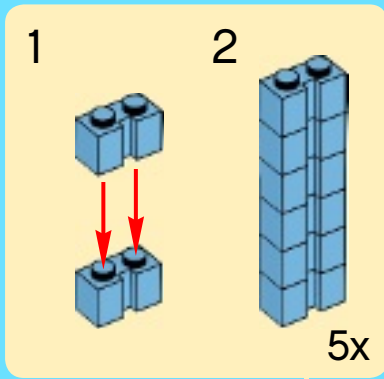

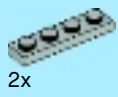

2x



8x



4x

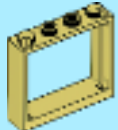

2x



2x



4x

# 19

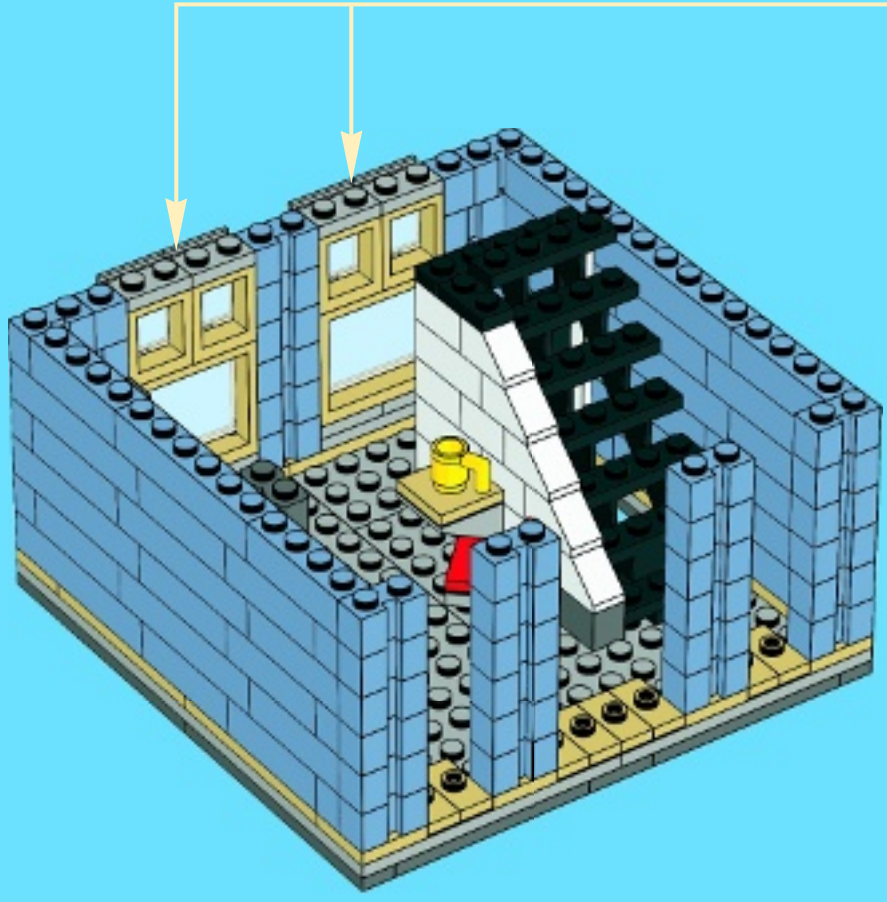
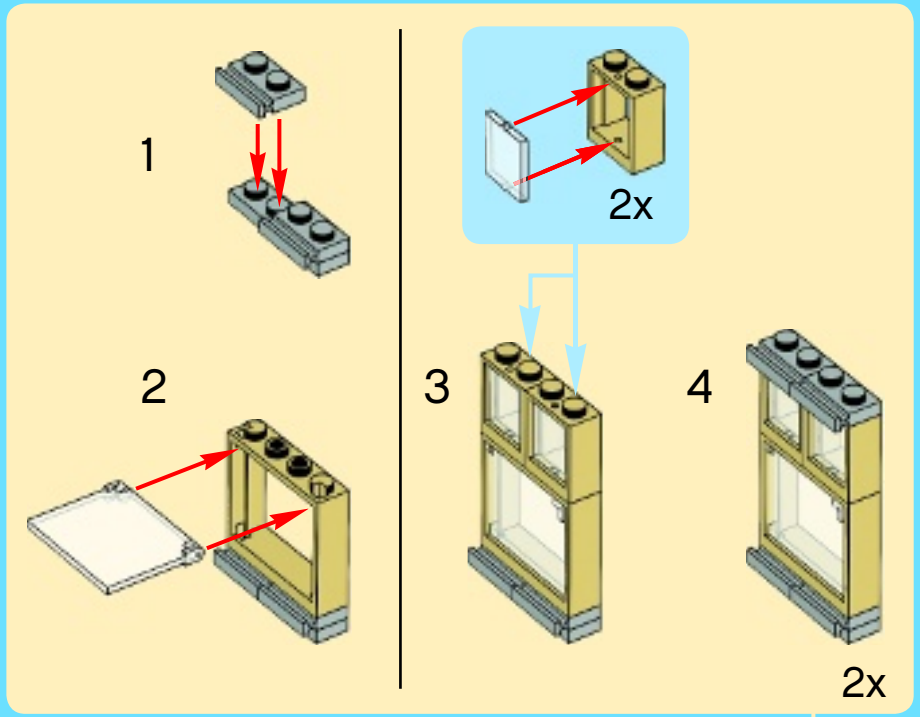

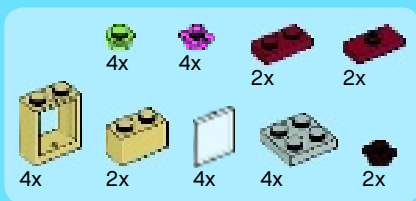

# 20

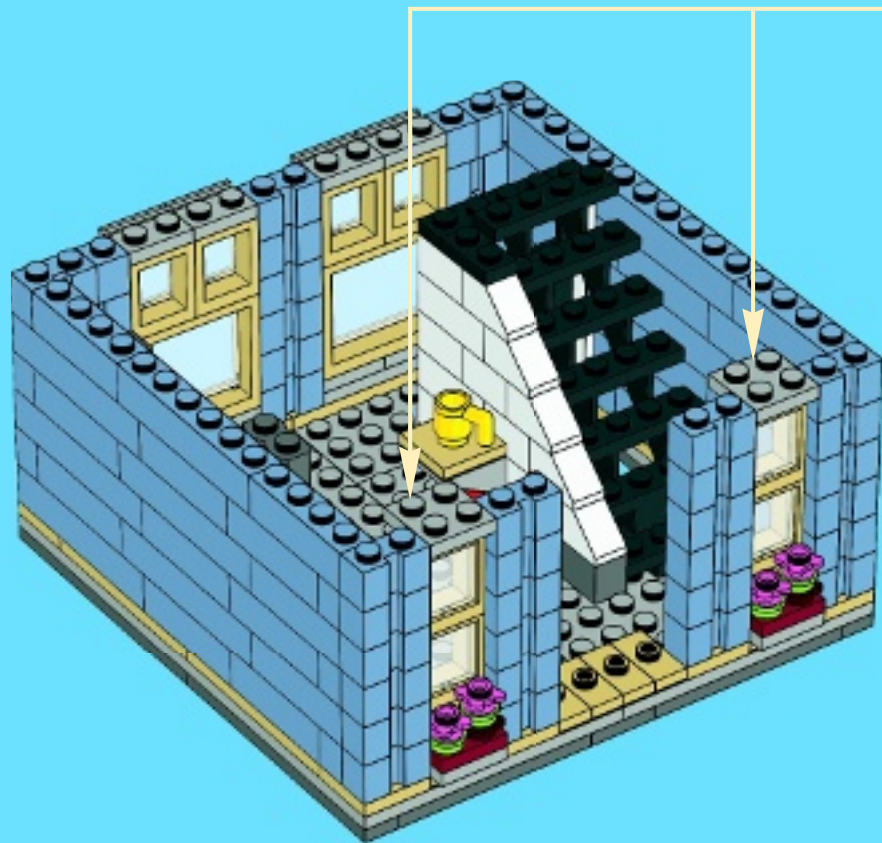
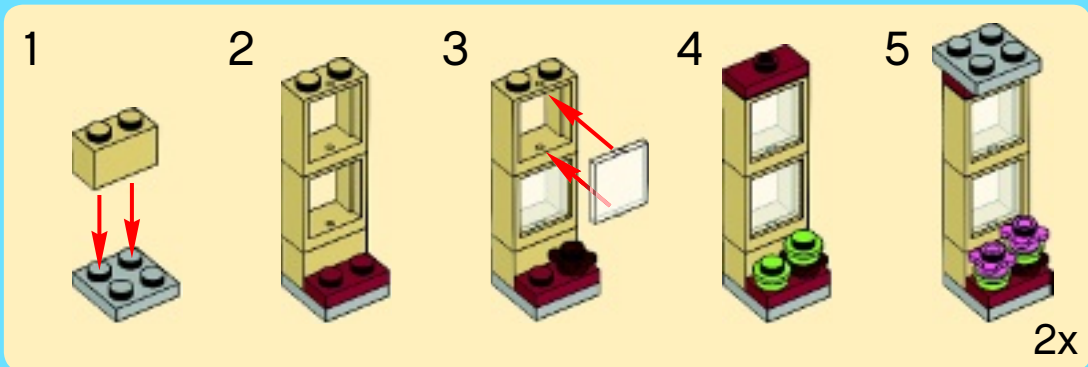

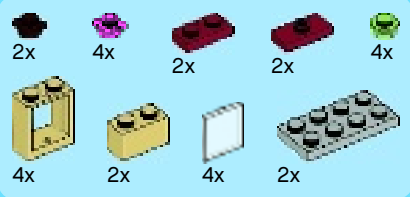

# 21

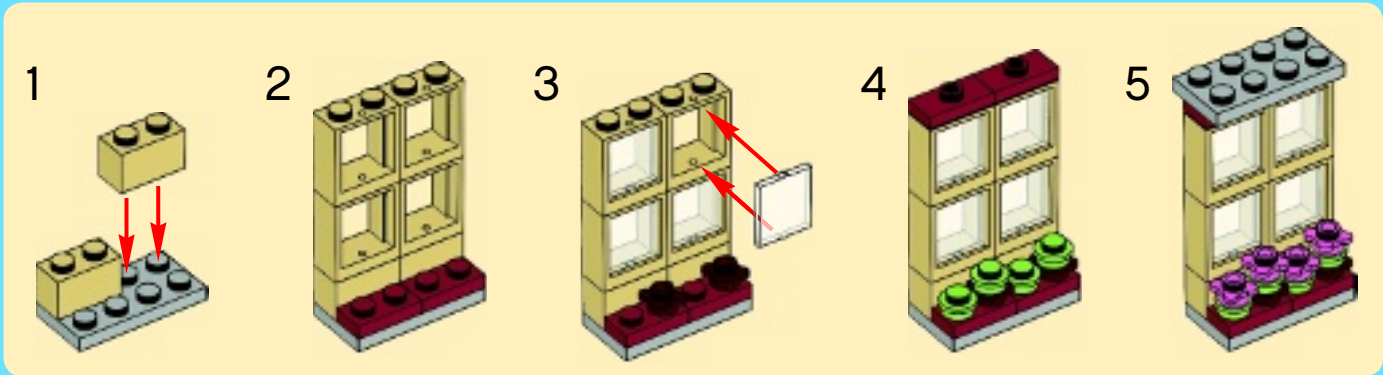

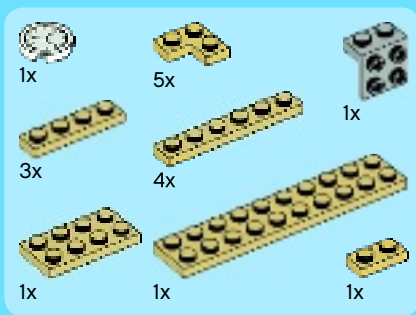

# 22

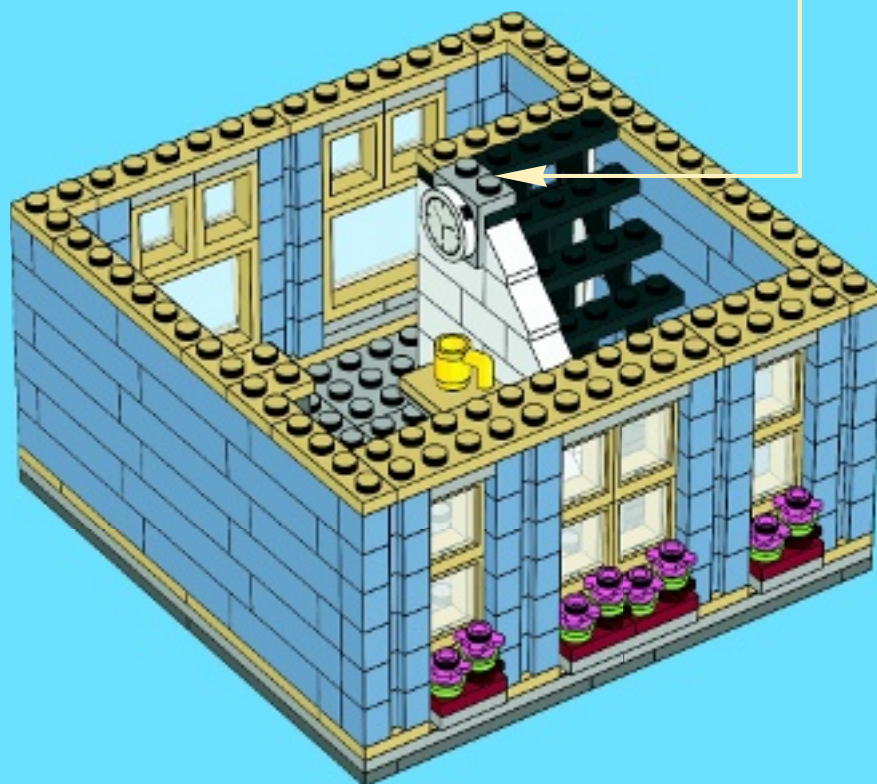
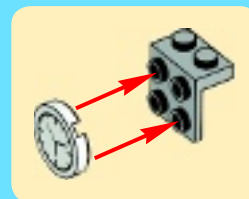

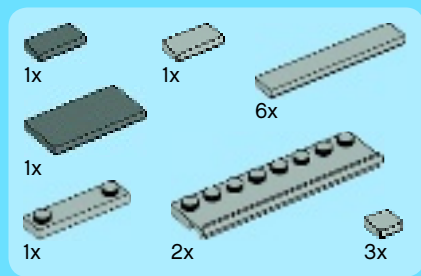

23

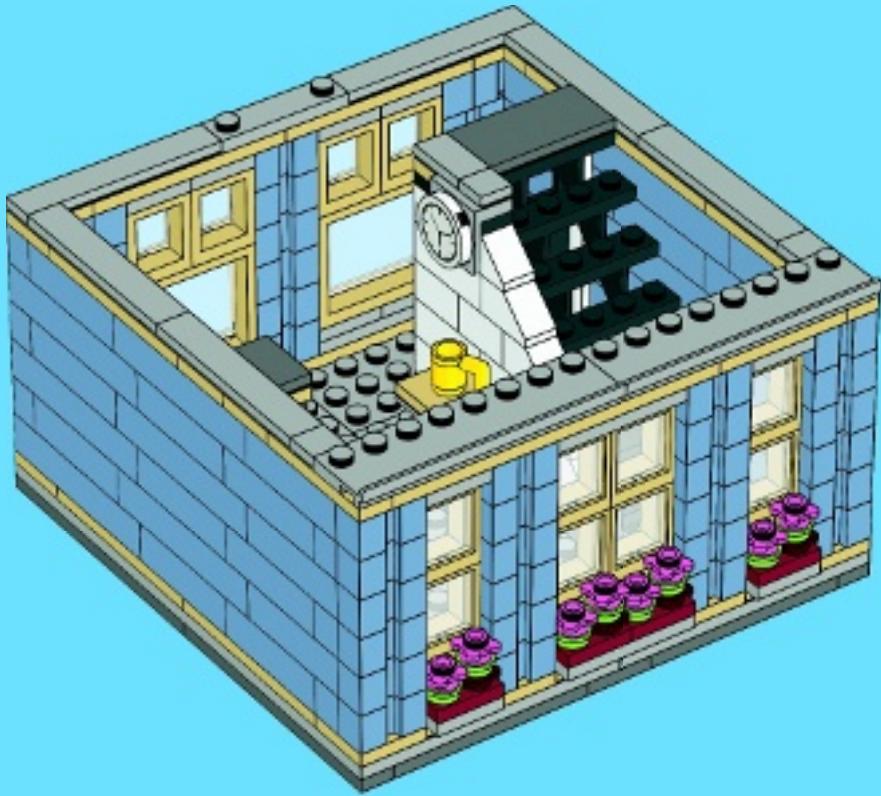

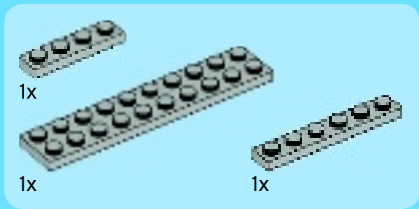
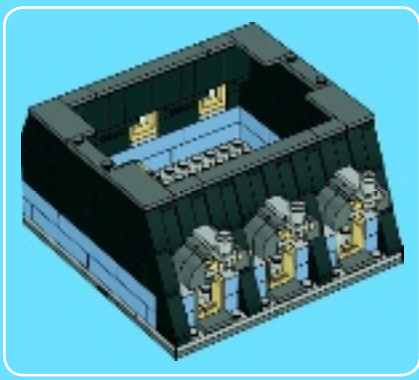

1

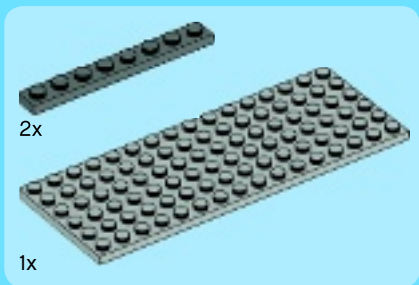
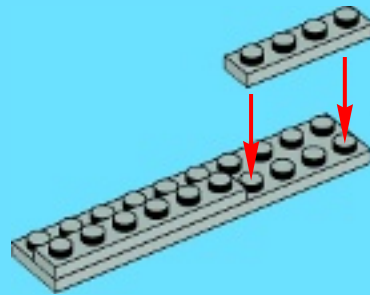

2

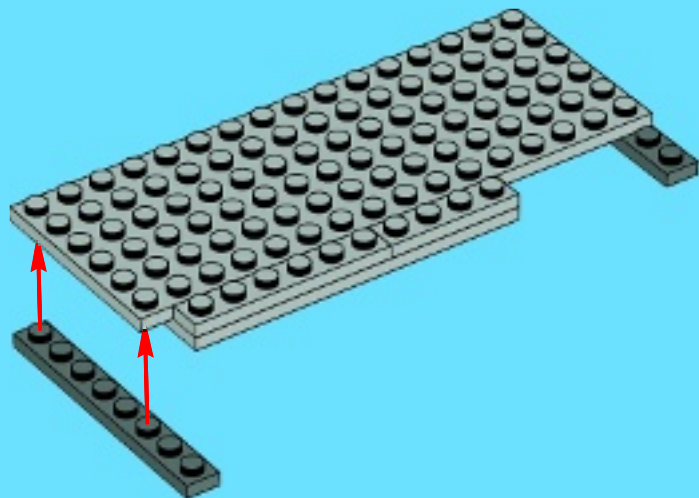

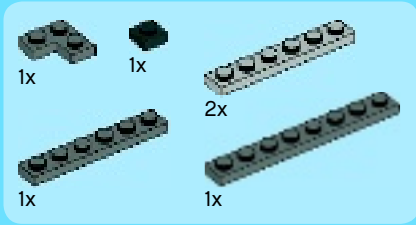

3

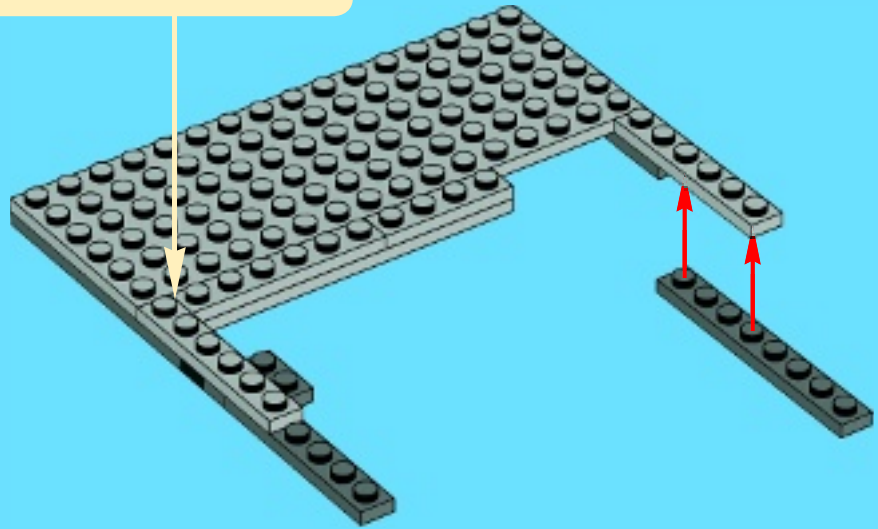
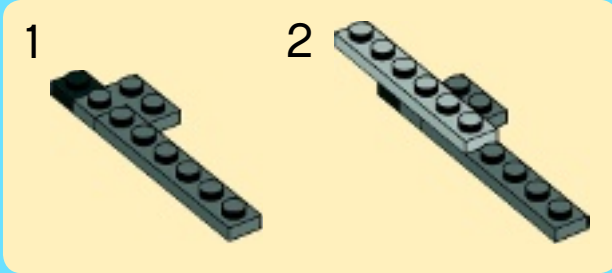

4

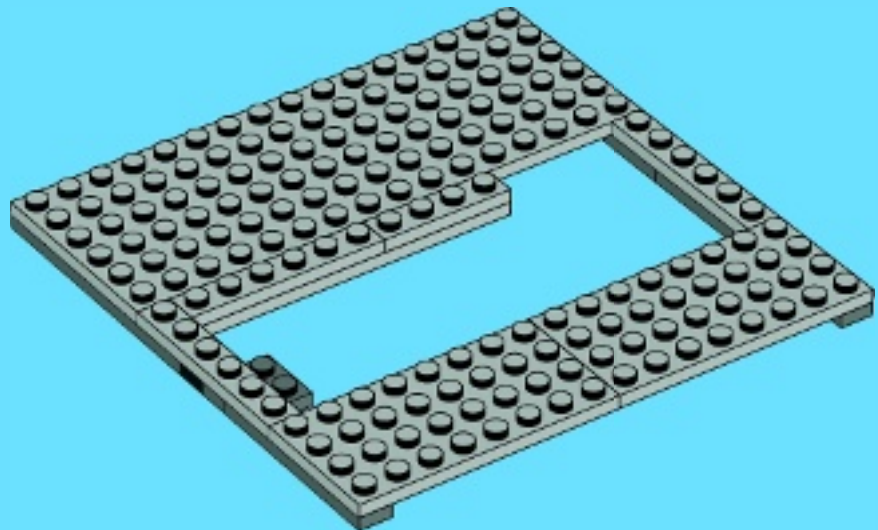



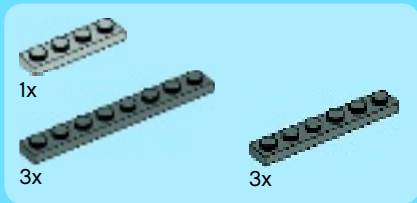

5

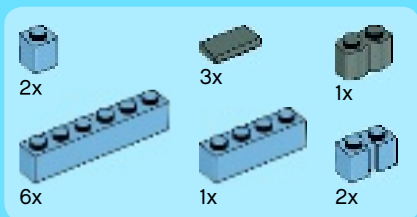
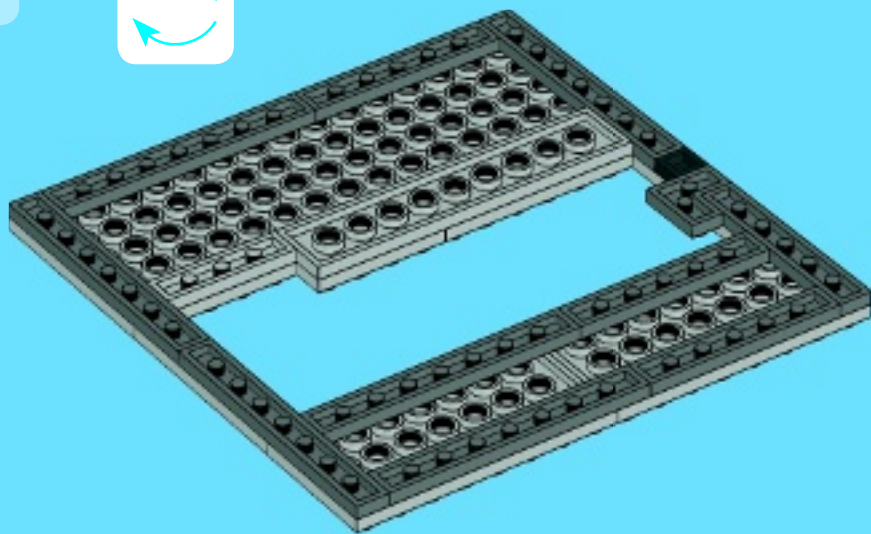

6

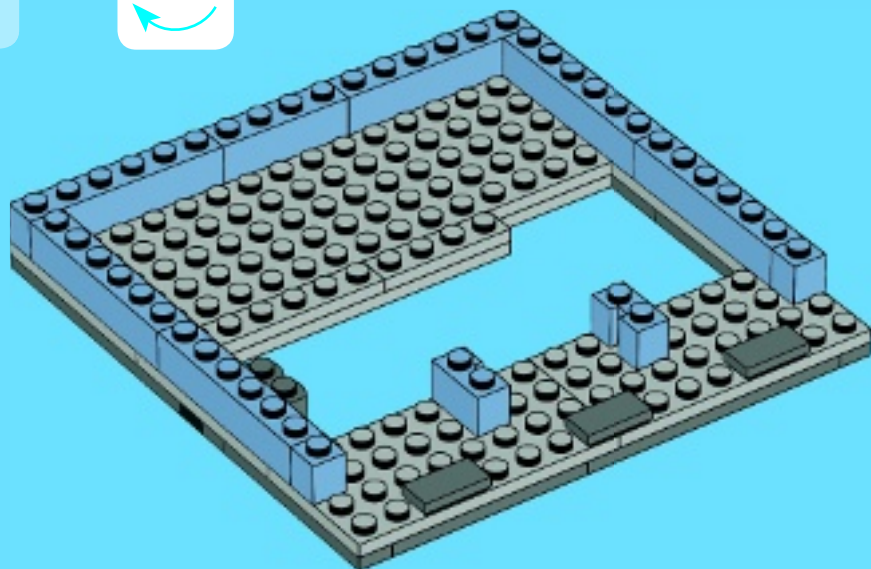

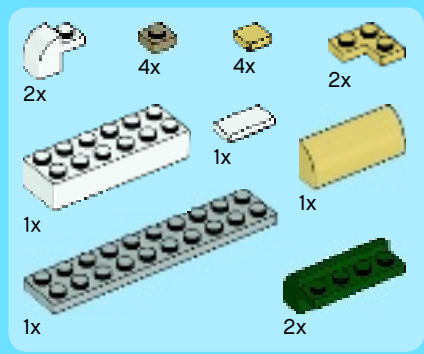

# 7

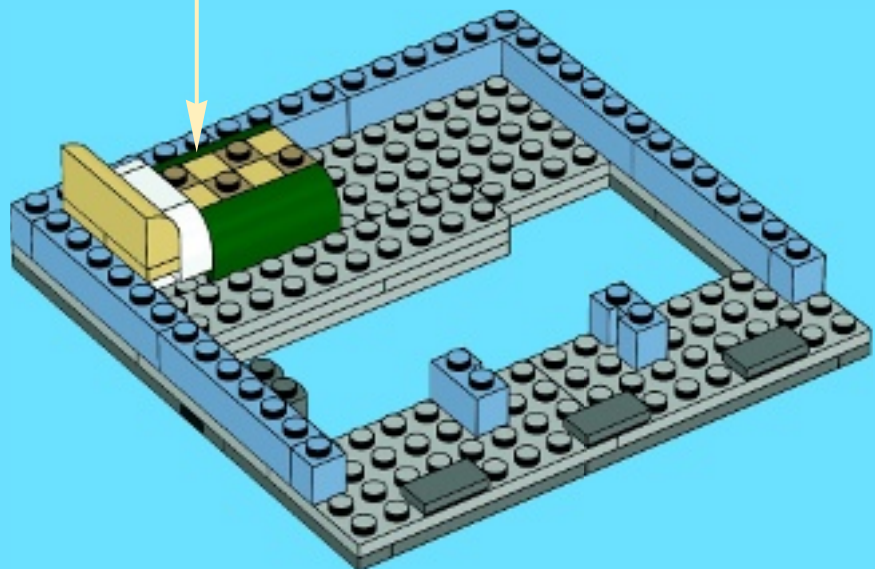
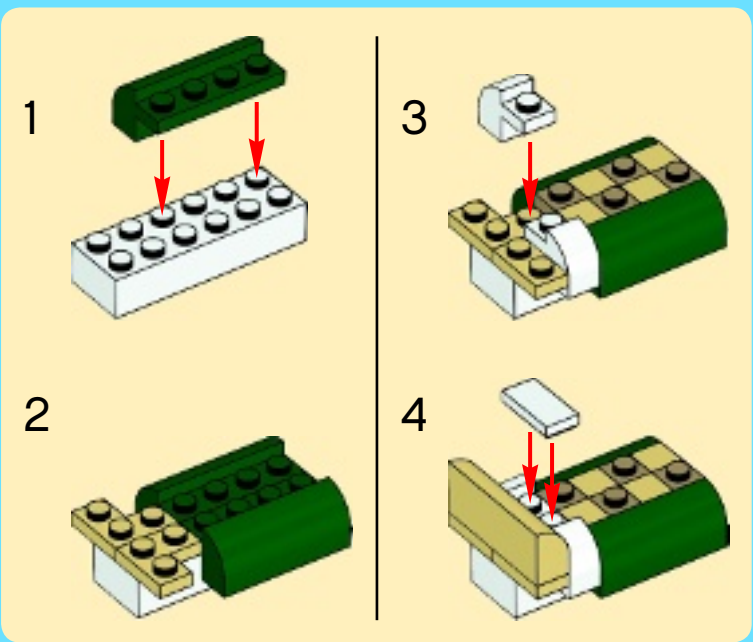

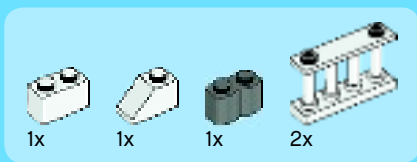

8

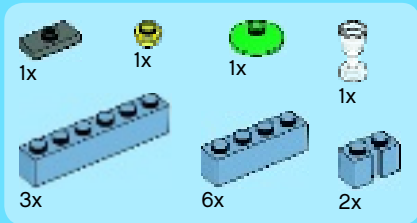
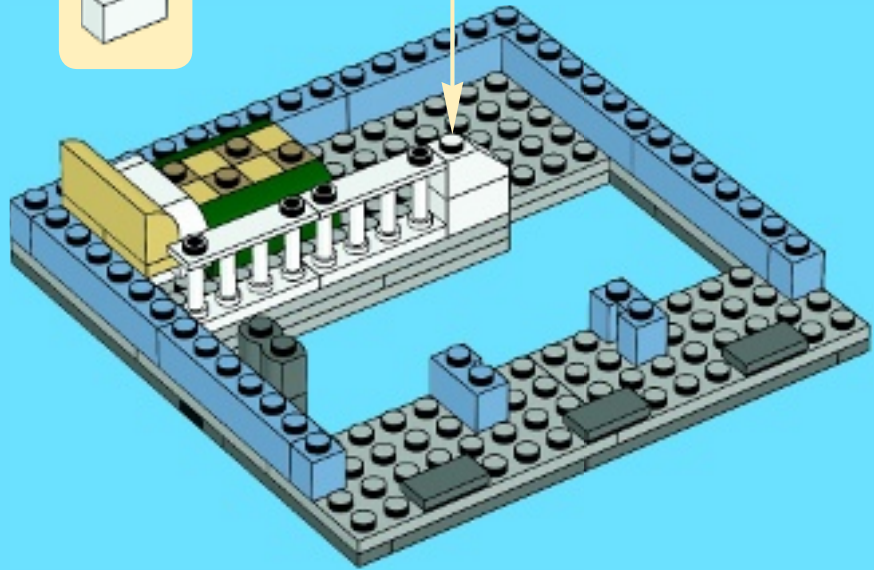
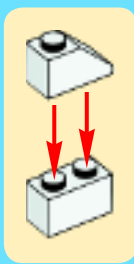

9

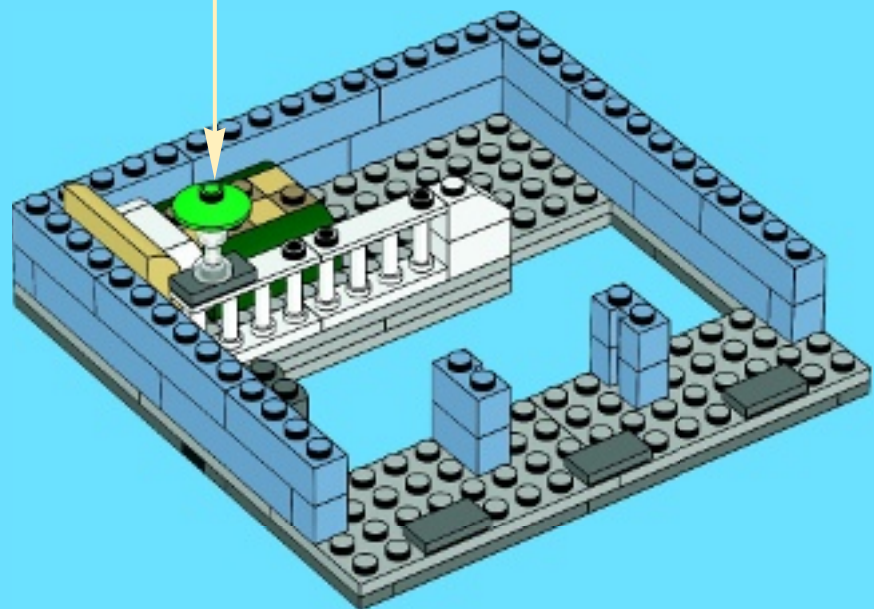



10

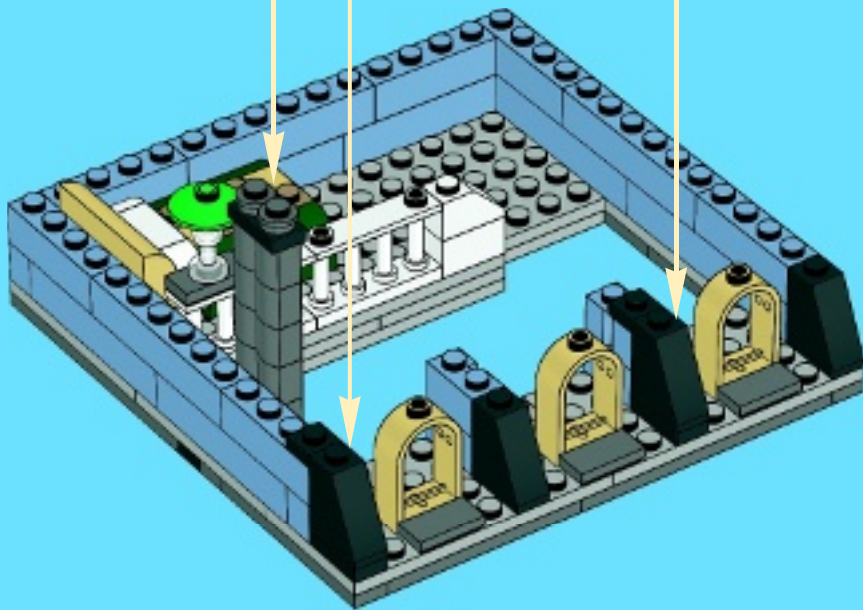
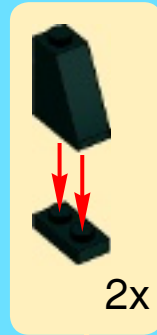
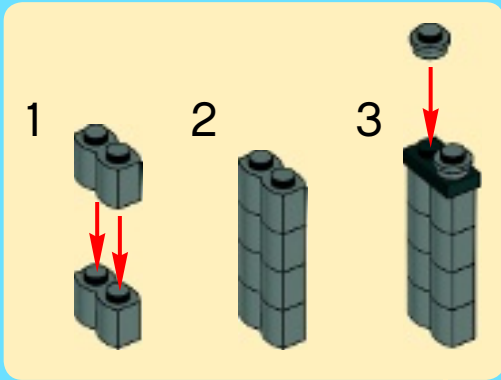

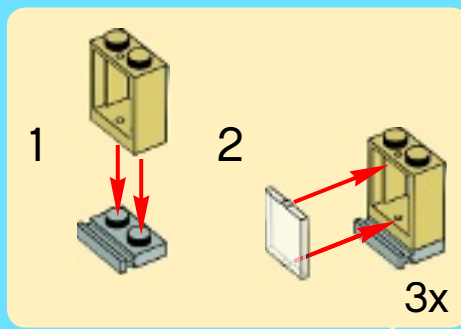
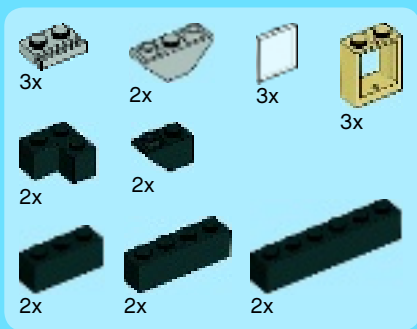

11

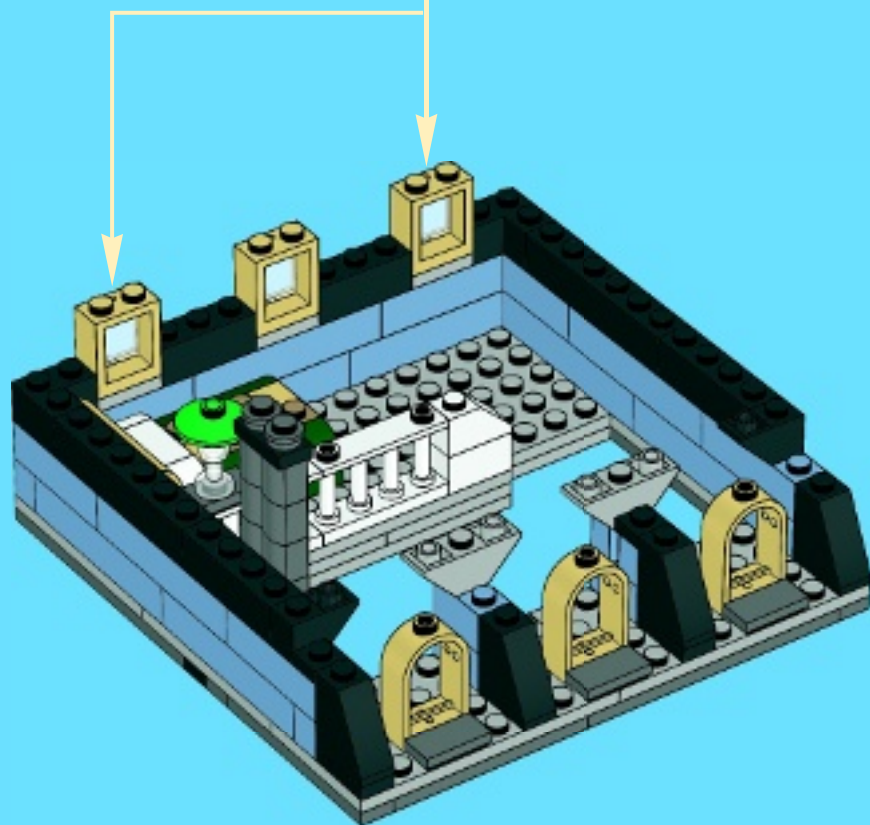

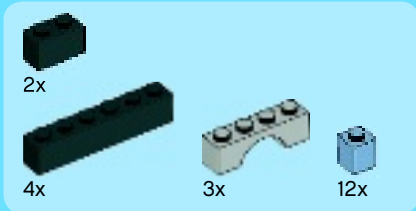

12

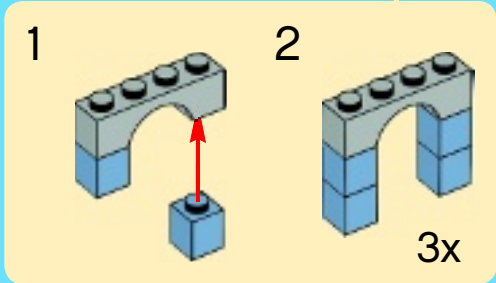
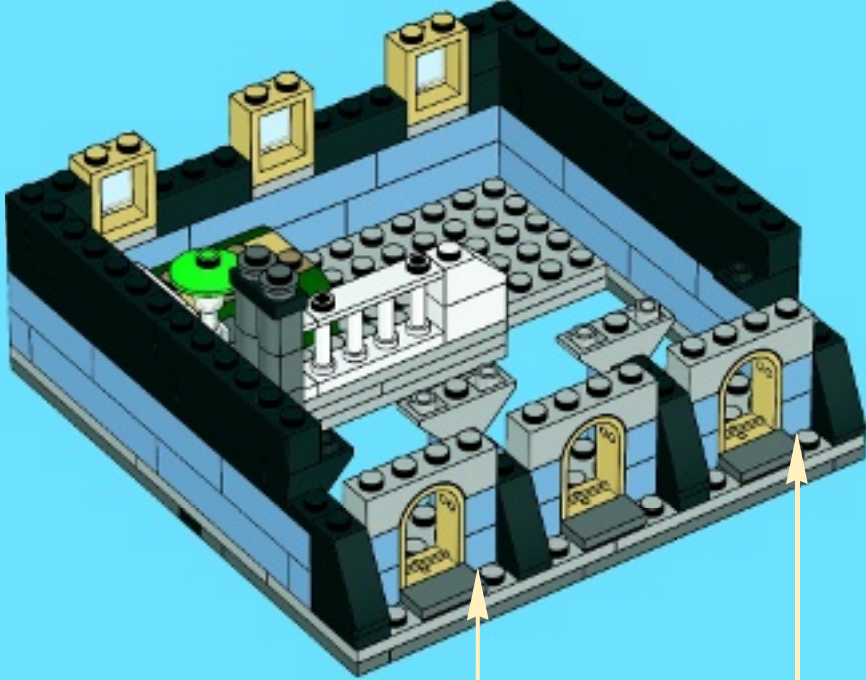

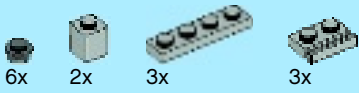

13

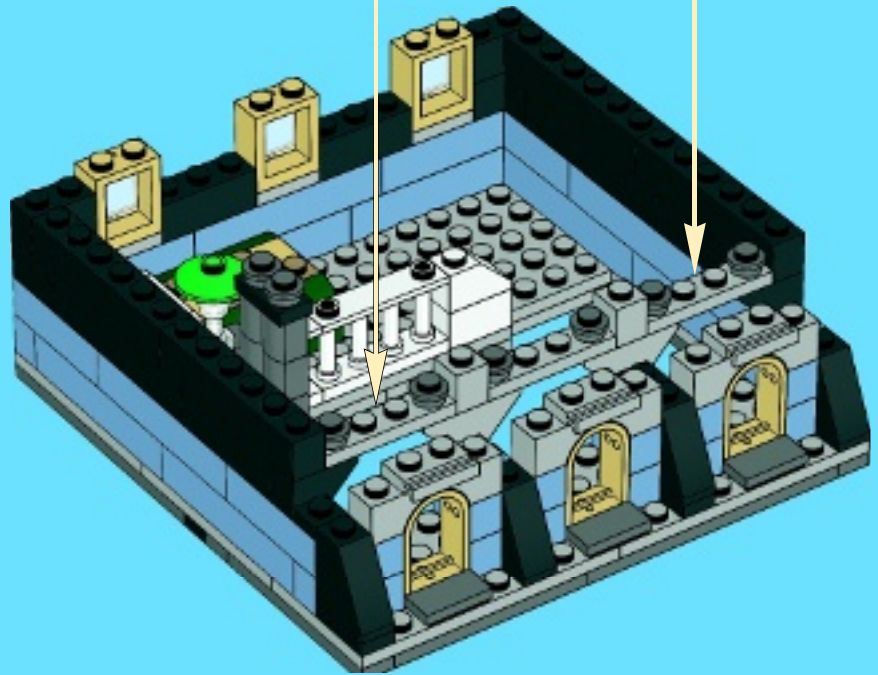
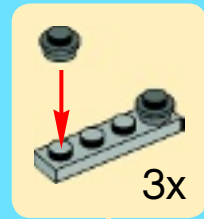

14

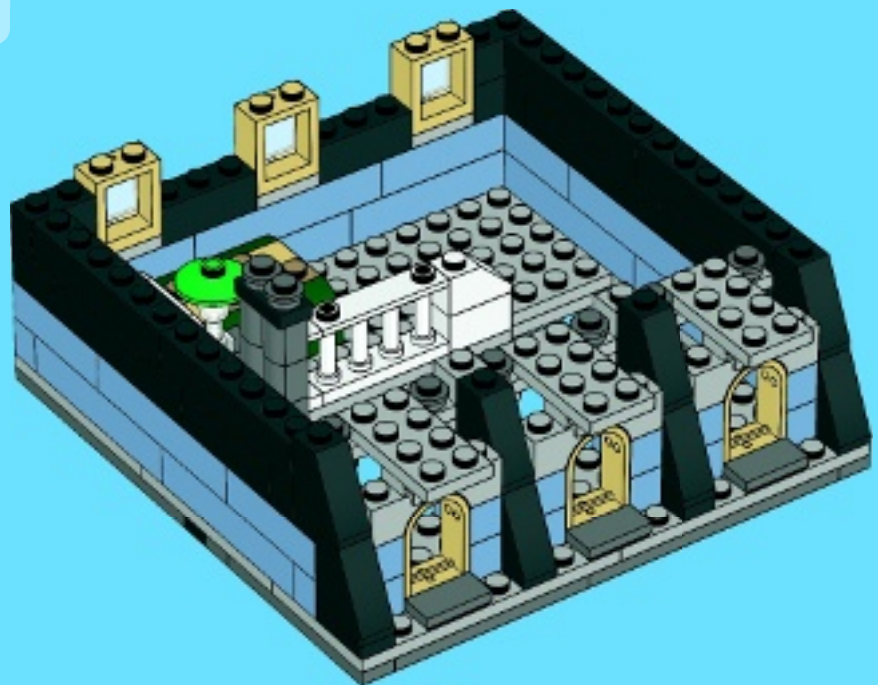



3x



2x



4x

# 15

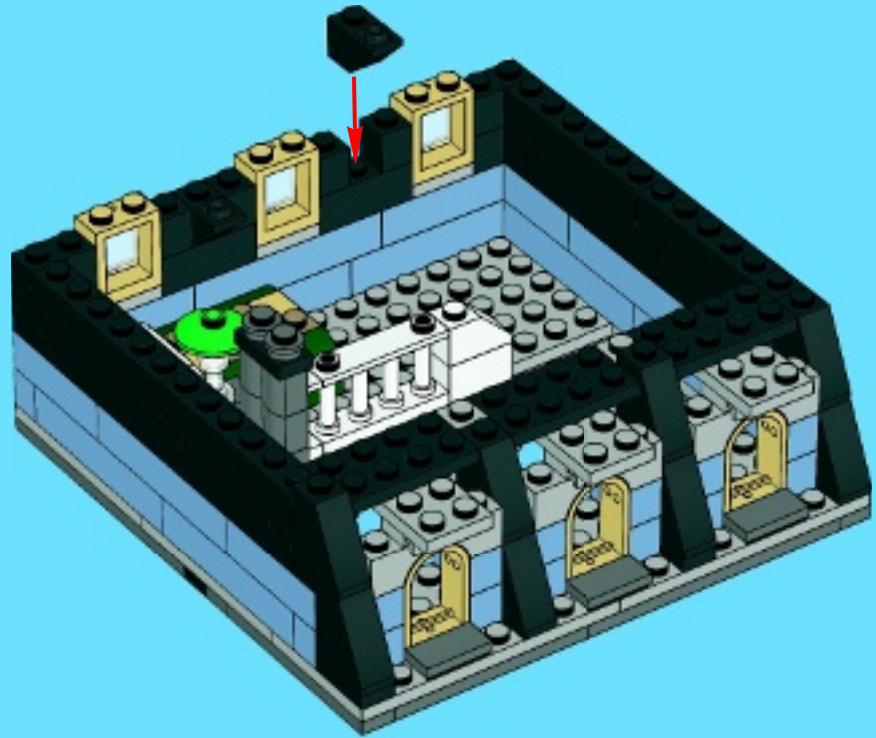

12x



2x



2x



2x

# 16

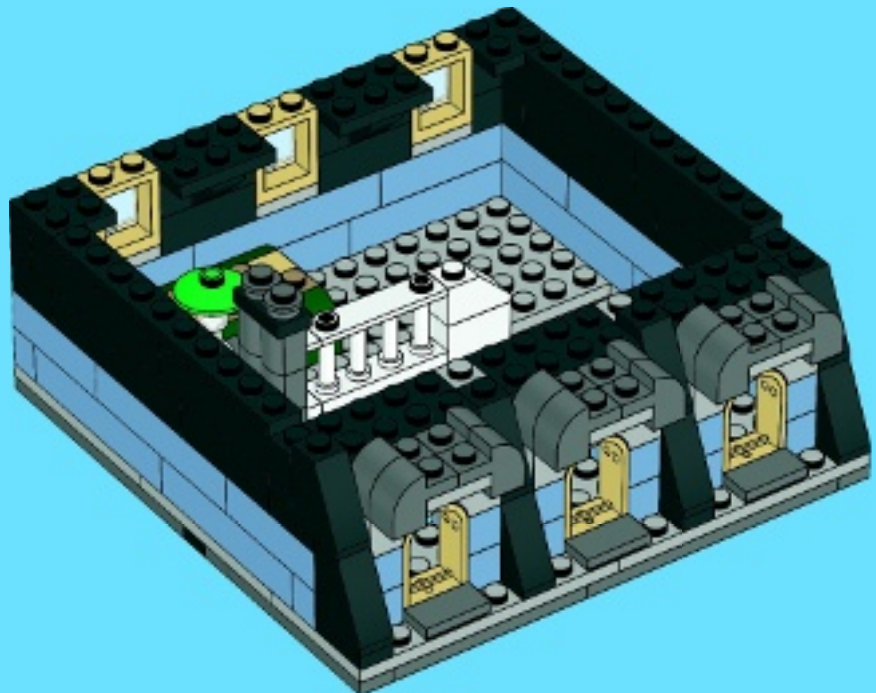





6x



2x



3x



3x

# 17

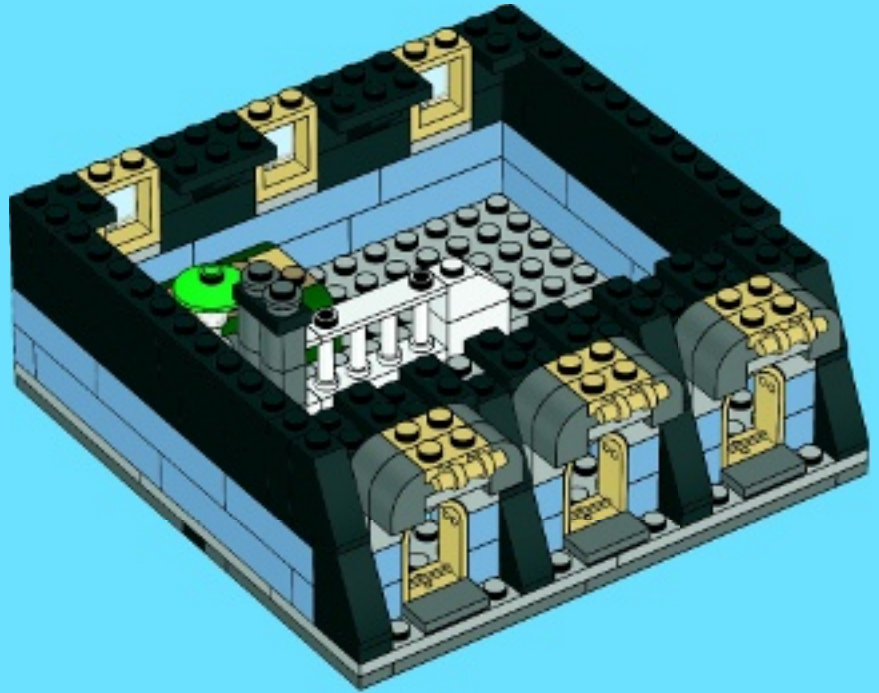

6x



6x



4x



2x



2x

# 18

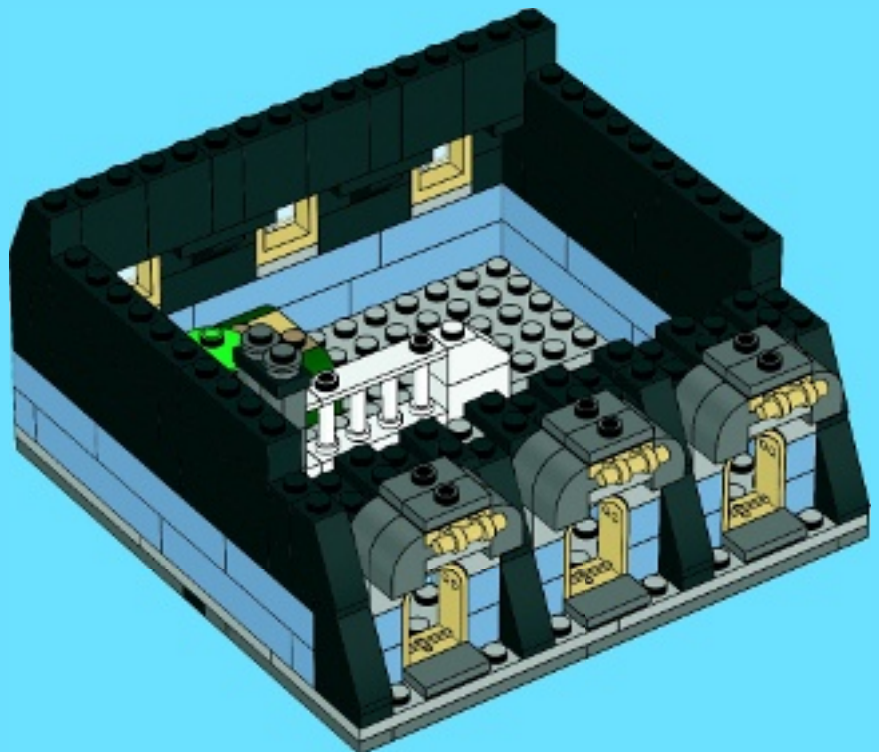



3x



16x

# 19

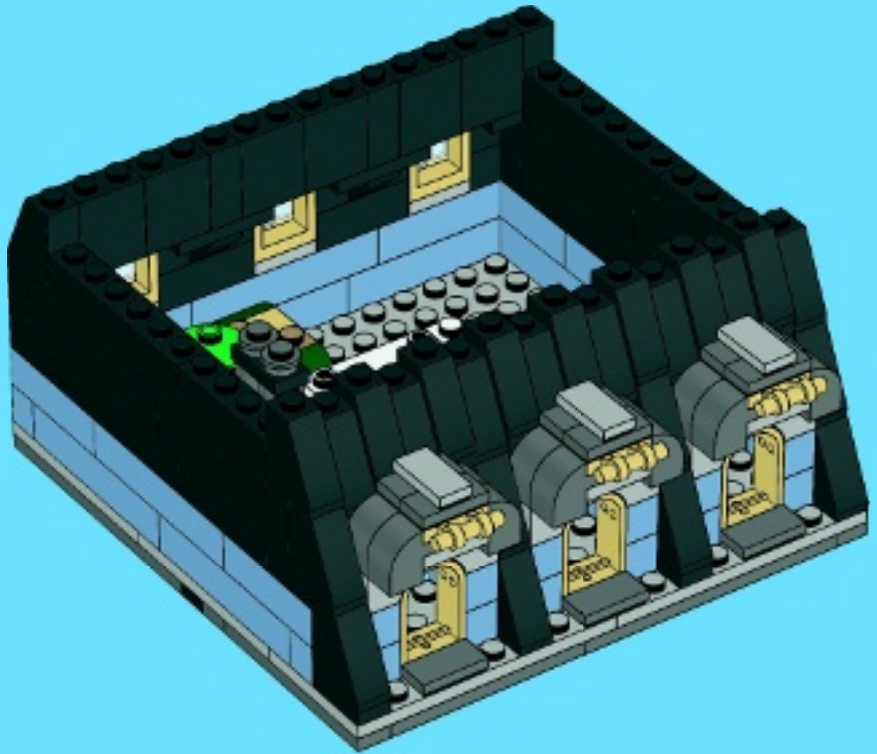

3x



3x



8x



2x



2x

# 20

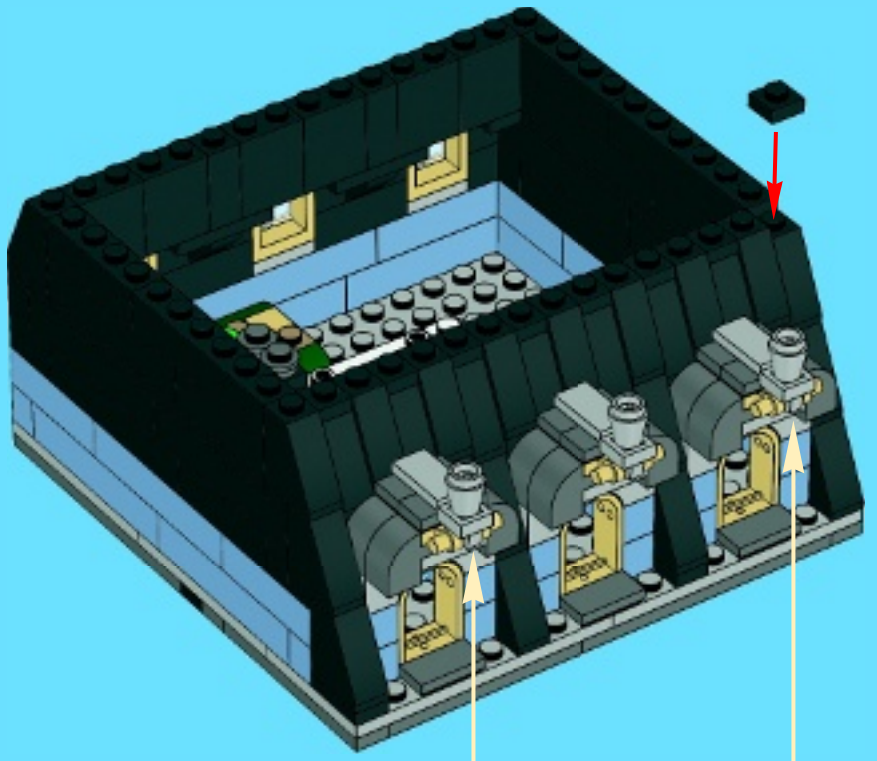

3x

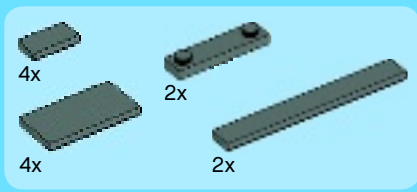

21

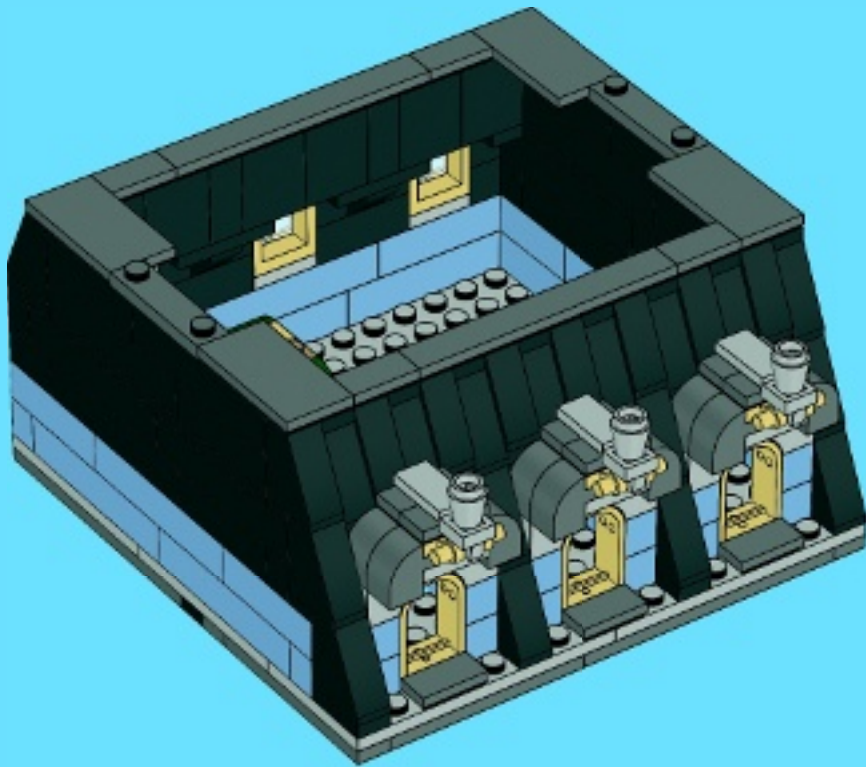

24

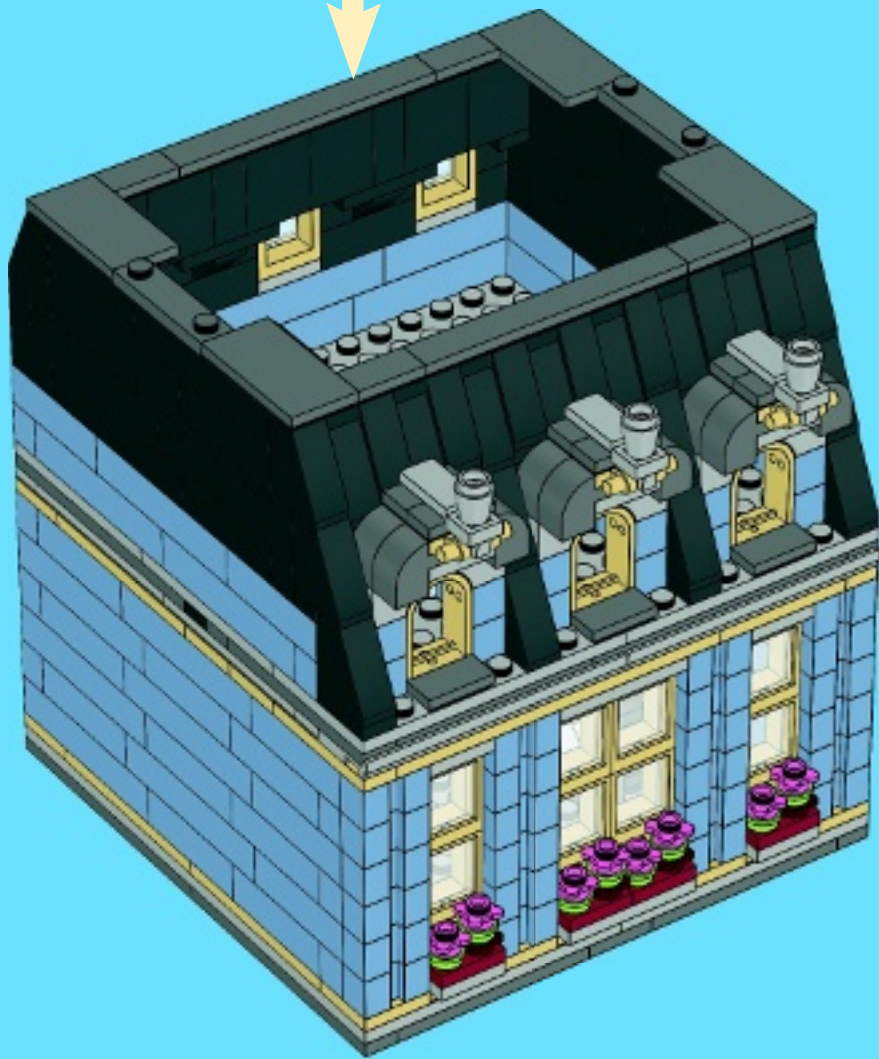

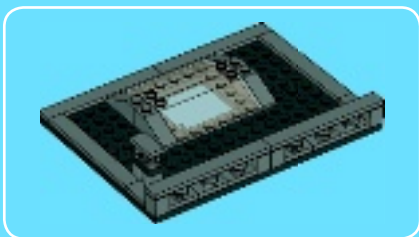

1

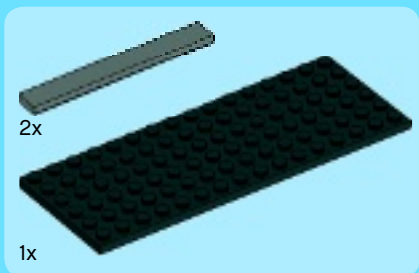
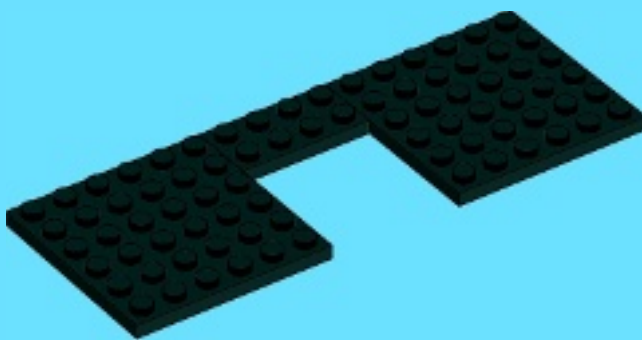

2

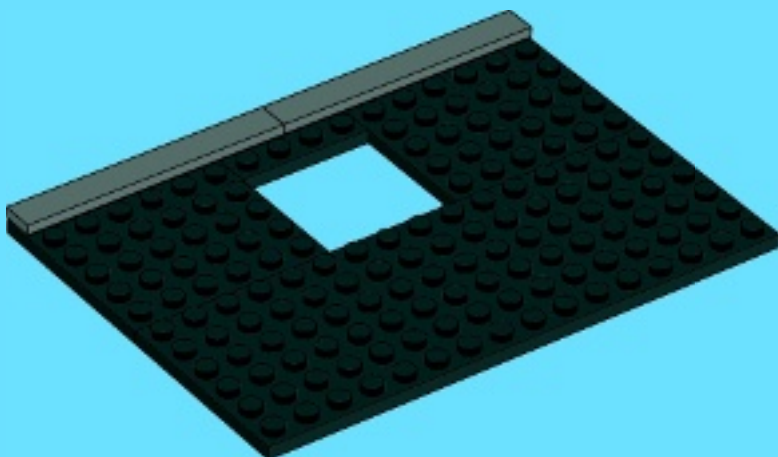

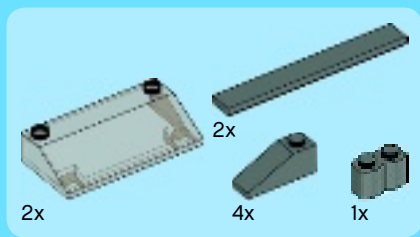

3

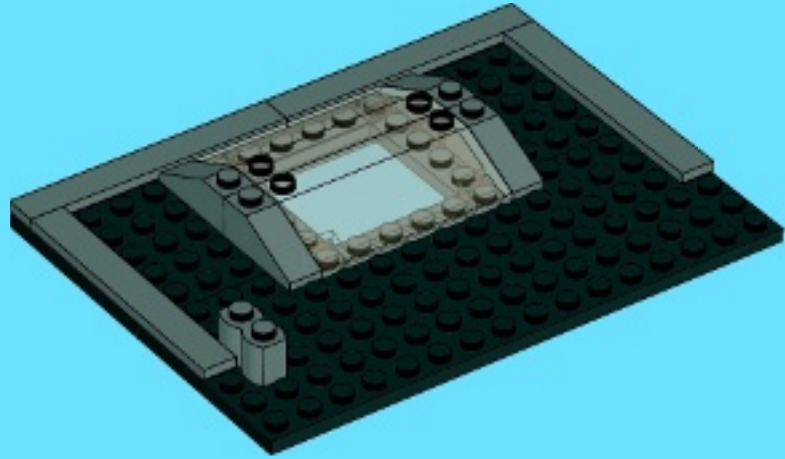

4

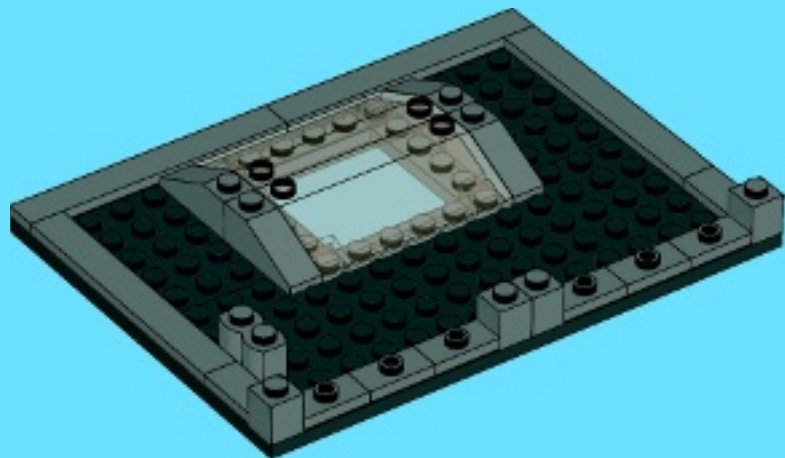

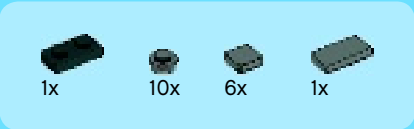

5

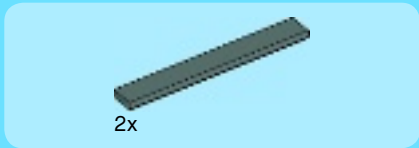
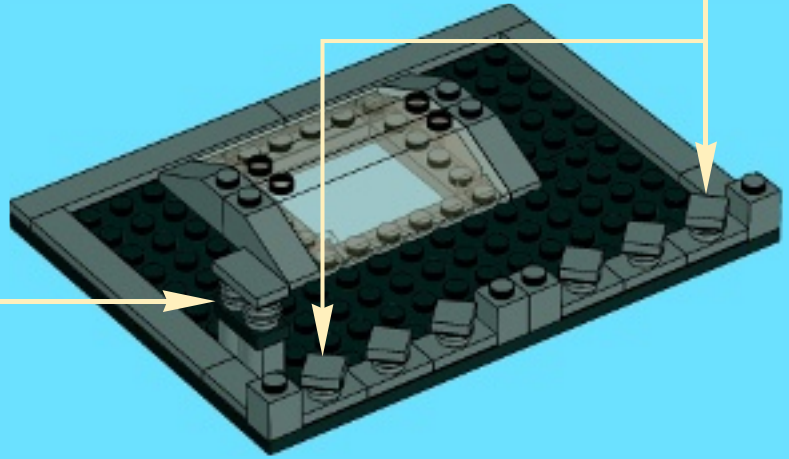
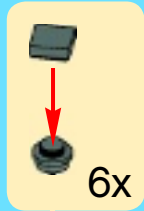
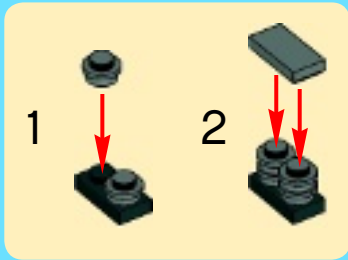

6

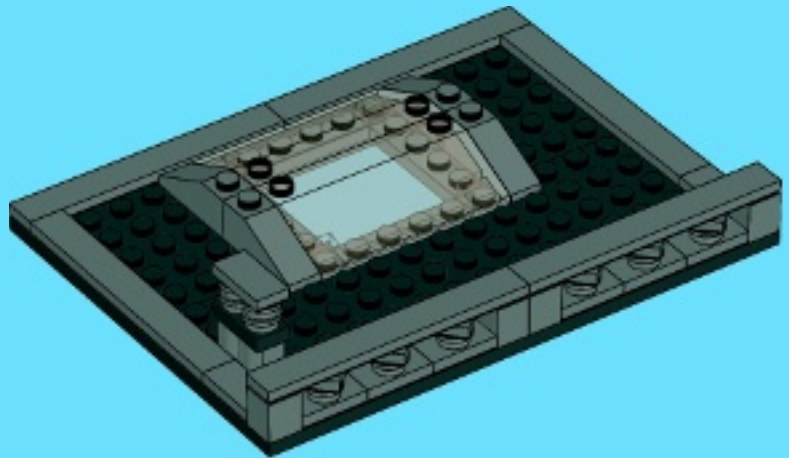

25

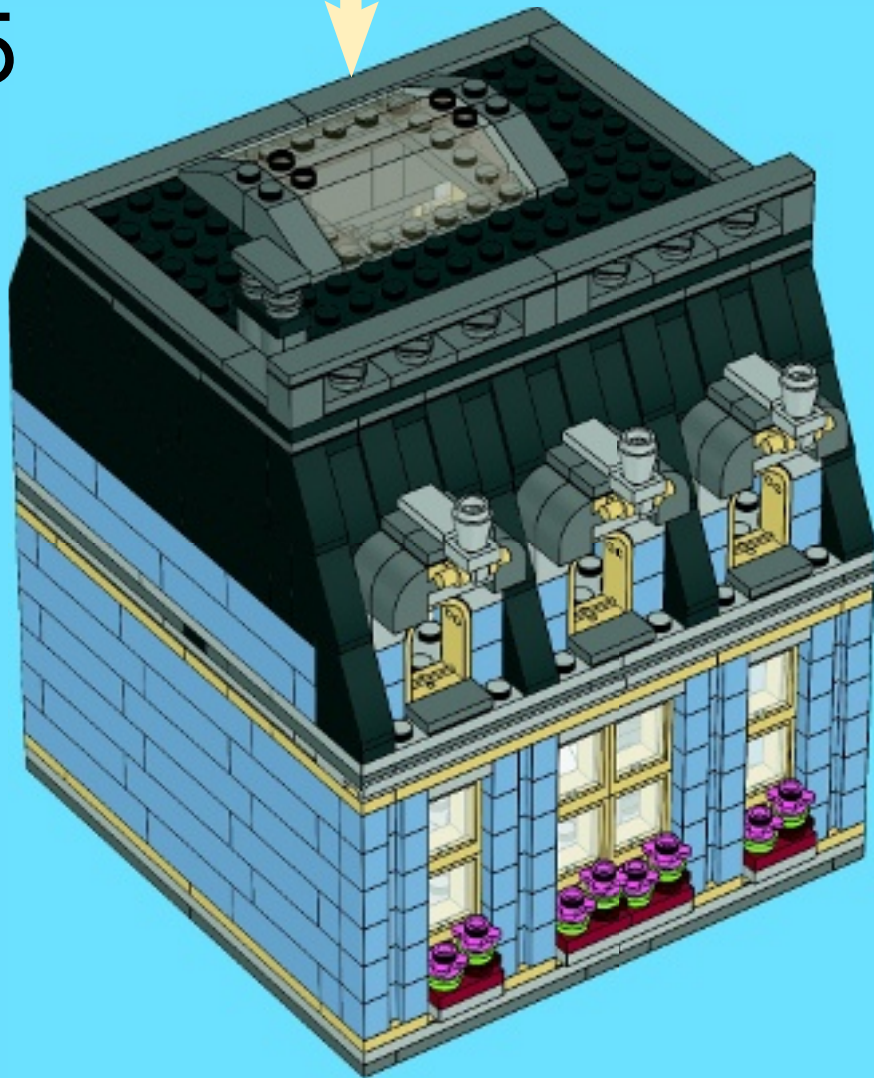





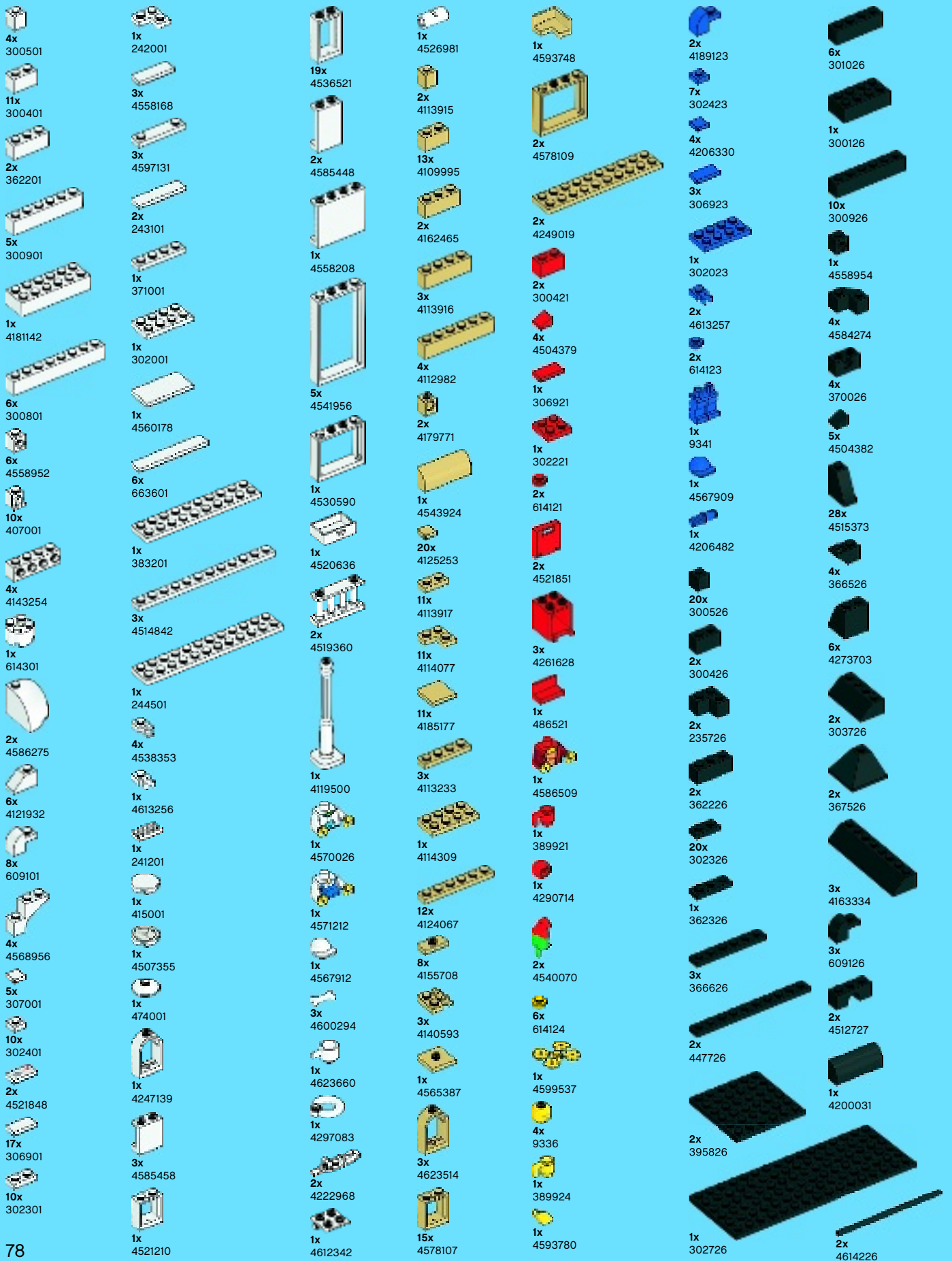

29x 302426  
 4x 302226  
 1x 4558170  
 2x 302126  
 7x 243126  
 5x 302026  
 3x 255526  
 1x 4632571  
 2x 4565323  
 4x 4515368  
 2x 317626  
 1x 4282746  
 3x 4114689  
 38x 614126  
 2x 403226  
 4x 4521208  
 1x 4536520  
 2x 459926  
 6x 243226

3x 4185652  
 3x 4187209  
 1x 4279270  
 1x 73587  
 2x 4538456  
 7x 4249857  
 5x 4598897  
 1x 4587844  
 2x 4289538  
 1x 393726  
 6x 4121715  
 1x 4140801  
 2x 4529239  
 4x 4107637  
 1x 4295260  
 6x 4569058  
 2x 4219615

1x 4567908  
 2x 4583718  
 1x 374128  
 1x 4586882  
 1x 4592277  
 9x 4619599  
 2x 4119479  
 1x 4624374  
 8x 4614158  
 3x 4616027  
 1x 4529755  
 2x 4119350  
 1x 3006844  
 1x 4567332  
 1x 3005744  
 1x 4540865  
 1x 306548

1x 4106556  
 16x 4552035  
 19x 4536998  
 4x 4113028  
 1x 4508261  
 1x 4521504  
 3x 4552033  
 1x 4219773  
 2x 3001140  
 1x 3000240  
 1x 626440  
 2x 4622574  
 1x 4620810







6x 4179826  
 14x 4528357  
 1x 4179828  
 2x 4581079  
 1x 4593773  
 1x 4623481  
 1x 4244368  
 1x 4200798  
 2x 4498370  
 15x 4183133  
 43x 4620077  
 62x 4620993  
 54x 4620992  
 48x 4620991  
 3x 4255416  
 3x 4247145  
 4x 4549436  
 4x 4528604

2x 4507045  
 3x 4570111  
 1x 4595712  
 1x 4595709  
 7x 4249891  
 1x 4296785  
 2x 4264578  
 6x 4264569  
 2x 4579753  
 2x 4623597  
 1x 4609925  
 7x 4623695  
 2x 4585518  
 2x 4539082  
 6x 4539097  
 2x 4539105  
 5x 4539061

1x 4539062  
 5x 4539063  
 1x 4541496  
 2x 4262655  
 7x 4624184  
 1x 4243668  
 37x 4211242  
 32x 4211149  
 2x 4211200  
 8x 4211220  
 9x 4211225  
 3x 4211201  
 32x 4211193  
 42x 4263776  
 16x 4225469  
 4x 4225823  
 4x 4529242  
 2x 4620075  
 5x 4211252  
 4x 4211199

- 7x 4211288
- 20x 4211150
- 2x 4211152
- 1x 4211186
- 2x 4211204
- 8x 4221590
- 3x 4558537
- 1x 4216945
- 3x 4623513
- 12x 4623429
- 1x 4211185
- 1x 4277751
- 1x 4550736
- 3x 4211389
- 4x 4211349
- 6x 4211428
- 2x 4211385
- 8x 4211393
- 2x 4558953
- 2x 4225532
- 7x 4550325
- 2x 4211460
- 2x 4211461
- 4x 4529241
- 2x 4211535
- 2x 4521921
- 2x 4211436
- 2x 4211488
- 2x 4251563
- 1x 4211570
- 5x 4211435
- 1x 4221600
- 13x 4211399
- 8x 4211415
- 9x 4211398
- 21x 4211414
- 5x 4211397
- 26x 4558169
- 8x 4211429
- 1x 4211396
- 8x 4211356
- 6x 4599498
- 10x 4211445
- 5x 4211395
- 1x 4560183
- 29x 4211549
- 15x 4211438
- 7x 4211452
- 3x 4211369
- 6x 4594238
- 19x 4211451
- 1x 4277927
- 20x 4211568
- 3x 4603503
- 1x 4211376
- 11x 4211425
- 4x 4211406
- 1x 4211498
- 4x 4222019
- 3x 4211407
- 2x 4211462
- 2x 4211408
- 2x 4211400
- 3x 4211733
- 3x 4598522
- 18x 4219256
- 12x 4211525
- 1x 4507056
- 1x 4211503
- 1x 4610112
- 11x 4215513
- 1x 4211769
- 3x 4211473
- 1x 4538098
- 1x 4227657
- 1x 4640844
- 1x 4211760
- 1x 4512743
- 2x 4542590
- 1x 4211483
- 3x 4211105
- 6x 4558955
- 1x 4213574
- 22x 4211095
- 9x 4211090
- 2x 4180811
- 6x 4211135
- 6x 4621917
- 5x 4560184
- 3x 4211065
- 9x 4211056
- 2x 4211002
- 10x 4210998
- 10x 4211008
- 1x 4211099
- 3x 4211107
- 1x 4210796
- 2x 4211085
- 4x 4211045
- 12x 4210797
- 10x 4210848
- 34x 4211052
- 1x 4210635
- 17x 4211055
- 4x 4211043
- 24x 4211001
- 2x 4598769
- 21x 4211119
- 24x 4210633
- 1x 4211010
- 2x 4521386
- 1x 4626645
- 1x 4272368
- 2x 4211050
- 8x 4216479
- 1x 4567509
- 4x 4566522
- 1x 4490082
- 4x 4249040
- 1x 4581313
- 1x 4603517
- 1x 4624615
- 1x 4624598



**Customer Service**  
**Kundenservice**  
**Service Consommateurs**  
**Servicio Al Consumidor**  
[www.lego.com/service](http://www.lego.com/service) or dial  
 00800 5346 5555 :       
 1-800-422-5346 :  



# CREATOR

5770

5771



creator.LEGO.com





10220





FREE! GRATIS! GRATUIT!



www.LEGOclub.com



LEGO® Club Magazine



LEGO® Club Email

SIGN UP ONLINE!

www.LEGOclub.com

VISIT THE WORLD'S BIGGEST LEGO® SHOP!

www.LEGOshop.com



GO TO

www.LEGOclub.com

00800 5346 5555\*



1-866-534-6258 • 1-877-518-5346

US & Canada only

Canada seulement



\* Freephone. Mobile charges may apply. \* Numéro sans frais. Des frais peuvent s'appliquer avec les téléphones cellulaires. \* Gebührenfrei. Kosten für Anrufe aus Mobilfunknetzen können abweichen. \* Gratis telefoonnummer vanaf vaste lijn. \* Det er et gratis nummer, når du ringer fra fasttelefon. \* Det är gratis, när du ringer från en fast telefon. \* Numéro sans frais. Des frais peuvent s'appliquer avec les téléphones portables.



# WIN!

Go to [www.LEGOsurvey.com/product](http://www.LEGOsurvey.com/product) to fill out a survey for a chance to win a cool LEGO® Product. No purchase necessary. Open to all residents where not prohibited.



[www.LEGO.com](http://www.LEGO.com)



## [www.LEGOsurvey.com/product](http://www.LEGOsurvey.com/product)

### GEWINNE!

Nimm an der Umfrage auf [www.LEGOsurvey.com/product](http://www.LEGOsurvey.com/product) teil und hab die Chance ein cooles LEGO® Produkt zu gewinnen!

Die Teilnahme am Gewinnspiel führt zu keinerlei Kaufverpflichtungen. Teilnahme in allen nicht ausgeschlossenen Ländern möglich.

### WIN!

Ga naar [www.LEGOsurvey.com/product](http://www.LEGOsurvey.com/product), vul een enquêteformulier in en maak kans op een cool LEGO® product.

Geen aankoopverplichting. Iedereen mag deelnemen, uitzonderd ingezetenden van landen waar een enquêteverbod geldt.

### GAGNE!

Visite [www.LEGOsurvey.com/product](http://www.LEGOsurvey.com/product) pour répondre à un questionnaire et avoir une chance de gagner un produit LEGO® très cool!

Aucune obligation d'achat. Ouvert à tous les résidents des pays autorisés.

### 当てよう!

[www.LEGOsurvey.com/product](http://www.LEGOsurvey.com/product) にアクセスして、アンケートにご記入ください。当選者にはレゴ製品を差し上げます。

お買い上げの必要はありません。禁止されていない限り、すべての皆様にご利用いただけます。

Trademarks, design patents and copyrights are used with the approval of the owner Volkswagen AG./

Les marques déposées, les brevets de conception et les copyrights sont utilisés avec l'autorisation du propriétaire Volkswagen AG./ El uso de las marcas comerciales, patentes de diseño y derechos de autor se realiza con el consentimiento de su propietario, Volkswagen AG. LEGO and the LEGO logo are trademarks of the LEGO Group. ©2011 The LEGO Group. ©2011 LucasFilm Ltd. & TM. All rights reserved.