



DC UNIVERSE™
**SUPER
HEROES**

4526



BATMAN™



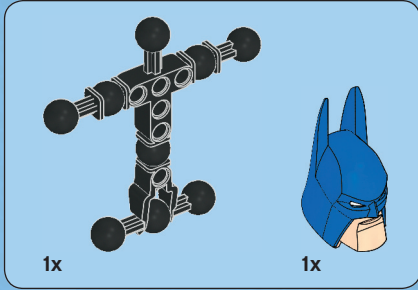

1

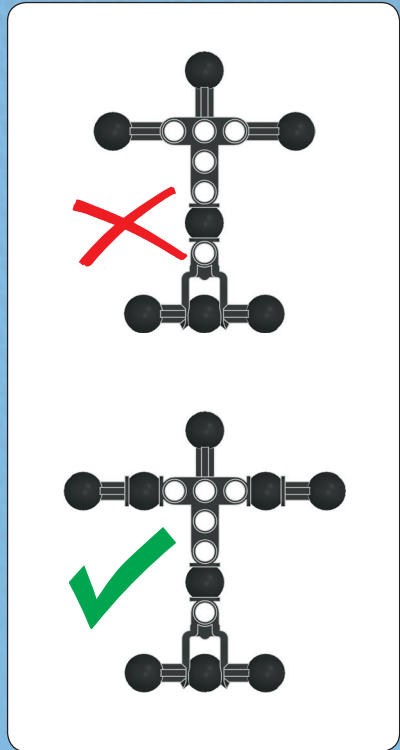
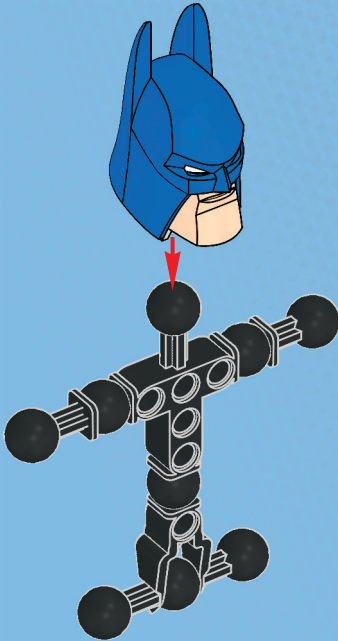

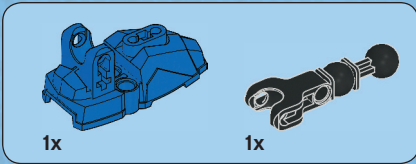
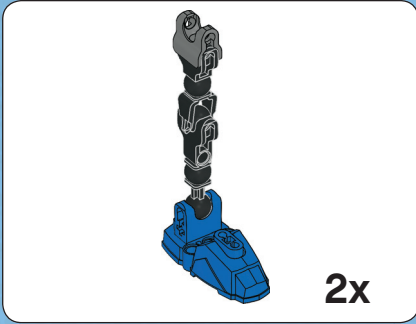

1

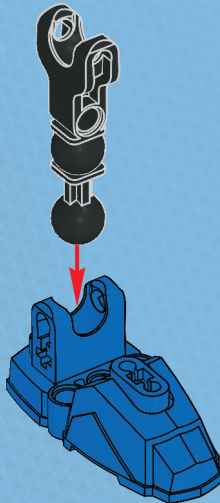

4

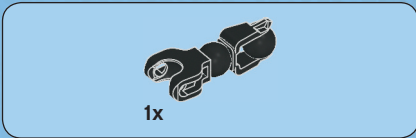

2

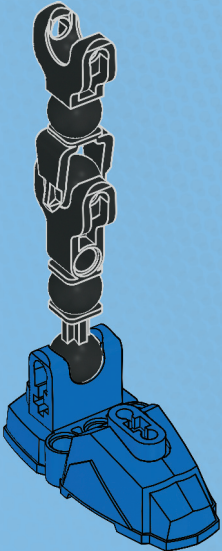

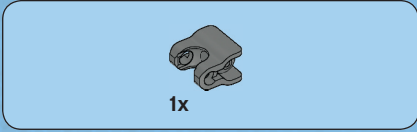

3

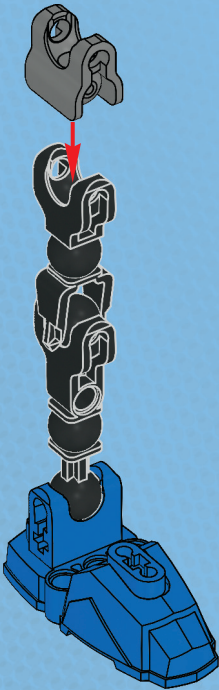

2x

6

4

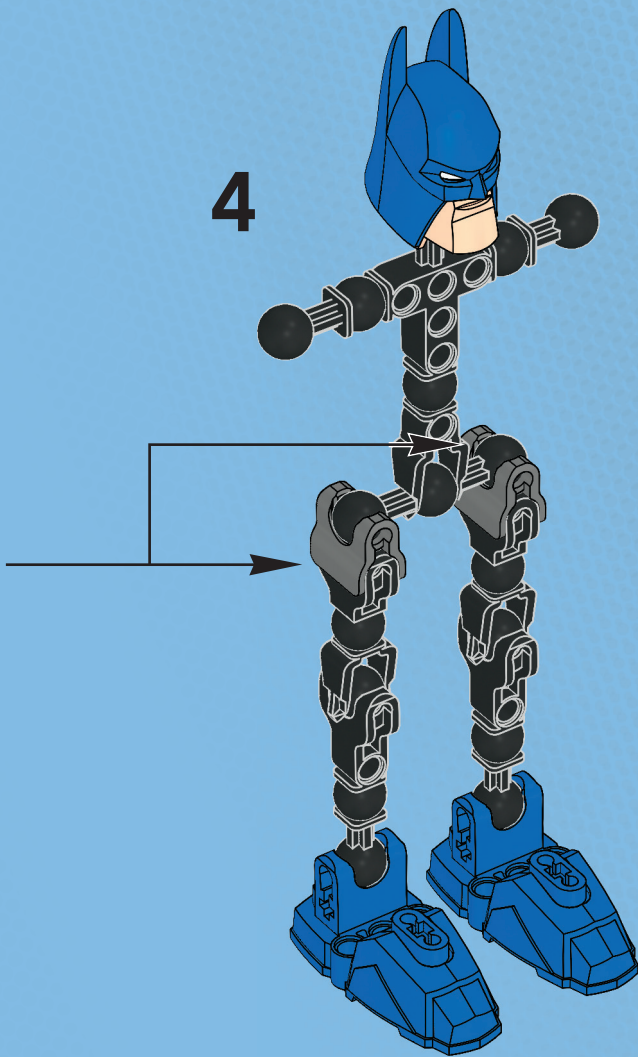

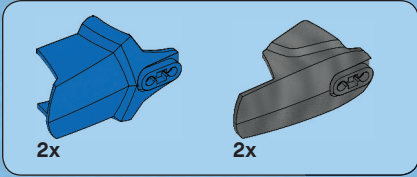

5

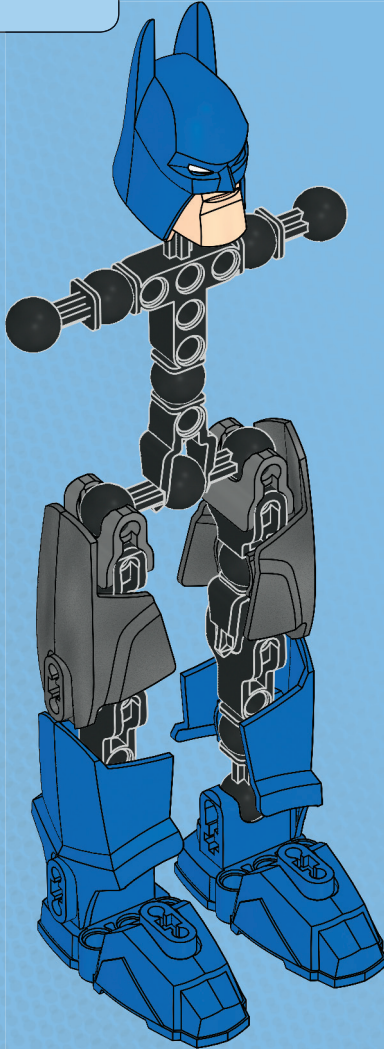

8

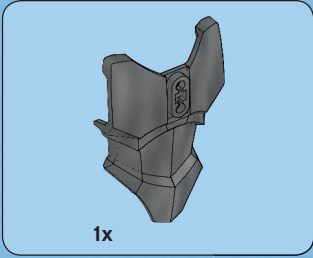

6

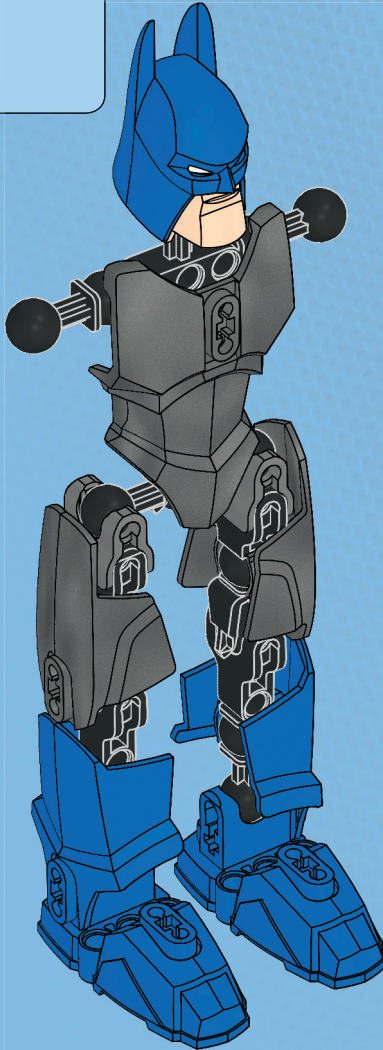

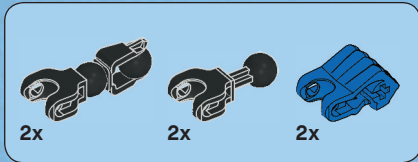

7

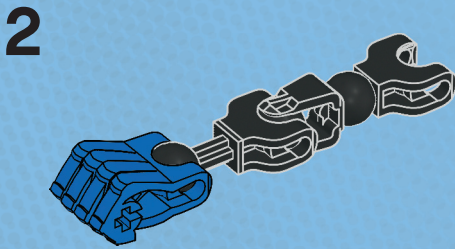
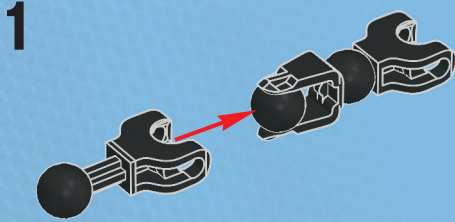

2x

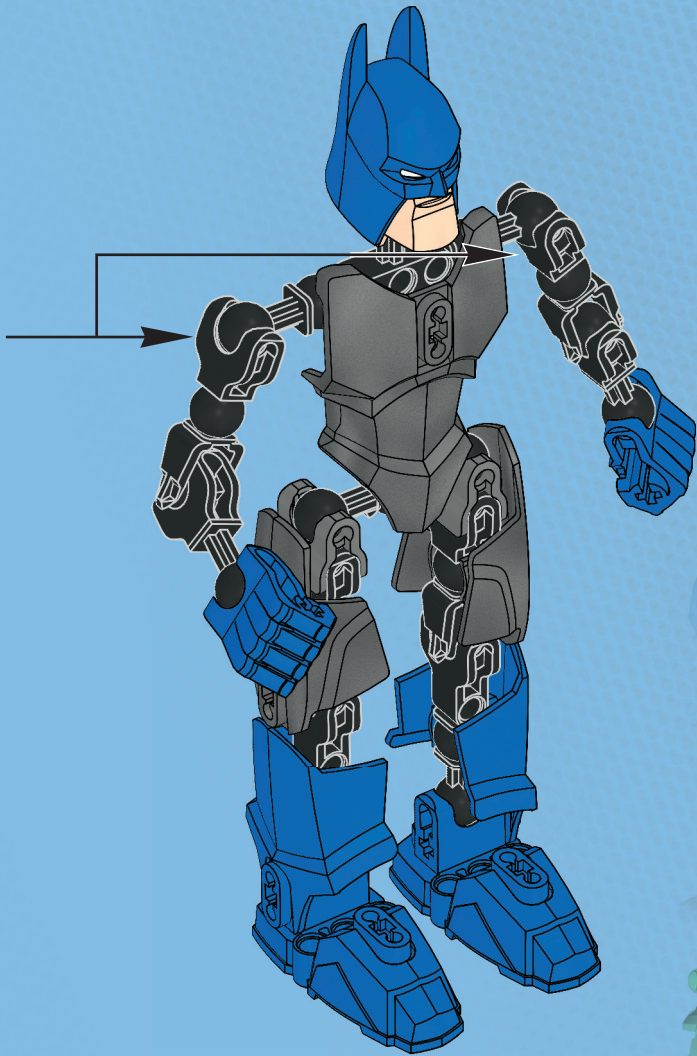



8

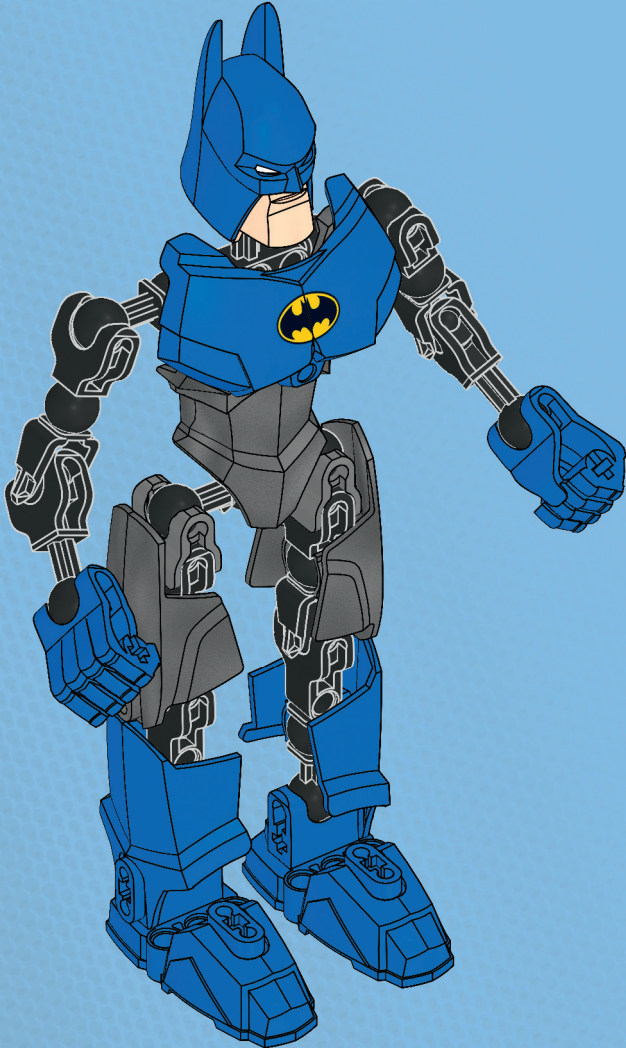

12

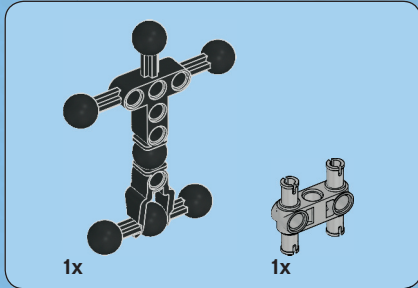

9

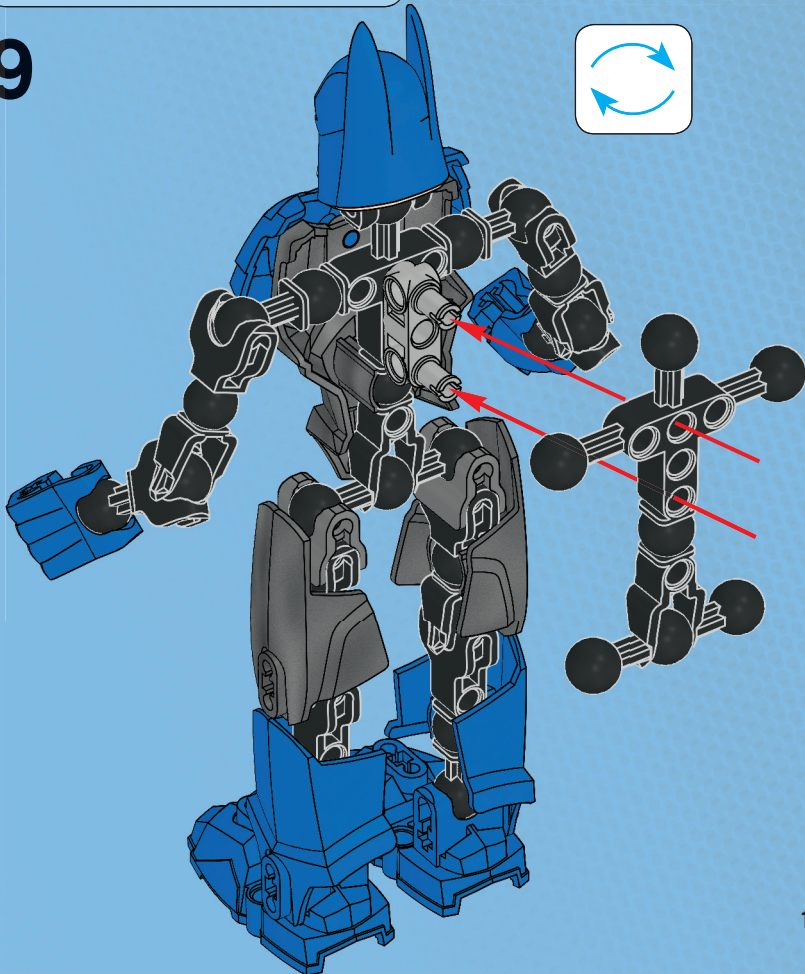
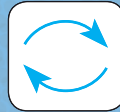

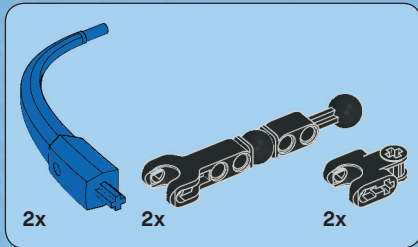

10

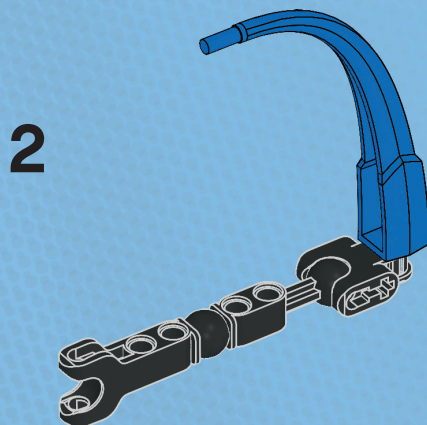
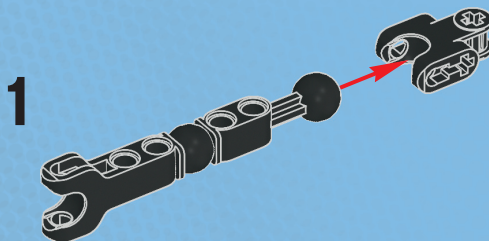

2x

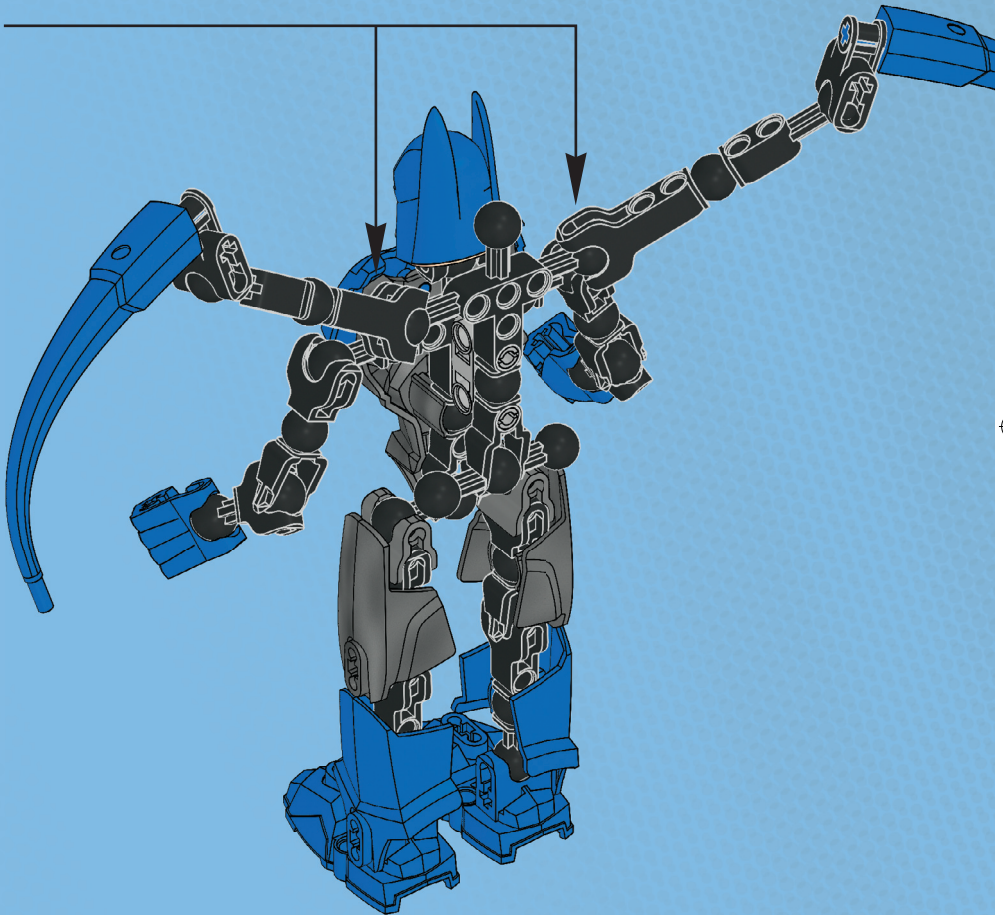

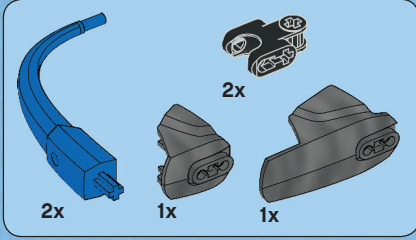

11

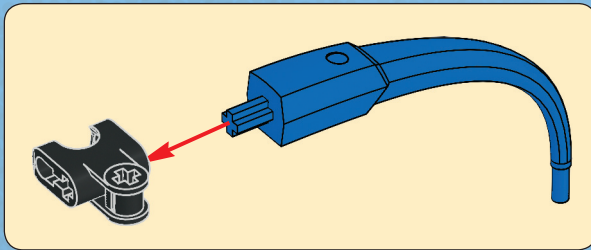
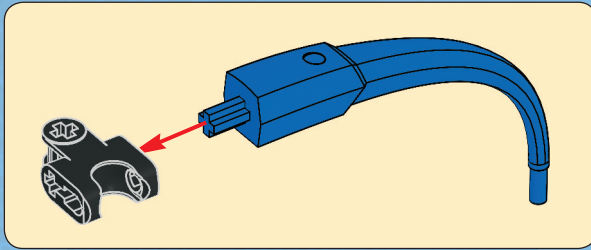

16

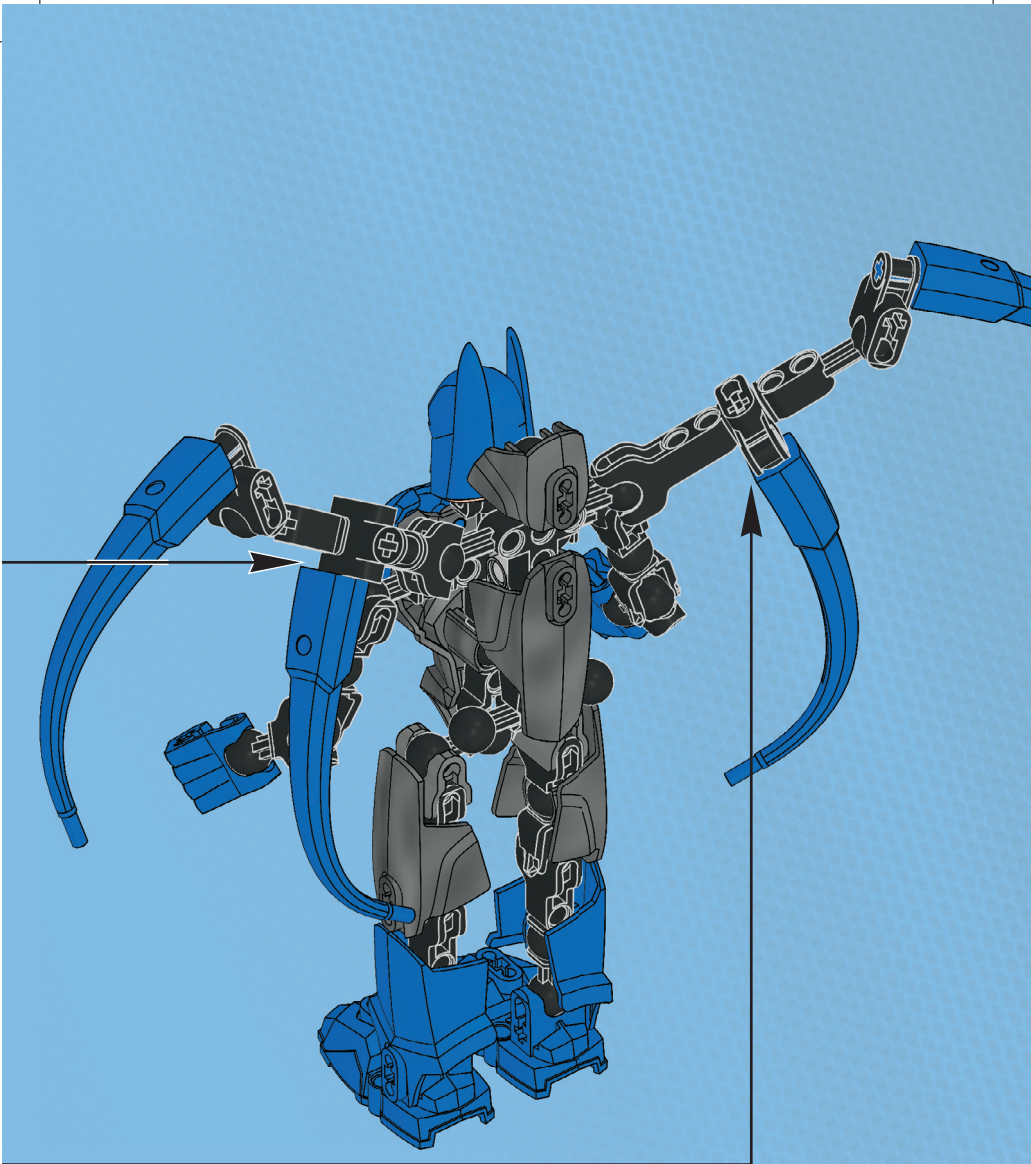

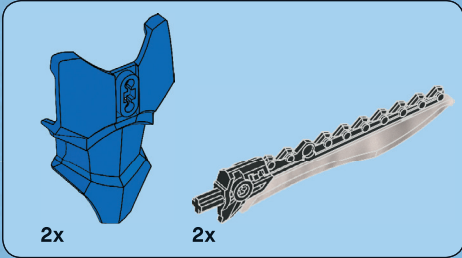

12

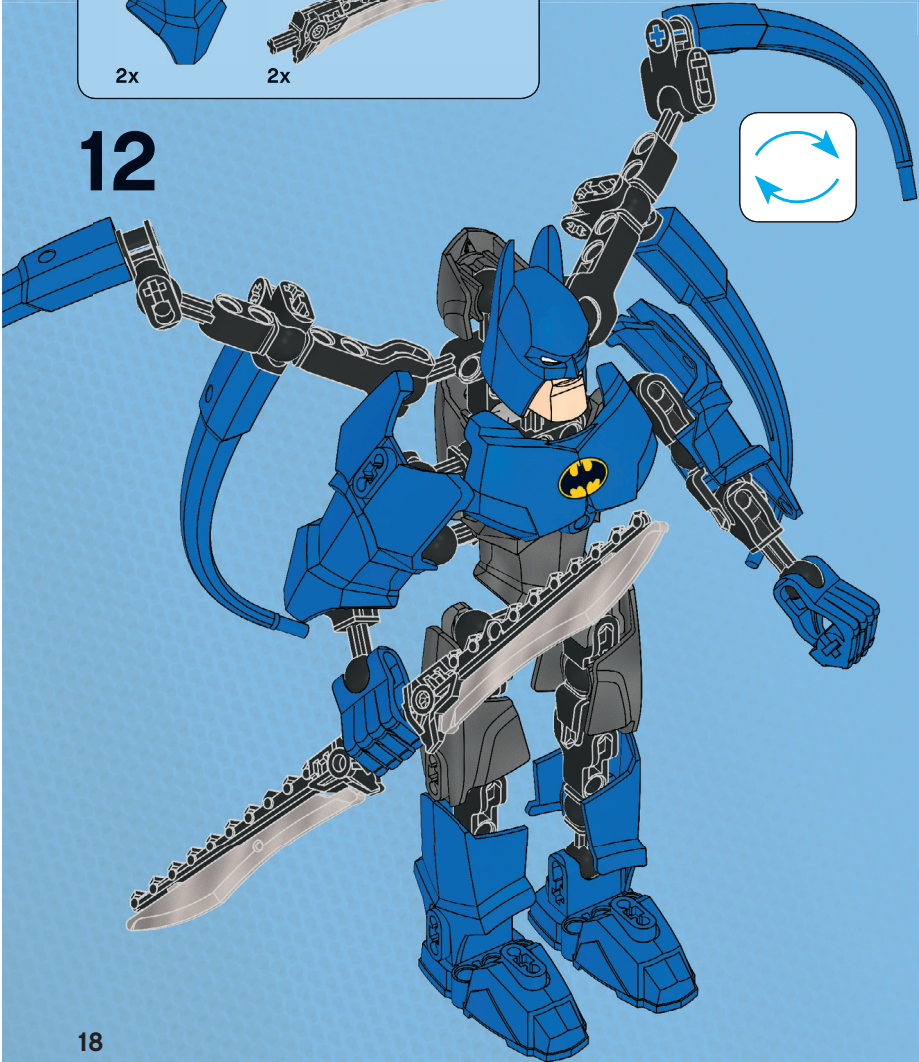

18



2x
4610919



2x
4632582



1x
4651752



4x
4653564



1x
4654434

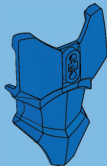

2x
4611797

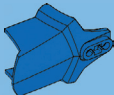

2x
4609804



2x
4652171



4x
4610948



4x
4589952



2x
4593554

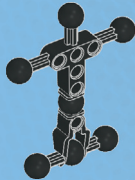

1x
4589953

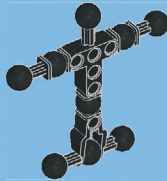

1x
4593571

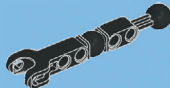

2x
4610696



2x
4609682



2x
4666471



1x
4632613

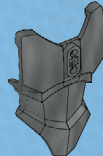

1x
4632593

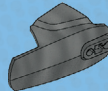

3x
4632628



1x
4225033



Customer Service

Kundenservice

Service Consommateurs

Servicio Al Consumidor

www.lego.com/service or dial



: 00800 5346 5555



: 1-800-422-5346



4527 THE JOKER



4528 GREEN LANTERN

LEGO DC UNIVERSE™
SUPER HEROES

4526 BATMAN™ + 4528 GREEN LANTERN

DCUNIVERSESUPERHEROES.LEGO.COM

The advertisement features a blue background with a white grid pattern. It shows the LEGO Batman minifigure (set 4526) and the LEGO Green Lantern minifigure (set 4528) being combined to form a new, larger minifigure. The new figure is primarily blue and green, with a Batman logo on its chest and a Green Lantern emblem on its leg. The background is a dark blue with a white grid pattern. The text "LEGO DC UNIVERSE™ SUPER HEROES" is prominently displayed at the top. Below it, the sets "4526 BATMAN™" and "4528 GREEN LANTERN" are shown with a plus sign between them. Arrows point from the two sets to the new figure. At the bottom, the website "DCUNIVERSESUPERHEROES.LEGO.COM" is listed.



6203



HERO FACTORY



6217

6200

6202

6227

6298





DC UNIVERSE™
**SUPER
HEROES**



6860



6864



6858



6862



6863





www.LEGOclub.com



clubTM

FREE! GRATIS! GRATUIT!



LEGO® Club Magazine



LEGO® Club Email

SIGN UP ONLINE!

www.LEGOclub.com

**VISIT THE WORLD'S
BIGGEST LEGO® SHOP!
www.LEGOshop.com**

00800 5346 5555         

  **1-866-534-6258 • 1-877-518-5346**

US & Canada only

Canada seulement



* Freephone. Mobile charges may apply. * Numéro sans frais. Des frais peuvent s'appliquer avec les téléphones cellulaires. * Gebührenfrei, Kosten für Anrufe aus Mobilfunknetzen können abweichen. * Gratis telefoonnummer vanaf vaste lijn. * Det er et gratis nummer, når du ringer fra fasttelefon. * Det är gratis, när du ringer från en fast telefon. * Numéro sans frais. Des frais peuvent s'appliquer avec les téléphones portables.

BI112





WIN!

Go to www.LEGOsurvey.com/product
to fill out a survey for a chance
to win a cool LEGO® Product.
No purchase necessary.
Open to all residents where not prohibited.



www.LEGO.com



www.LEGOsurvey.com/product

GEWINNE!

Nimm an der Umfrage auf www.LEGOsurvey.com/product teil und hab die Chance ein cooles LEGO® Produkt zu gewinnen!

Die Teilnahme am Gewinnspiel führt zu keinerlei Kaufverpflichtungen. Teilnahme in allen nicht ausgeschlossenen Ländern möglich.

LEGO and the LEGO logo are trademarks of the/son des marques de commerce de/son marcas registradas de LEGO Group. ©2012 The LEGO Group.

WIN!

Ga naar www.LEGOsurvey.com/product, vul een enquêteformulier in en maak kans op een cool LEGO® product.

Geen aankoopverplichting. Iedereen mag deelnemen, uitgezonderd ingezetenden van landen waar een enquêteverbod geldt.

GAGNE!

Visite www.LEGOsurvey.com/product pour répondre à un questionnaire et avoir une chance de gagner un produit LEGO® très cool!

Aucune obligation d'achat. Ouvert à tous les résidents des pays autorisés.

当てよう!

www.LEGOsurvey.com/product にアクセスして、アンケートにご記入ください。当選者にはレゴ®製品を差し上げます。

お買い上げの必要はありません。禁止されていない限り、すべての皆様にご利用いただけます。



TM & © DC Comics.



WB SHIELD: TM & © Warner Bros. Entertainment Inc. (s12)

6002118 / 6002119