

60014

CITY



1



2



3



4



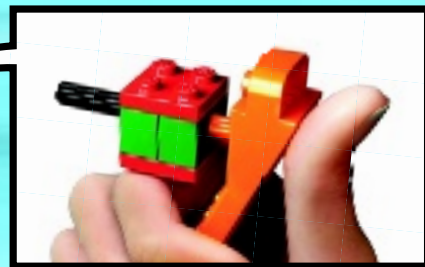
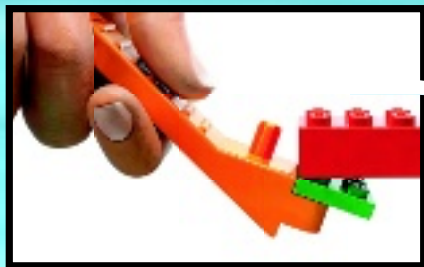

LEGO.com/brickseparator

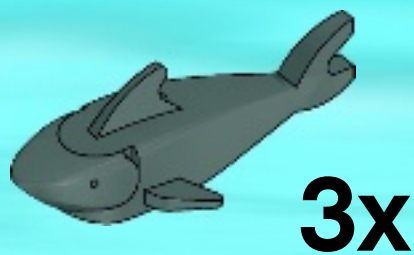
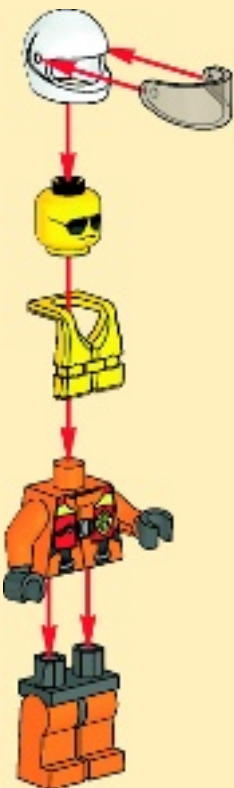
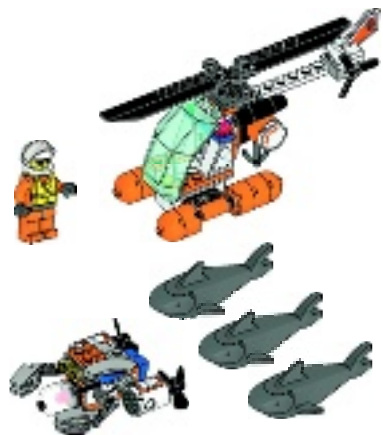



1x

1

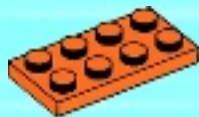

2x

2





2x

3



2x

4

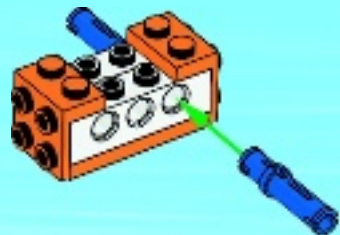



2x

5



4x

6

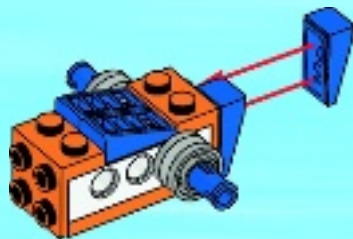



2x



2x



2x



2x

7

1



2



3



8



4

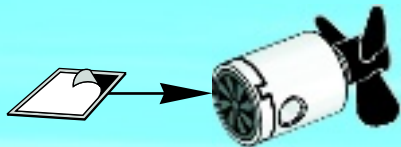

2x

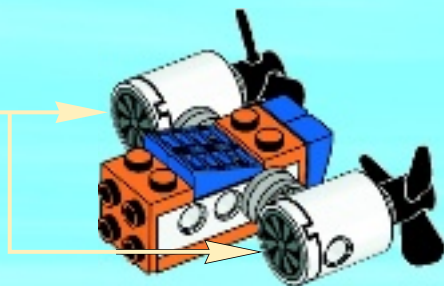

8

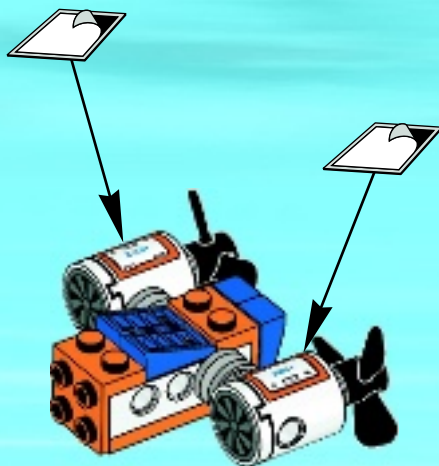



2x

9



2x

10





2x

11

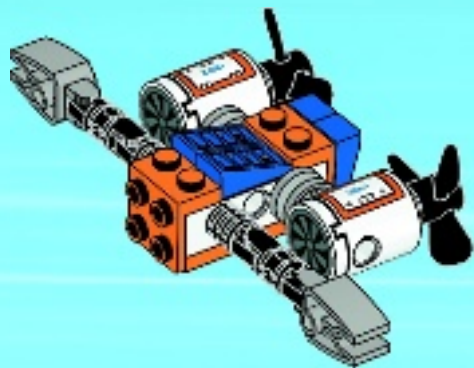

1x

12





1x



1x



1x

13

1



2





1x

14

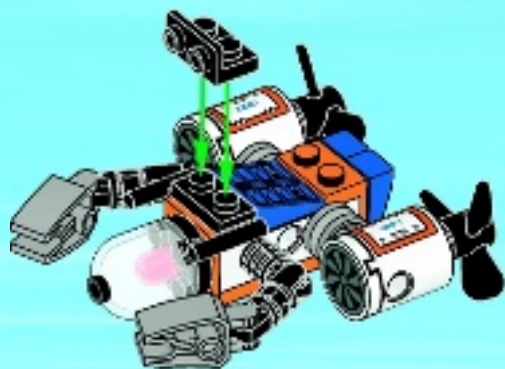



1x

15



2x



1x

16



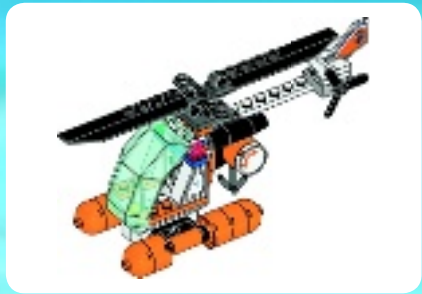

1



2

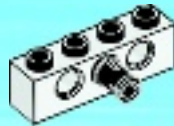



1x

3



1x

4

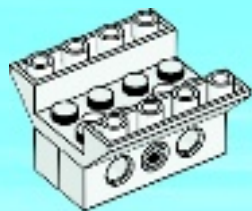



2x

5





2x

6



2x

7





1x

8

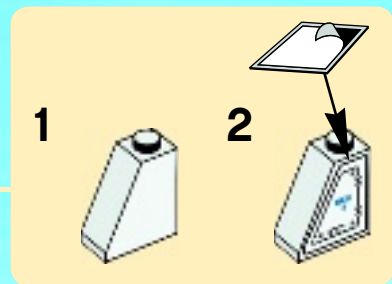



1x

9

1



2





1x



1x

10



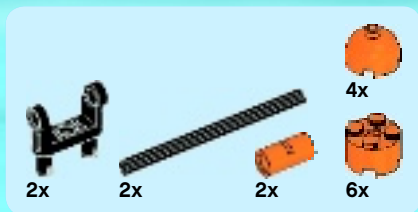
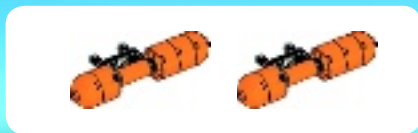

11

1



2

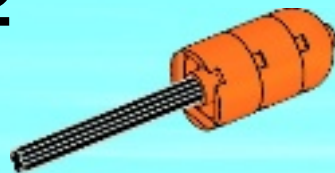

3

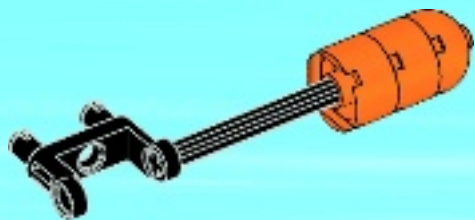

4

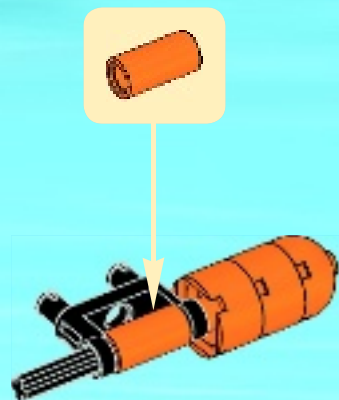



5

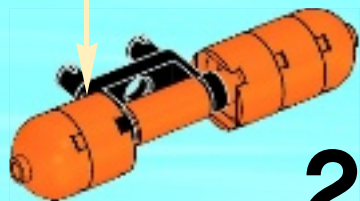

2x

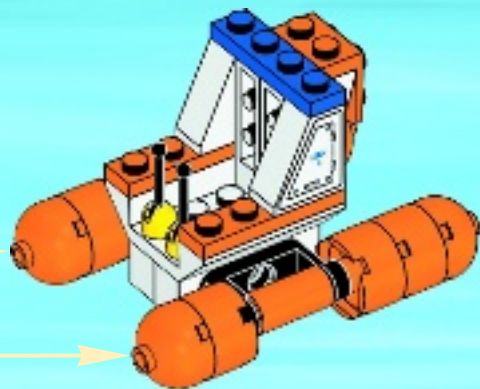



2x



1x



1x



2x



1x



1x



1x

12

1



2



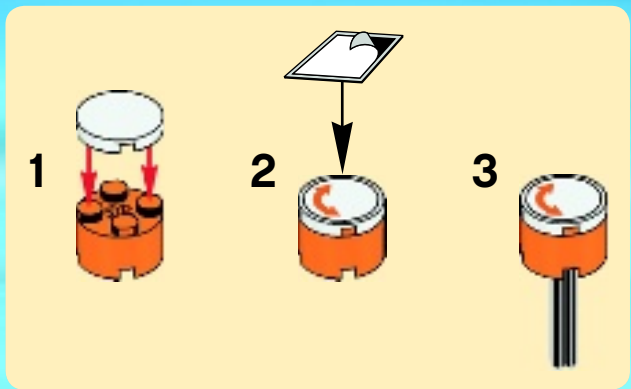

3



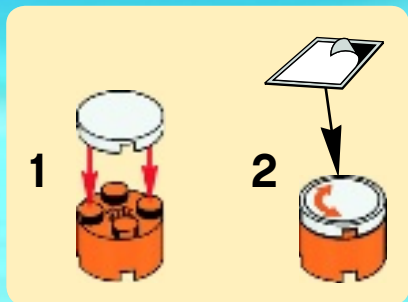

4



5



6

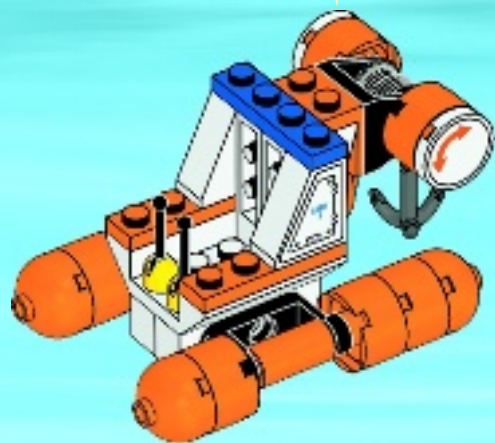



1x

13

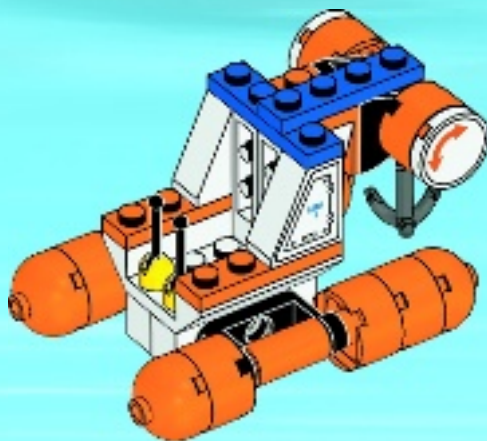

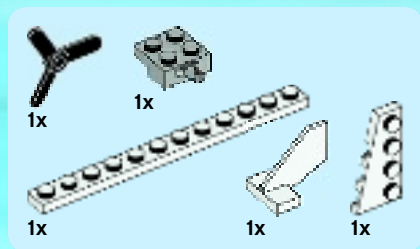

14

1

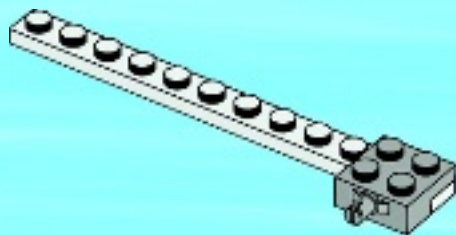

2

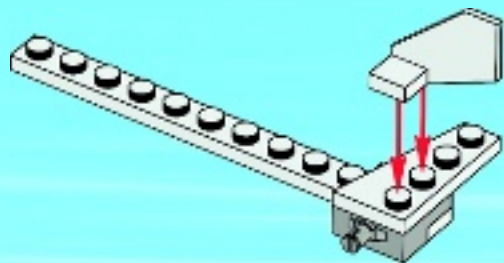

3

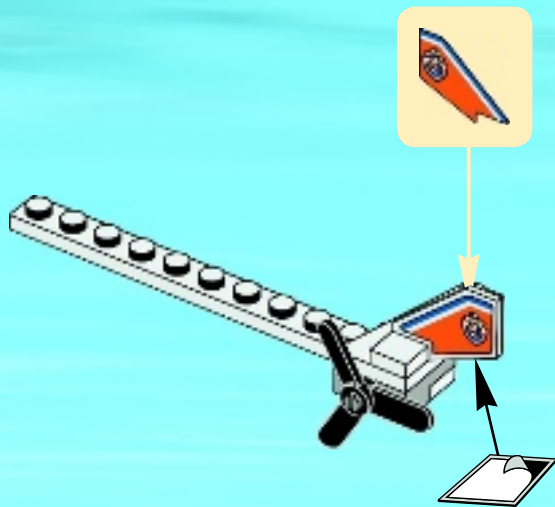

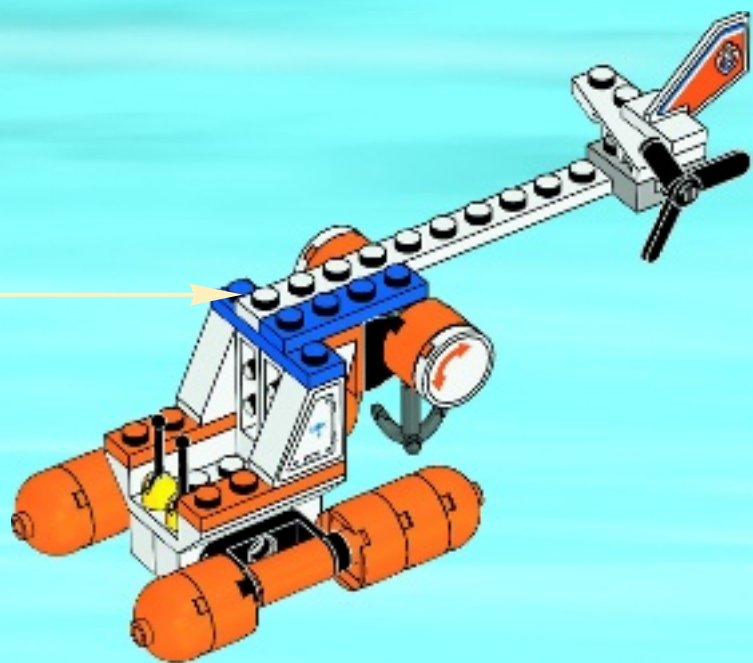



1x



2x

15

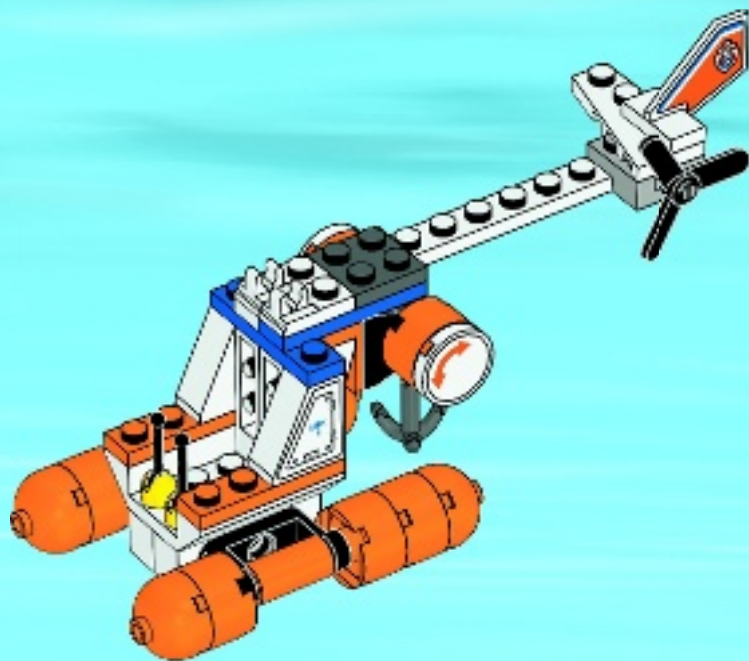



1x



1x



1x

16

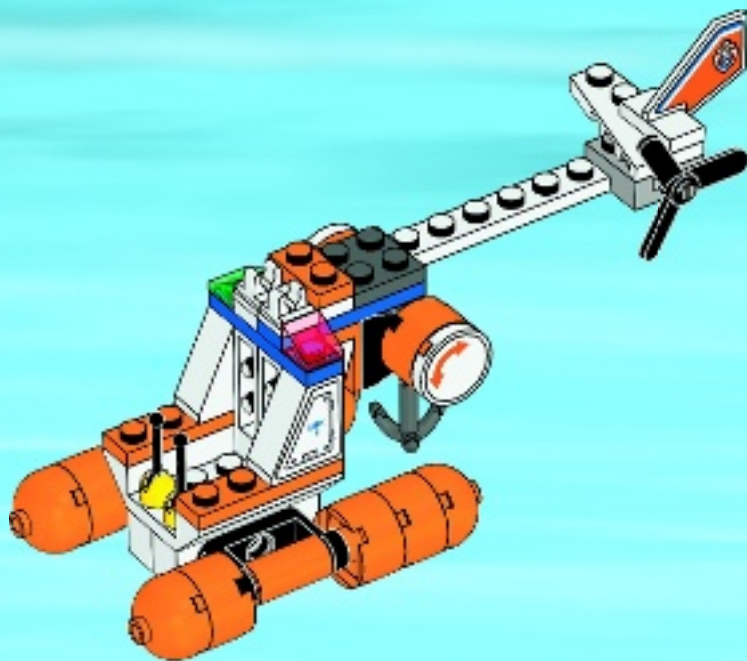



2x

17

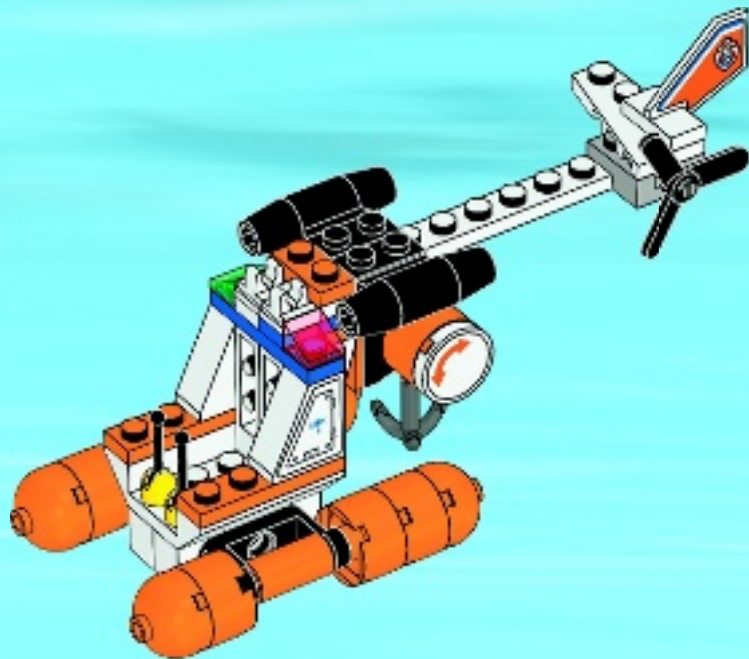



1x



1x

18

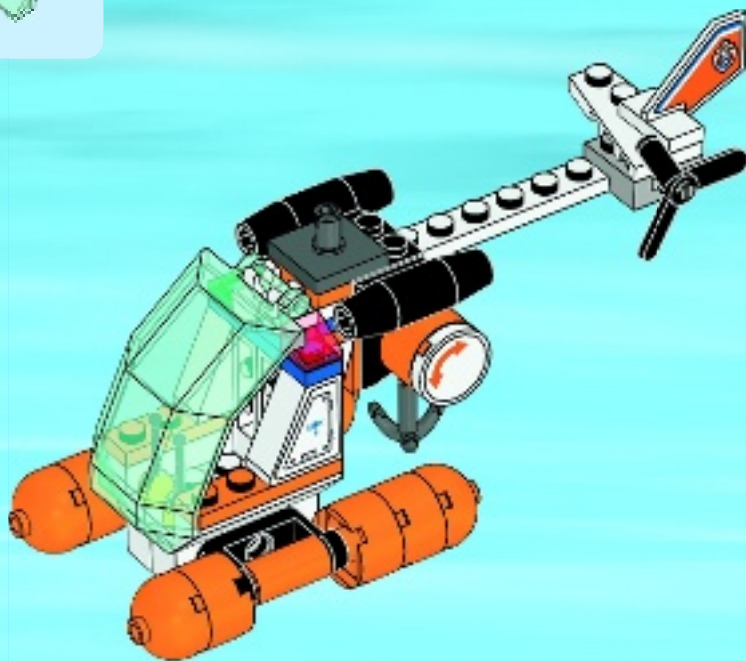

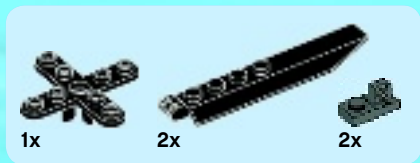

19

1



2



3



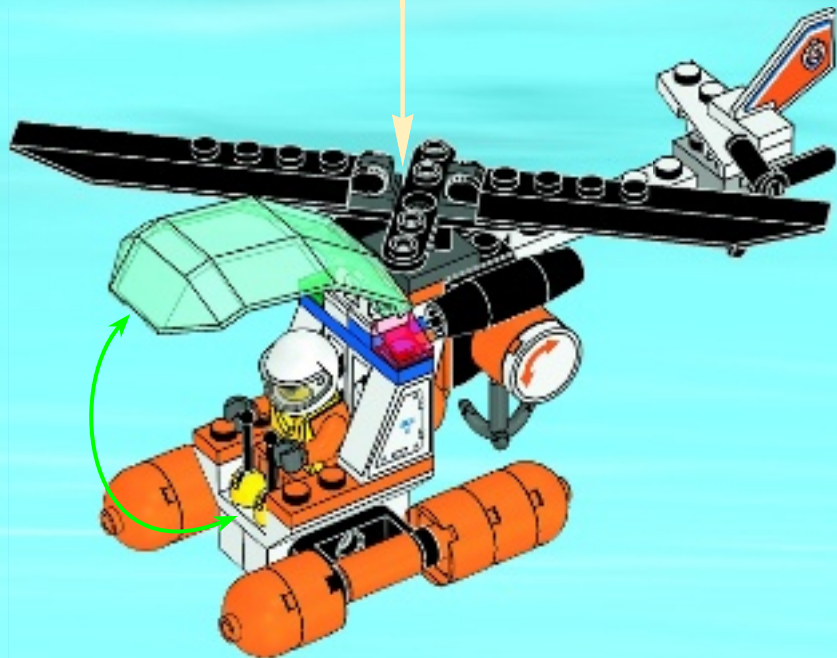



CITY

60014

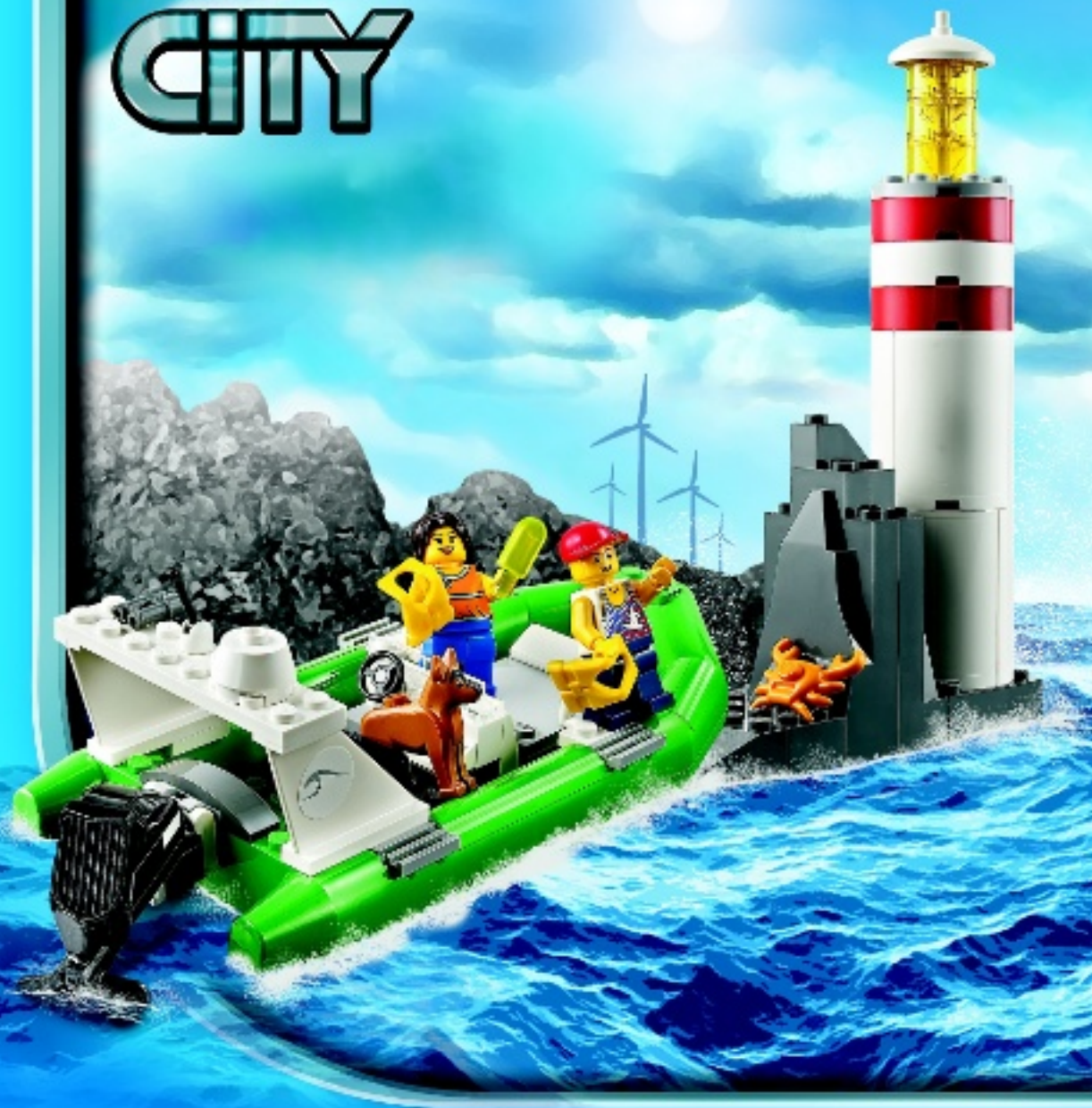

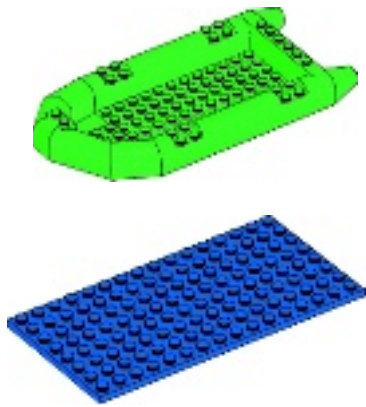

+

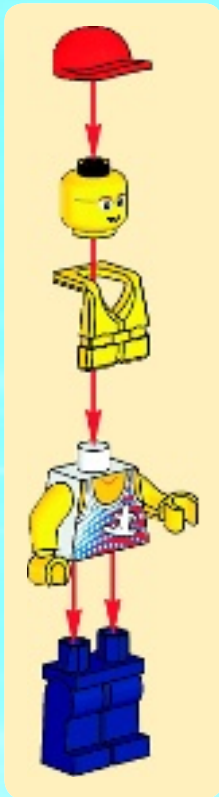

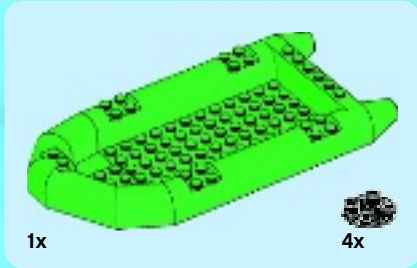
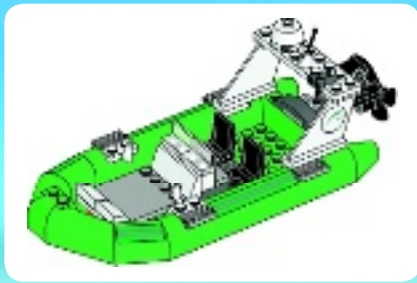

1

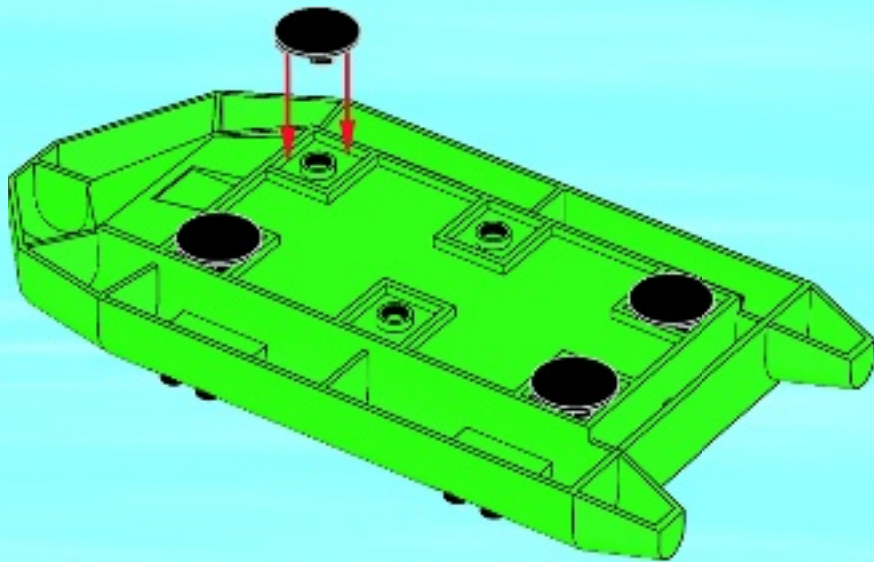



1x



2x

2

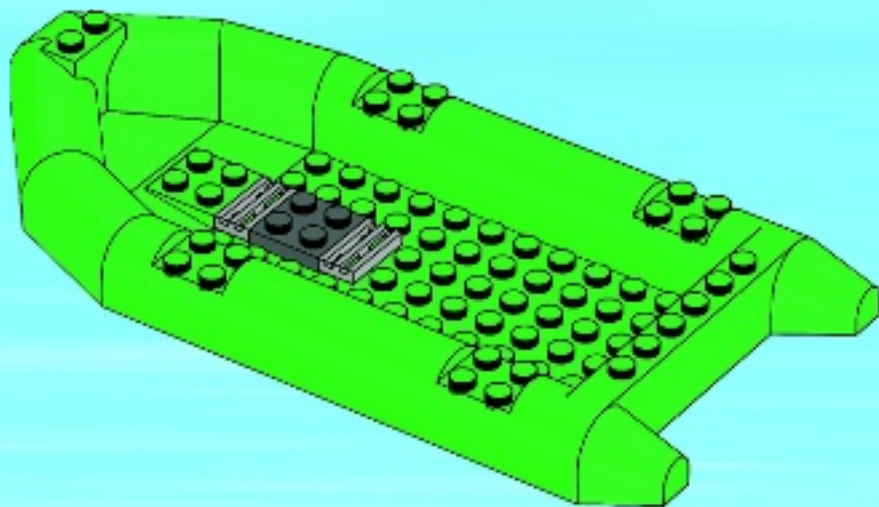



1x



1x

3

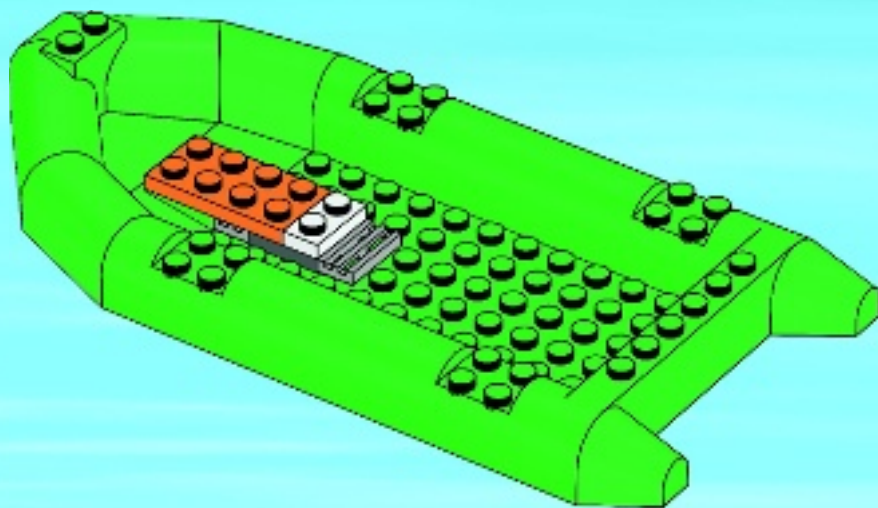



1x



1x

4

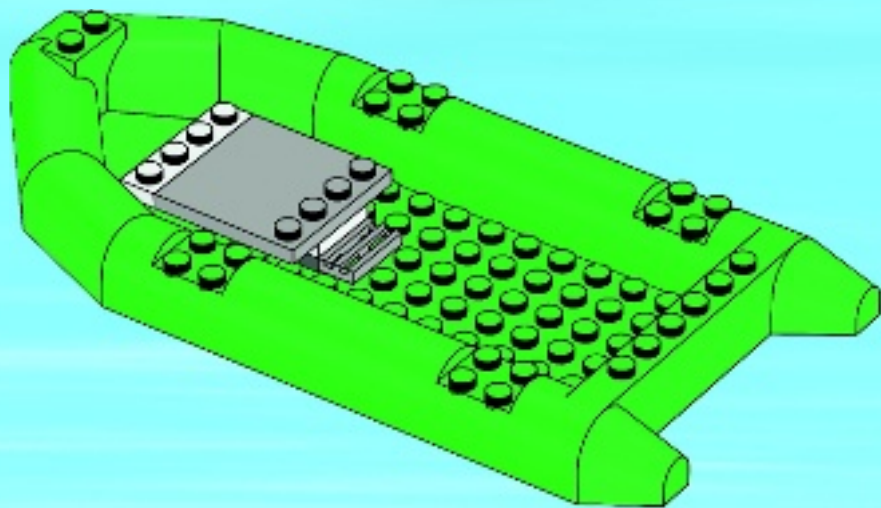



2x

5

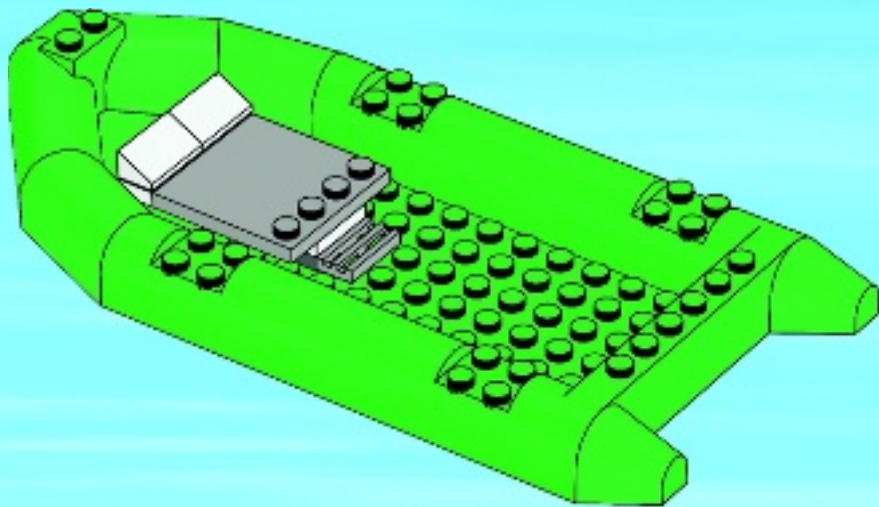



1x



2x



1x



1x



1x



1x

6

1



2

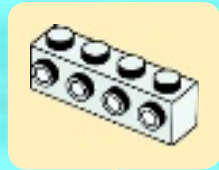

3



1

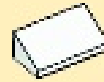

2



4



5

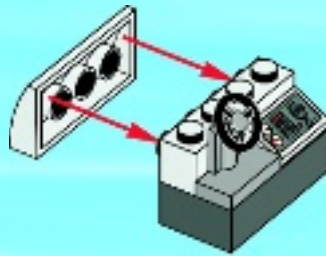

6



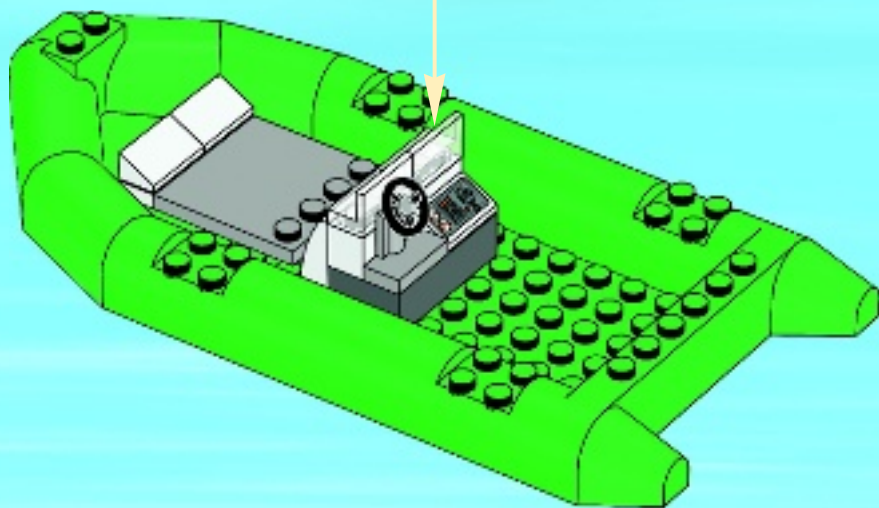



2x



1x

7

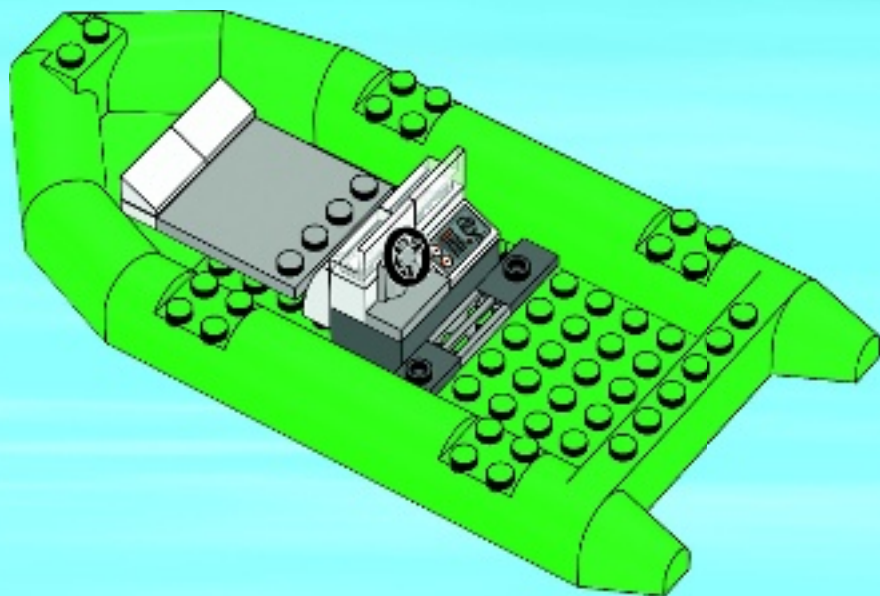



2x



1x

8

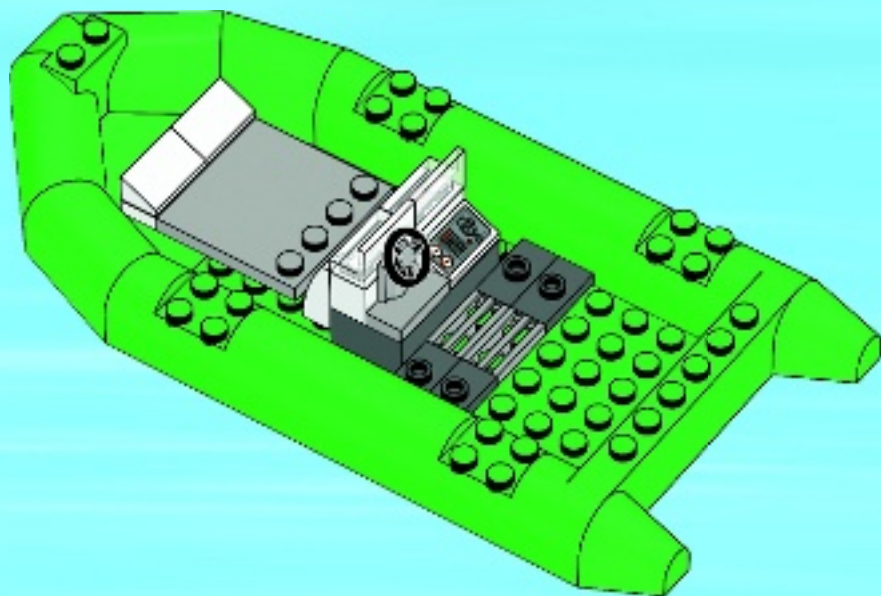



2x

9

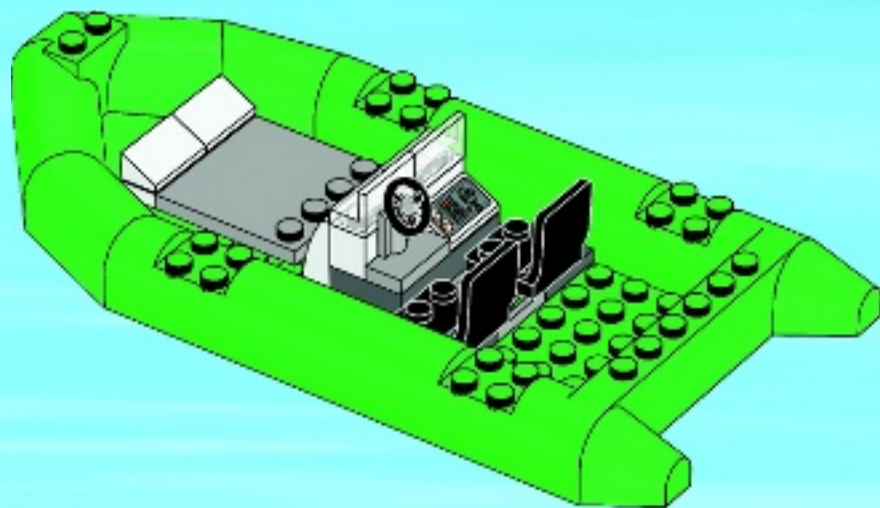



4x

10

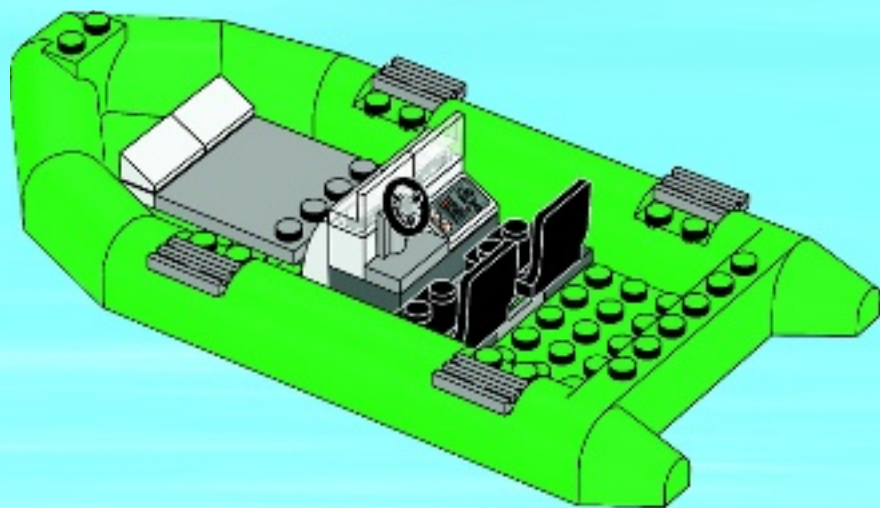

11

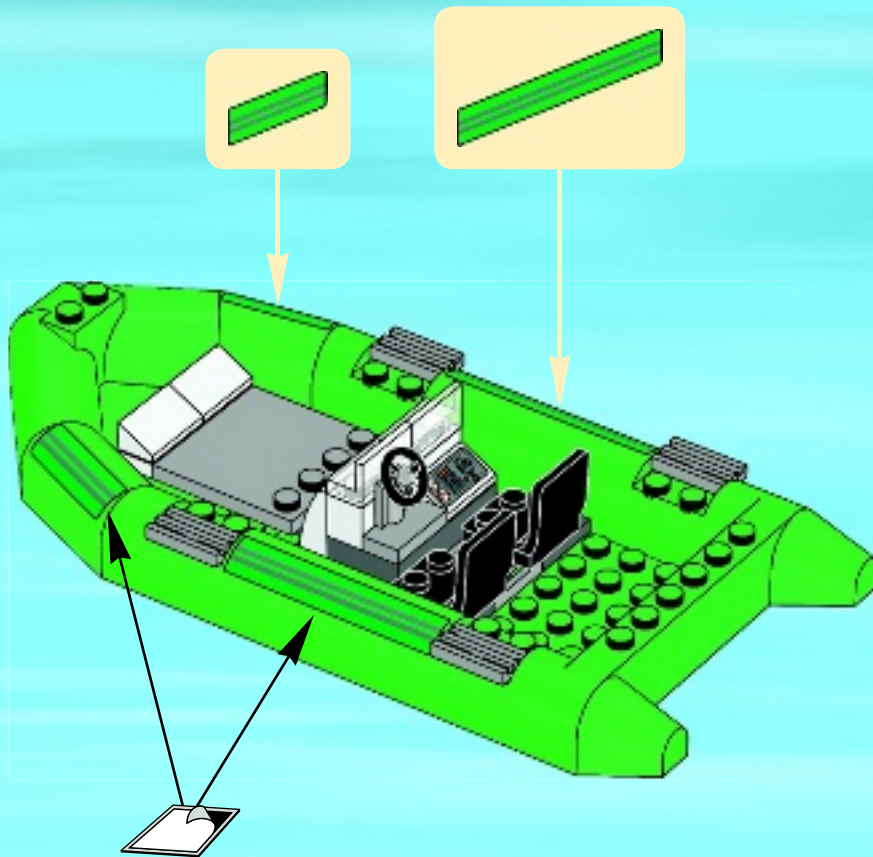



2x



1x



2x

12

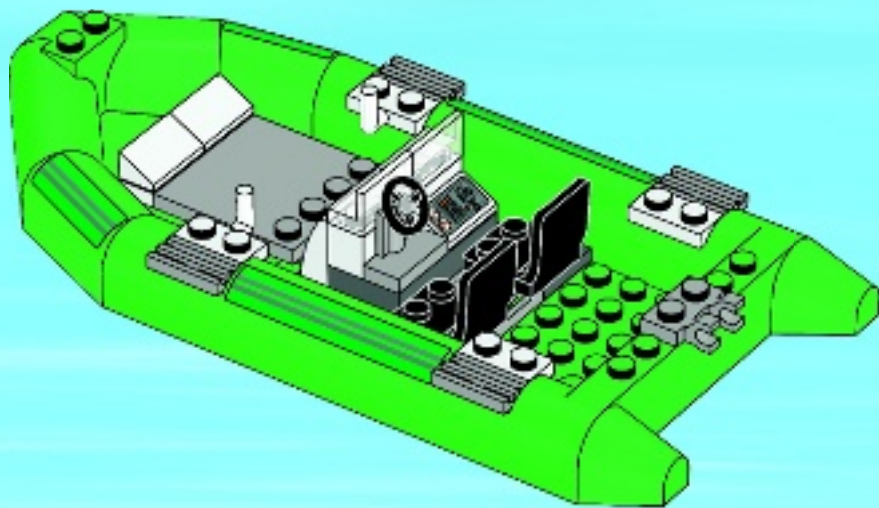



1x

13

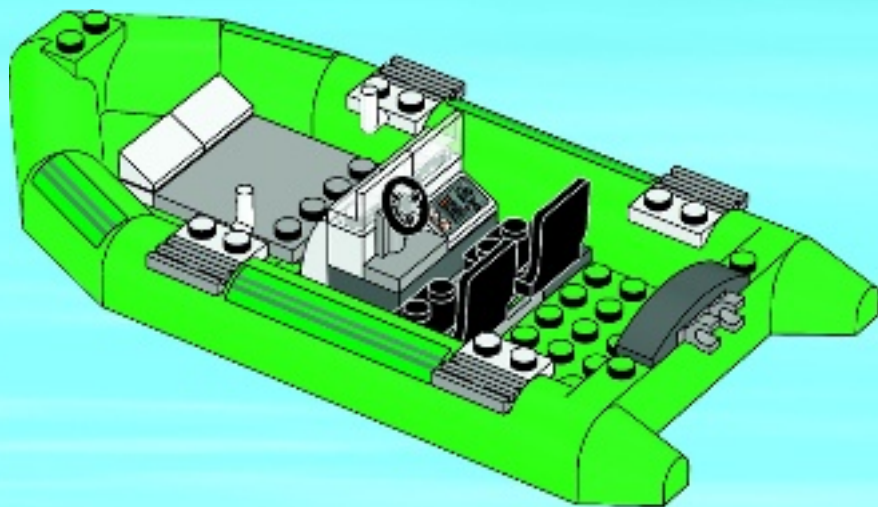

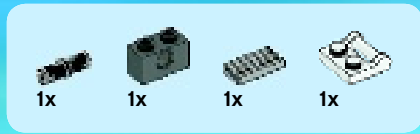

14

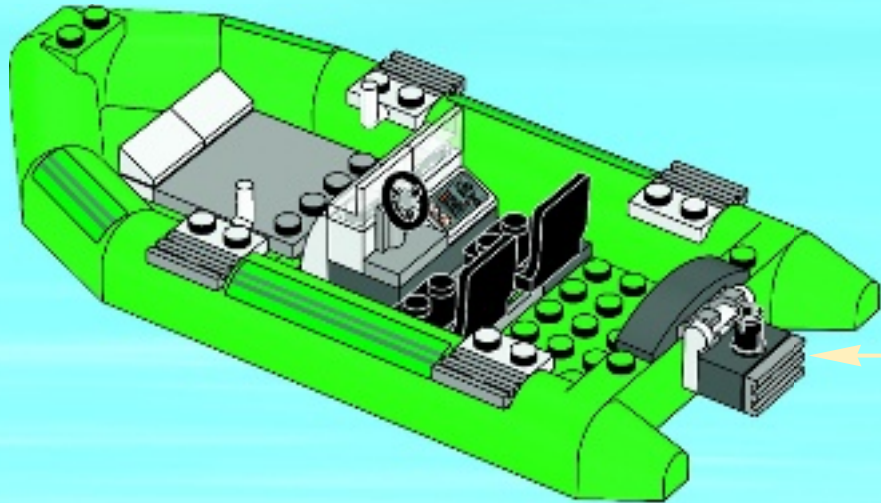
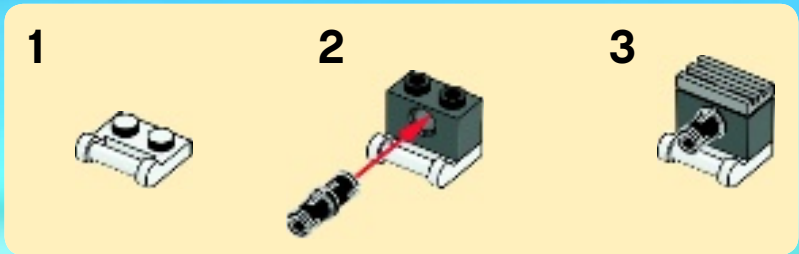



2x



1x



1x



1x



1x



1x



1x

15

1



2



3





4



5



6



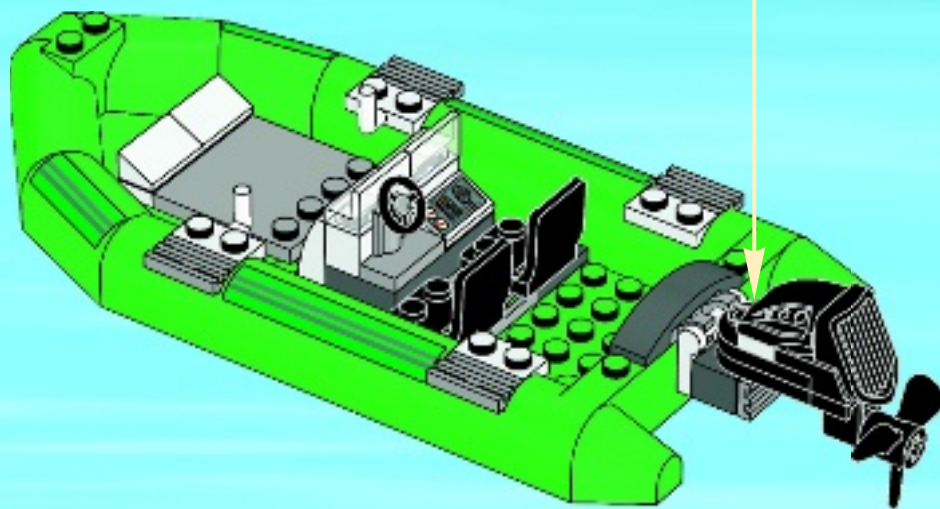



1x

16

1

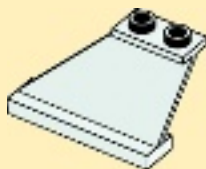

2

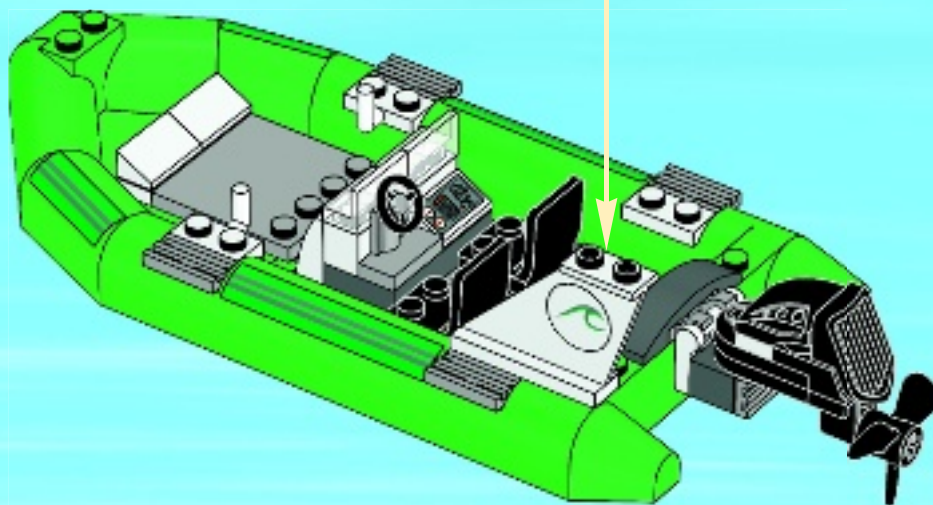
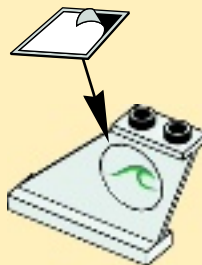

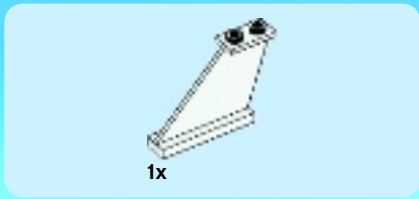

17

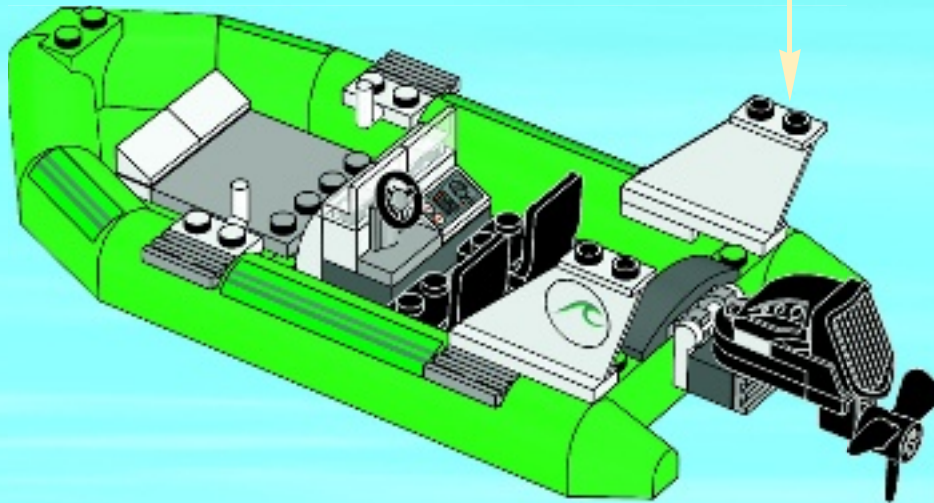
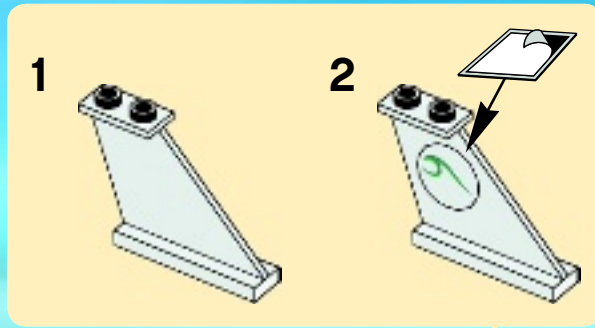

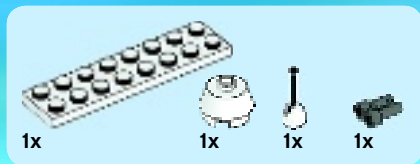

18

1



2



3

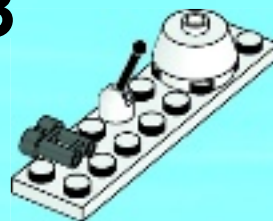

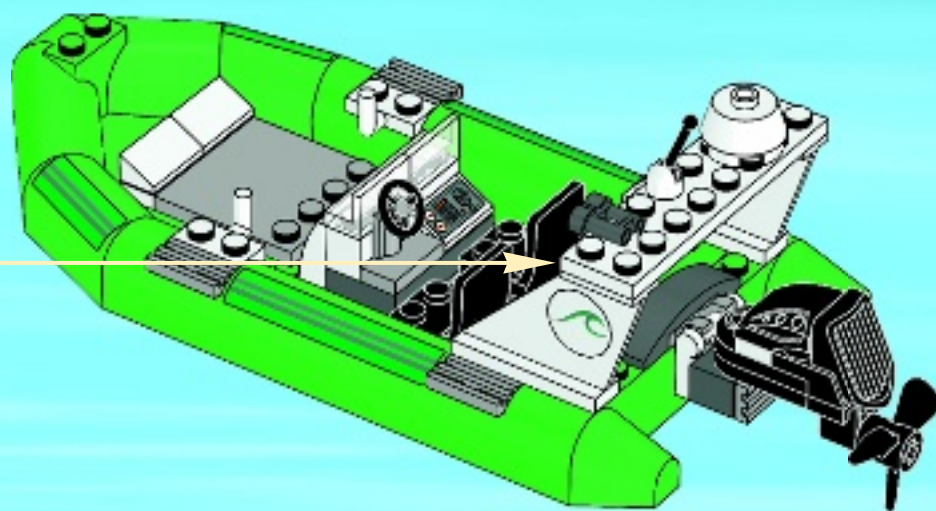

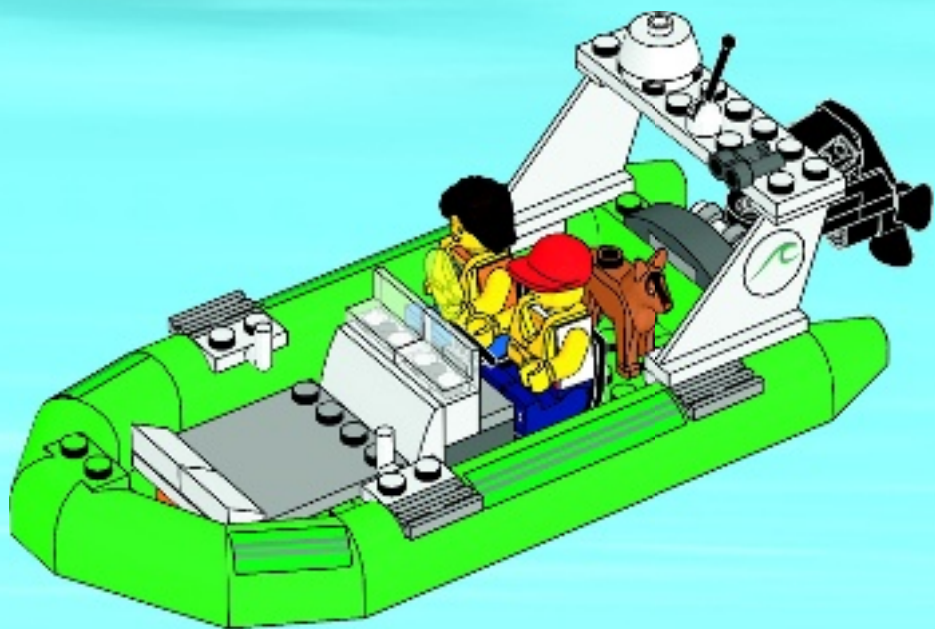

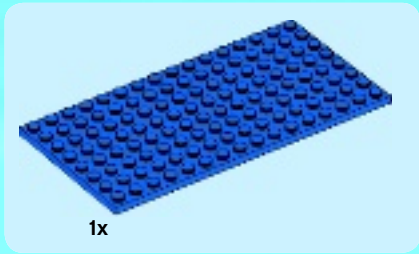

1x

1

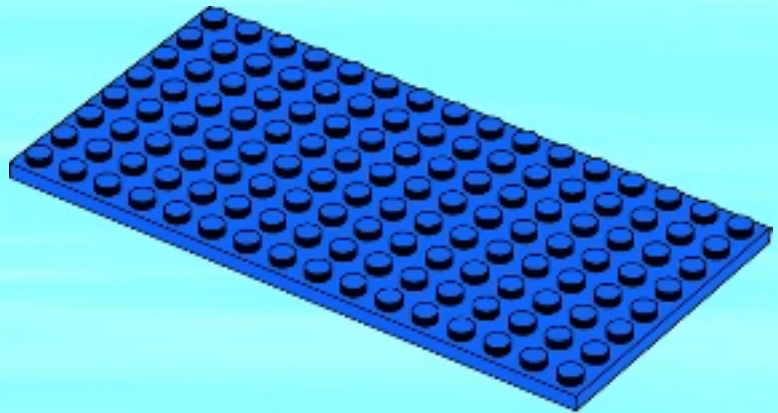



2x

2

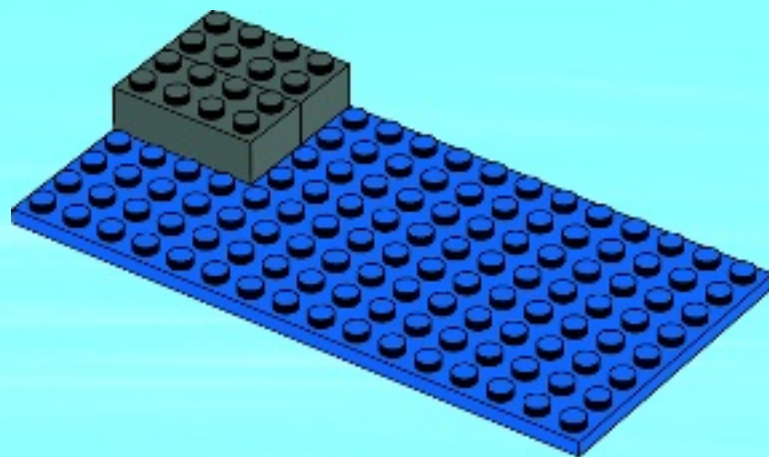



2x

3

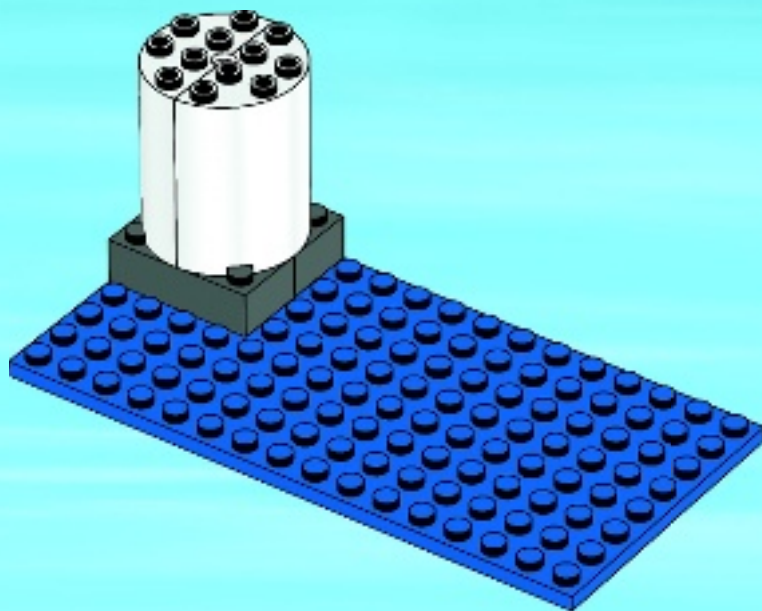



2x

4

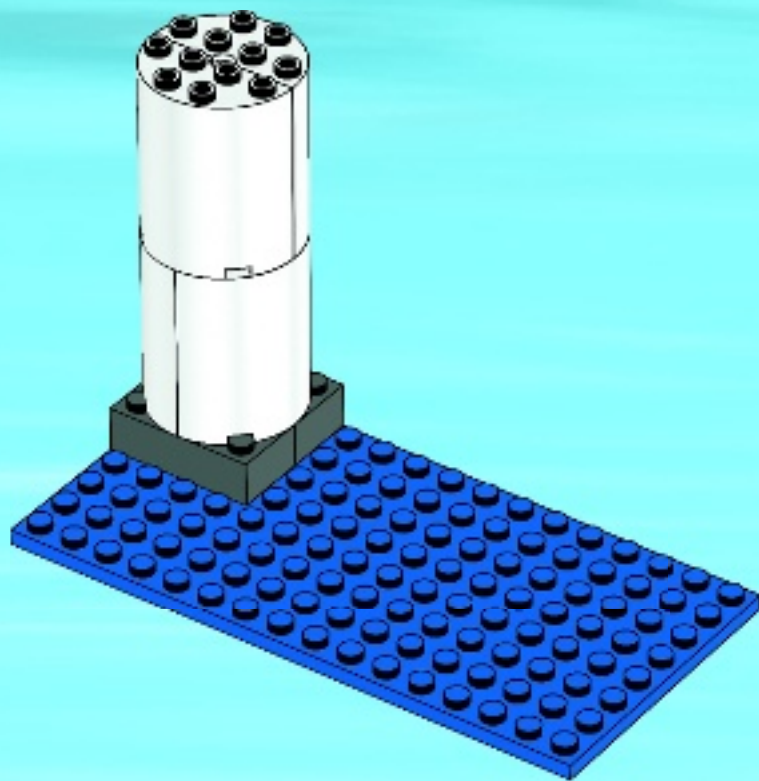



1x



1x

5

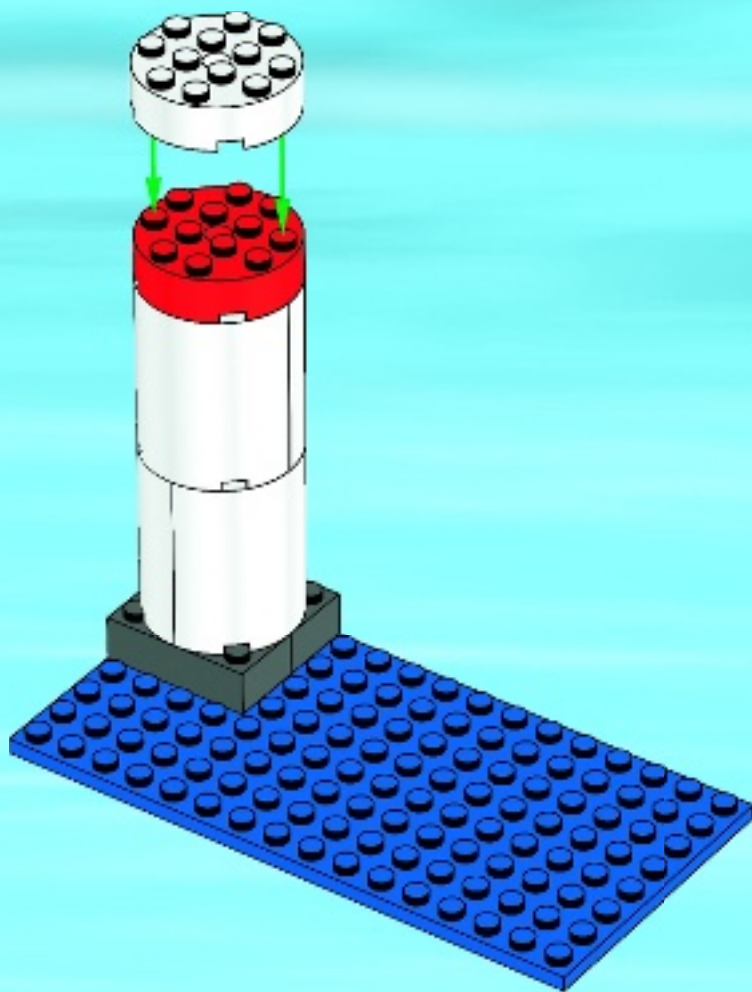



1x



1x

6

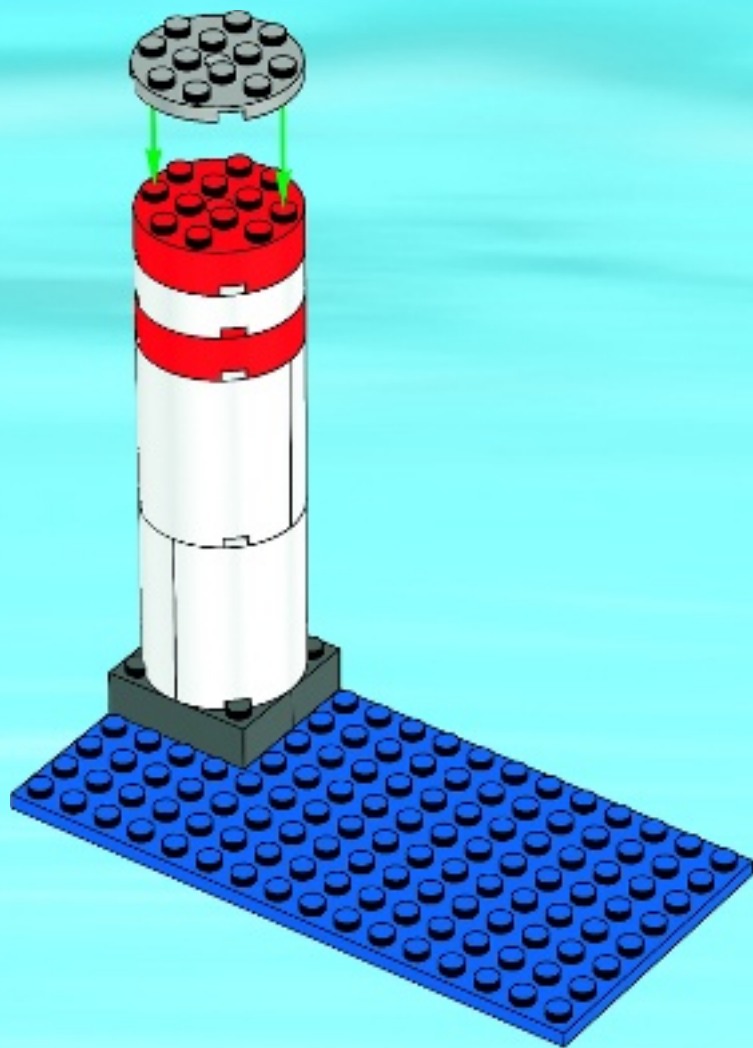



2x

7

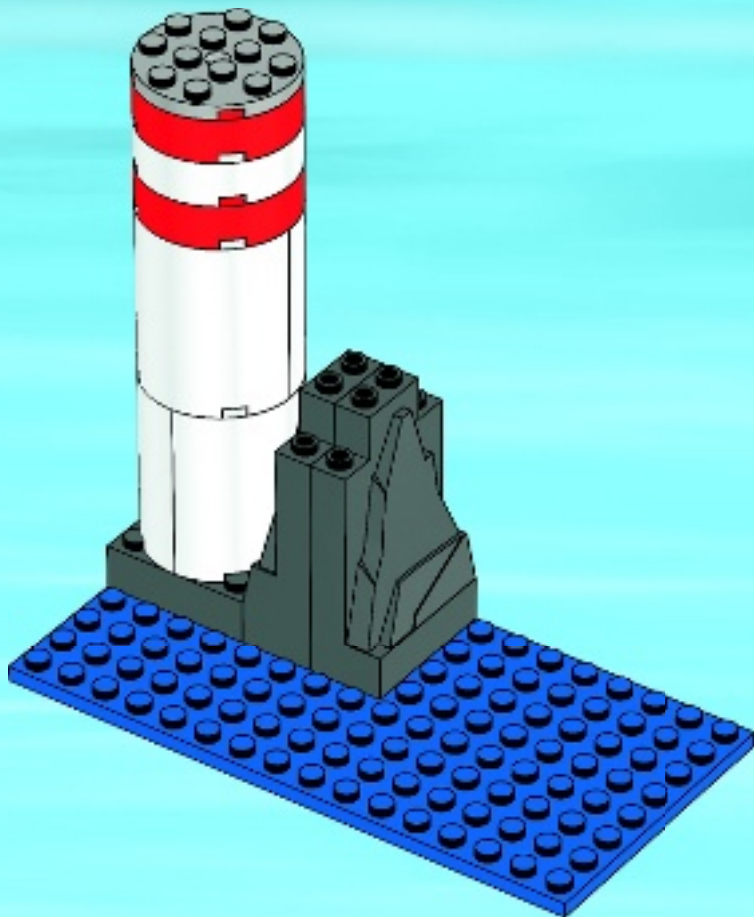



1x



1x

8

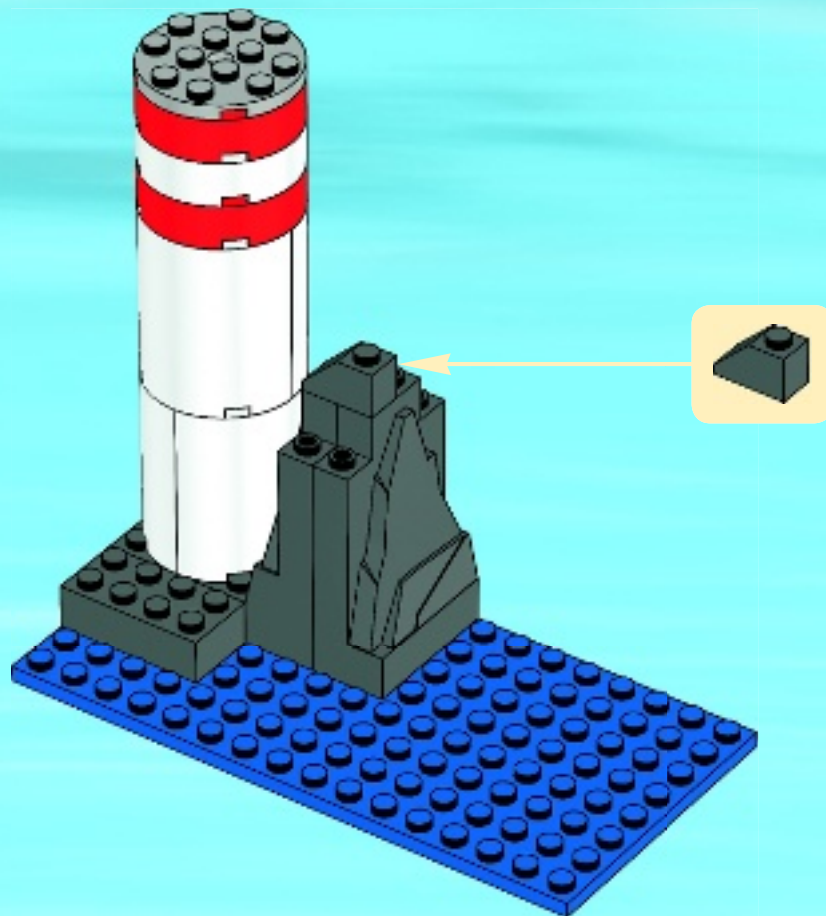



2x



1x

9

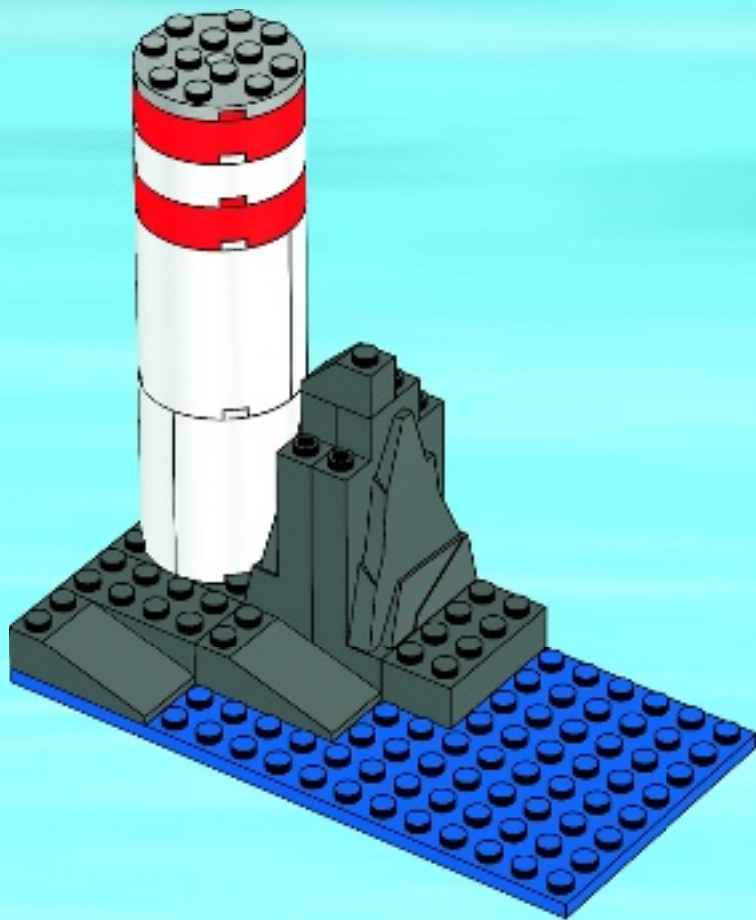



1x



2x

10

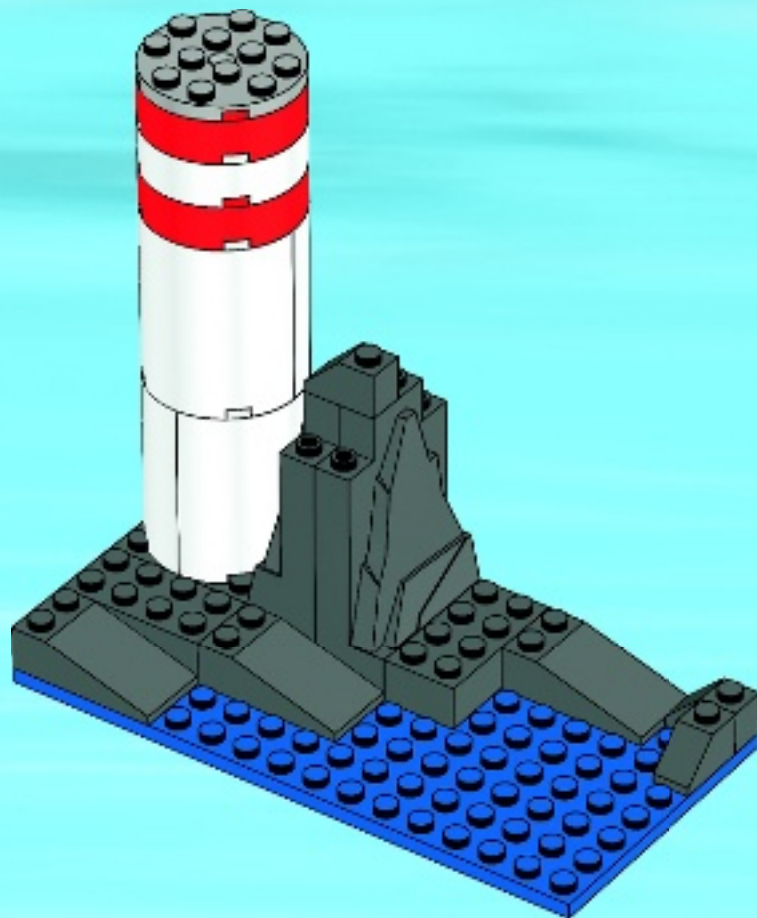



2x



1x

11



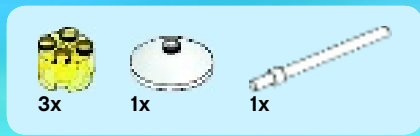

12







CITY



60014



60013



60012



60011

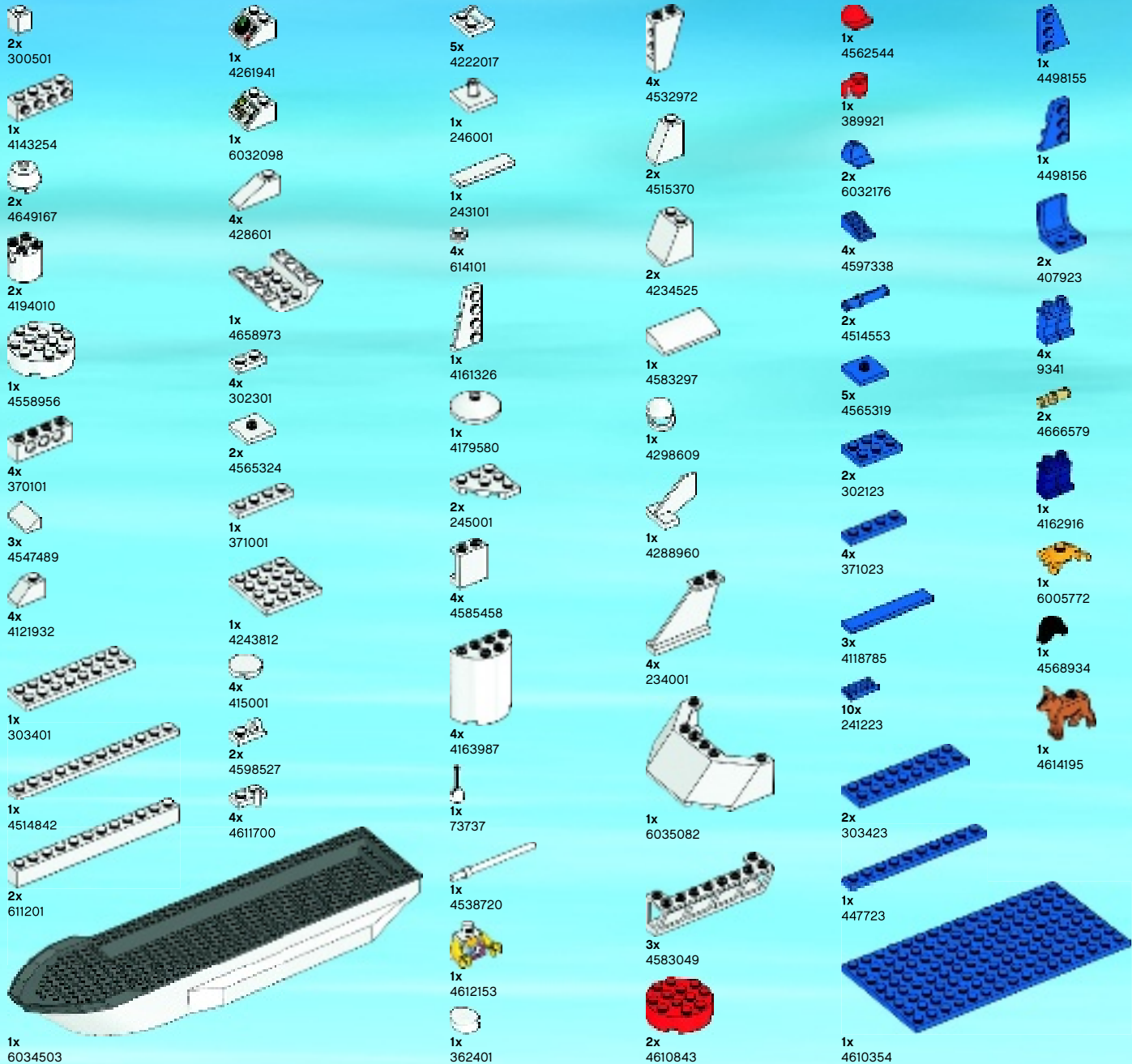



2x
486524



5x
74156



1x
4261572



1x
4651217



1x
4570663



1x
4651443



1x
4651441



1x
4261301



2x
4525464



1x
366624



2x
4611704



1x
306824



4x
4558172



1x
6034492

42



2x
4639064



2x
4527354



2x
4215263



5x
4648281



1x
9553



1x
4612112



2x
4526983



10x
300326



2x
6007896



2x
6021752



1x
6021752



1x
6021752



1x
6021752



1x
4144023



1x
6020193



6x
4535739



2x
317626



1x
383926



2x
6040336



1x
403226



4x
4278359



2x
407926



2x
4647286



1x
395726



1x
396226



1x
4217725



6x
4121715



1x
4121715



1x
4121715



1x
6021604



3x
604126



1x
4289255



2x
4660876



1x
247926



1x
6036006



2x
4507820



2x
4159335



1x
258426



1x
4584350



1x
4584350



1x
4584350



2x
4238840



1x
370526



2x
370726



1x
370726



1x
370726



2x
4153827



12x
4532970



12x
4141089



6x
4118828



1x
4662210



1x
4662204



2x
4251969



3x
4177932



2x
4118782



2x
4118782



2x
4118782



2x
4118782



2x
4118782



1x
4654448



1x
6034497



1x
6034497



1x
6034497



8x
4650690



1x
4214921



1x
6035126



1x
4580475



2x
4538144



3x
6037414



1x
4190164



1x
4190164



1x
4190164



1x
4190164



1x
4190164



1x
4190164



1x
4190164



1x
4190164



1x
4190164



1x
4190164



1x
4190164

- 2x 6019987
- 2x 6012812
- 5x 4211085
- 1x 6005667
- 1x 4244573
- 2x 4603504
- 2x 4211726
- 2x 3005748
- 1x 4211129
- 2x 4539297
- 1x 4211370
- 1x 4568173
- 1x 4211111
- 1x 4211370
- 2x 421758
- 1x 4163306
- 5x 4211135
- 1x 4211370
- 2x 421758
- 1x 6019162
- 3x 4210637
- 3x 4210967
- 1x 4211837
- 1x 609015
- 1x 4648256
- 2x 4500517
- 1x 4211807
- 4x 4211815
- 4x 4211815
- 4x 4211815
- 1x 4211511
- 3x 4583051
- 1x 4521886
- 2x 4211079
- 1x 4211511
- 3x 611644
- 1x 4211079
- 2x 4556157
- 1x 4194535
- 1x 4194535
- 2x 4211051
- 2x 4558169
- 1x 4194535
- 6x 3005740
- 2x 4211051
- 2x 4558169
- 2x 4113106
- 1x 4194535
- 3x 4562882
- 1x 4211079
- 2x 3005740
- 1x 4194535
- 3x 4210781
- 1x 4211079
- 2x 3005740
- 1x 4194535
- 1x 4210726
- 2x 4562882
- 4x 4211524
- 1x 3005741
- 1x 4194535
- 1x 4210706
- 3x 4562882
- 4x 4211524
- 1x 3005741
- 1x 4194535
- 1x 4210706
- 3x 4210781
- 1x 4211524
- 1x 3005741
- 1x 4194535
- 1x 4256149
- 4x 4600437
- 1x 4226995
- 1x 4194535
- 1x 4194535

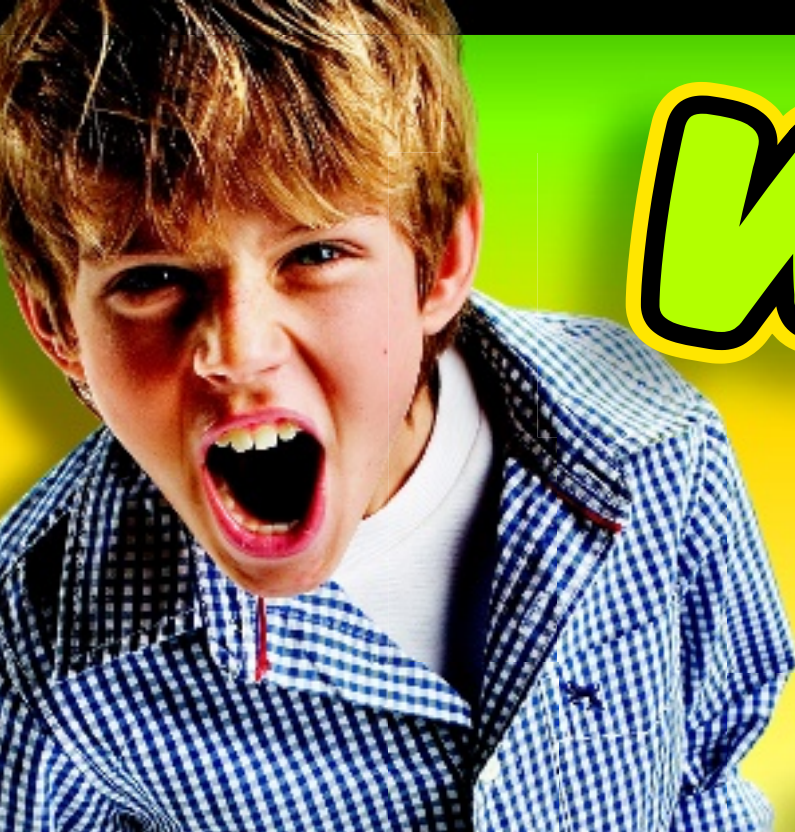

WIN!

Go to www.LEGOsurvey.com/product
to fill out a survey for a chance
to win a cool LEGO® Product.

No purchase necessary.

Open to all residents where not prohibited.



LEGO.com



www.LEGOsurvey.com/product

GEWINNE! WIN!

Nimm an der Umfrage auf
www.LEGOsurvey.com/product
teil und hab die Chance ein cooles
LEGO® Produkt zu gewinnen!

Die Teilnahme am Gewinnspiel führt zu keinerlei
Kaufverpflichtungen. Teilnahme in allen nicht
ausgeschlossenen Ländern möglich.

Ga naar www.LEGOsurvey.com/product,
vul een
enquêteformulier in en maak
kans op een cool LEGO® product.

Geen aankoopverplichting.
Iedereen mag deelnemen, uitgezonderd
ingezetenden van landen waar een
enquêteverbod geldt.

GAGNE! 当てよう!

Visite www.LEGOsurvey.com/product
pour répondre à un
questionnaire et avoir une chance de
gagner un produit LEGO® très cool!

Aucune obligation d'achat.
Ouvert à tous les résidents des pays
autorisés.

www.LEGOsurvey.com/product にアクセスして、
アンケートにご記入ください。当選者にはレゴ
製品を差し上げます。

お買い上げの必要はありません

禁止されていない限り、すべての皆様にご利用いただけます。



CITY

60014







+

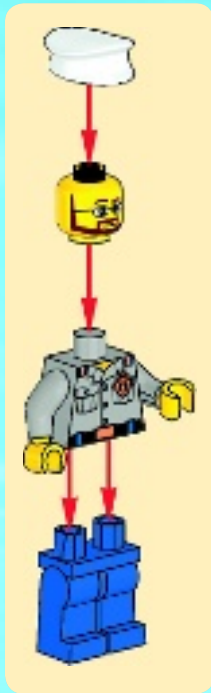
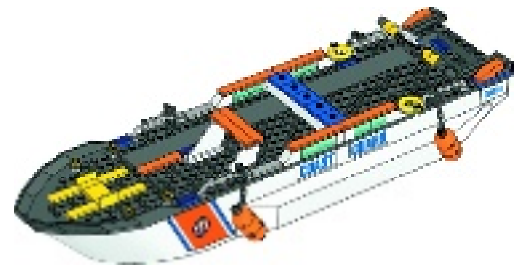

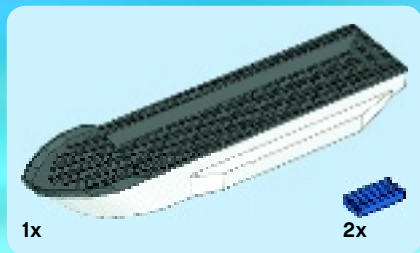

1

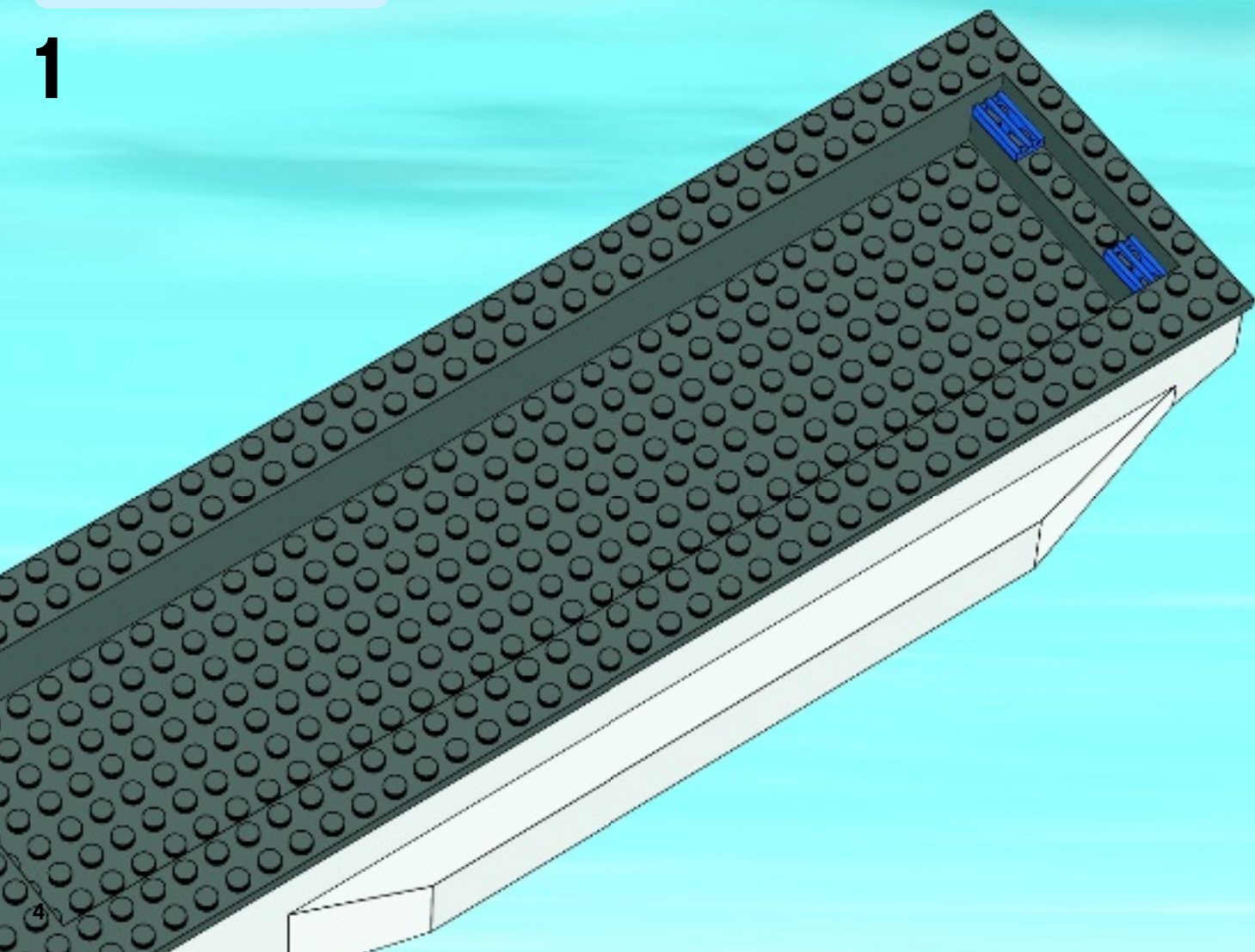



2x

2

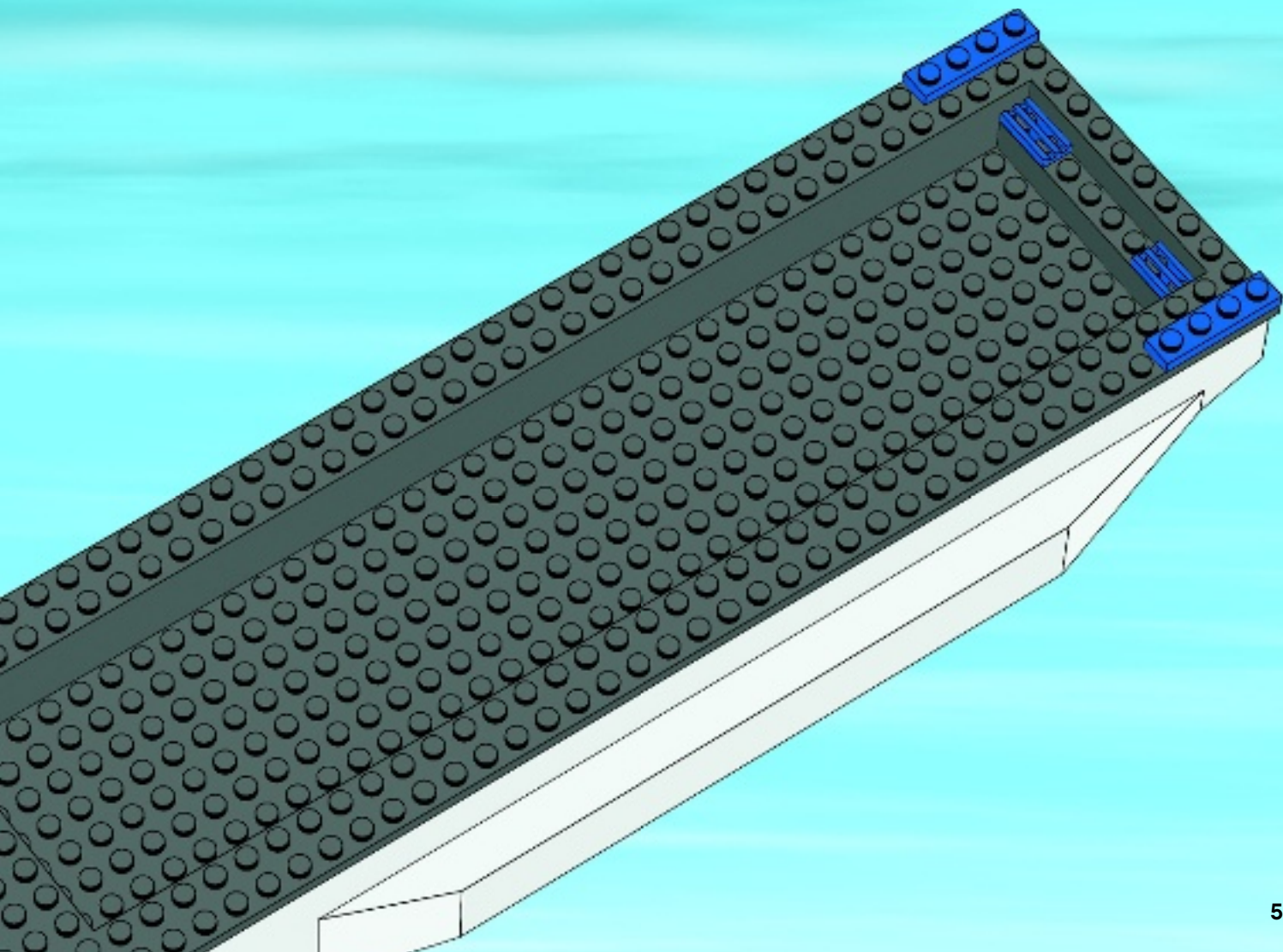



2x

3

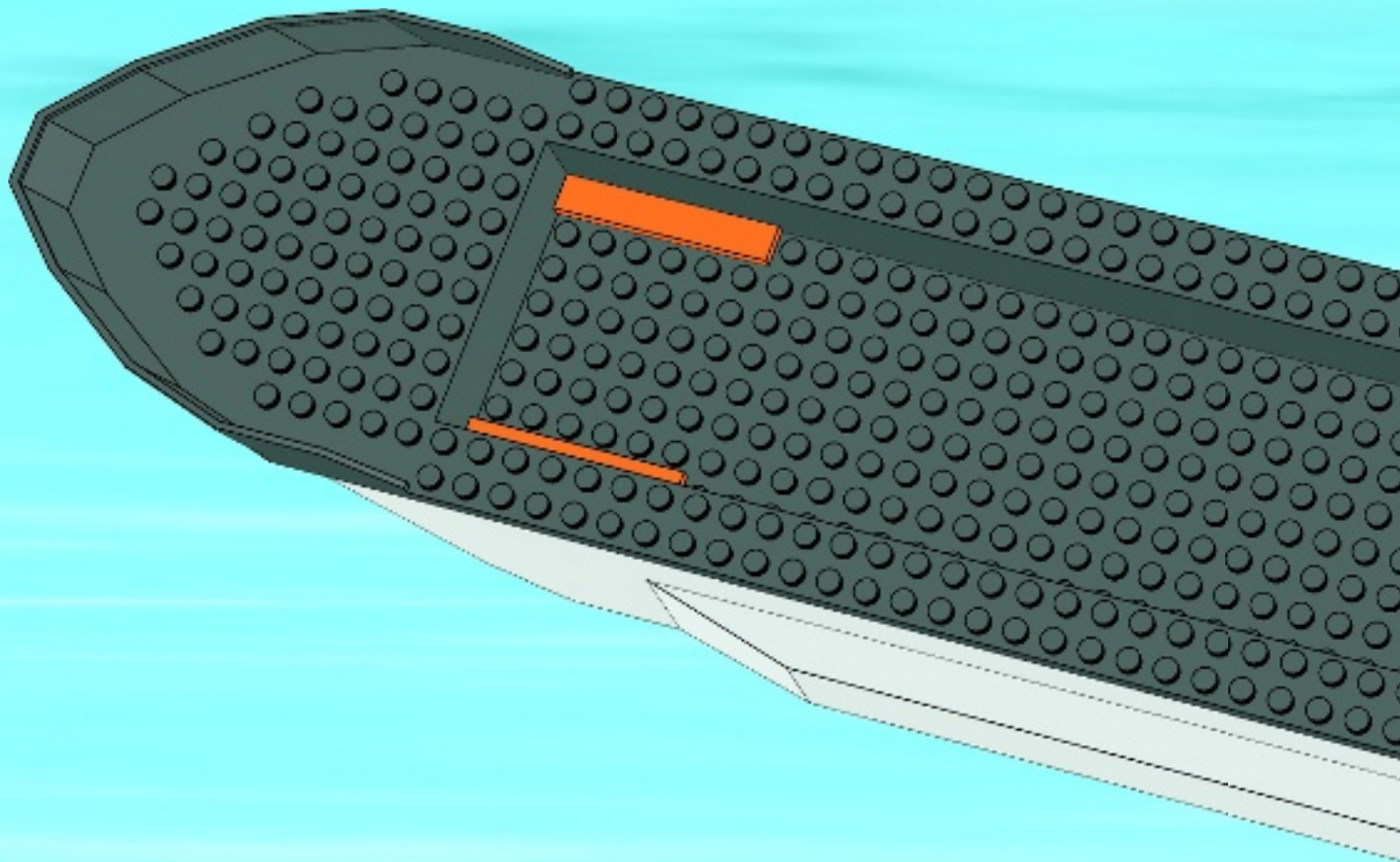



2x

4

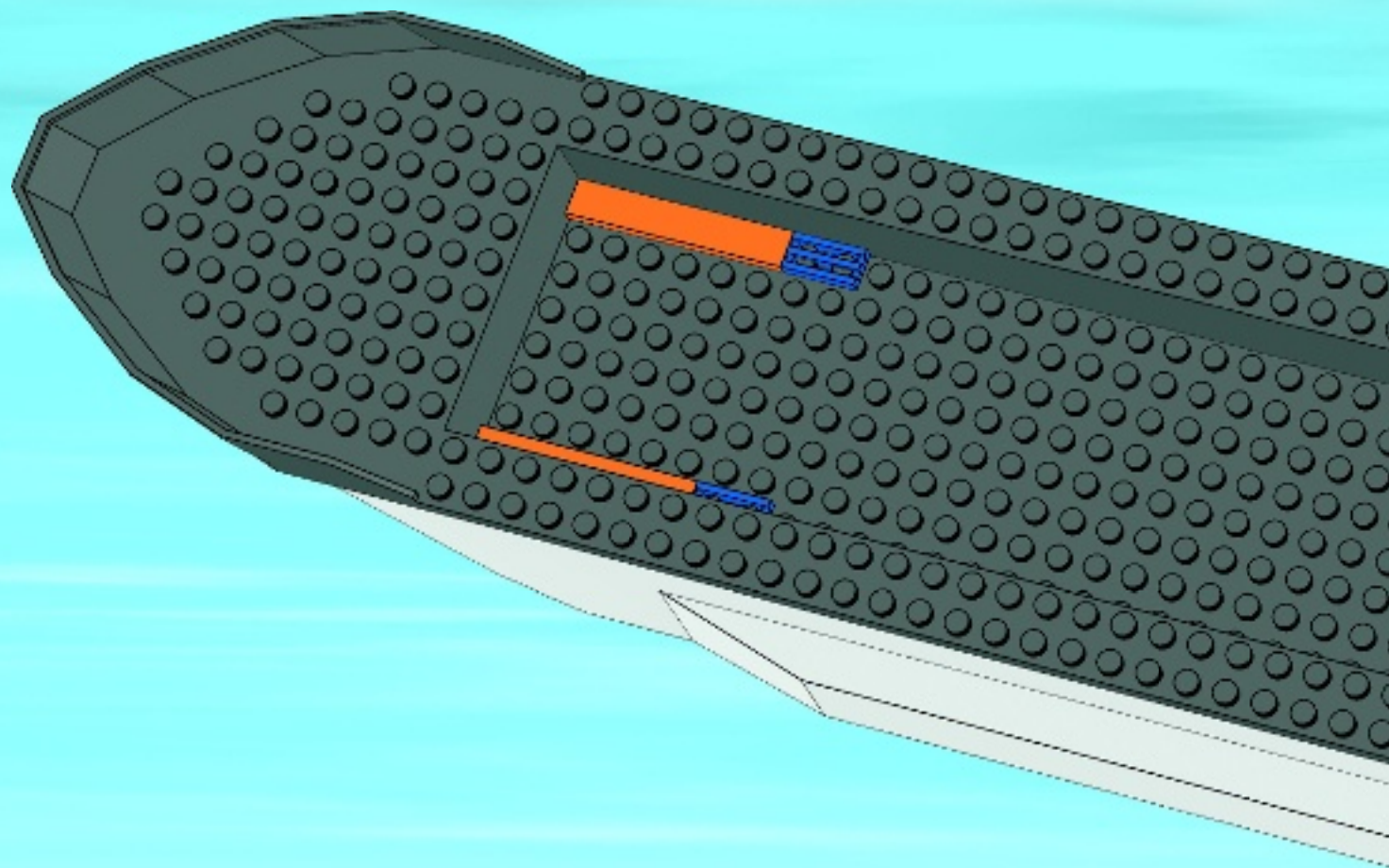

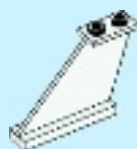

2x

5

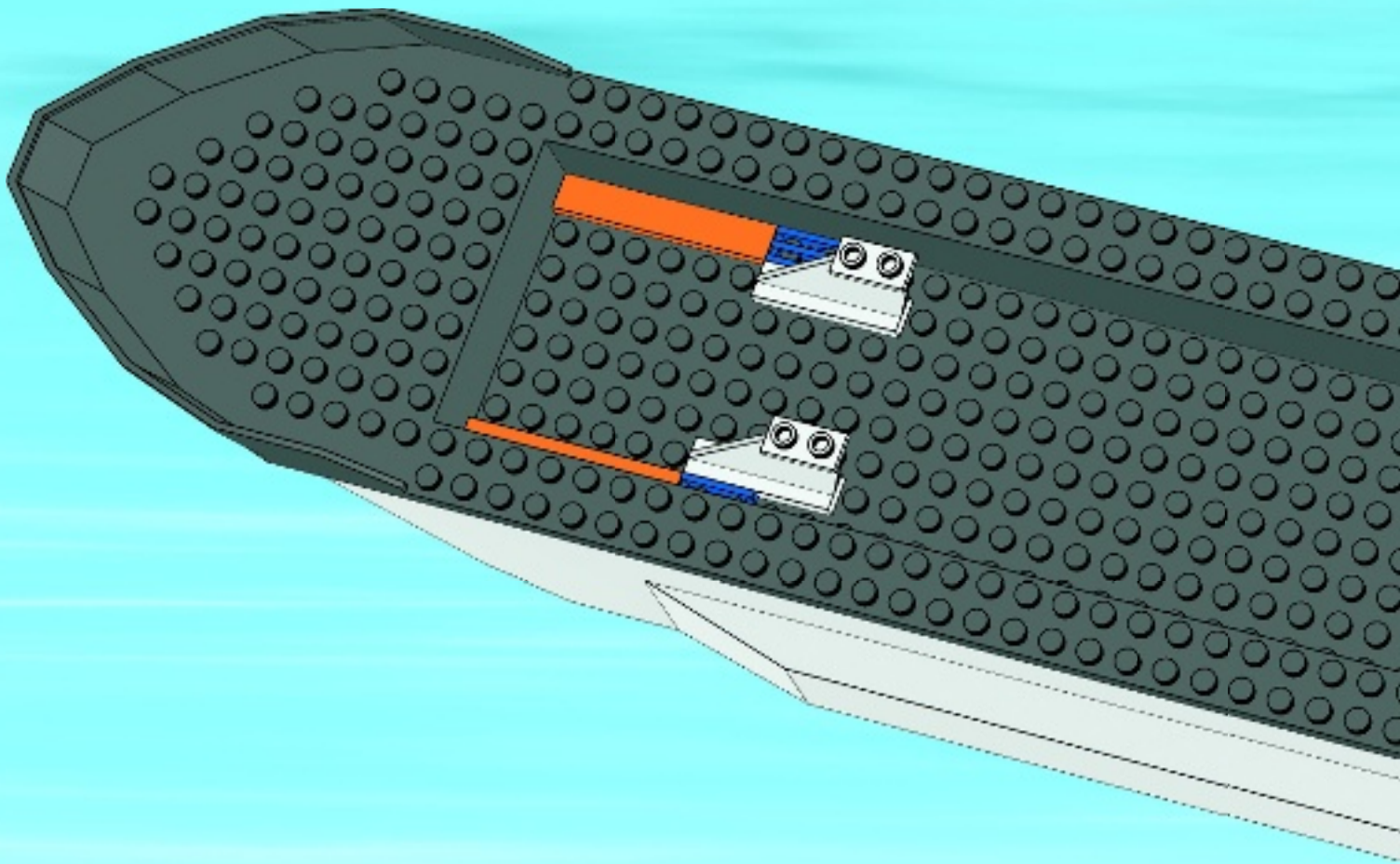



2x

6

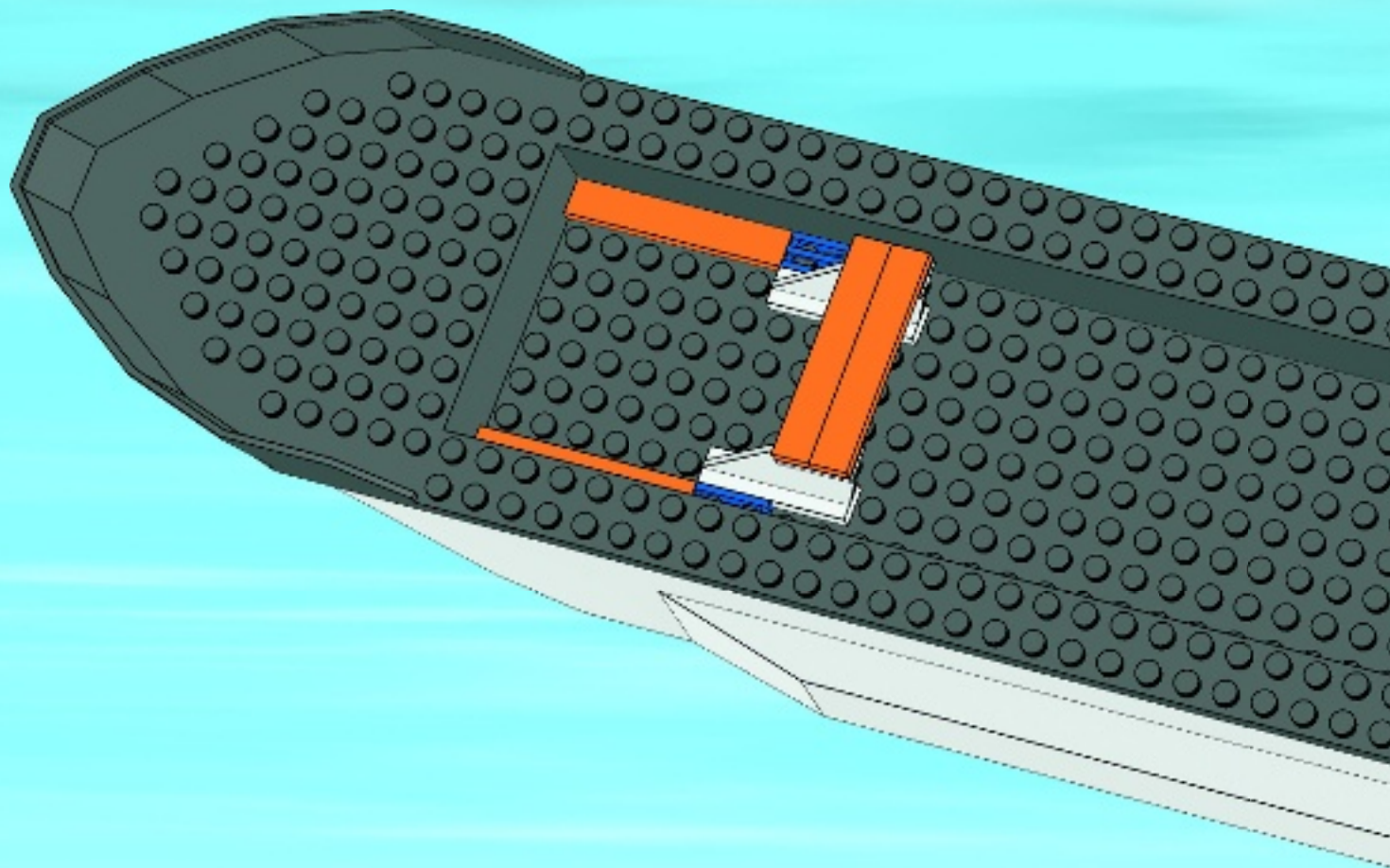



2x



2x

7

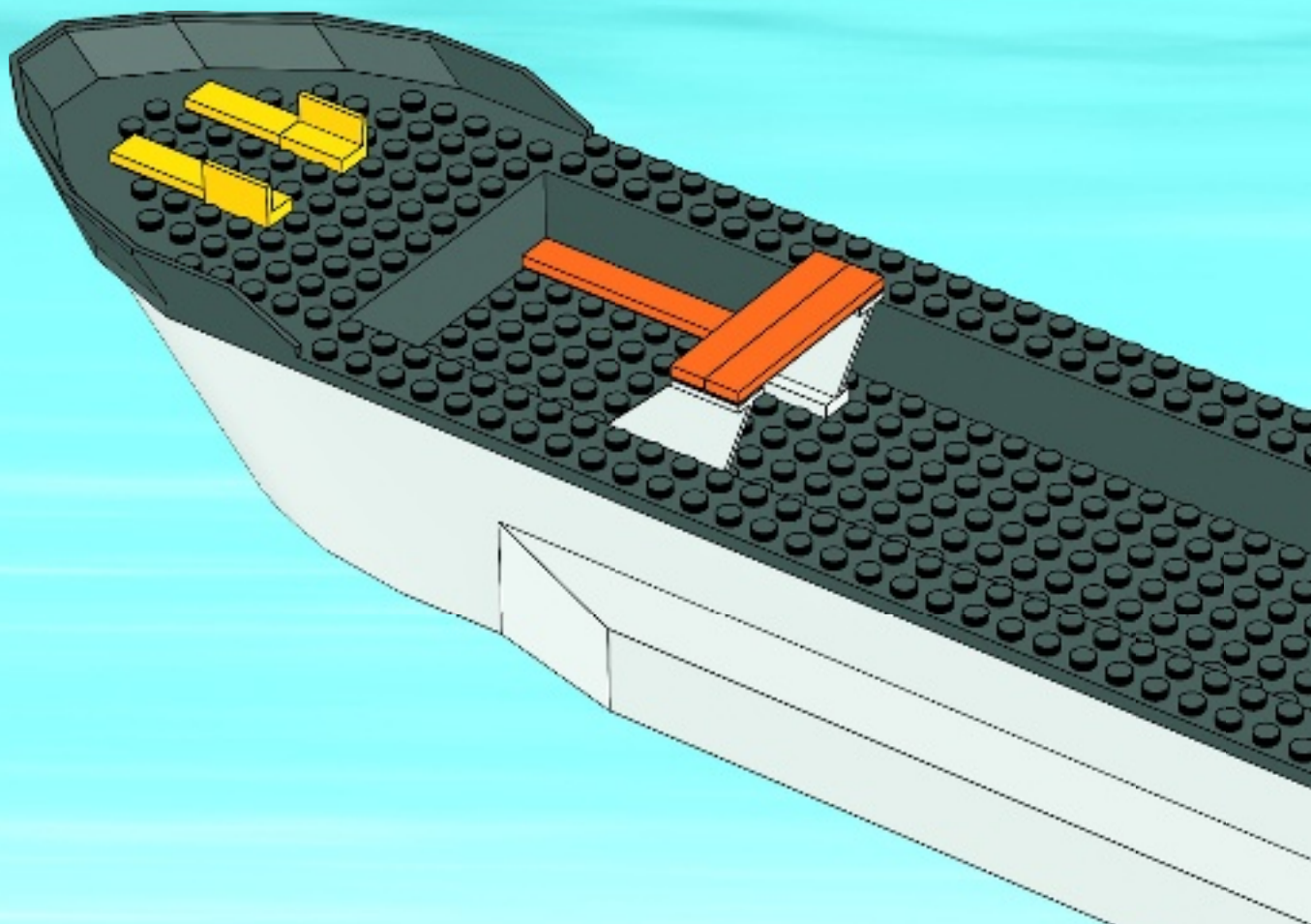



1x



2x

8

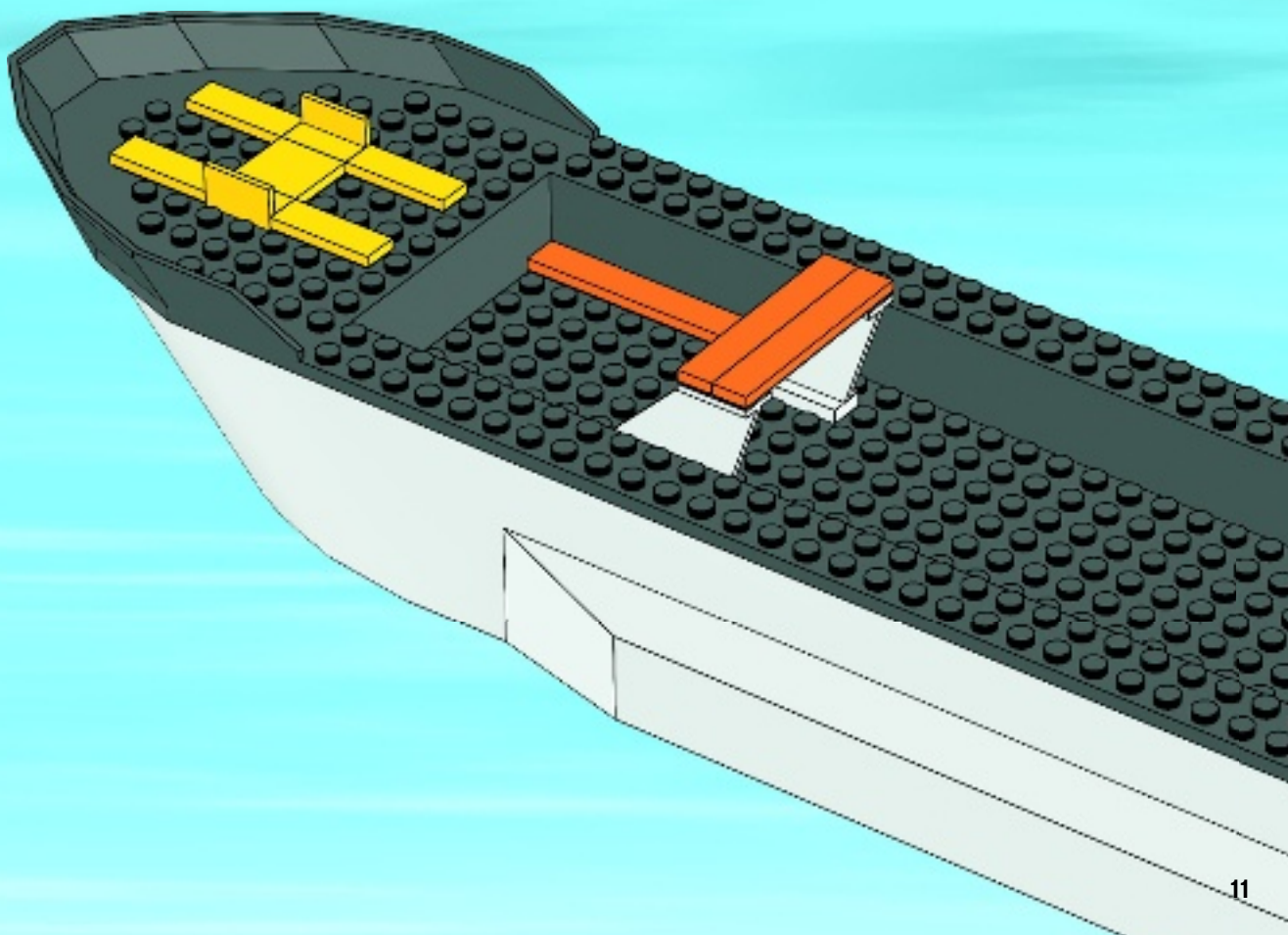



4x



4x

9



4x

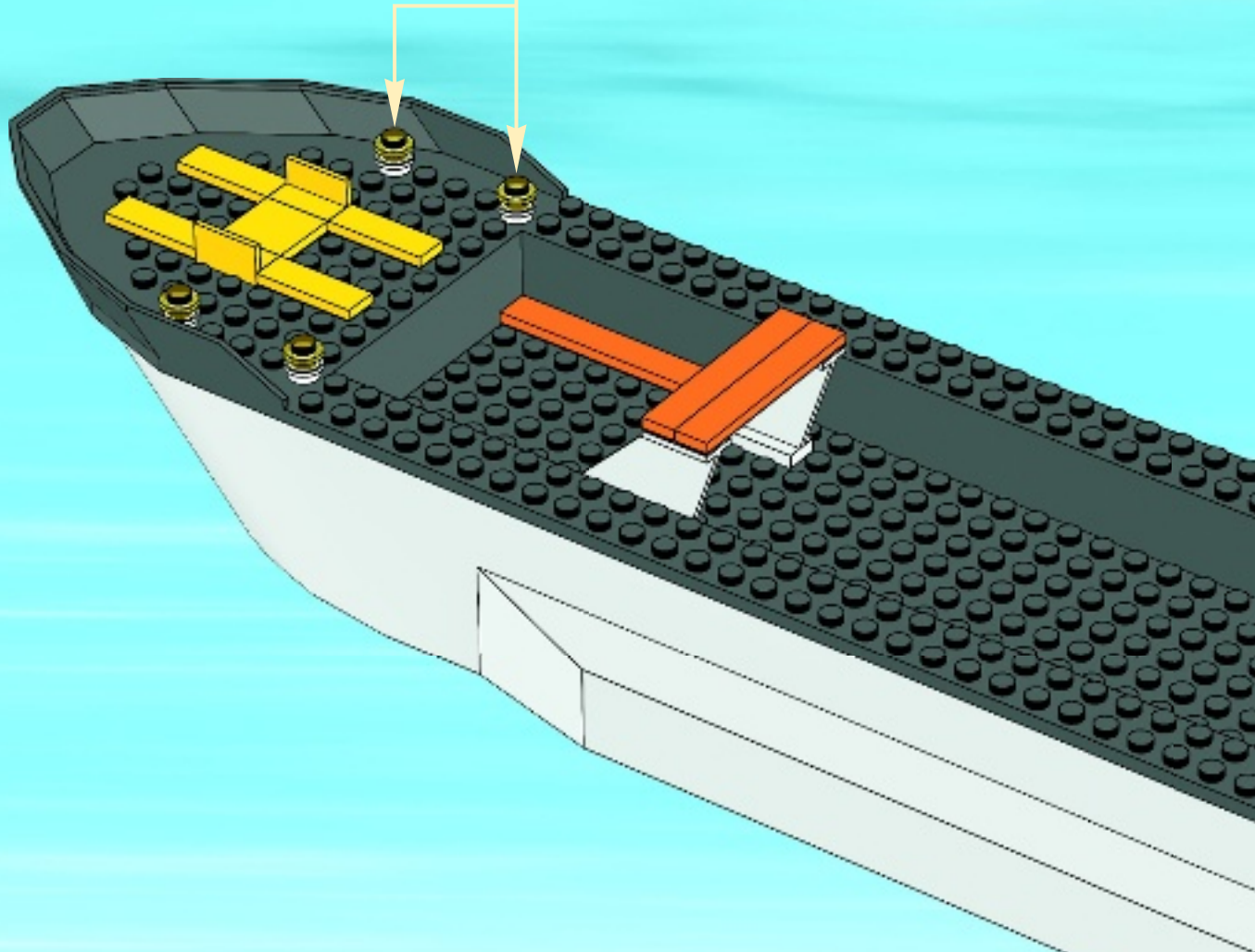



2x

10

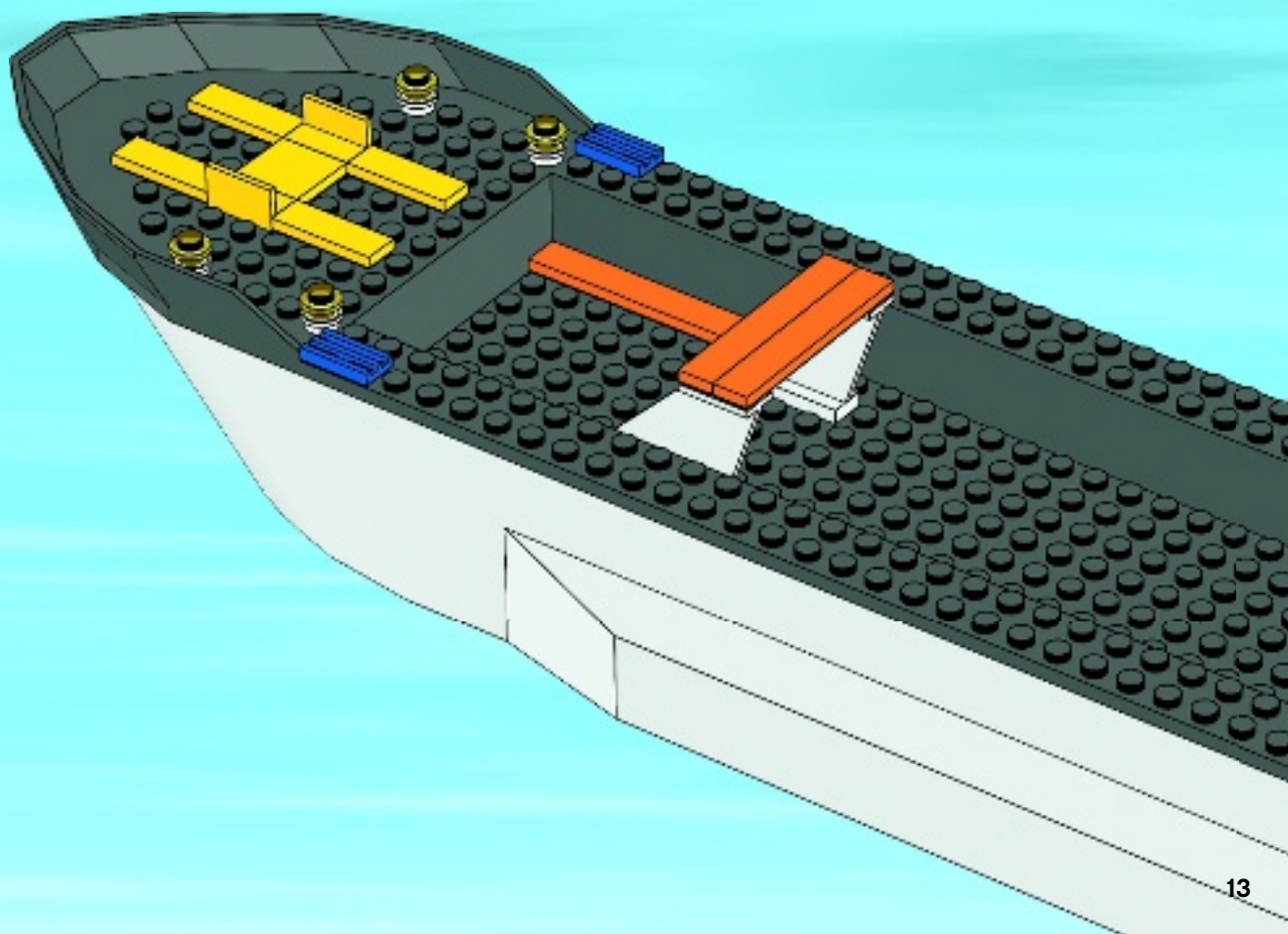



2x



2x

11

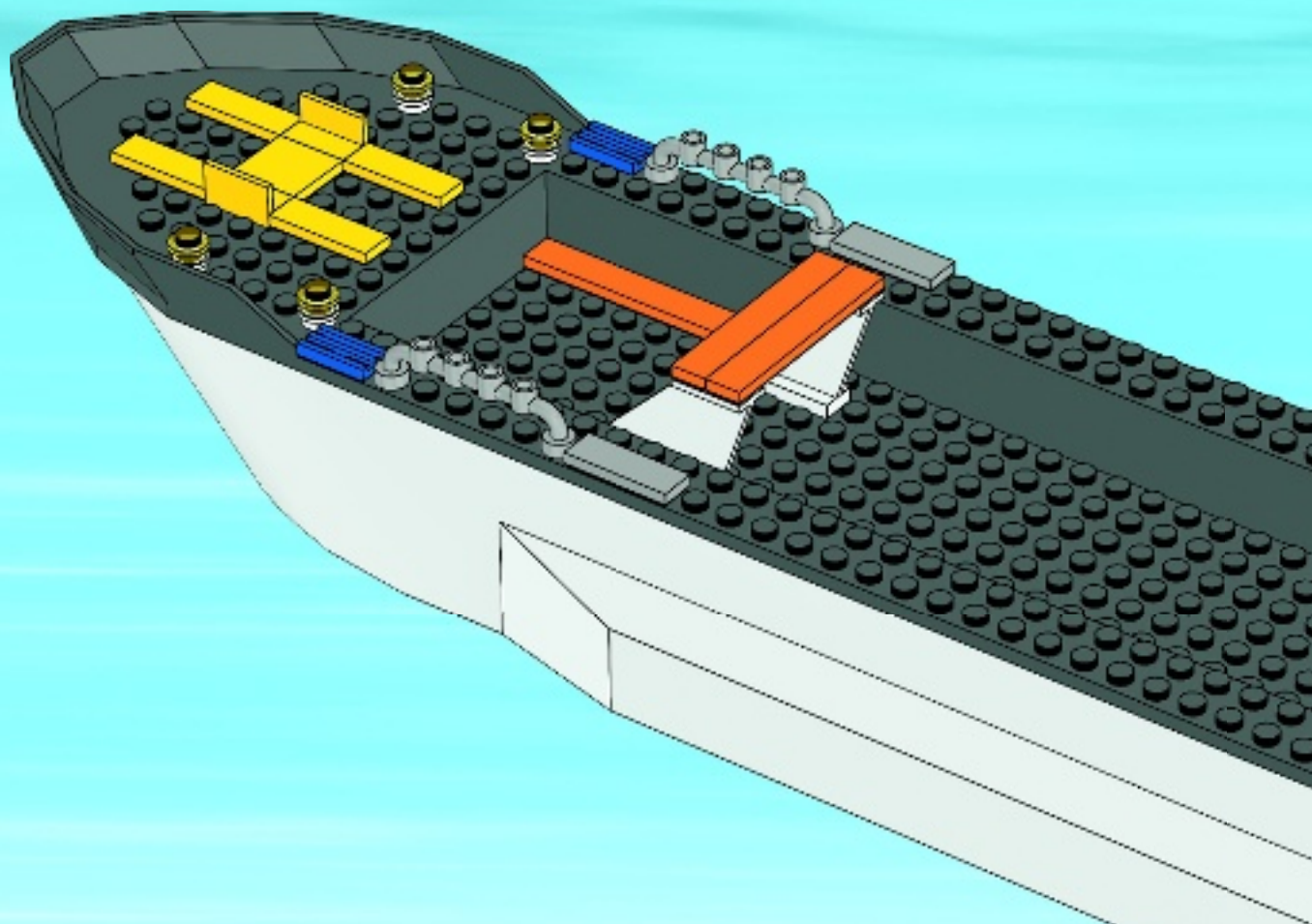



2x



4x

12

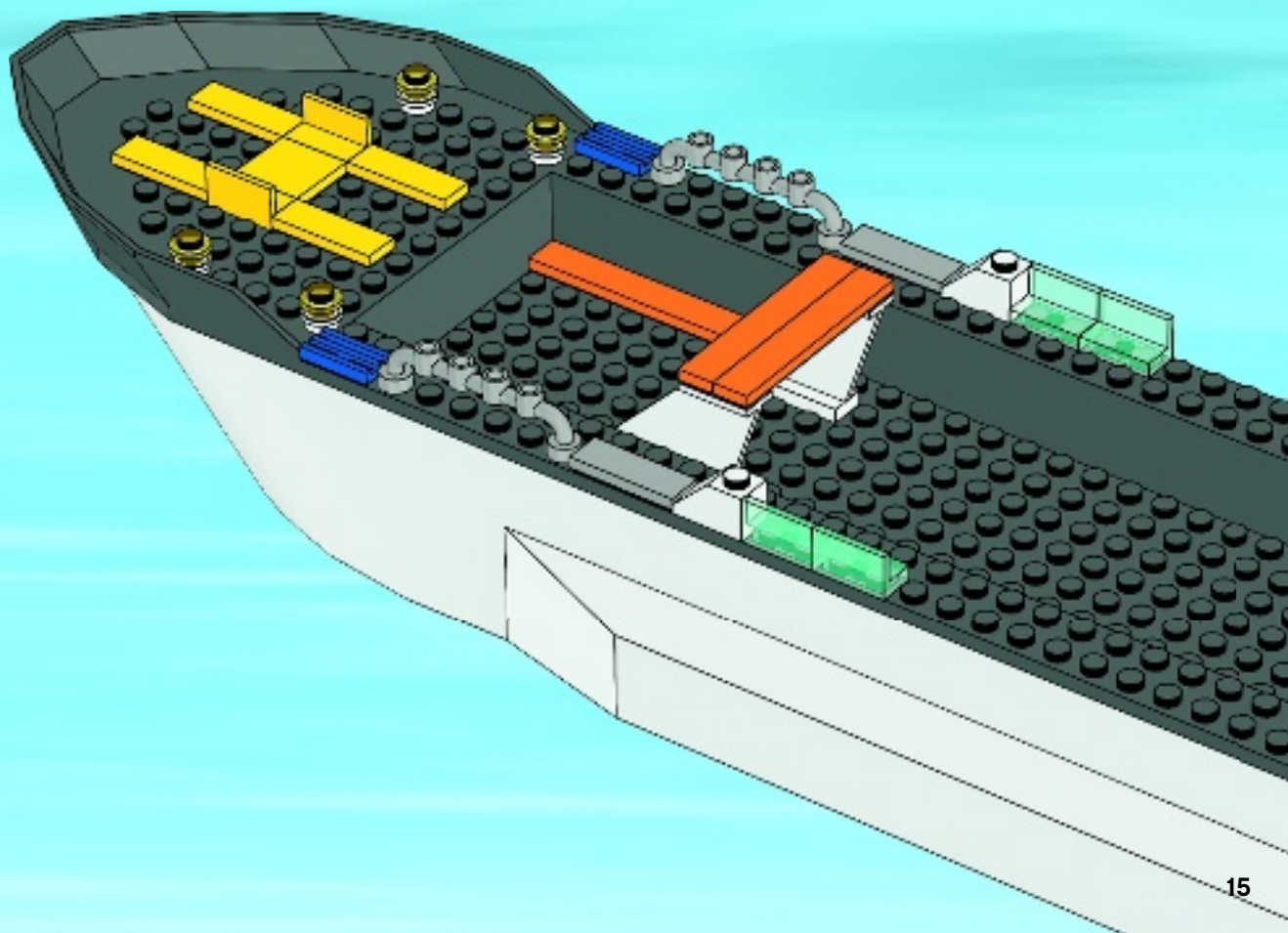

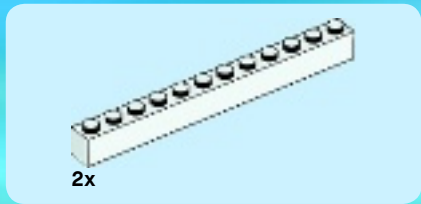

13

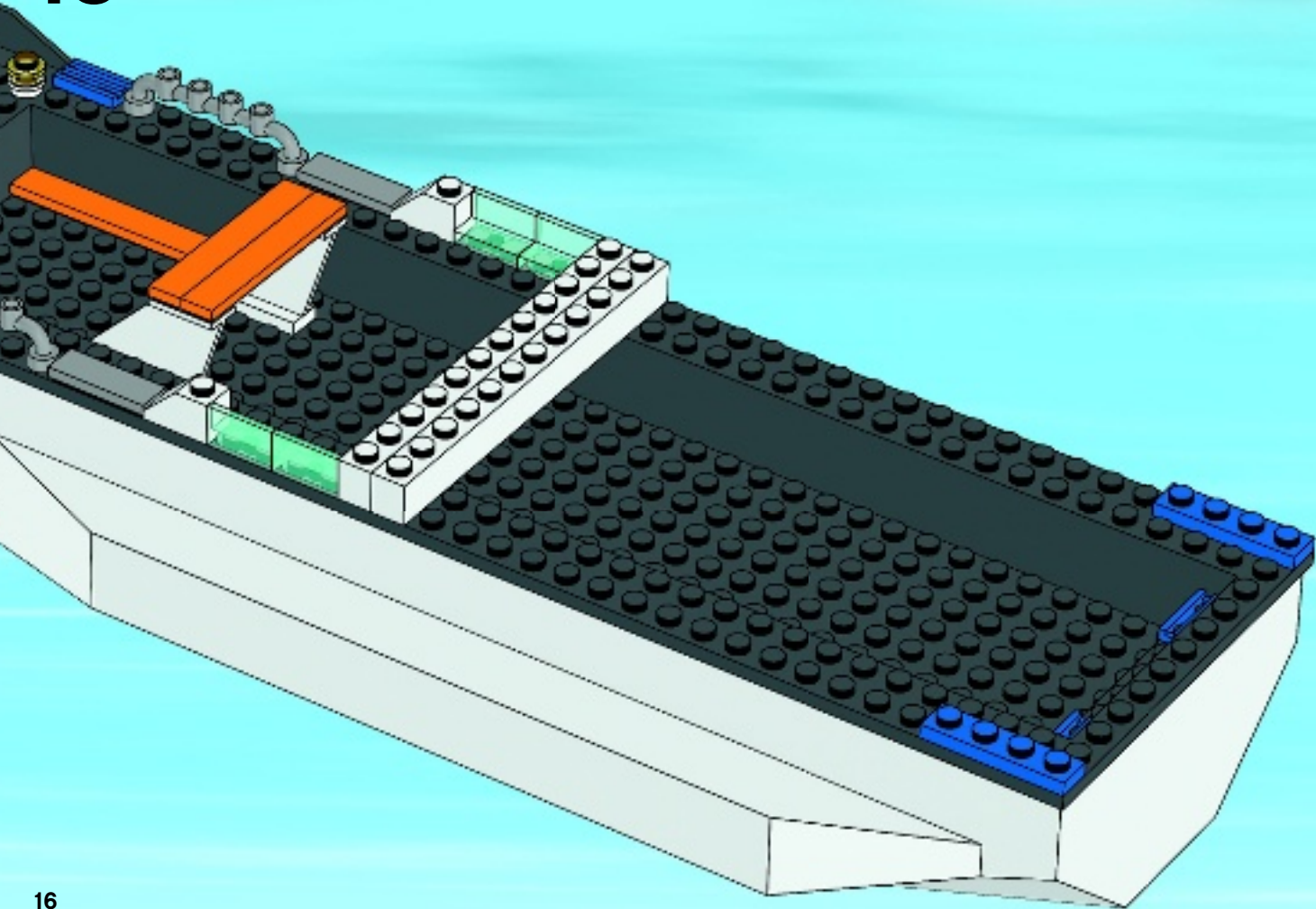



2x



4x

14

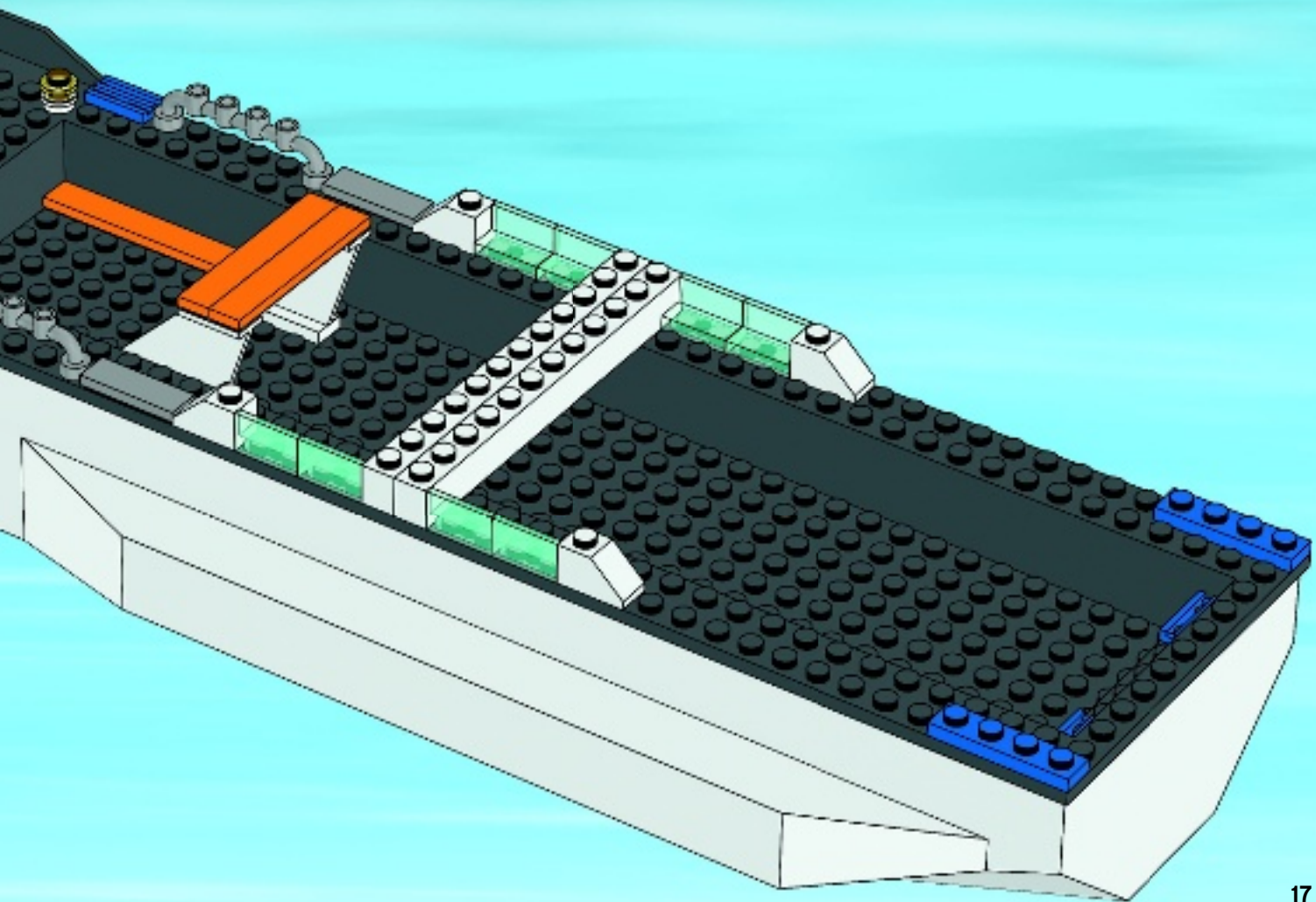



4x

15

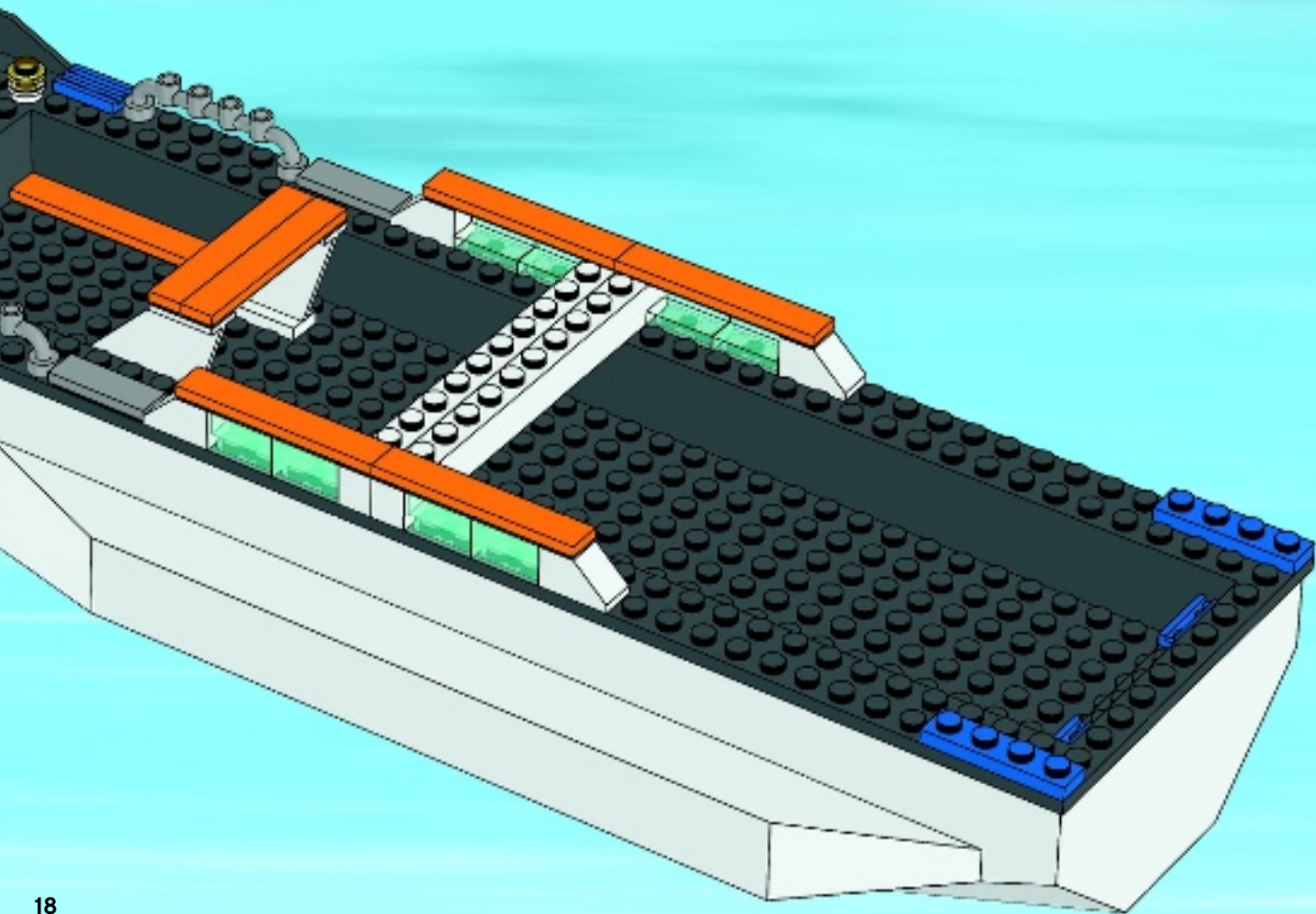



5x

16

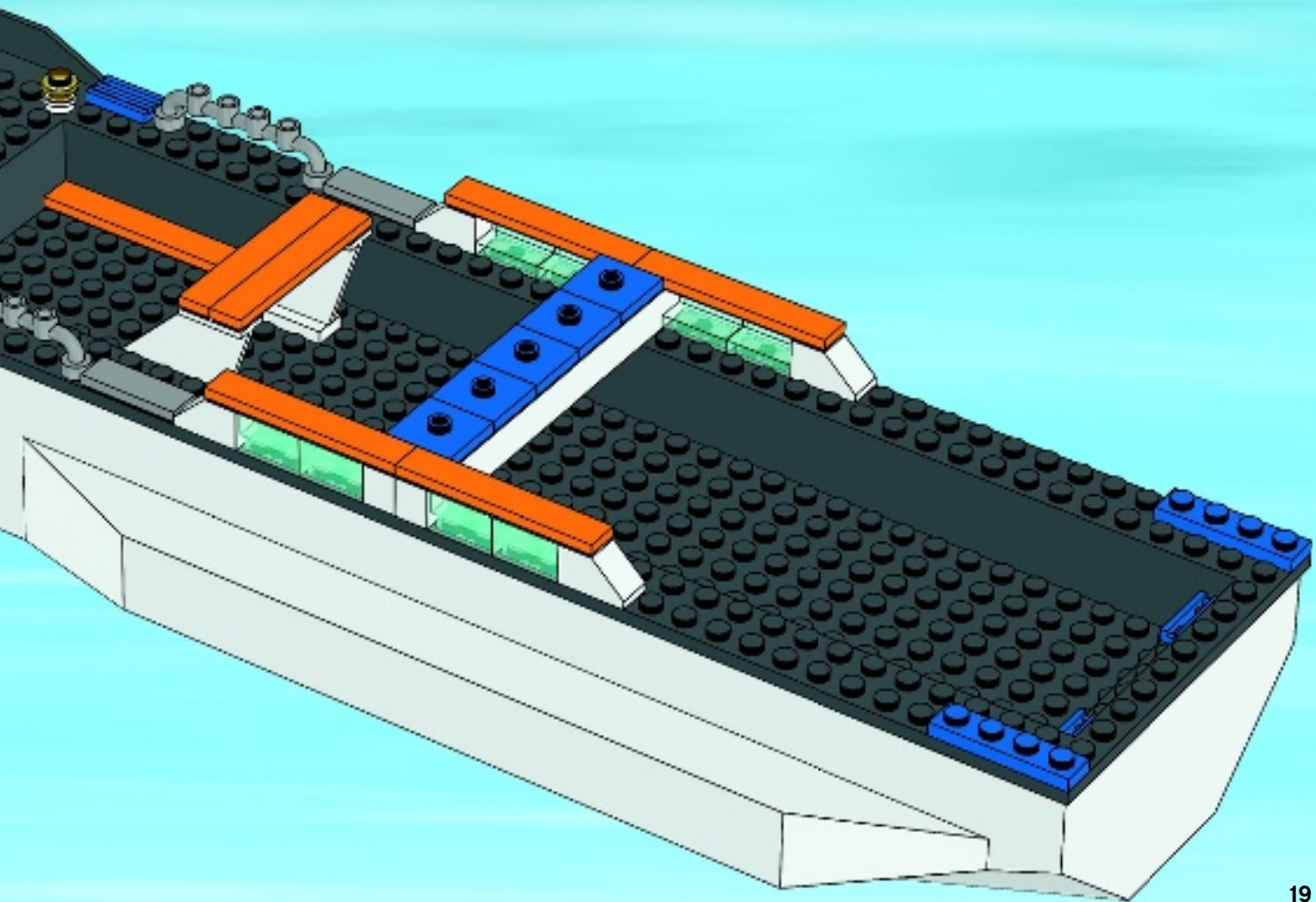



2x



2x

17

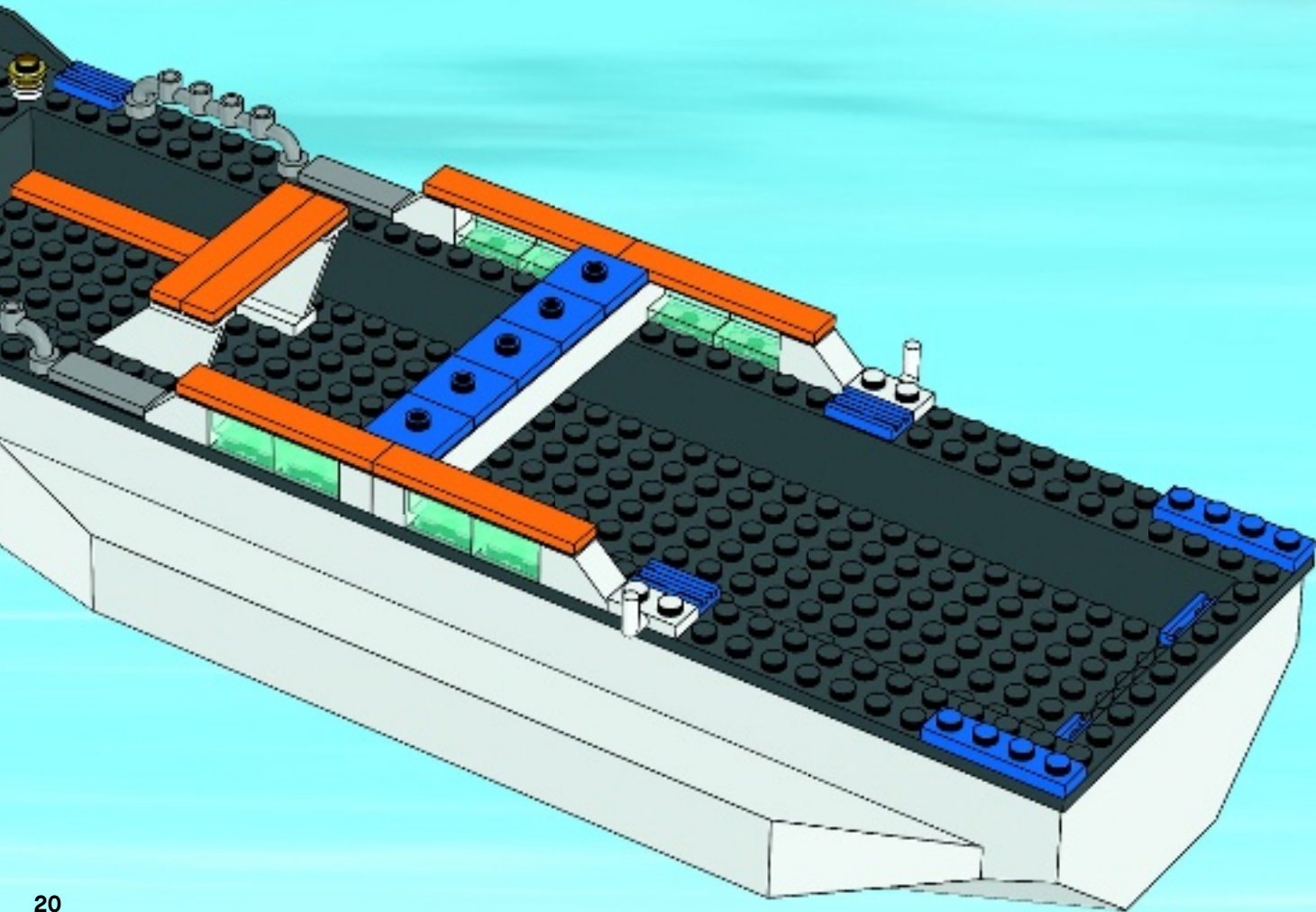



2x

18

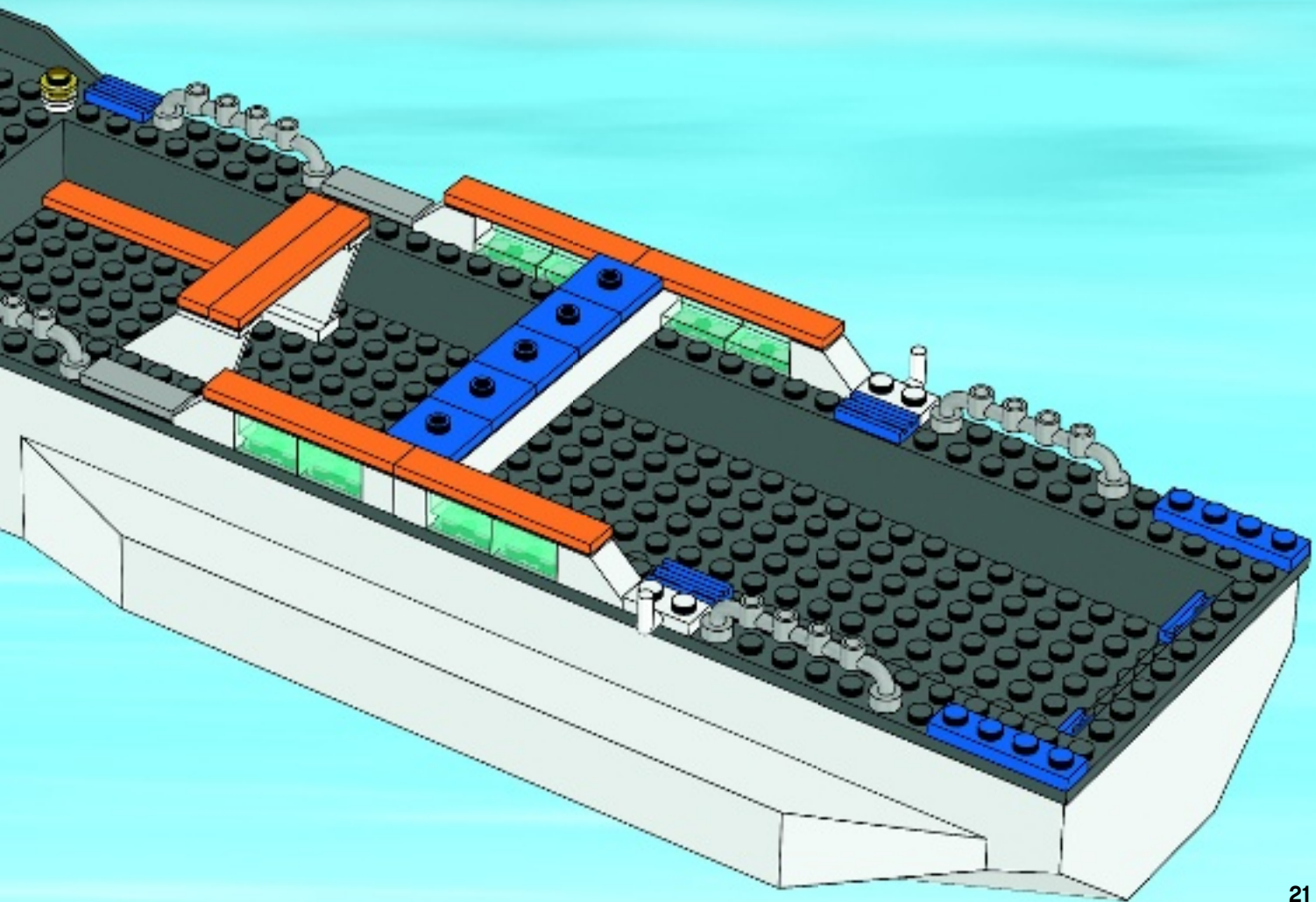



2x

19

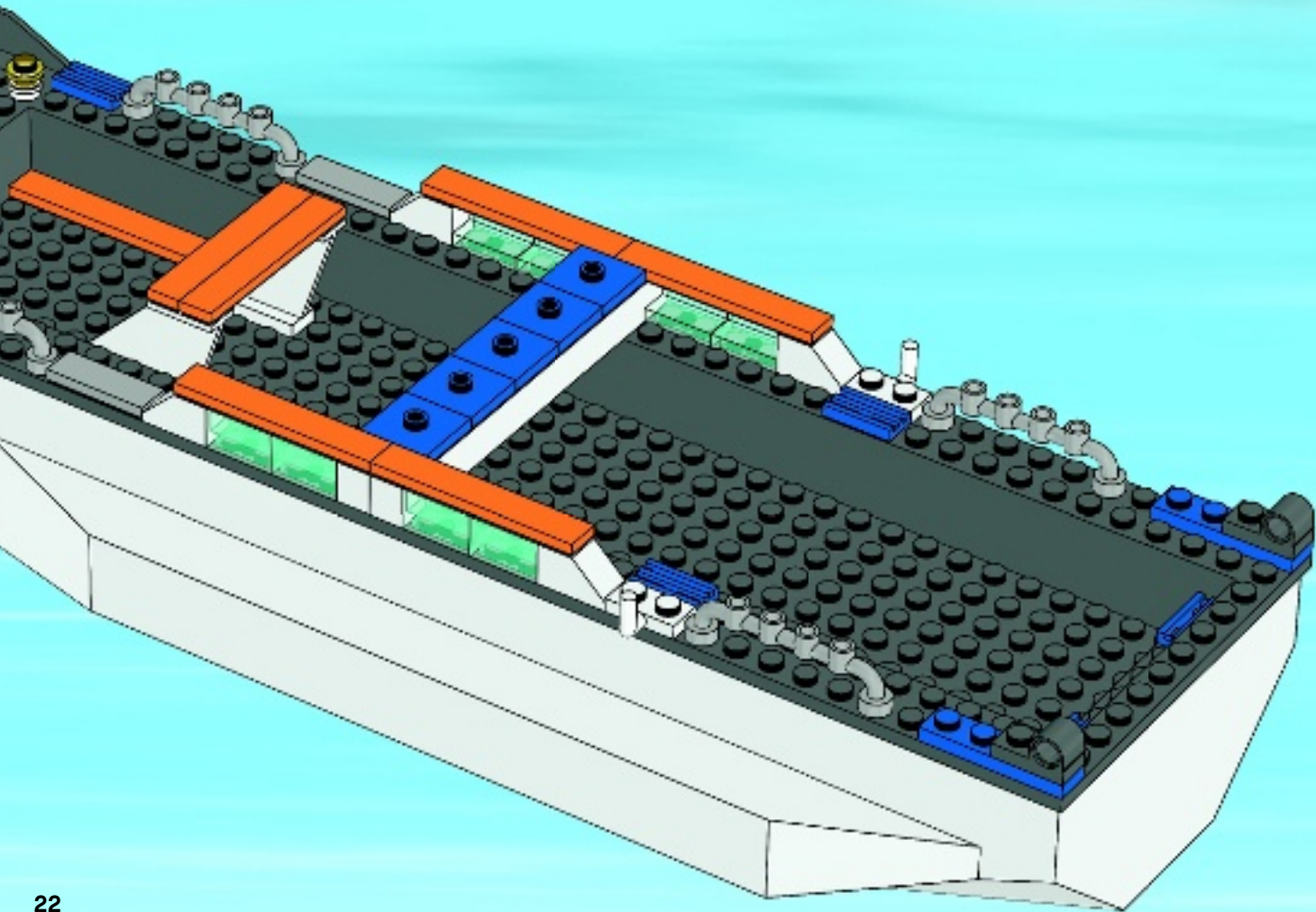



2x



2x

20

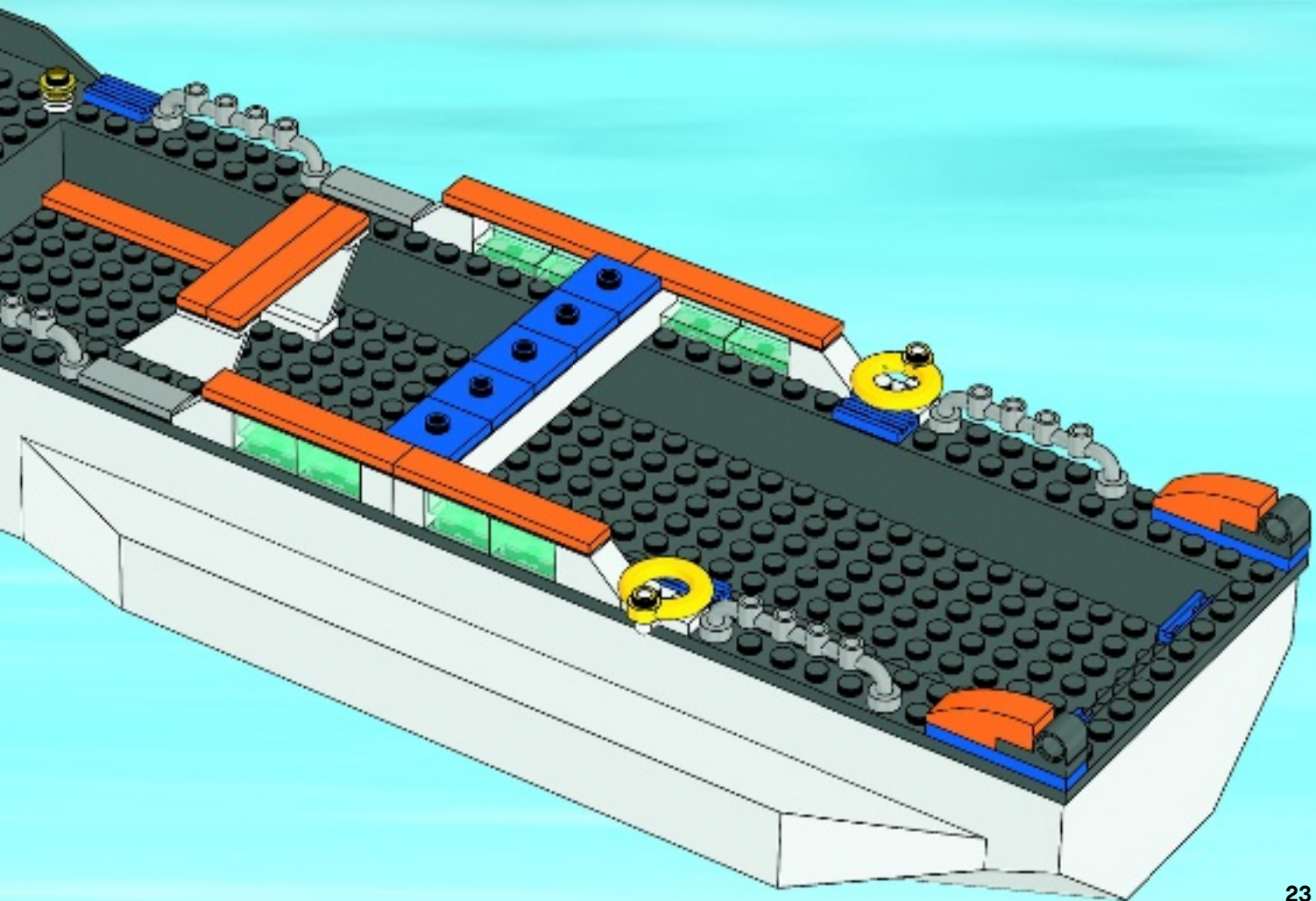

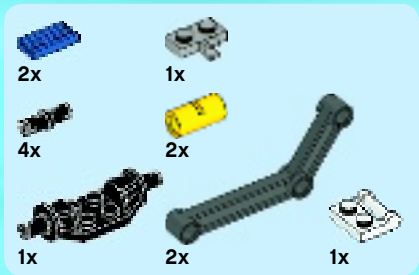

21

1



2



3



4



5



6

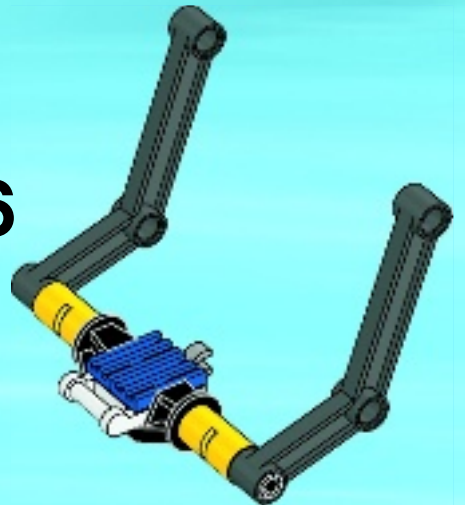

7

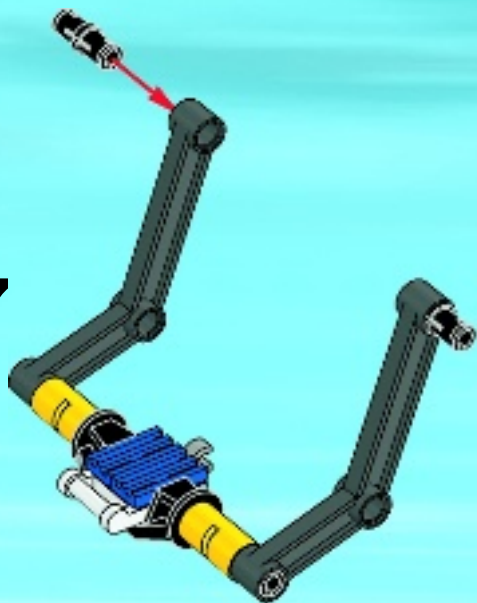

8

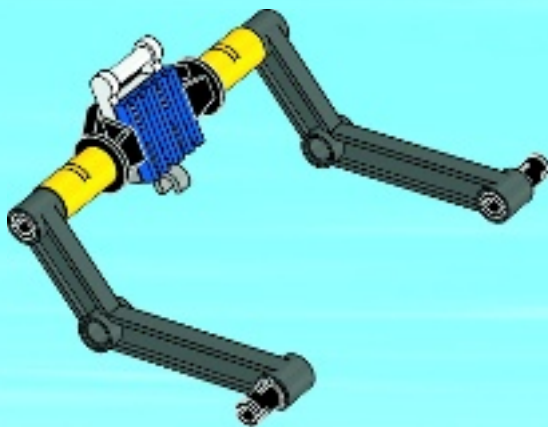

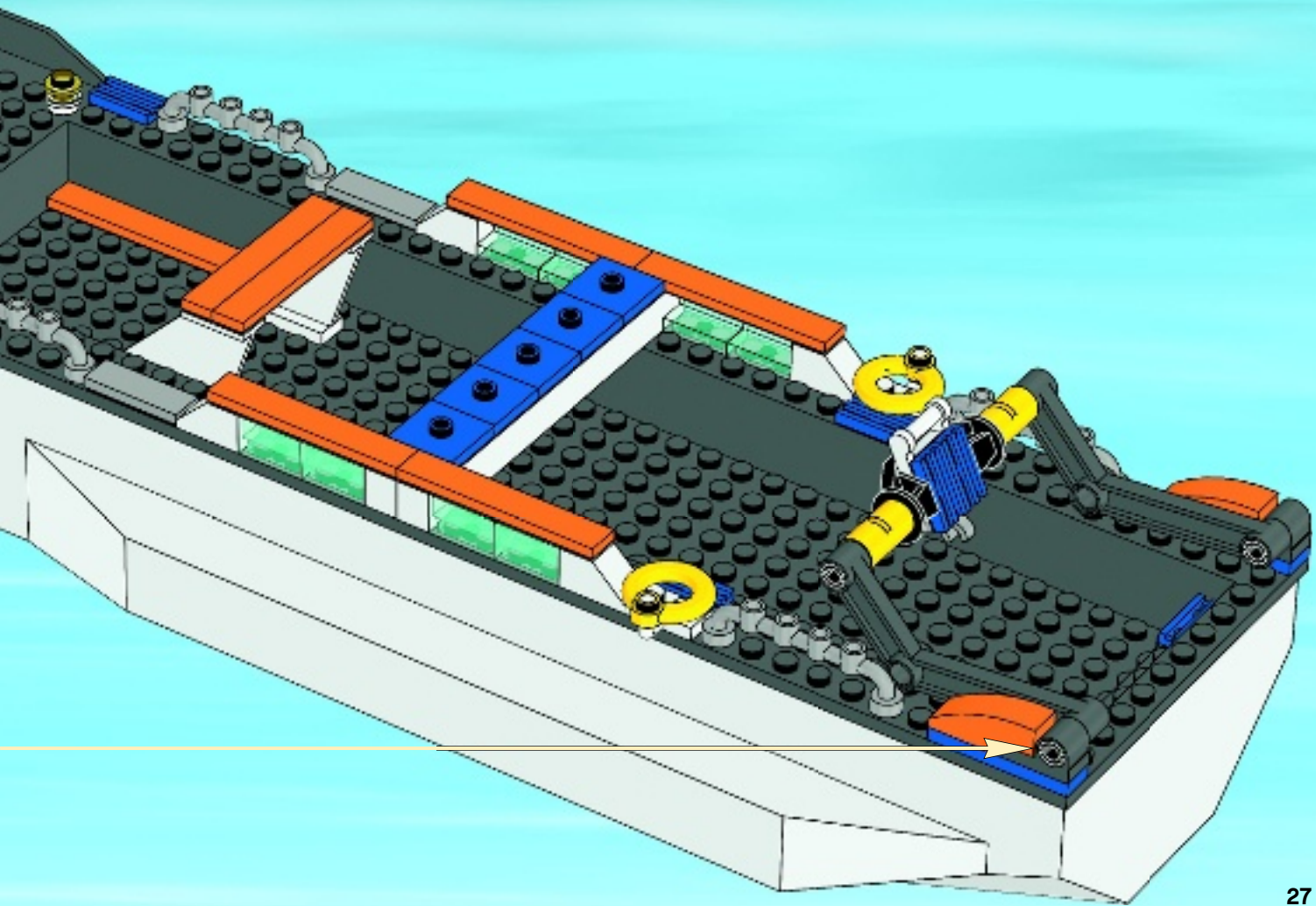

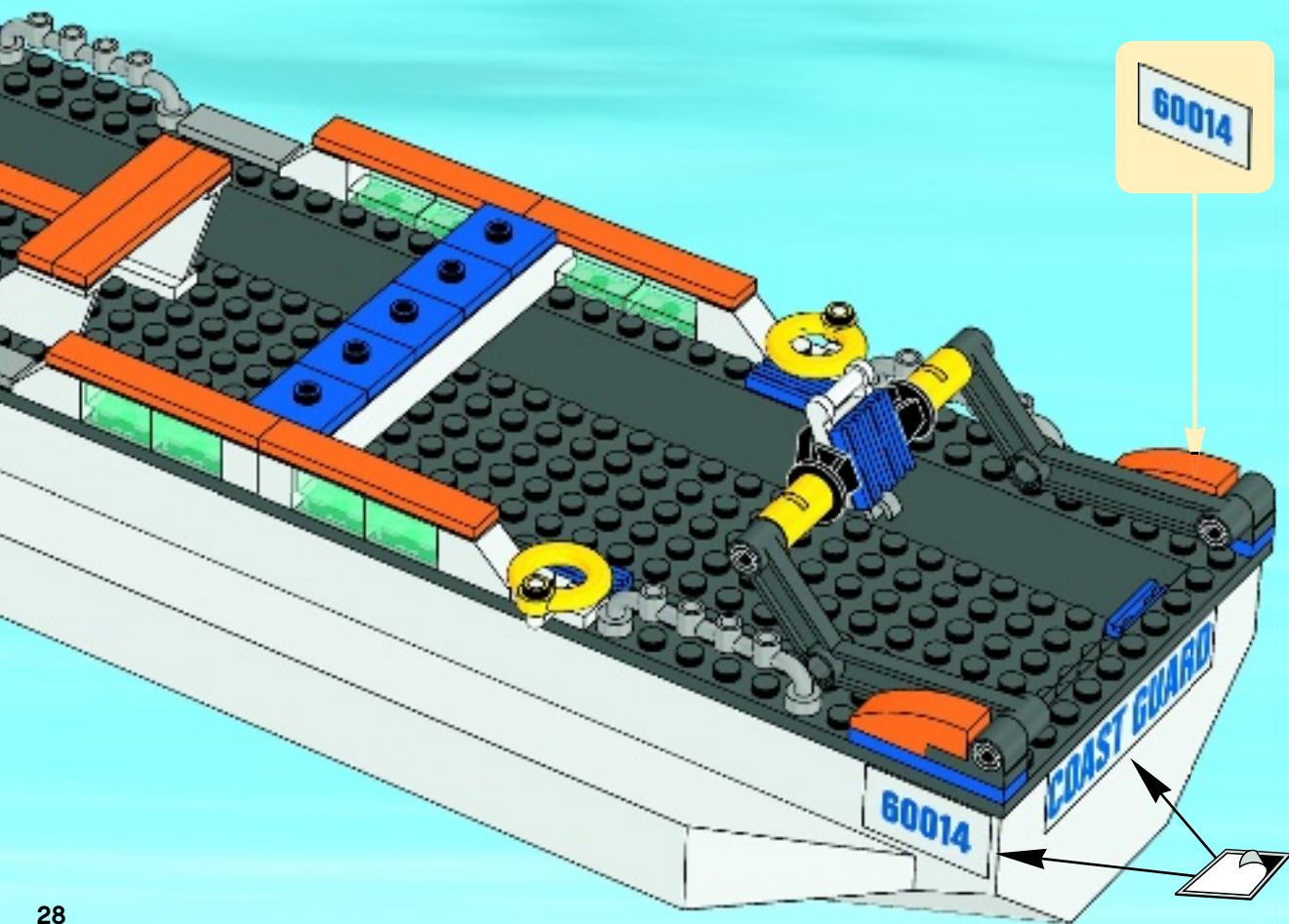

23

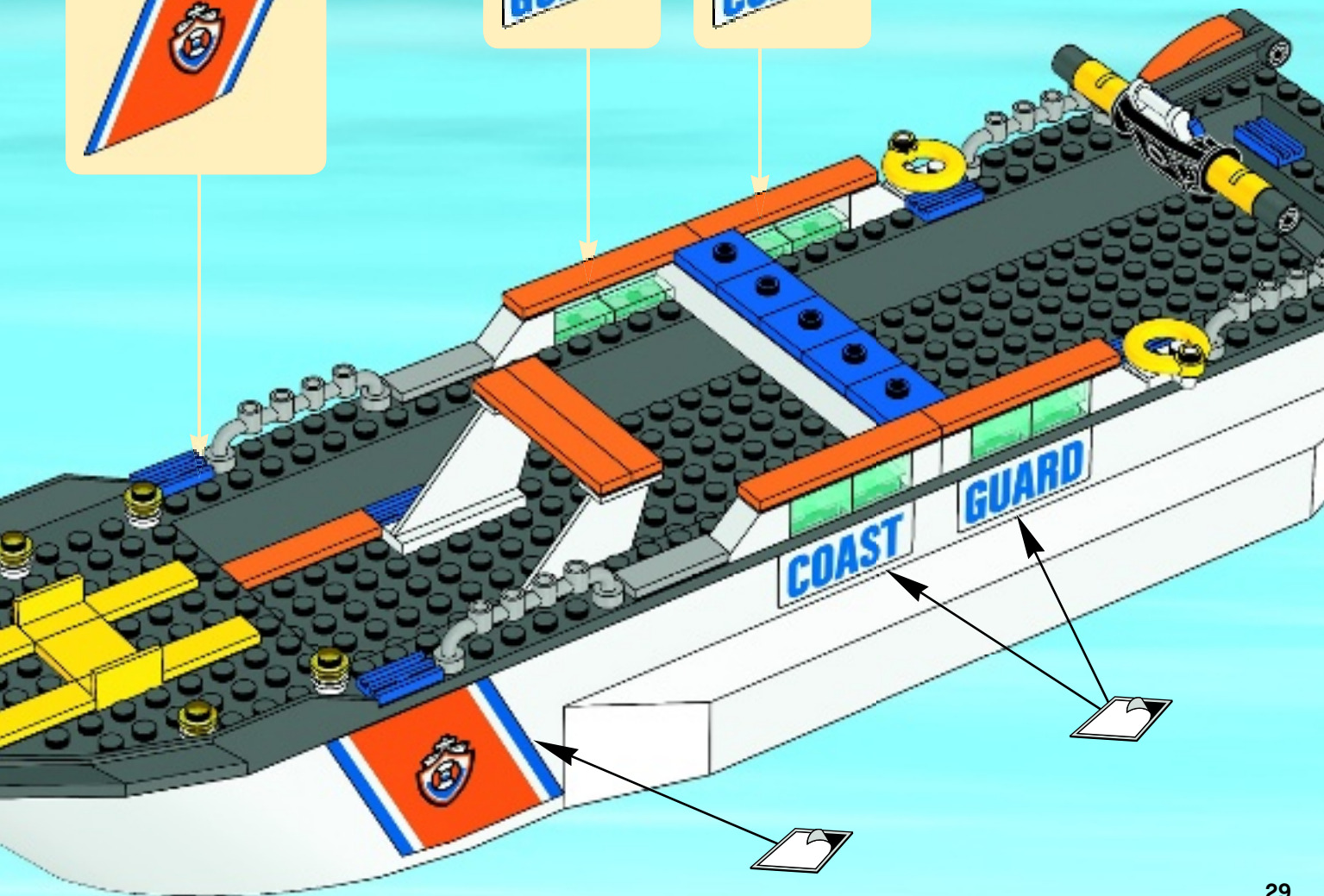

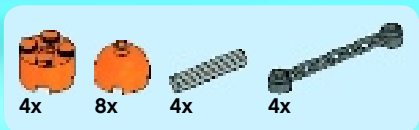

24

1



2

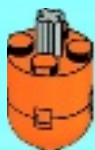

3



4



4x

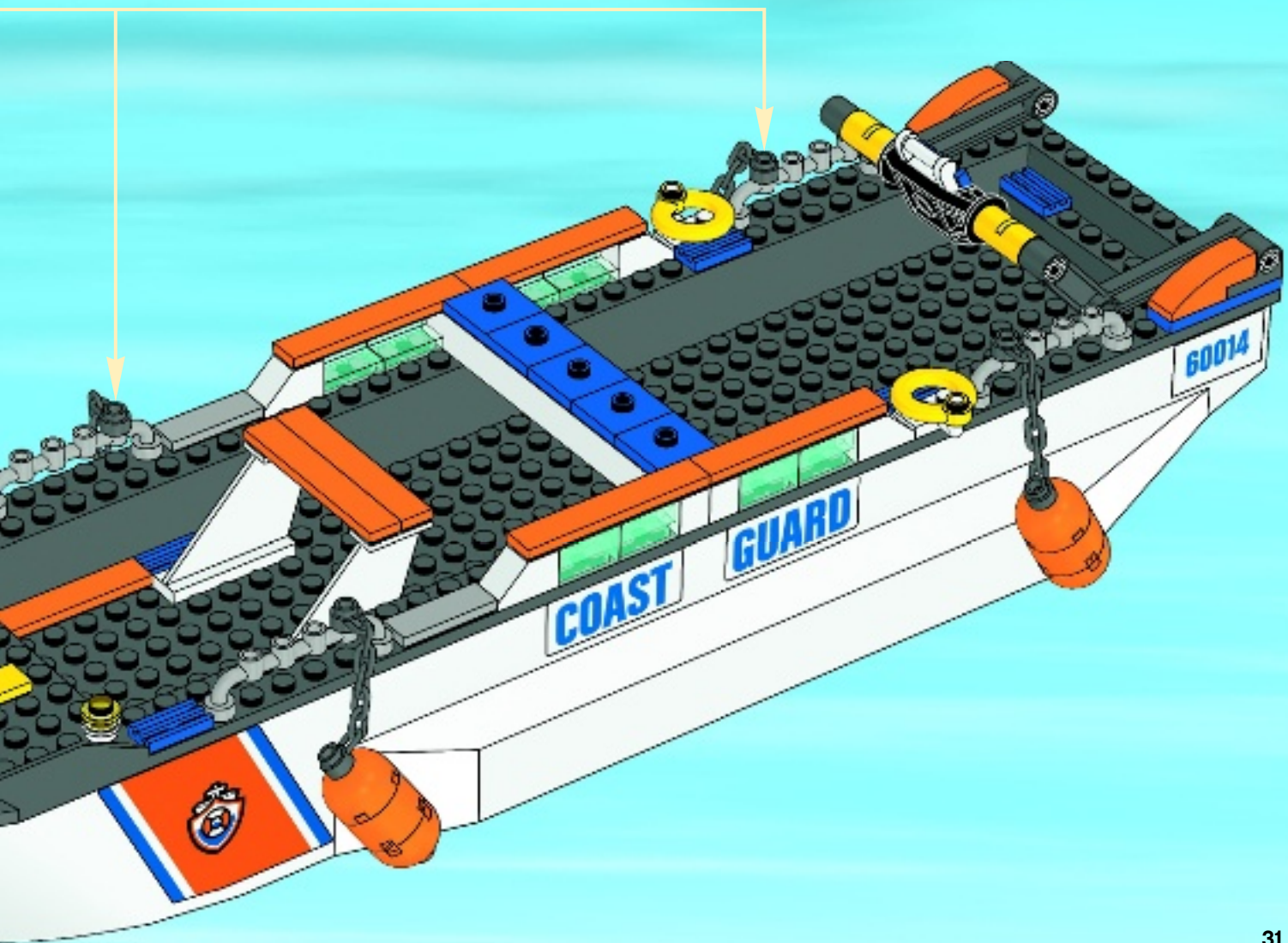



4

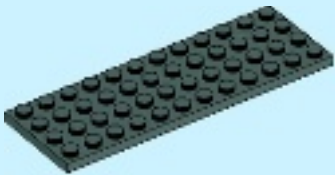

1x

1

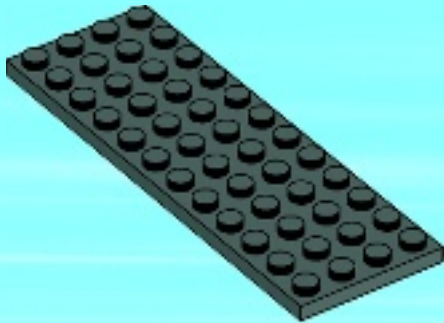

2x

2

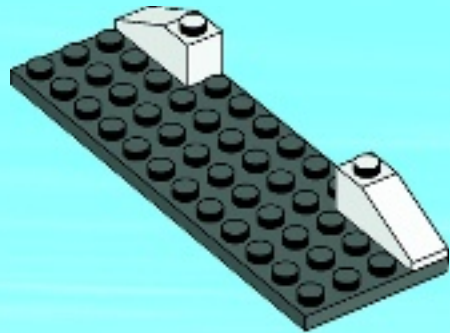

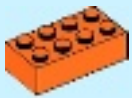

1x



2x

3

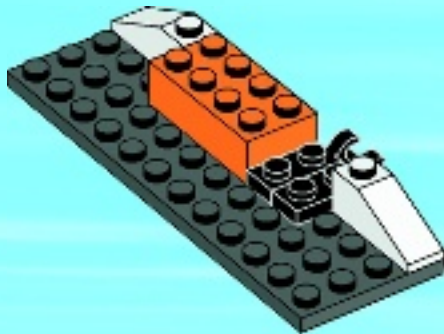

2x



1x

4

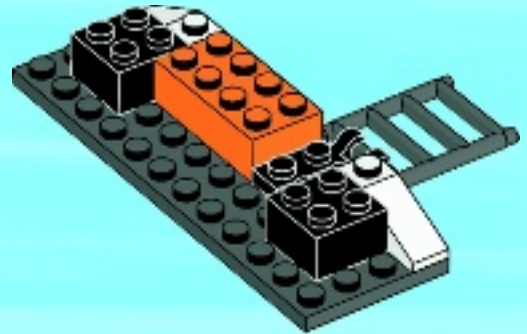



2x



1x

5

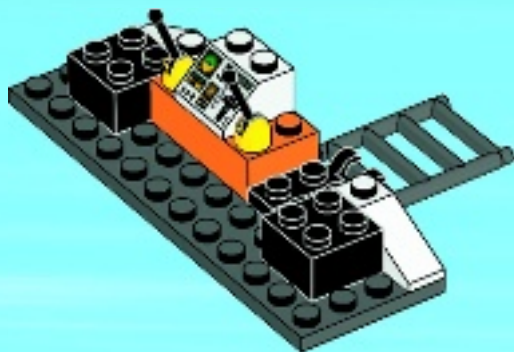



2x



2x

6

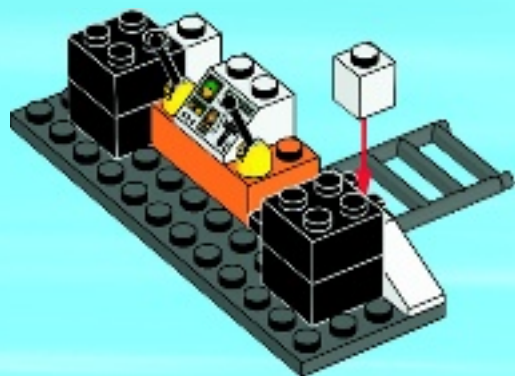

2x

7

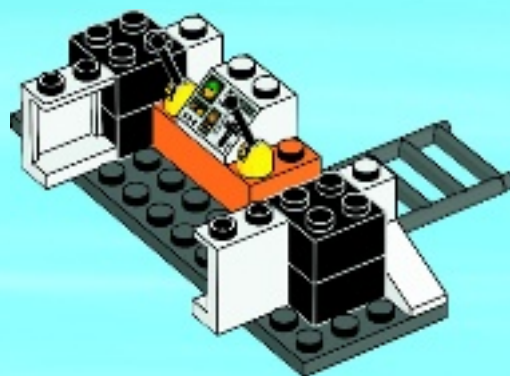

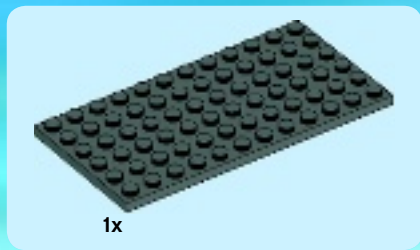

8

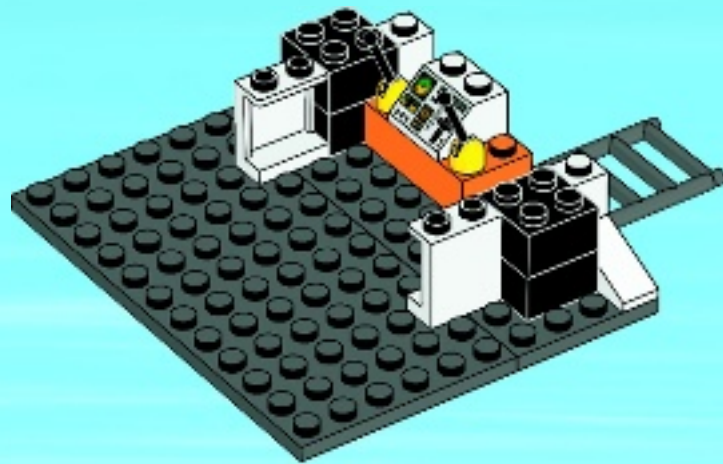



2x

9

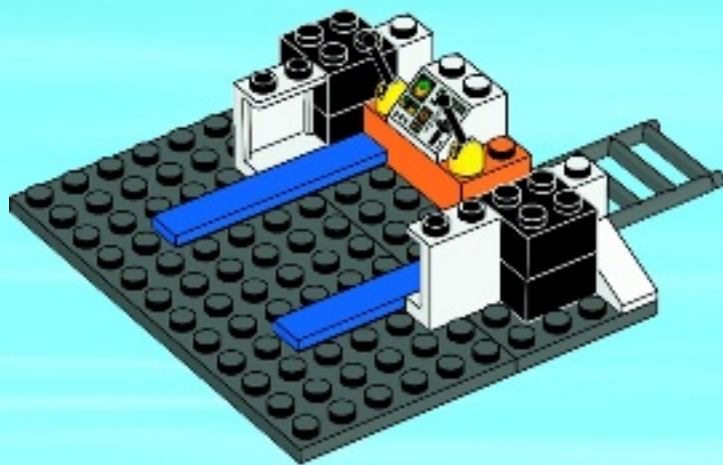



2x



2x

10

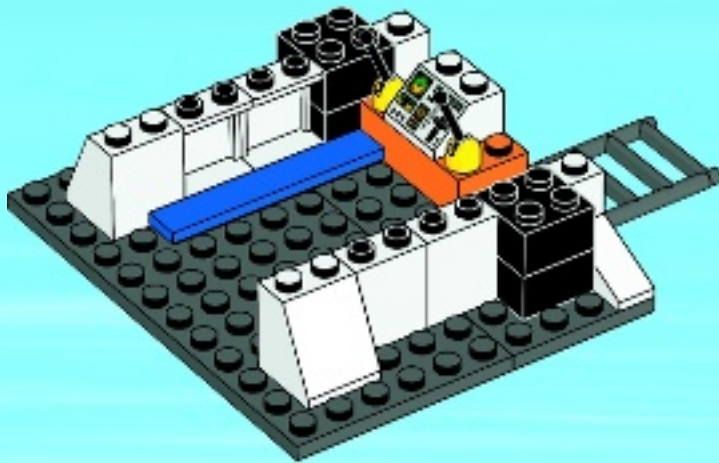



2x

11

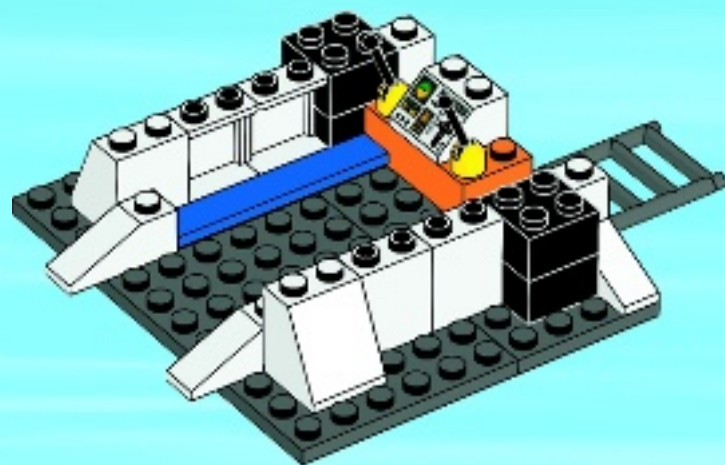



2x

12

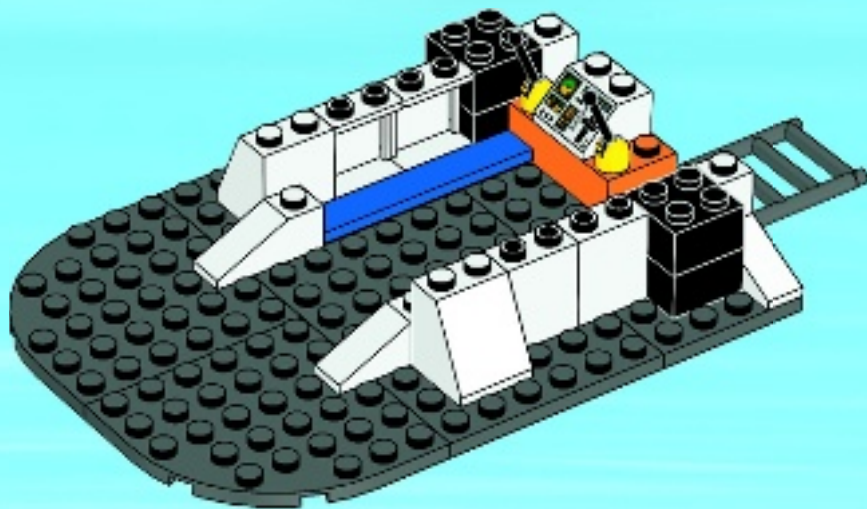

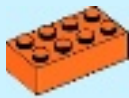

1x

13

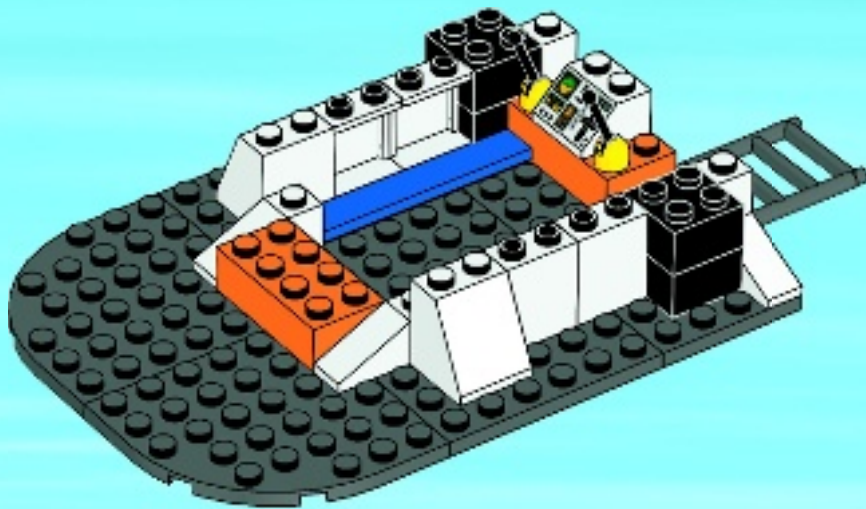



1x



1x

14

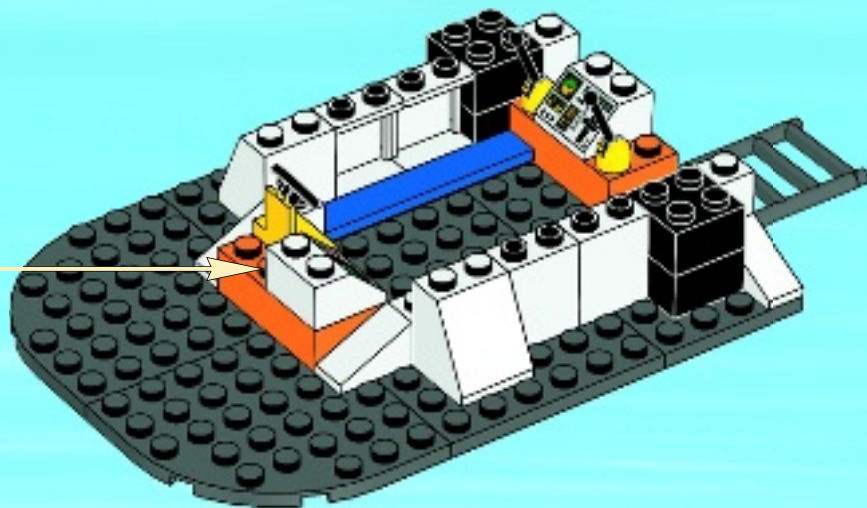



1x



2x

15

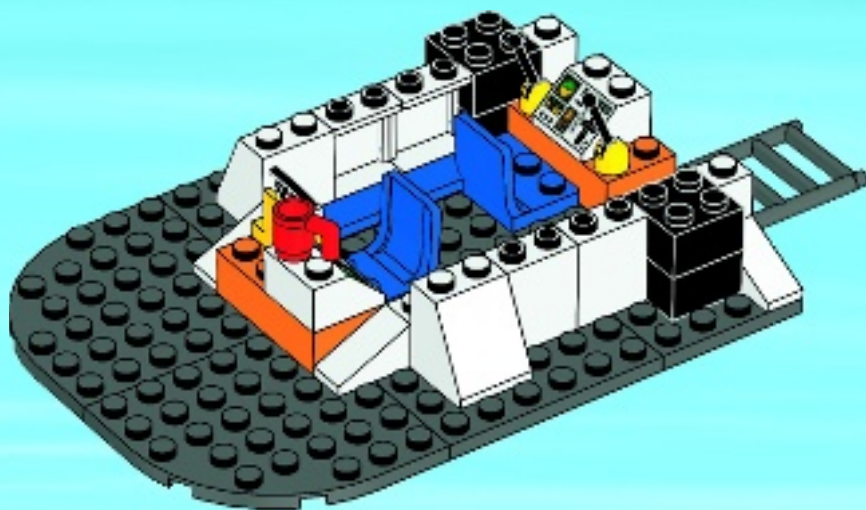



16

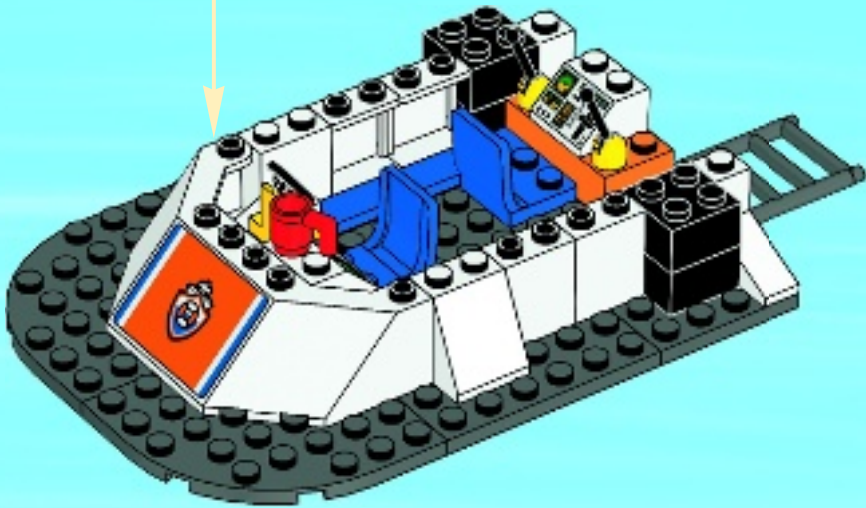
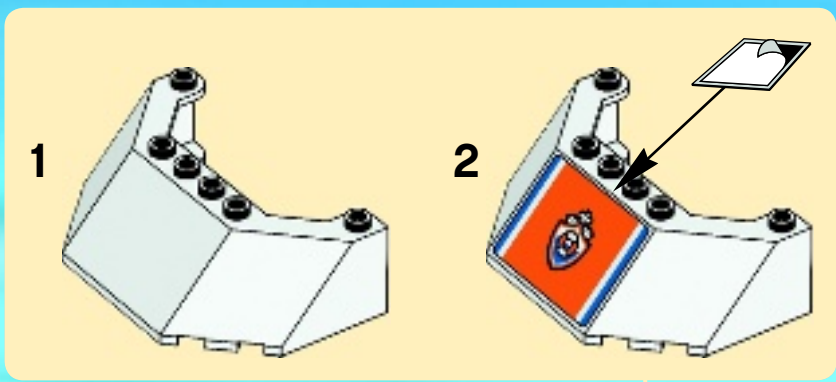



2x



2x

17

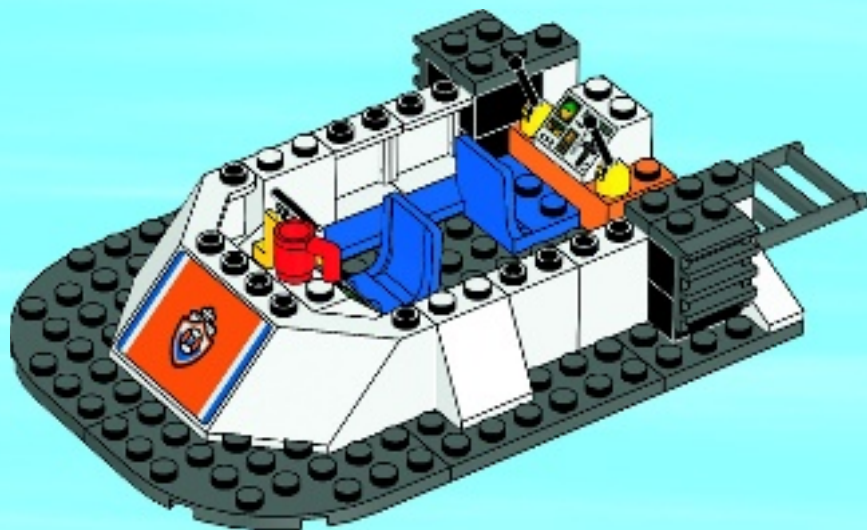

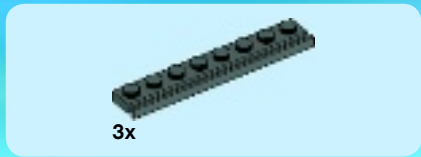

18

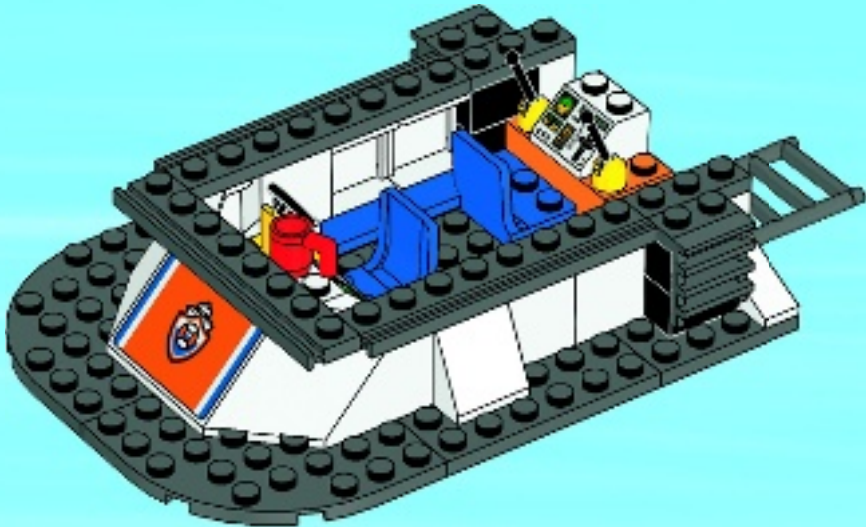



2x

19

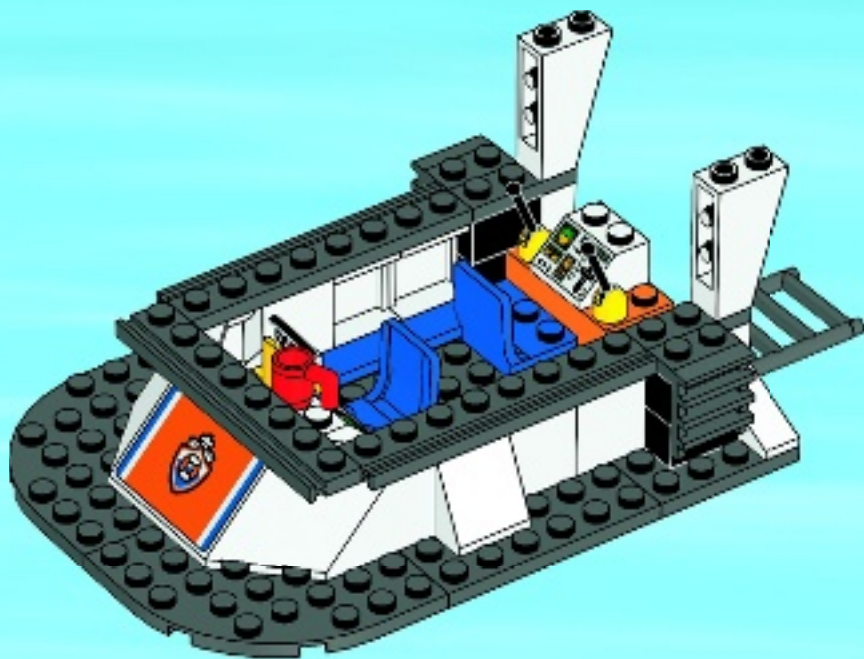

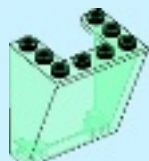

1x

20

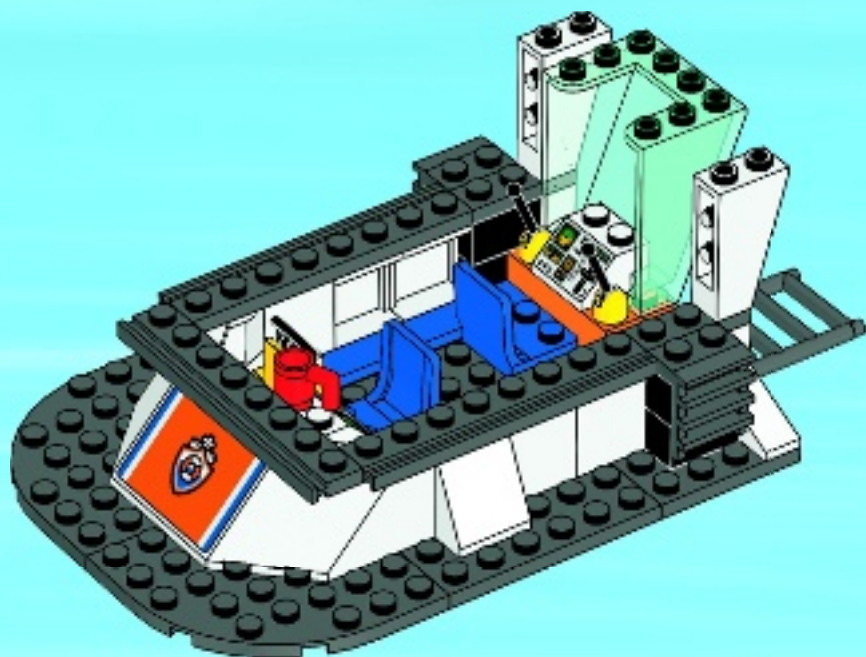



4x

21

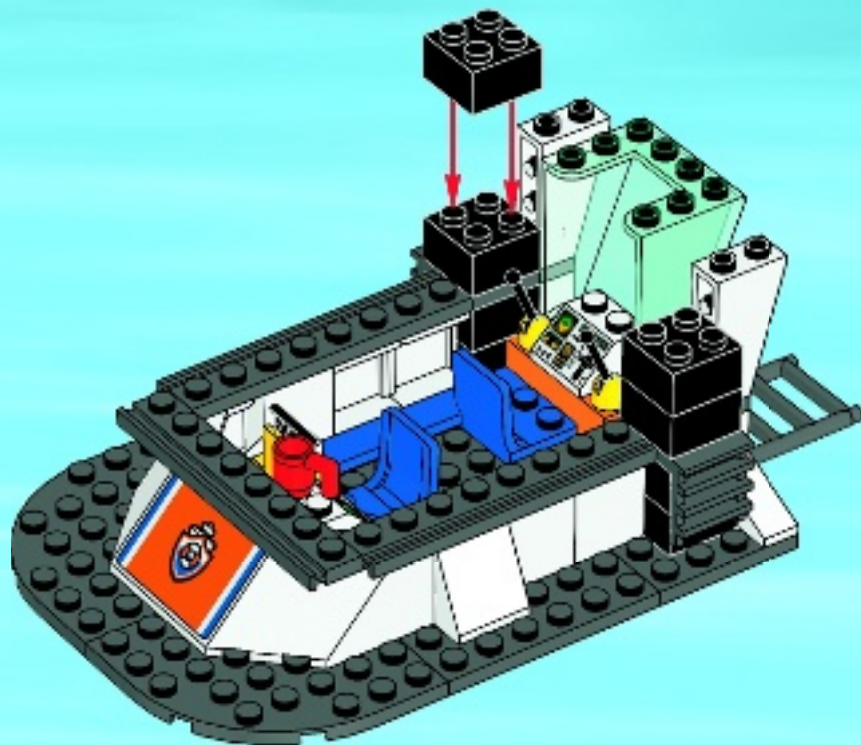

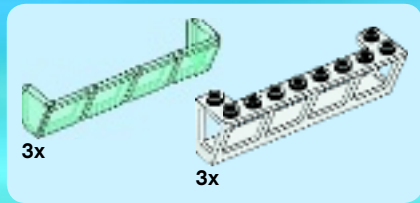

22

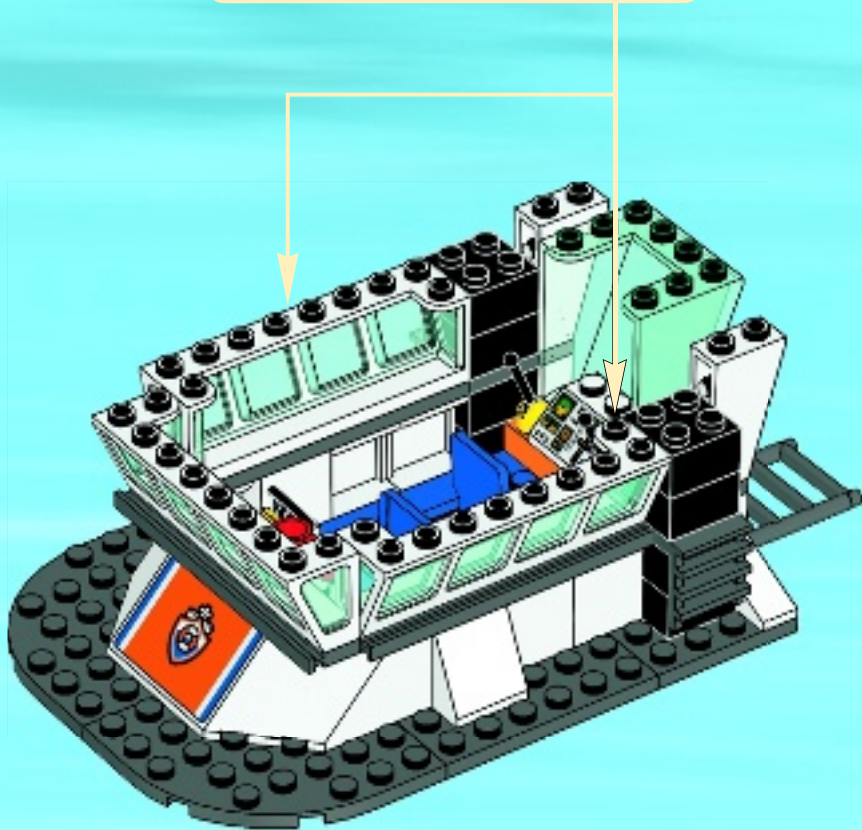
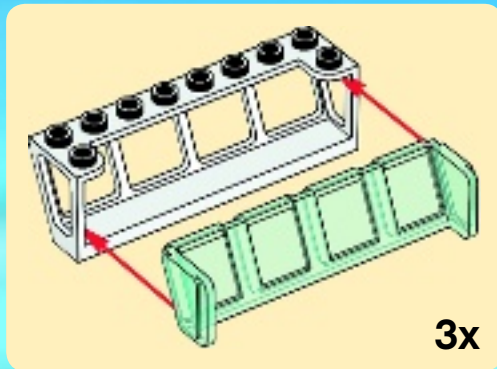

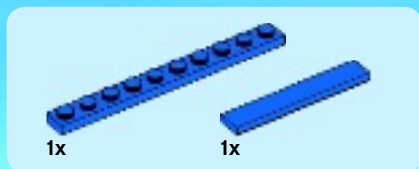

23

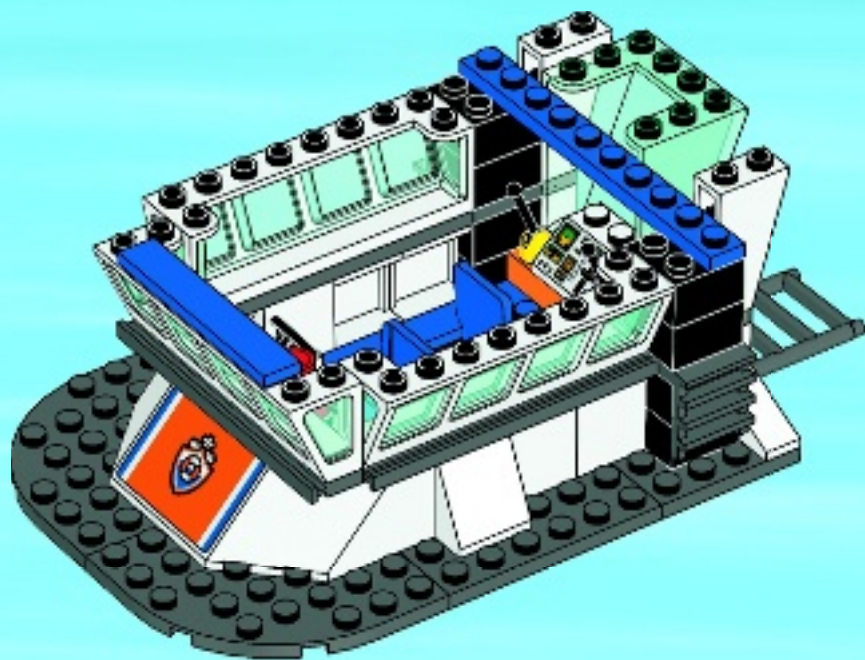

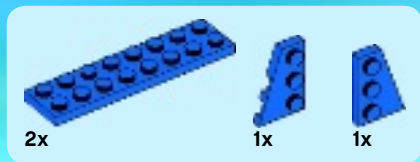

24

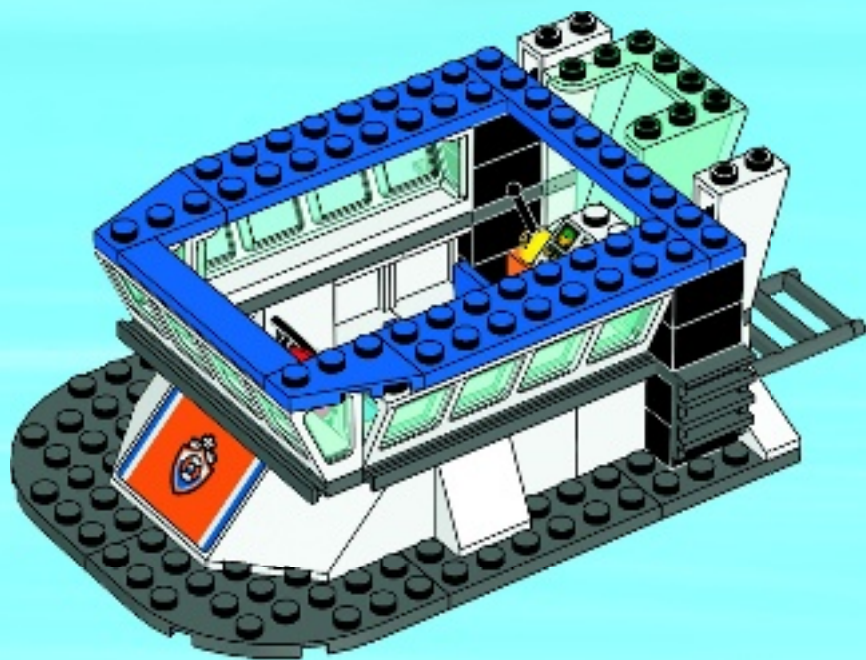



2x



1x

25

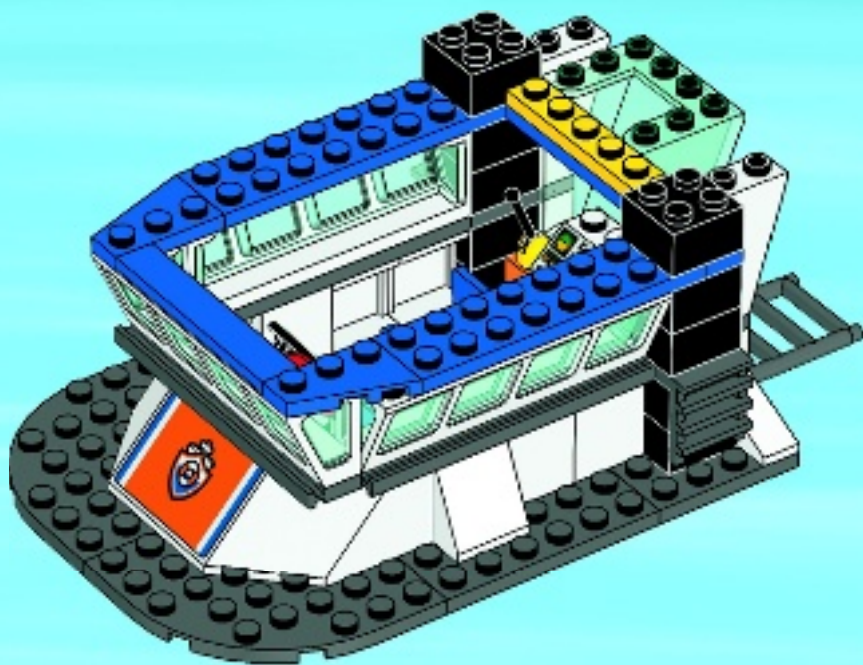



1x



2x

26

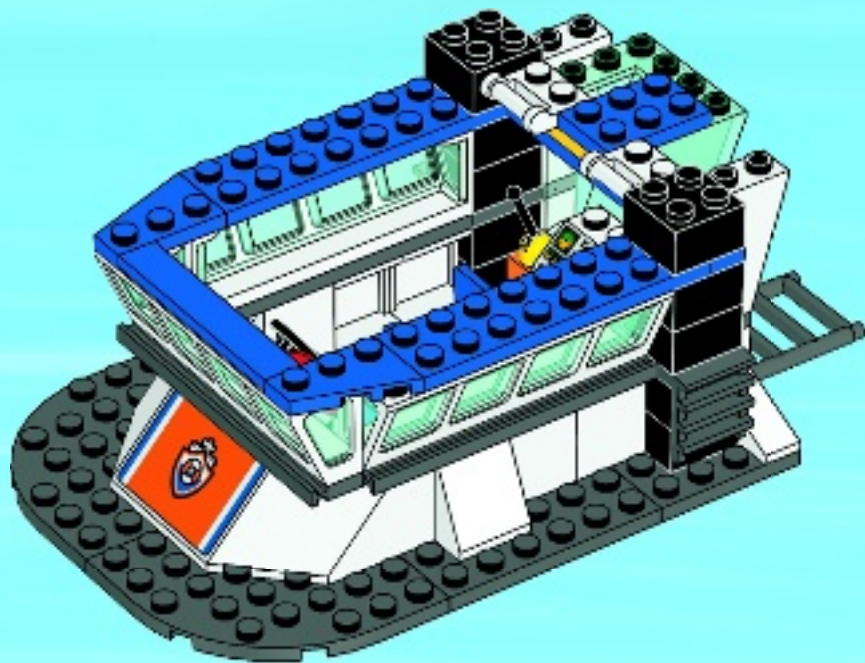



1x



1x

27

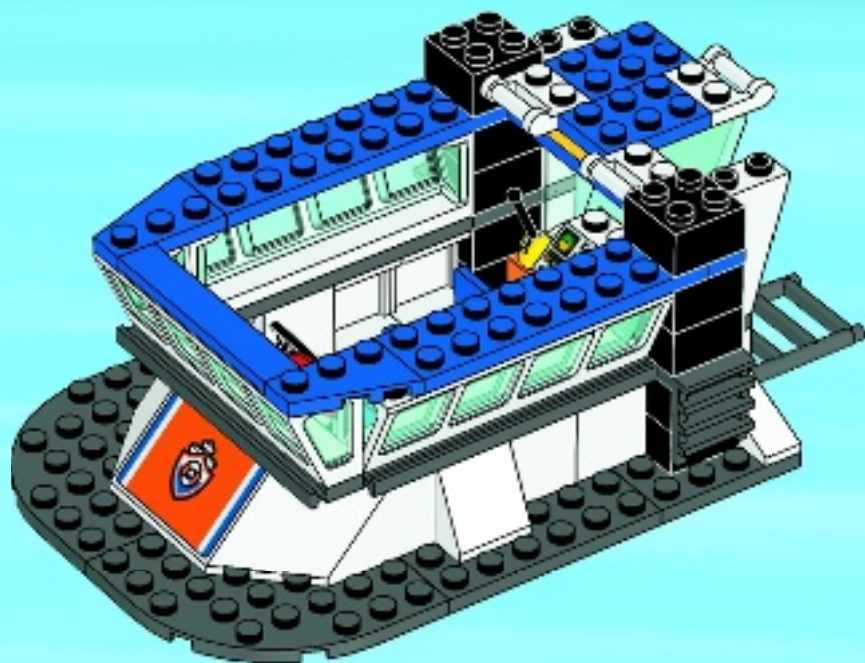



1x



1x

28

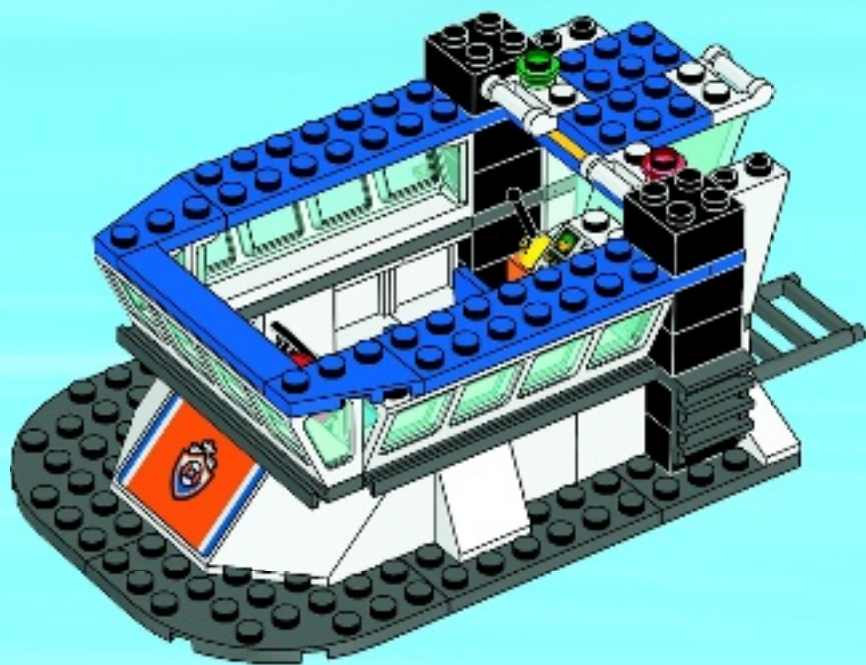



2x



1x

29

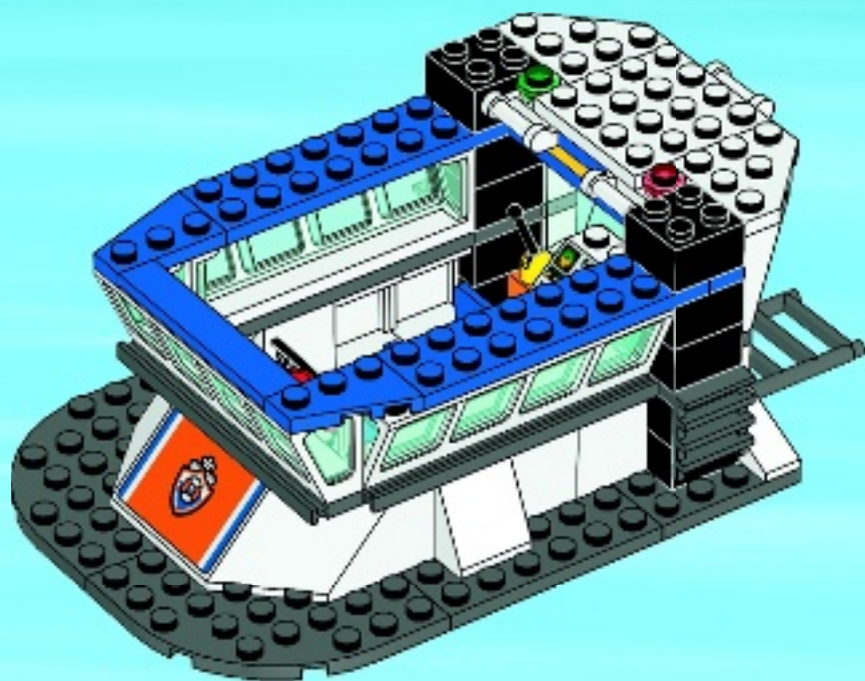



2x

30

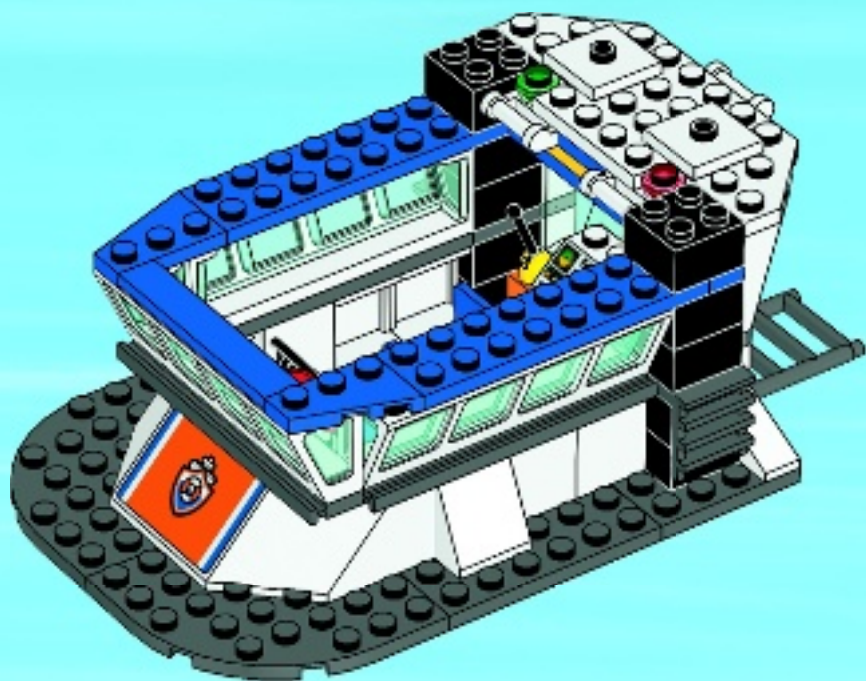



6x

31

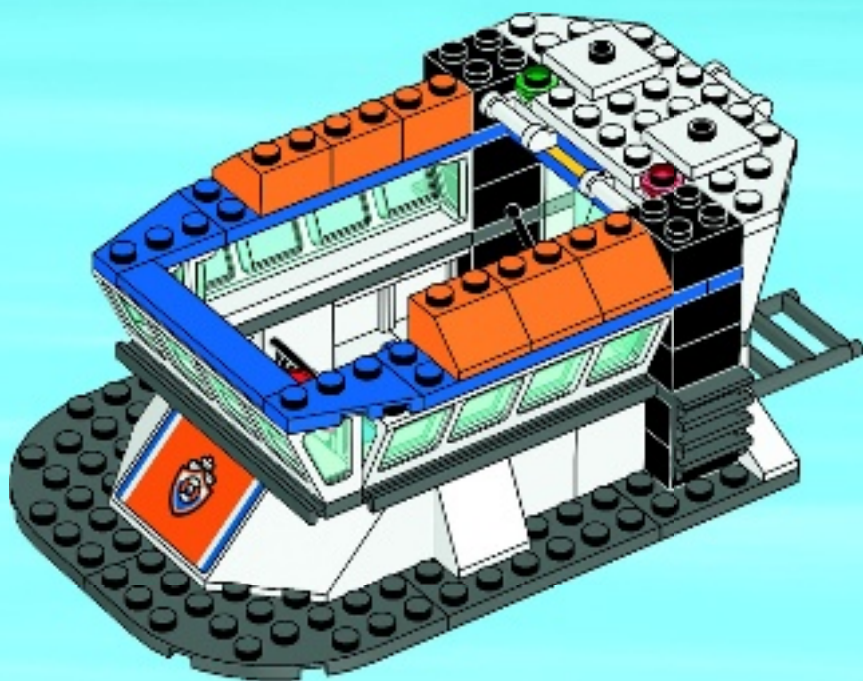



1x



1x

32

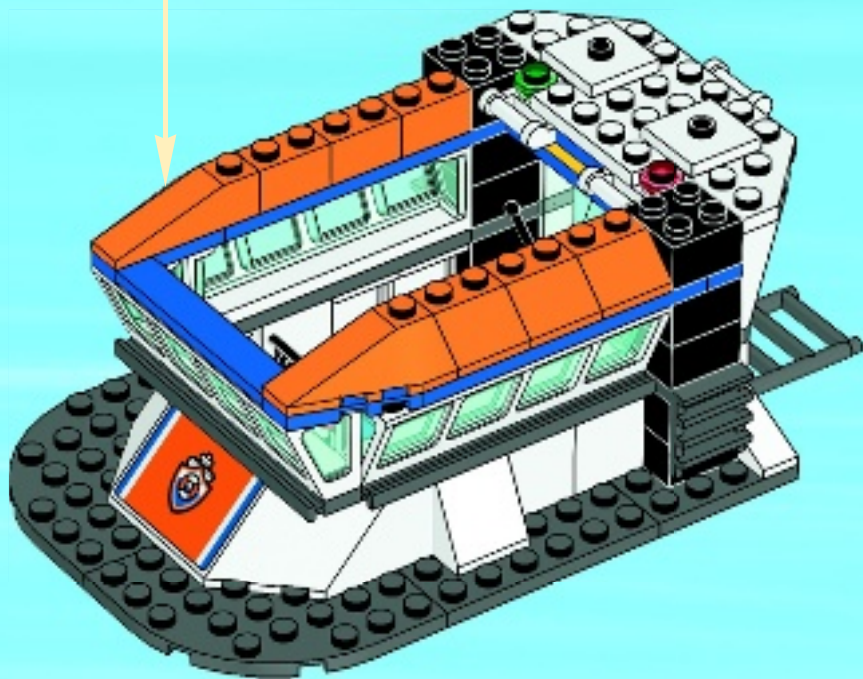



2x



2x

33

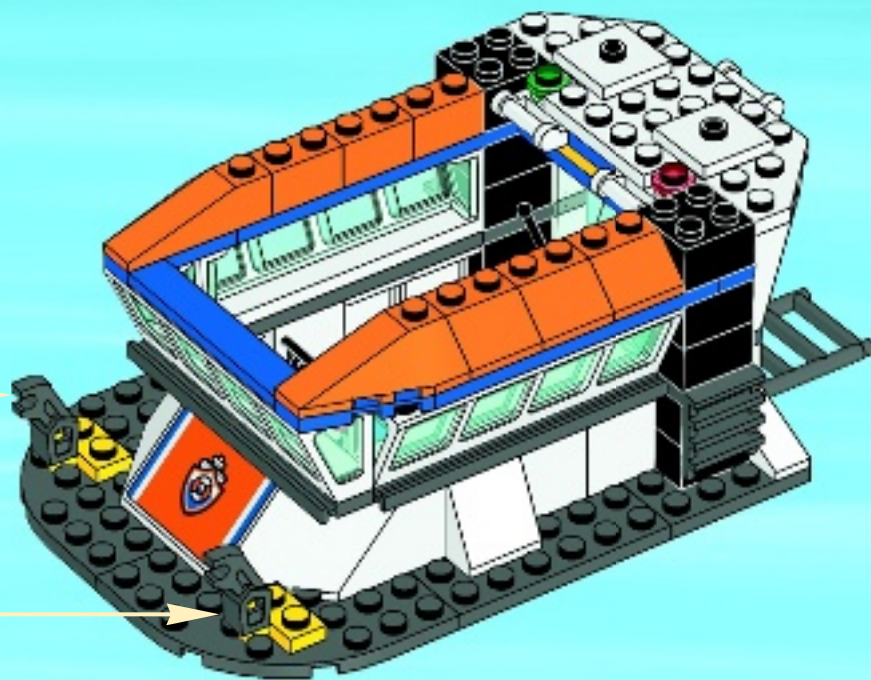
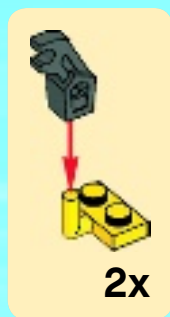



2x



2x

34

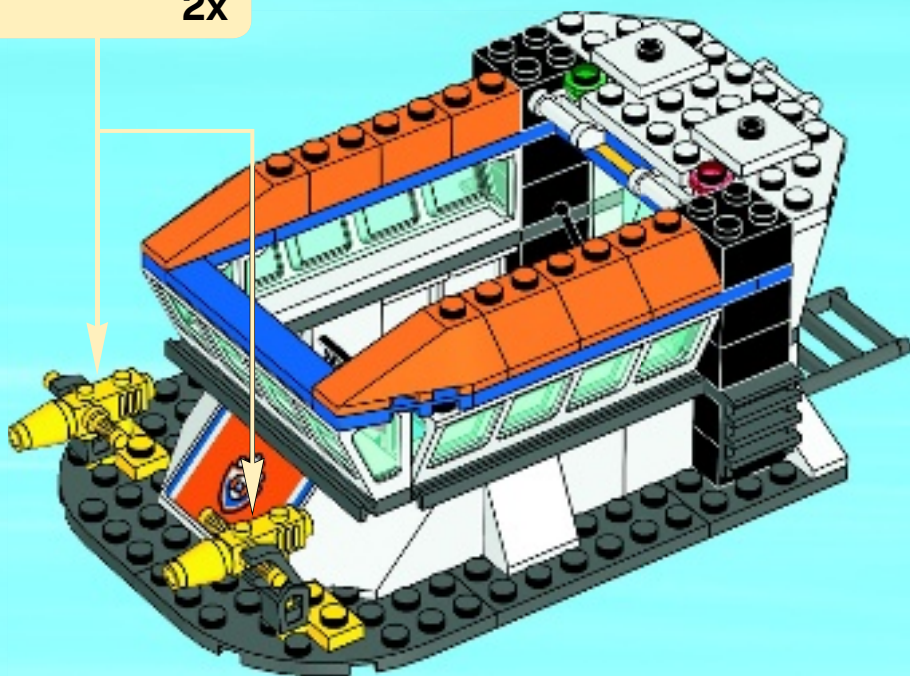
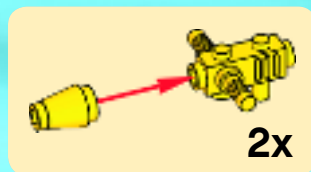

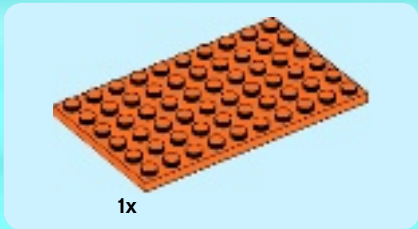

1x

1

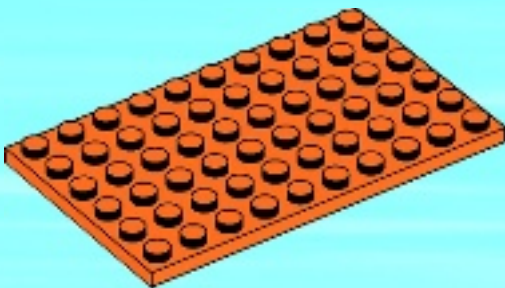

4x

2





2x

3

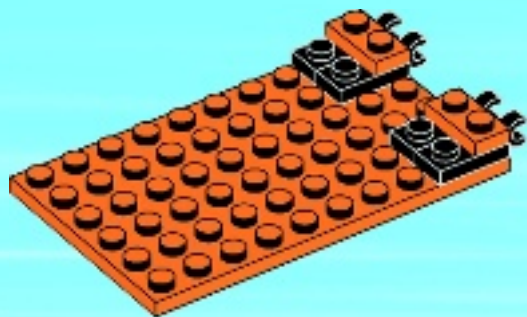

2x

4





1x



1x

5



1x



1x



1x

6





1x

7

1

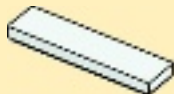

2

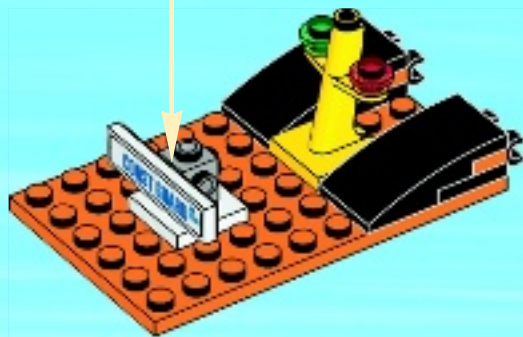
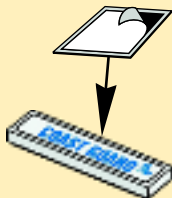



1x



2x

8

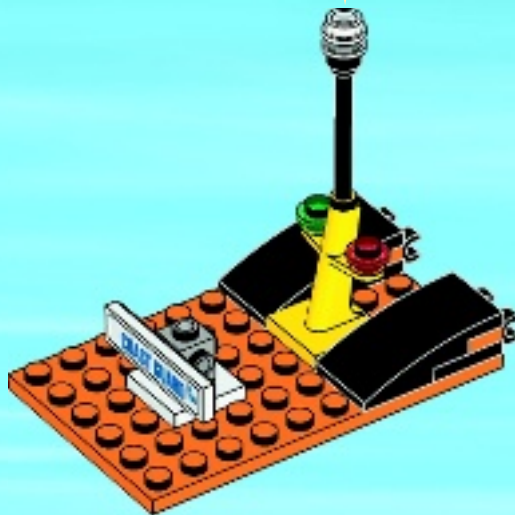

35

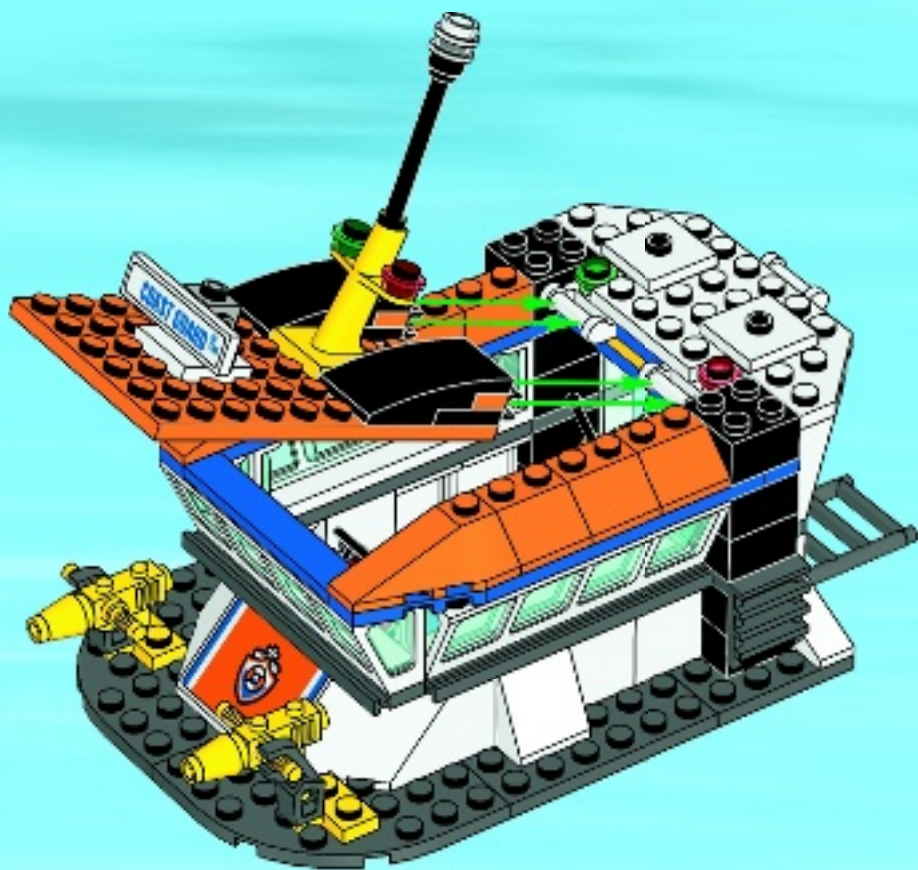



2x

36

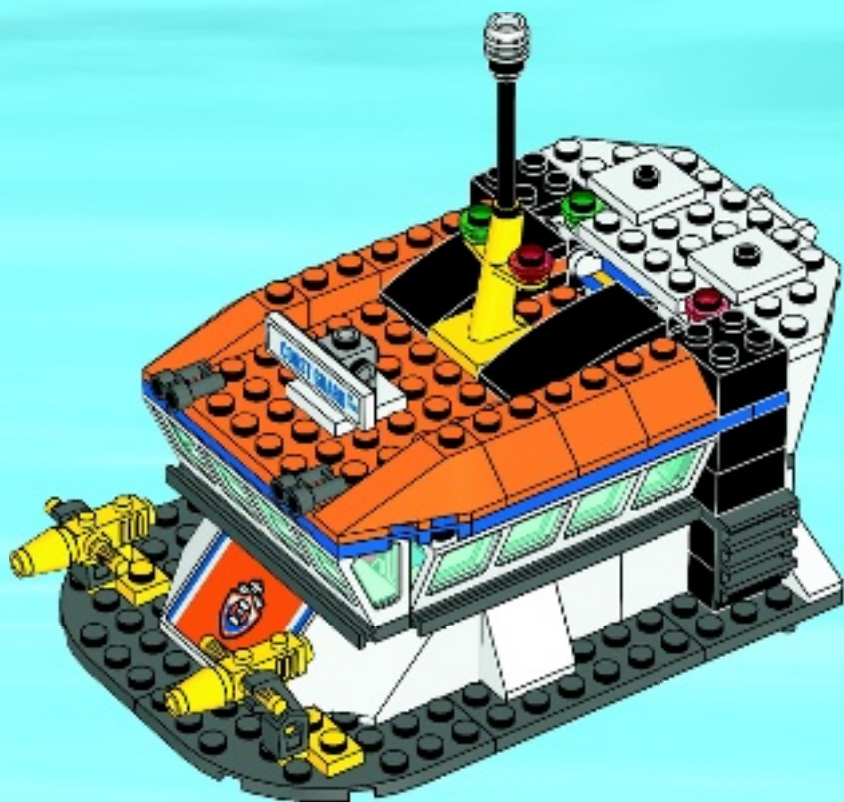



1x



1x



1x



1x

37

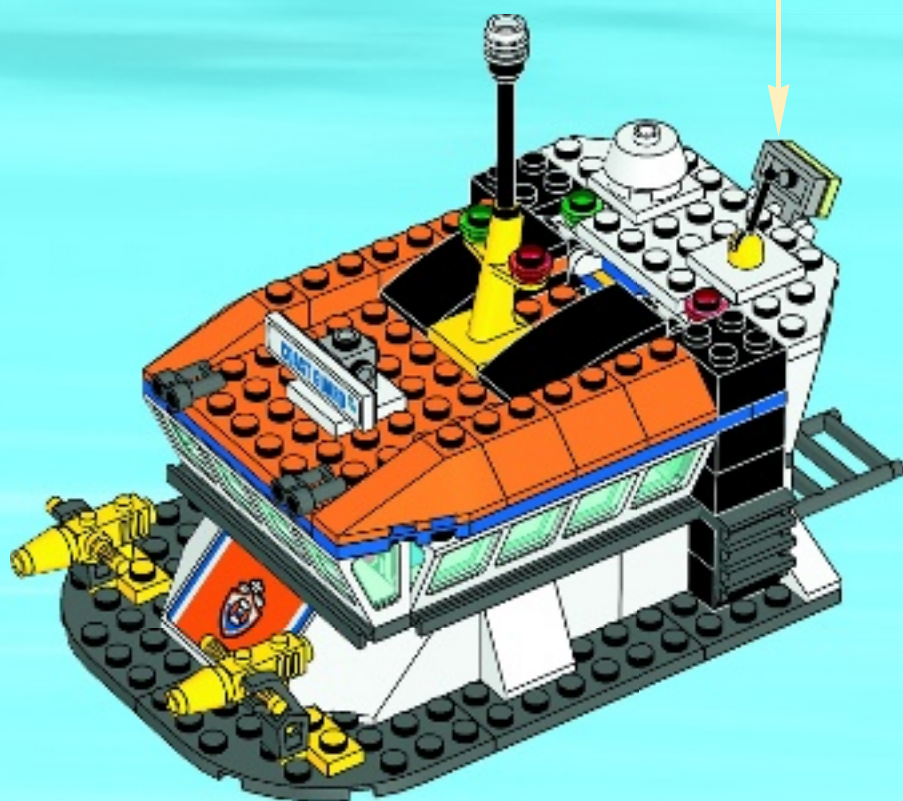
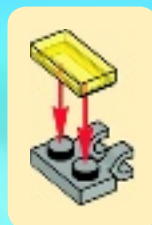



2x

38

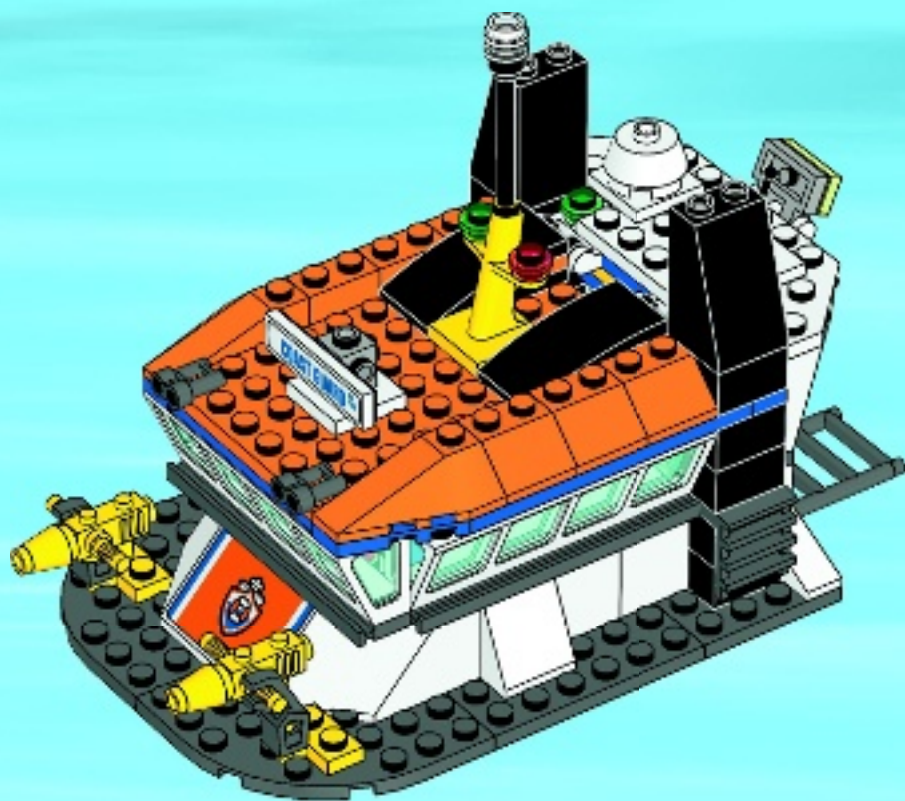

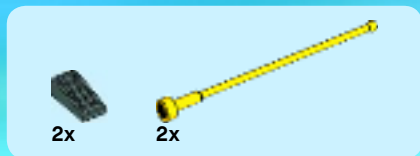

39

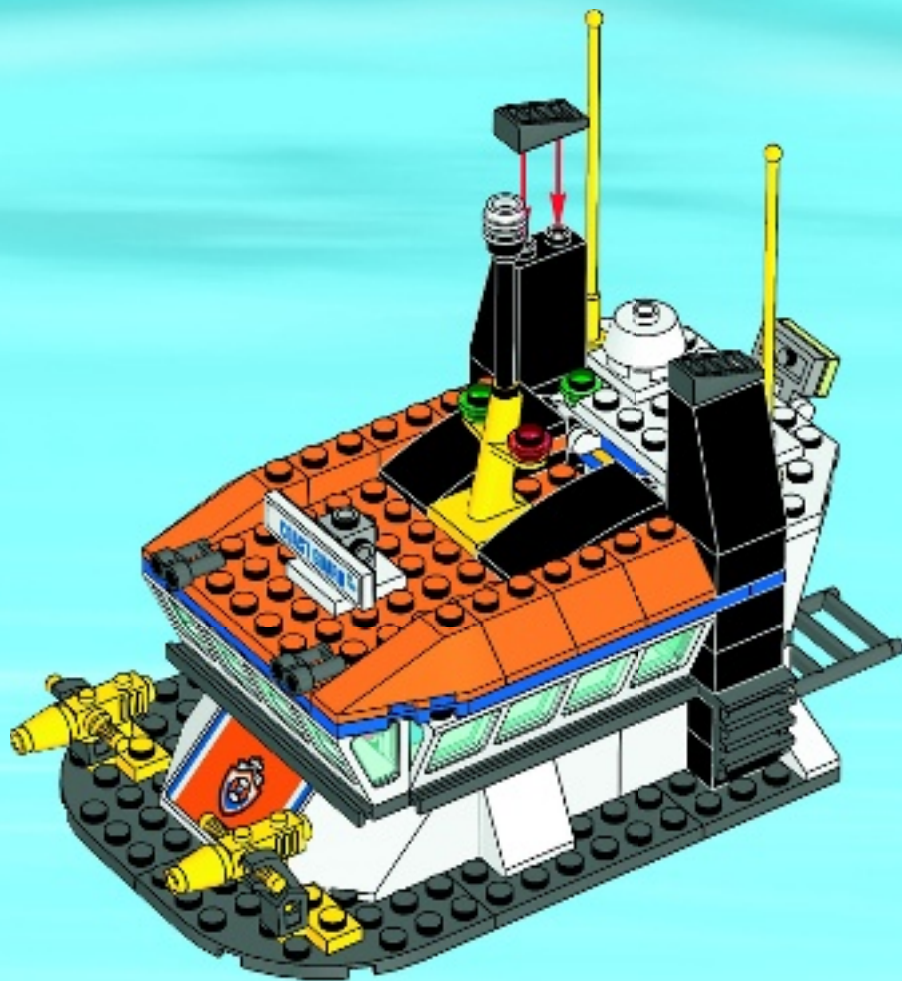

40



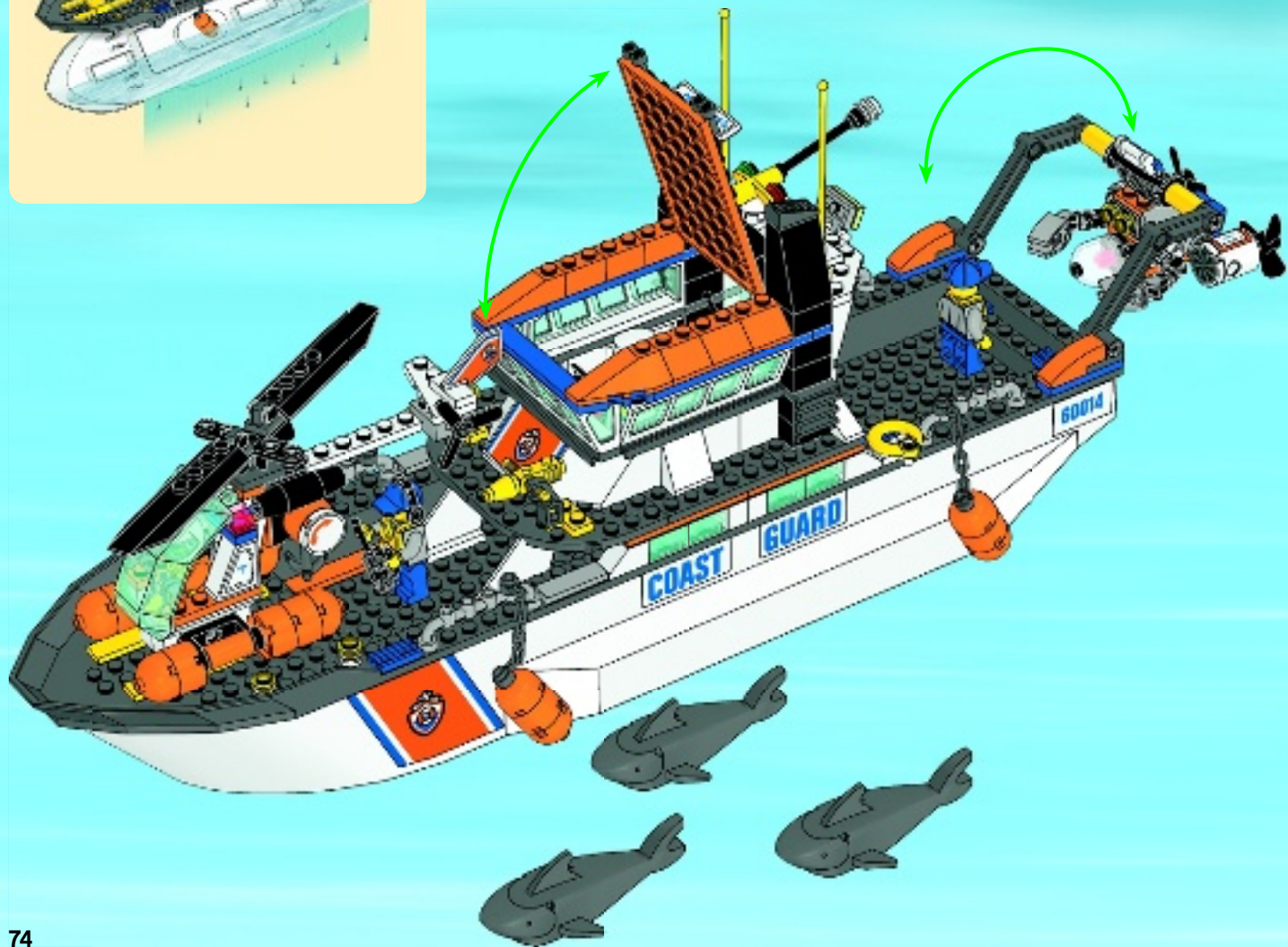



Nintendo



CITY

UNDERCOVER





CITY

LEGO.com

LEGO and the LEGO logo are trademarks of the LEGO Group. ©2013 The LEGO Group. 6075297



60004



60003



60002



60001



60000