



Mixels™

41546

FORX



6126506

1



2

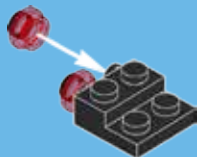

3

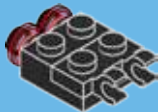

4

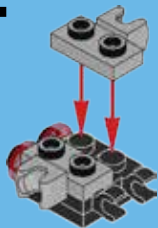

5



6

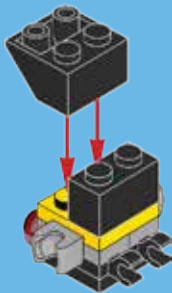

7



8



9



10



11



1



2



2x

12

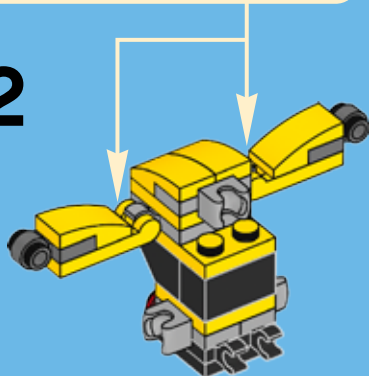

13

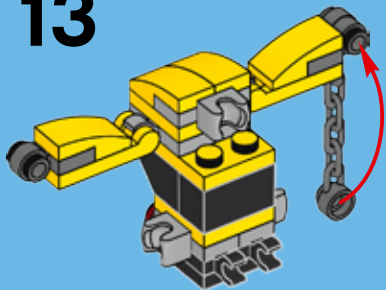

14



15



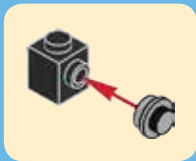

16



17



18

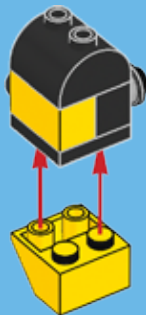

19



20

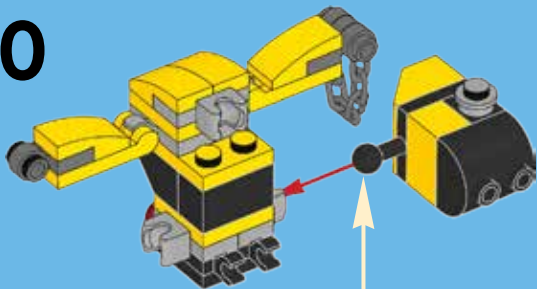



21

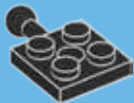

22



23

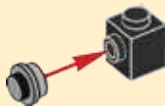

24



25

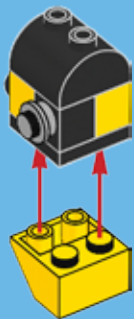

26



27

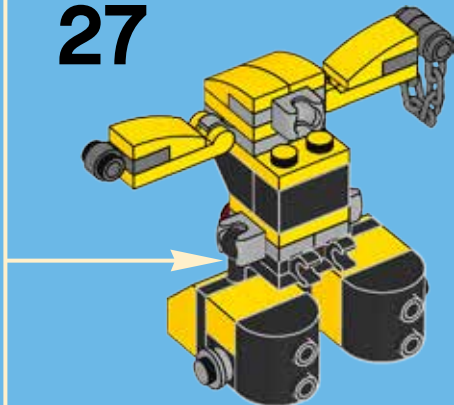



28

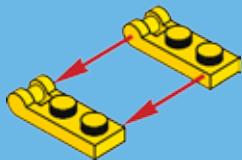

29



30

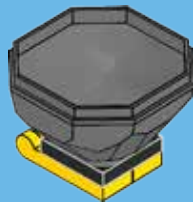

31

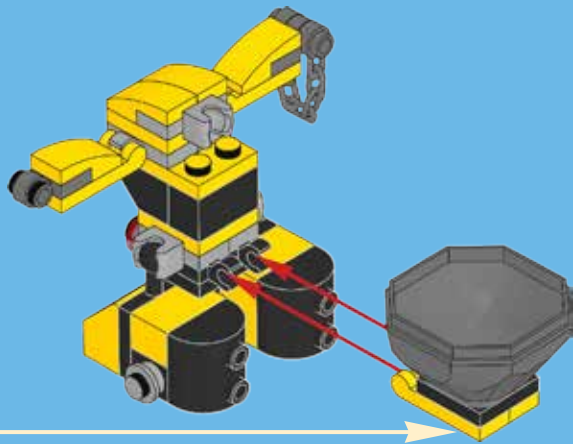



32



33



34



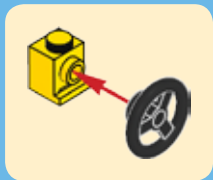

35



36



37



38



39



40

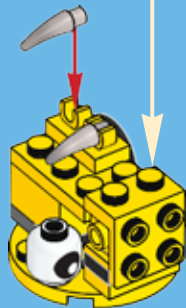

41

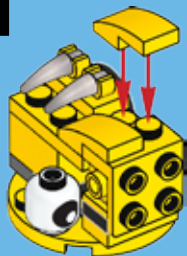

42

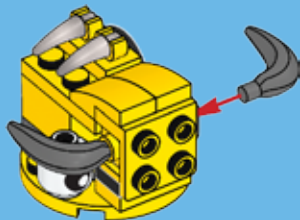

43

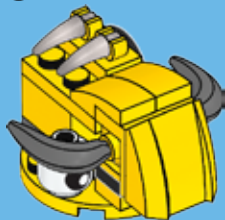

44



45

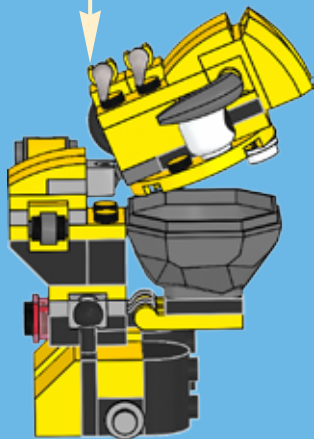

46





2x
614101



3x
6043656



3x
235724



2x
302124



2x
6071270



1x
300426



2x
4632574



2x
6060802



2x
6028812



3x
407024



1x
6117938



2x
302224



1x
366026



1x
6039479



2x
3005741



2x
4211525



2x
366024



4x
4515367



2x
4558954



2x
4200023



2x
6109672



2x
4612901



1x
4540203



6x
6029947



1x
4515349



2x
302326



1x
6057397



1x
302324



1x
4144412



1x
4556158



1x
368026



1x
4600437



Customer Service

Kundenservice

Service Consommateurs

Servicio Al Consumidor

LEGO.com/service or dial



00800 5346 5555 :



1-800-422-5346 :



1x
6052126



2x
6051038



1x
4506779



**KRAMM
41545**



**FORX
41546**



**WUZZO
41547**



WELDOS MAX!



LEGO.com/mixels





Mixels™

SERIES
6



41545
KRAMM



41546
FORX



41547
WUZZO



41548
DRIBBAL



41549
GURGGLE



41550
SLUSHO



41551
SNAX



41552
BERP



41553
VAKA-WAKA



LEGO.com/mixels



Mixels RUSH



**YOU CAN
BUY THE
GAME!**

D E M O L I T I O N

IN GAME CODE!



Apple, the Apple logo, iPad, iPhone and iPod touch are trademarks of Apple Inc., registered in the U.S. and other countries. App Store is a service mark of Apple Inc. Google Play is a trademark of Google Inc.