



Friends™



41123





1

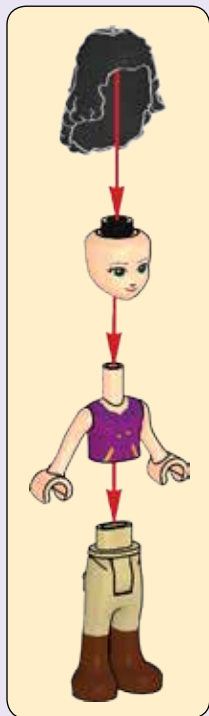

2



1x

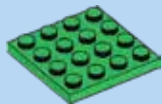

1x

1



1x

2

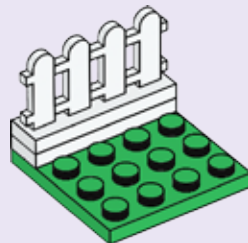



3

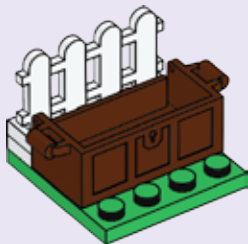

4



4

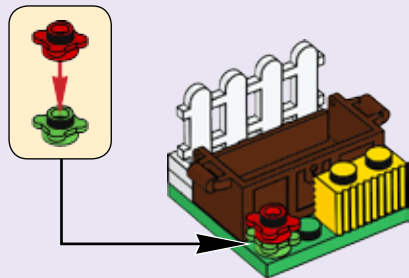



5

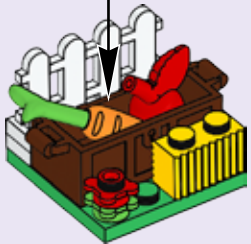
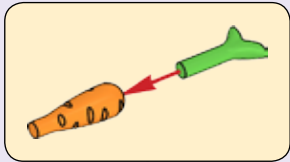



1x

6



6



4x

7

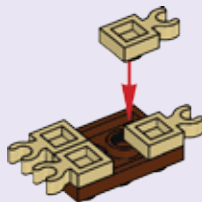



2x

8

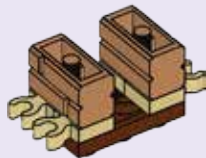

9

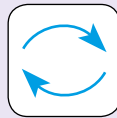
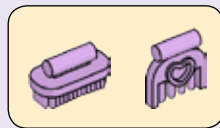



10

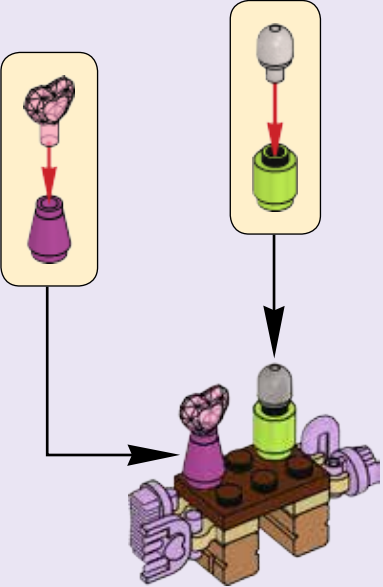

11

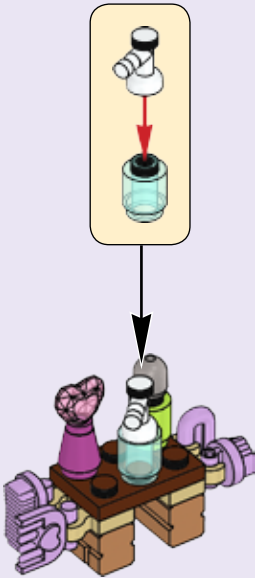



1x

1

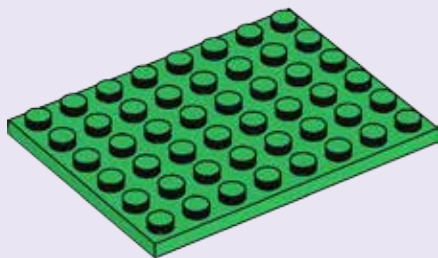



2x

2

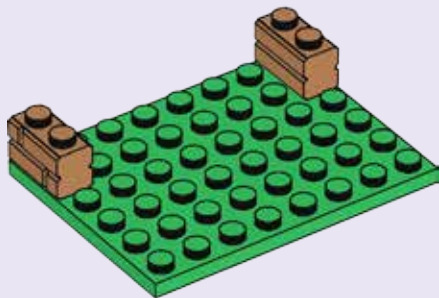

10

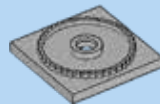

2x

1x

3

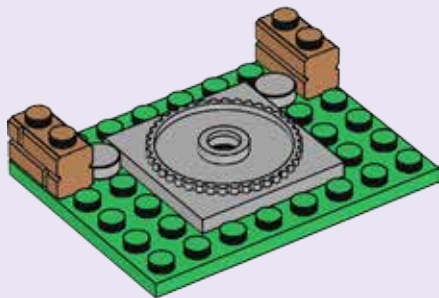



4

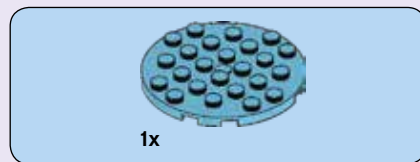
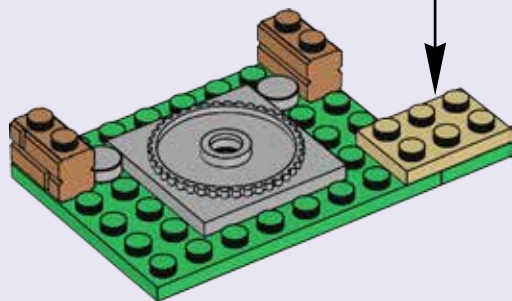

5

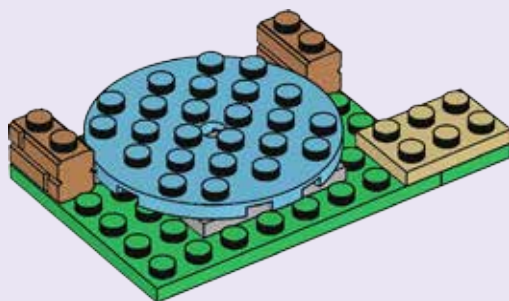



2x

6

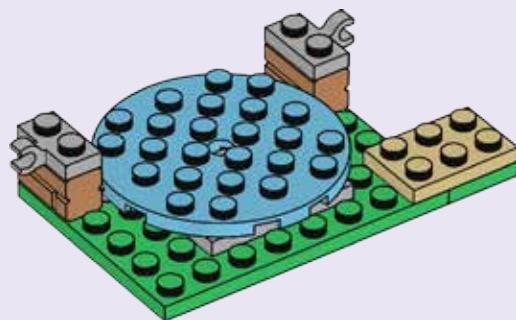



7

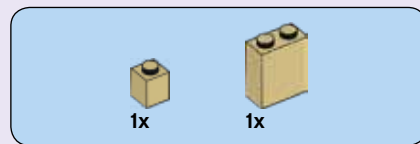
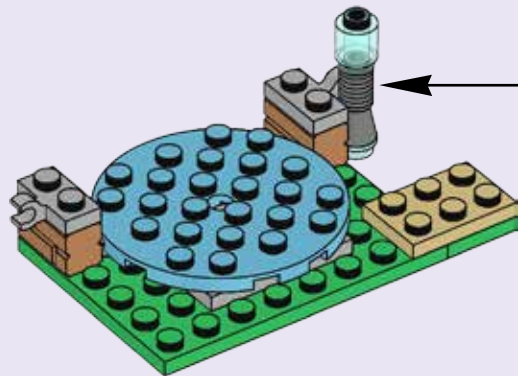
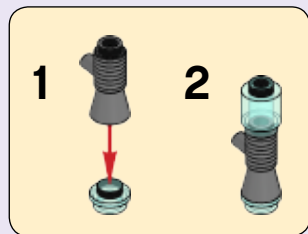

8

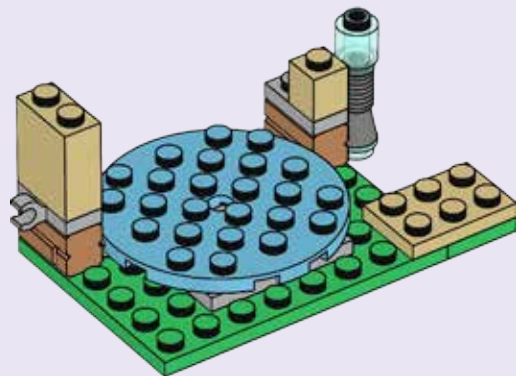

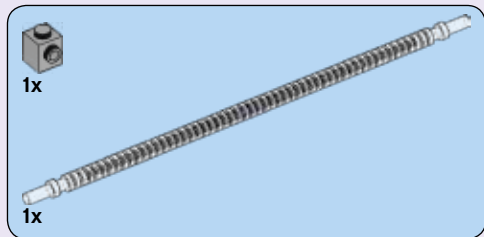

9

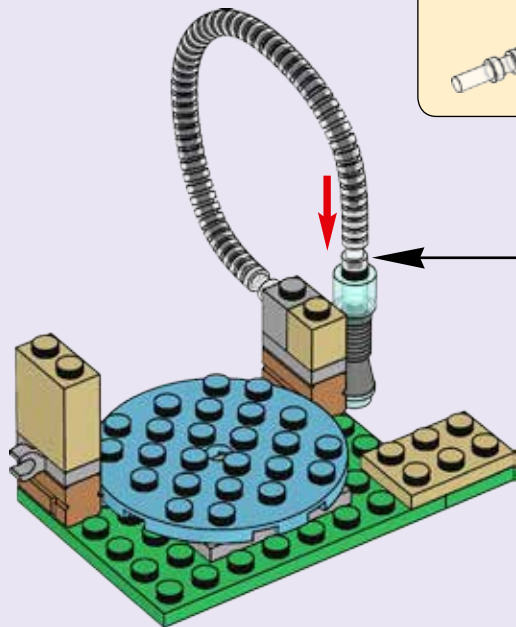
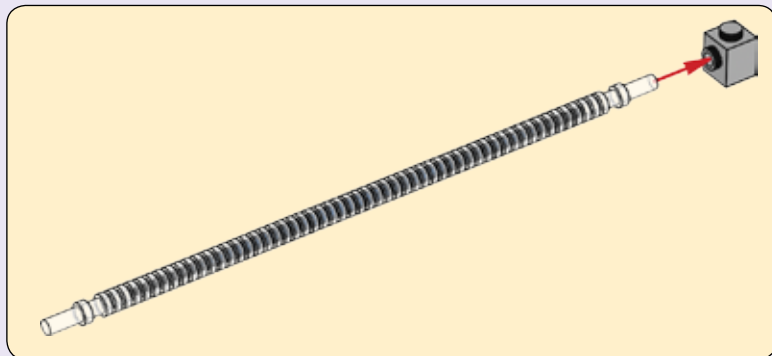

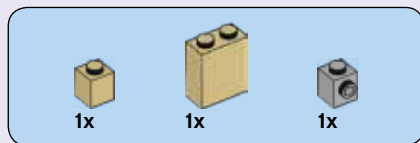

10

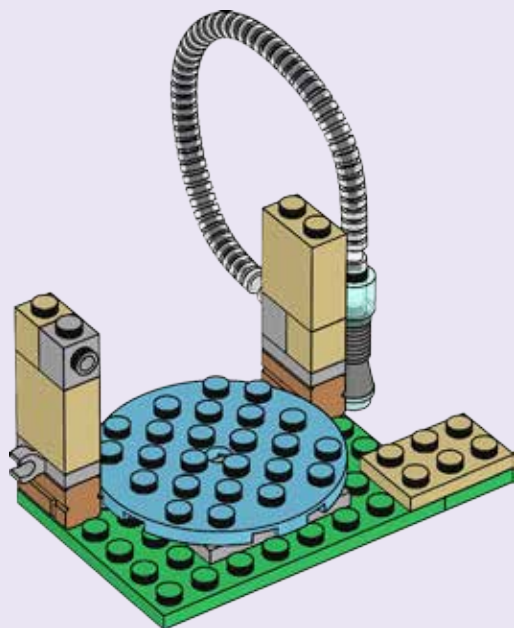

11

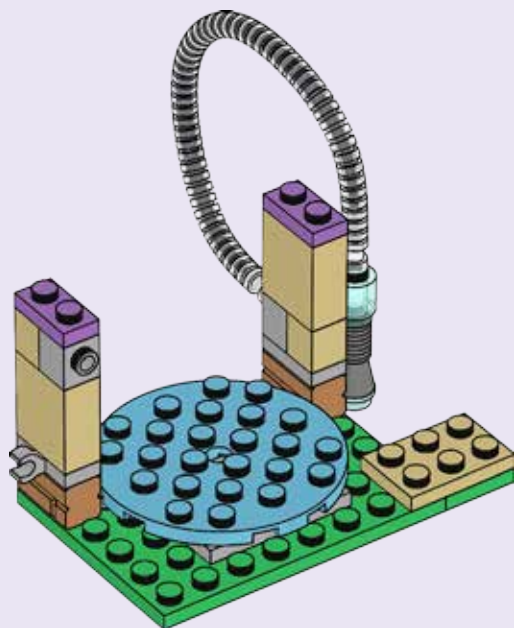

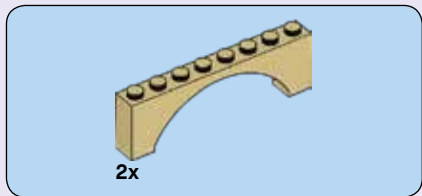

12

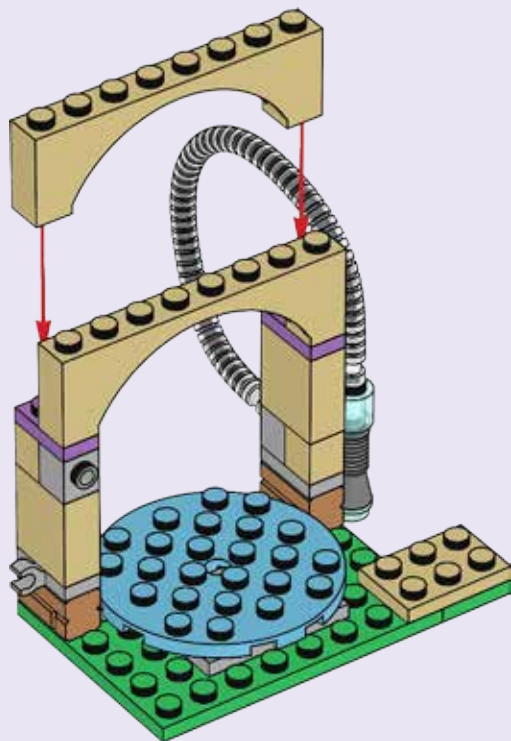



13

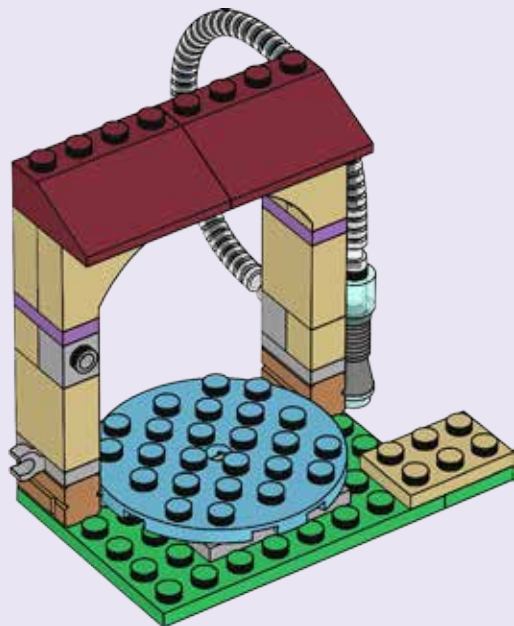

14

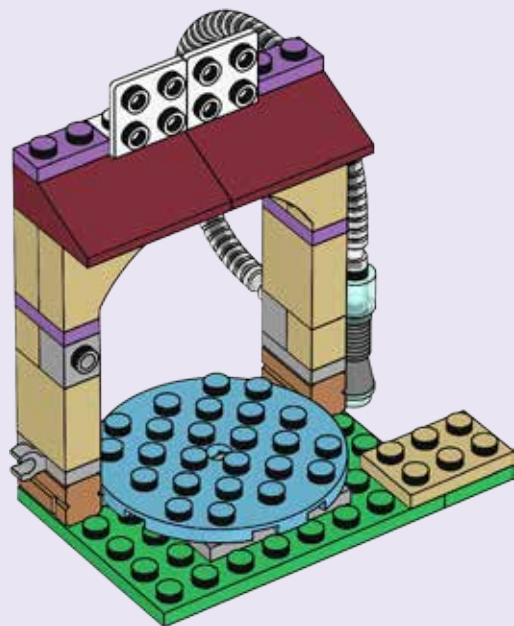

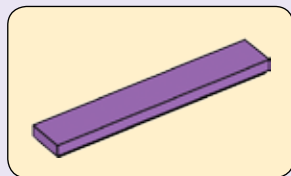
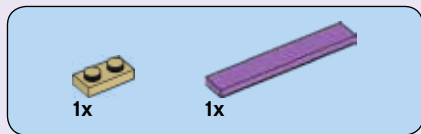

15

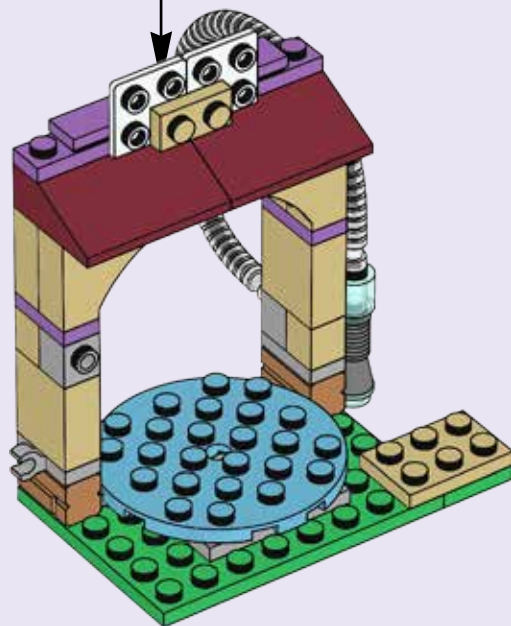

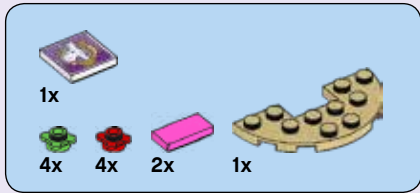

16

1

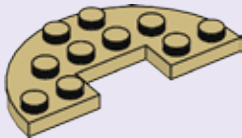

2



3

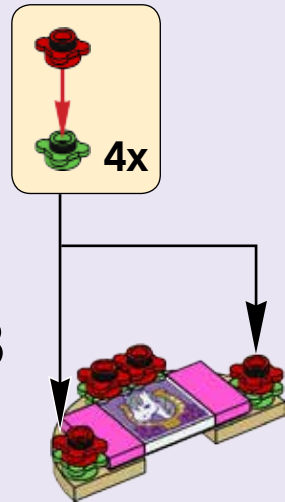

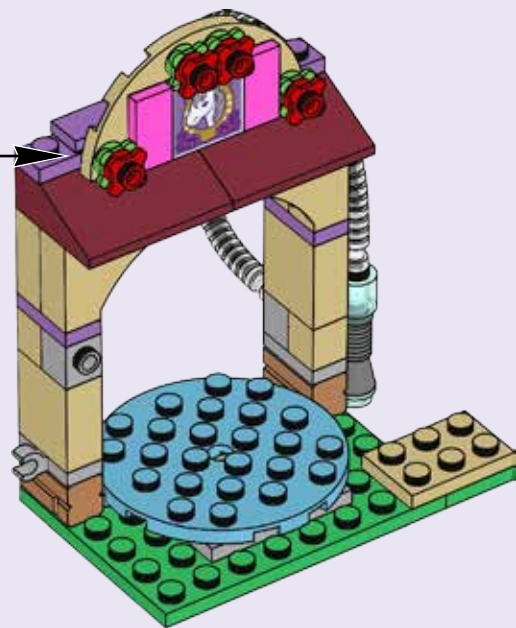



1x



1x



1x

17

1

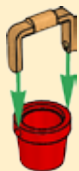

2

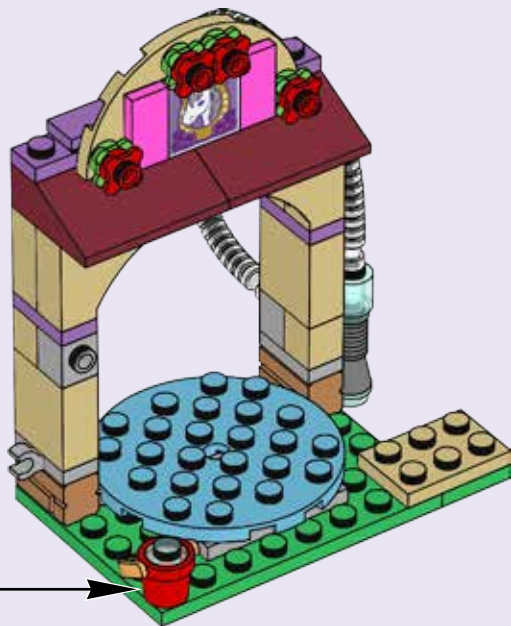

18

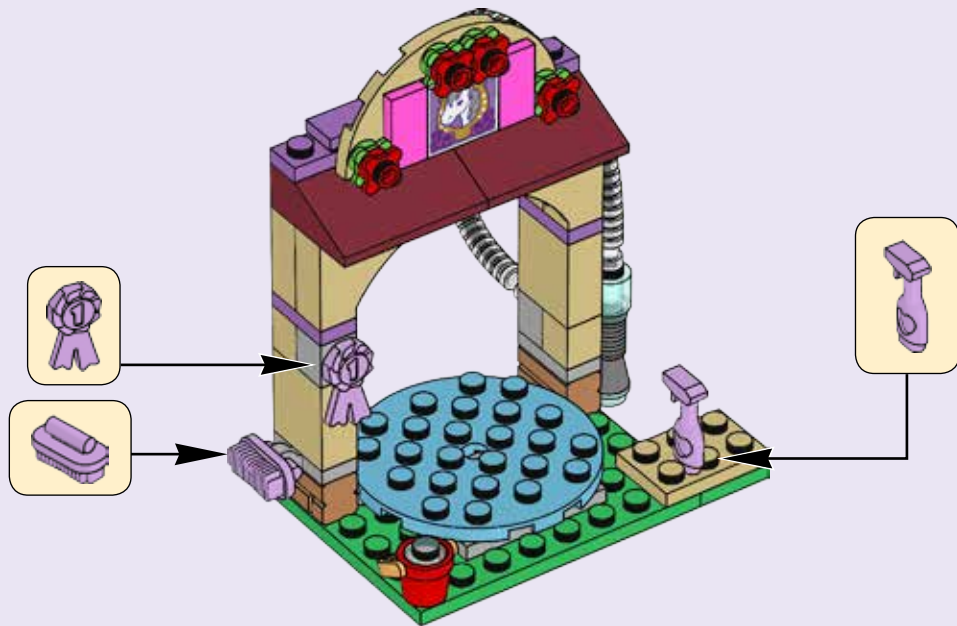

19





Friends™



41123



41125



41126



41124



41118



41119





Customer Service

Kundenservice

Service Consommateurs

Servicio Al Consumidor

LEGO.com/service or dial



: 00800 5346 5555

: 1-800-422-5346



Friends™

41125



41126



41125



41123

41126

 LEGO.com/friends

41123



Friends™



LEGO.com/friends

GET IT ON
 Google play



Download on the
 App Store

Google Play is a trademark of Google Inc.
Apple, the Apple logo and iPad are trademarks of Apple Inc.