



CITY

60119



LEGO.com/city

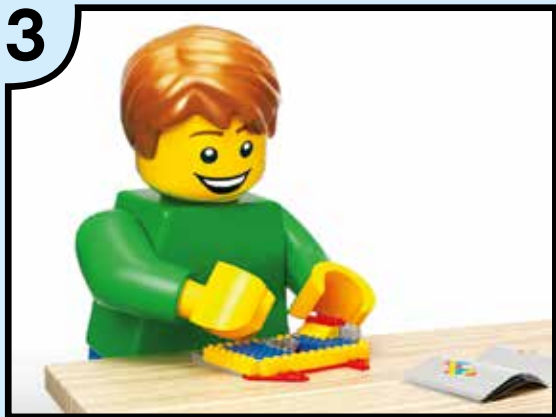



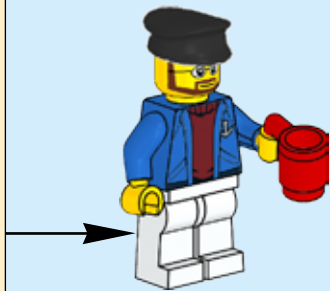
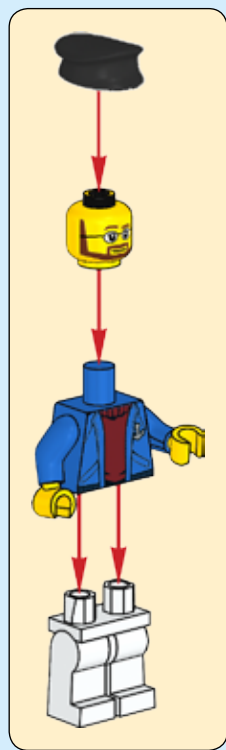

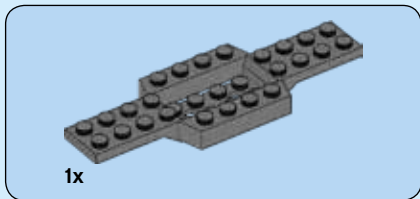

1

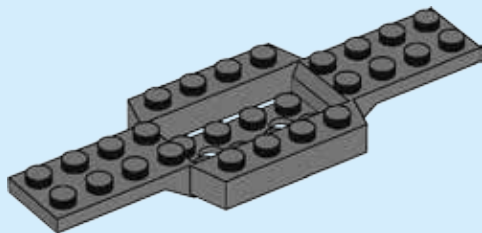

2

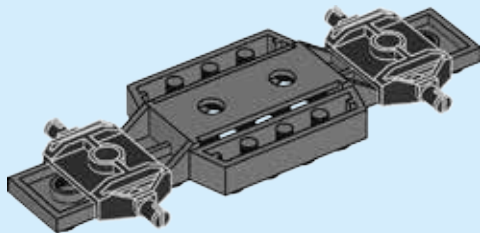
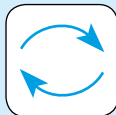

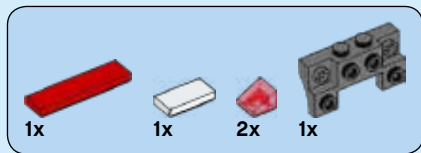

3

1

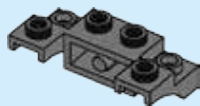

2

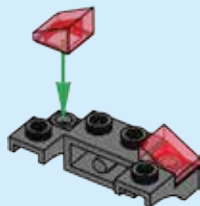

3

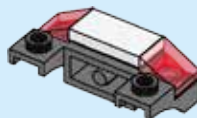

4

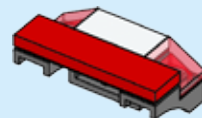

5

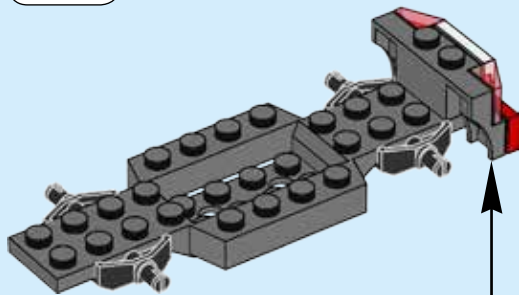
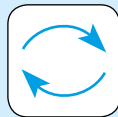
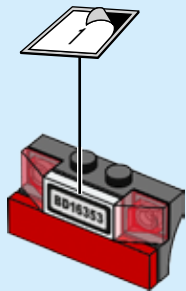



2x

4

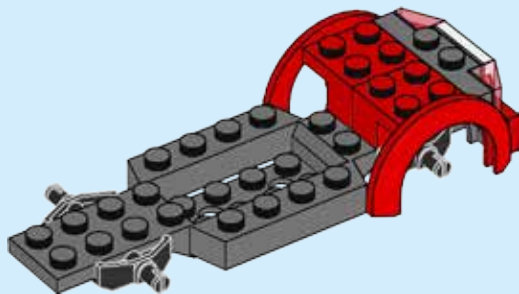

8



1x



1x

5

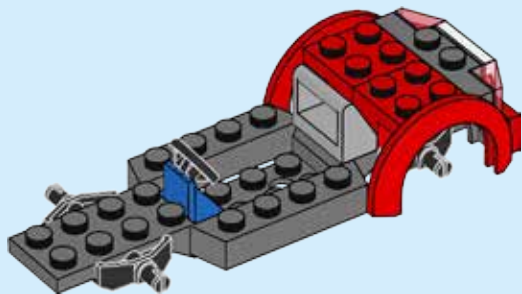

2x

6

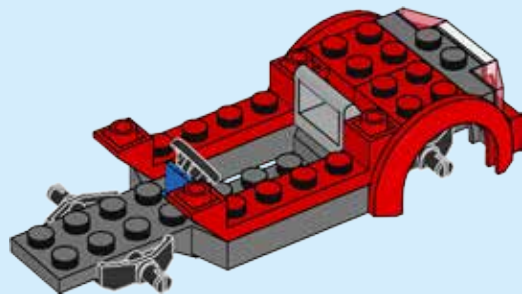



1x

7

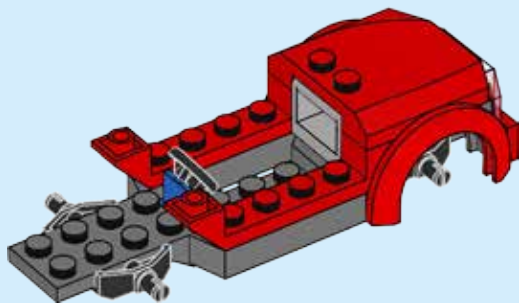



2x

8

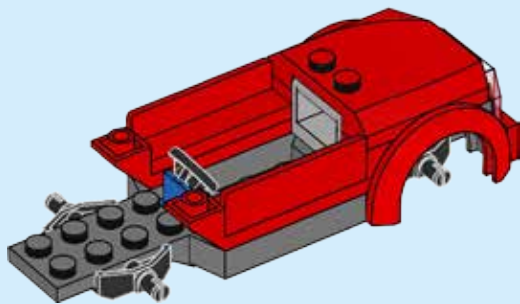



2x

9

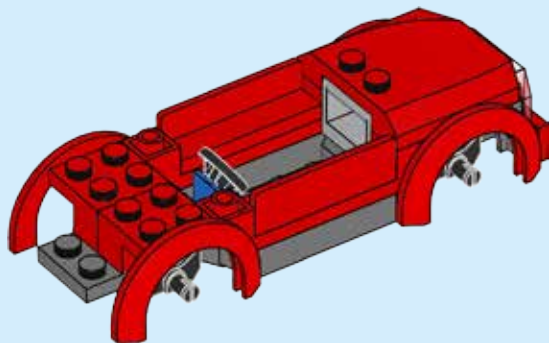

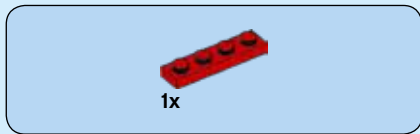

10

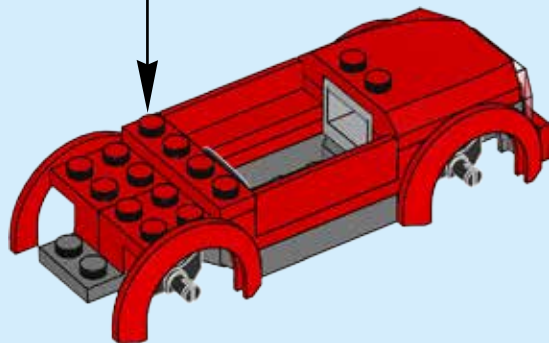
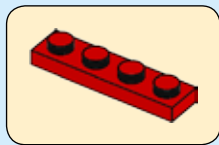

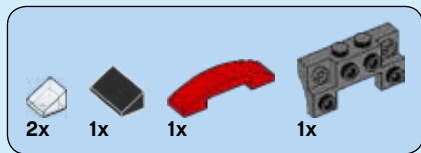

11

1

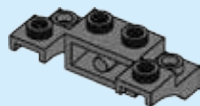

2

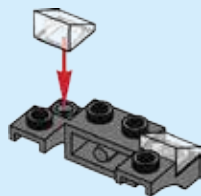

3

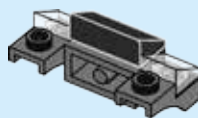

4



5

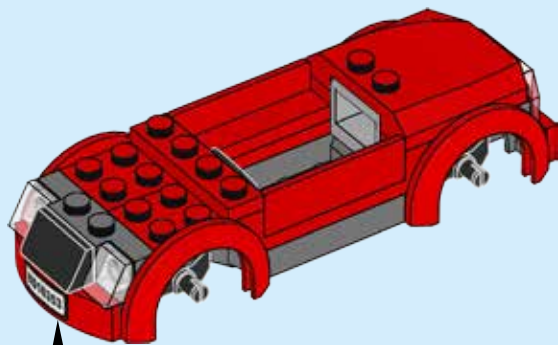
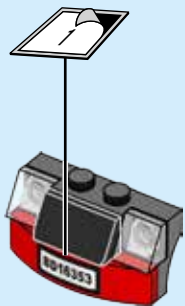



1x

12

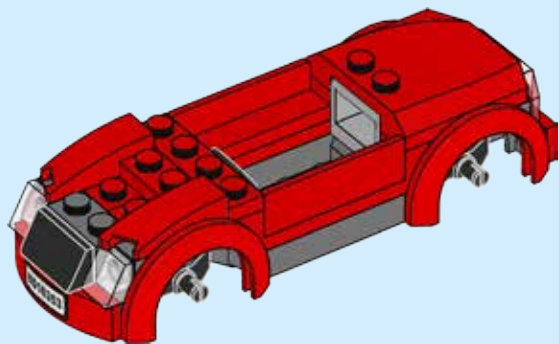



1x



2x

13

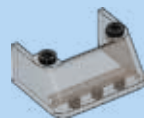
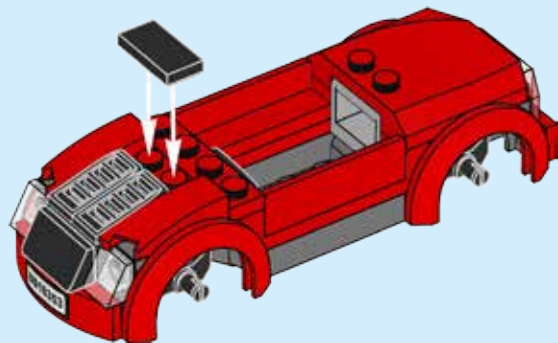

1x

14

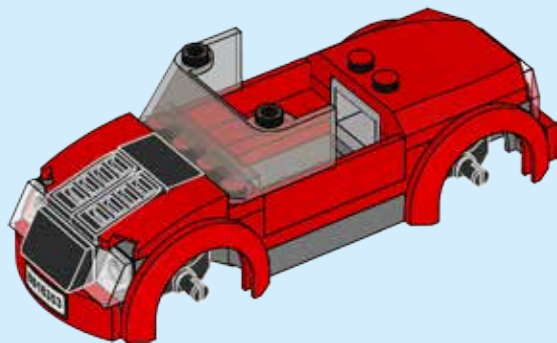

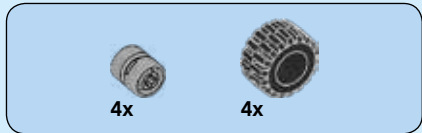

15

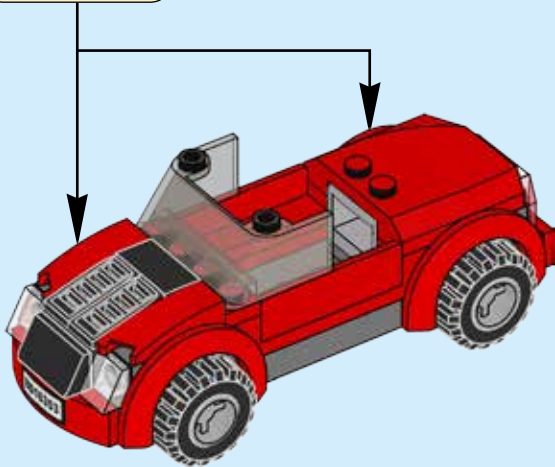
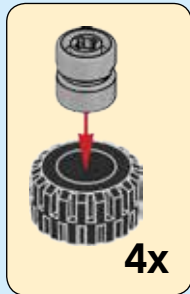

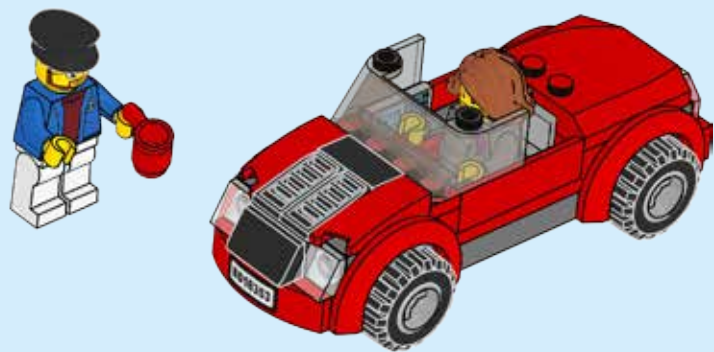



CITY

60119

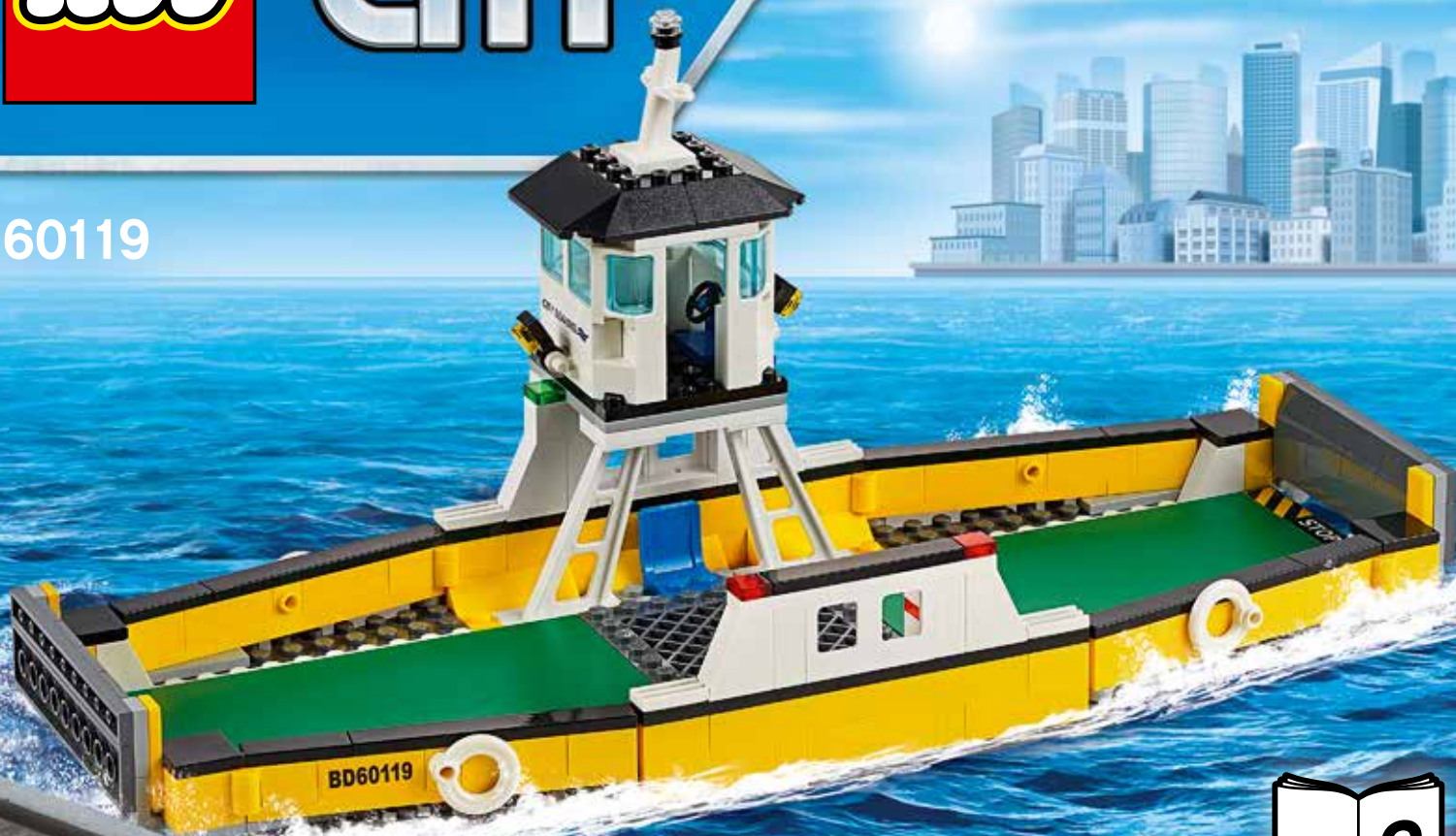

 LEGO.com/city



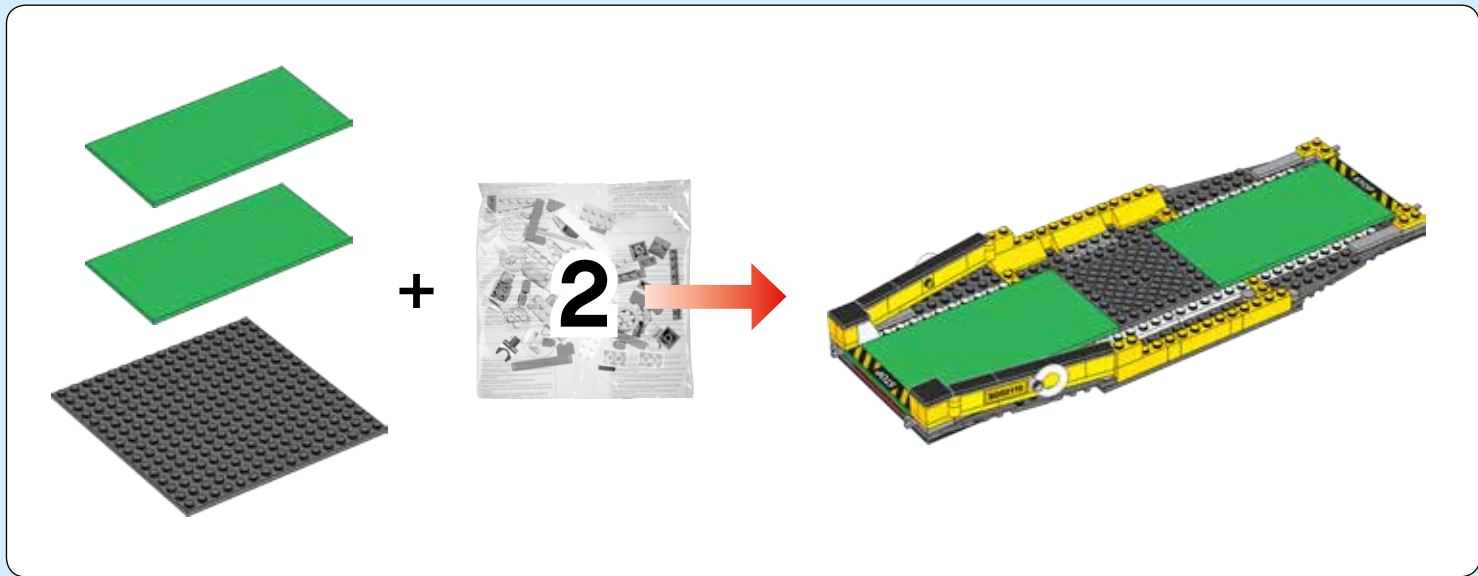



1

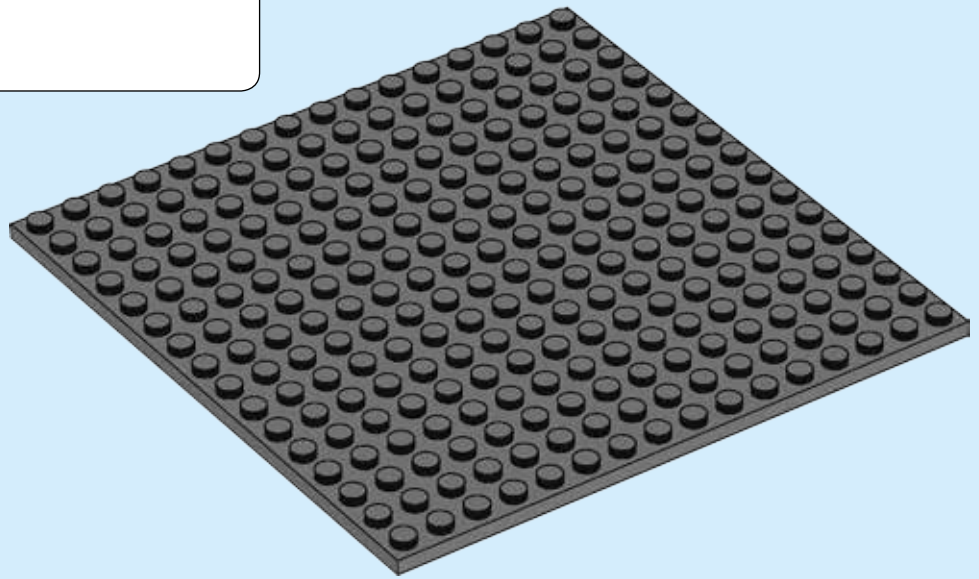

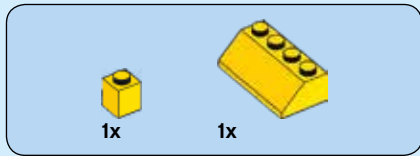

2

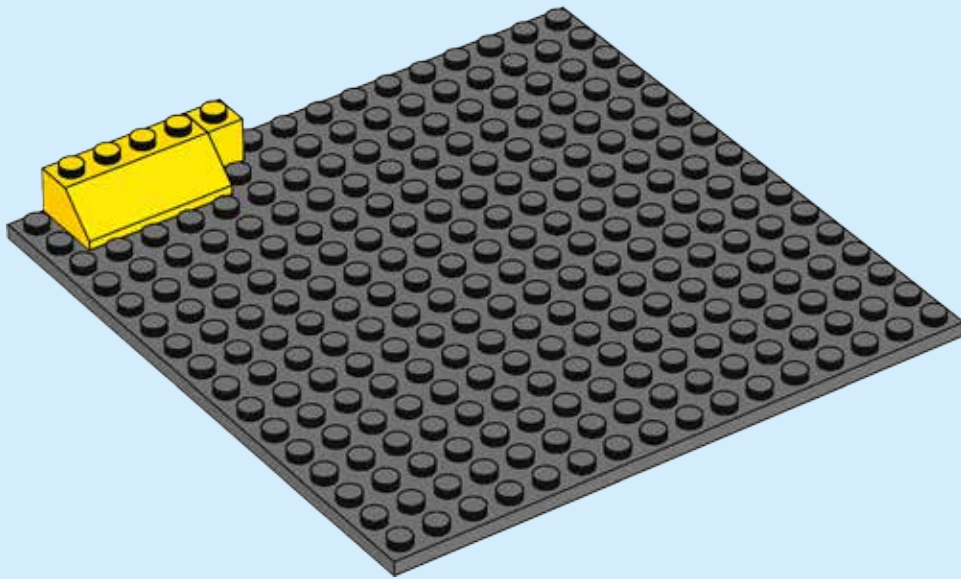

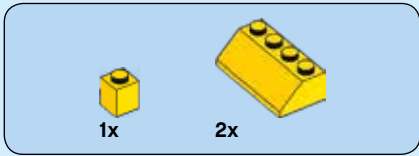

3

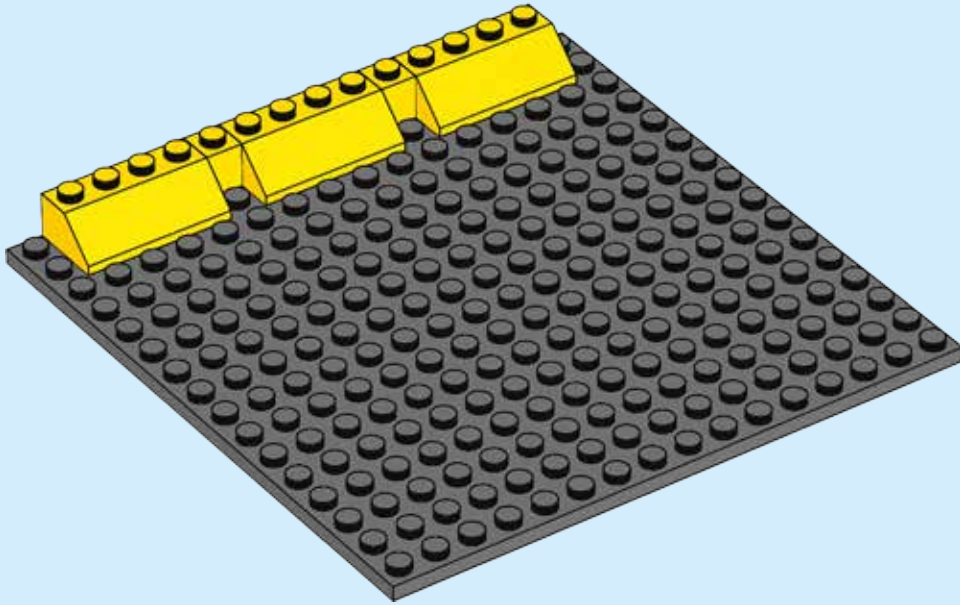



1x

4

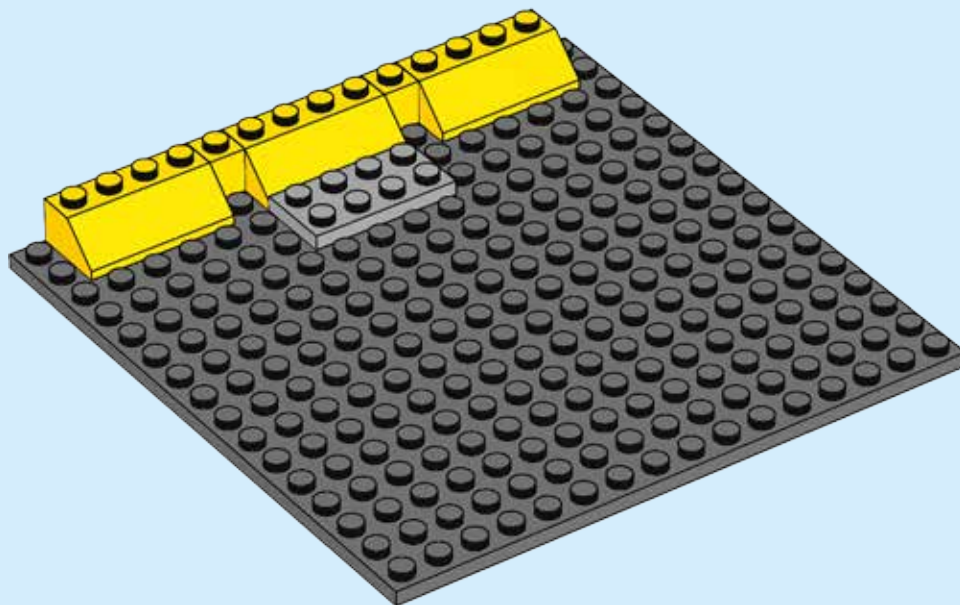

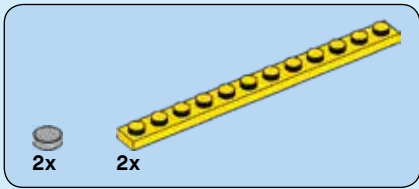

5

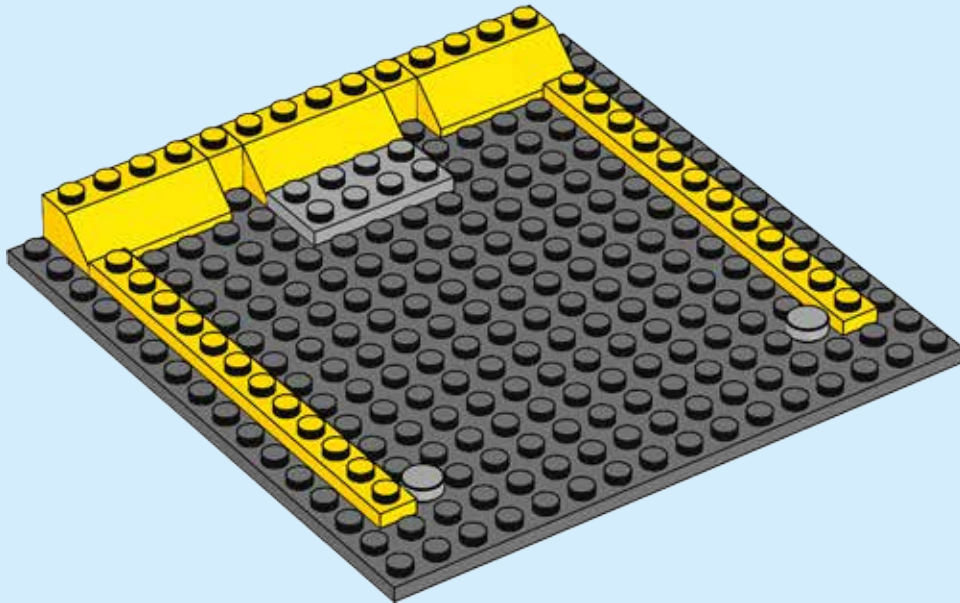

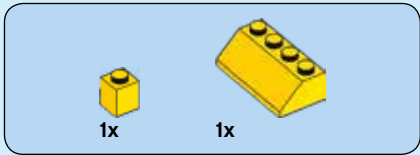

6

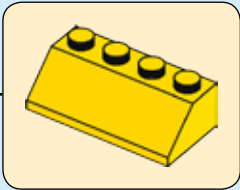
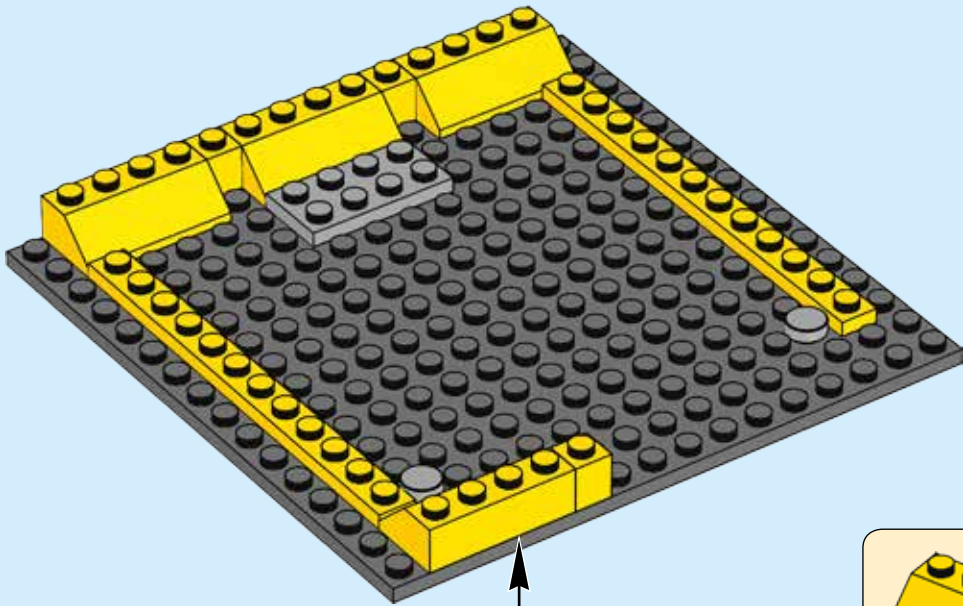

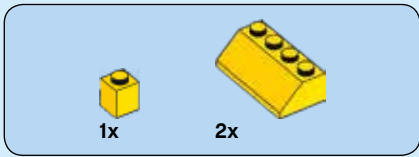

7

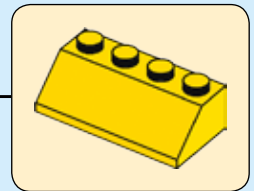
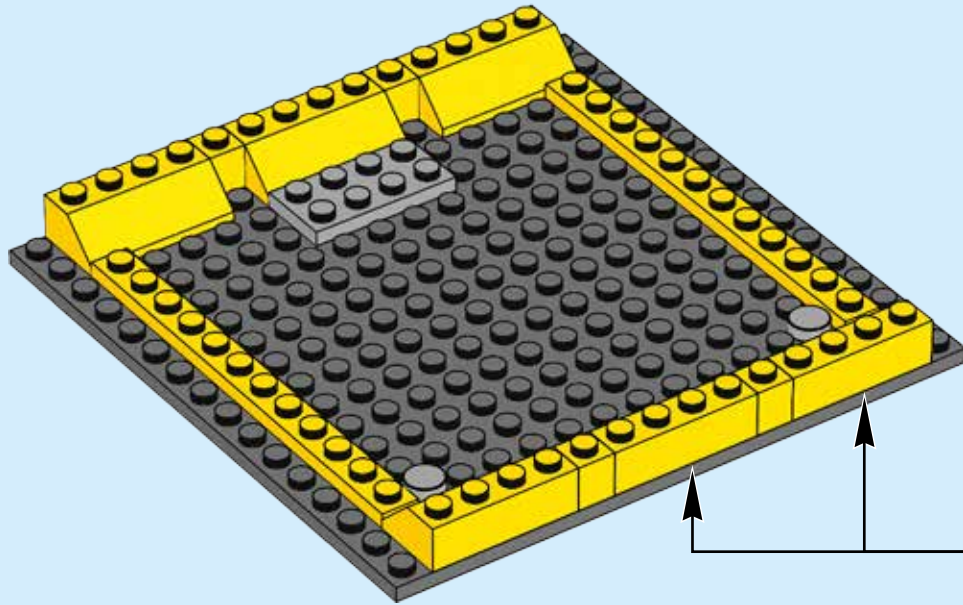

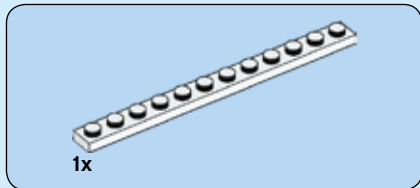

8

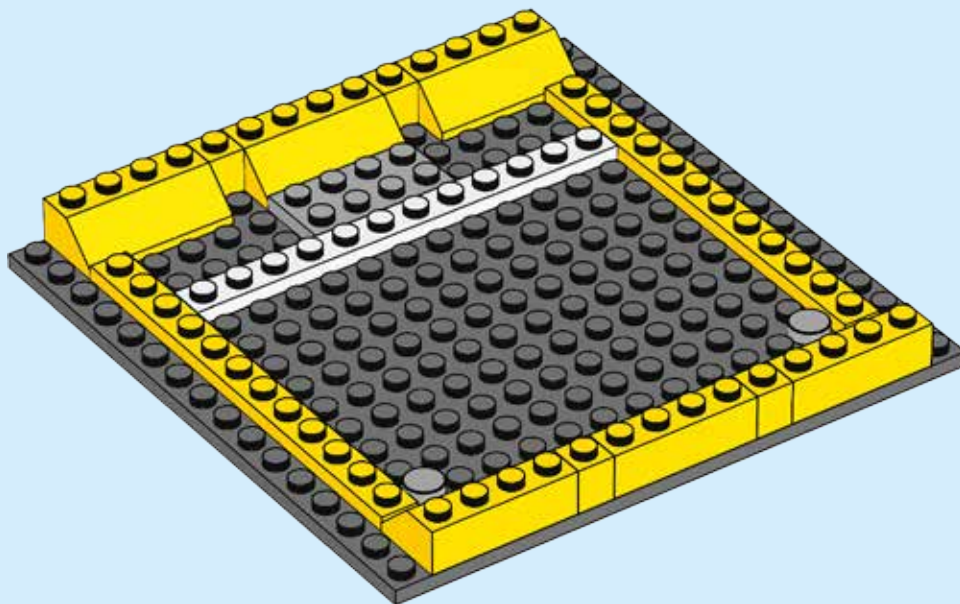

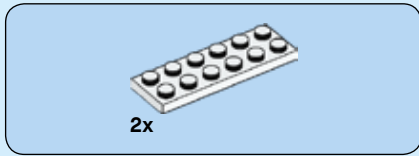

9

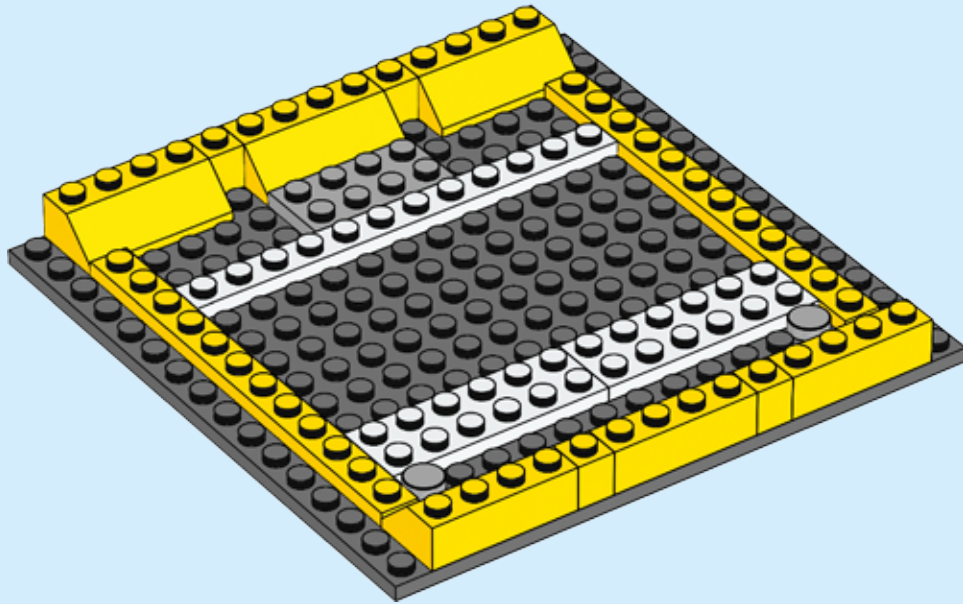

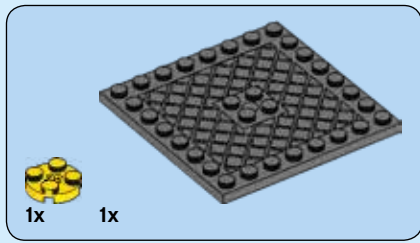

10

1

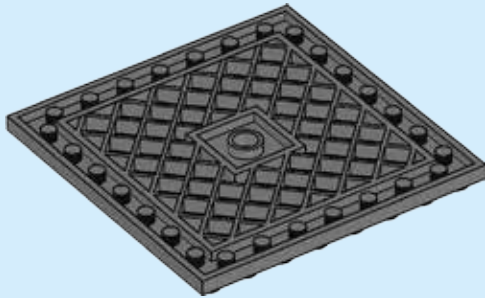

2

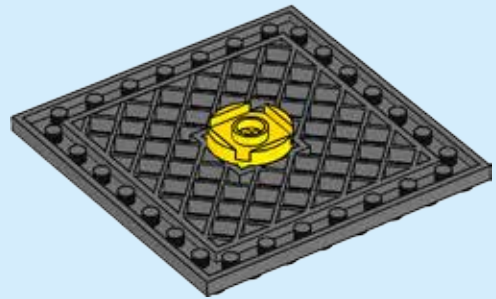

3

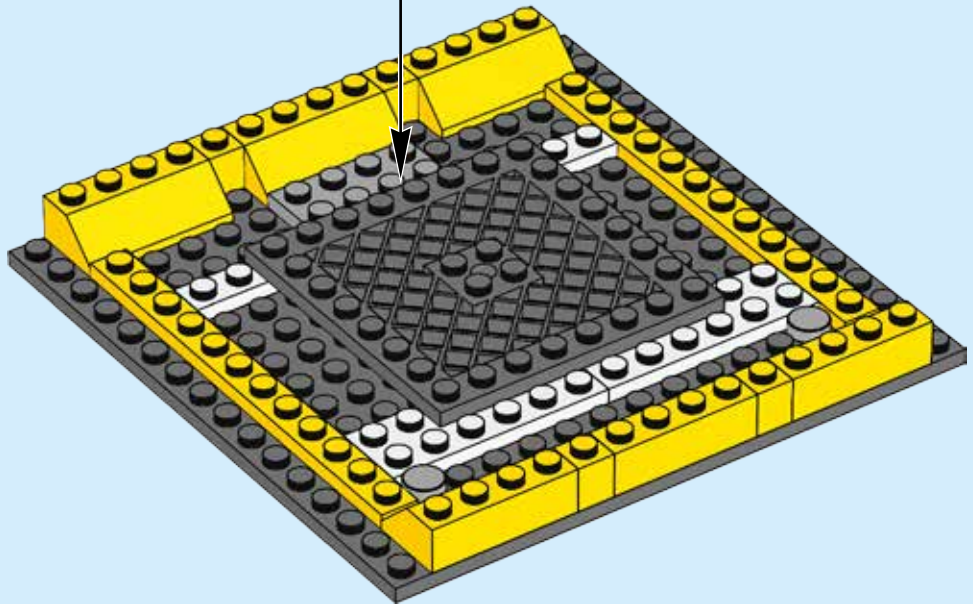
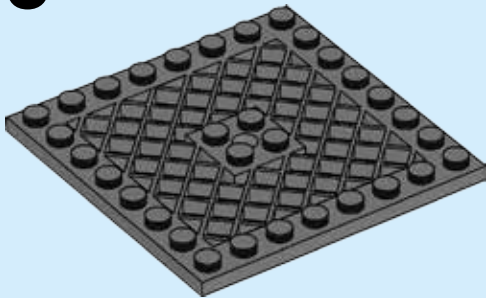
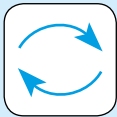

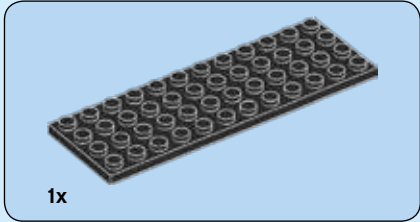
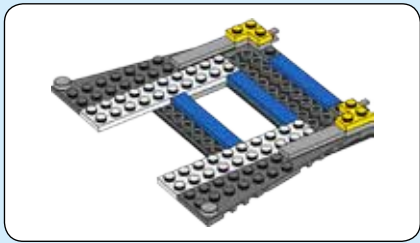

11

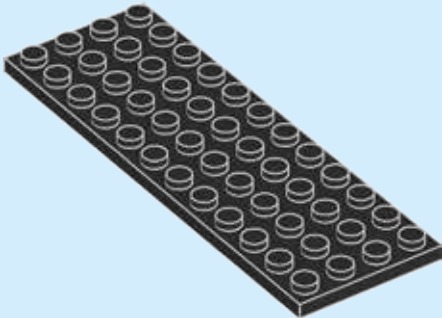

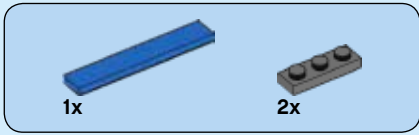

12

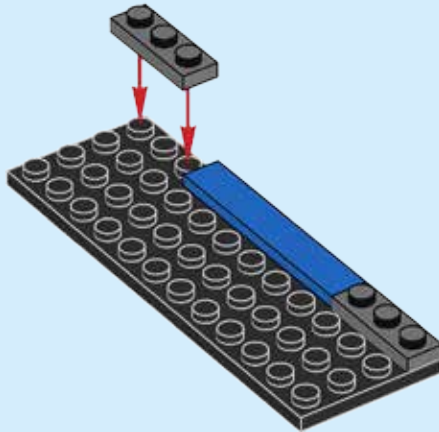

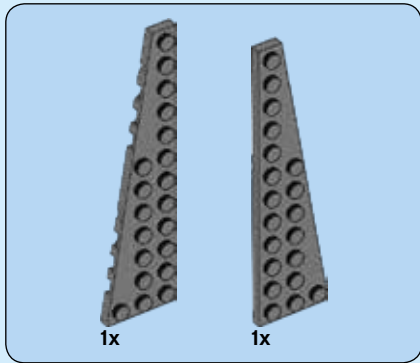

13

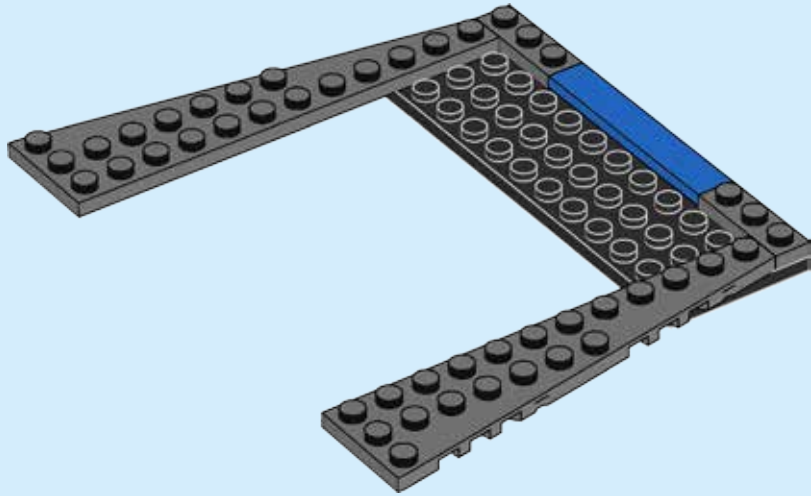

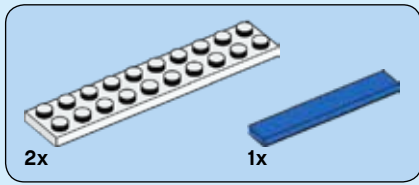

14

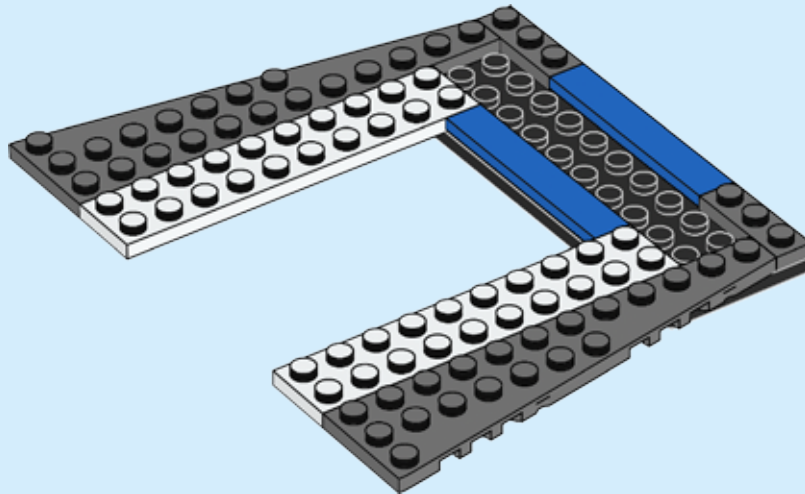

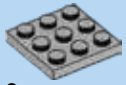

2x

15

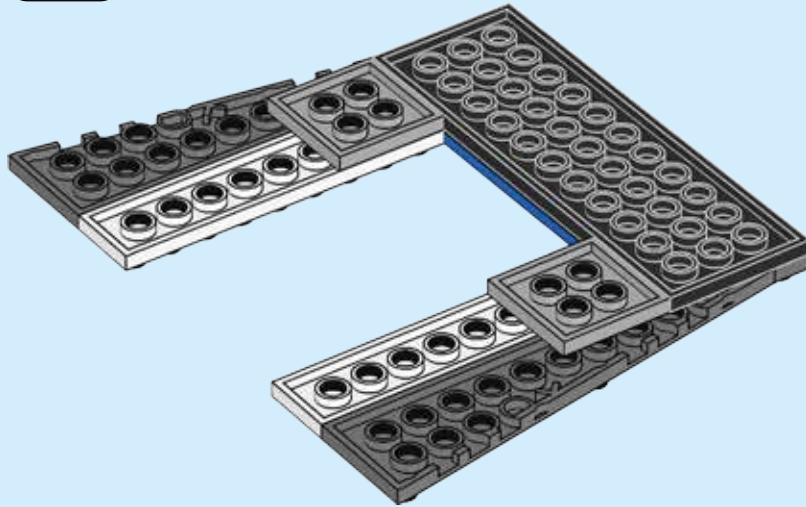
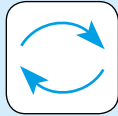

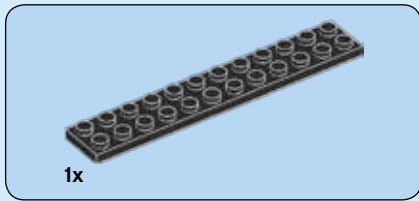

16

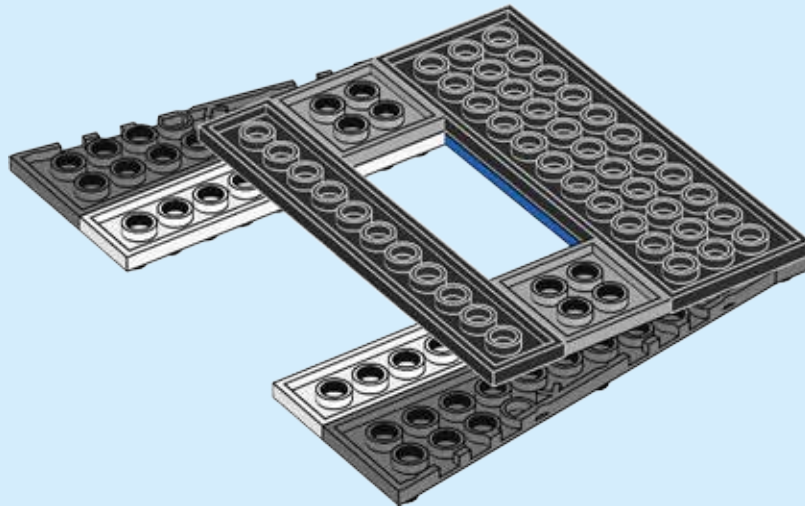

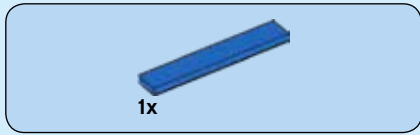

17

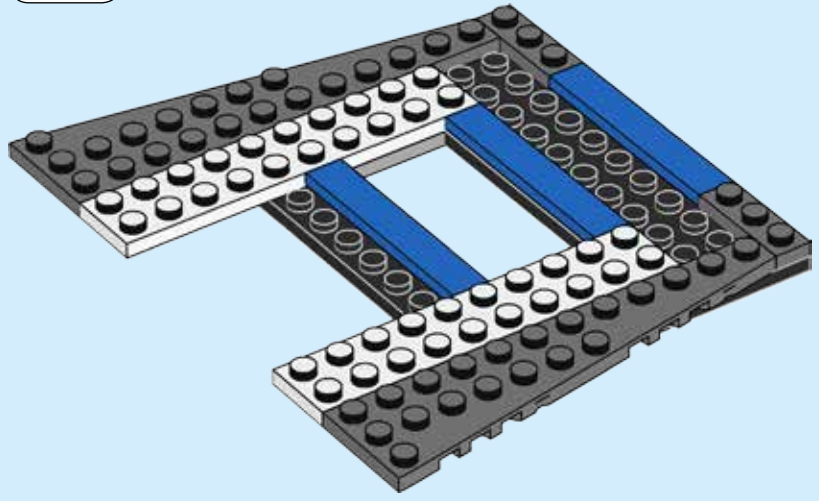
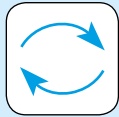

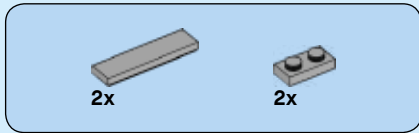

18

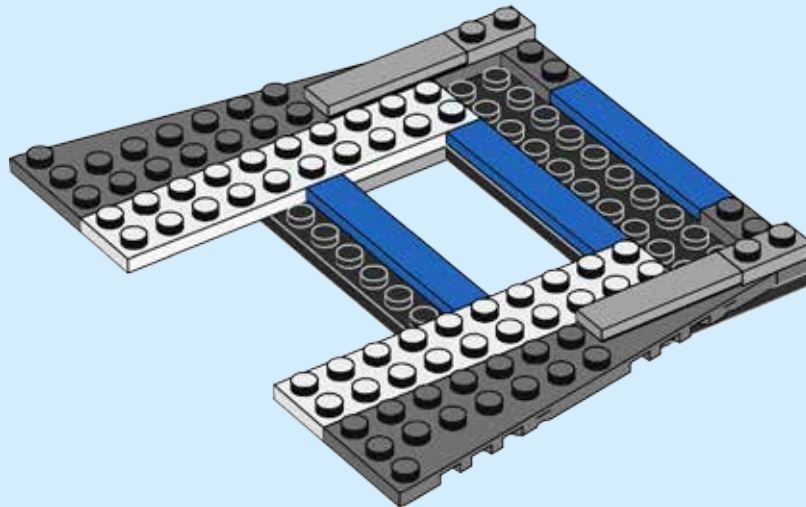



2x

19

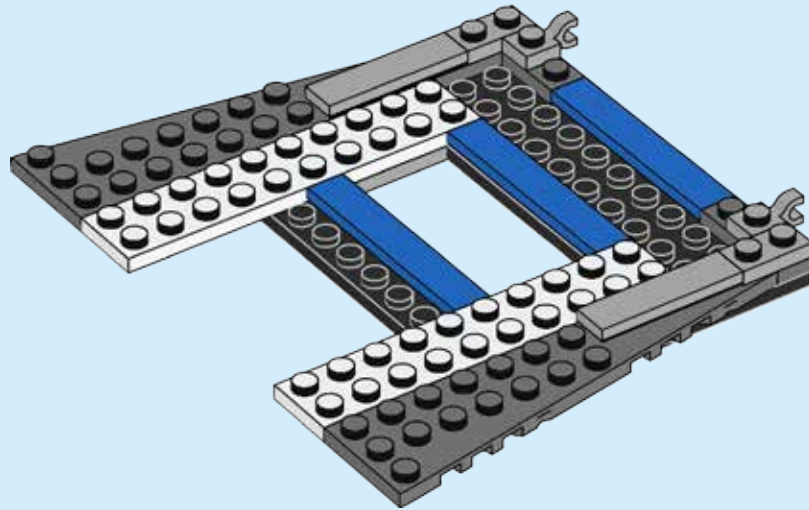



2x



2x

20

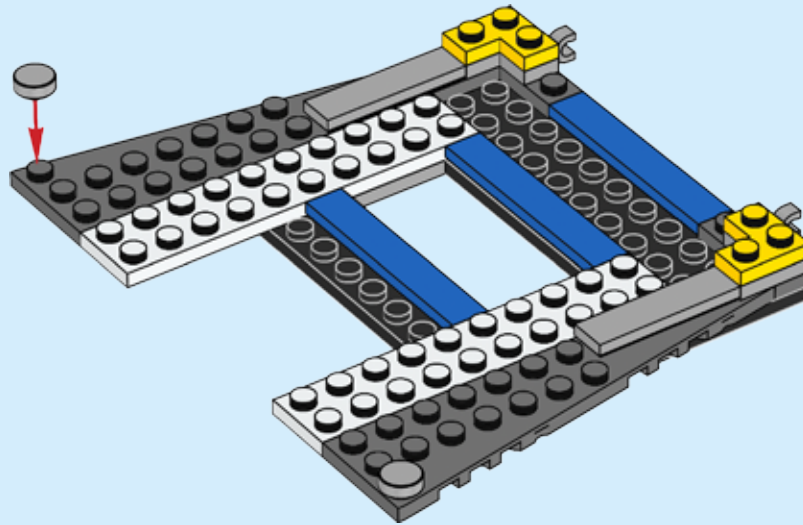

21

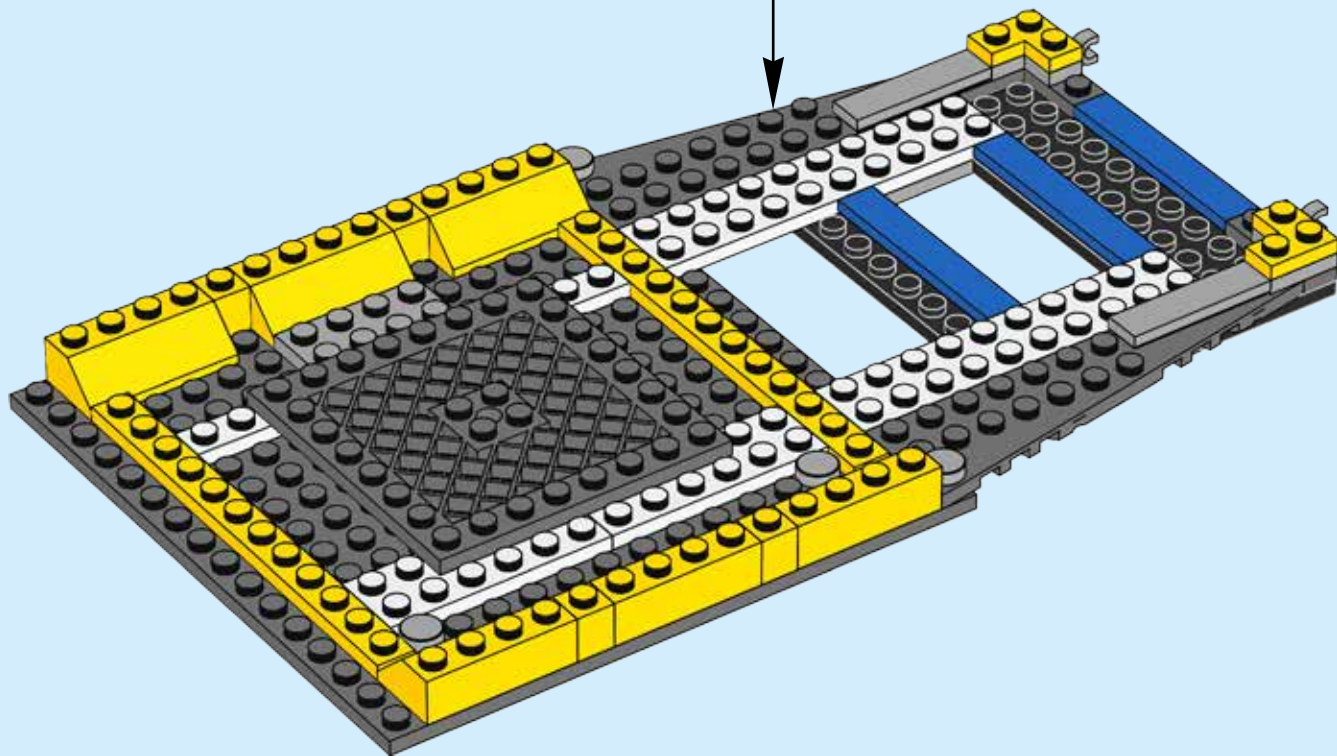

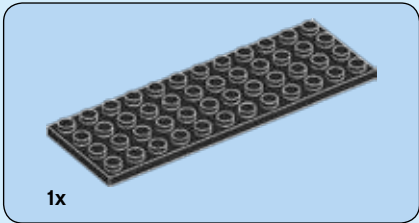
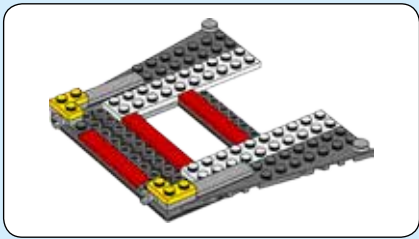

1x

22

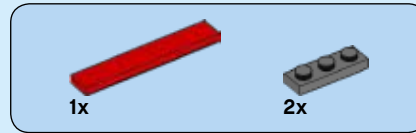
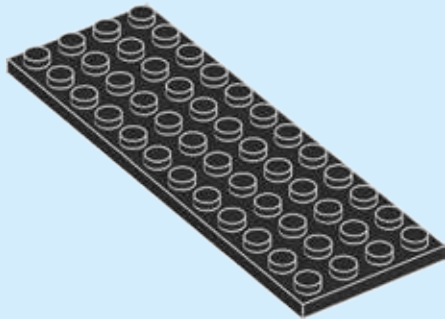

23

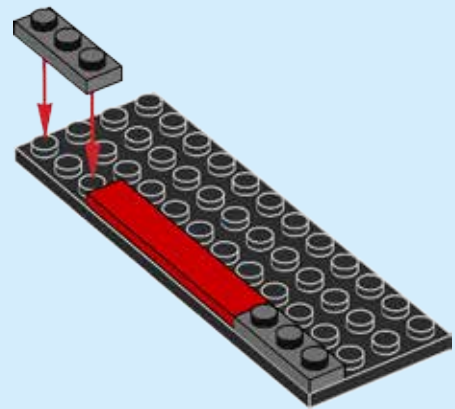

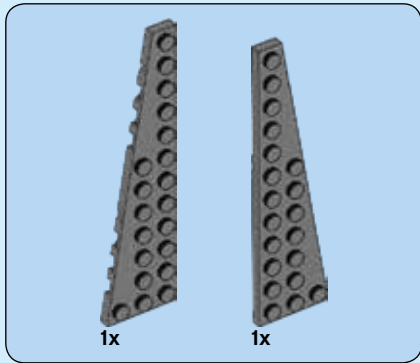

24

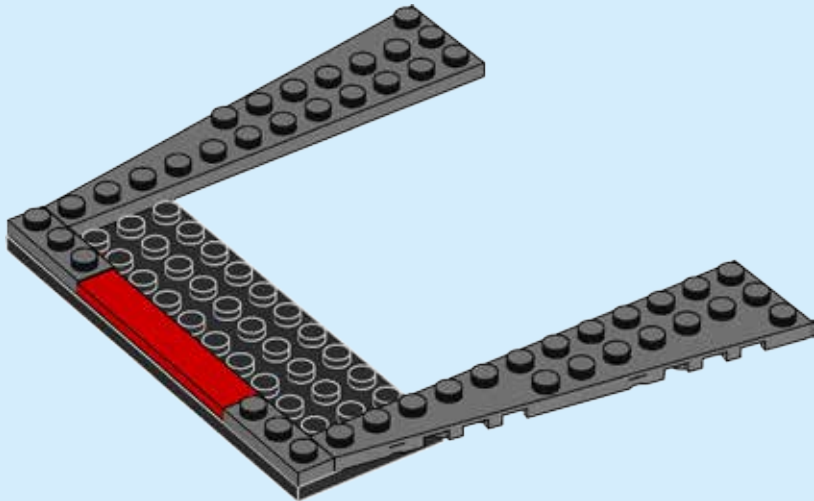

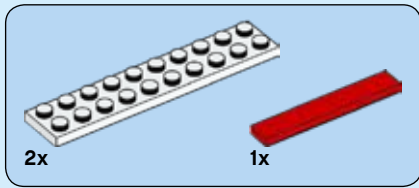

25

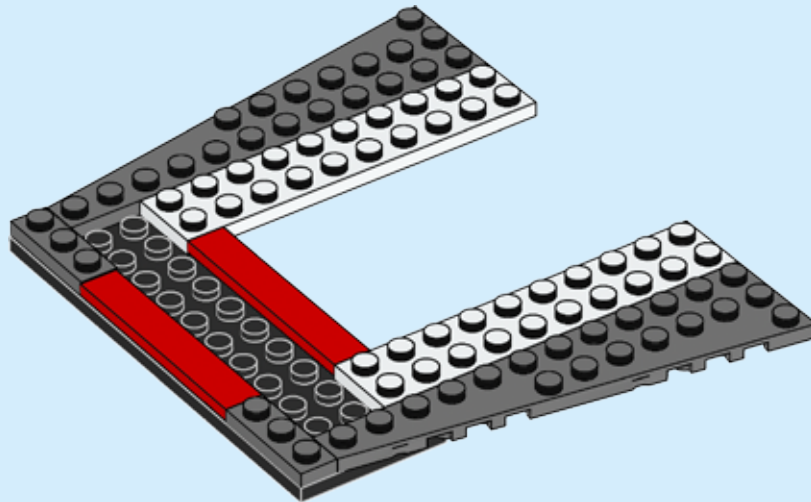

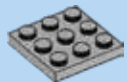

2x

26

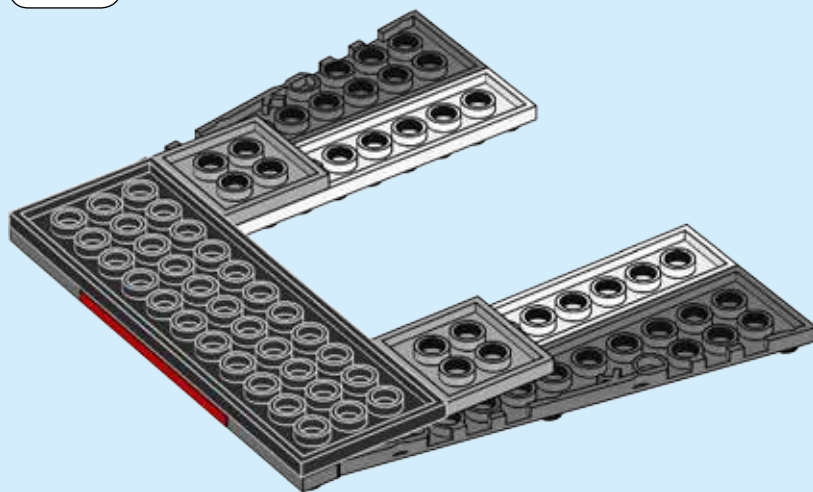
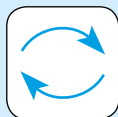

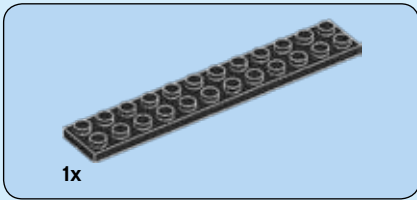

27

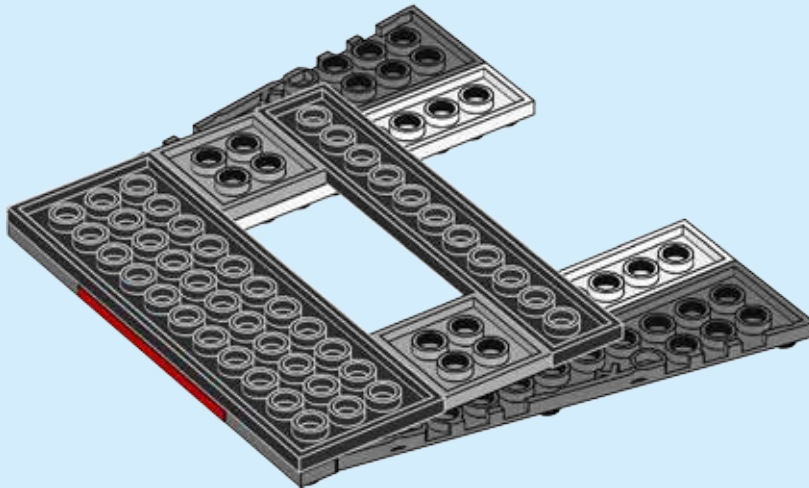

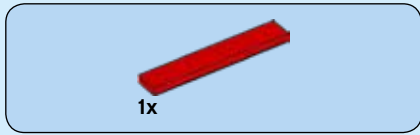

28

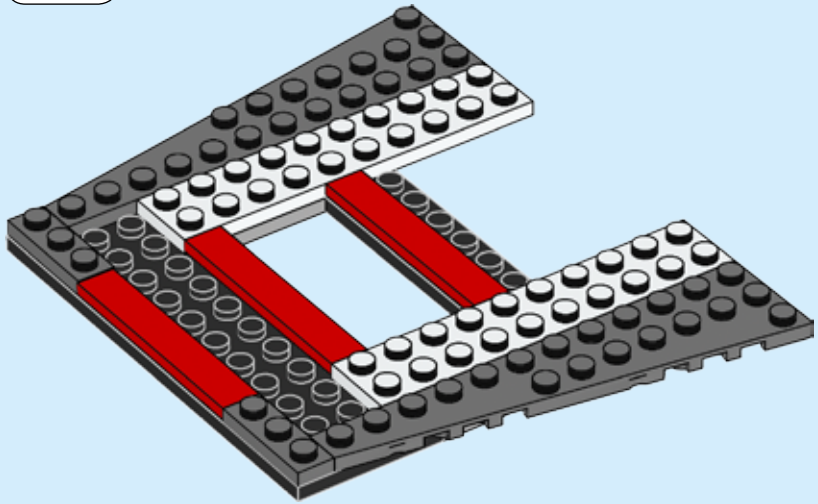
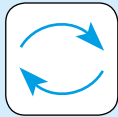

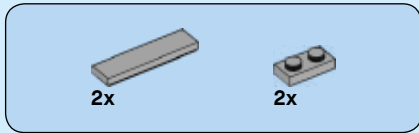

29

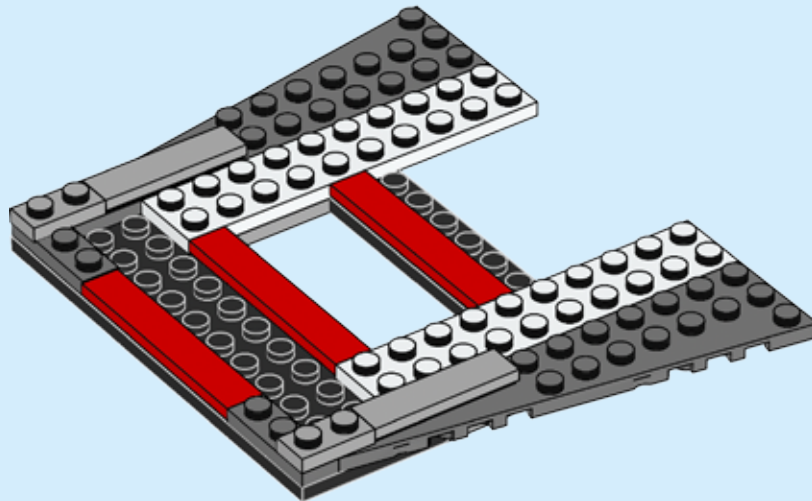



2x

30

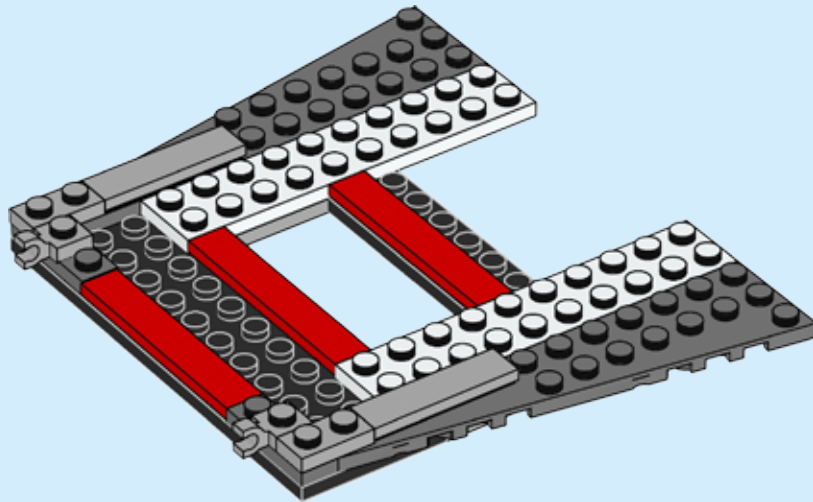



2x

33



2x

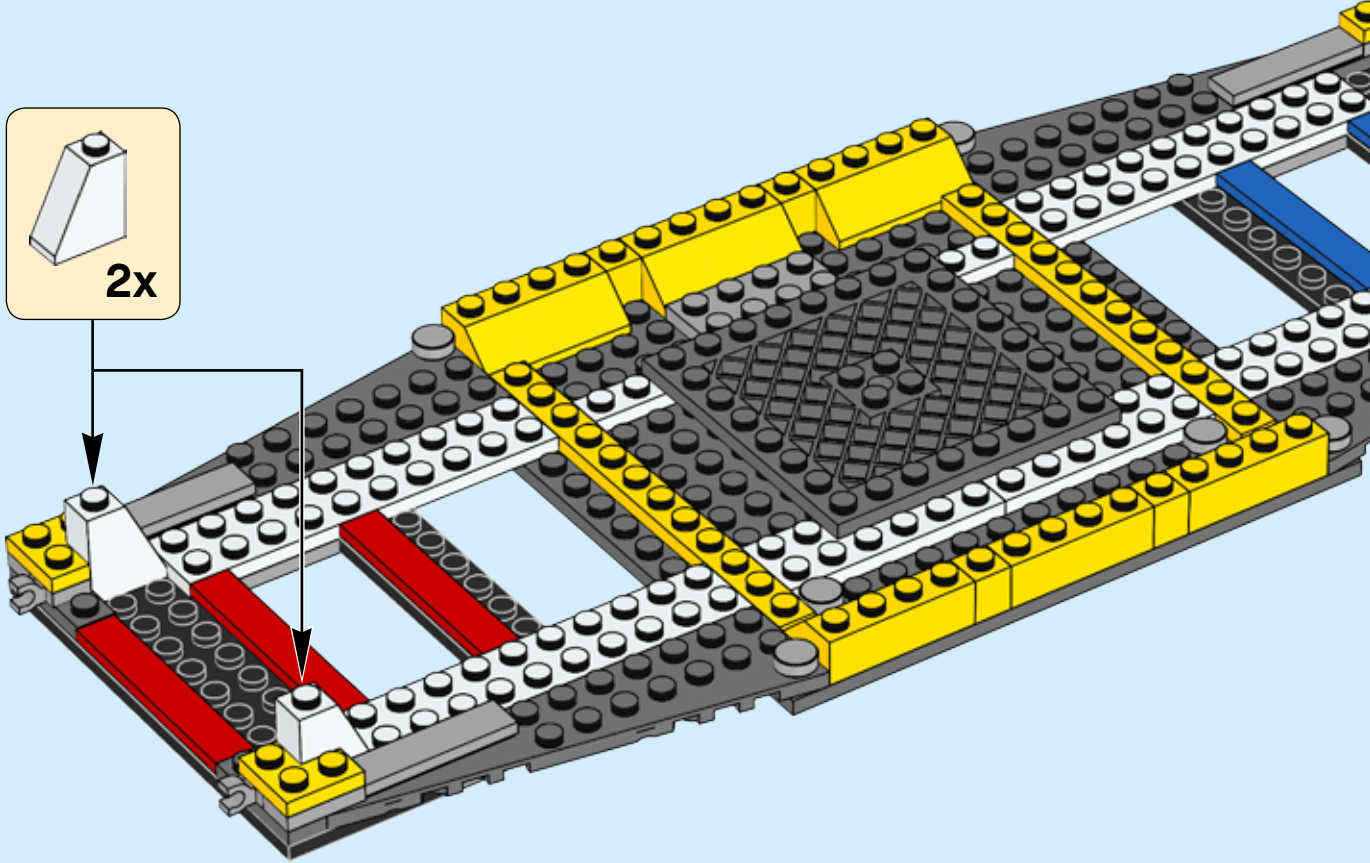

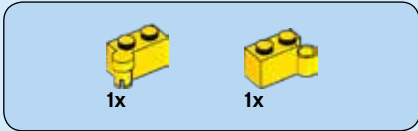

1x

1x

34

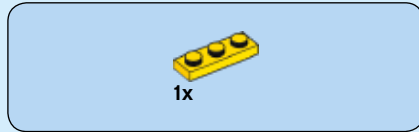
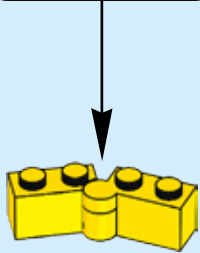
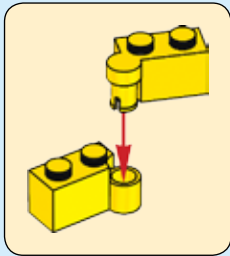

1x

35

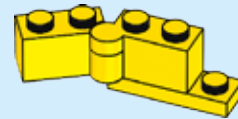

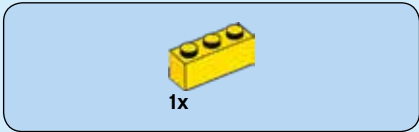

36

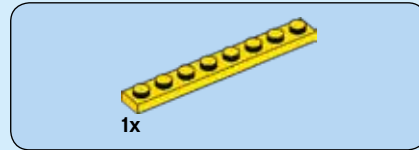
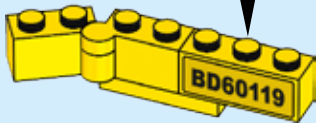
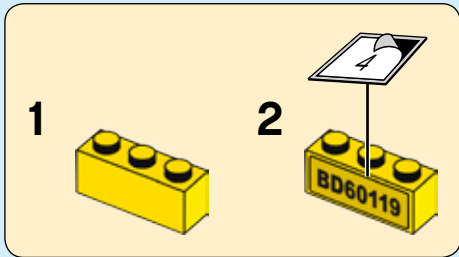

37

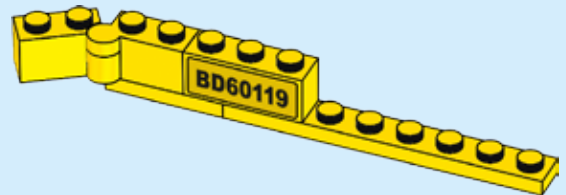



1x



1x

38

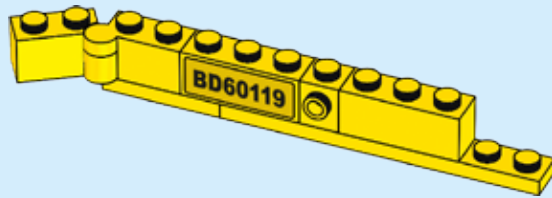

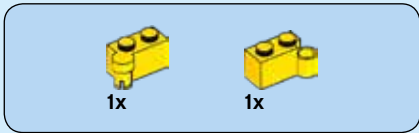

39

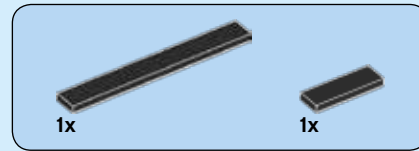
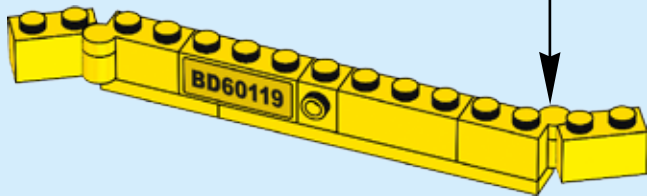
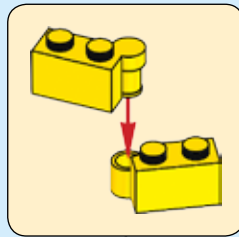

40

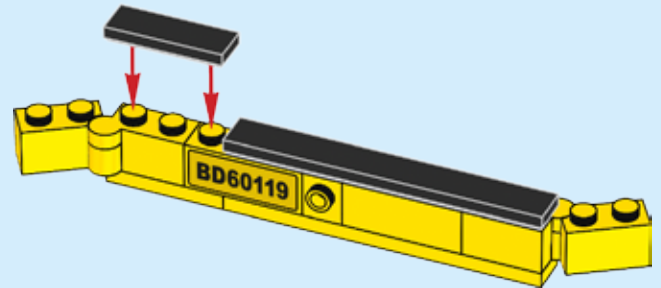

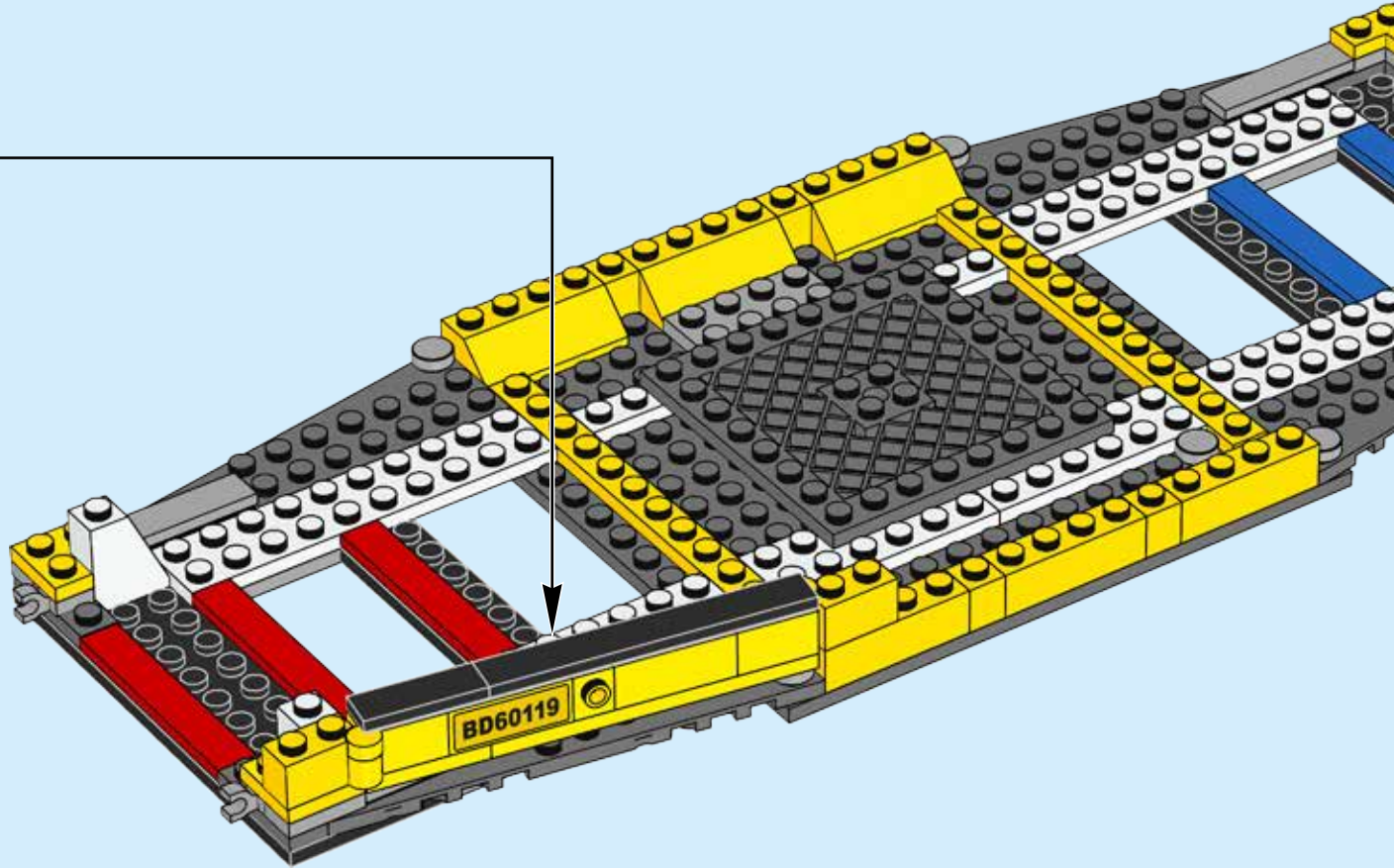

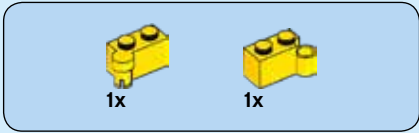

42

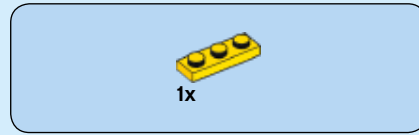
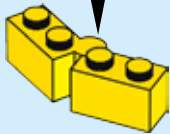
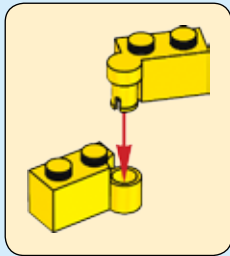

43

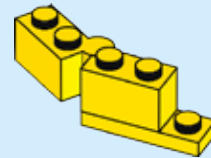



1x

44

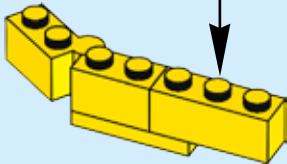
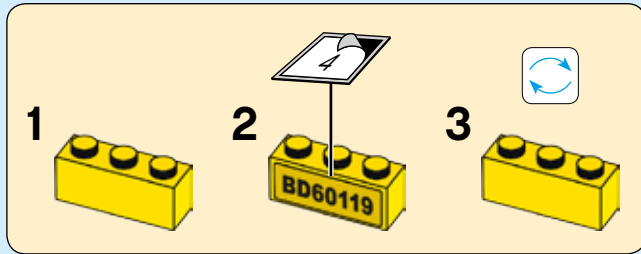

1x

45

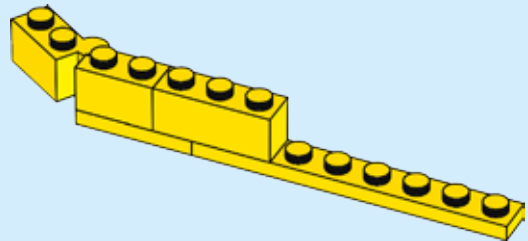

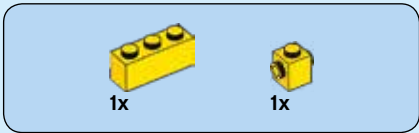

46

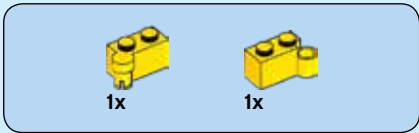
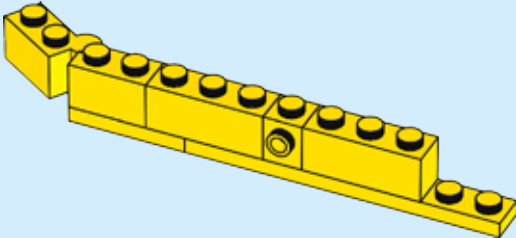

47

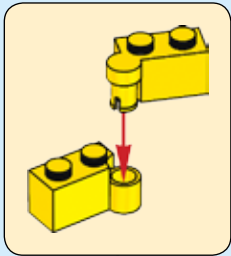
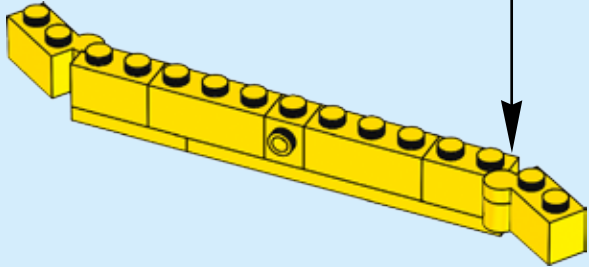

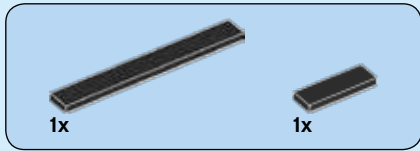

48

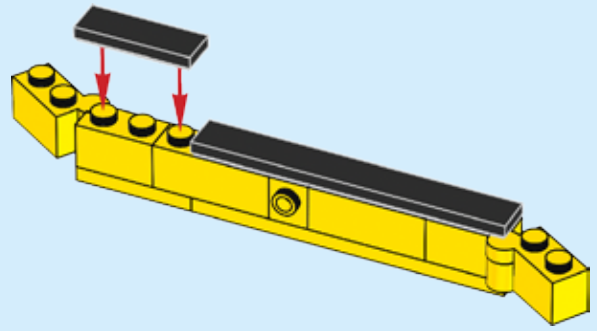

49

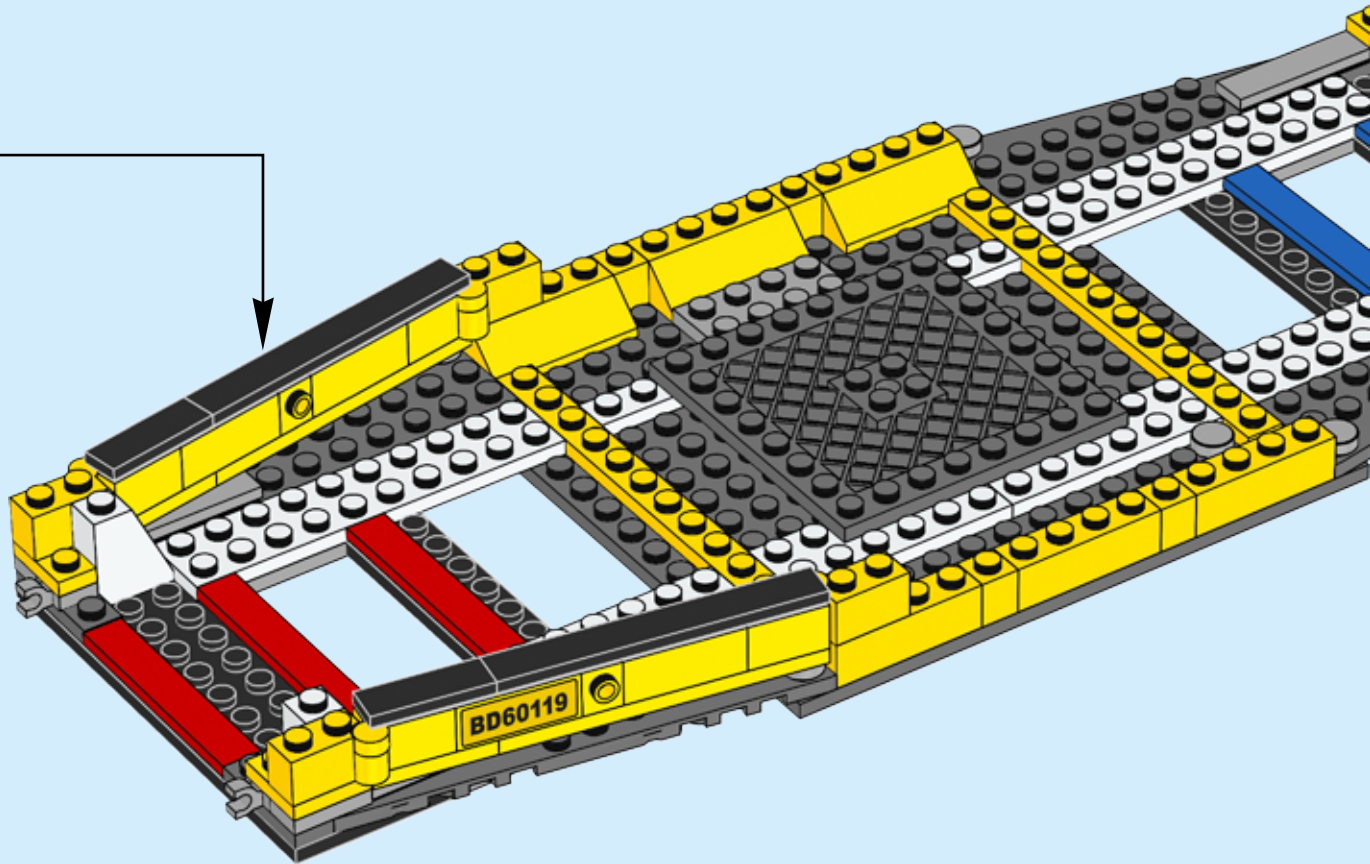



2x

50

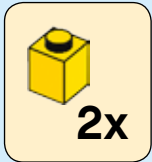

2x

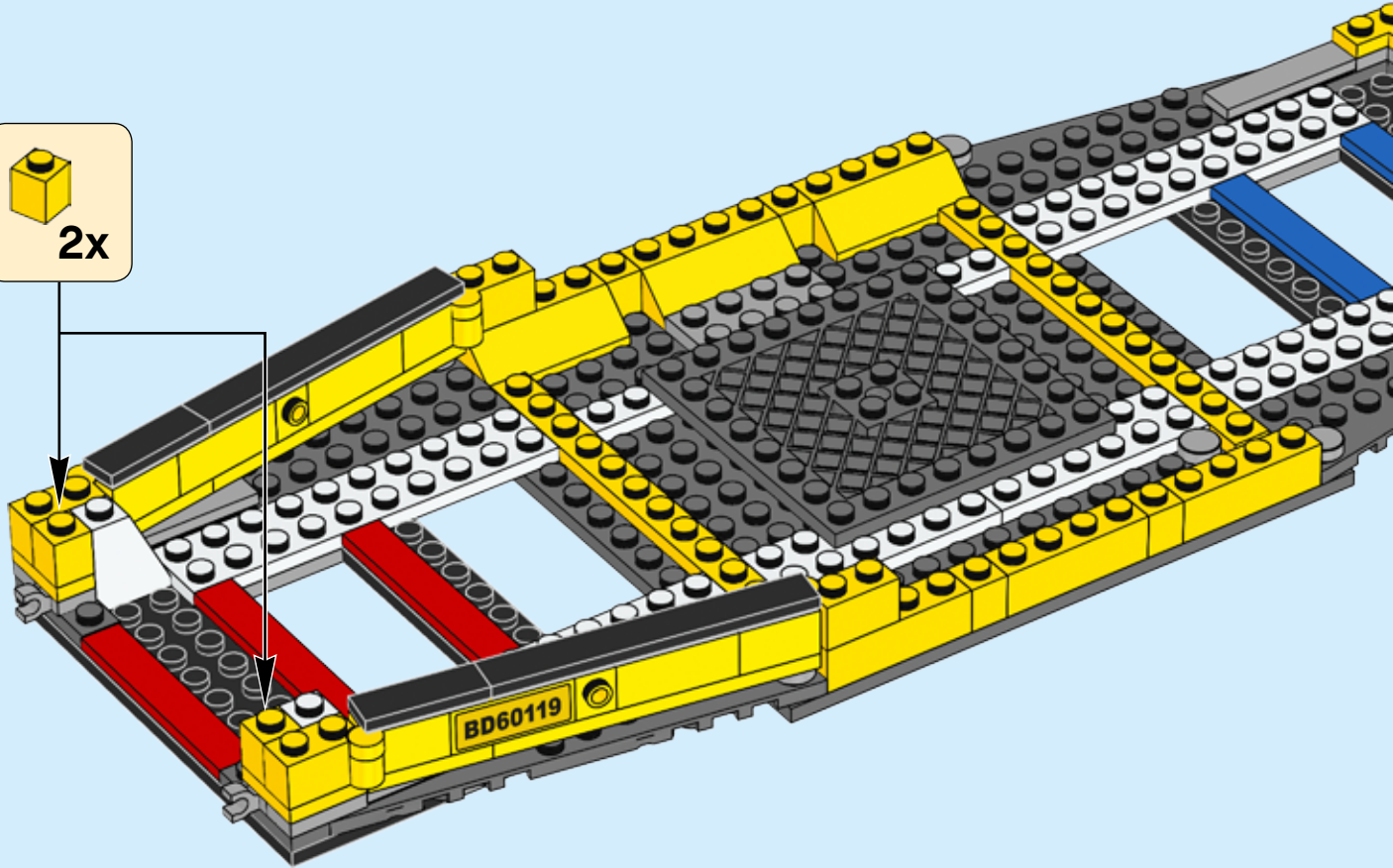



2x

51

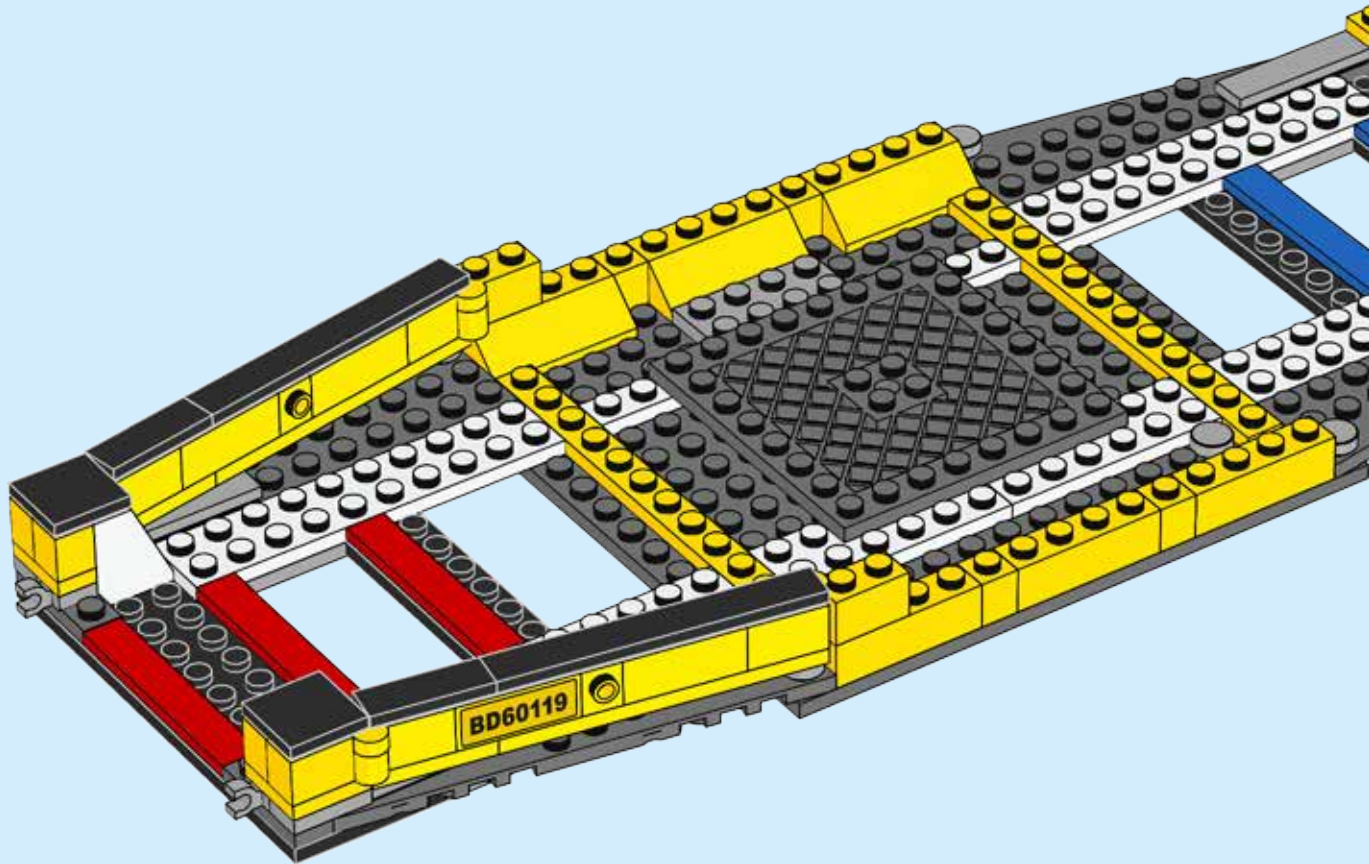



2x

52



2x

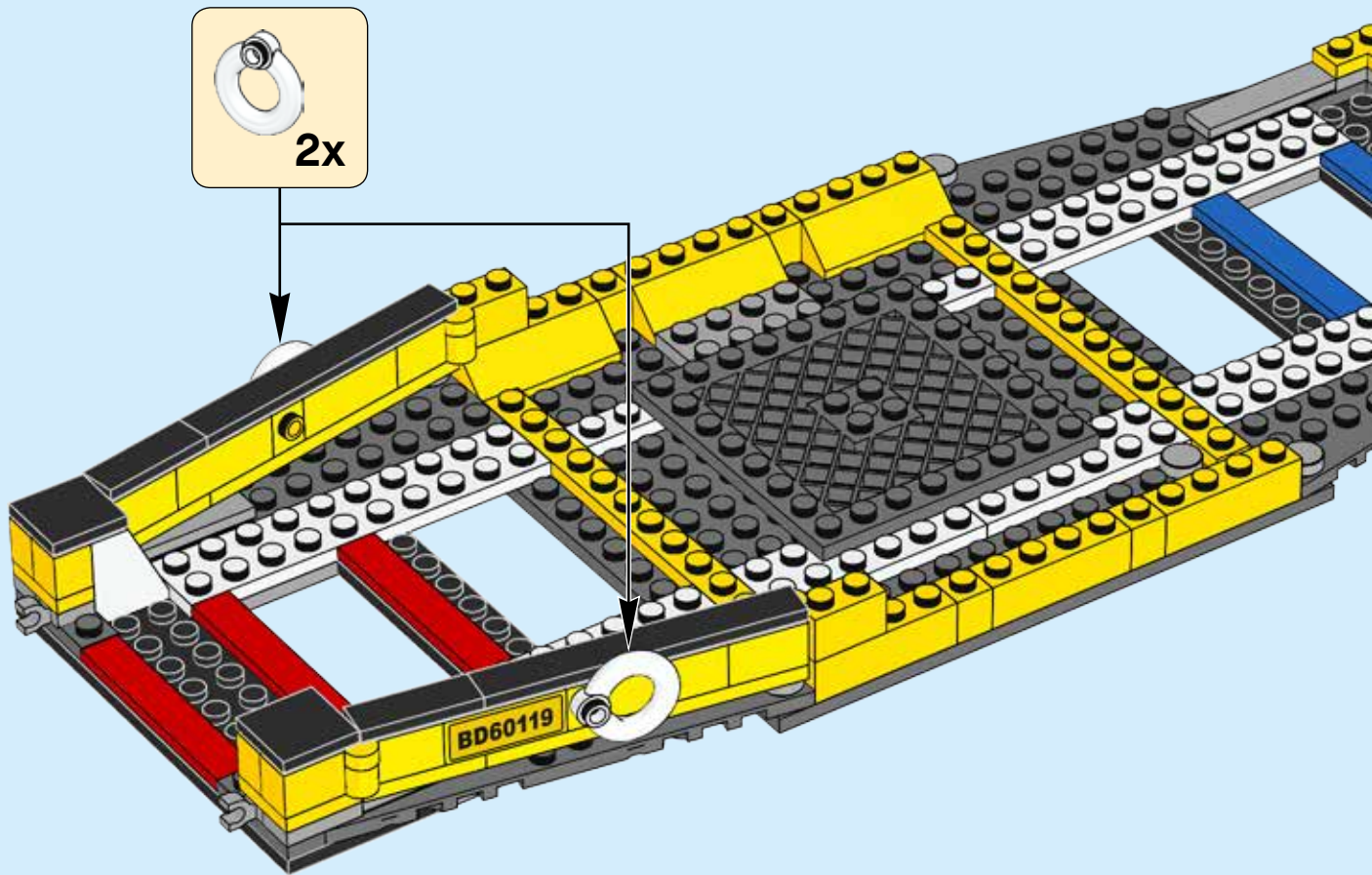

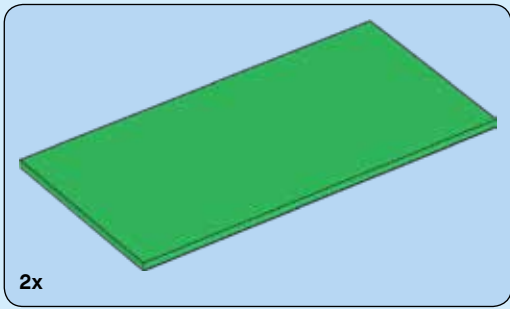

53

1

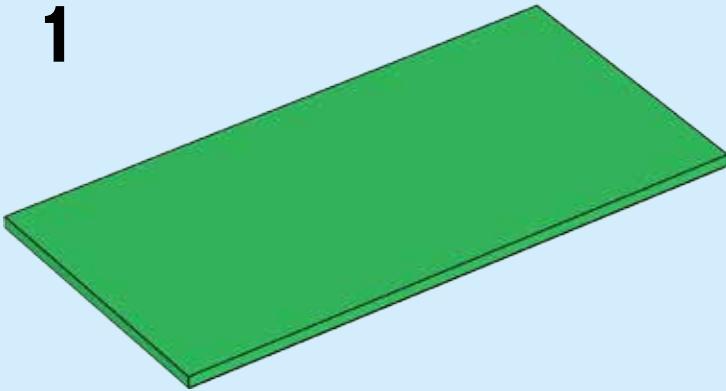

2

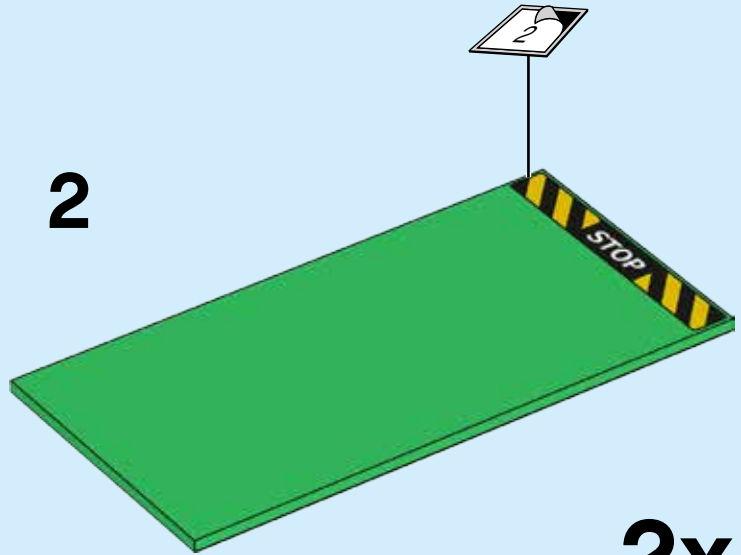

2x

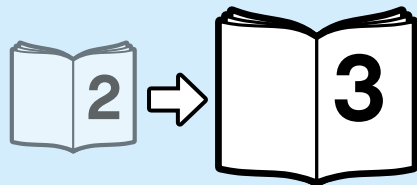
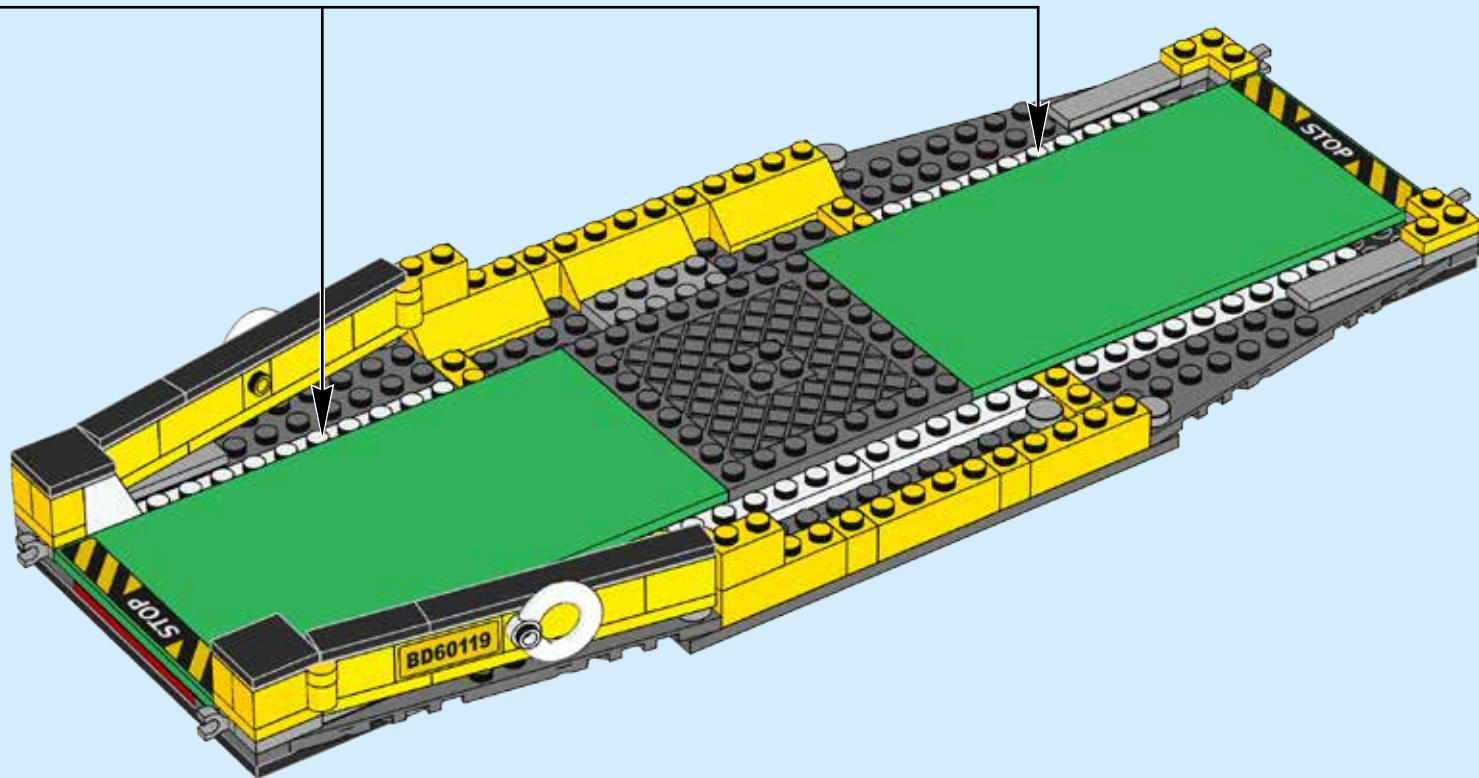

LEGO CITY



60110



60109



60108



60107



60106



60105

 [LEGO.com/city](https://www.lego.com/city)

LEGO

CITY



60130



60129



60128



60127



60126

LEGO and the LEGO logo are trademarks of the LEGO Group.
©2016 The LEGO Group.
6150627

 LEGO.com/city



CITY

60119







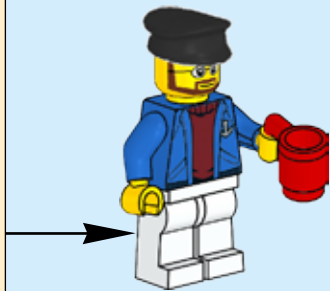
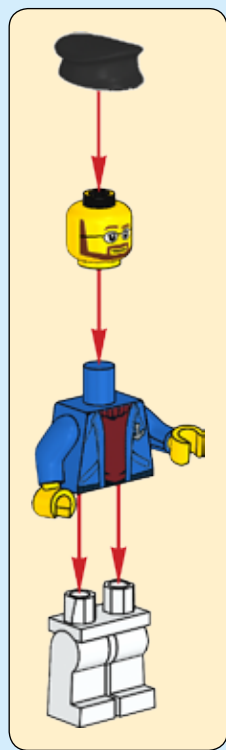

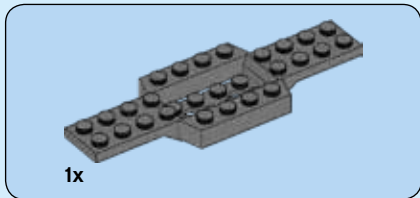

1

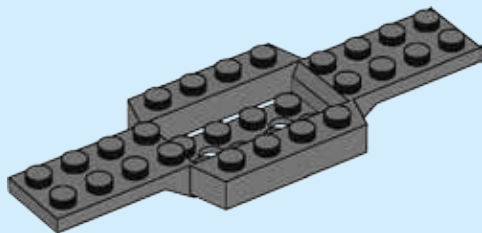

2

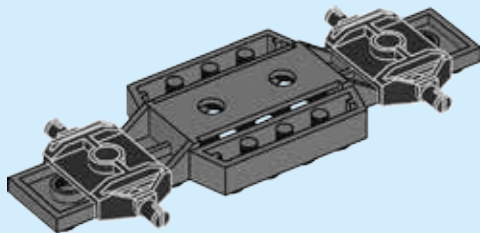
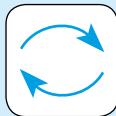

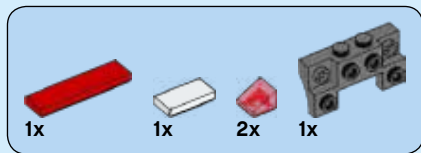

3

1

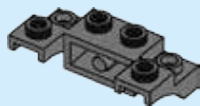

2

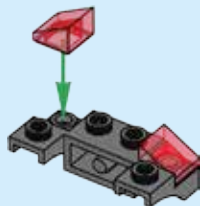

3

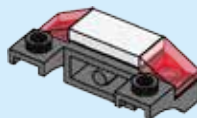

4

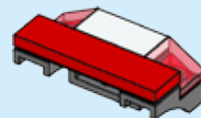

5

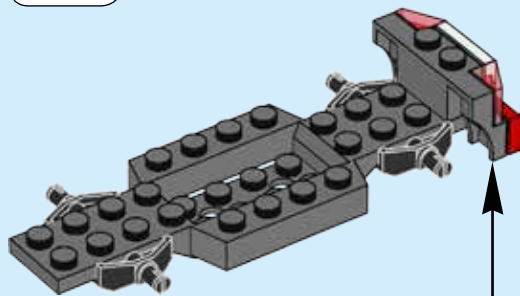
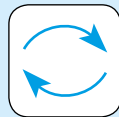
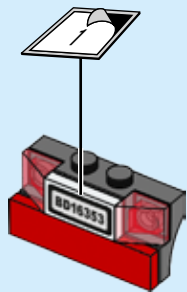



2x

4

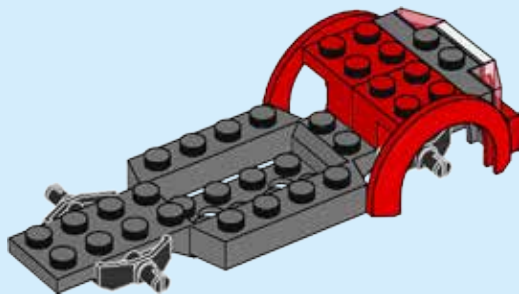

8



1x



1x

5

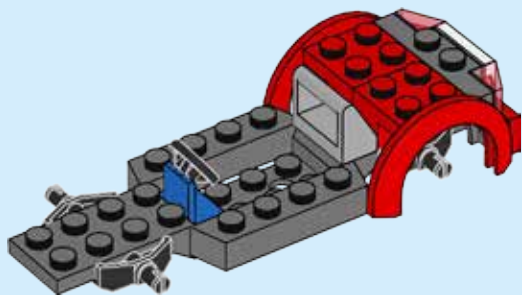

2x

6

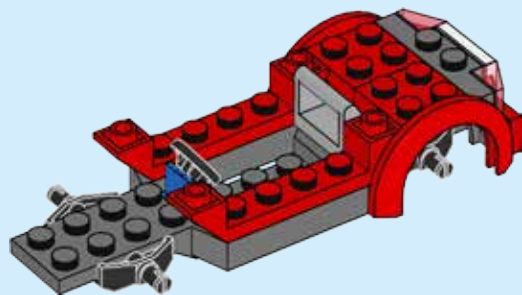



1x

7

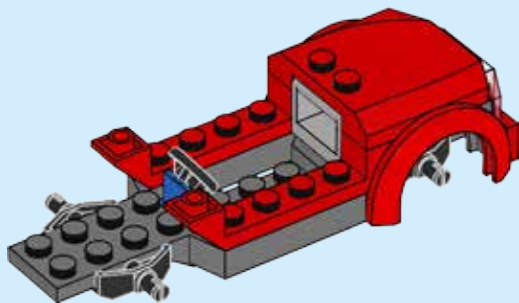



2x

8

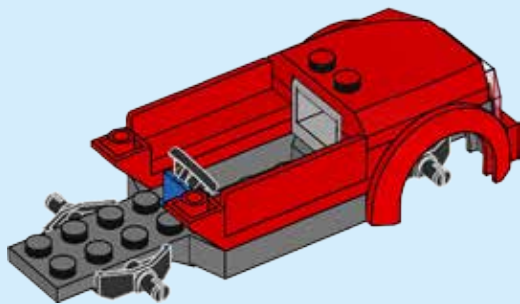



2x

9

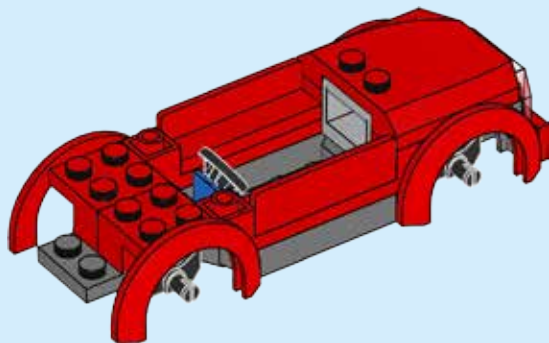

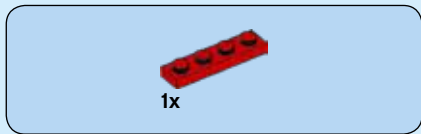

10

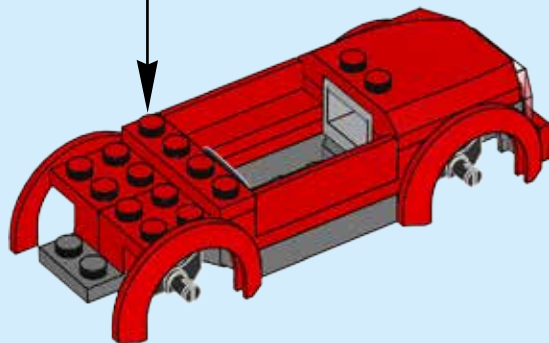
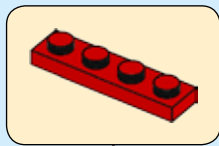

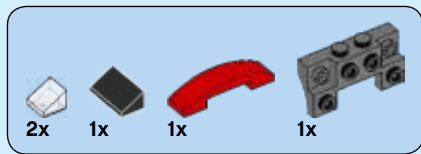

11

1

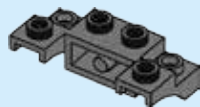

2

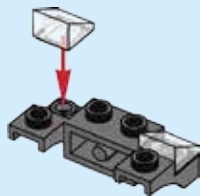

3

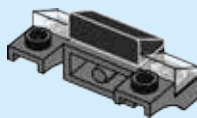

4



5

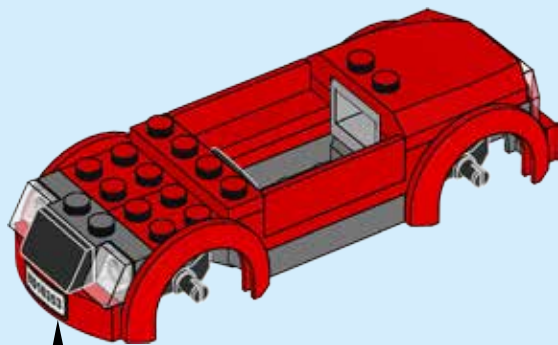
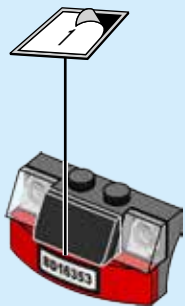



1x

12

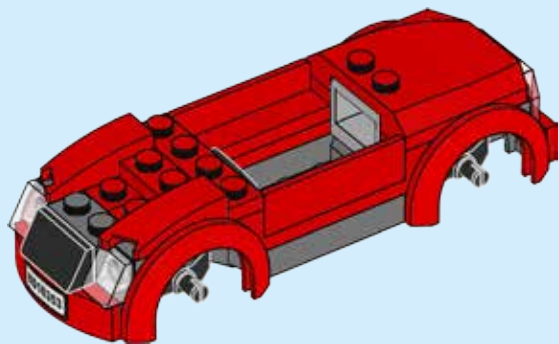



1x



2x

13

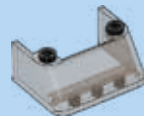
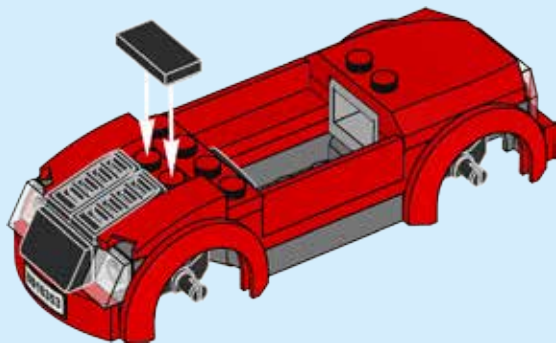

1x

14

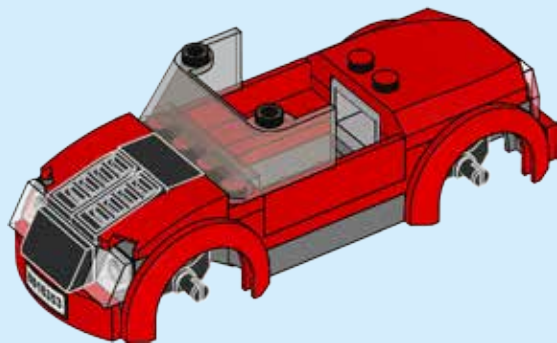

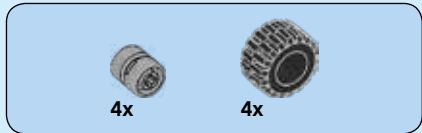

15

