



BRICK 'HEADZ

41612



MINECRAFT

 [LEGO.com/brickheadz](https://www.LEGO.com/brickheadz)

STEVE

58





1

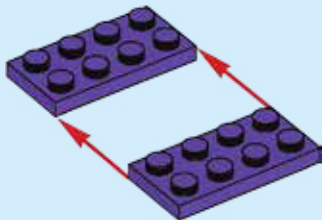



2x

2

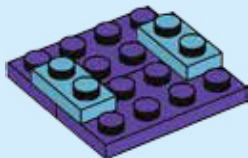

4



3

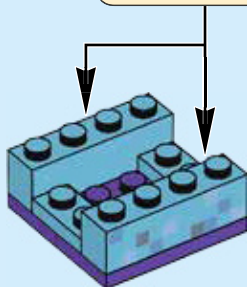
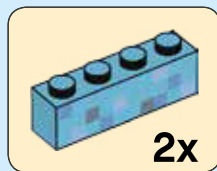

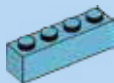

1x



2x

4

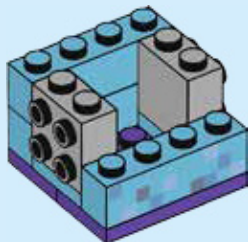

6

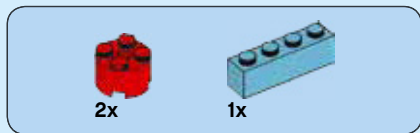

5

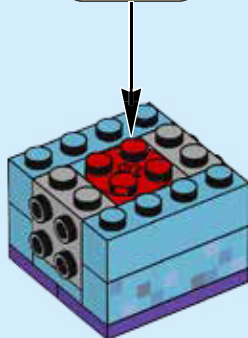



1x



2x



2x

6

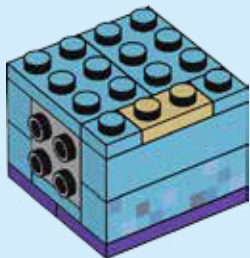

8

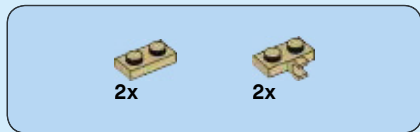

7

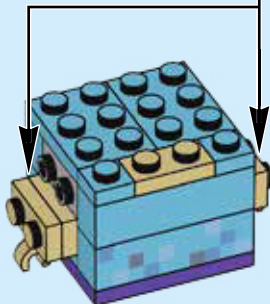
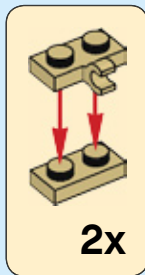



2x



2x

8



2x

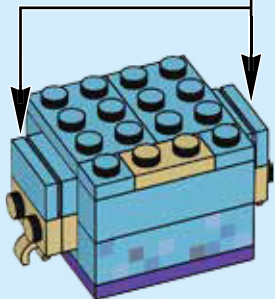



6x

9

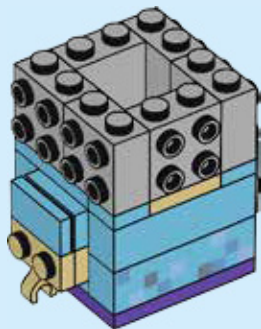



2x



1x



1x

10

1

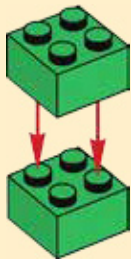

2

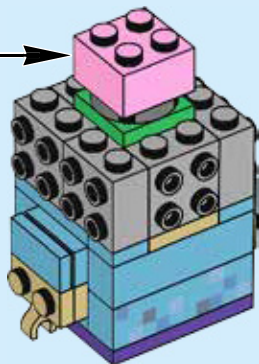
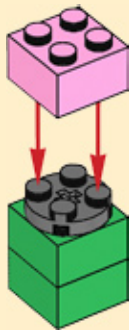

12



6x

11

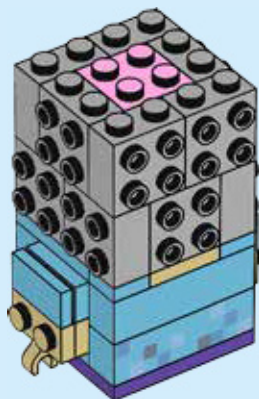



1x

12

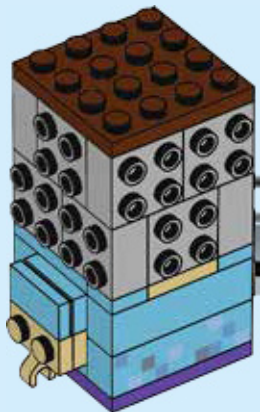

14



1x



1x

13

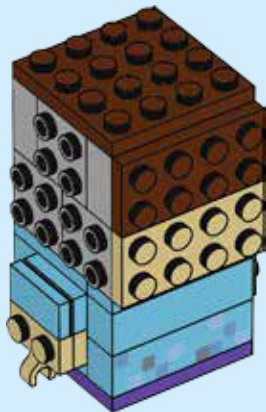

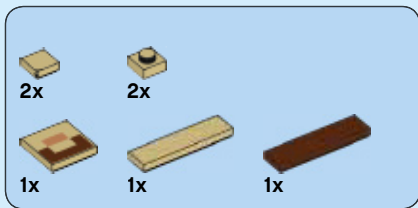

14

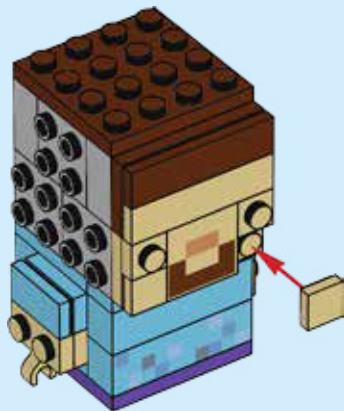



2x

15

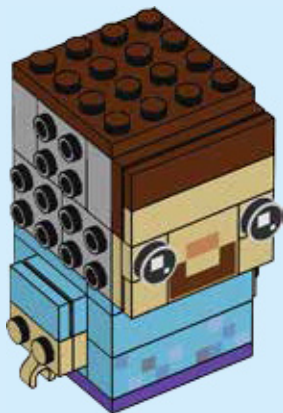



1x



1x



1x



1x

16

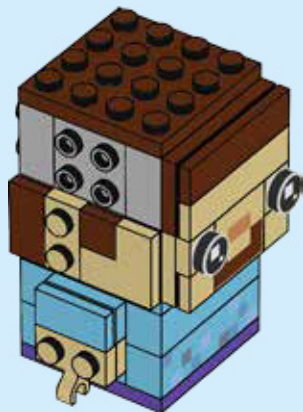

18



1x



1x

17

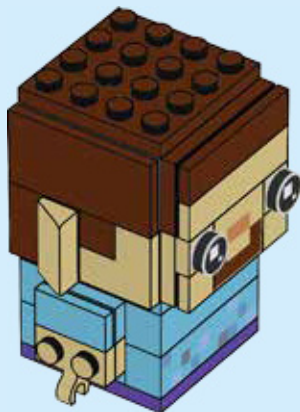



1x



1x



1x



1x

18

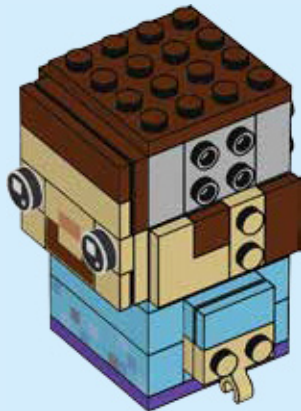
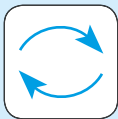



1x



1x

19

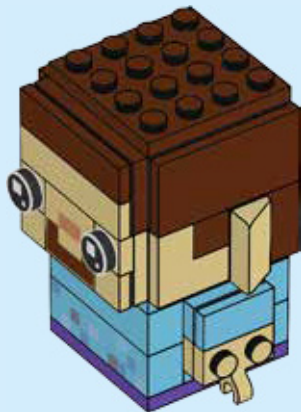



1x

20

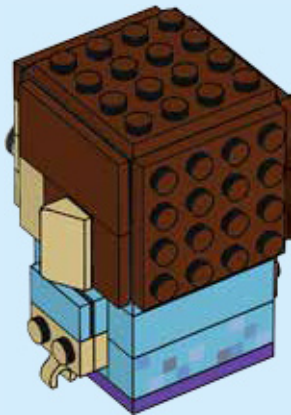
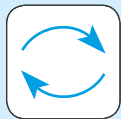

22



2x

21





1x

22

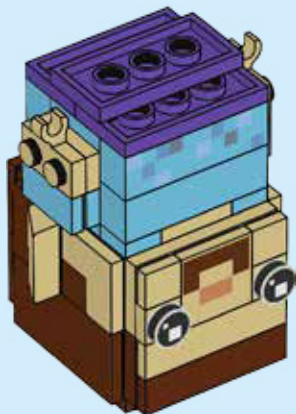
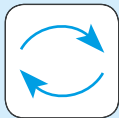

24

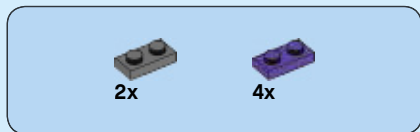

23

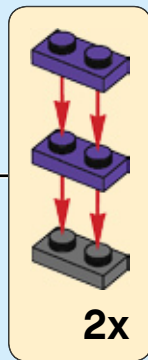
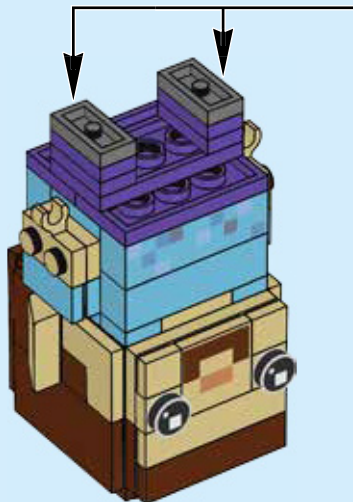



1x

24

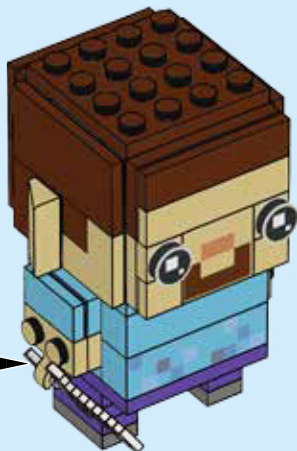
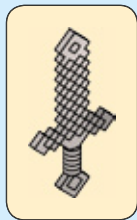
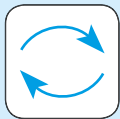

26

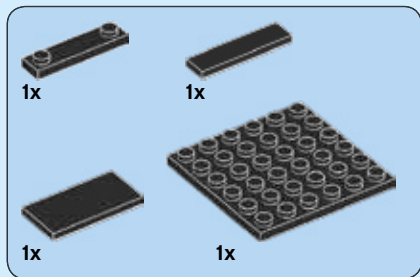

25

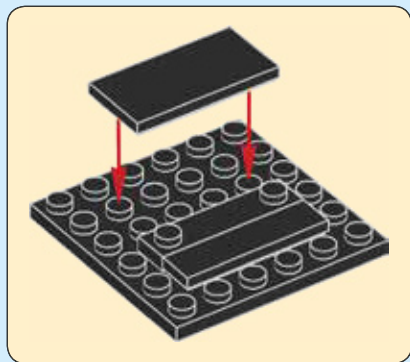

WIN

GO TO WWW.LEGO.COM/PRODUCTFEEDBACK AND
GIVE US YOUR SHORT **FEEDBACK** ABOUT THIS
LEGO® SET FOR A CHANCE TO WIN
A COOL LEGO PRIZE.

Terms & Conditions apply

LEGO.com/productfeedback



GEWINNE

Erzähle uns auf
www.LEGO.com/productfeedback

etwas über die Erfahrungen, die du
mit diesem LEGO® Set gemacht hast,
und sichere dir die Chance auf einen
coolen LEGO Preis!

Es gelten die Teilnahmebedingungen

GAGNE

Rends-toi sur
www.LEGO.com/productfeedback

et donne-nous quelques commen-
taires sur ce produit LEGO® pour
avoir une chance de gagner un
prix LEGO !

Voir Conditions Générales

GANANA

Visita
www.LEGO.com/productfeedback

y envíanos tu opinión acerca de este
set LEGO®. ¡Participarás en el sorteo
de un premio LEGO!

Términos y Condiciones aplicables

获取奖品

登录
www.LEGO.com/productfeedback

给出关于此乐高®套装的简短反馈，
就有机会获得炫酷乐高奖品

《条款及条件》适用

LEGO and the LEGO logo are trademarks of the LEGO Group. ©2018 The LEGO Group.

© 2018 Mojang AB and Mojang Synergies AB. MINECRAFT is a trademark or
registered trademark of Mojang Synergies AB.

6248182



BRICK HEADZ

41612



MINECRAFT

 [LEGO.com/brickheadz](https://www.LEGO.com/brickheadz)

CREEPER™

59

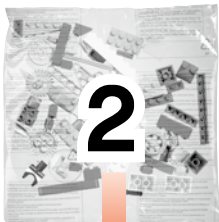

1x



1x

1

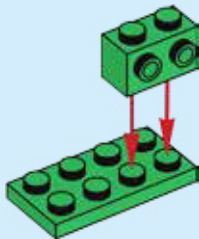



2

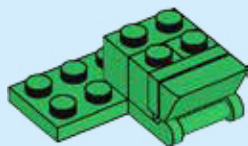
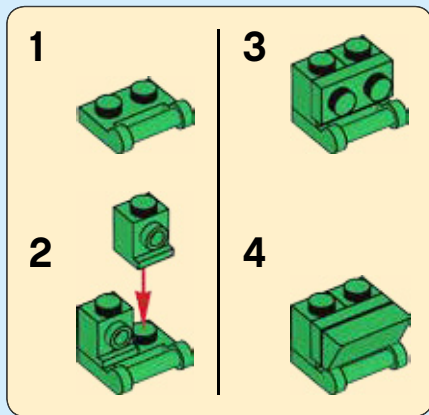



1x



3x

3

1

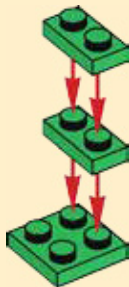

2

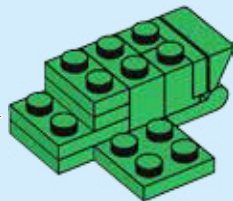
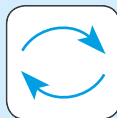
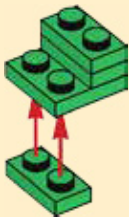

4



1x

4

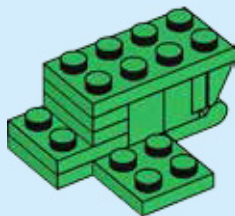



5

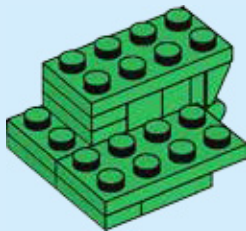
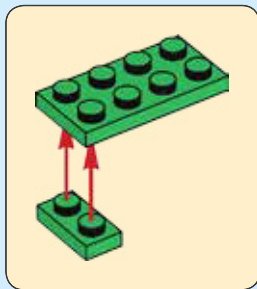

6



1x

6

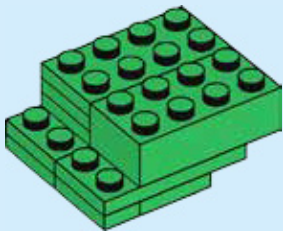



1x

7

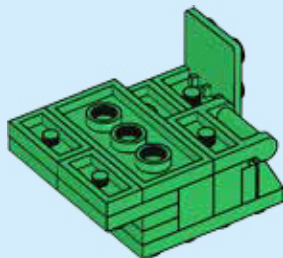
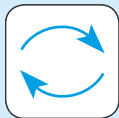

8



8

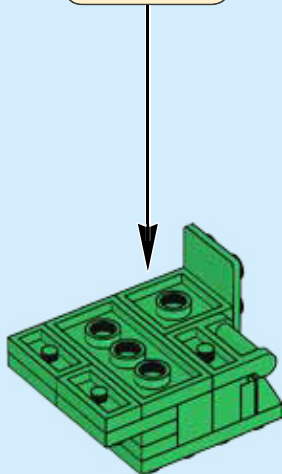



1x



1x

9

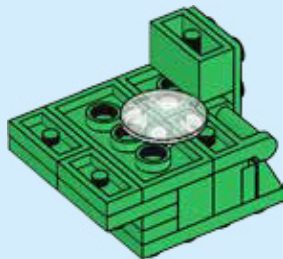

10



10

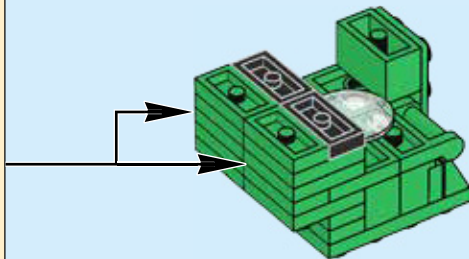
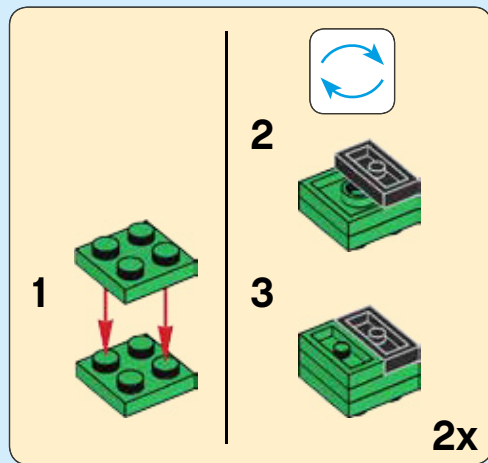



1x



1x

11

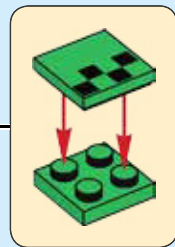
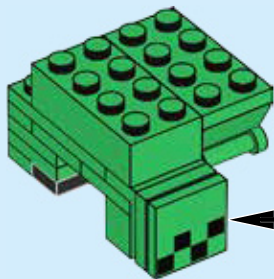
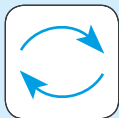

12



12

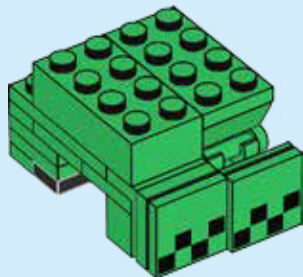
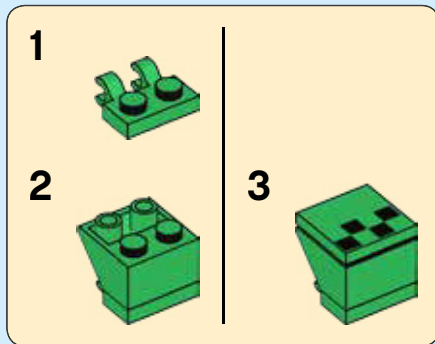



2x

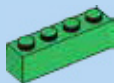

1x

13

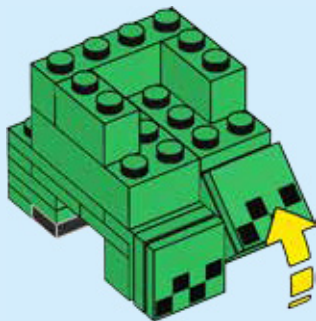

14

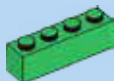

1x



1x

14

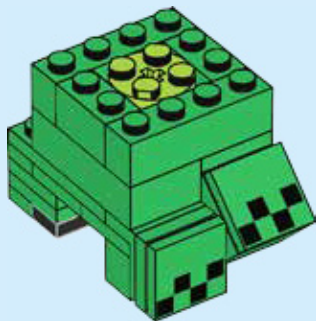

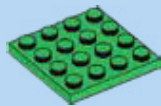

1x

15

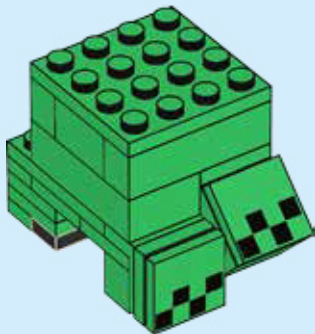

16



5x

16

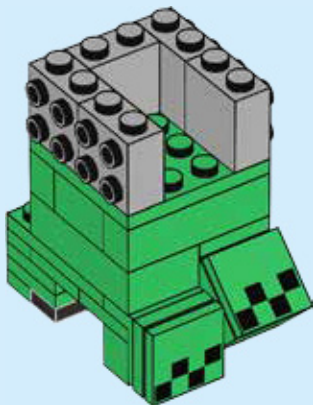

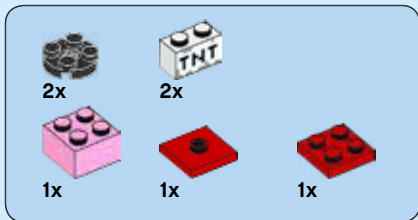

17

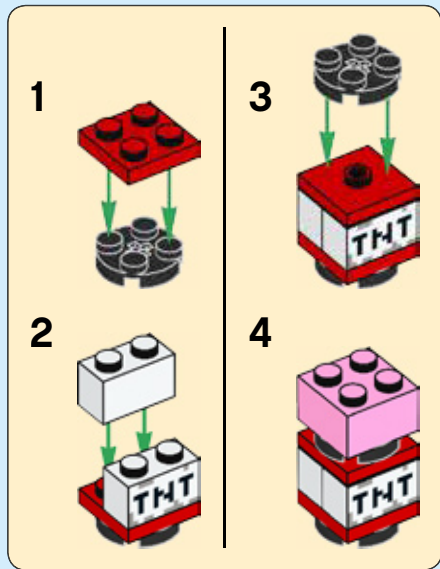
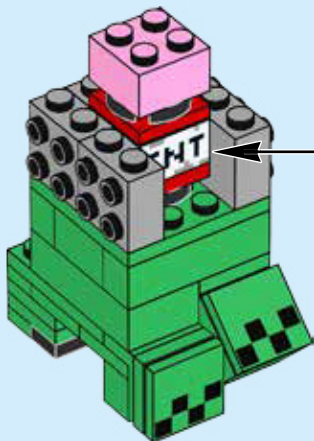

18



4x



2x

18

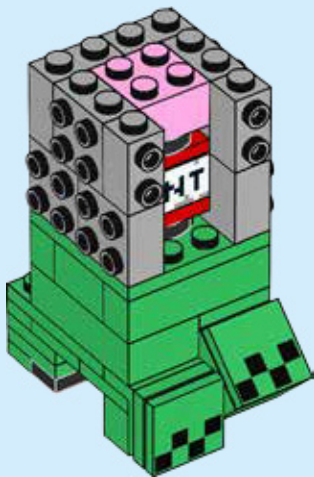

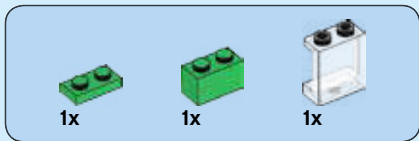

19

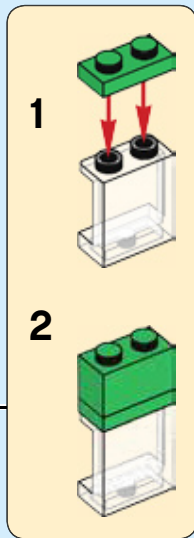
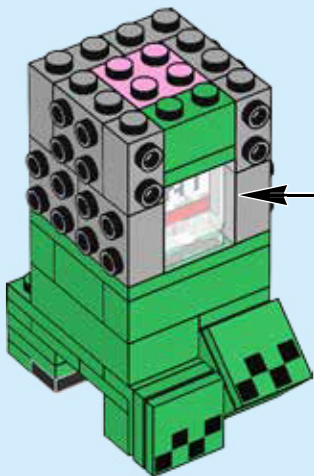

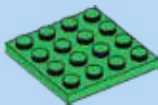

1x

20

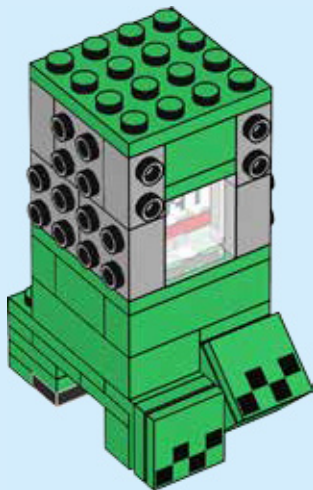

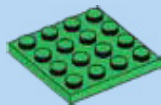

1x

21

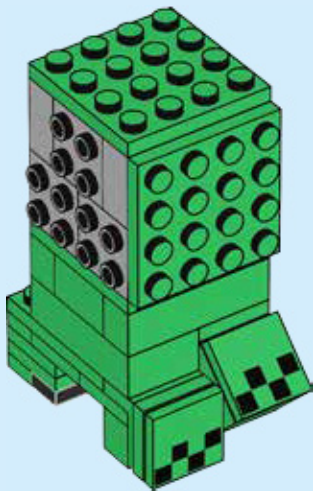

22

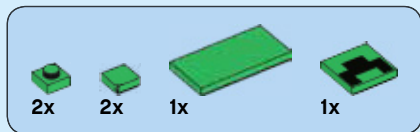

22

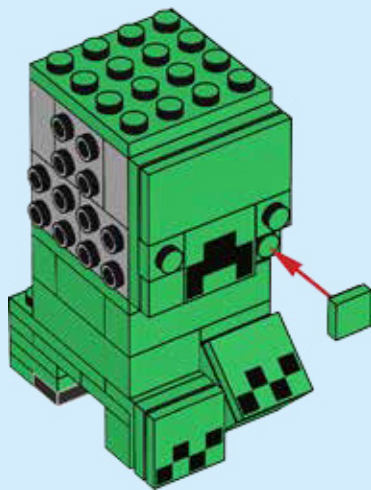



2x

23

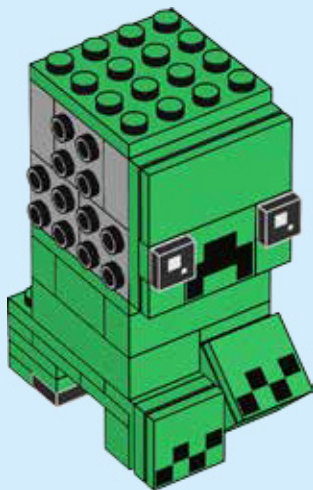

24

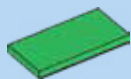

2x

24

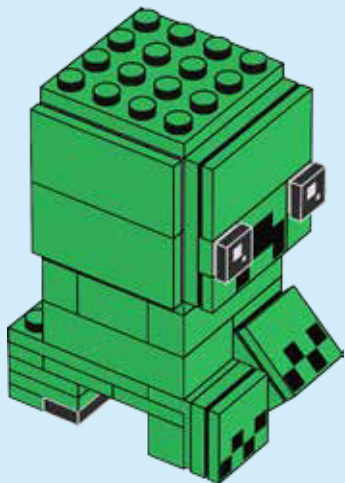

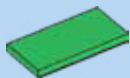

2x

25

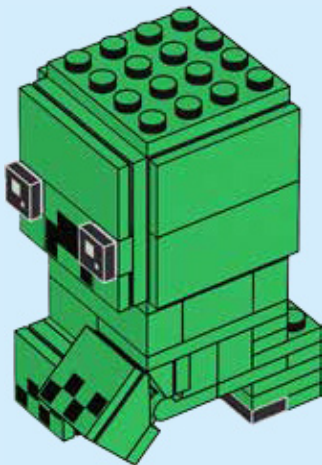
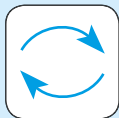

26

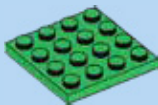

1x

26

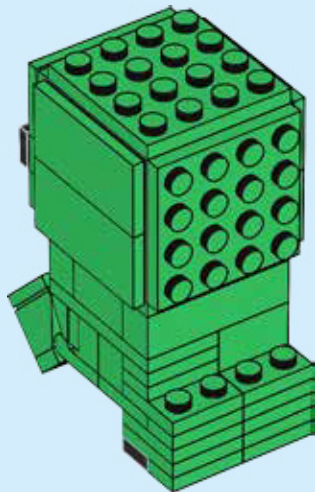
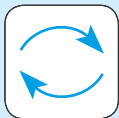

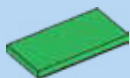

2x

27

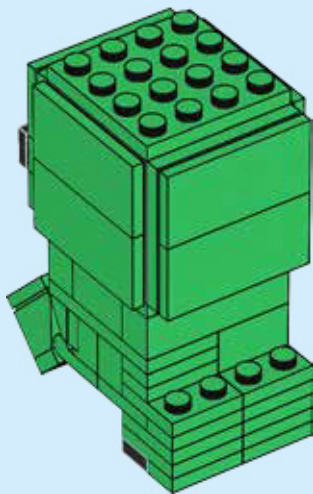

28

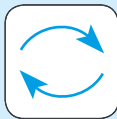
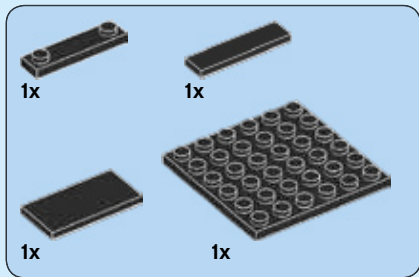

28

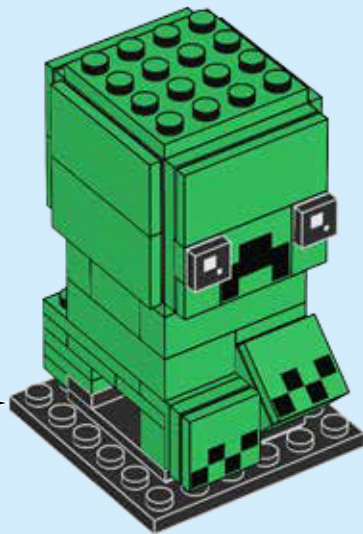
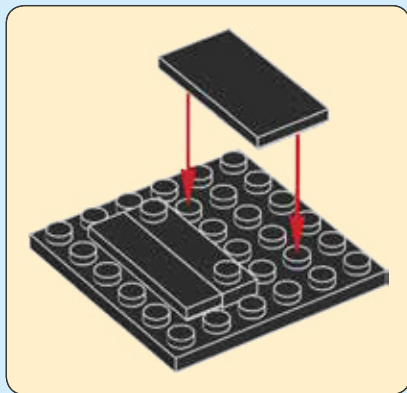



2x
6097028



2x
4159553



2x
4125253



2x
4624086



2x
6177314



5x
4113917



1x
6238349



2x
6173057



1x
4550324



1x
4114309



2x
6178627



2x
6239888



2x
403226



2x
302326



2x
243126



2x
4599499



2x
4560182



2x
395826



2x
4187334



2x
302428



2x
4558593



1x
6000071



1x
6129807



4x
4107736



8x
302328



1x
6117971



1x
4556159



1x
4521931



7x
302228



1x
6238262



2x
6238268



2x
300328



1x
4142717



2x
4112838



7x
4566179



3x
302028



1x
4106356



4x
4243821



2x
614321



1x
6126048



1x
302221



1x
4527943



2x
4211288



2x
4211151



1x
4211194



4x
4579690



1x
4211186



2x
4243838



2x
6225242



23x
6123809



1x
4211042



2x
4211063



1x
6000740



1x
4278412



2x
4550359



4x
4655695



3x
6030277



1x
6089098



2x
6097493



4x
6097419



2x
4649741



2x
4619513



2x
6036238



2x
6238335



Customer Service

Kundenservice

Service Consommateurs

Servicio Al Consumidor

LEGO.com/service or dial



: 00800 5346 5555

: 1-800-422-5346

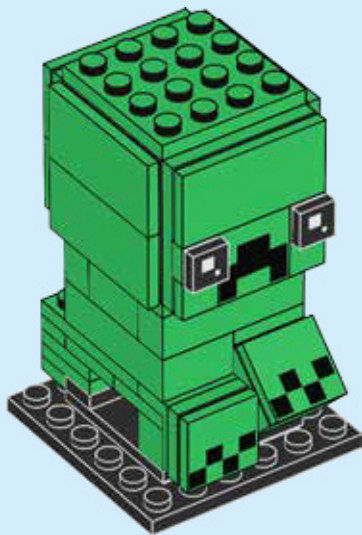
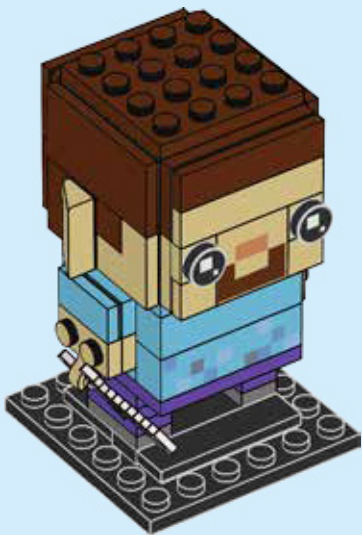

LEGO and the LEGO logo are trademarks of the LEGO Group. ©2018 The LEGO Group.

© 2018 Mojang AB and Mojang Synergies AB. MINECRAFT is a trademark or registered trademark of Mojang Synergies AB.

6248187