

LEGO

MINIFIGS

70671





- 1** Download the LEGO® Life App
 Lade dir die LEGO® Life App herunter
 Télécharge l'application LEGO® Life
 Télécharger l'application LEGO® Life
 Scarica l'app LEGO® Life
 Descarga la app LEGO® Life
 Descarrega a App LEGO® Life
 Töltsd le a LEGO® Life Appot!
 Lejupielādē lietotni LEGO® Life
 下载 LEGO® Life 应用程序



- 2** Scan the code on the front cover
 Scanne den Code auf der Titelseite
 Scanne le code sur la page de
 couverture
 Scanner le code sur la page
 couverture
 Scansiona il codice sulla copertina
 Escanea el código de la portada
 Faz scan do código na frente da capa
 Olvasd be a borítón látható kódot!
 Noskenē kodu uz priekšējā vāka
 扫描封面上的二维码



- 3** Get the Building Instructions
 Hol dir die Bauanleitung
 Obtens les instructions de montage
 Obtenir les instructions de montage
 Scarica le istruzioni per la
 costruzione
 Consulta las instrucciones de
 construcción
 Obtém as Instruções de Construção
 Szerezd be az építési útmutatókat!
 Saņem būvēšanas instrukcijas
 获取拼搭说明

LEGO.com/apps

Check for compatibility
 Kompatibilitāt pārbaudīt
 Vérifier la compatibilité
 Controlla la compatibilità
 Comprueba tu compatibilidad

Verificar a compatibilidade
 Ellenőrizd a kompatibilitást
 Pārbaudīt saderību
 检查兼容性

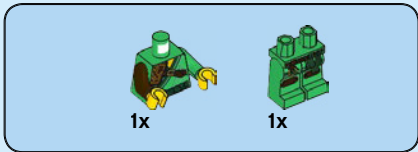
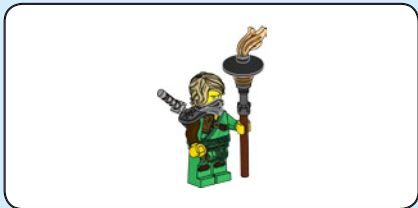

1

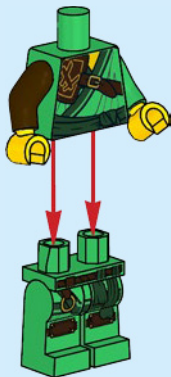



1x



1x



1x

2

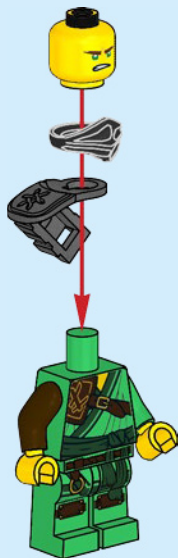

4



1x

3



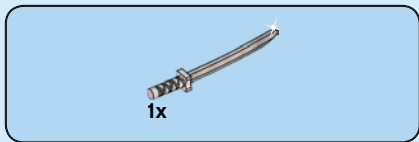

4



6



5

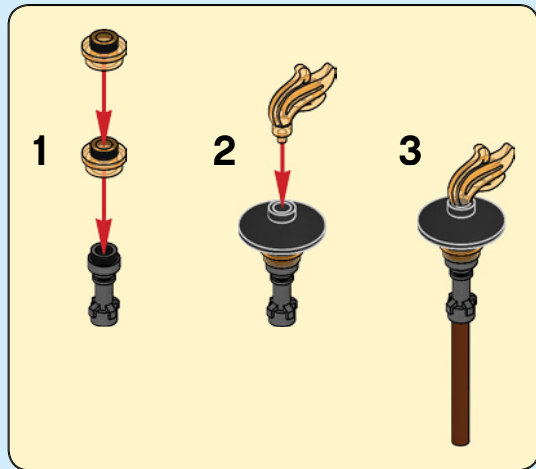

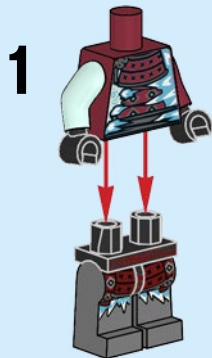
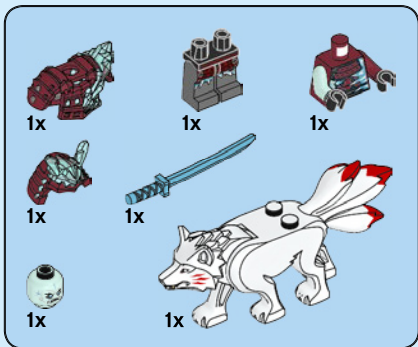

2

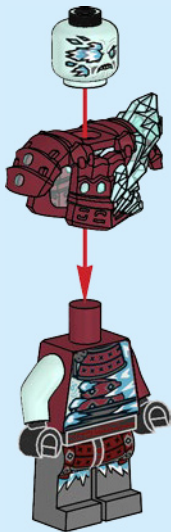

3

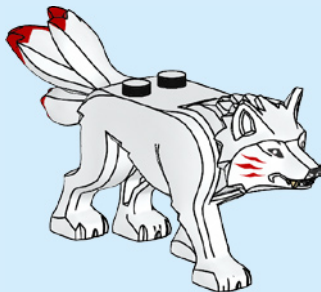

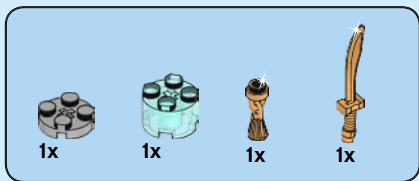

1

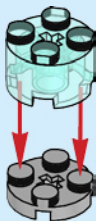

2

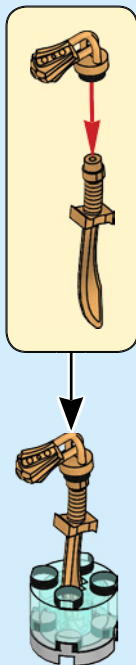

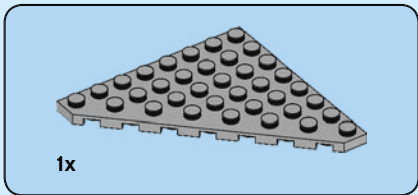
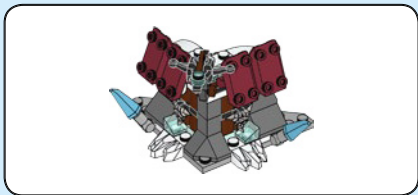

1

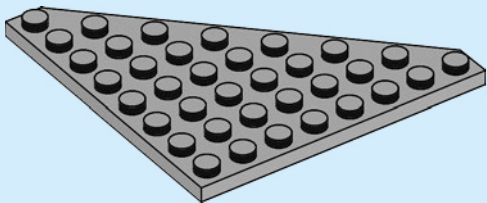



1x

2

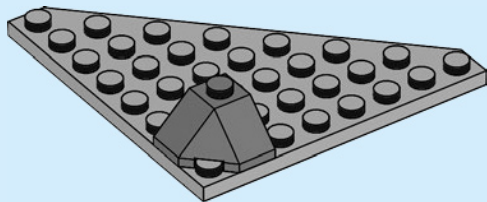



2x



2x

3

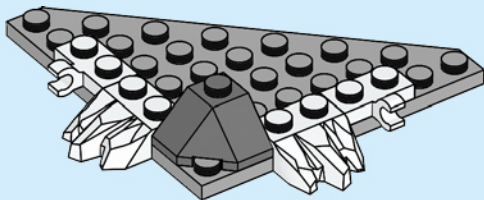



2x

4

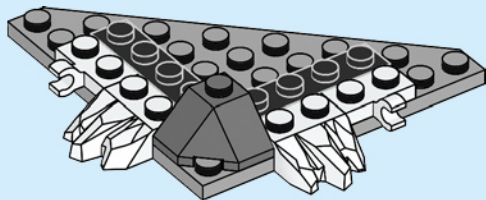



2x

5

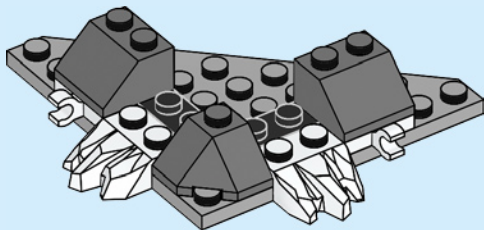



2x



2x

6



2x

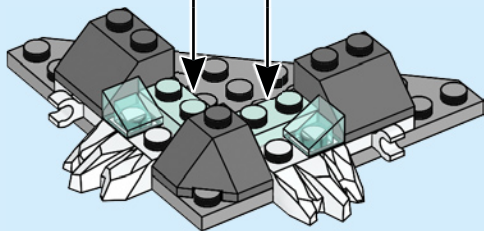



2x

7

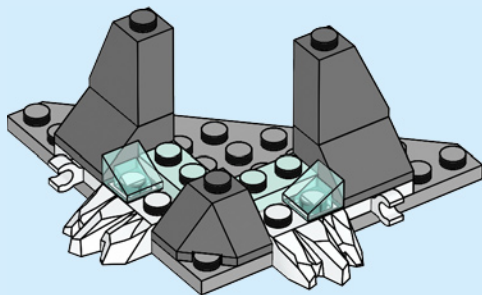



4x



2x

8

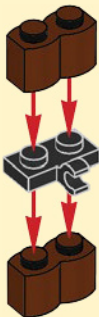

2x

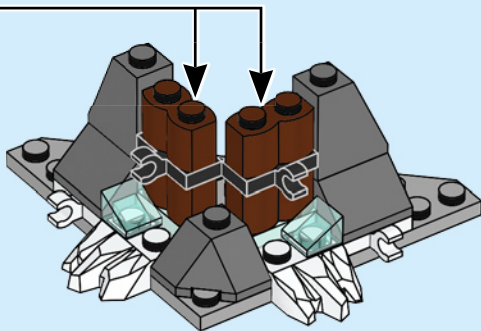



2x

9

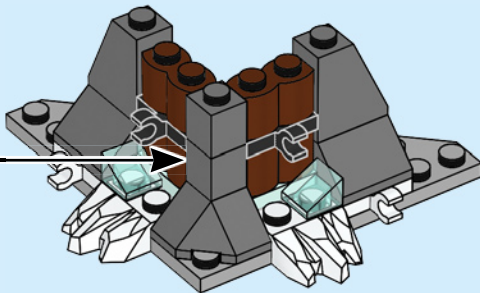
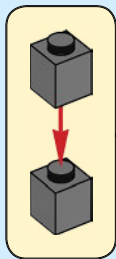



1x



2x

10

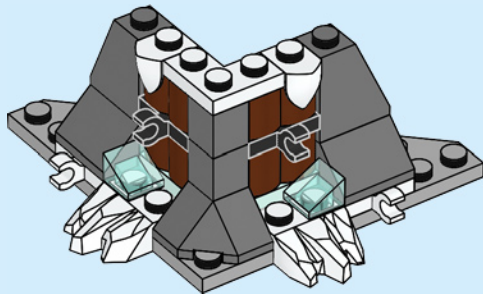



2x



1x

11

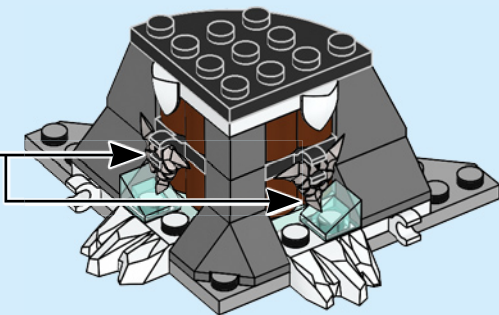
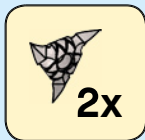



2x



2x

12

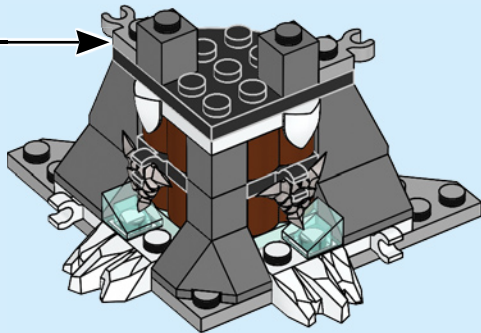



2x

13

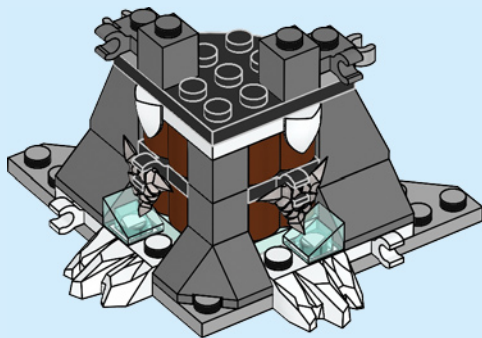



2x

14

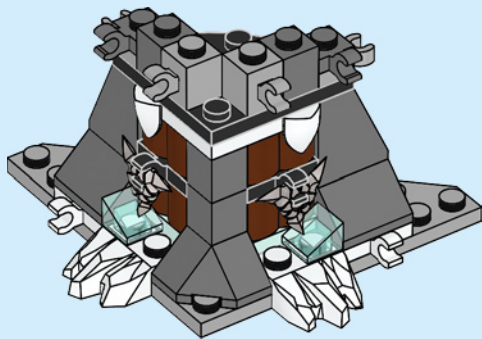

24



1x



2x

15

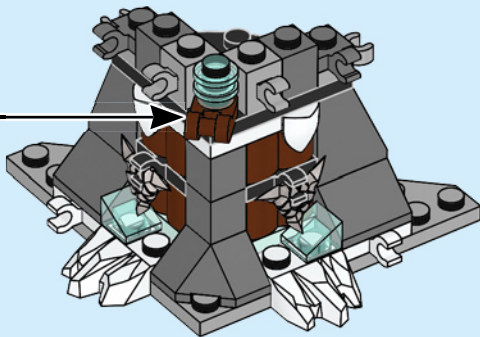
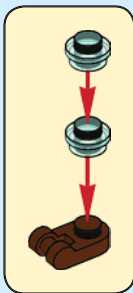



1x



2x

16

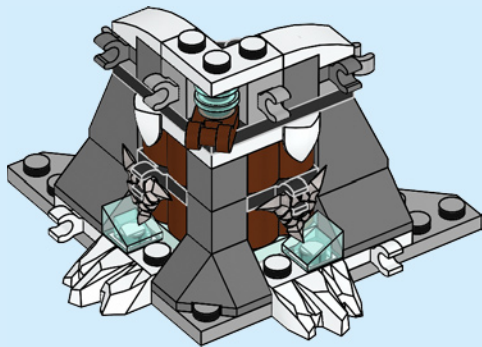



4x

17

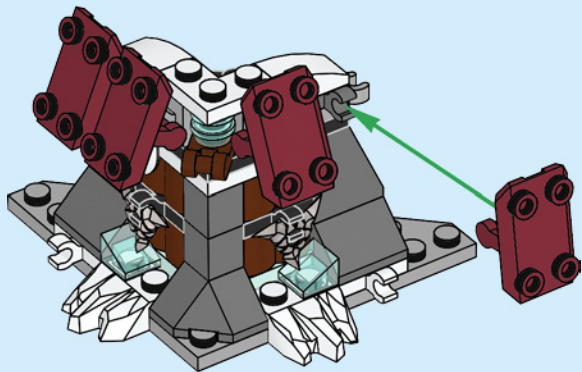



2x



2x

18

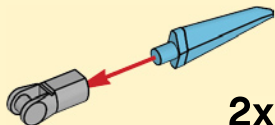

2x

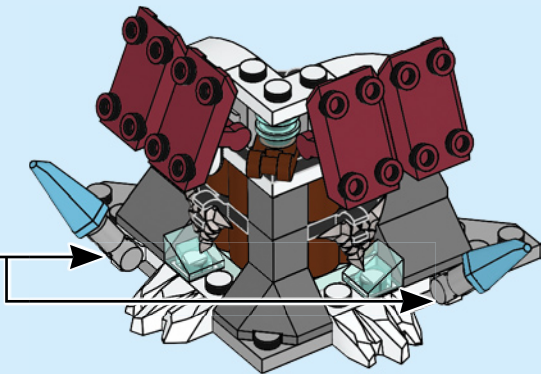



1x

19

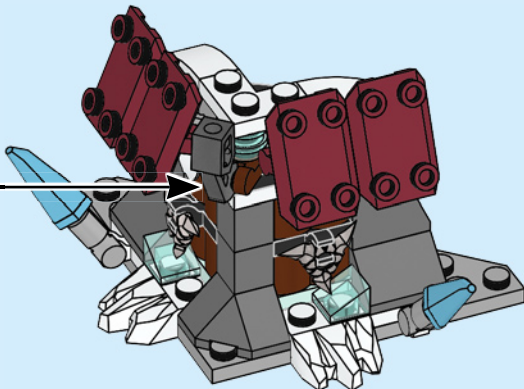



1x



1x



20

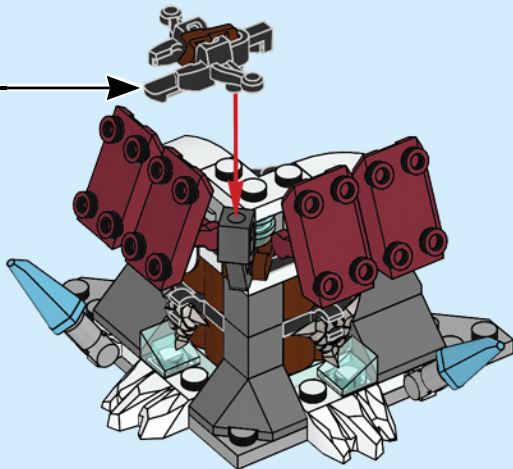
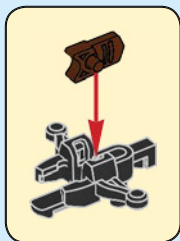

30



3x



21

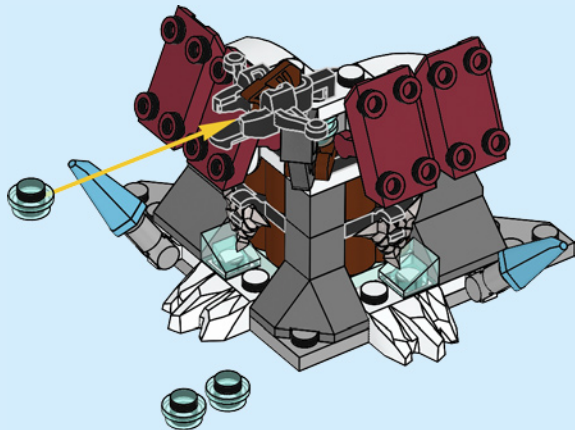

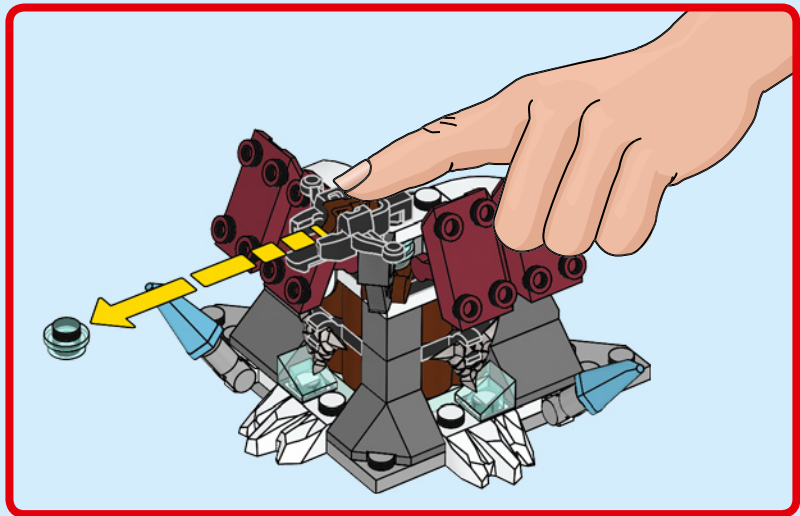



1



2



3



2x
4579354

4x
4211098

2x
6013658

1x
6227909

2x
4211054

1x
6266714

1x
6117255

1x
6116593

1x
4649066

2x
6134722

1x
6122727

1x
6008484

1x
6267464

2x
6264114

1x
6264121

1x
6266909

2x
6146701

2x
6046905

2x
6070712

2x
6034044

2x
6181319

2x
242001

1x
6195105

1x
6274711

1x
6245239

1x
6191962

1x
6266665

1x
6054856

1x
474026

2x
6132731

1x
6266911

1x
6117858

2x
371026

1x
6266679

5x
6240225

2x
6245277

1x
6273153

1x
6265071

1x
6101857

4x
6220561

1x
6263957

1x
6116613

1x
6114374

1x
6153863

4x
4211180

2x
6152107

2x
4535764



1x
6265264



1x
4268343

2x
4594238

1x
4211475



Customer Service

Kundenservice

Service Consommateurs

Servicio Al Consumidor

LEGO.com/service or dial



: 00800 5346 5555

: 1-800-422-5346

WIN

GO TO WWW.LEGO.COM/PRODUCTFEEDBACK AND
GIVE US YOUR SHORT **FEEDBACK** ABOUT THIS
LEGO® SET FOR A CHANCE TO WIN
A COOL LEGO PRIZE.

Terms & Conditions apply



LEGO.com/productfeedback

GEWINNE

Erzähle uns auf
www.LEGO.com/productfeedback

etwas über die Erfahrungen, die du
mit diesem LEGO® Set gemacht hast,
und sichere dir die Chance auf einen
coolen LEGO Preis!

Es gelten die Teilnahmebedingungen

GAGNE

Rends-toi sur
www.LEGO.com/productfeedback

et donne-nous quelques commen-
taires sur ce produit LEGO® pour
avoir une chance de gagner un
prix LEGO !

Voir Conditions Générales

GANAN

Visita
www.LEGO.com/productfeedback

y envíanos tu opinión acerca de este
set LEGO®. ¡Participarás en el sorteo
de un premio LEGO!

Términos y Condiciones aplicables

获取奖品

登录
www.LEGO.com/productfeedback

给出关于此乐高®套装的简短反
馈，就有机会获得炫酷乐高奖品

《条款及条件》适用

LEGO, the LEGO logo, NINJAGO and the NINJAGO logo are trademarks of the/son des marques de commerce du/son marcas registradas de LEGO Group. ©2019 The LEGO Group.

6282582/6282583