



CITY

60306



1





- 1** Scan the code on the front cover
Scanne den Code auf der Titelseite
Scanne le code sur la page de couverture
Scanner le code sur la page couverture
Scansiona il codice sulla copertina
Escanea el código de la portada
Faz scan do código na frente da capa
Olvasd be a borítón látható kódot!
Noskenē kodu uz priekšējā vāka
扫描封面上的二维码

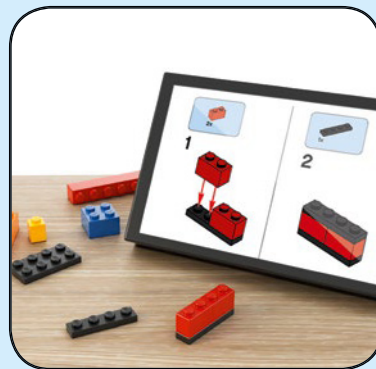

- 2** Get the Building Instructions
Hol dir die Bauanleitung
Obtiens les instructions de montage
Obtenir les instructions de montage
Scarica le istruzioni per la costruzione
Consulta las instrucciones de construcción
Obtém as Instruções de Construção
Szerezd be az építési útmutatókat!
Saņem būvēšanas instrukcijas
获取拼搭说明

LEGO.com/apps

Check for compatibility
Kompatibilität prüfen
Vérifier la compatibilité
Controlla la compatibilità
Comprueba tu compatibilidad

Verificar a compatibilidade
Ellenőrizd a kompatibilitást
Pārbaudīt saderību
检查兼容性

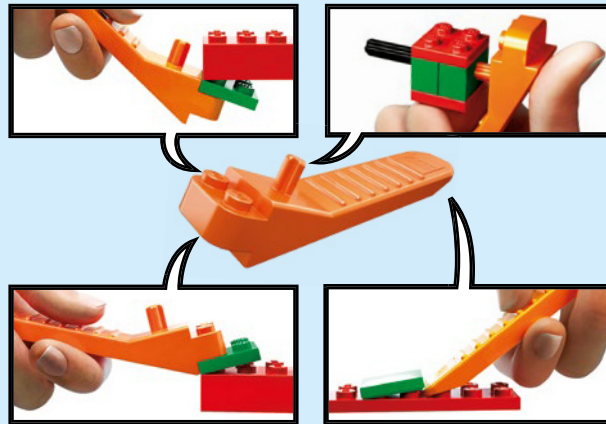

LEGO.com/brickseparator



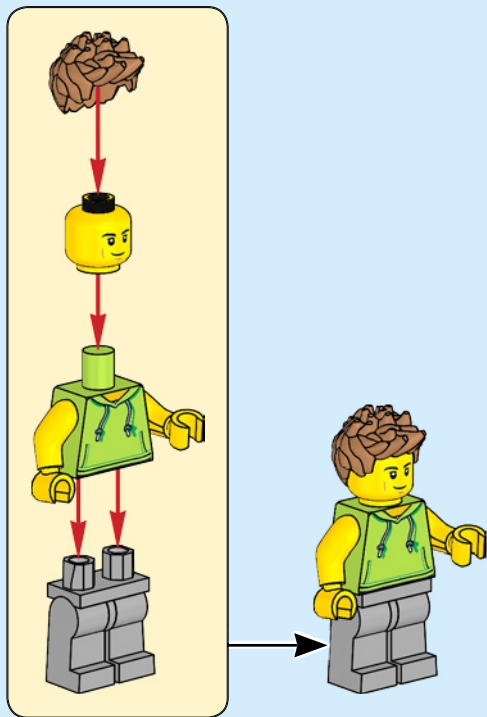
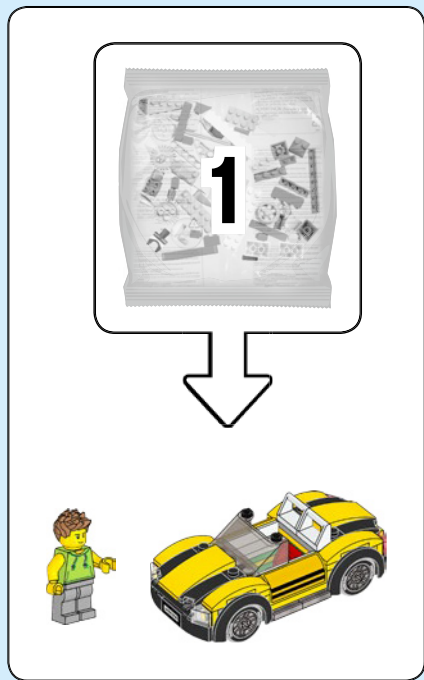

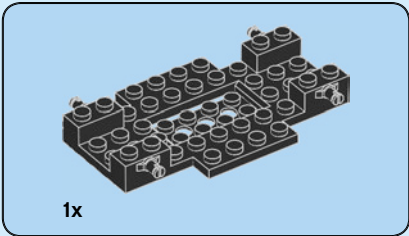
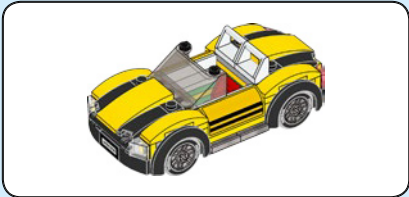

1

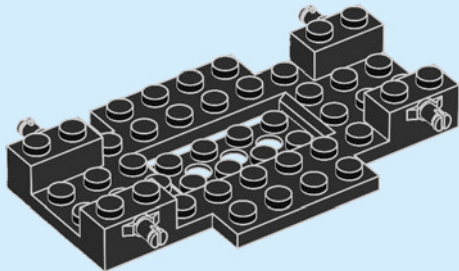

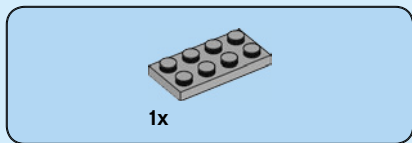

2

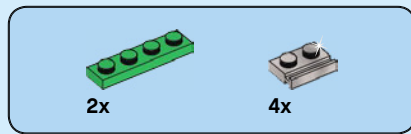
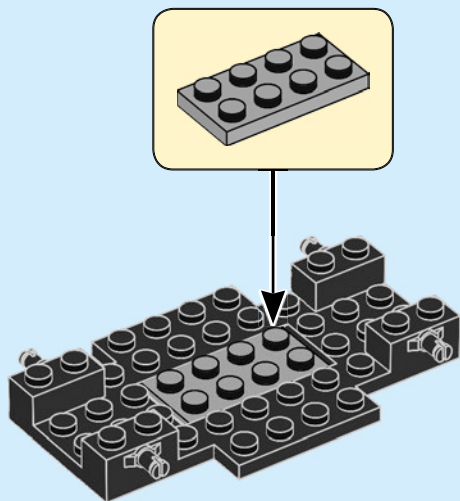

3

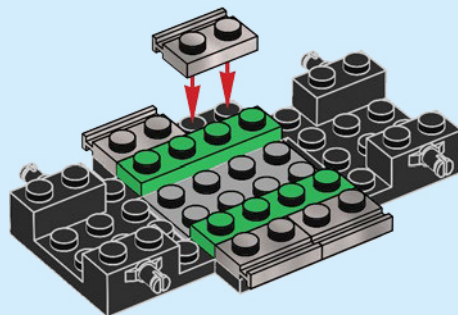



2x

4

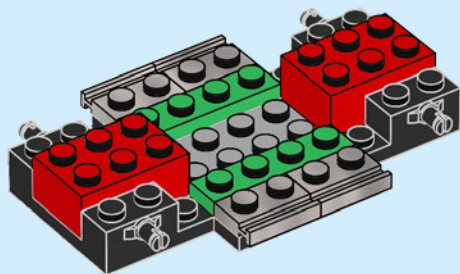

8



1x

5

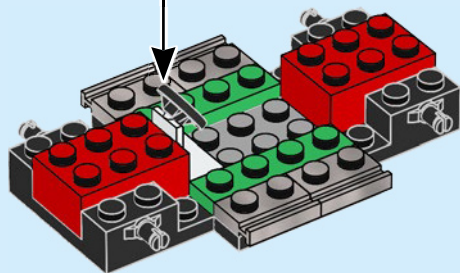

1x

6

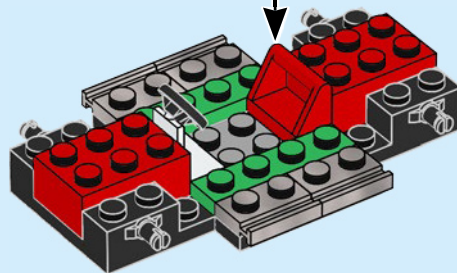
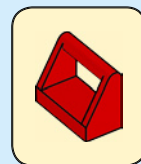

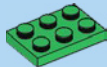

2x

7

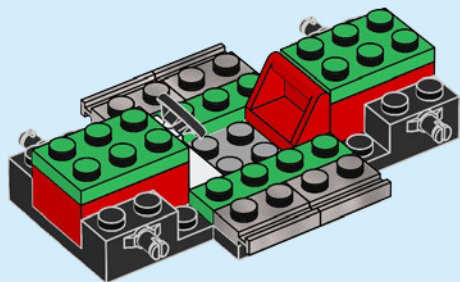

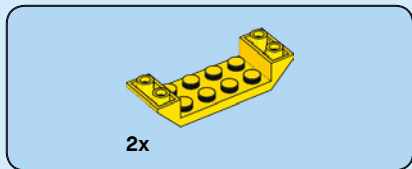

8

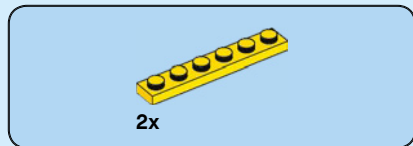
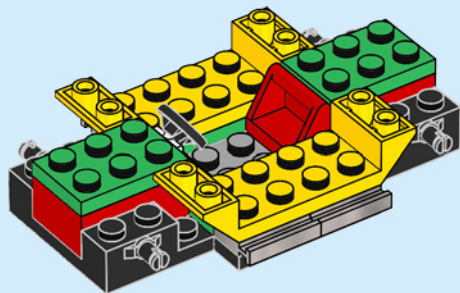

9

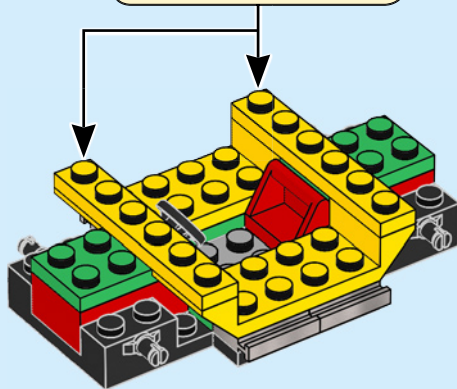
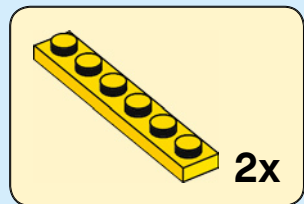



4x

10

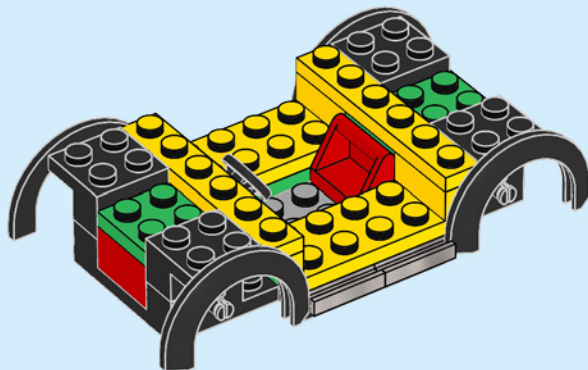

12

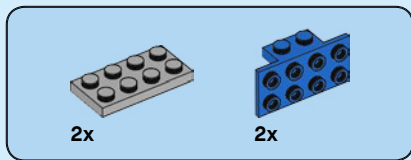

11

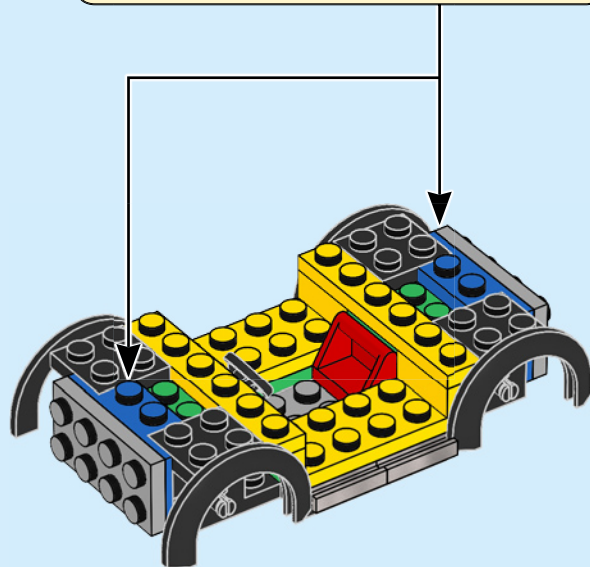
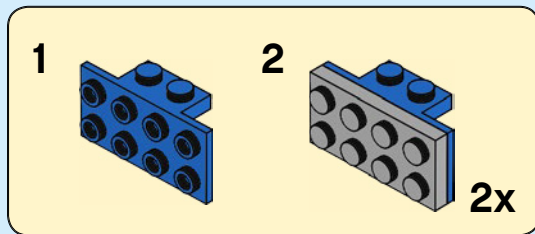

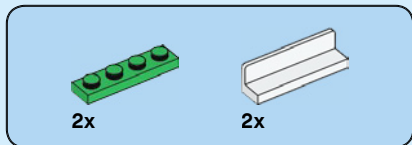

12

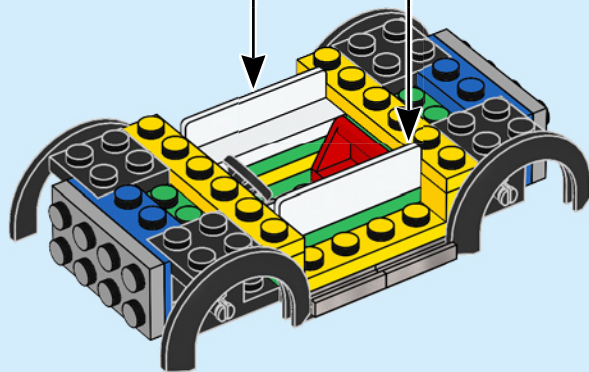
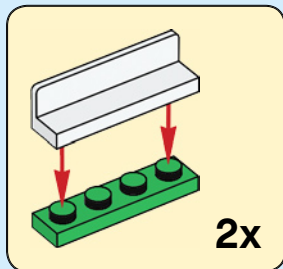

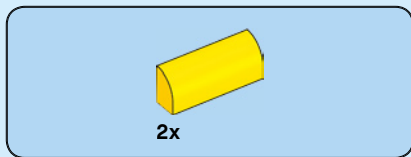

13

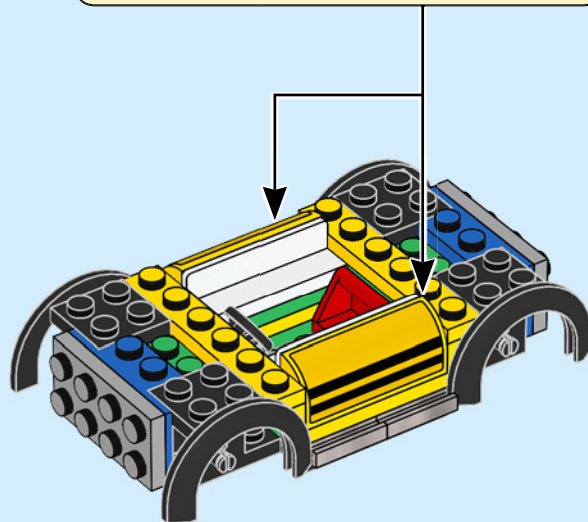
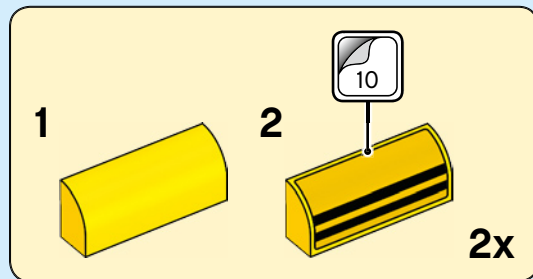



2x

14

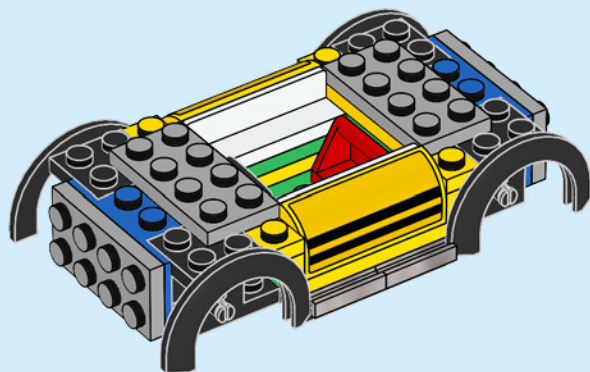

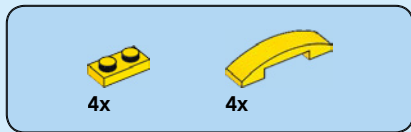

15

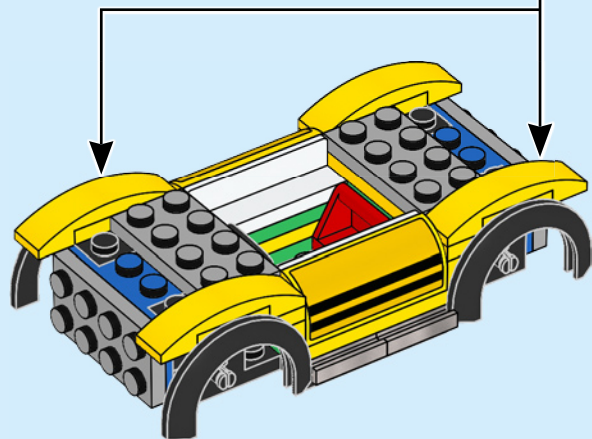
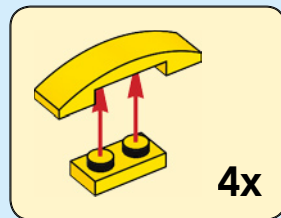



2x

16

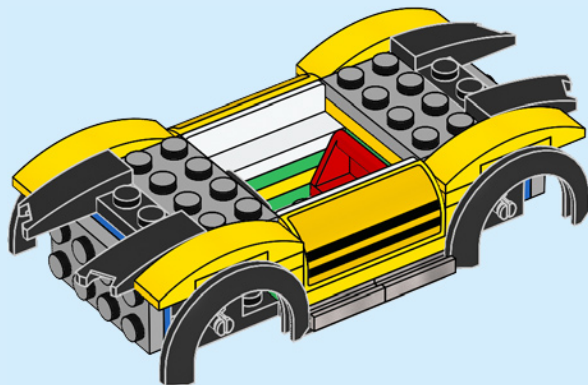

18

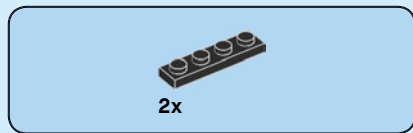

17

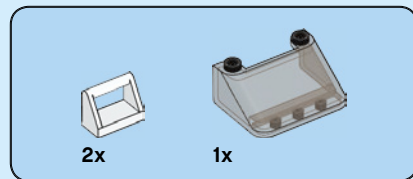
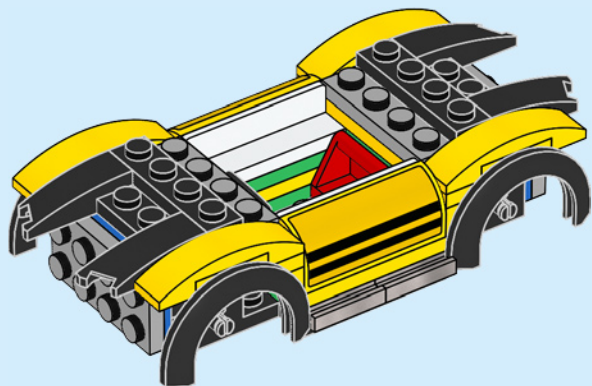

18

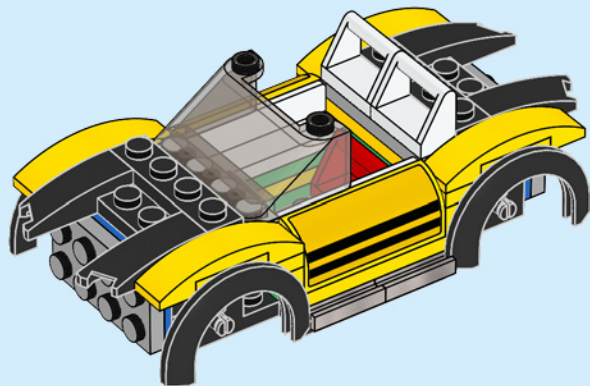



2x

19

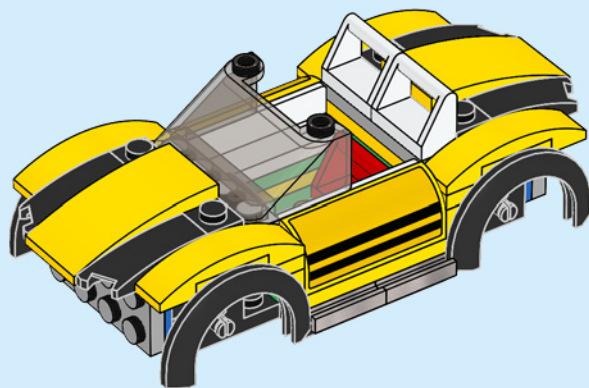

20

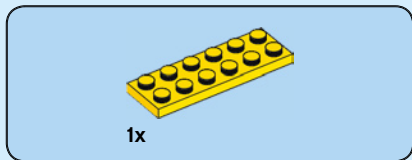

20

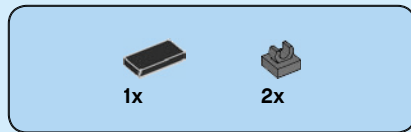
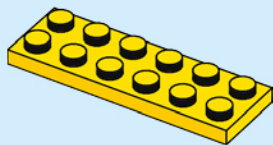

21

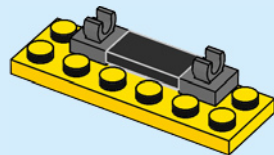



2x

22

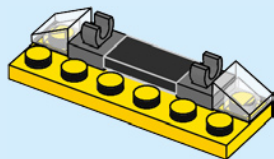

22



1x

23

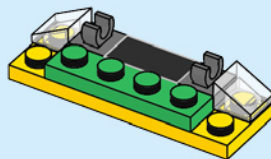



2x

24

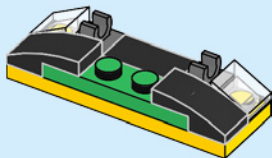

1x

25

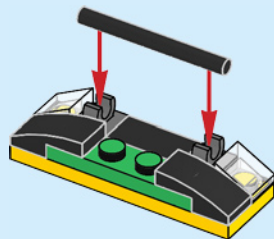



1x

26

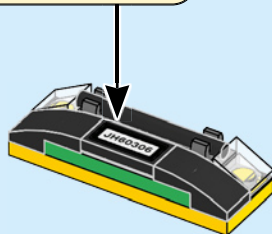
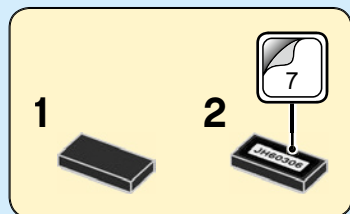

27

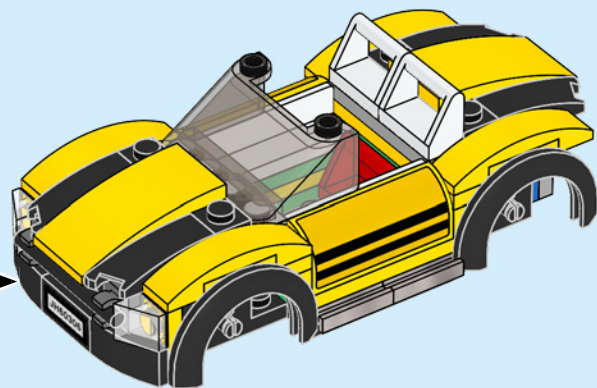

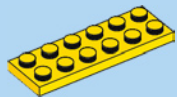

1x

28

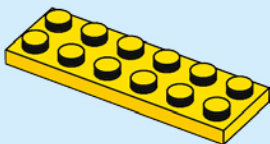

1x

29

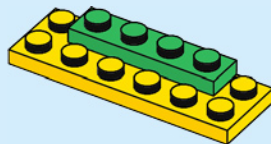



2x

30

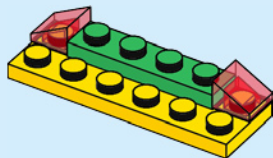

1x

31

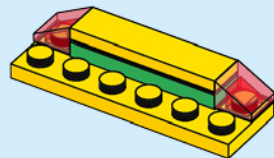



2x

32

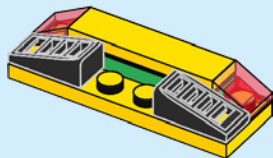

2x

33

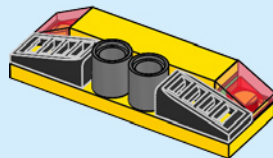

34

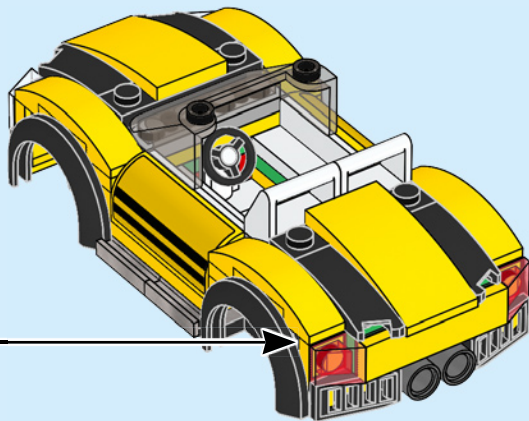
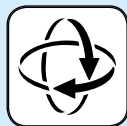



35

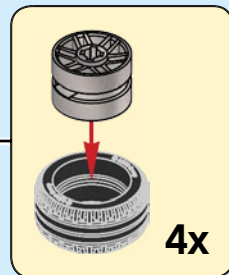
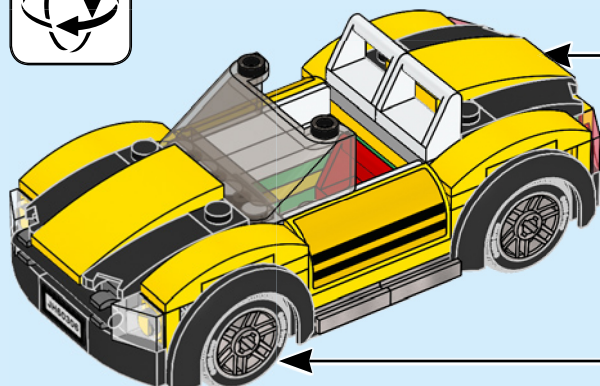
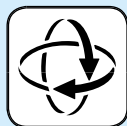

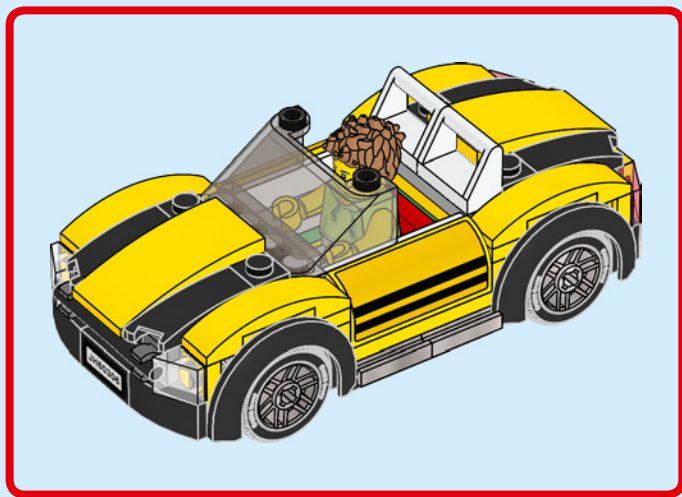

CITY ADVENTURES

City Abenteuer
Aventuras en City
City Aventuras
City kalandok
City piedzivojumi
乐高城市大冒险



VITO

60242



**SAM
GRIZZLED**

60243



**SNAKE
RATTLER**

60243 • 60276



**ROOKY
PARTNUR**

60244



**FRANKIE
LUPELLI**

60244 • 60277



**TOM
BENNETT**

60245



**BIG
BETTY**

60245



WHEELER

60246



**DAISY
KABOOM**

60246



**CLARA
THE CRIMINAL**

60276



**GRACIE
GOODHART**

60277



**DUKE
DETAIN**

60242 • 60246 • 60276



**FREYA
MCLOUD**

60248 • 60280



CLEMMONS

60247 • 60281



BOB

60282



FELDMAN

60282



**TREAD
OCTANE**

60258



**HARL
WIBBS**

60258 • 60266



**SHIRLEY
KEEPER**

60292



MADISON

60292

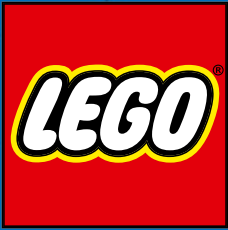

CITY

60306



2

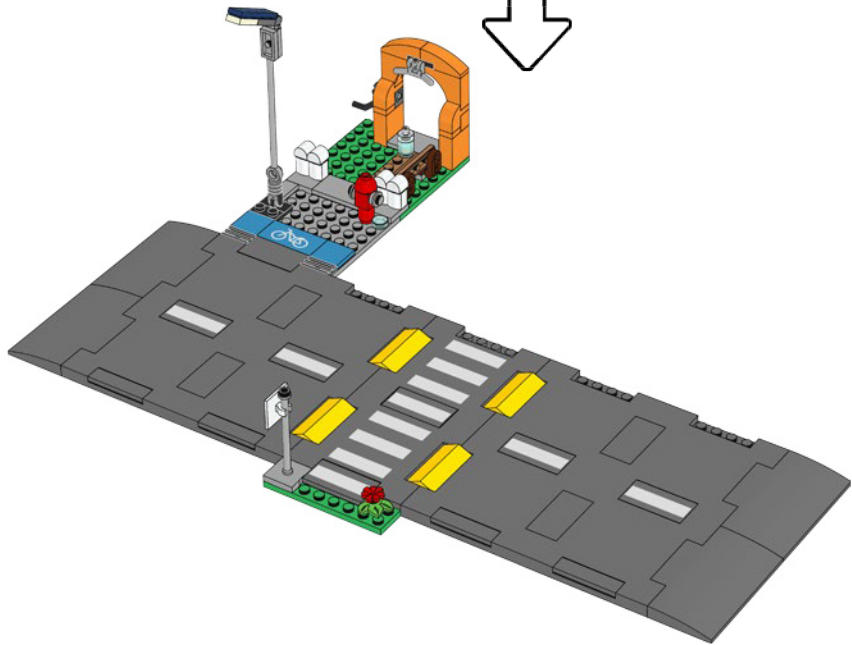
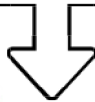
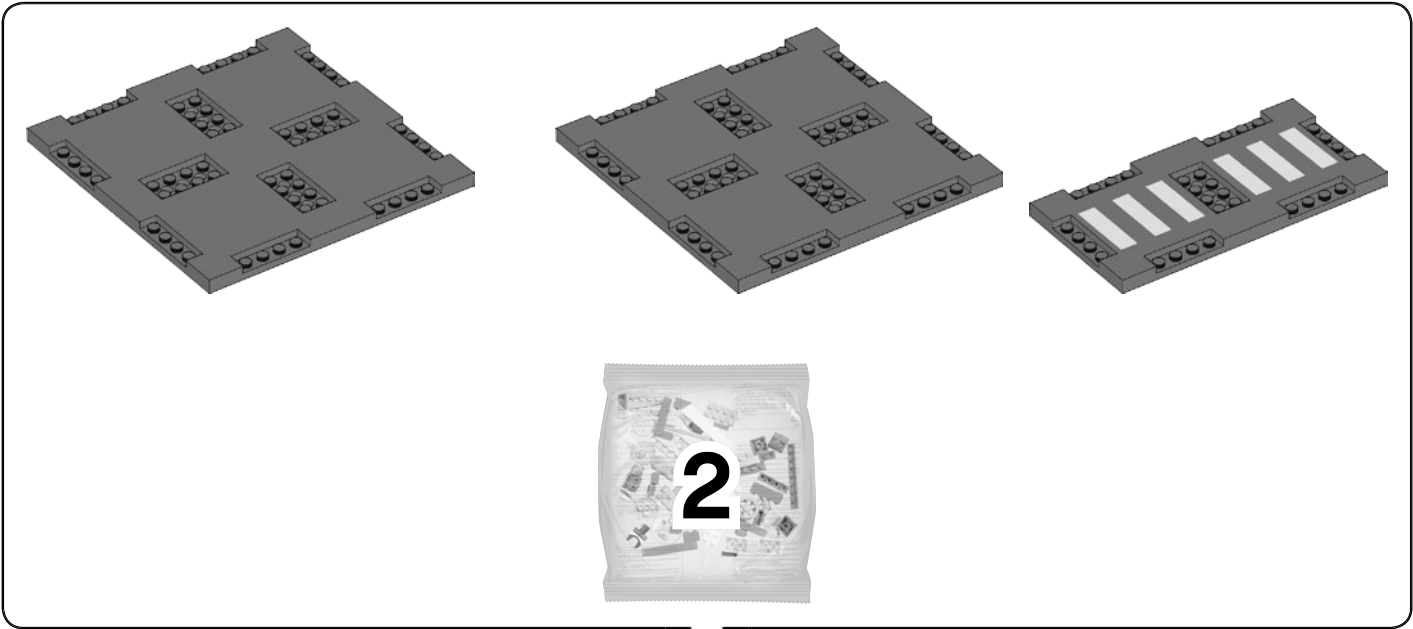

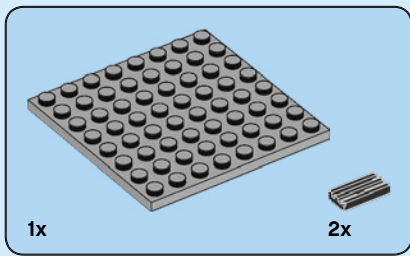

1

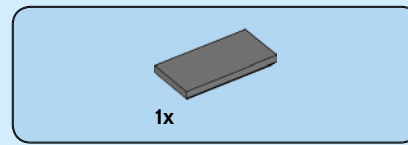
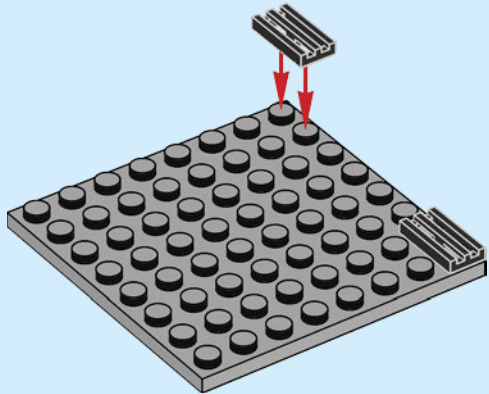

2

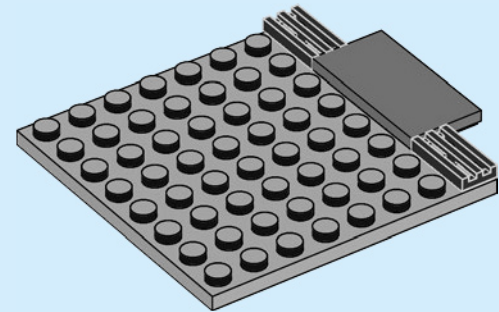

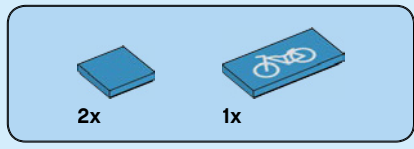

3

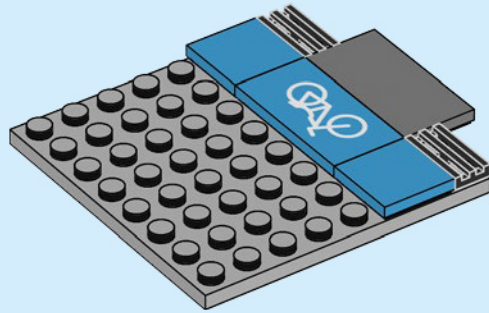

4



4

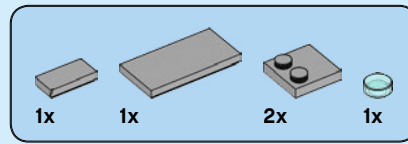
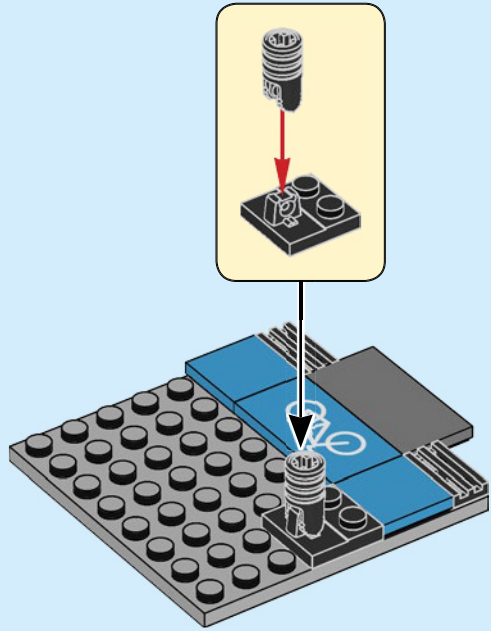

5

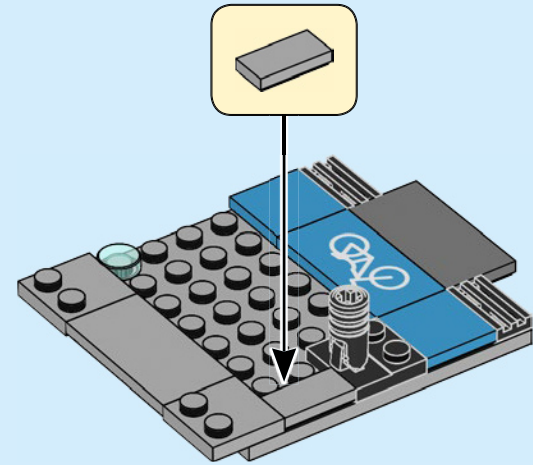

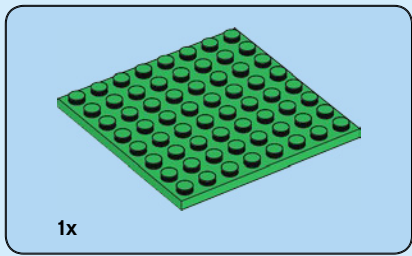

6

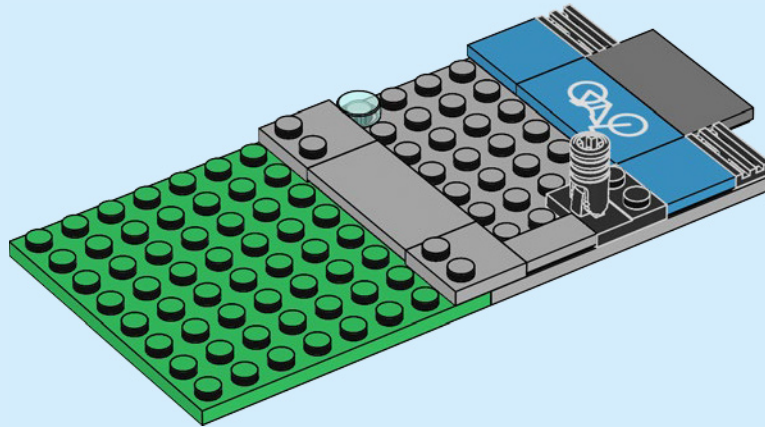



7

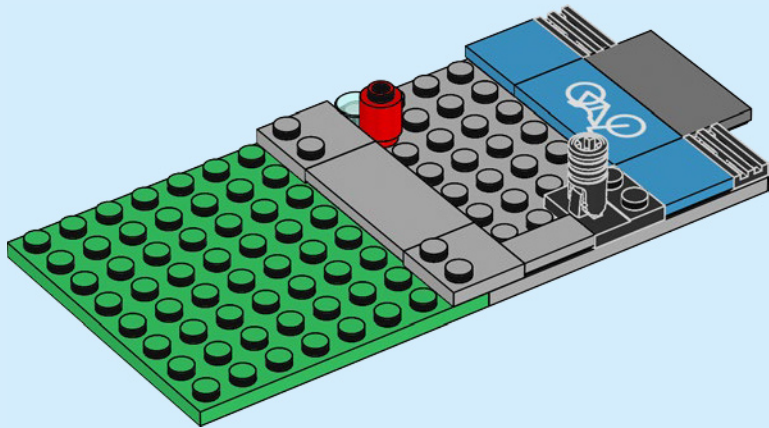

8

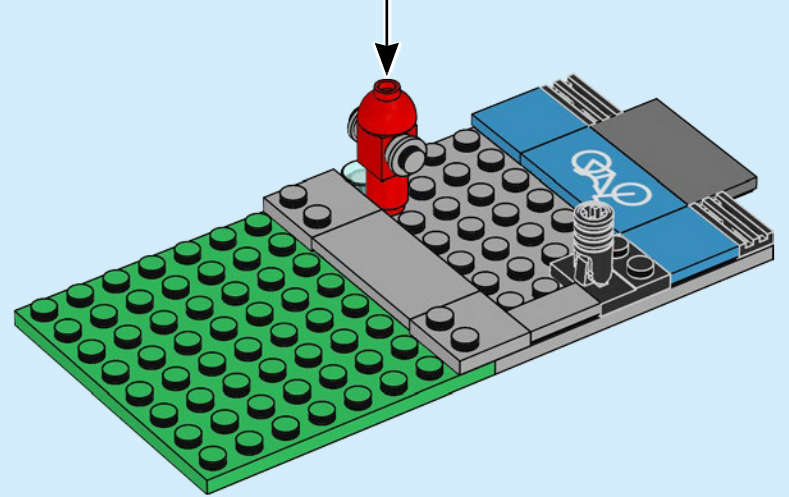
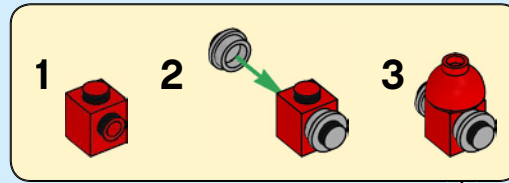

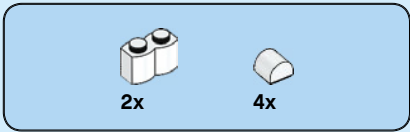

9

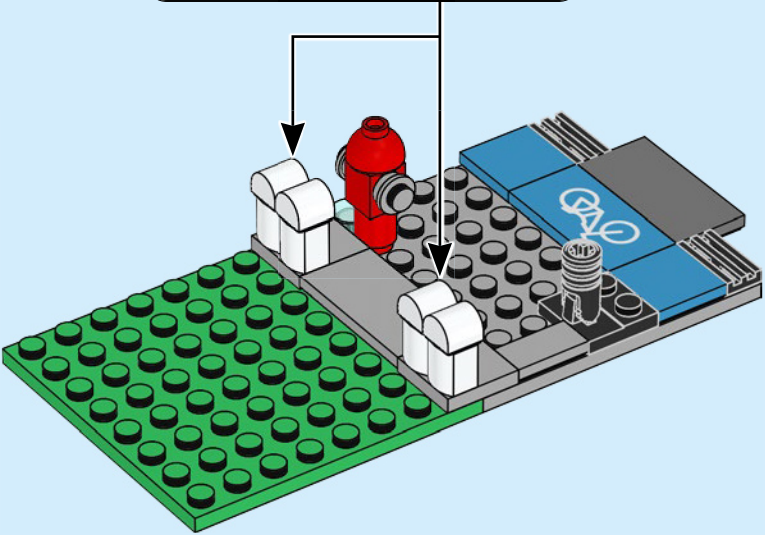
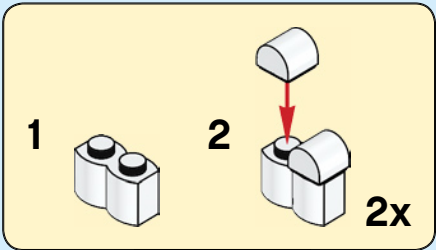

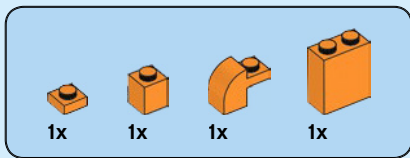

10

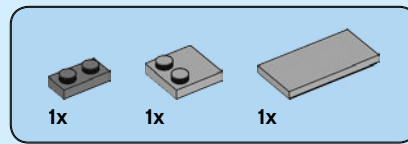
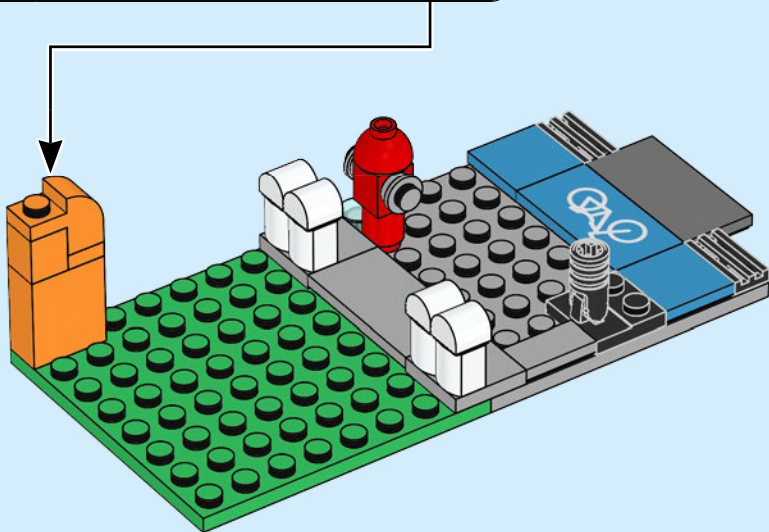
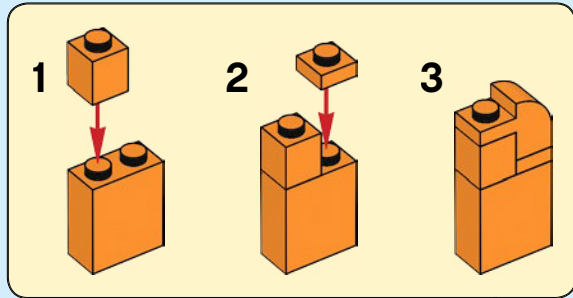

11

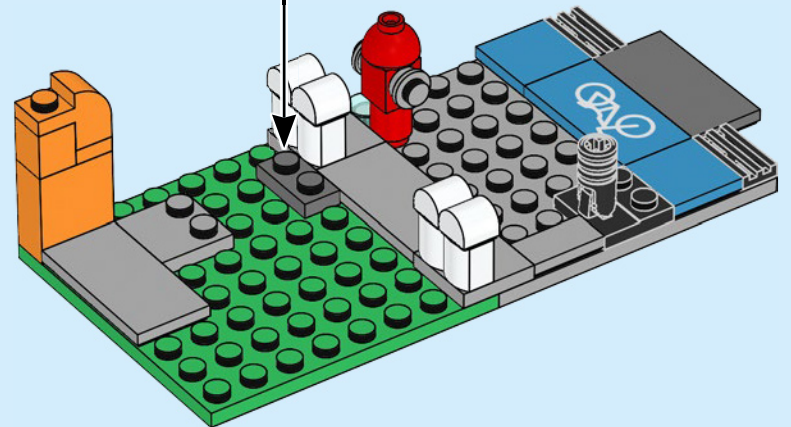
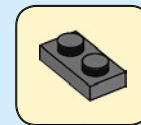

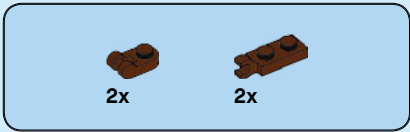

12

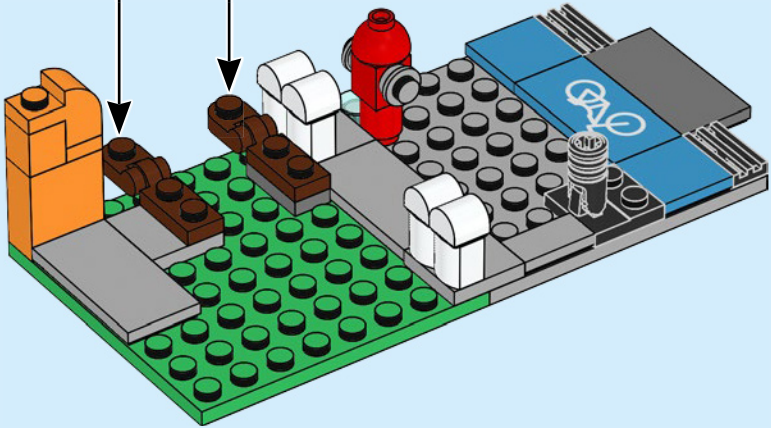
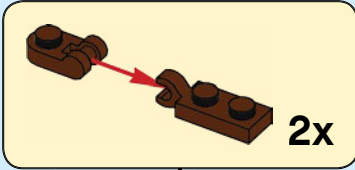

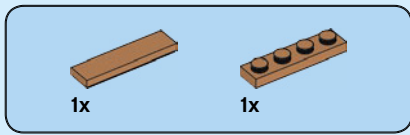

13

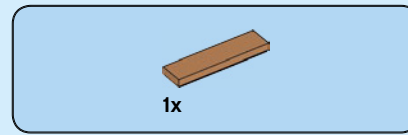
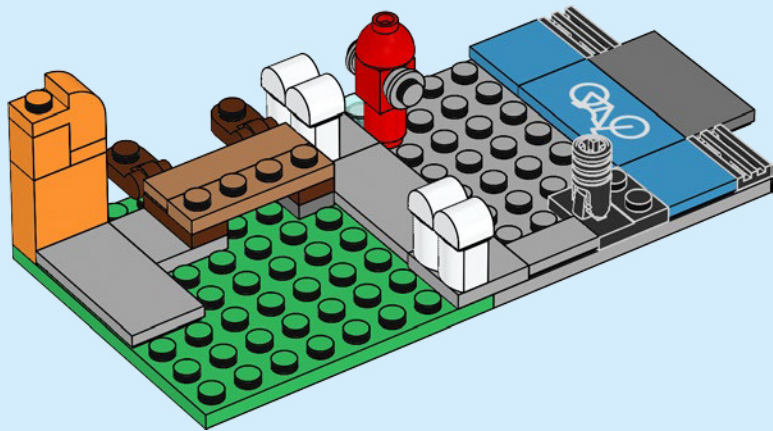

14

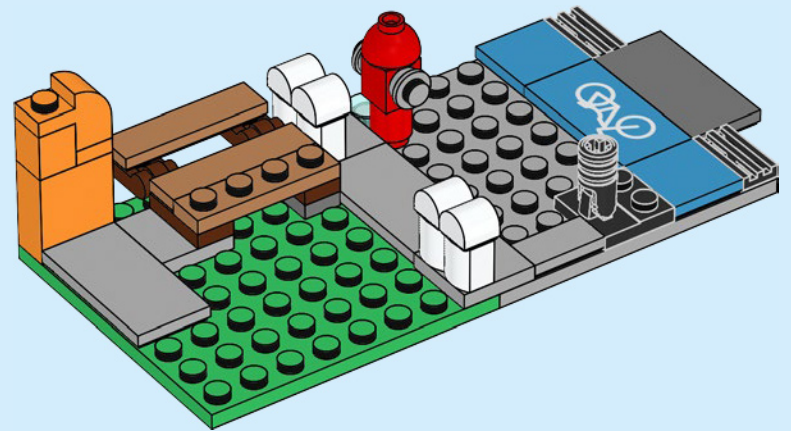



1x



1x

15

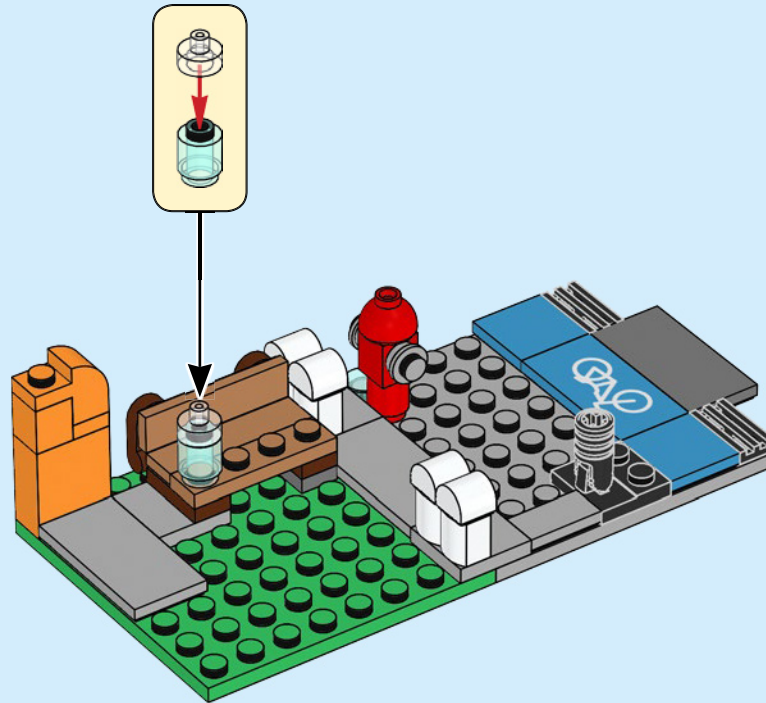

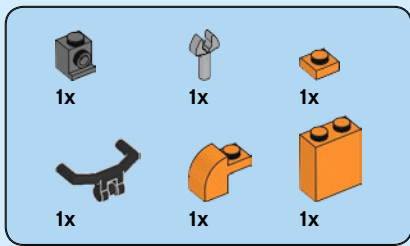

16

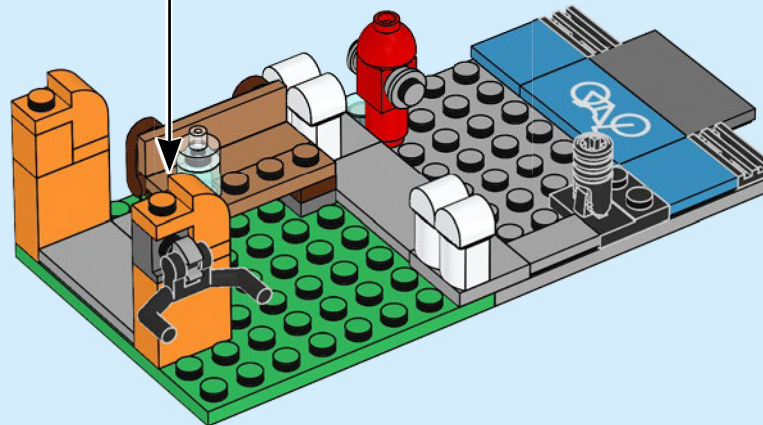
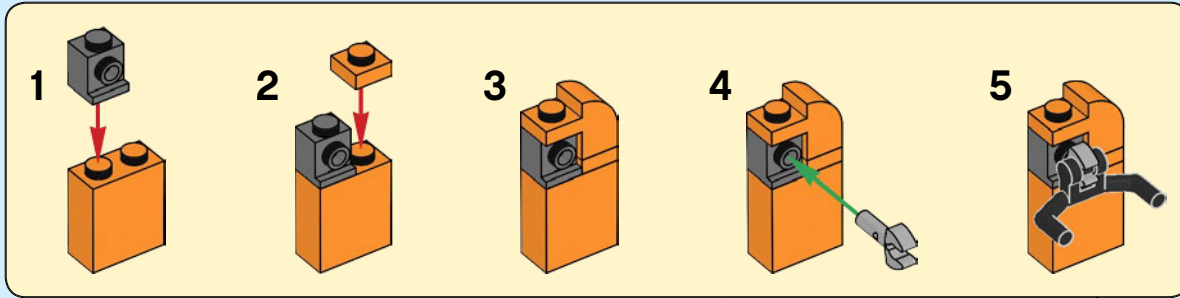

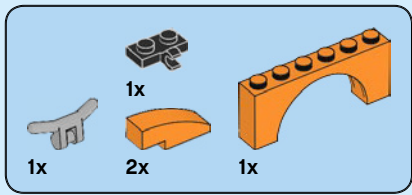

17

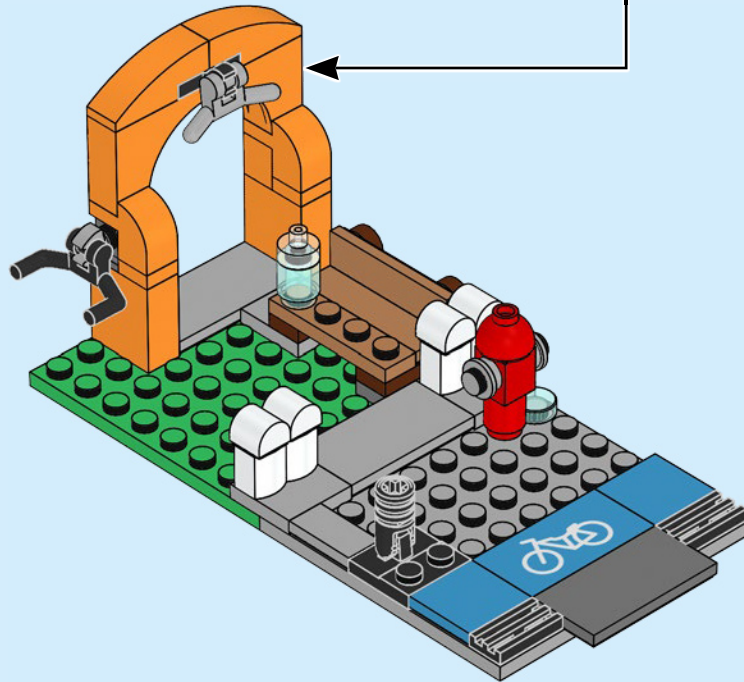
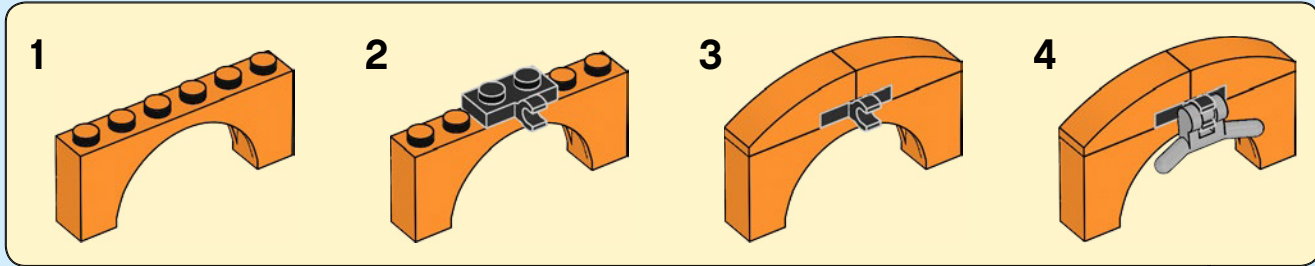

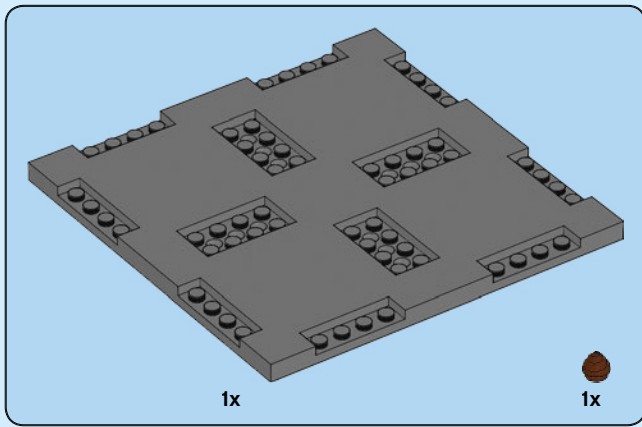

18

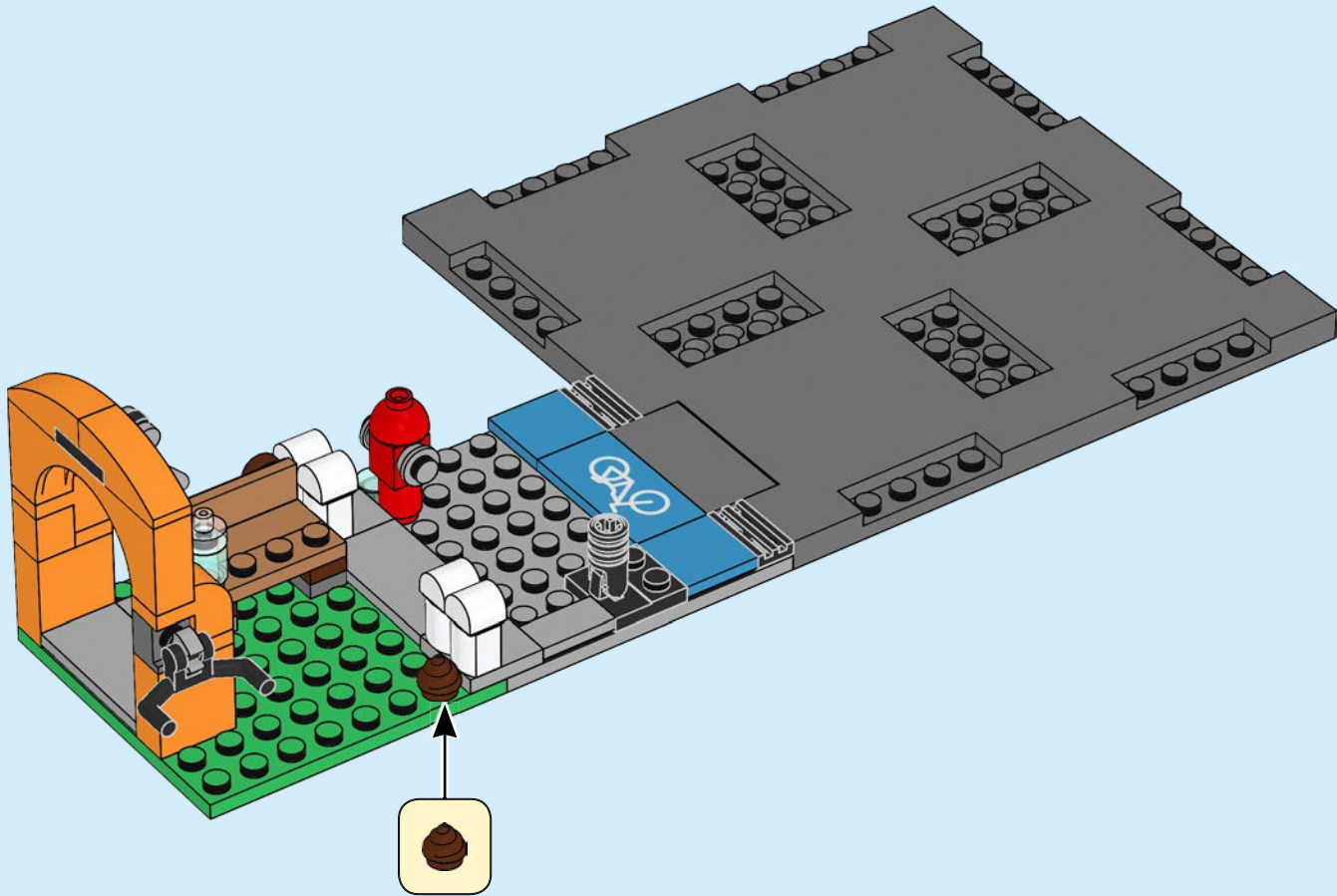

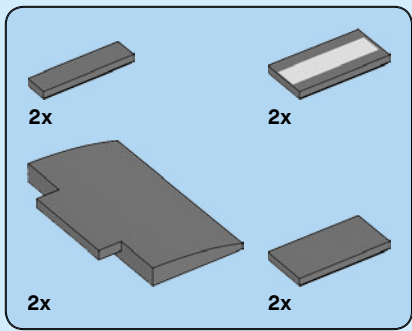

19

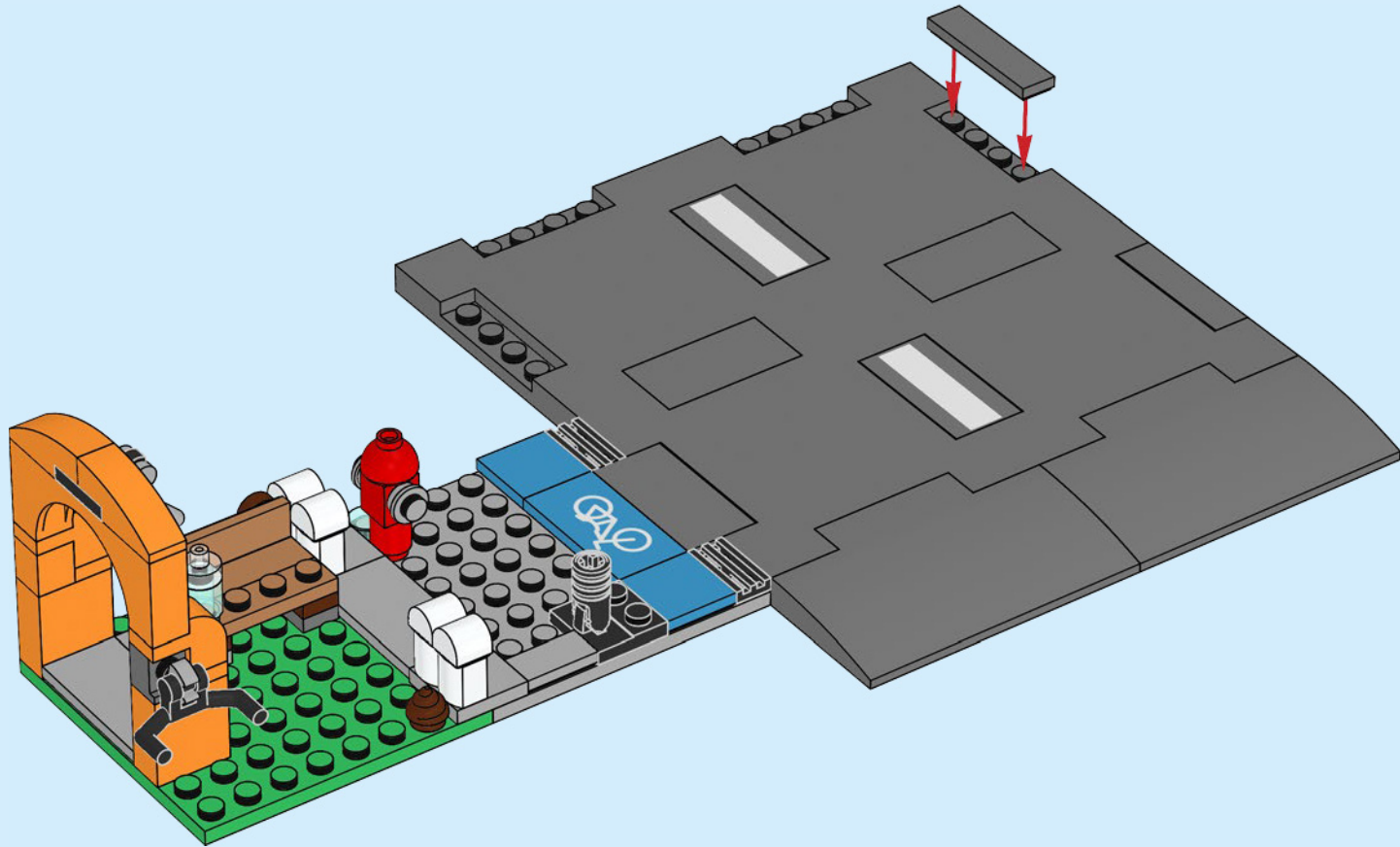

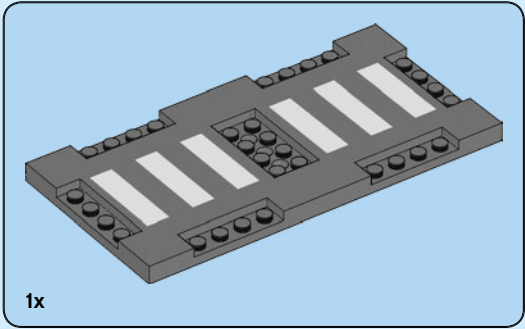
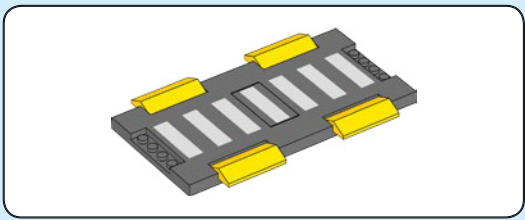

20

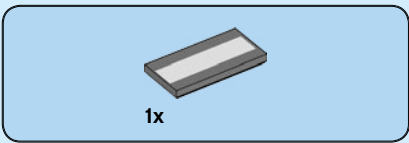
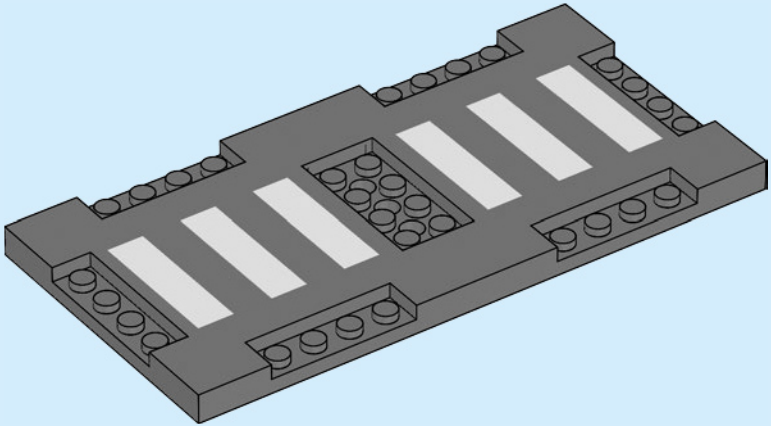

21

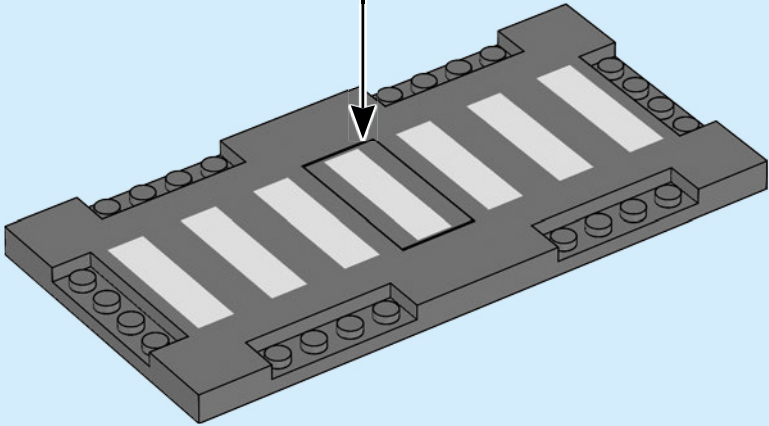
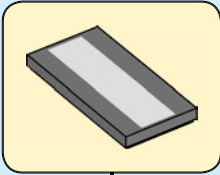

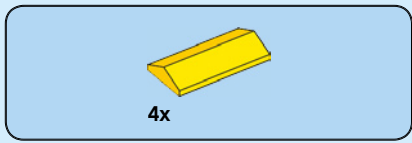

22

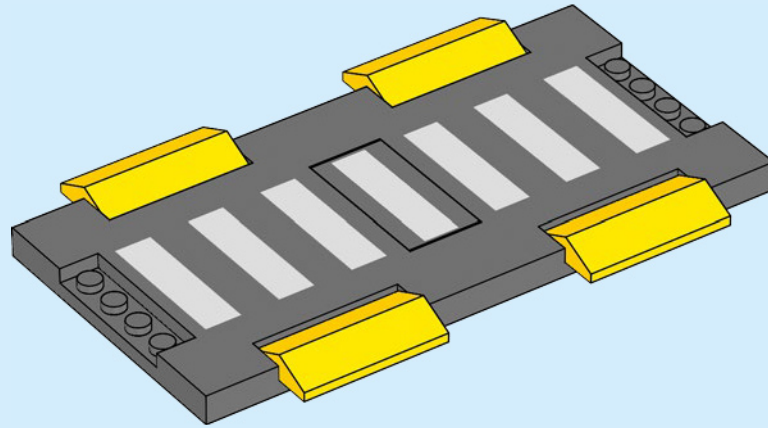

23

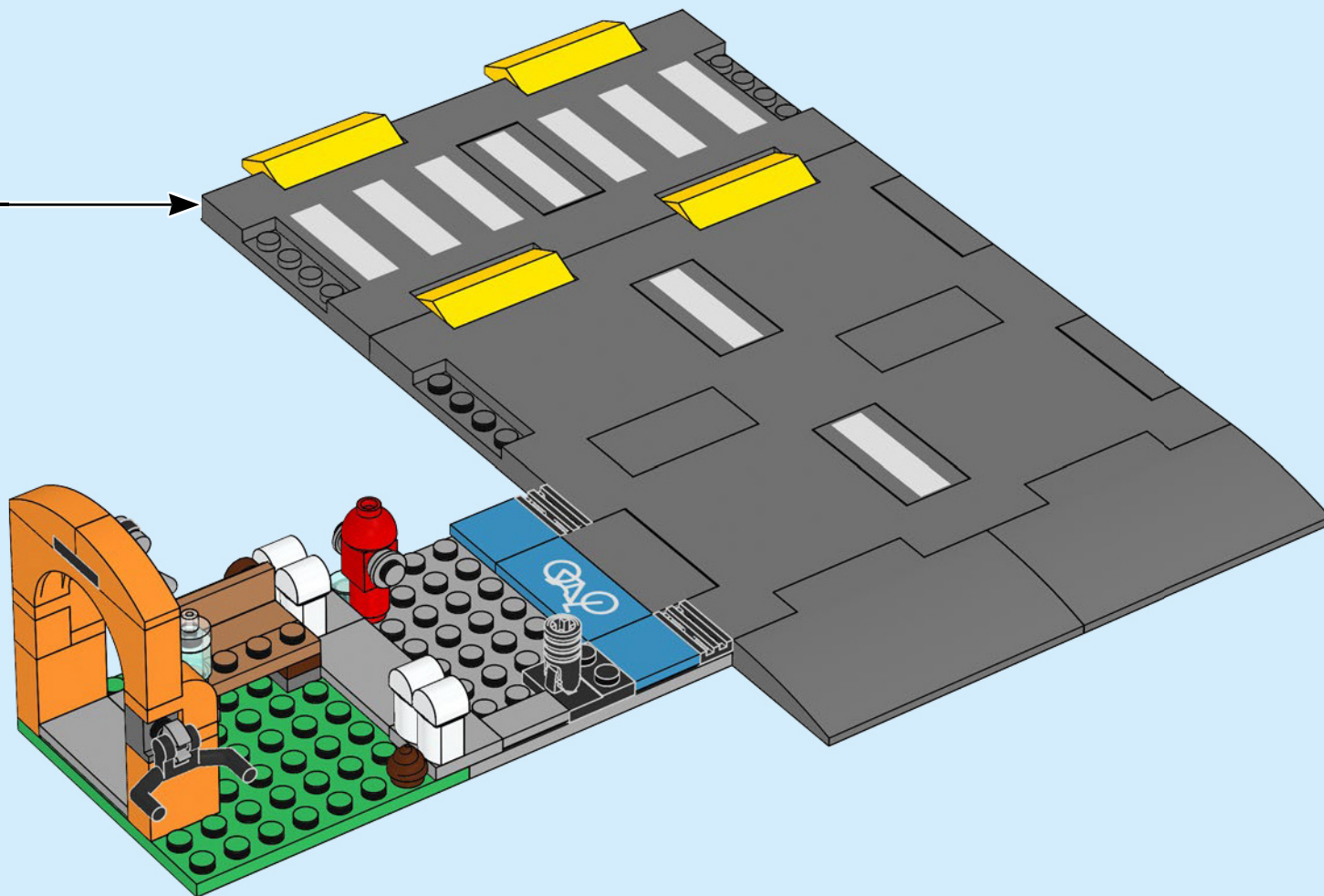

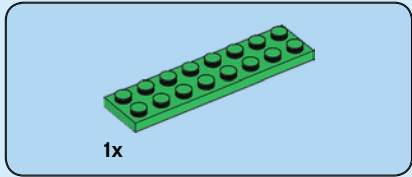
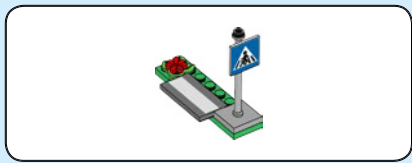

24

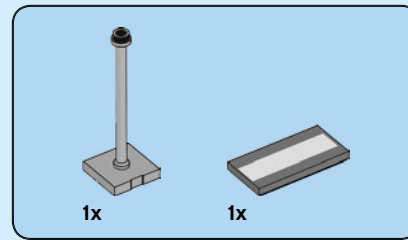
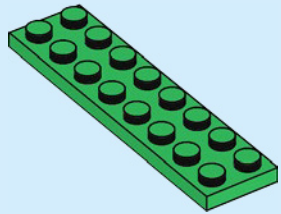

25

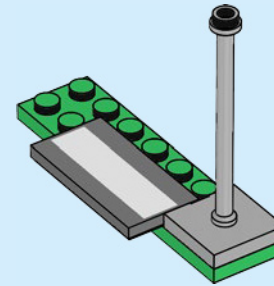



26

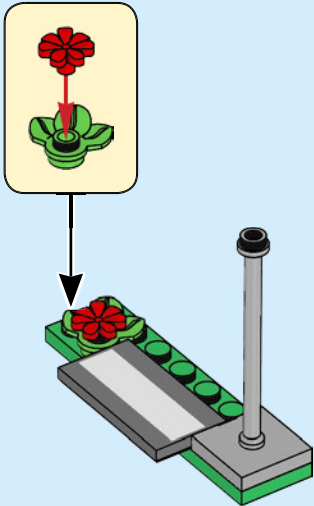

27

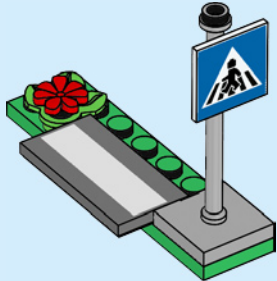

28

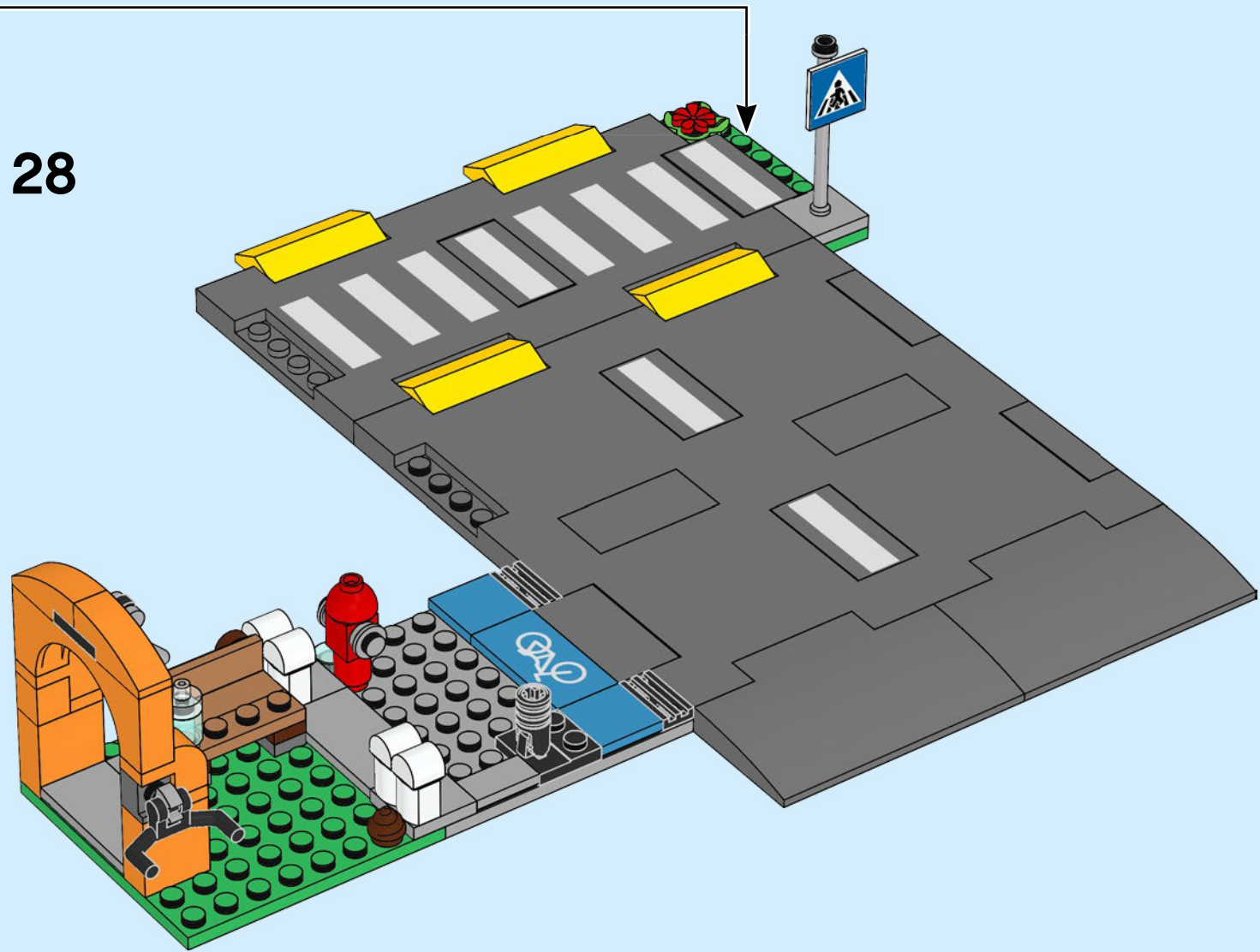

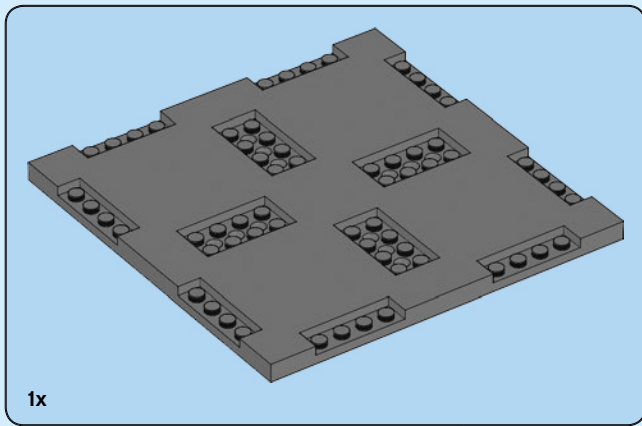

1x

29

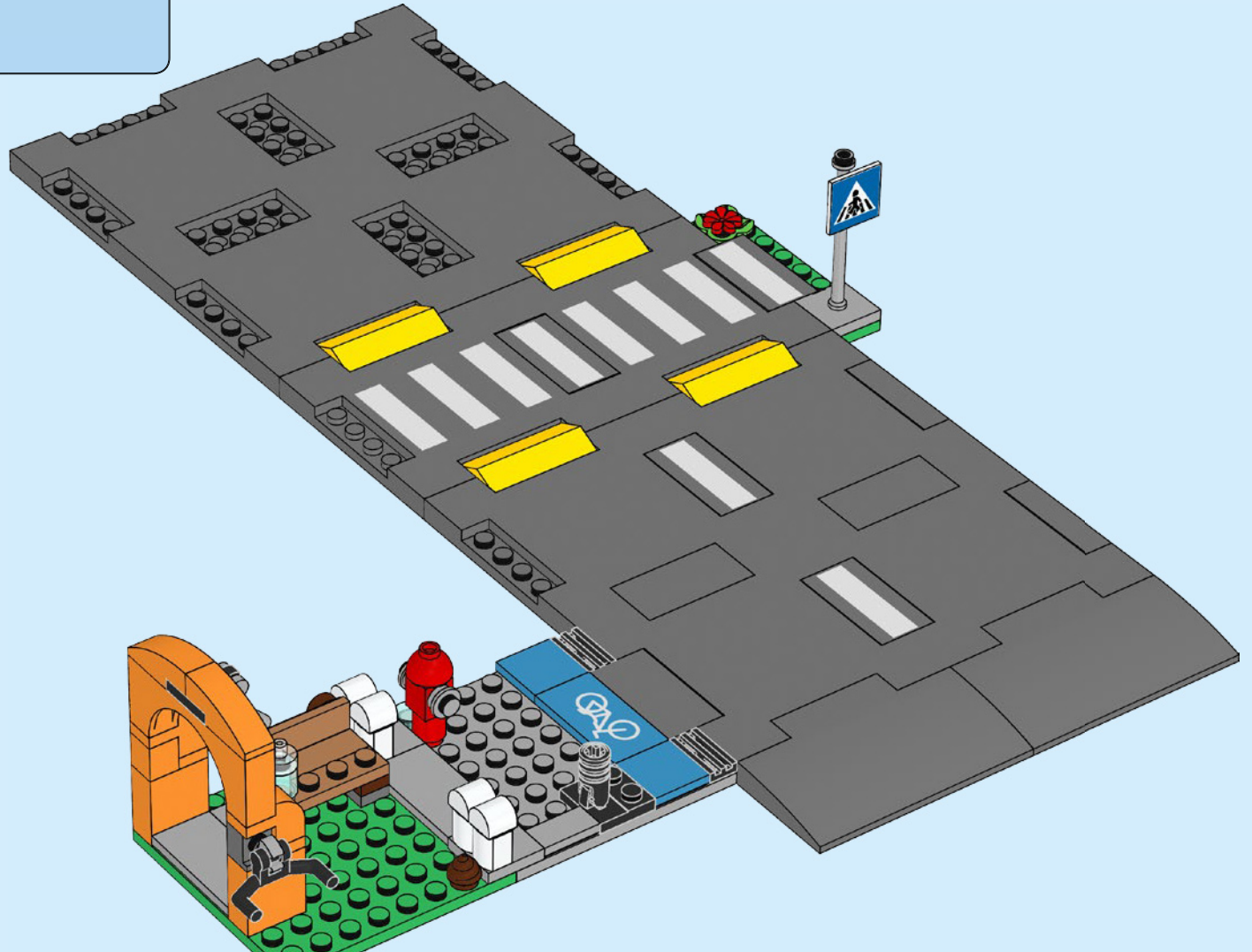

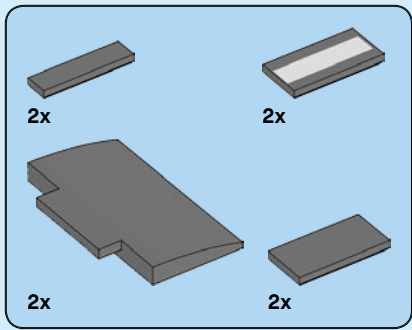

30

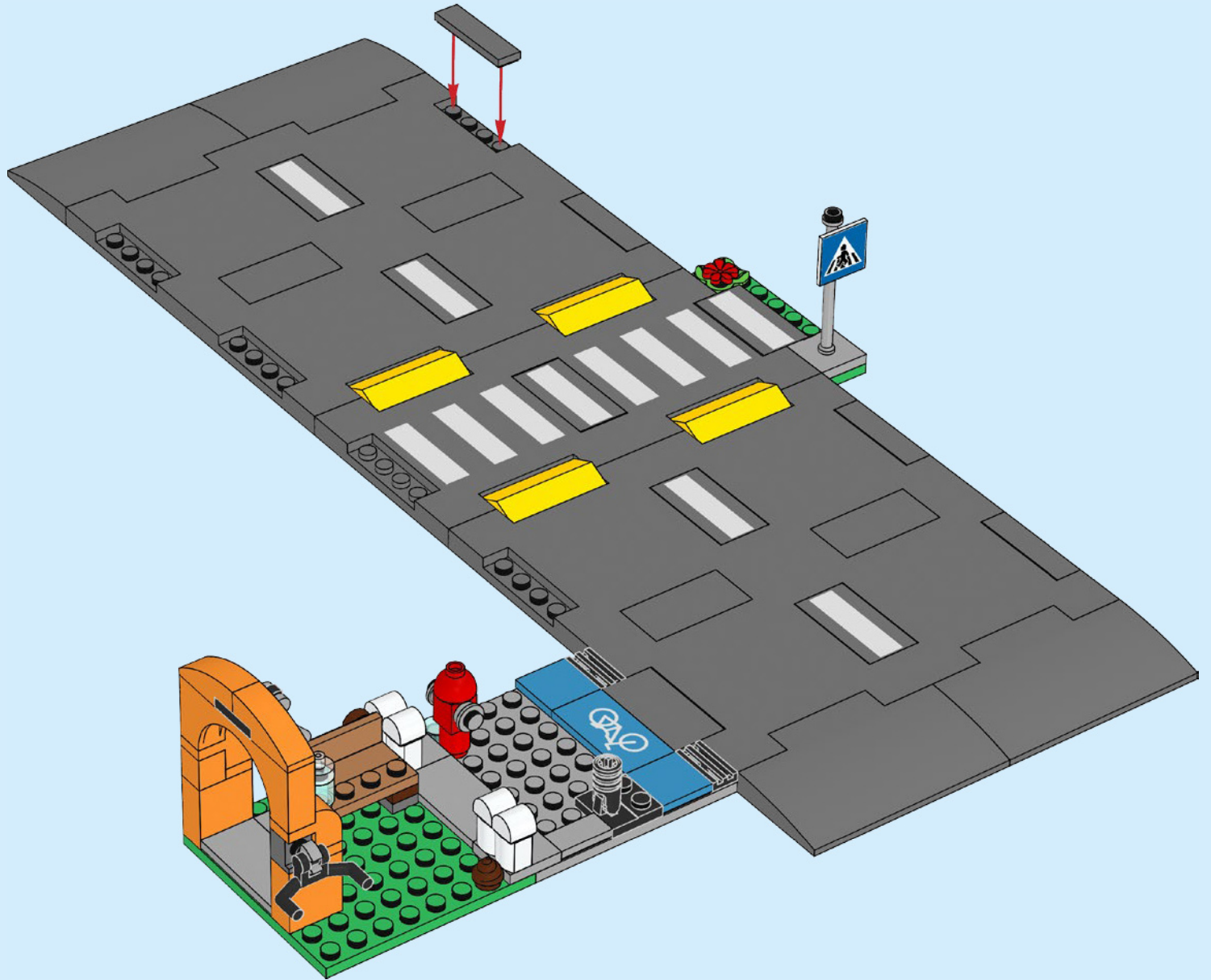

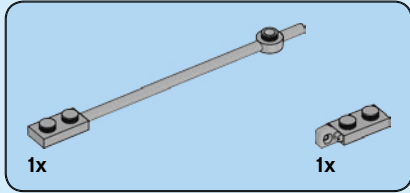
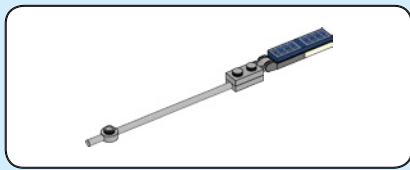

31

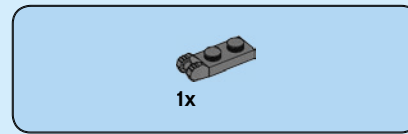
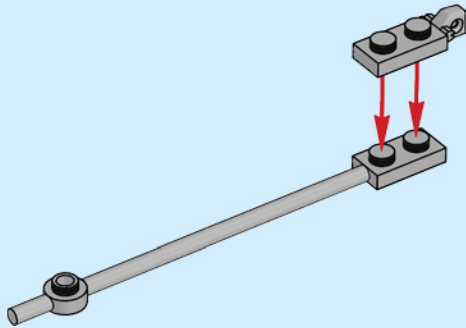

32

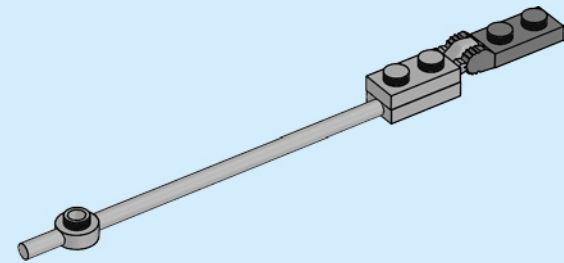

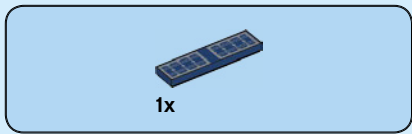

33

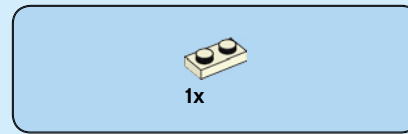
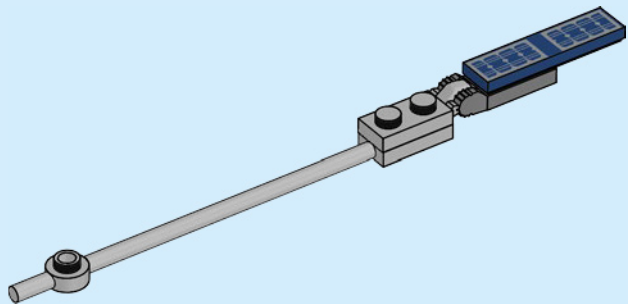

34

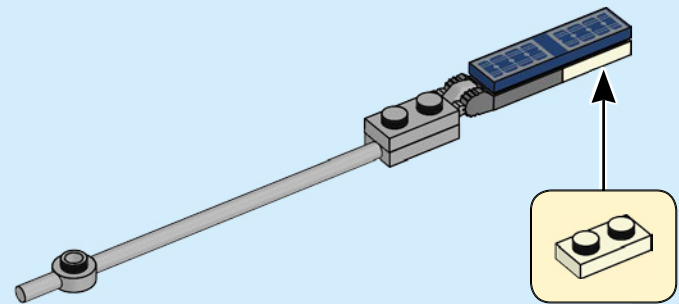

35

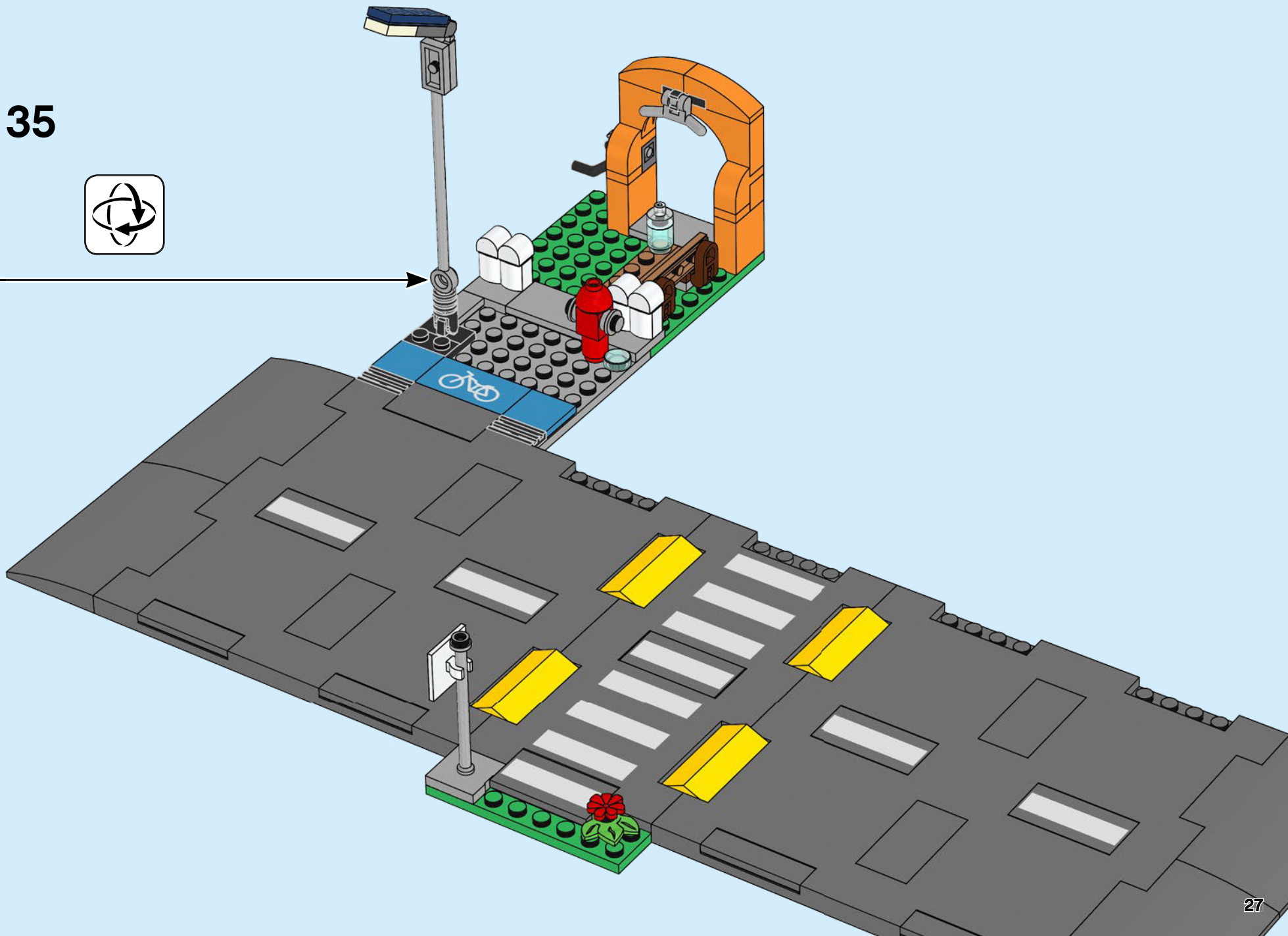

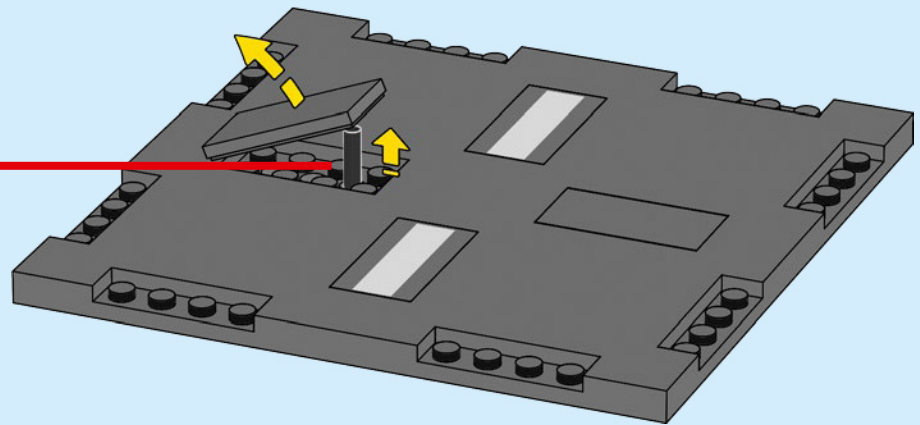
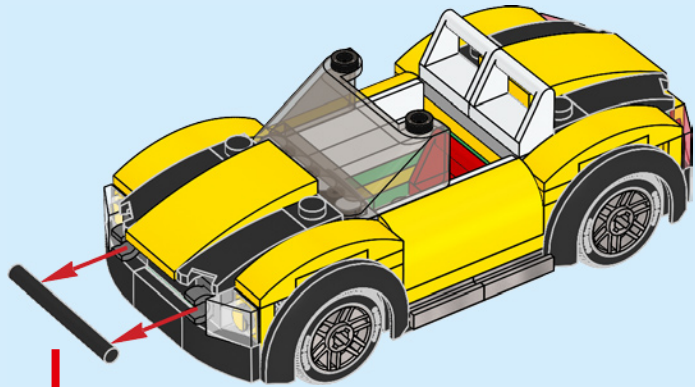

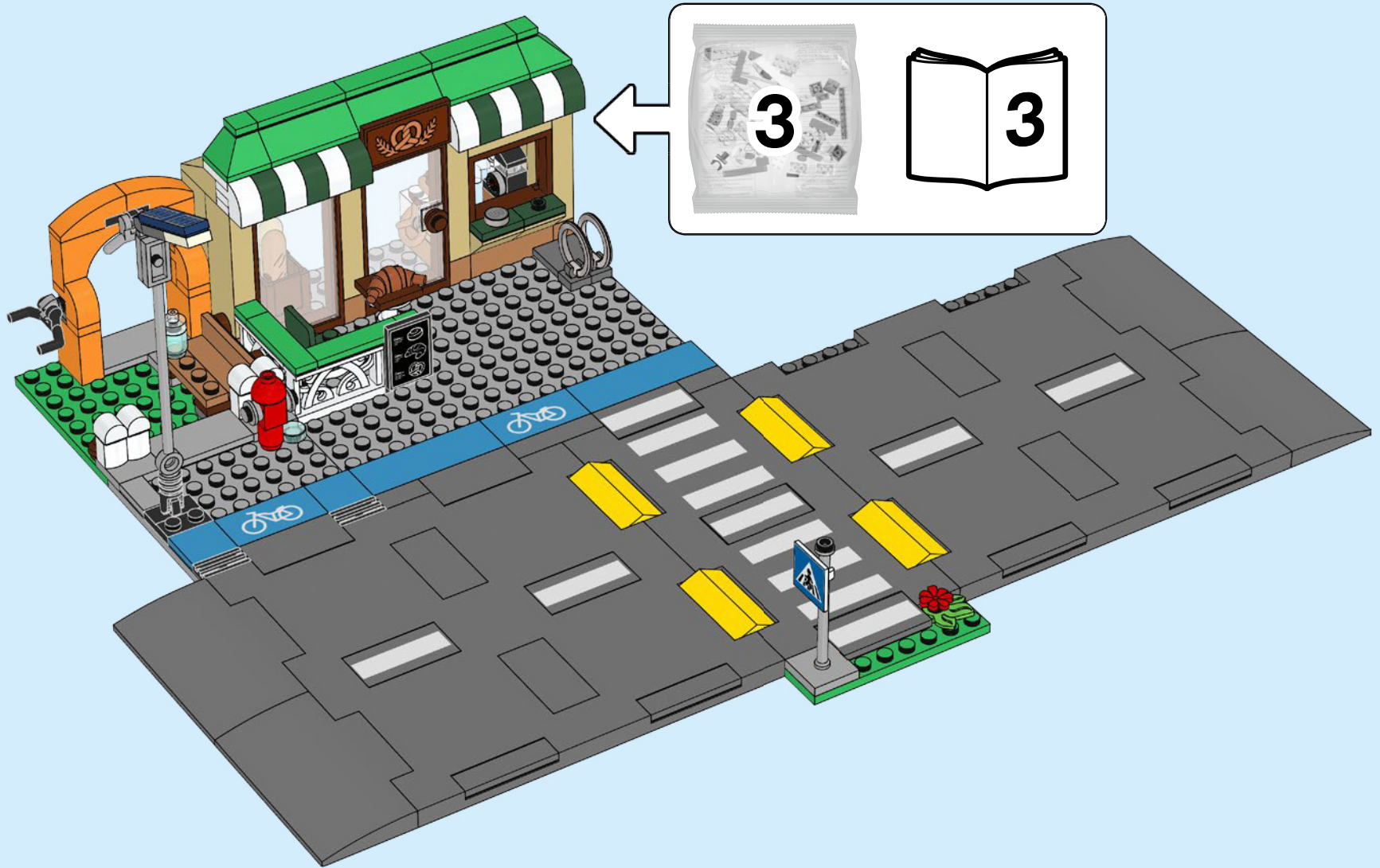

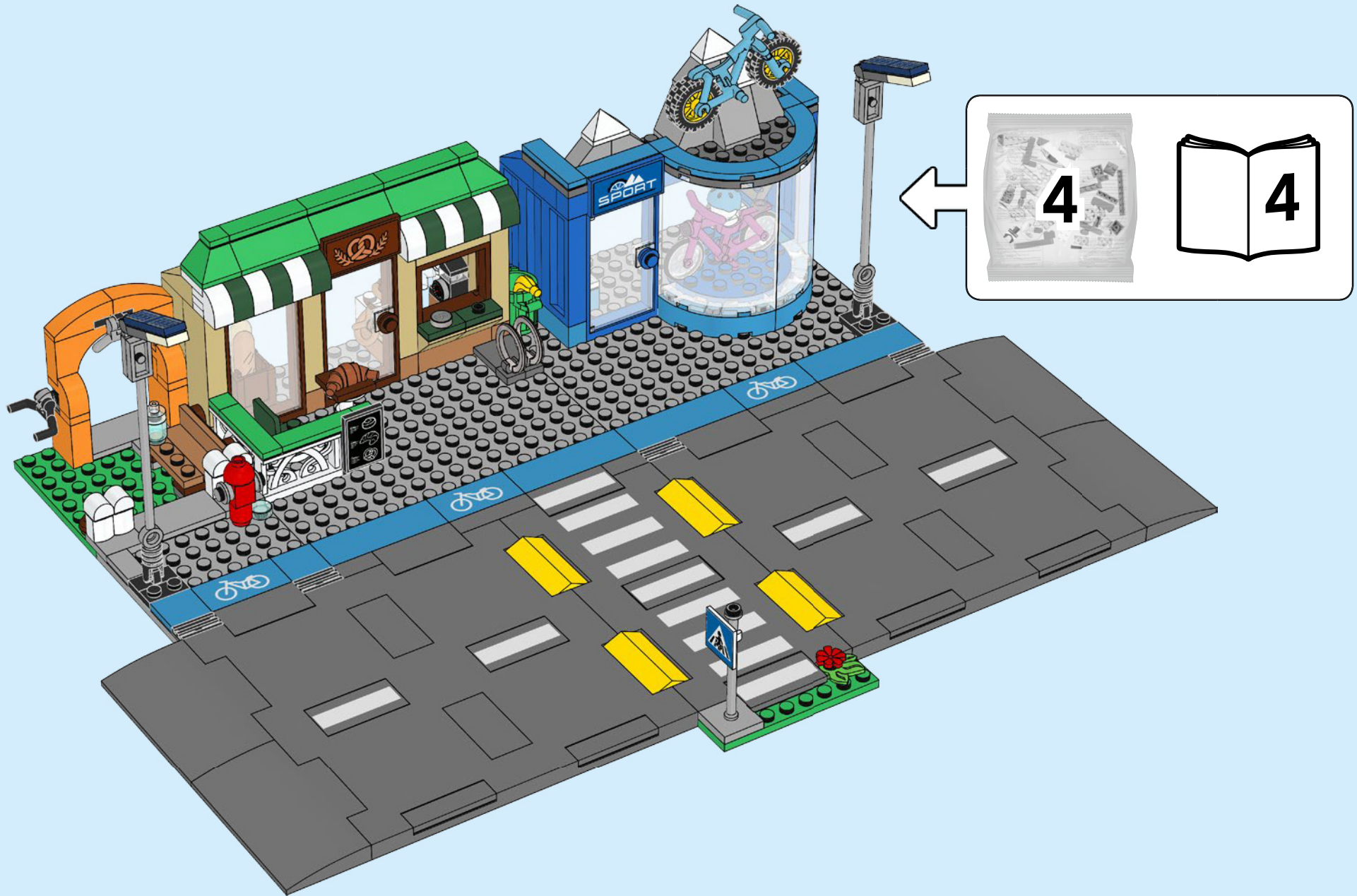







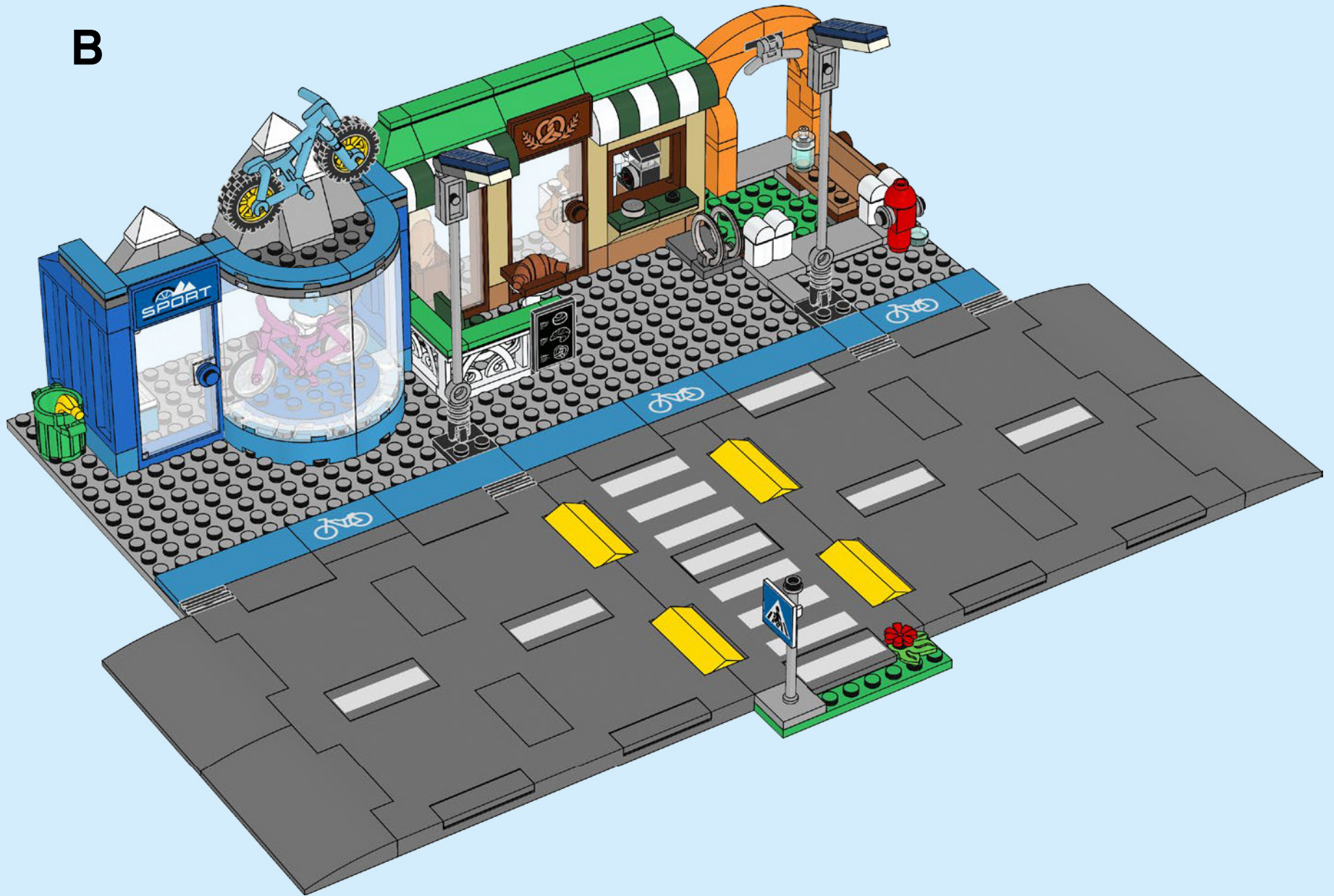

































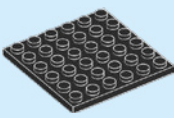

A

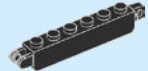

B

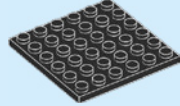

							
2x 4112980	2x 4190219	1x 300921	1x 614123	1x 6155272	4x 302324	1x 4558954	2x 6064174
							
1x 6092587	1x 6030266	3x 366621	1x 9341	1x 6153138	2x 302224	1x 6329579	8x 6029208
							
4x 4114064	2x 6345429	1x 4259903	3x 300423	1x 6219611	2x 408324	2x 6196548	2x 371026
						2x 6330189	
1x 6214334	1x 6177507	2x 428623	1x 243223	1x 6192789	4x 4613151	2x 6271535	2x 6179660
			1x 9566		2x 6057986	2x 4541191	
2x 4118866	3x 302321	2x 6194751	1x 6252060	1x 243124		2x 6313116	1x 366626
	6x 300421		1x 6328341		2x 6192835	1x 6313116	1x 6058118
2x 6058090	1x 243221		1x 6100249	1x 6338029	1x 6163633	3x 6047276	
	1x 4537986		1x 4651443		1x 4569382	6x 241226	1x 4517986
1x 4582437	1x 4537986	1x 4560180	1x 6283875	2x 6079001	1x 6226646	1x 6330197	1x 379526
	2x 6105976		1x 6153321	4x 366624	1x 6218360	1x 4618852	1x 6265688
1x 4113916	2x 366021	2x 6132335	1x 6174454	2x 379524	1x 4622738	3x 306926	
	1x 6182260		1x 6174454	2x 379524		2x 302326	
1x 306221	1x 4288209	1x 6096711	2x 302424	2x 6146800	2x 6187006	2x 302326	1x 395826
	2x 366021		1x 4114584			2x 6342135	
1x 6173572	1x 4288209	1x 6057905	2x 6338002	2x 4514844	2x 6102998	1x 6271542	1x 6285534
	4x 300221				4x 6223183		
1x 6337734	1x 243121						
1x 6177505							

2x
 302226

2x
 6265730

4x
 6092658

1x
 452226

1x
 6078610

1x
 6223896

1x
 400626

1x
 317626

1x
 6116604

1x
 6162892

1x
 302126

4x
 6170505

4x
 4260488

4x
 4558593

1x
 6182261

3x
 306928

1x
 4295260

2x
 300328

2x
 6234157

1x
 6171069

2x
 302128













6x
 371028

5x
 243128

3x
 4141737

1x
 303428

1x
 4161677

1x
 6329604

2x
 6207840

4x
 6218226

2x
 4619636

4x
 6132264

1x
 6338007

1x
 6093518

1x
 6303099

2x
 6258607

2x
 6245252

1x
 6138657

1x
 6341328

1x
 6186867

4x
 6245250

1x
 6252041

1x
 6238856

3x
 6163986

2x
 6246888

2x
 6236111

1x
 6256058

2x
 6247362

1x
 6255922

2x
 4524929

1x
 4173805

2x
 6112356

2x
 6078590

2x
 4251969

1x
 6337195

1x
 6240515

1x
 6102597

1x
 4524098

1x
 6120224

1x
 4530129

2x
 6215341

5x
 6331687

1x
 6247359

1x
 4216581

1x
 6275030

2x
 6153863

1x
 6269973

2x
 6338135















1x
 4565394













1x
 4520638

1x
 4595889

2x
 6262952

1x
 4579690

4x
 6274747

4x
 6251306

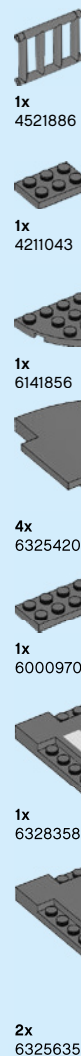
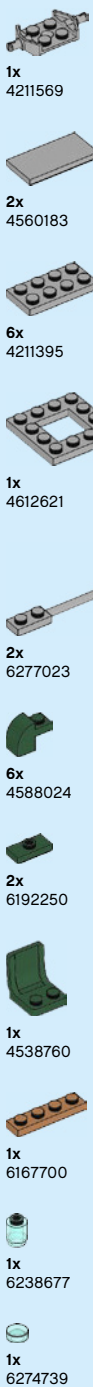
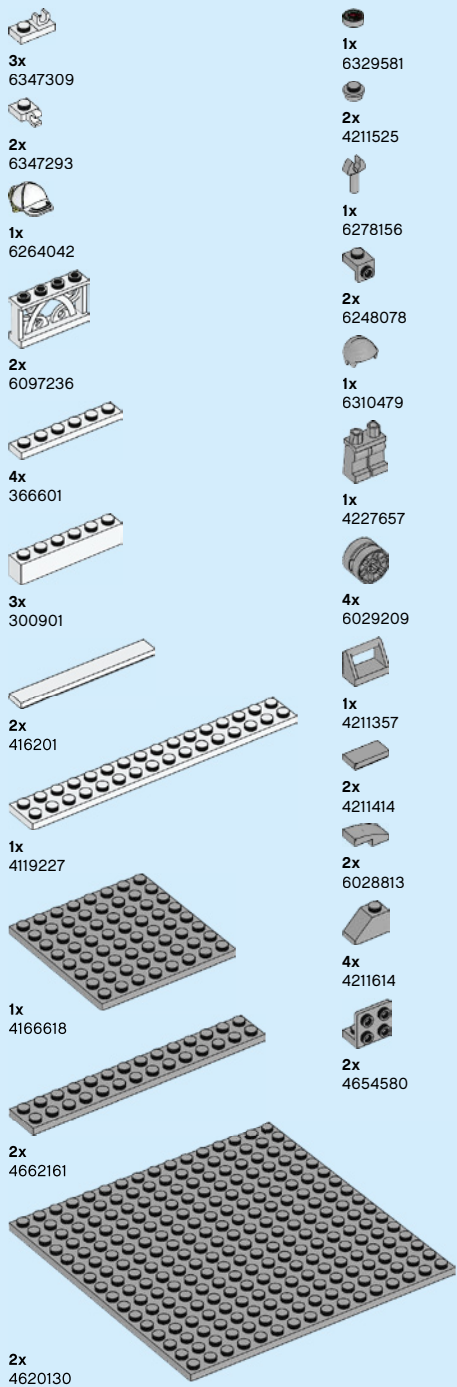
1x
 6338955

2x
 362601

4x
 6258135

4x
 407001

1x
 6329595

1x
 6174310

1x
 434601

1x
 403201

3x
 6097801

1x
 6284507

2x
 6059185

3x
 243201

1x
 9551

6x
 6285777

1x
 306901

1x
 6329575

4x
 300401

1x
 6218823

1x
 6329697

1x
 6126046

1x
 302201

4x
 366001

1x
 243101

2x
 6061047

1x
 6023806



Customer Service
Kundenservice
Service Consommateurs
Servicio Al Consumidor
LEGO.com/service or dial

 : 00800 5346 5555
 : 1-800-422-5346

WIN

GO TO WWW.LEGO.COM/PRODUCTFEEDBACK AND
GIVE US YOUR SHORT **FEEDBACK** ABOUT THIS
LEGO® SET FOR A CHANCE TO WIN
A COOL LEGO PRIZE.

Terms & Conditions apply



LEGO.com/productfeedback

GEWINNE

Erzähle uns auf
www.LEGO.com/productfeedback

etwas über die Erfahrungen, die
du mit diesem LEGO® Set gemacht
hast, und sichere dir die Chance
auf einen coolen LEGO Preis!

Es gelten die
Teilnahmebedingungen

GAGNE

Rends-toi sur
www.LEGO.com/productfeedback

et donne-nous quelques com-
mentaires sur ce produit LEGO®
pour avoir une chance de gagner
un prix LEGO !

Voir Conditions Générales

GANANA

Visita
www.LEGO.com/productfeedback

y envíanos tu opinión acerca de
este set LEGO®. ¡Participarás en el
sorteo de un premio LEGO!

Términos y Condiciones aplicables

获取奖品

登录
www.LEGO.com/productfeedback

给出关于此乐高®套装的简短反馈，
就有机会获得炫酷乐高奖品

《条款及条件》适用

경품 당첨 기회

www.LEGO.com/productfeedback

페이지로 이동하여 이 레고® 세트에
대한 간단한 피드백을 보내 주시고
멋진 레고 경품을 탈 수 있는 기회도
잡으십시오

약관 적용

ЗАПОЛНИ АНКЕТУ И ПОЛУЧИ ПРИЗ

Перейди по ссылке
www.LEGO.com/productfeedback

ответь всего на несколько во-
просов об этом наборе LEGO®,
и у тебя появится шанс выиграть
замечательный приз от компании
LEGO.

Применяются Условия и правила
участия



CITY

60306



3

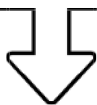
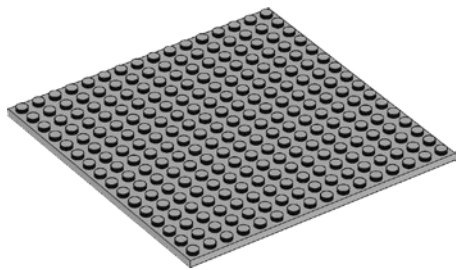

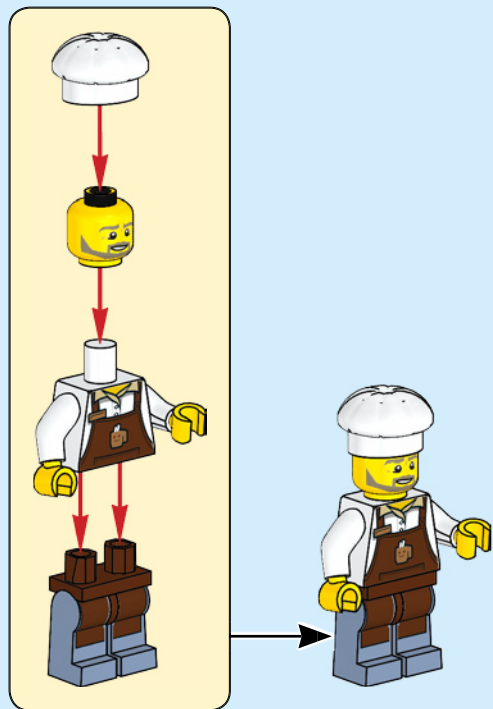

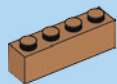

2x

1

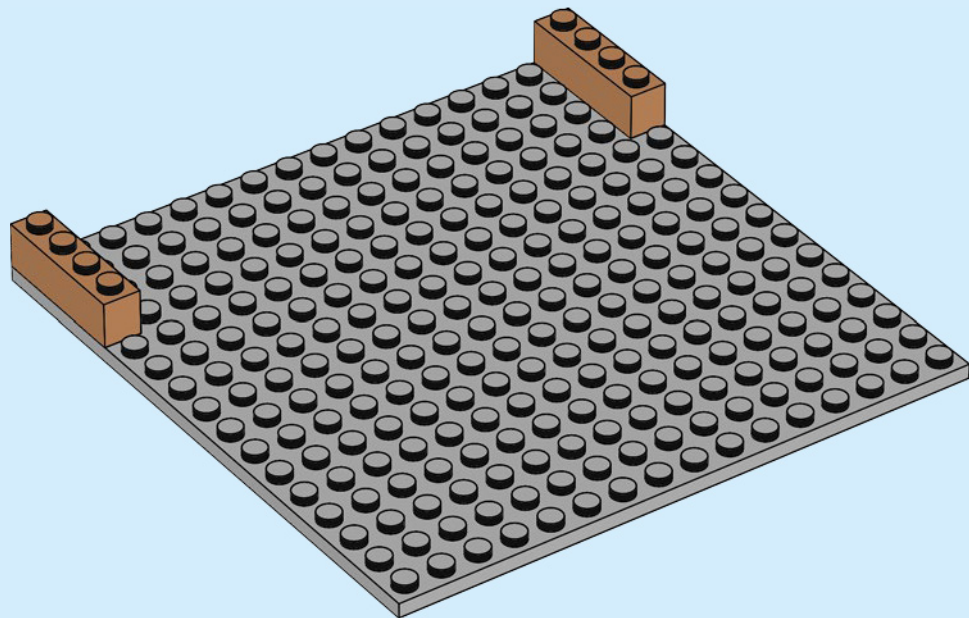

4

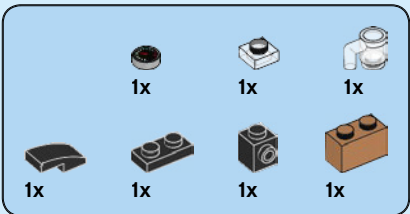

2

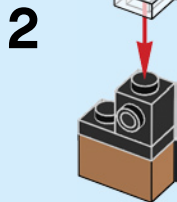
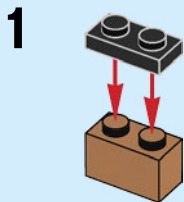

4



5



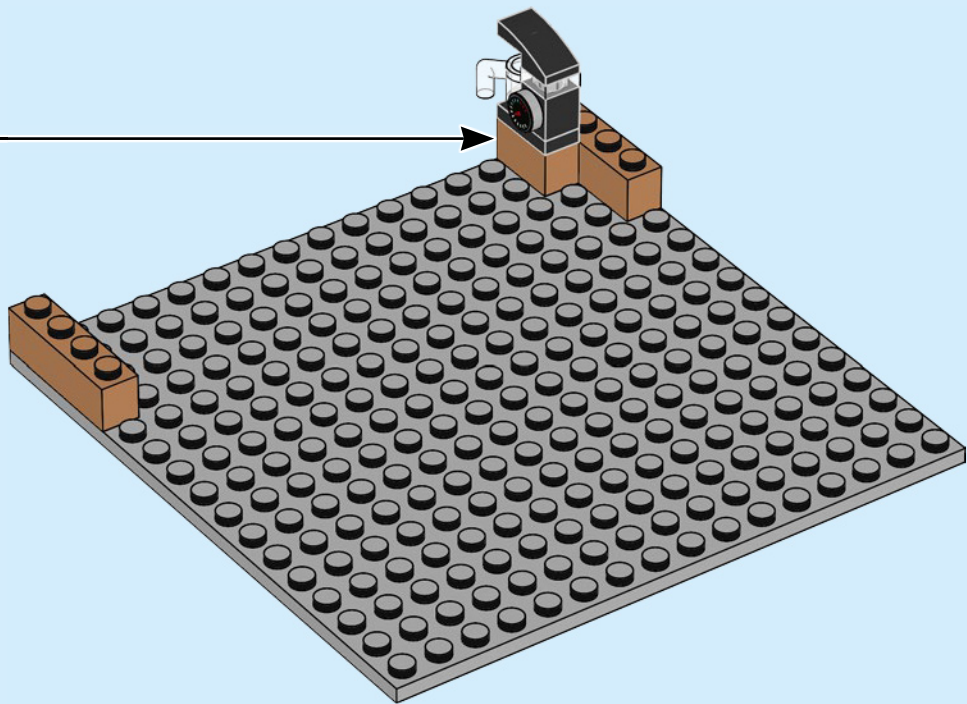

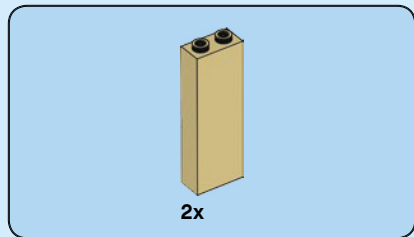

3

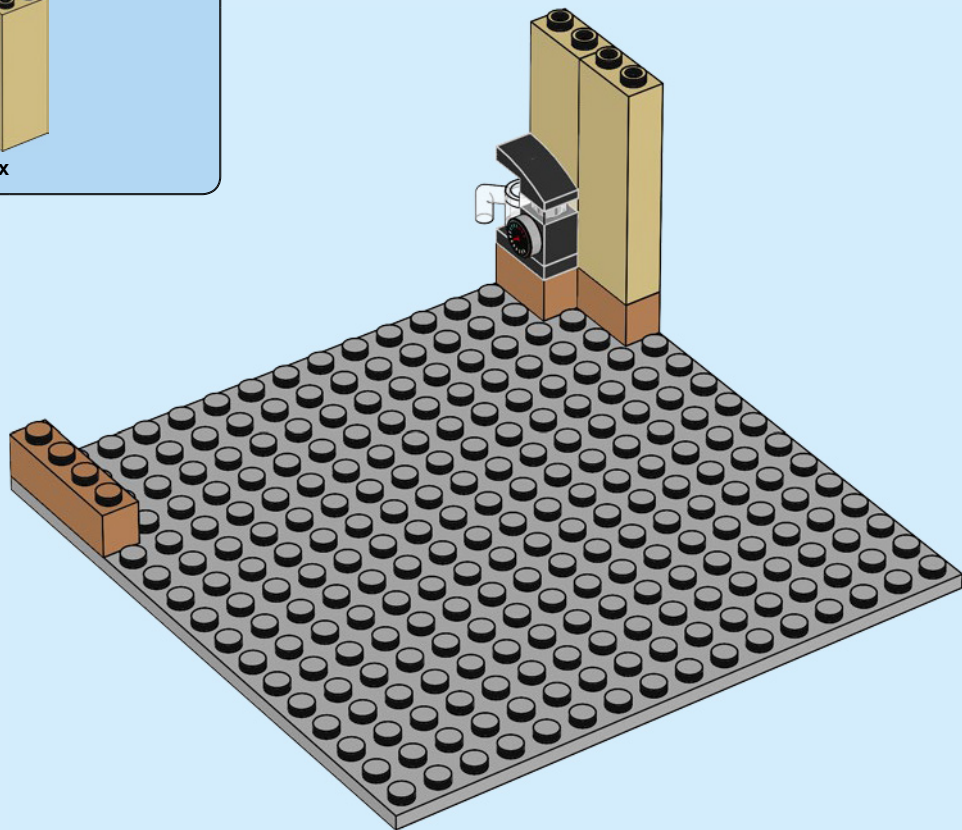

8

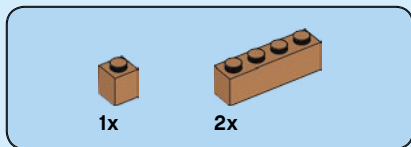

4

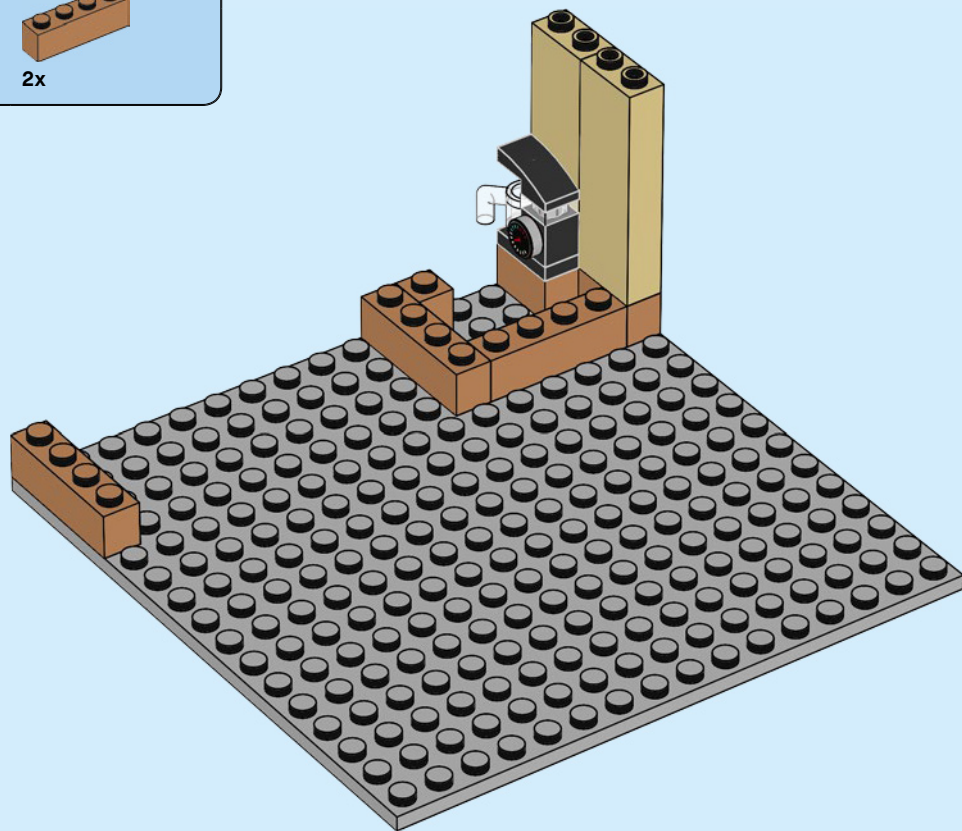



1x



2x

5

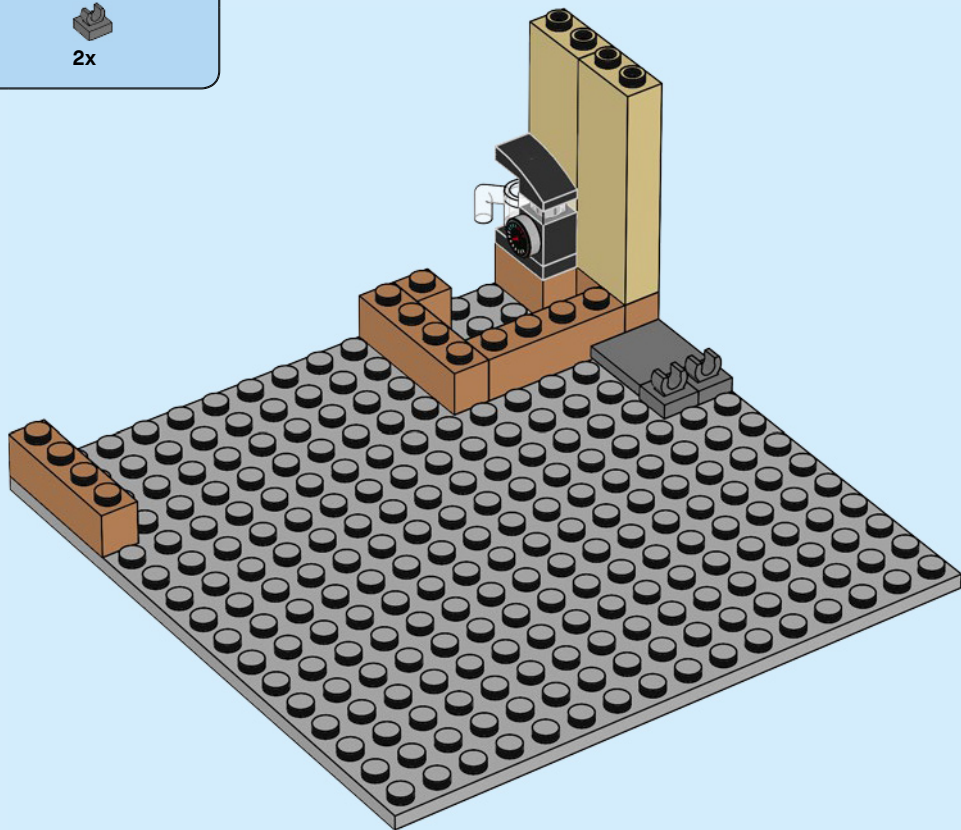

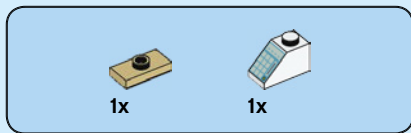

6

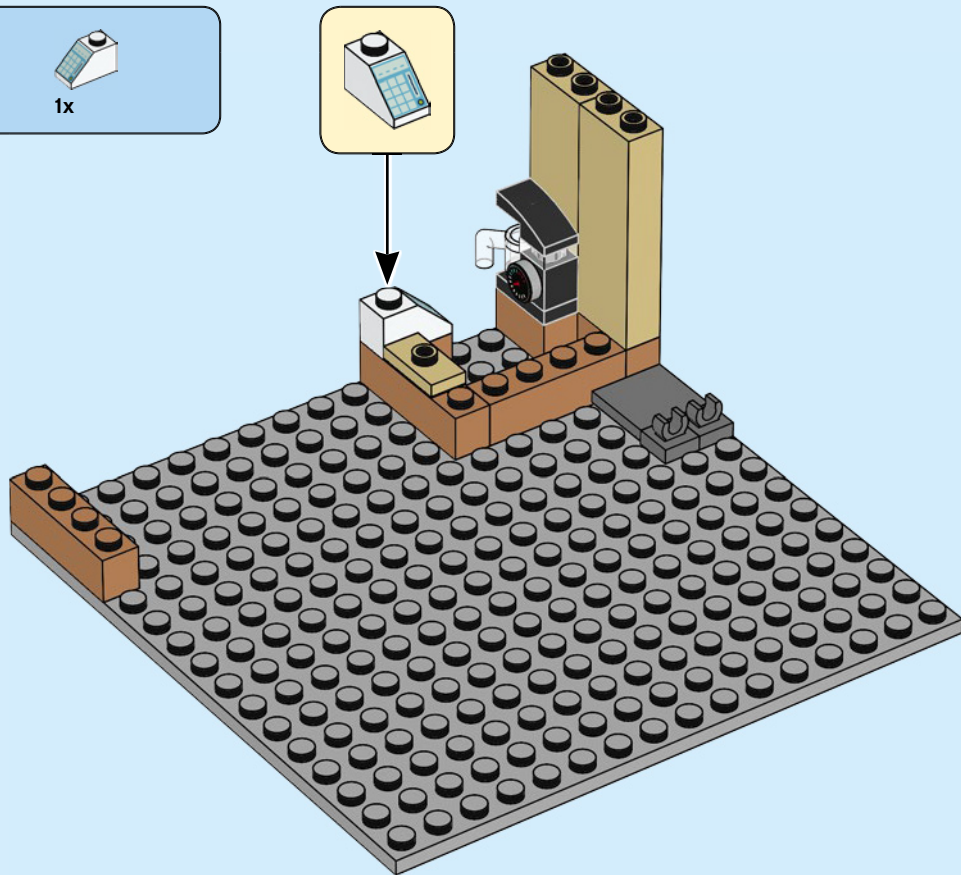



2x

7

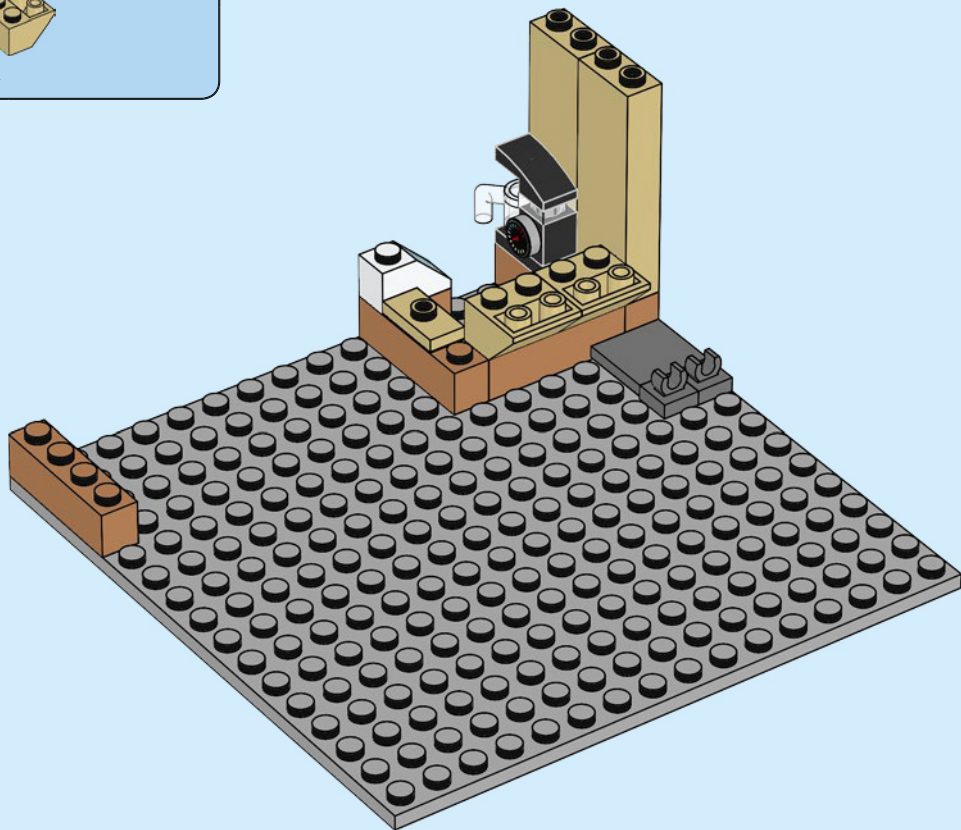

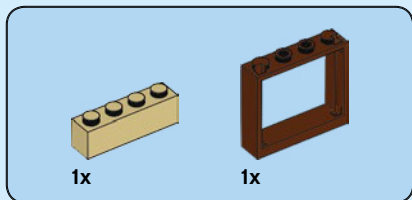

8

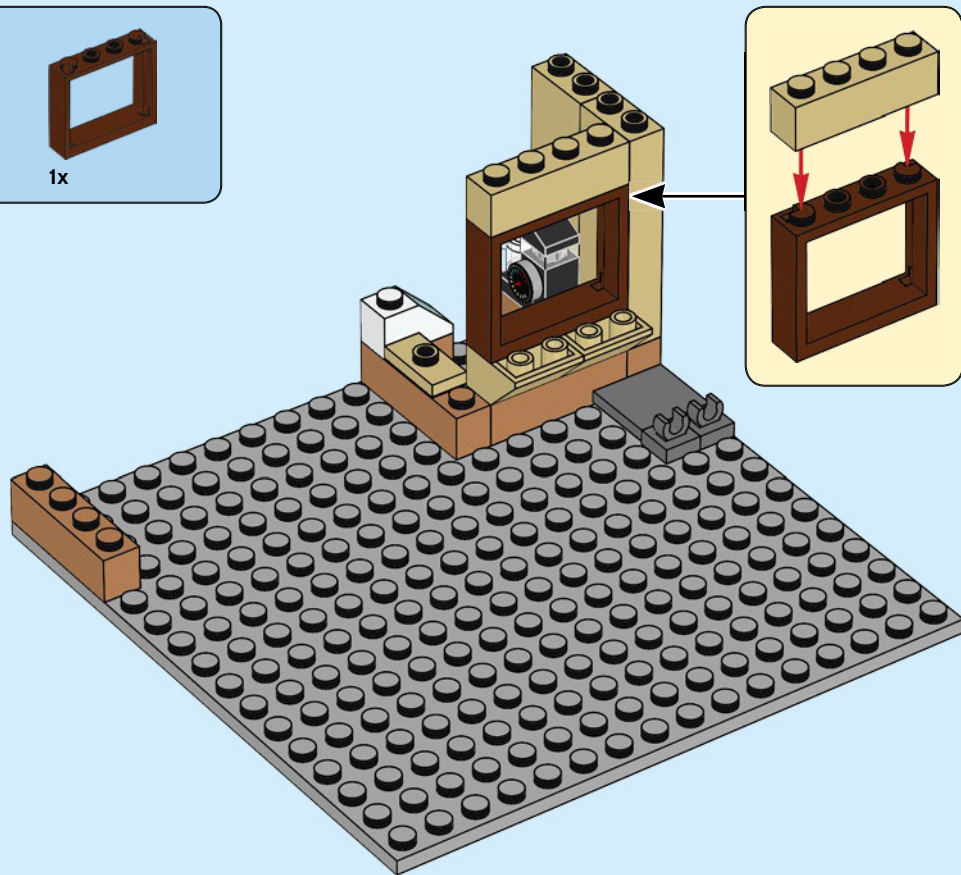

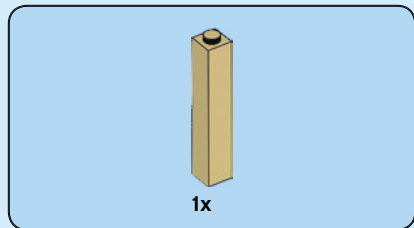

9

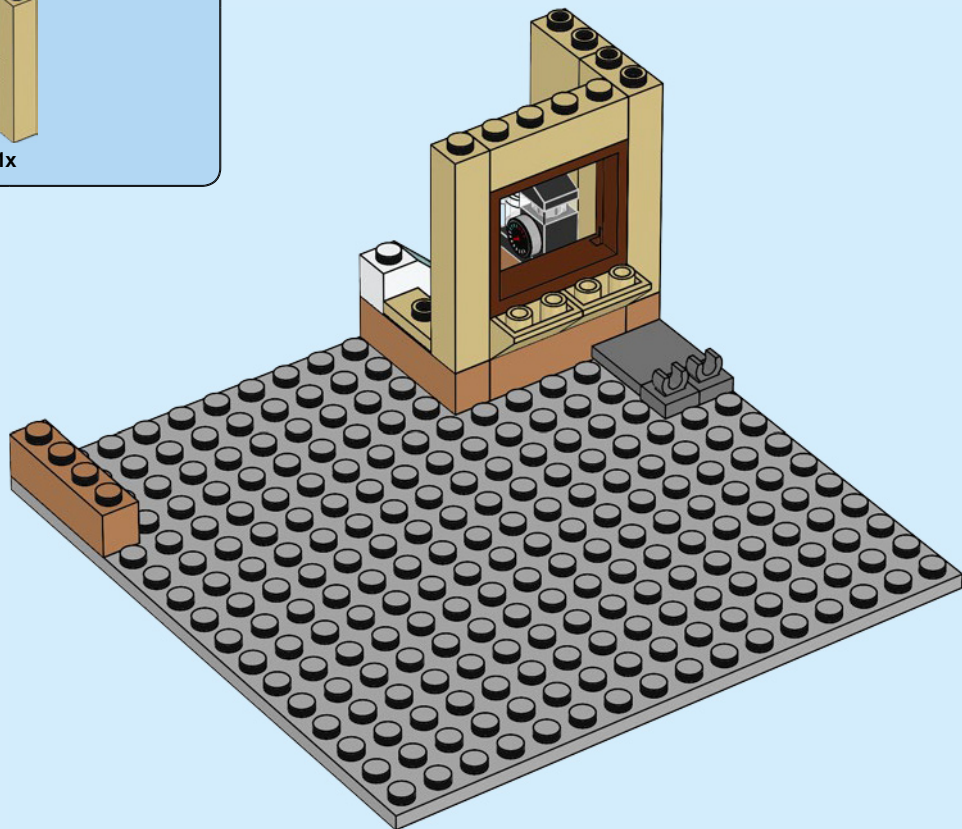

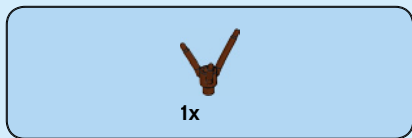

10

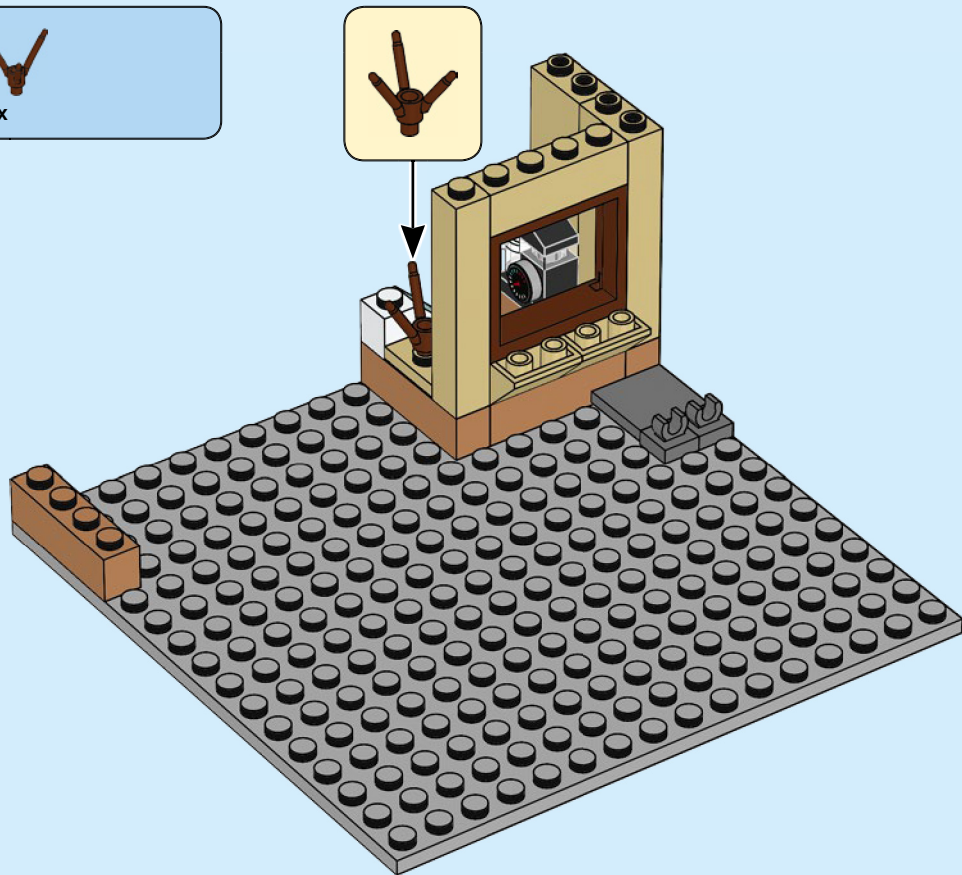

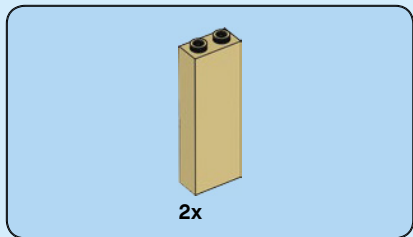

11

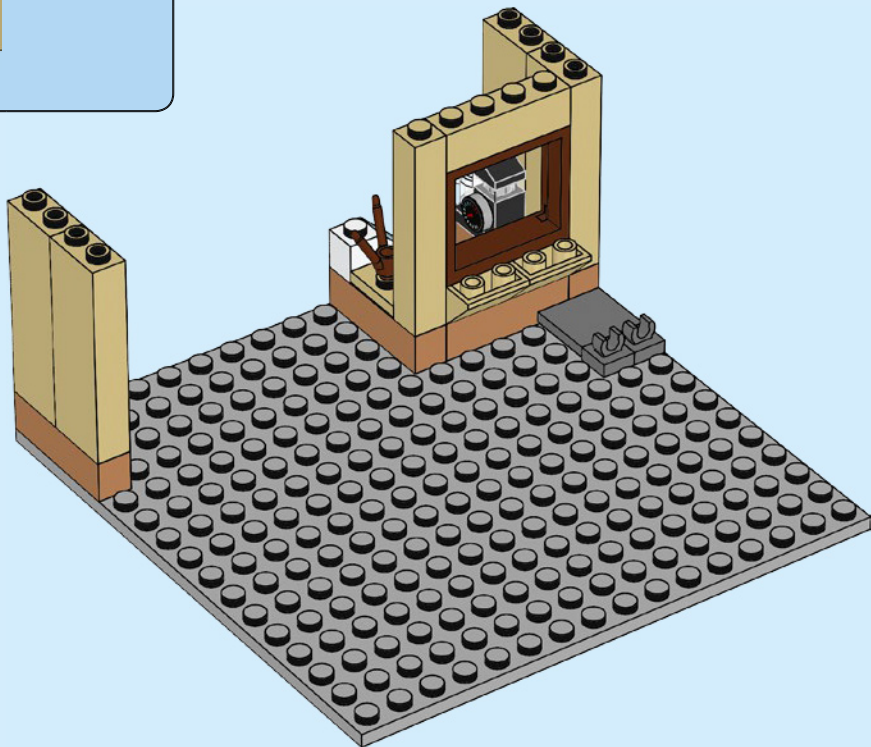

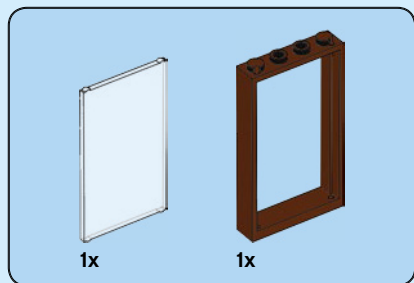

12

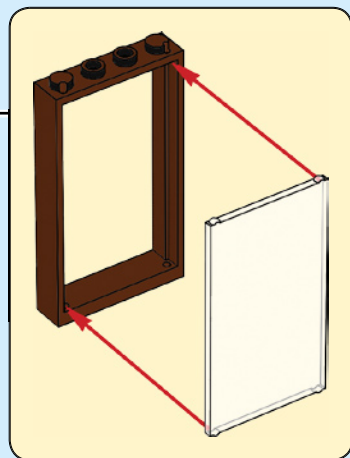
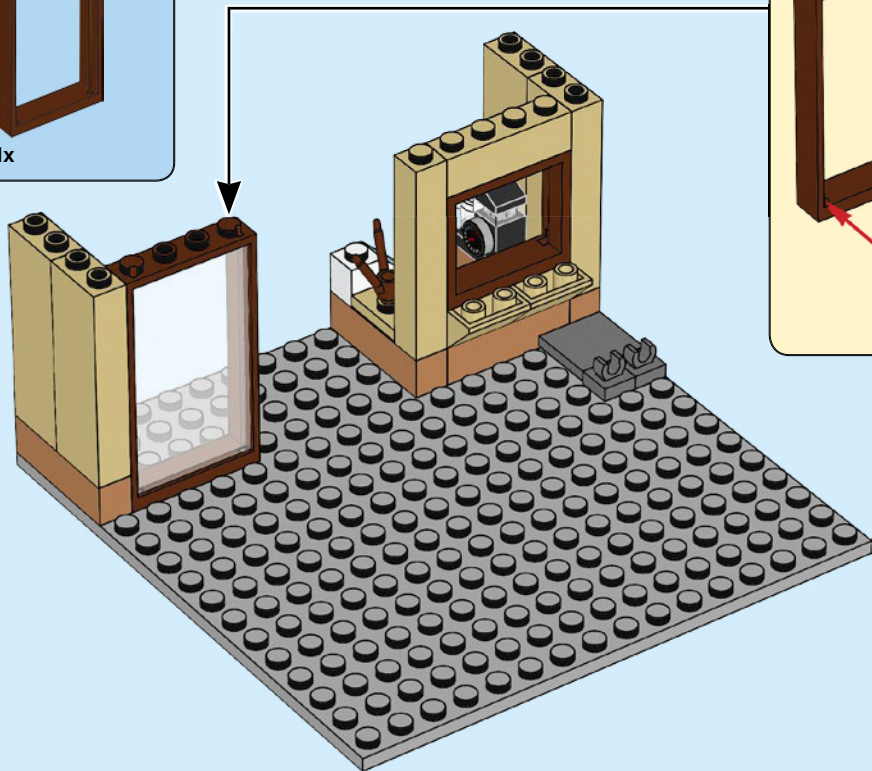

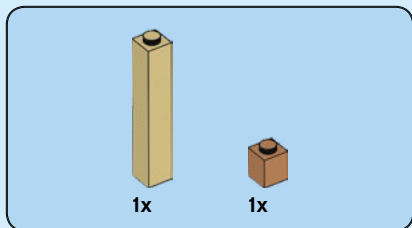

13

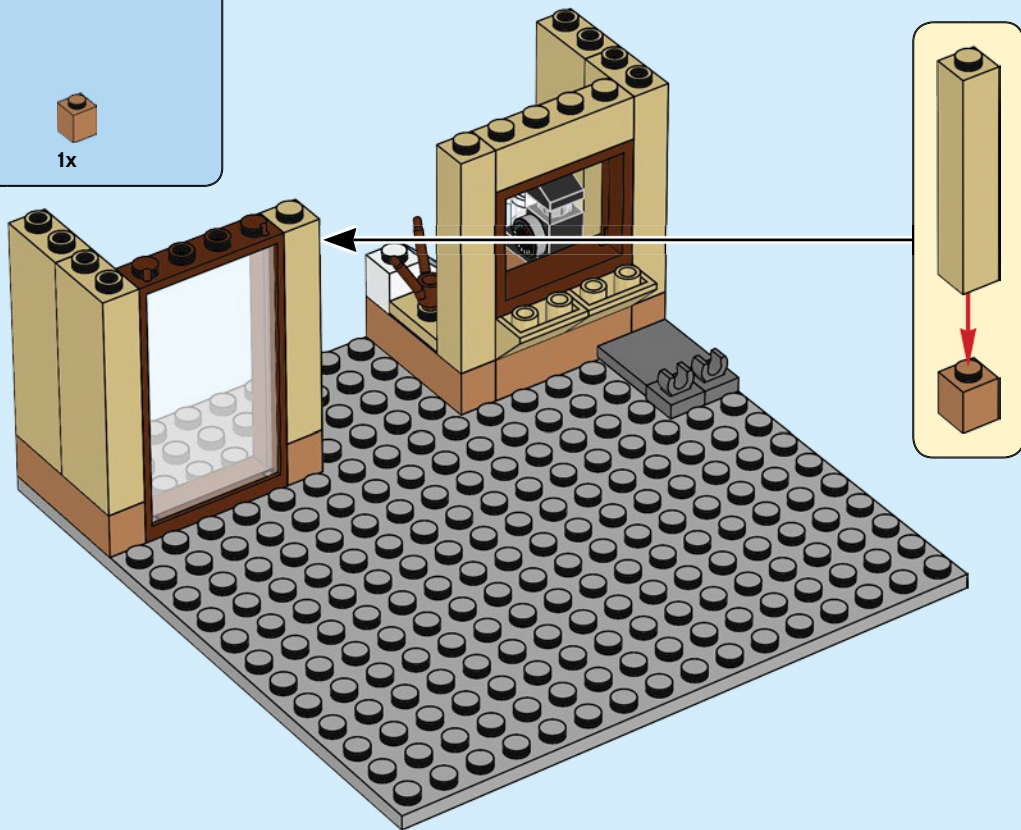

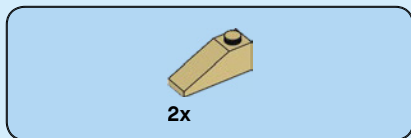

14

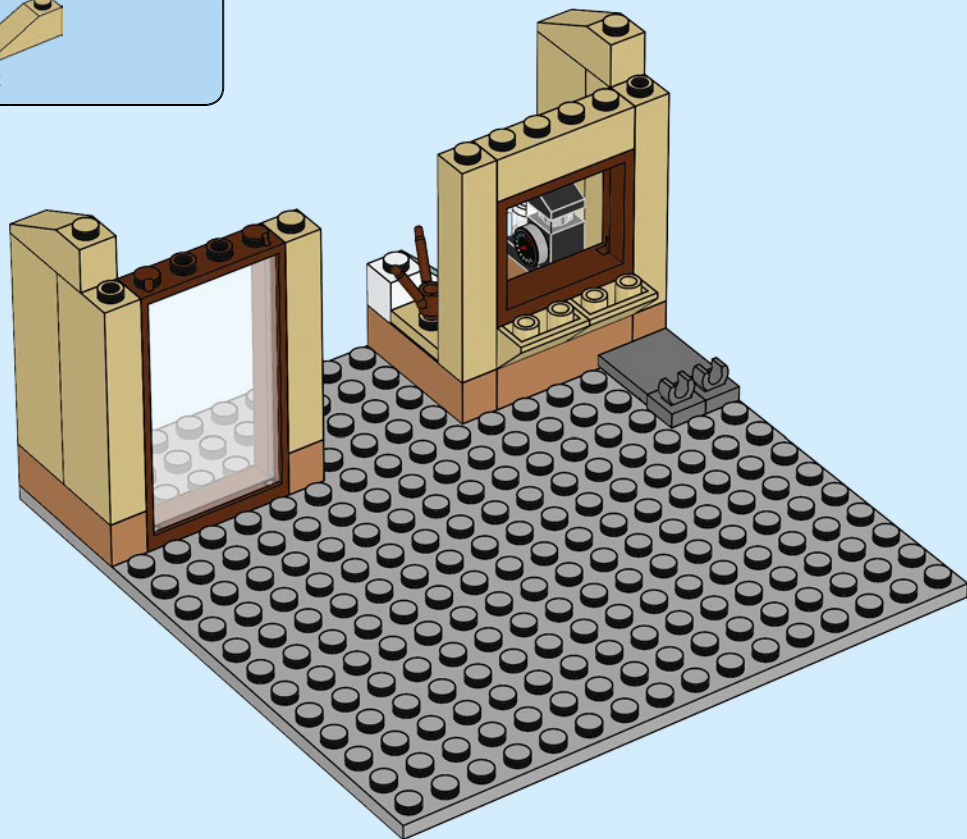

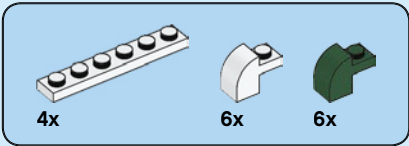
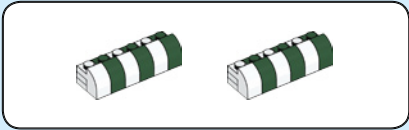

15

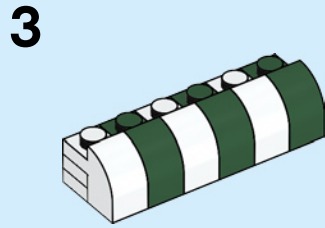
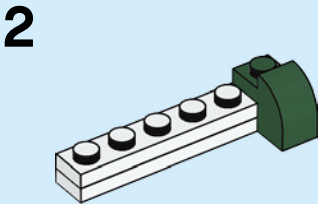
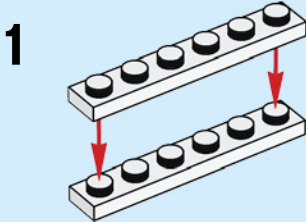

2x

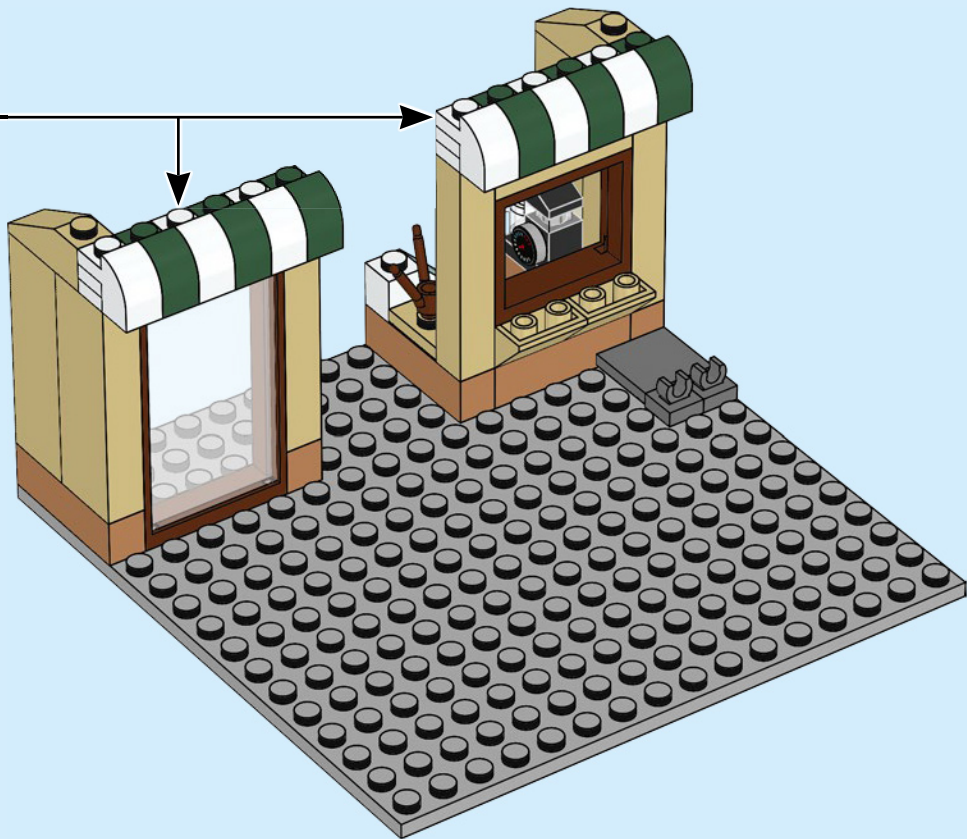

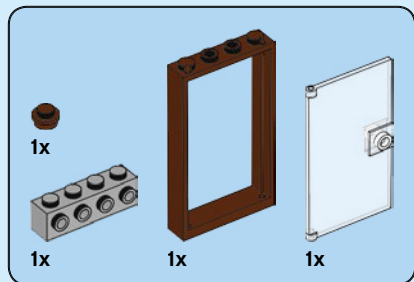

16

1

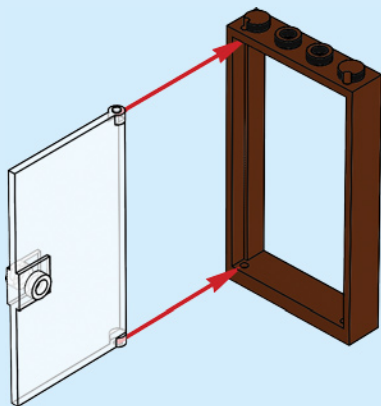

2



3

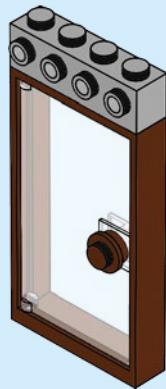

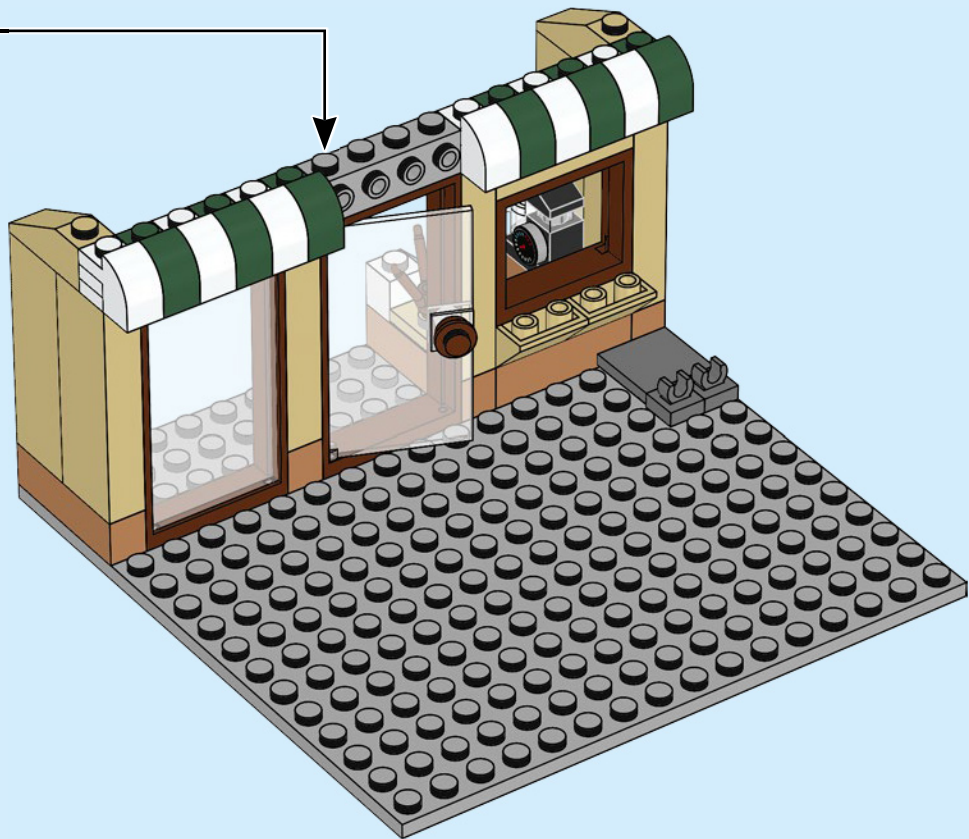

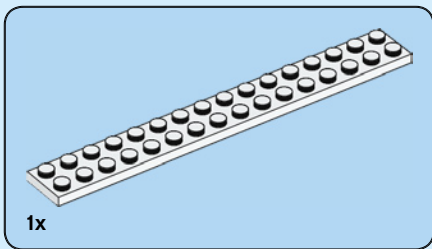

17

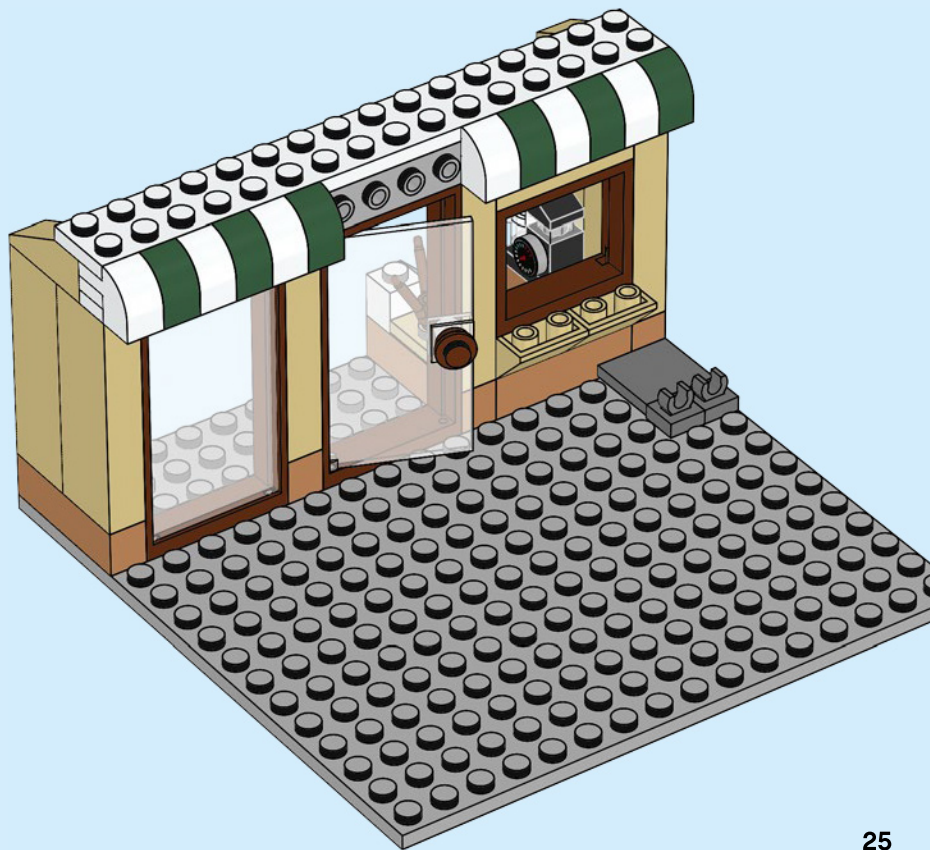

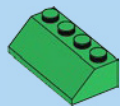

3x

18



26



19



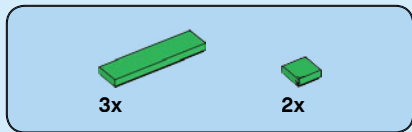

20



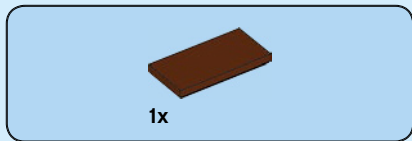

21

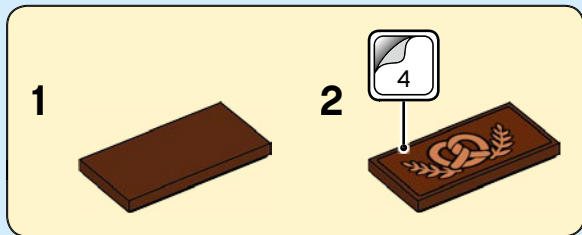

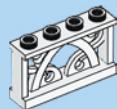

2x

22



30

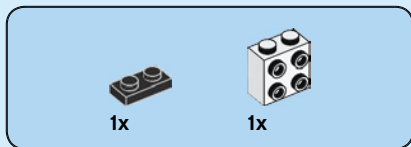

23

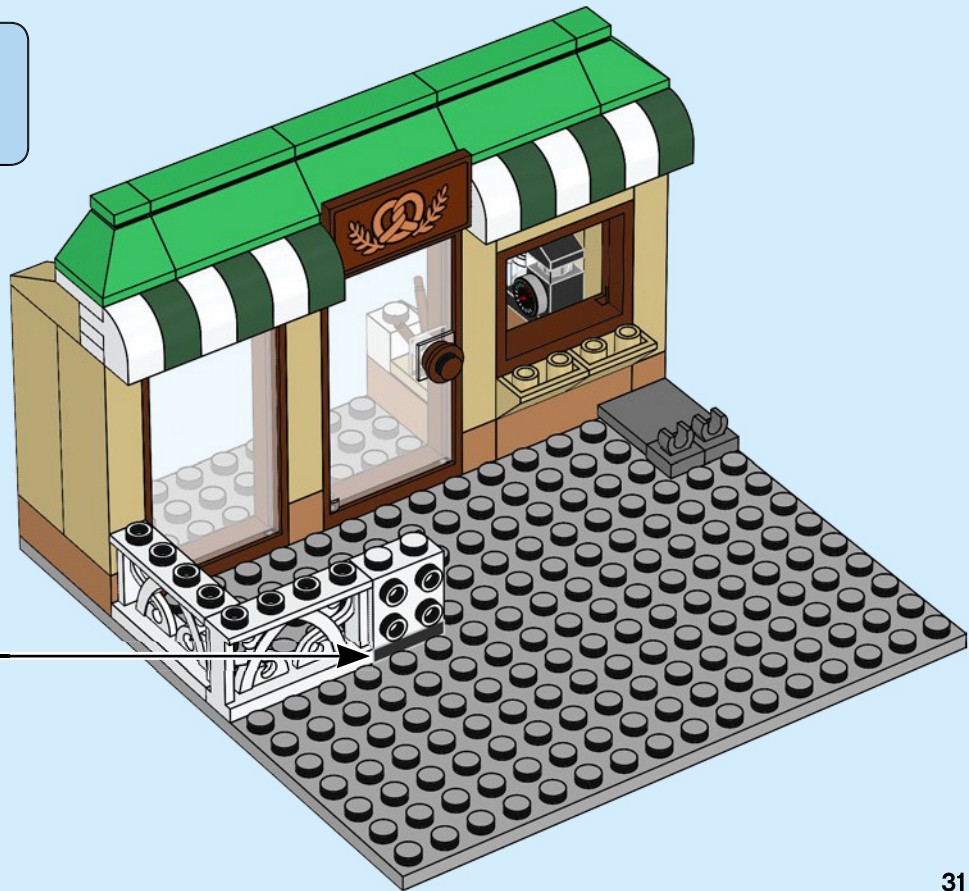
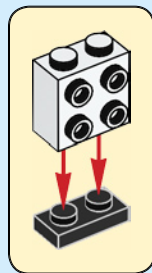

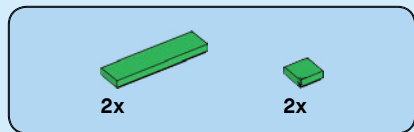

24





1x

25

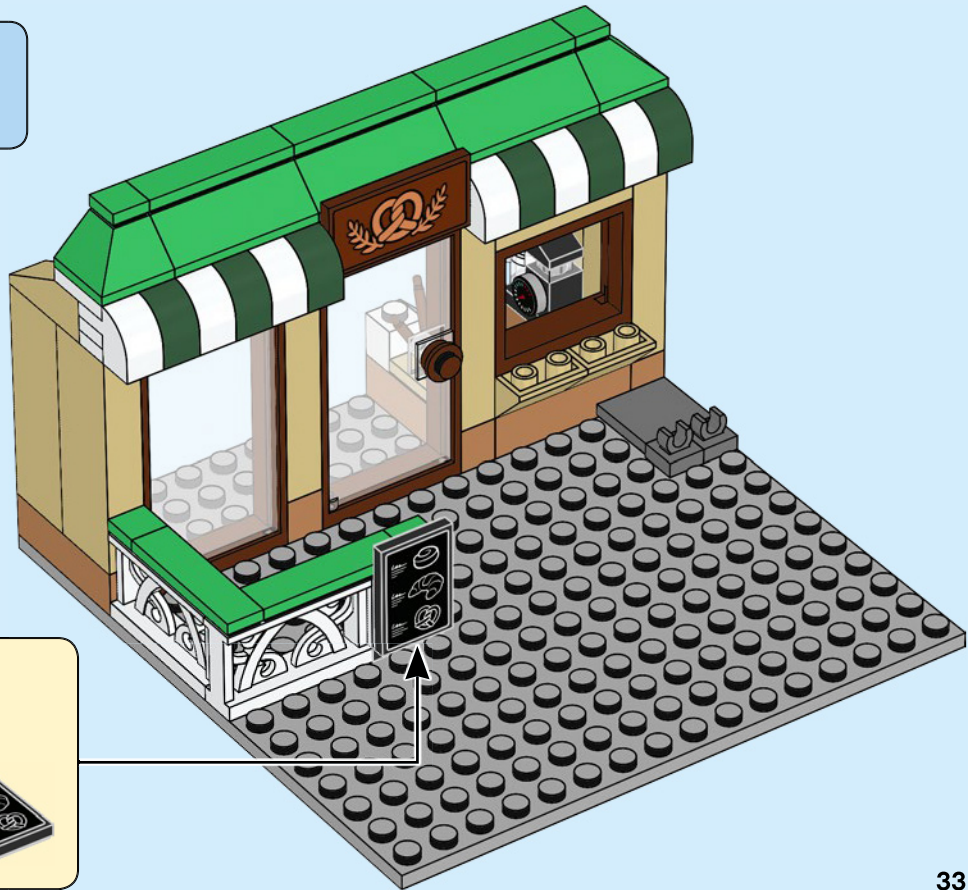

1



2





2x

26

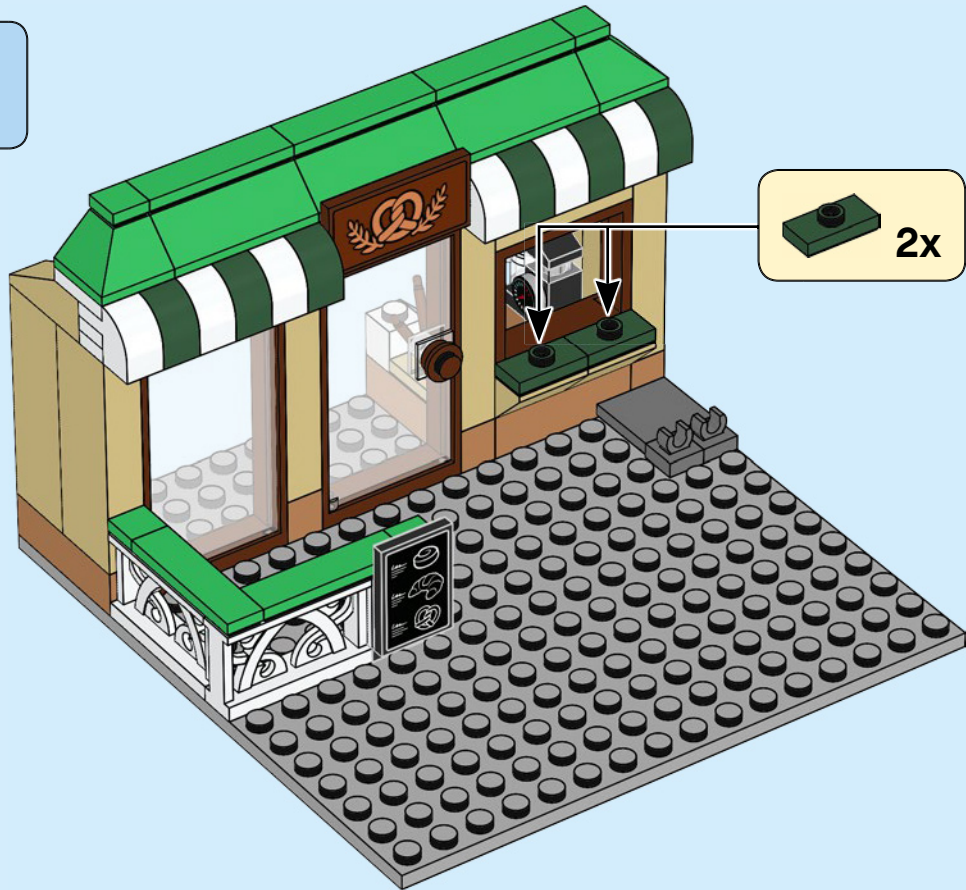

2x



2x



1x

27

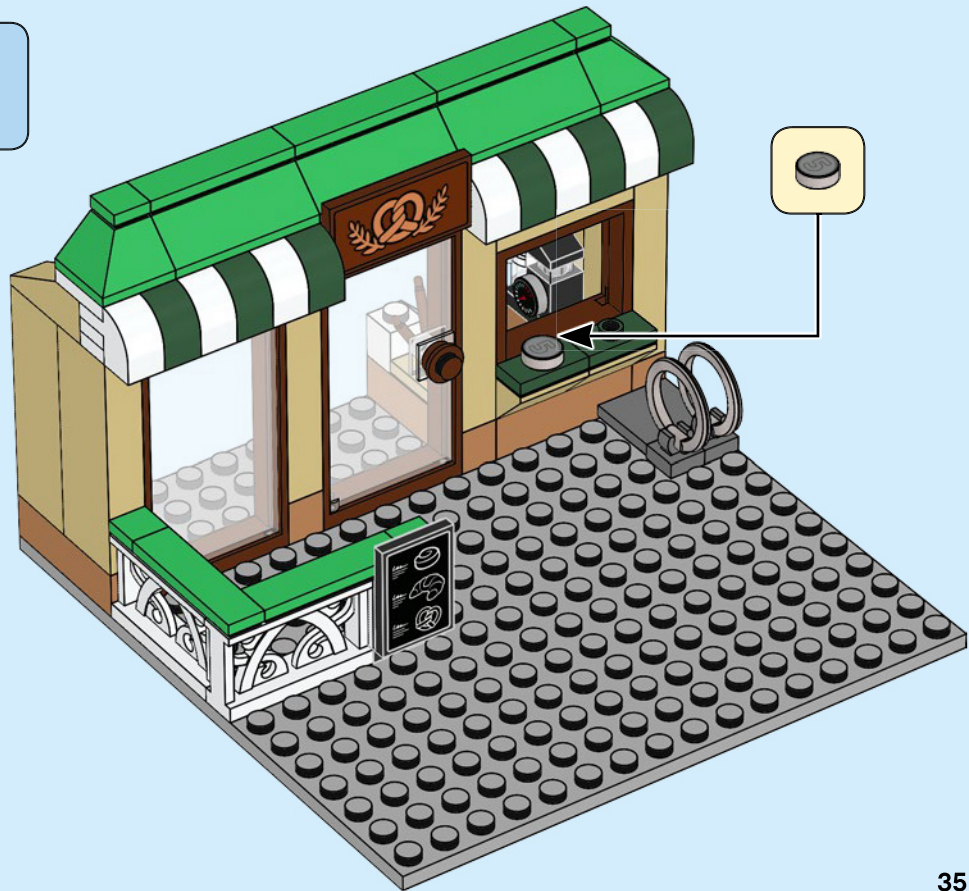

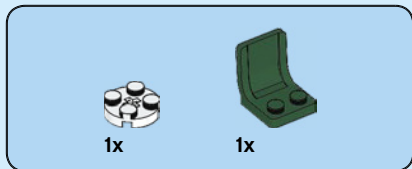

28

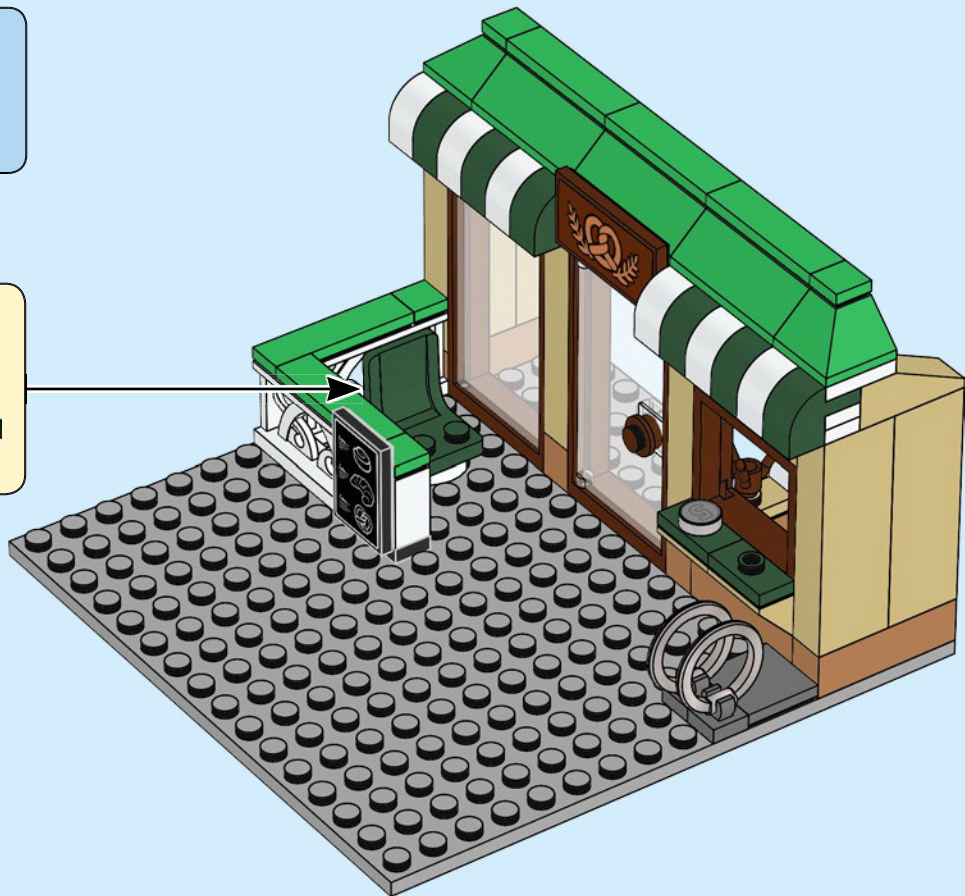
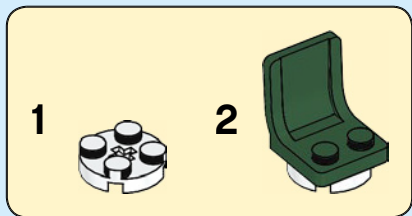

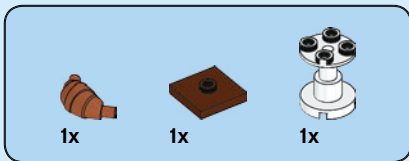

29

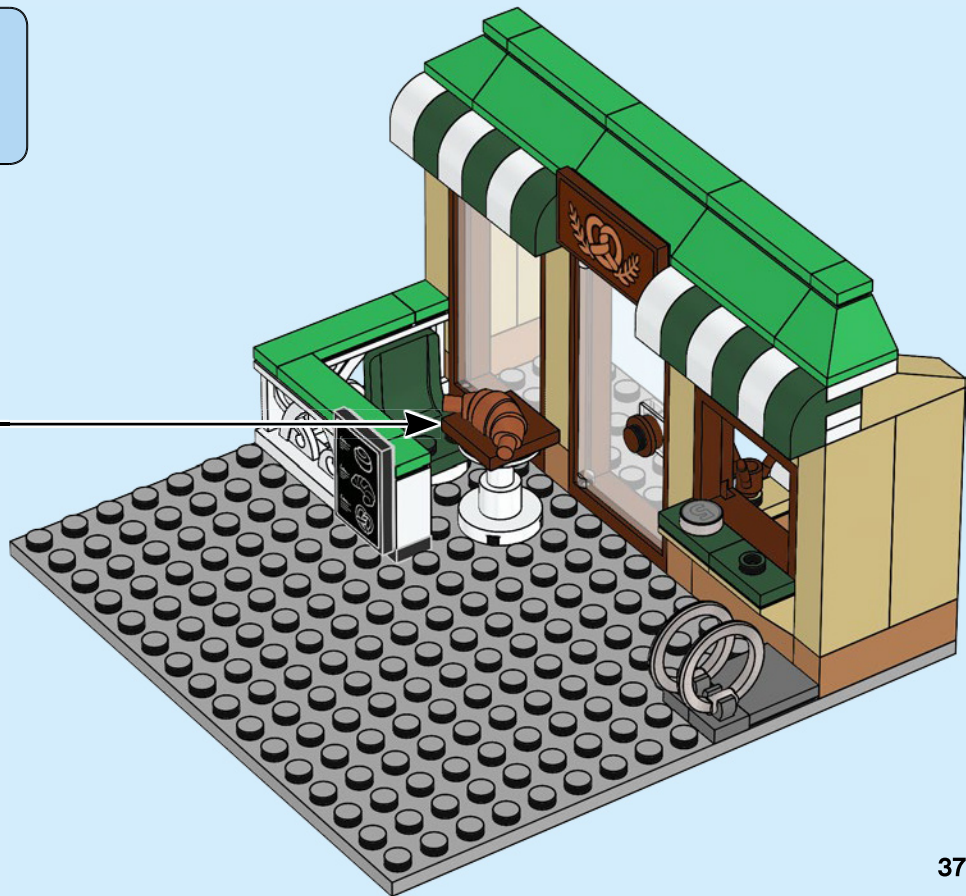
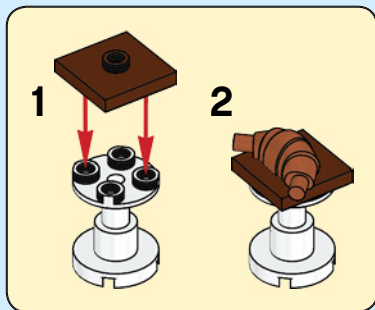

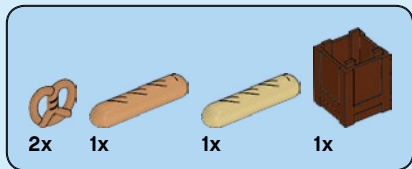

30

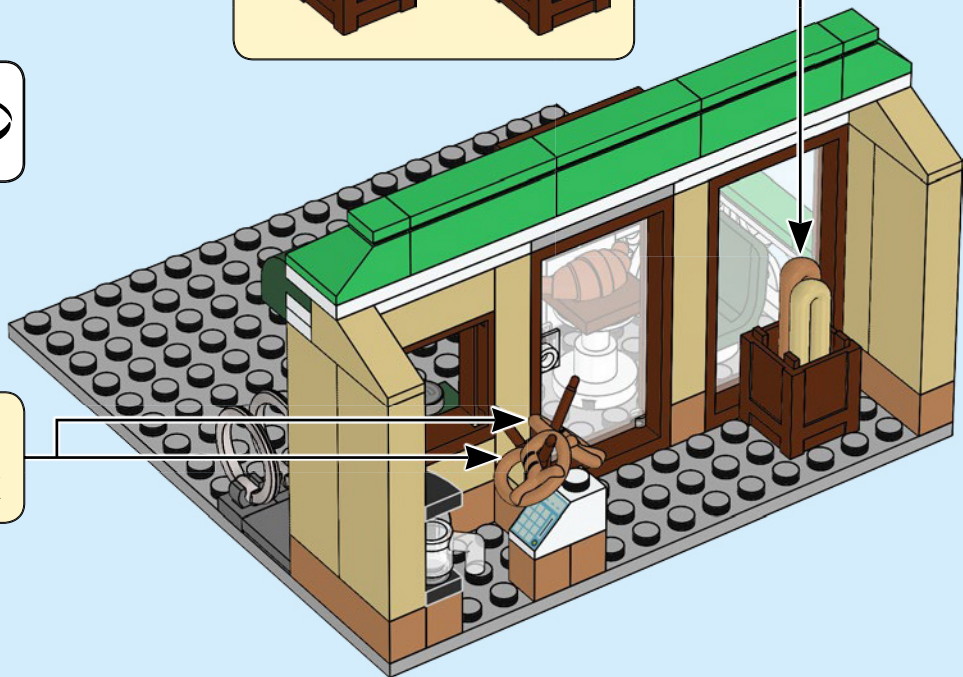
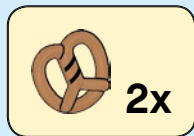
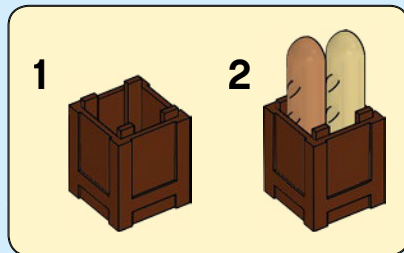

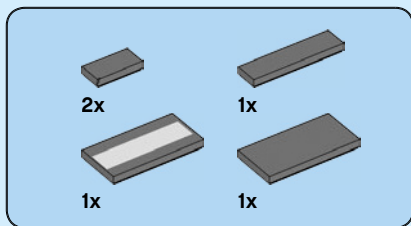

31

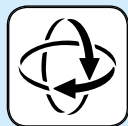

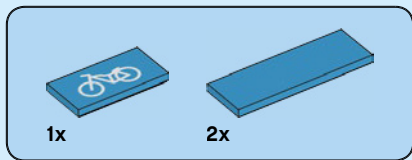

32

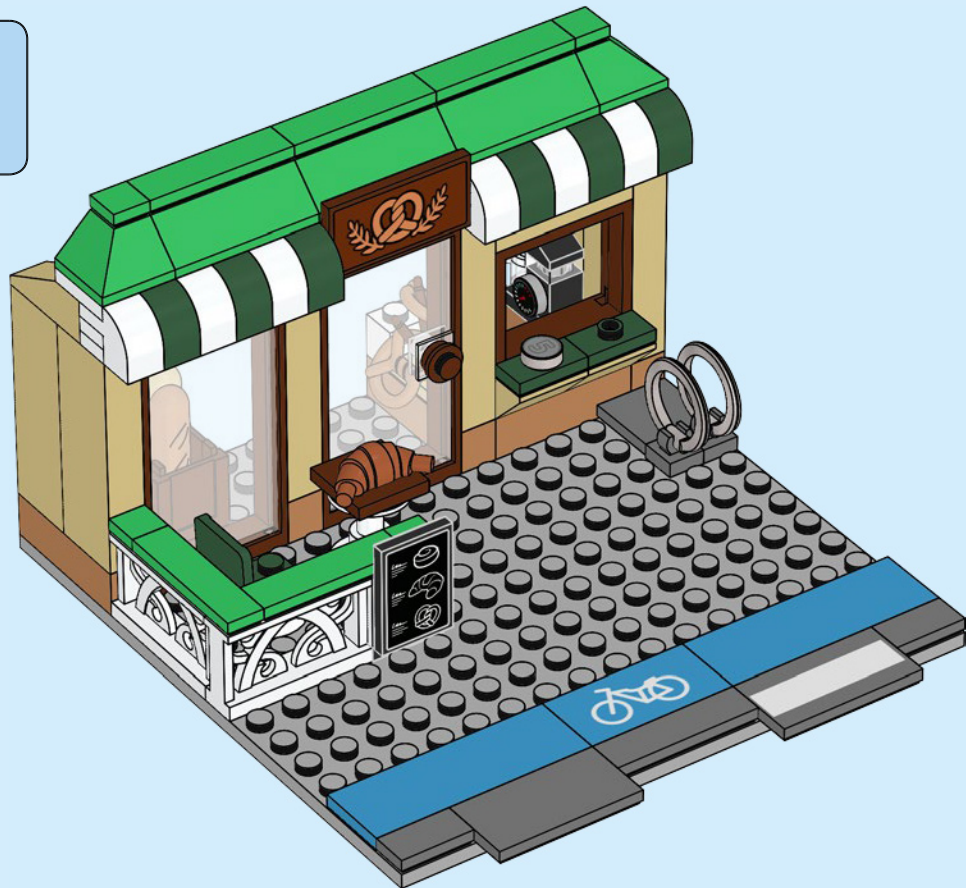

33

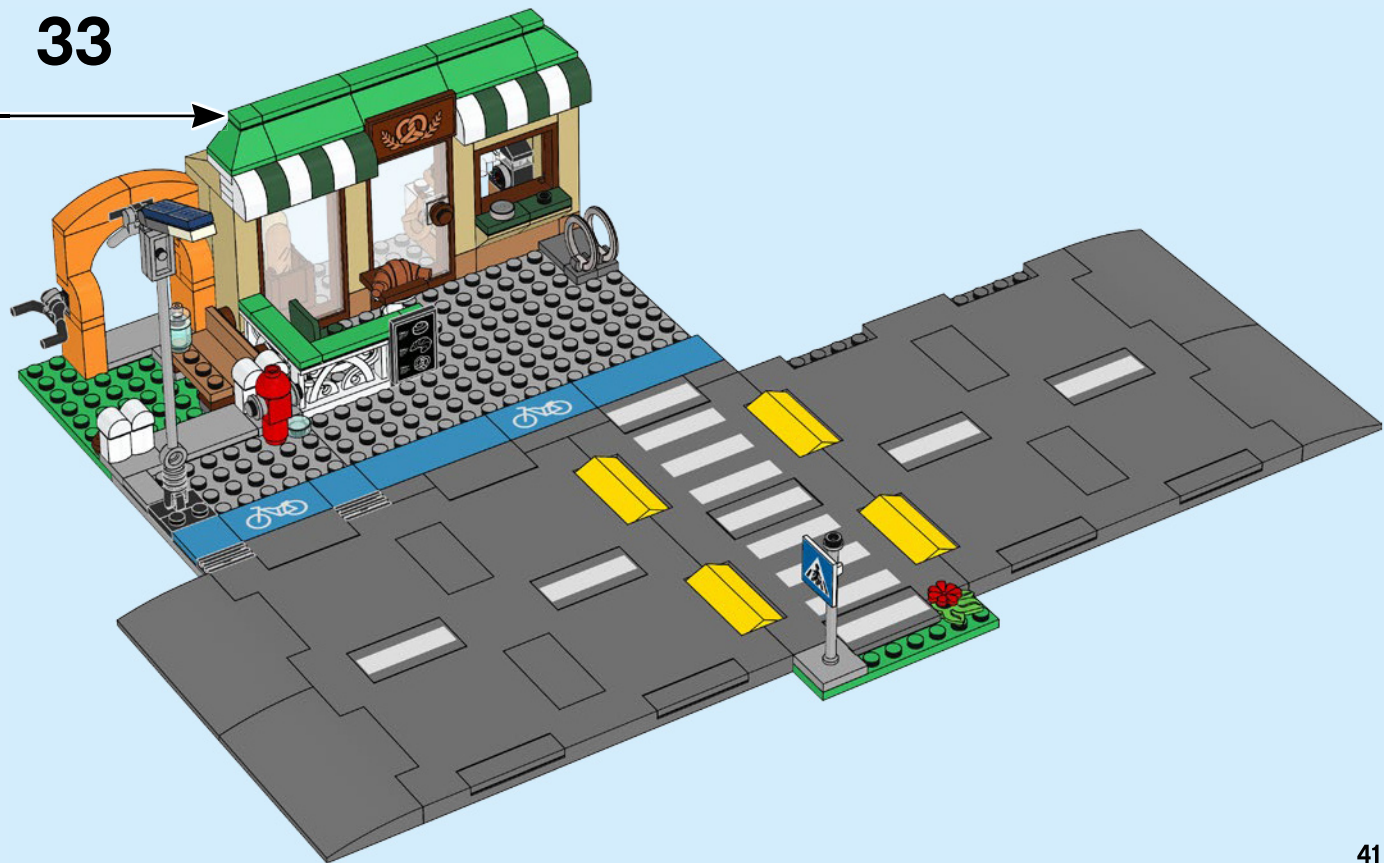

CITY ADVENTURES

City Abenteuer
Aventuras en City
City Aventuras
City kalandok
City piedzivojumi
乐高城市大冒险



VITO

60242



SAM
GRIZZLED

60243



SNAKE
RATTLER

60243 • 60276



ROOKY
PARTNUR

60244



FRANKIE
LUPELLI

60244 • 60277



TOM
BENNETT

60245



BIG
BETTY

60245



WHEELER

60246



DAISY
KABOOM

60246



CLARA
THE CRIMINAL

60276



GRACIE
GOODHART

60277



DUKE
DETAIN

60242 • 60246 • 60276



FREYA
MCLOUD

60248 • 60280



CLEMMONS

60247 • 60281



BOB

60282



FELDMAN

60282



TREAD
OCTANE

60258



HARL
HUBBS

60258 • 60266



SHIRLEY
KEEPER

60292



MADISON

60292

CITY

ADVENTURES

City Abenteuer
Aventuras en City
City Aventuras
City kalandok
City piedzīvojumi
乐高城市大冒险

Aus der erfolgreichen TV-Serie!
Vu dans la série télévisée à succès !
Dalla divertentissima serie TV!
¡De la popular serie de la tele!
Da série de sucesso da TV!
A népszerű TV-sorozatból!
No populārā TV seriāla!
源自热门动画片!



FROM THE HIT
TV SERIES!



CITY



60281



60279



60280



60282



CITY

60306



4

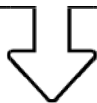
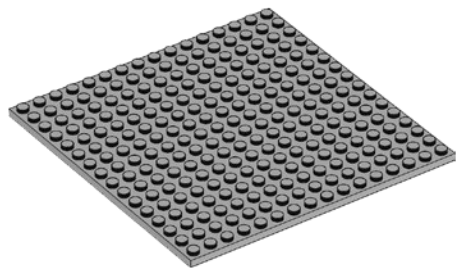

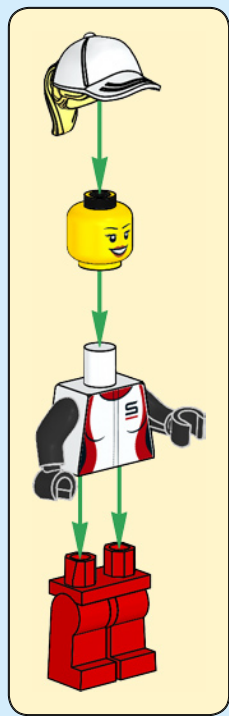

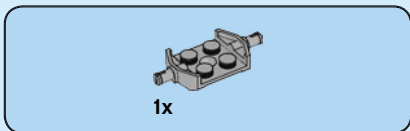
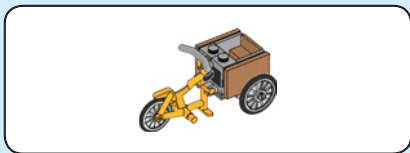

1

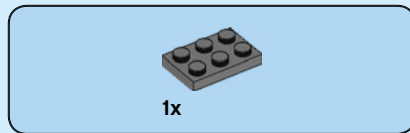
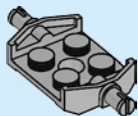

2

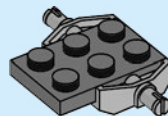



2x

3

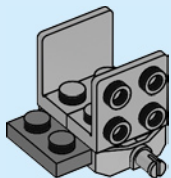

6



1x

4

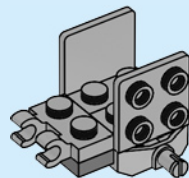

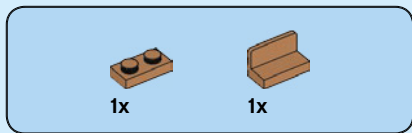

5

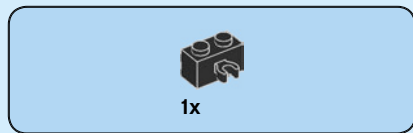
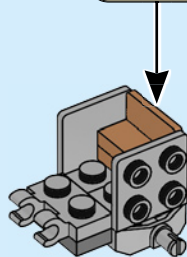
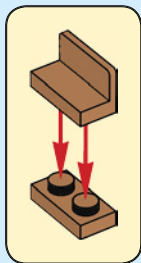

6

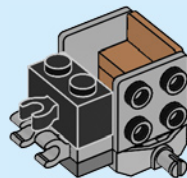



2x

7

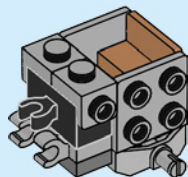

8



2x

8

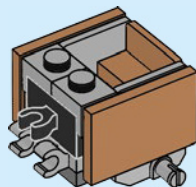

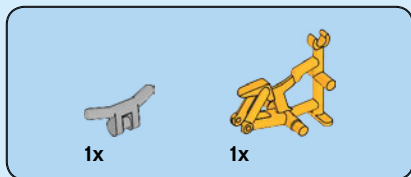

9

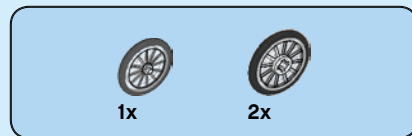
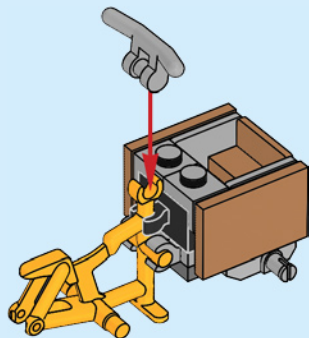

10

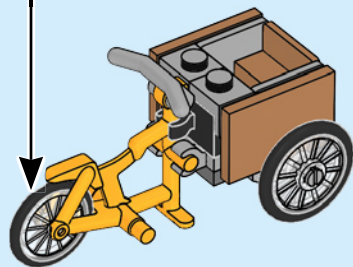
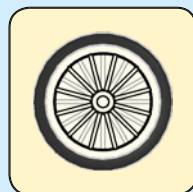



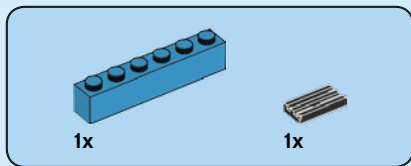

1

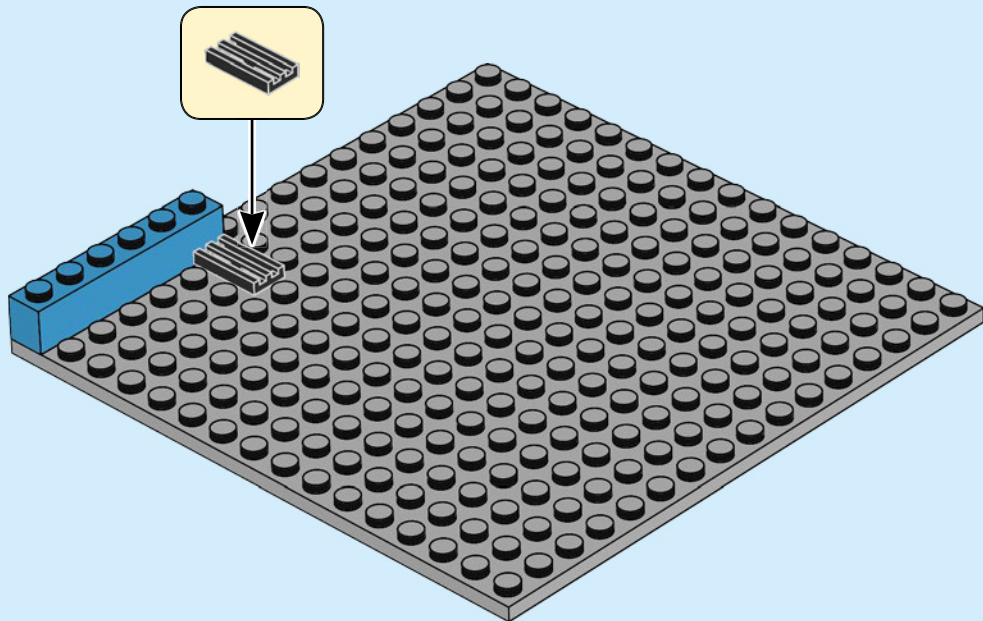



2x

2

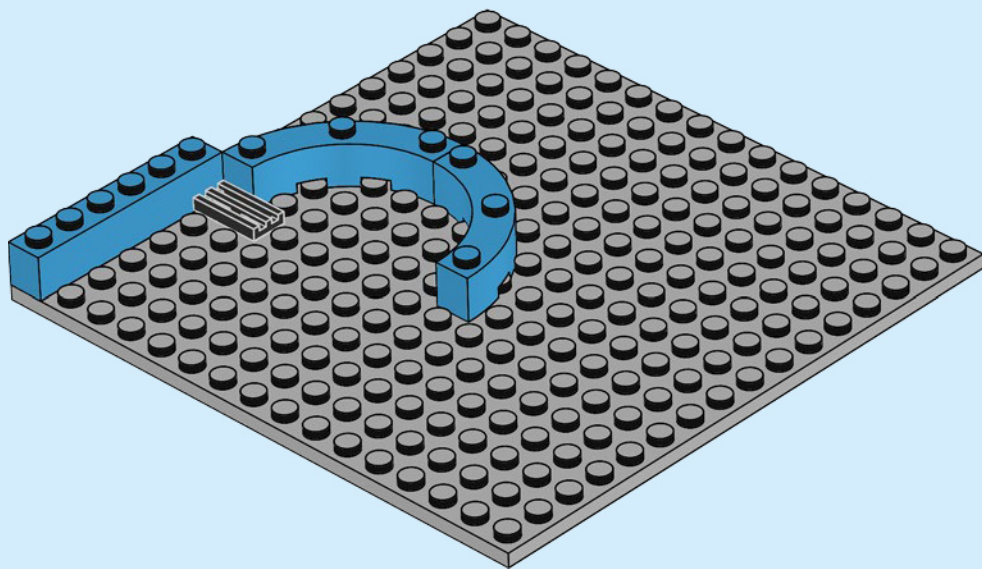



1x

3

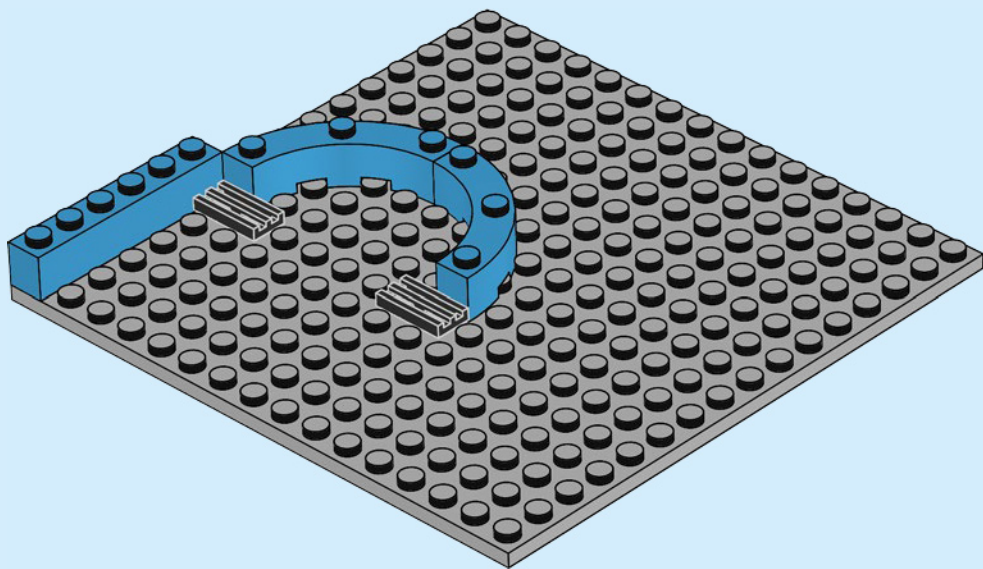

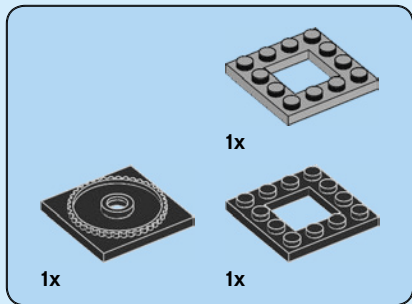

4

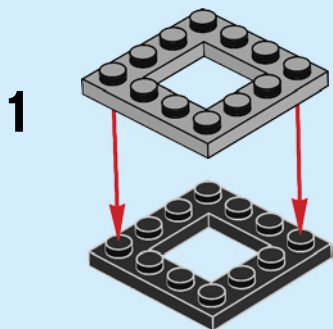

2

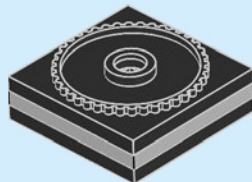

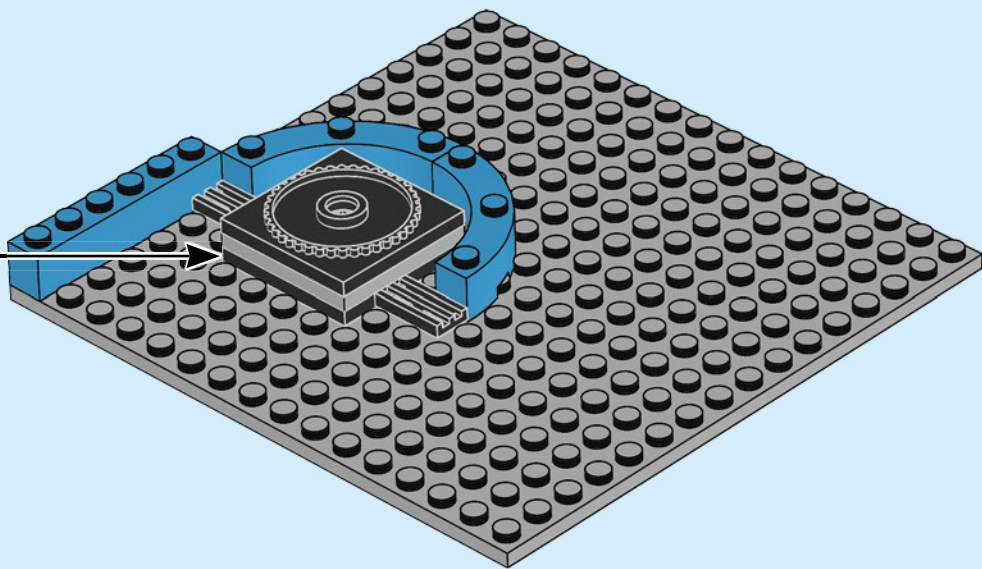

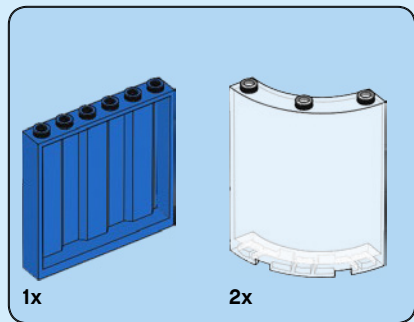

5

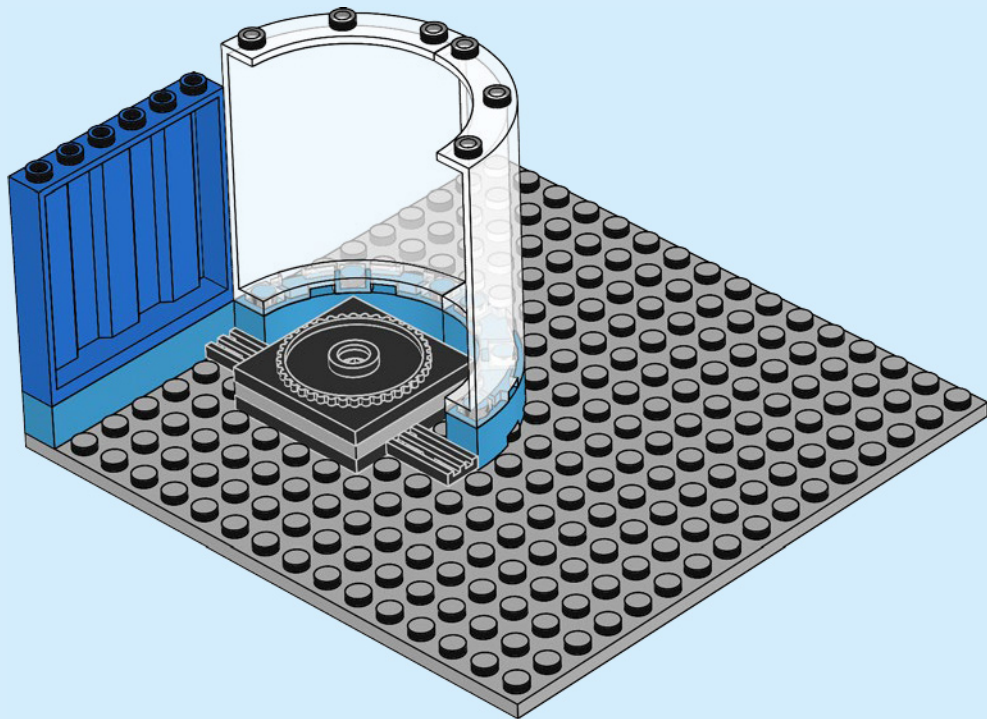

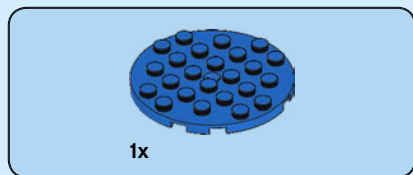

6

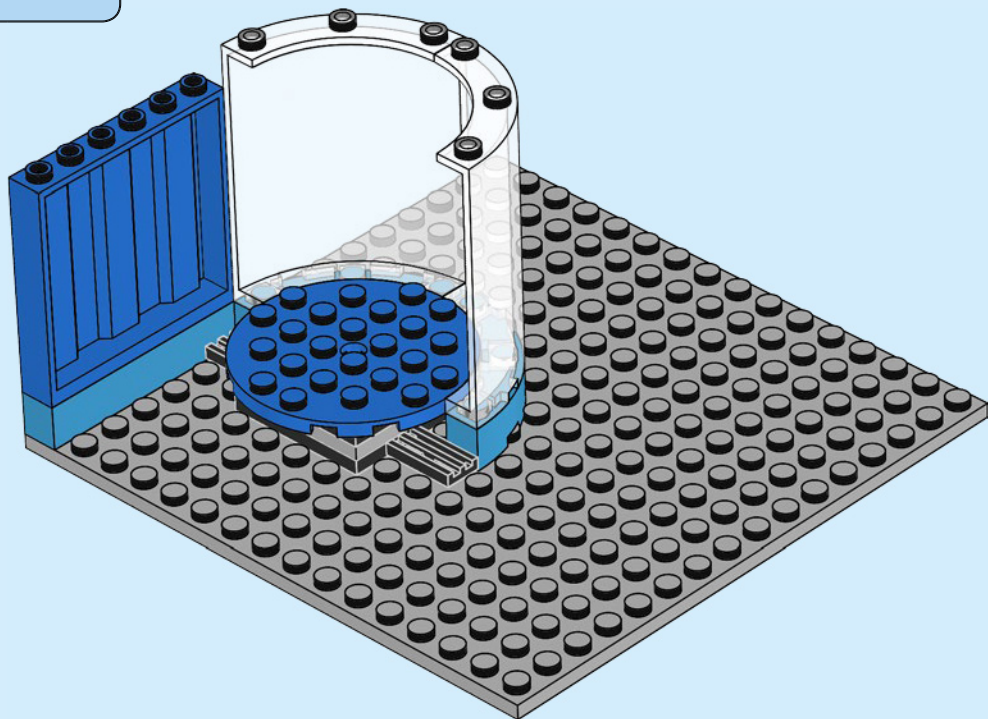

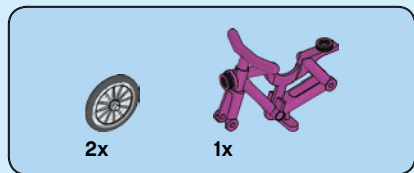

7

1

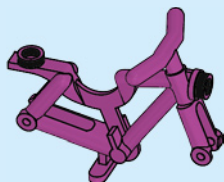

2

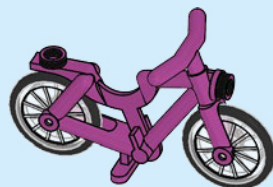

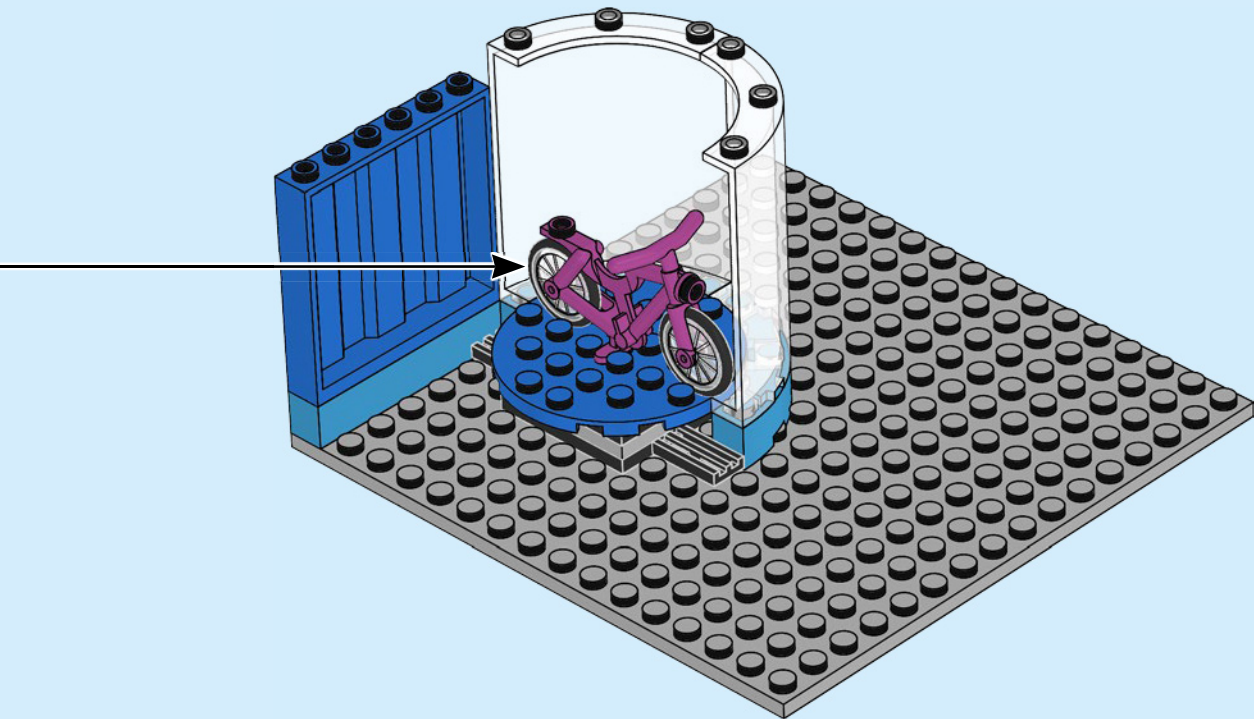



2x

8

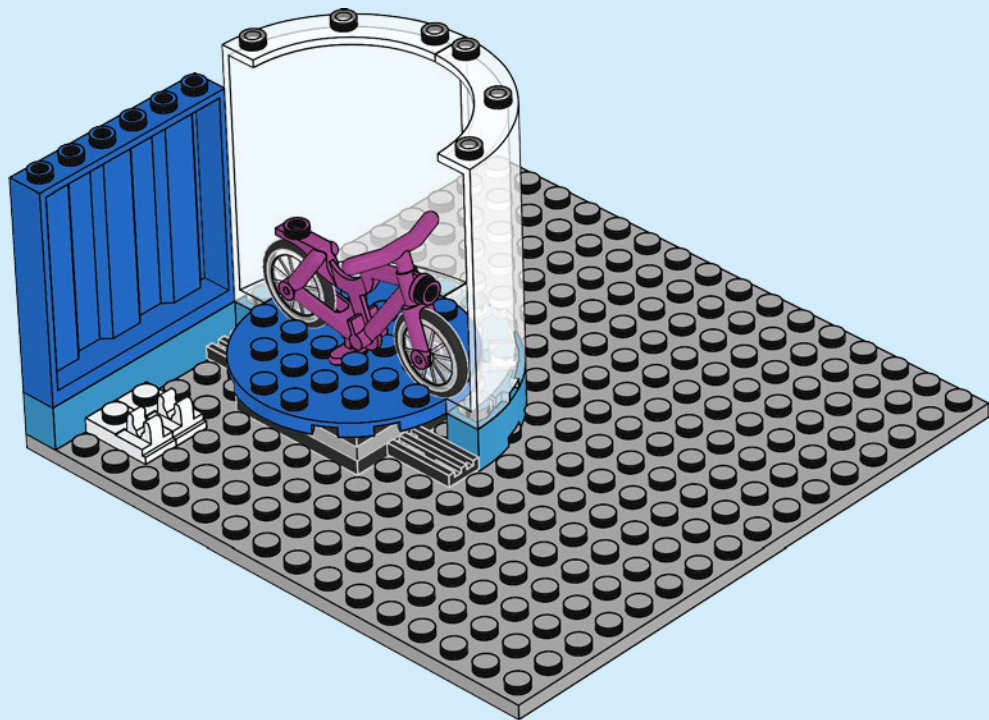

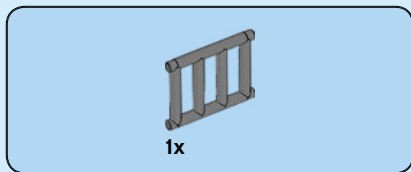

9

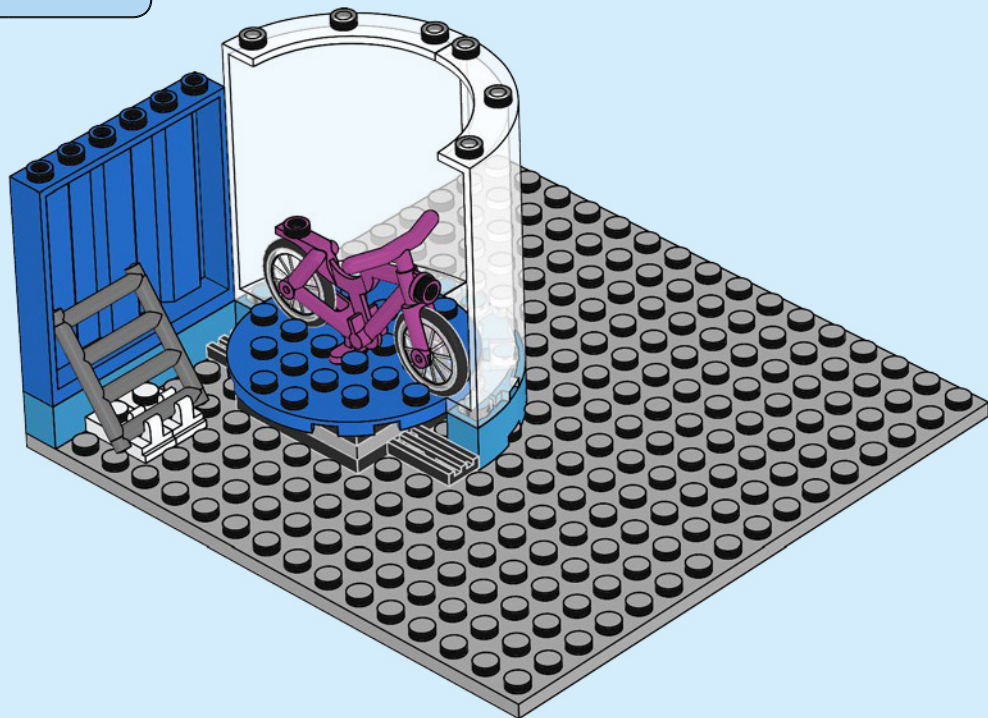



2x



2x



1x



1x

10

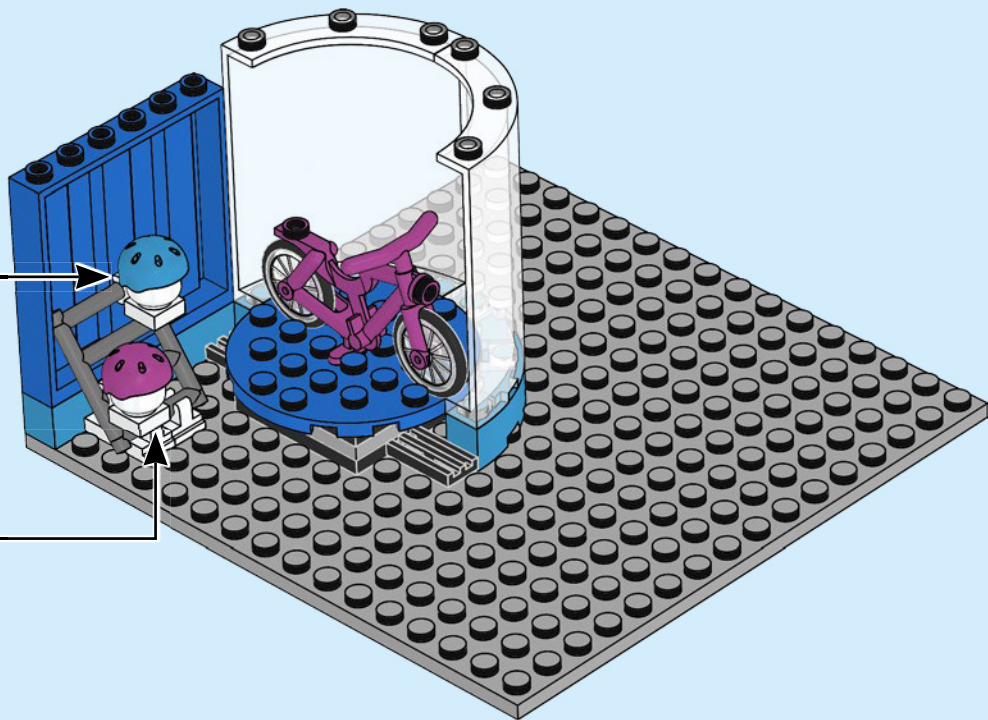
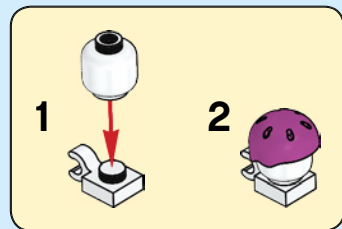
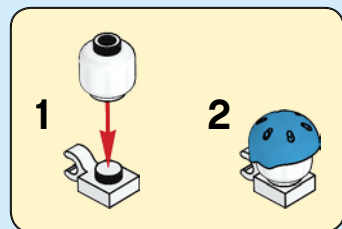

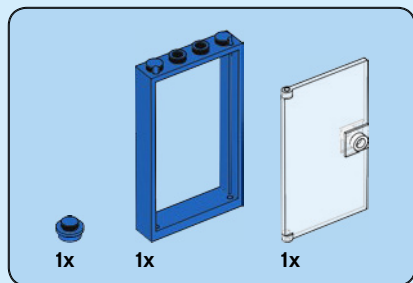

11

1

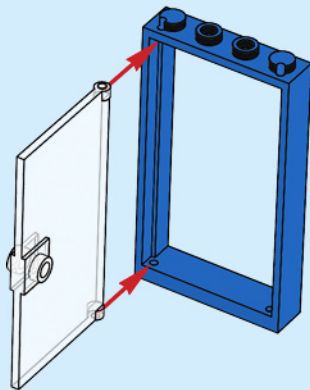

2



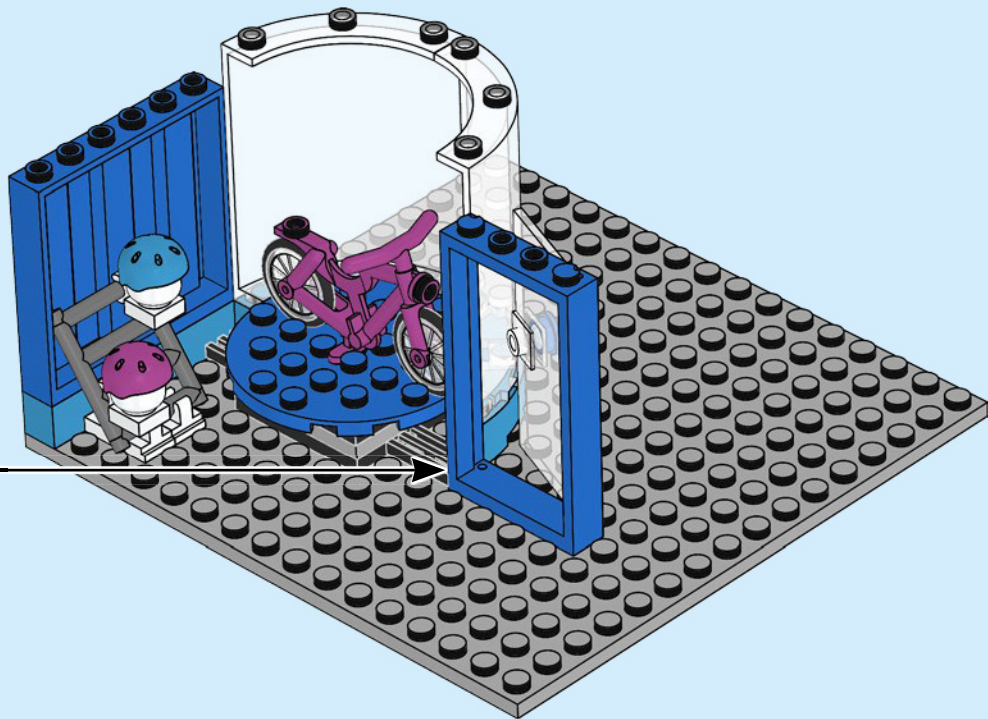

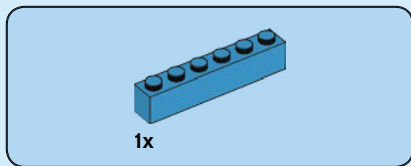

12

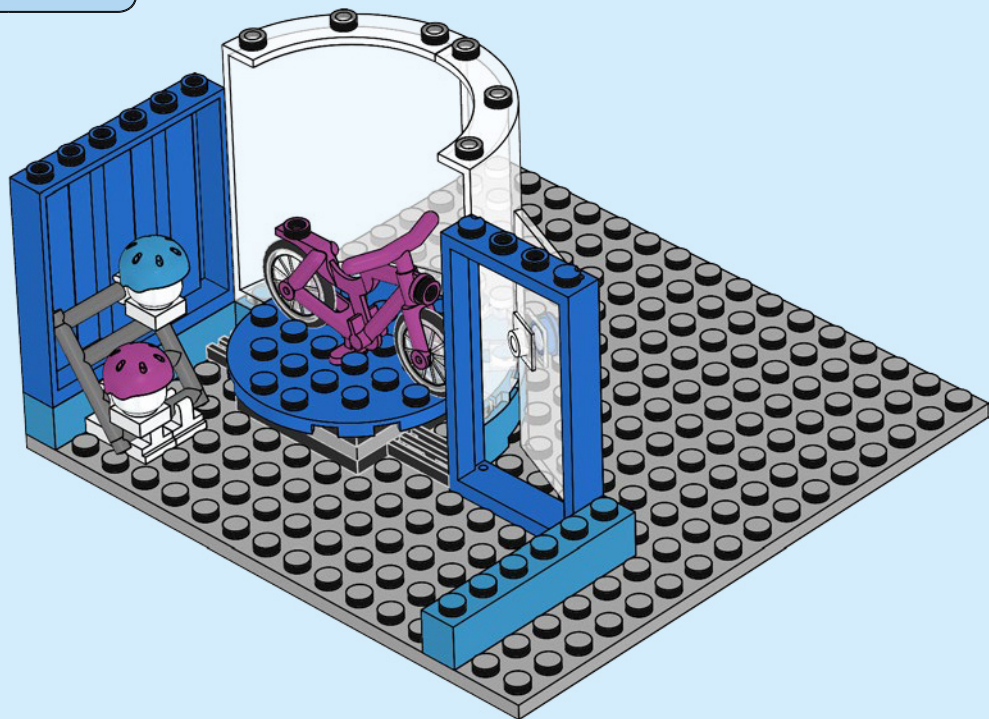

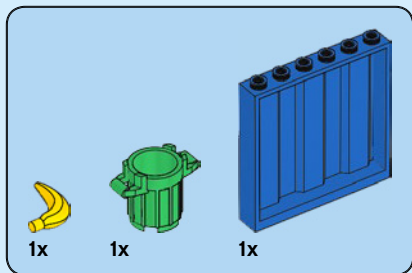

13

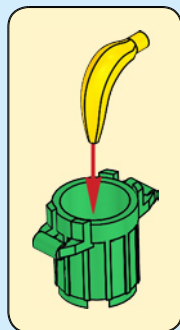
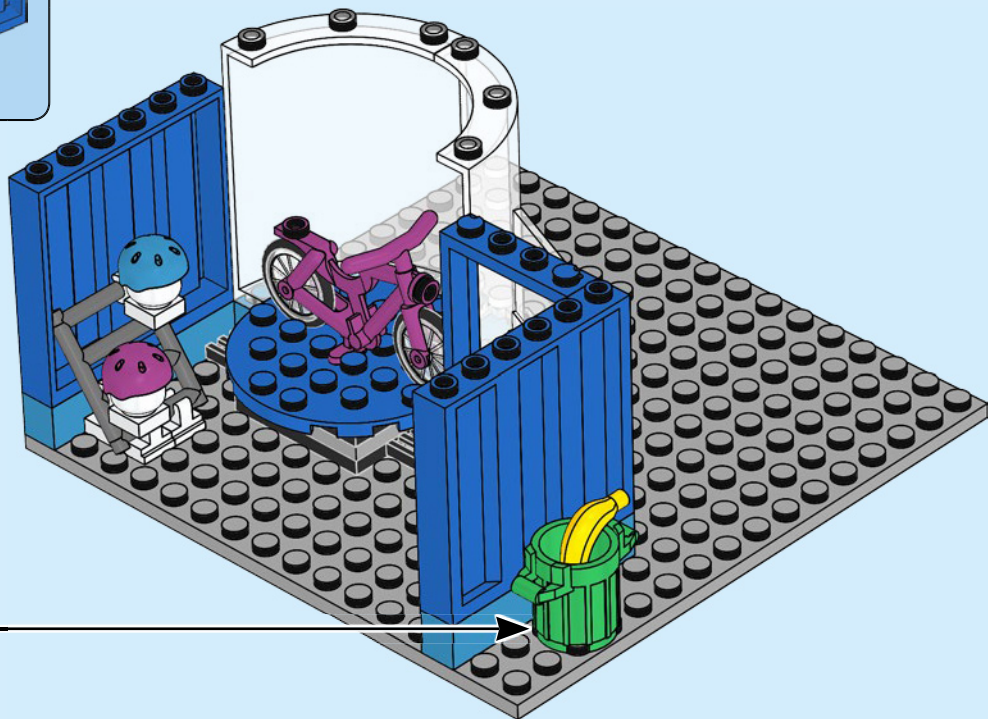

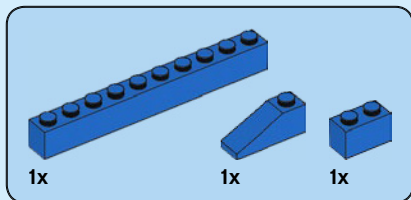

14

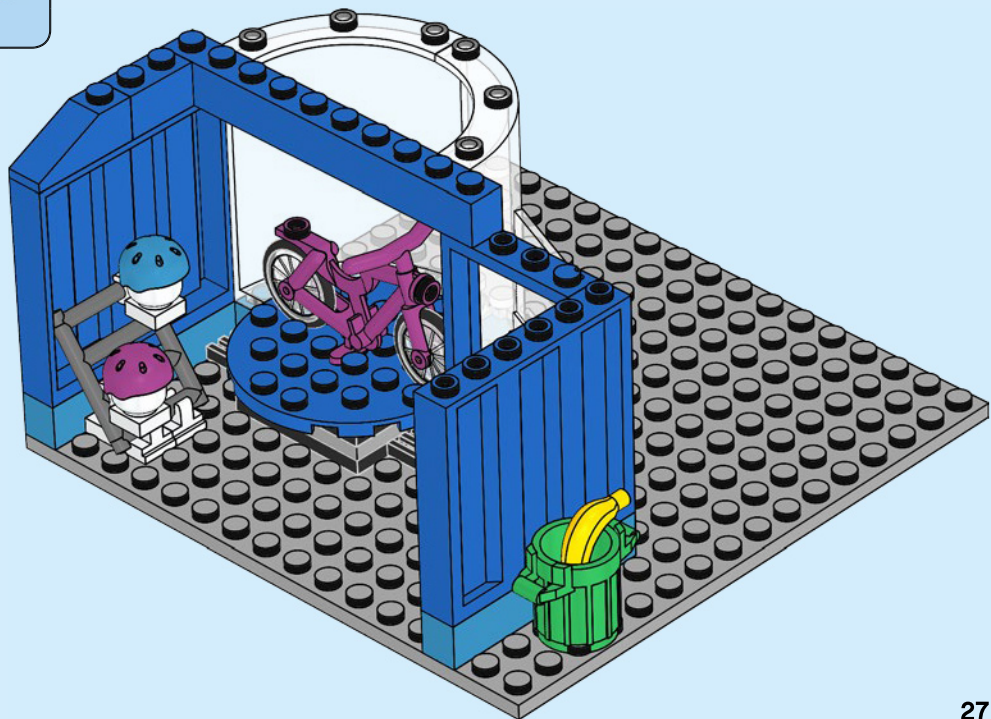

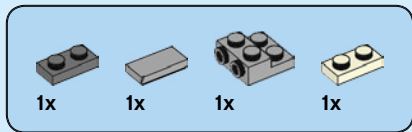

15

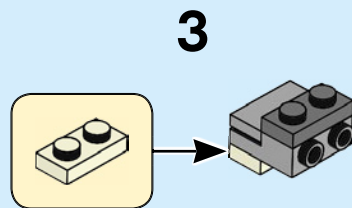
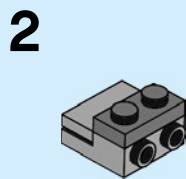
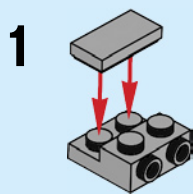

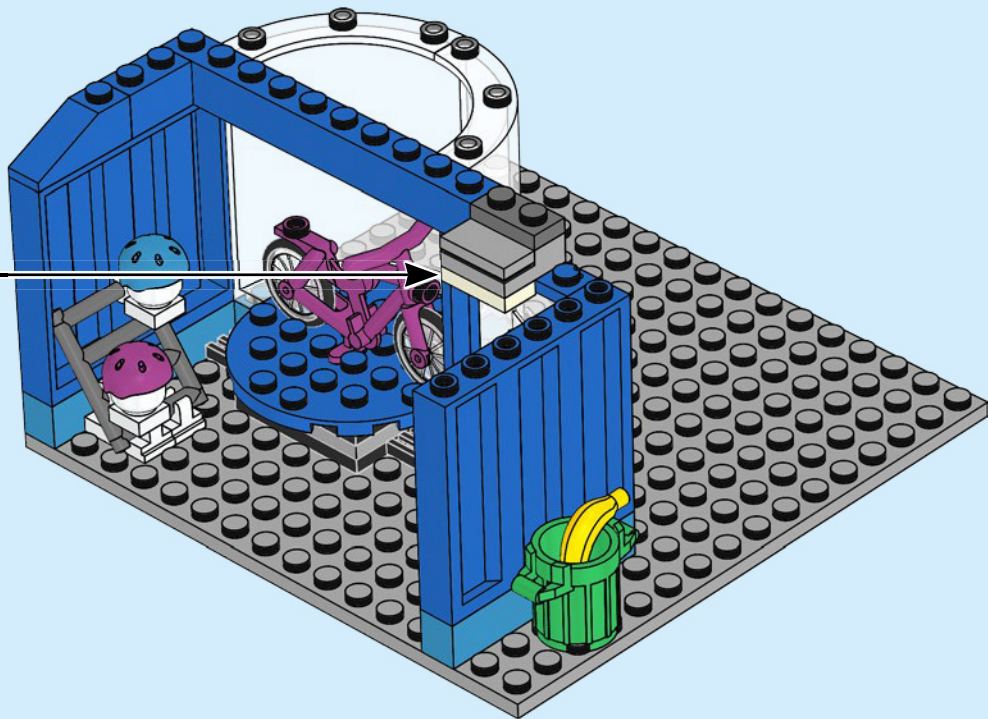



2x



1x

16

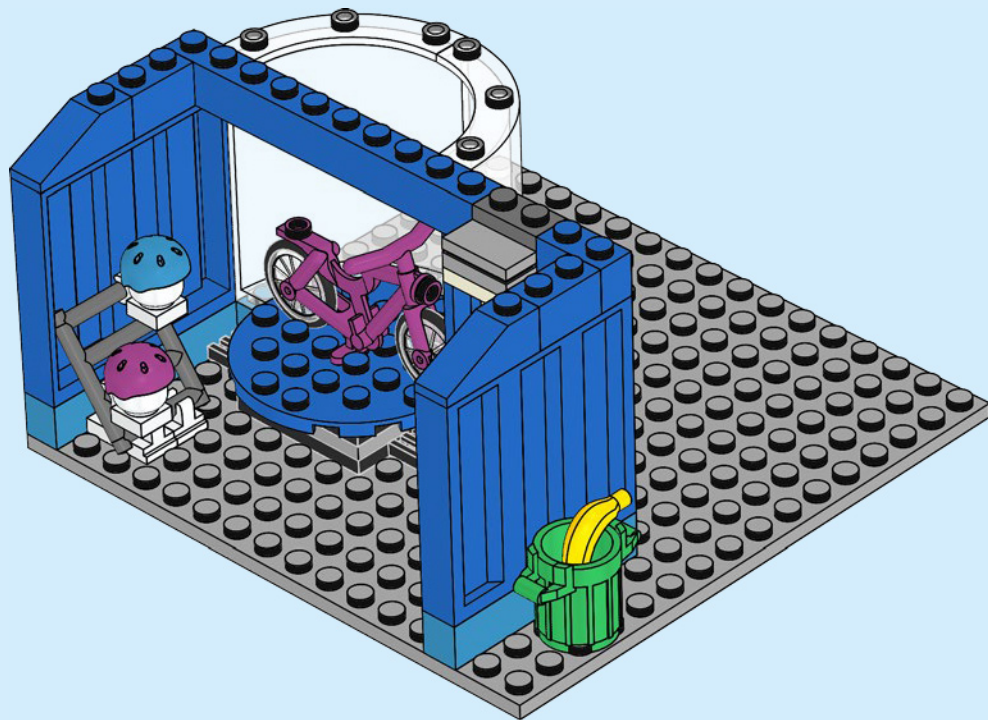

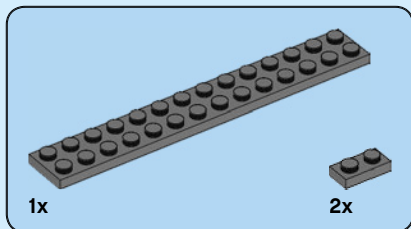

17

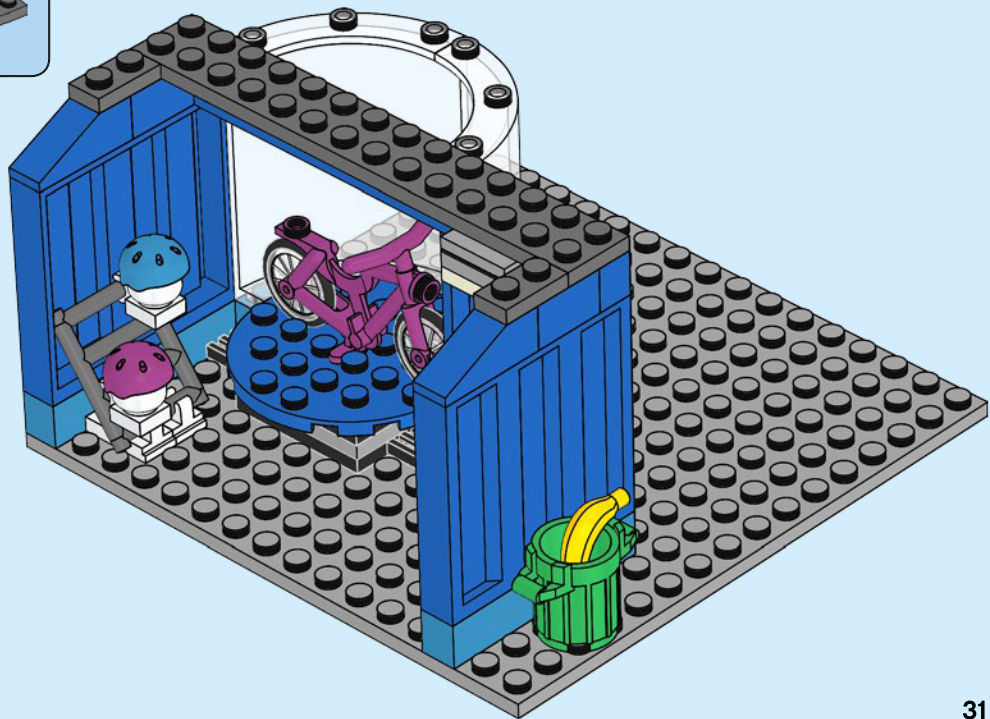

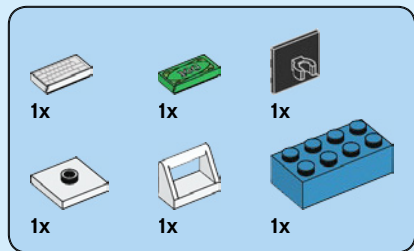

18

1

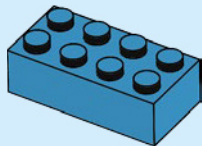

2



3



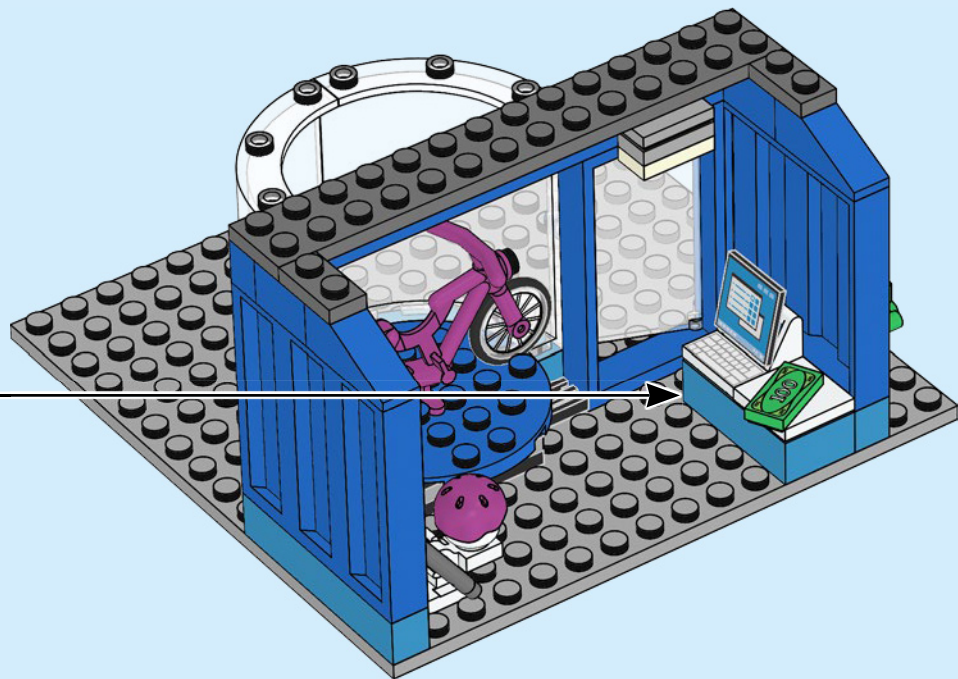

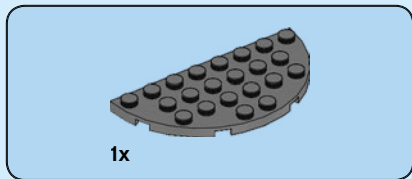

19

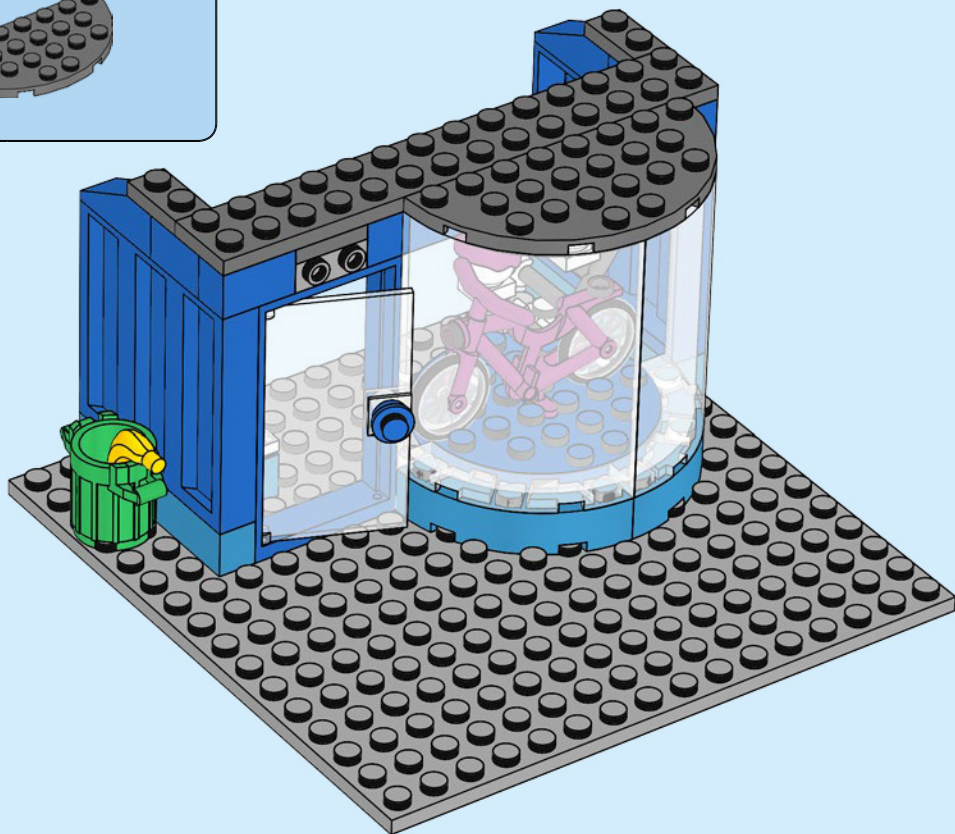



3x

20

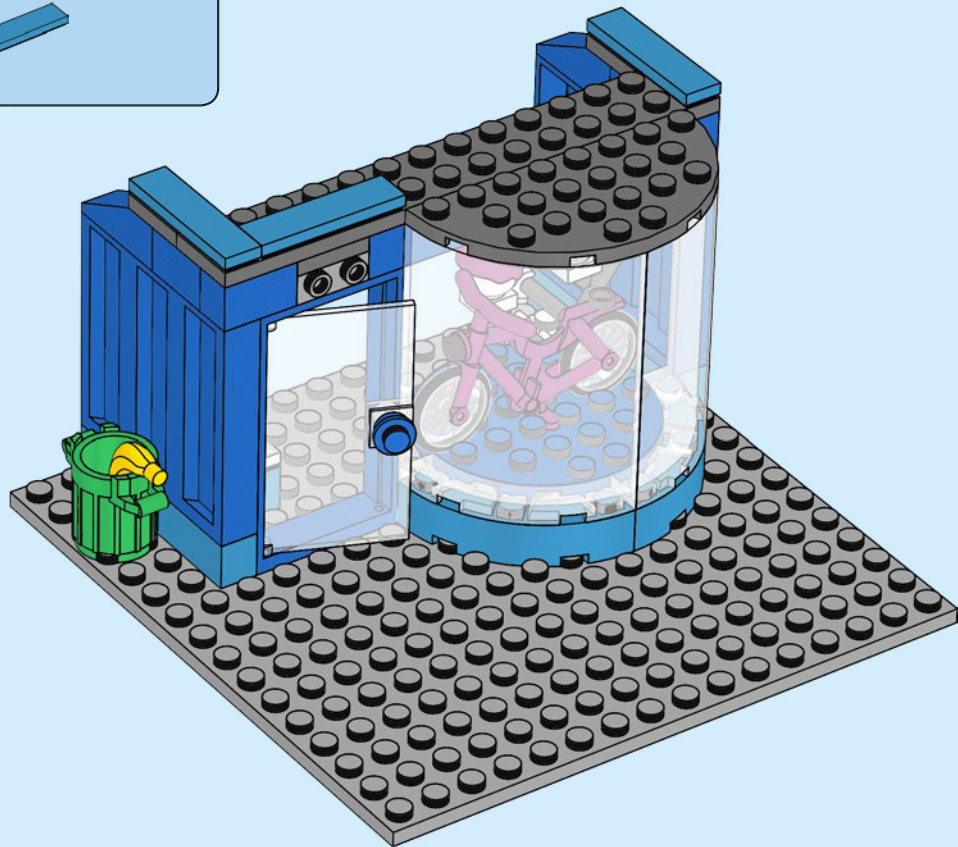

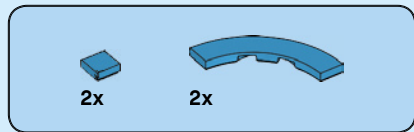

21

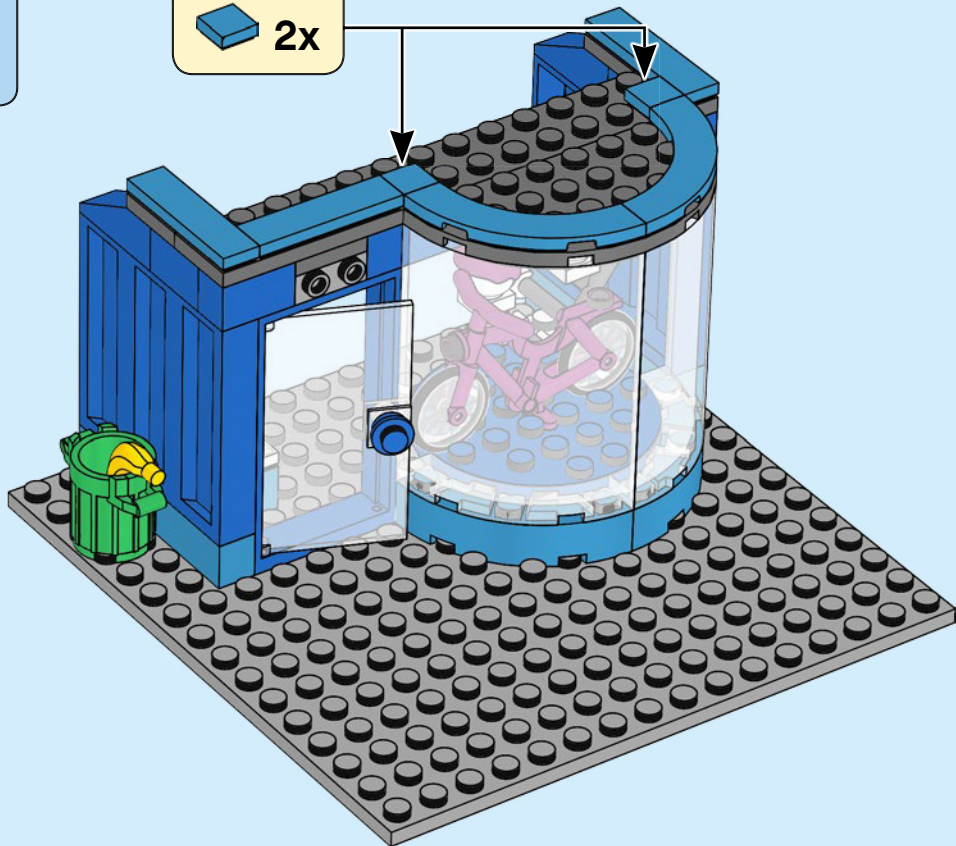

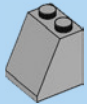

2x



1x

22

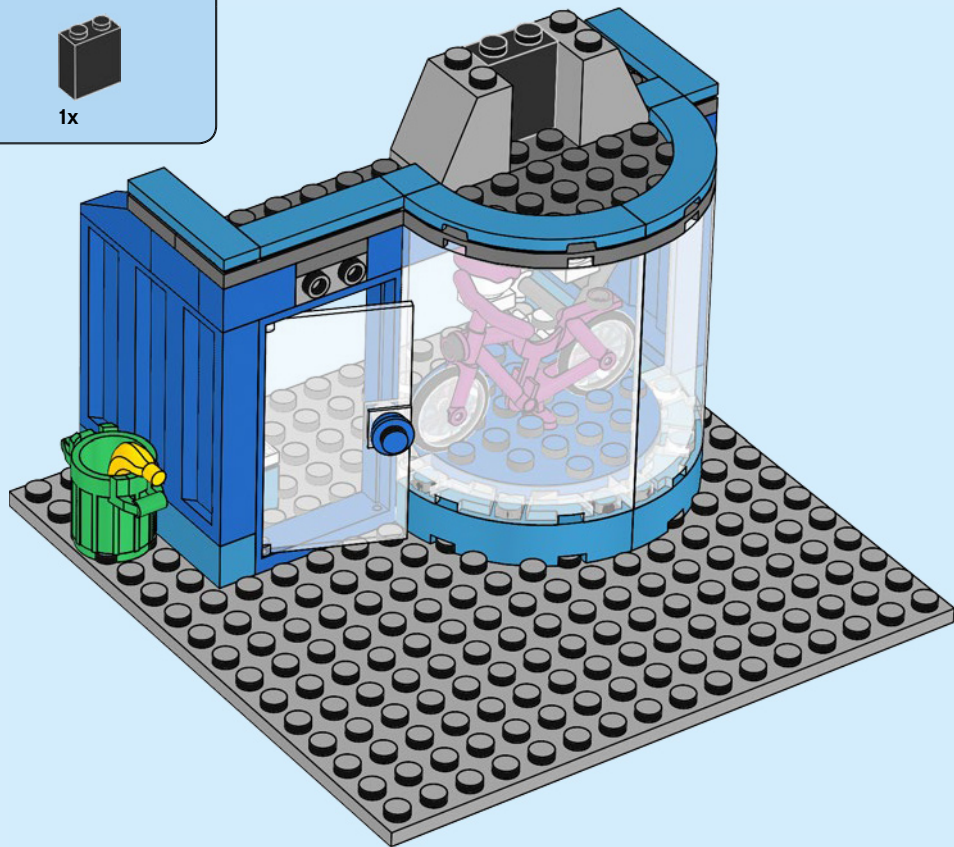



4x

23

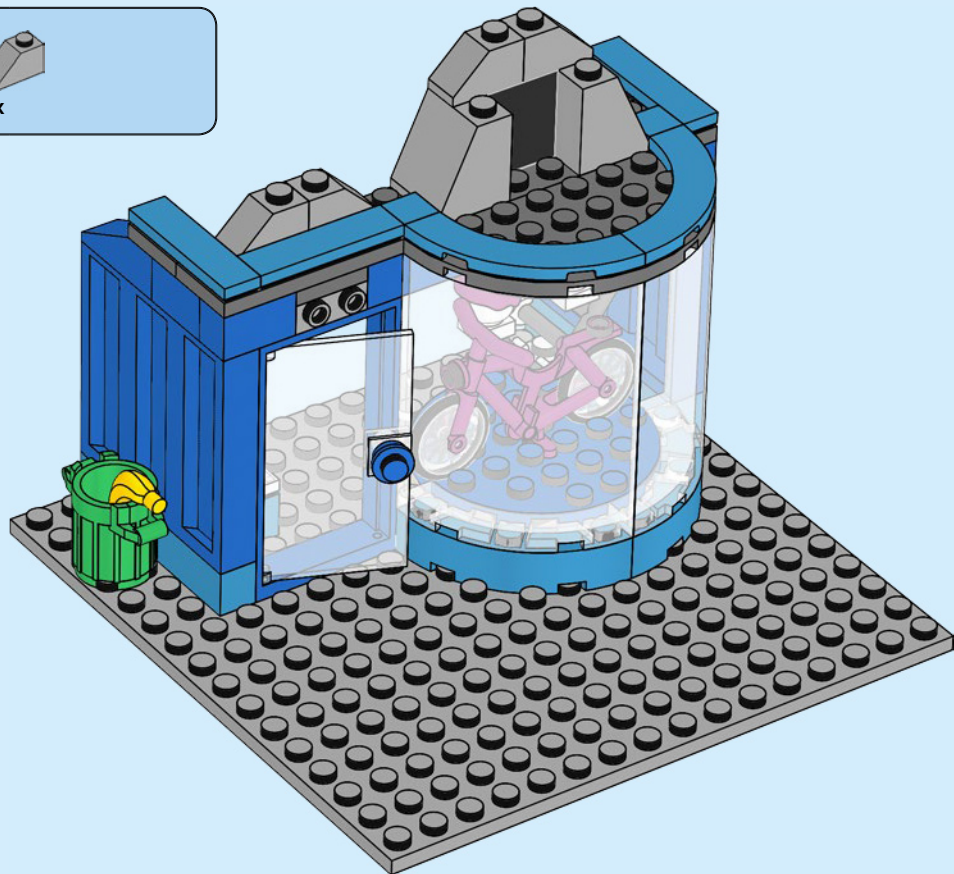

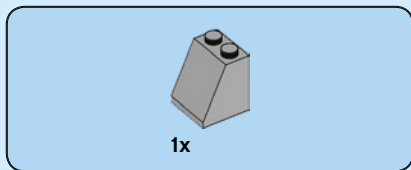

24





3x

25





1x

26

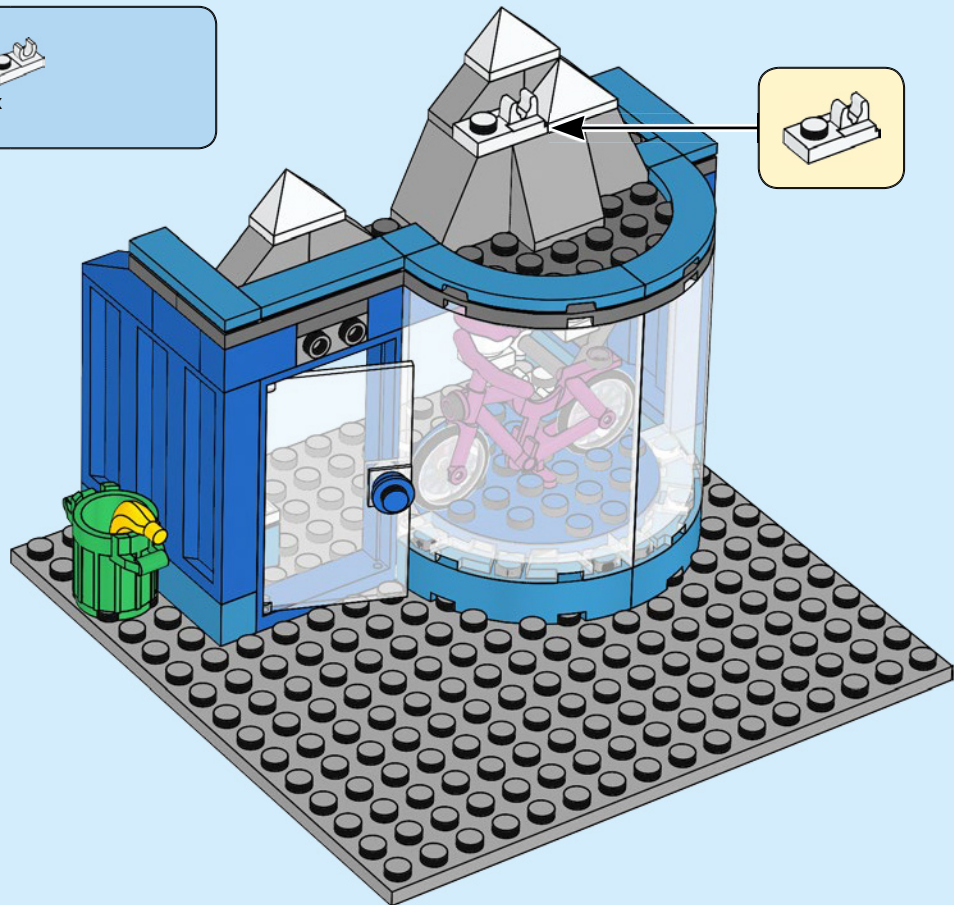

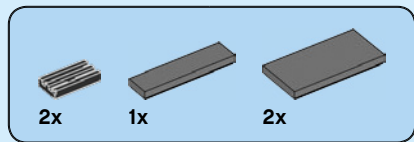

27

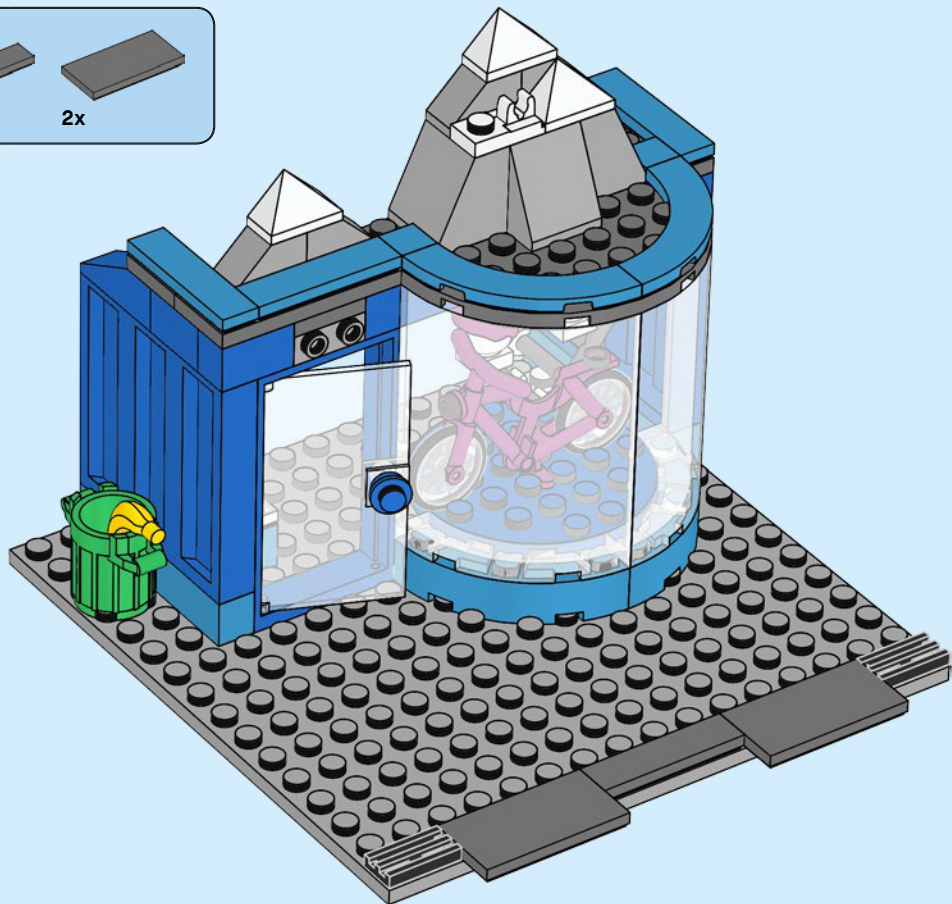

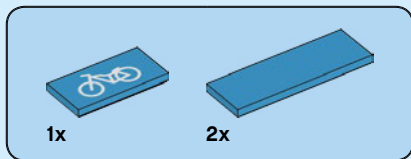

28

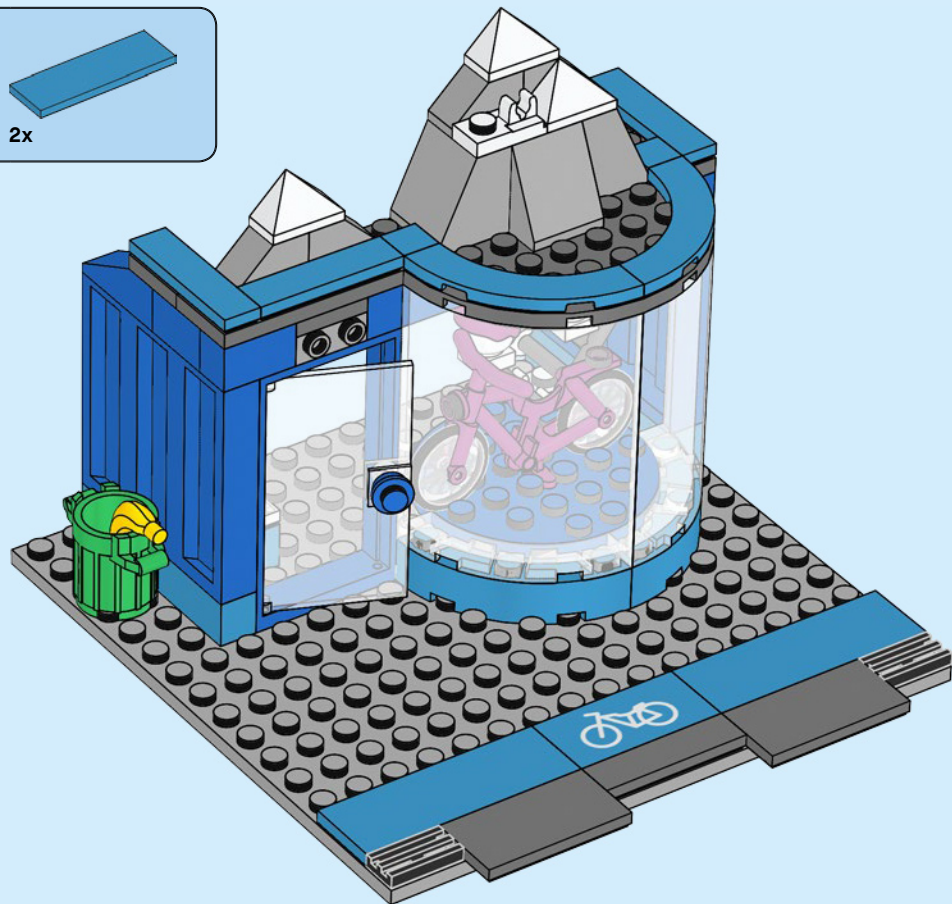



29

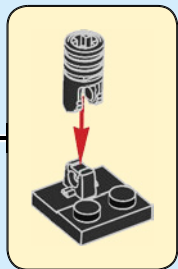
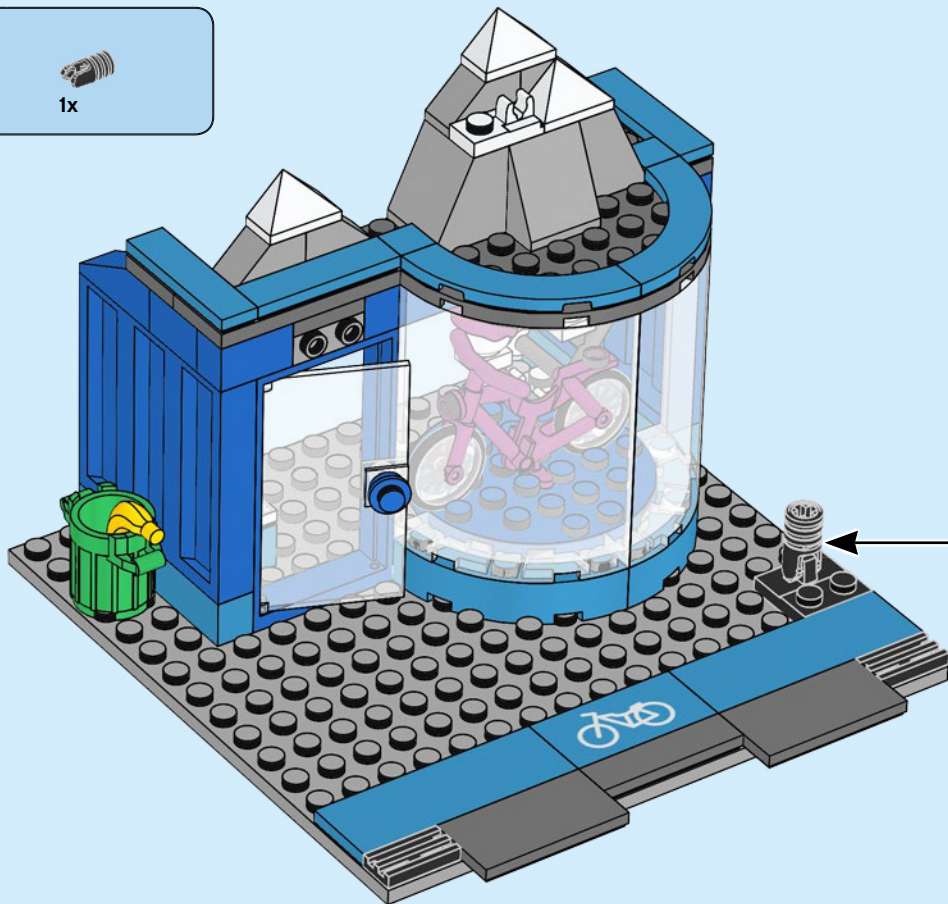

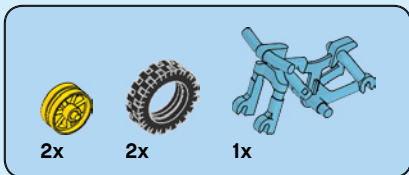

30

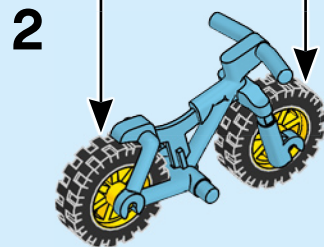
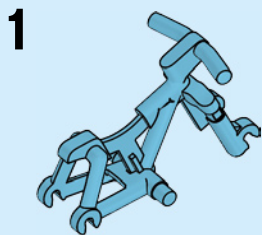

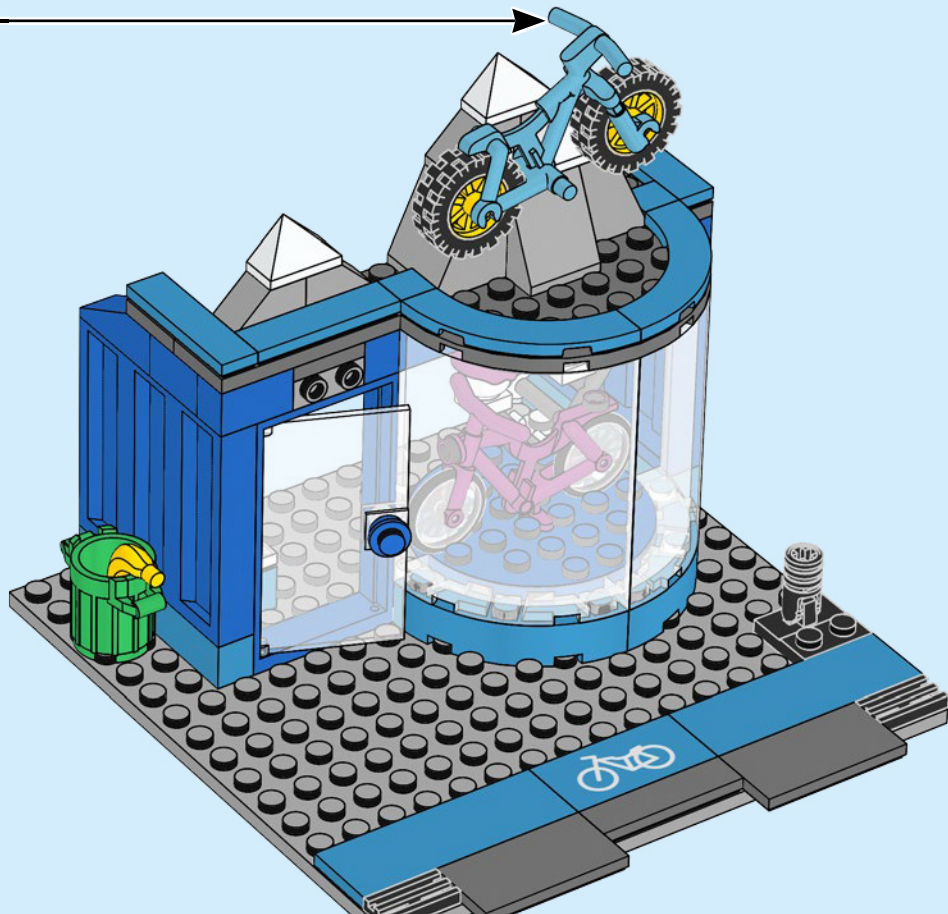

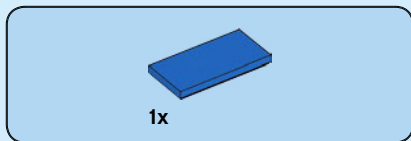

31

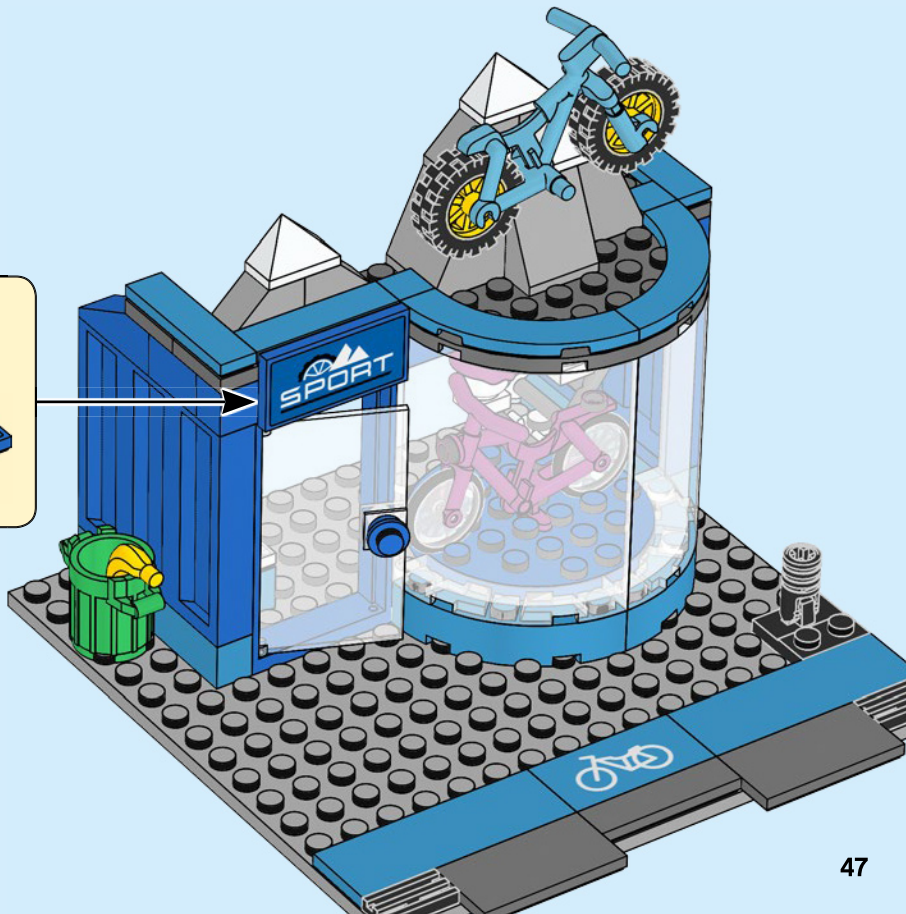
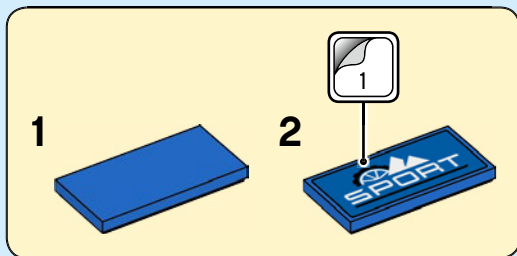

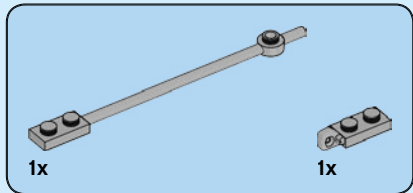
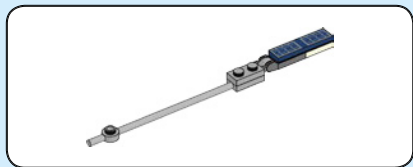

32

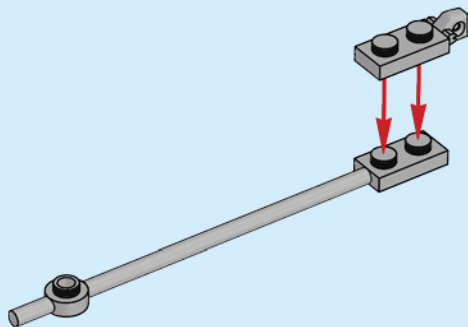



1x

33

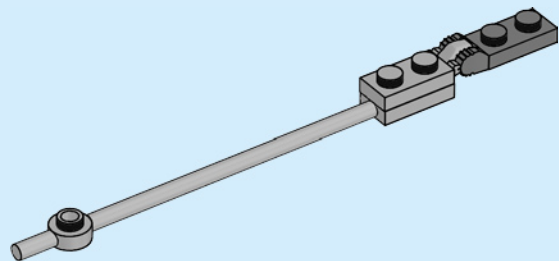

1x

34

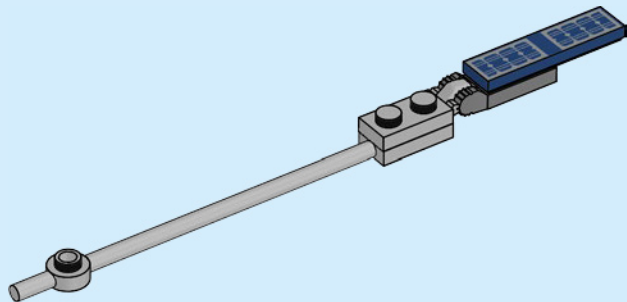



1x

35

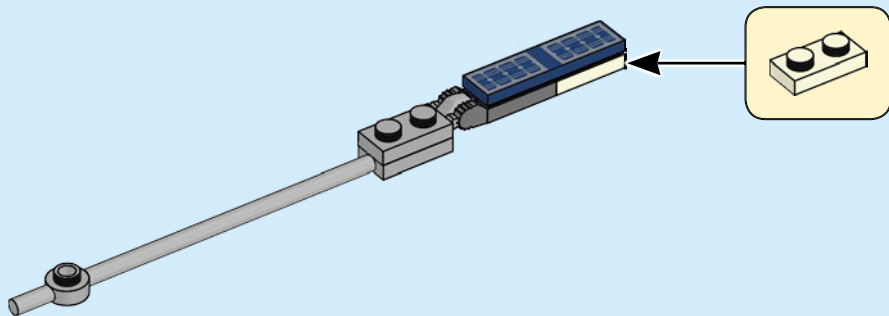

36

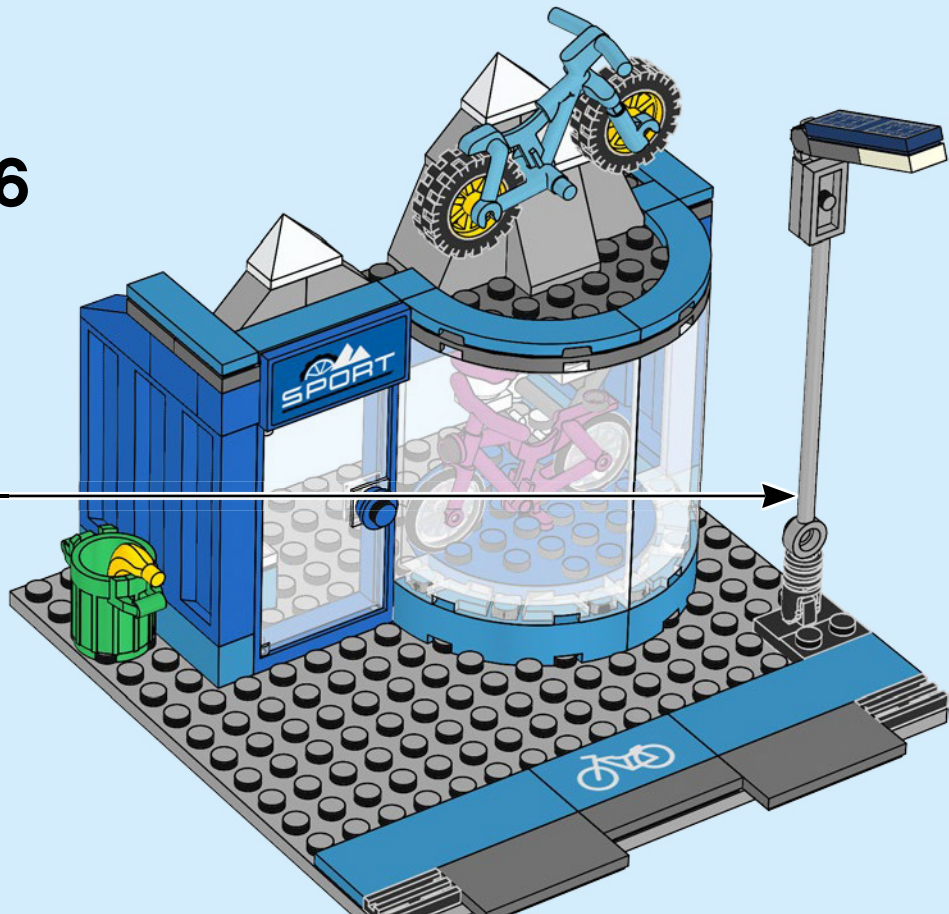



CITY



60277



60275



60276



CITY

60306



5

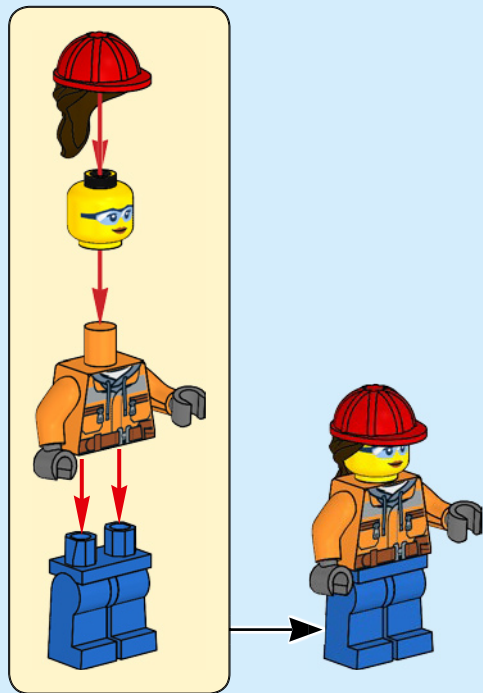
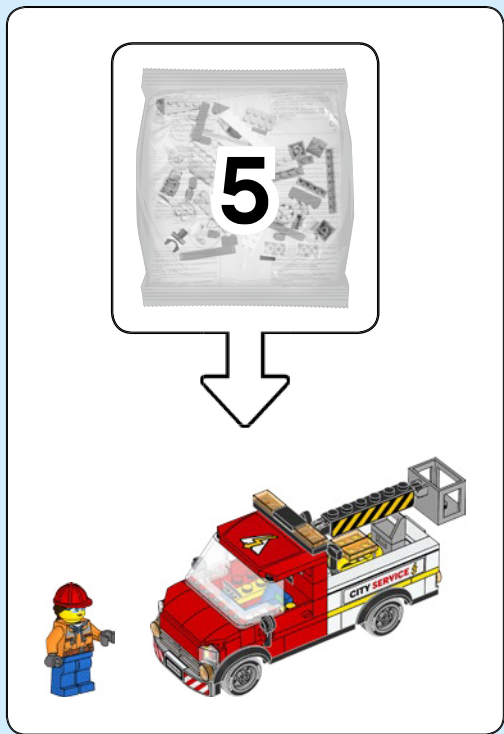

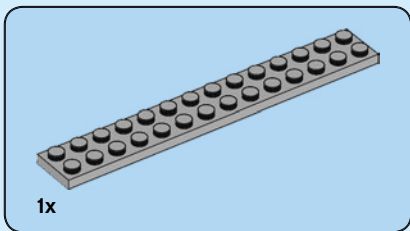

1x

1

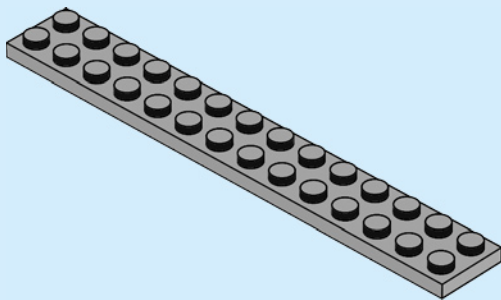



2x

2

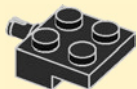

2x

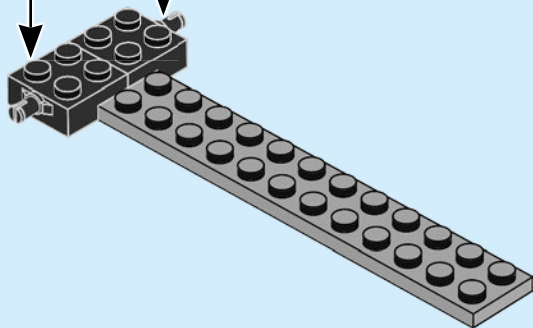

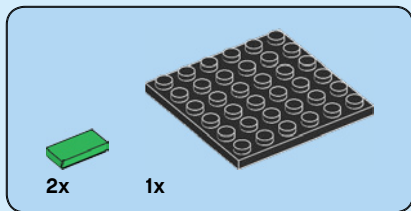

3

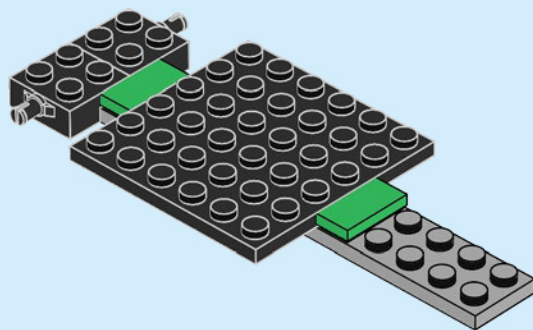



2x

4

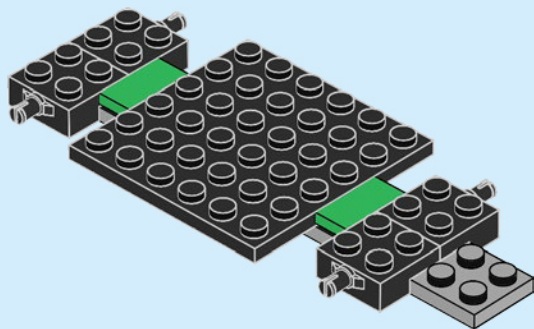

6

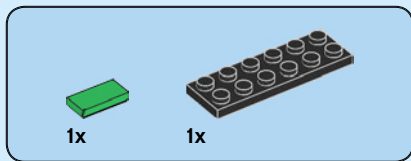

5

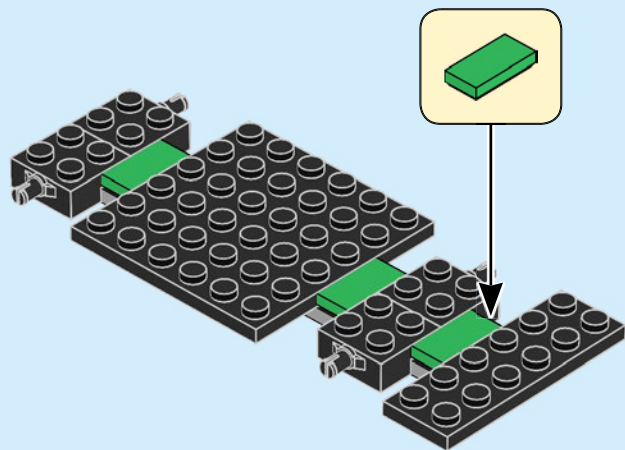

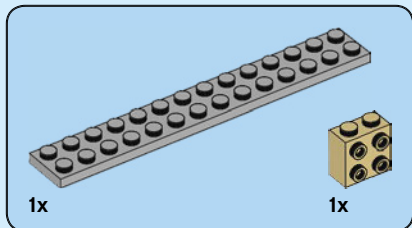

6

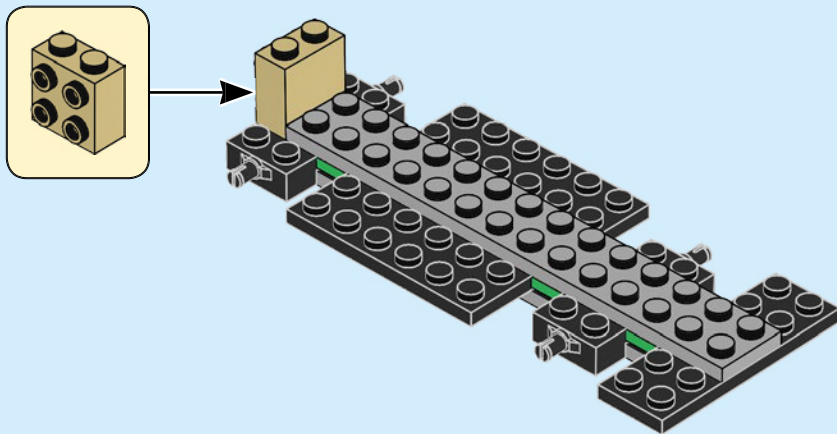

8



2x

7

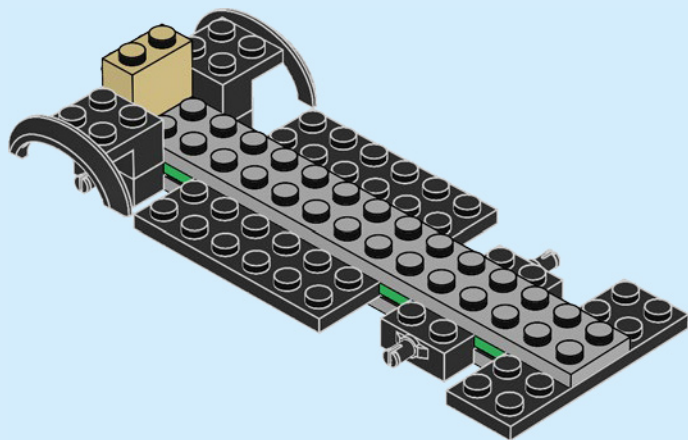



1x

9

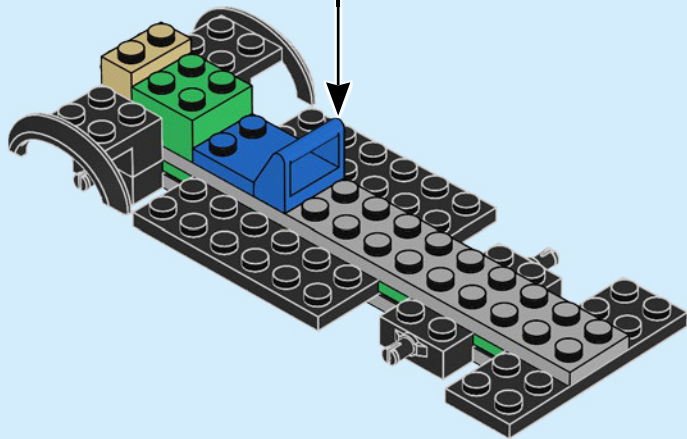



1x

10

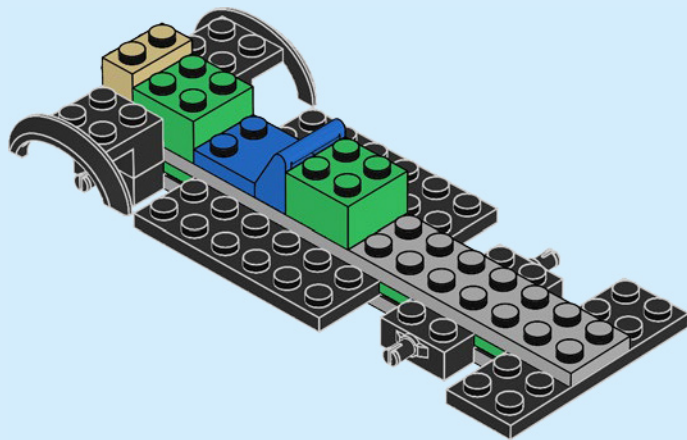

12

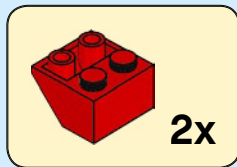
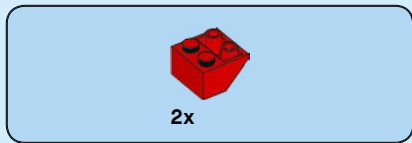

11

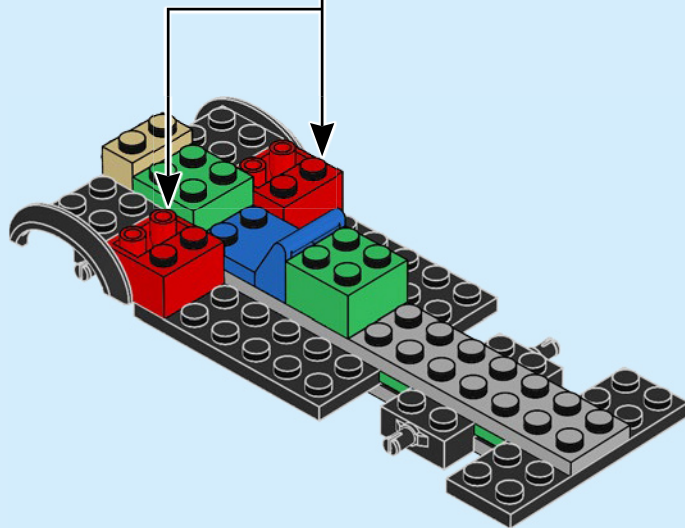



2x

12

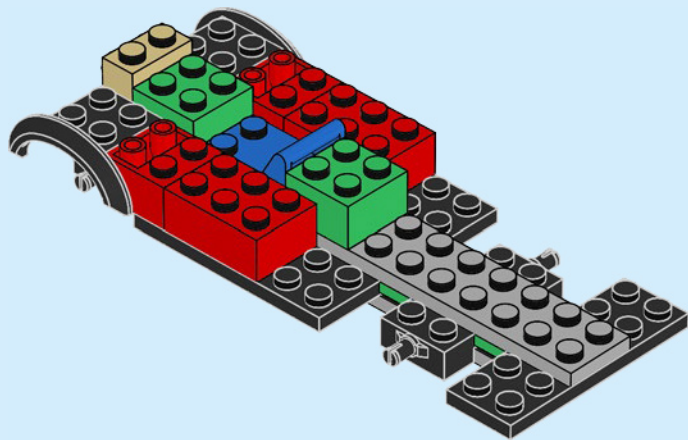

14



2x

13

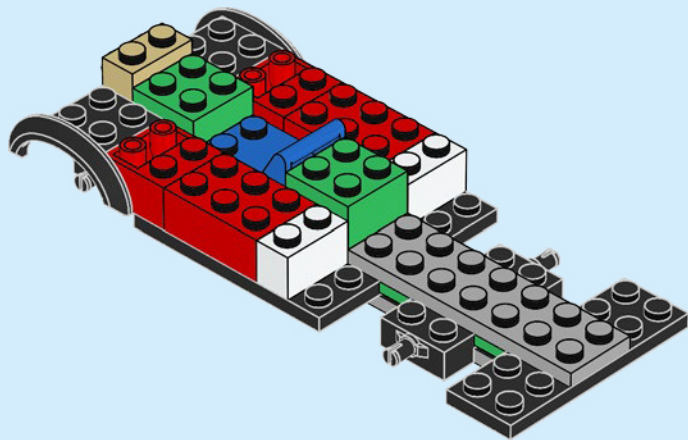



2x

14

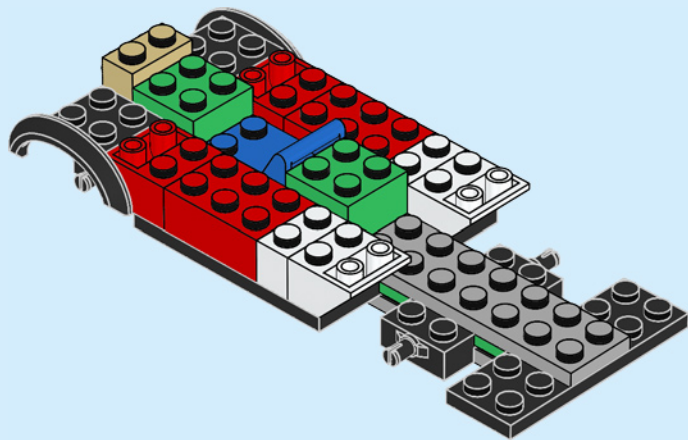



2x

15

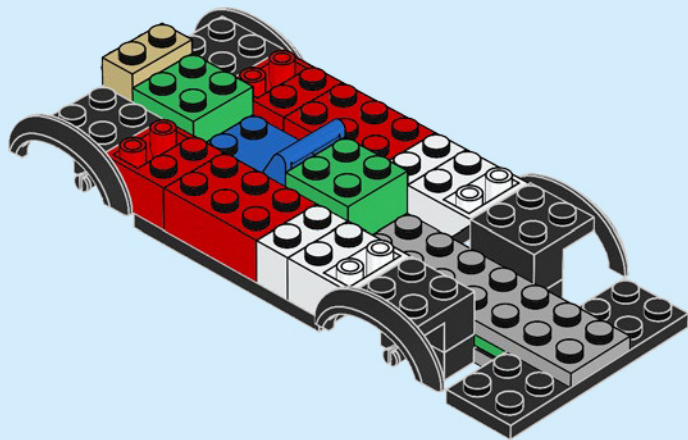



2x

16

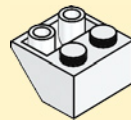
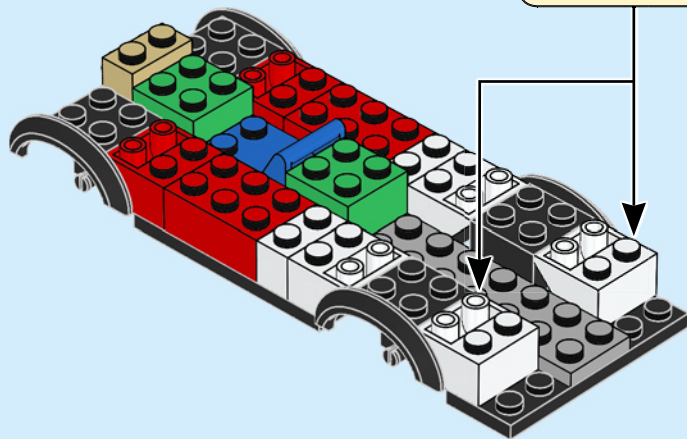

2x



2x



2x

17

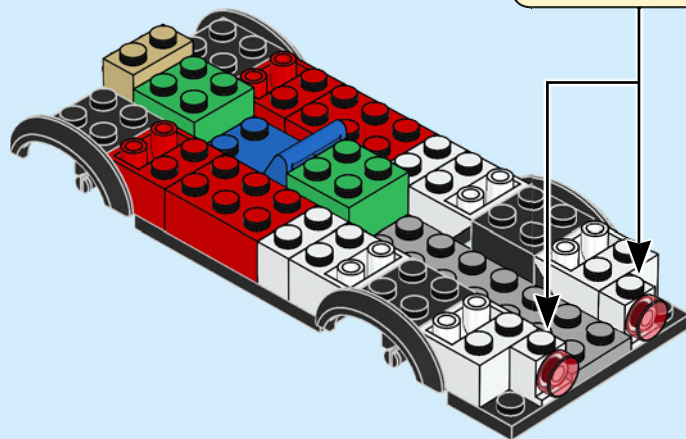

2x



2x



2x

18

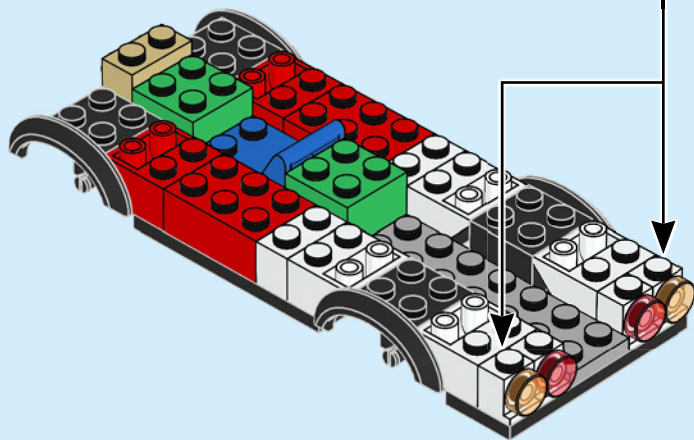
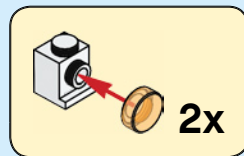



2x



1x

19

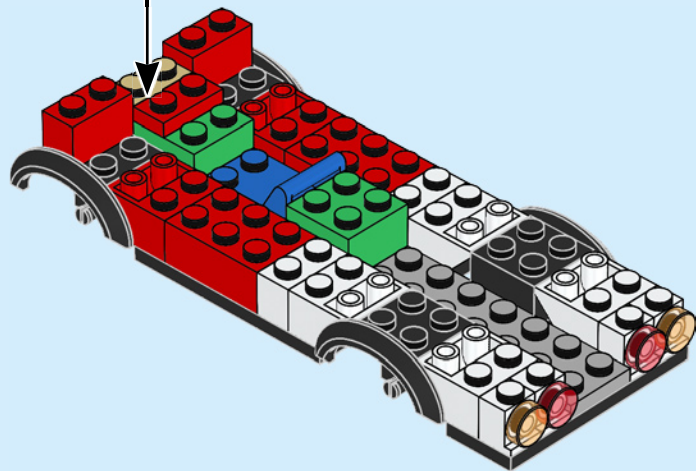
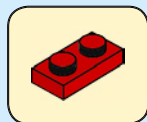

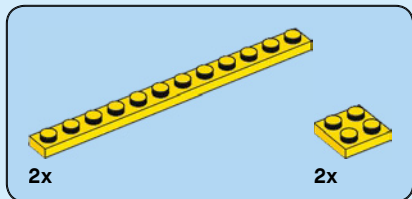

20

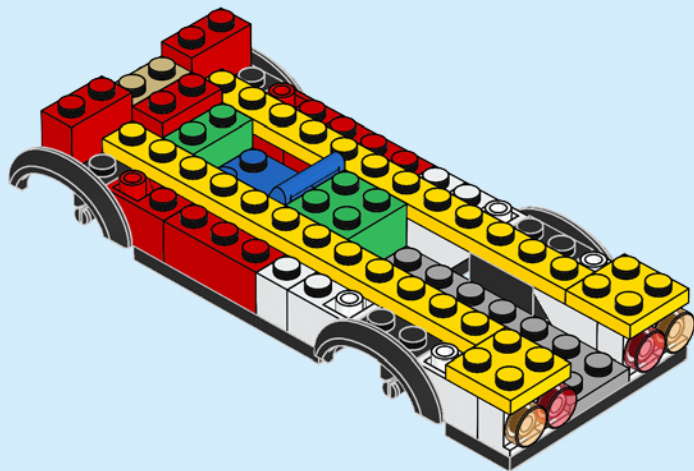

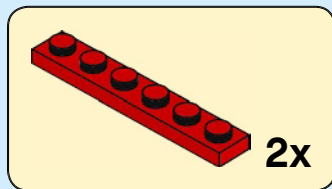
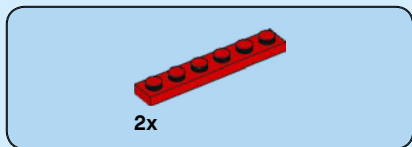

21

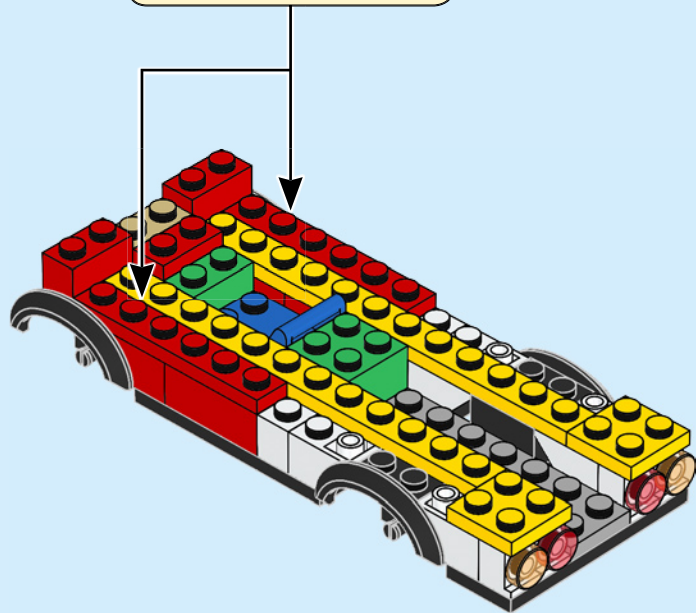



2x

22

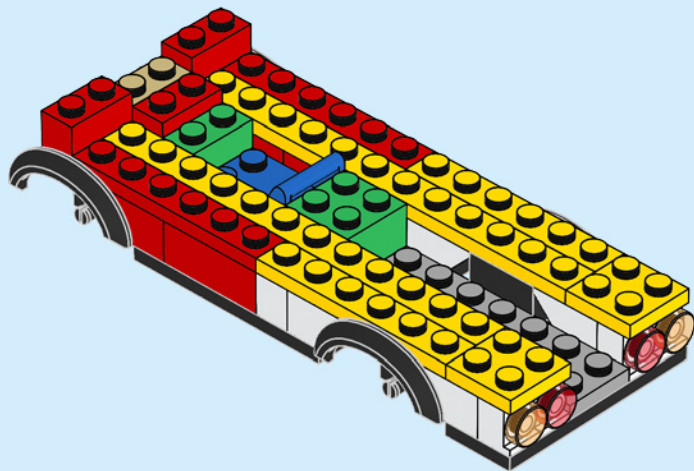

24



1x

23

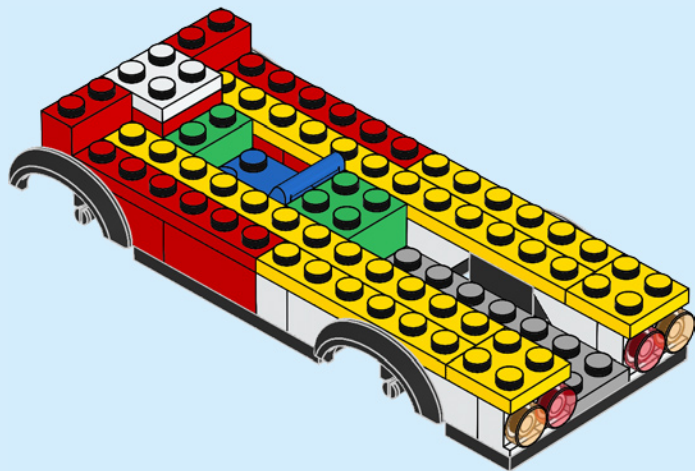



2x



1x

24

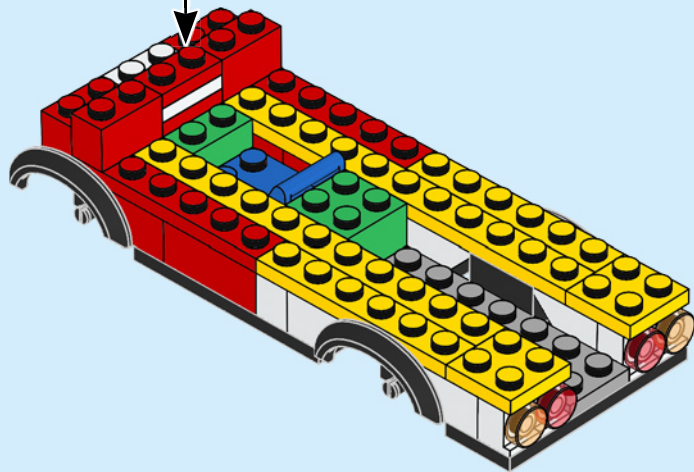



1x

25

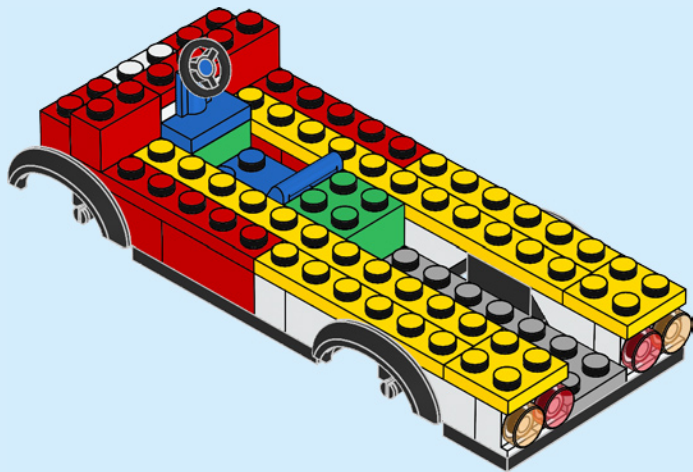



2x



2x

26

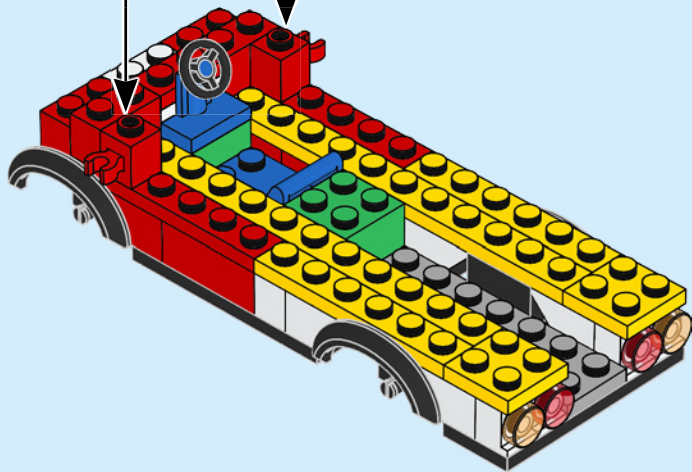

28

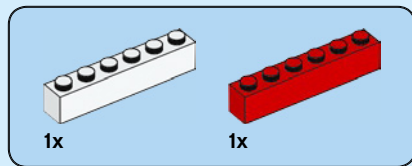

28

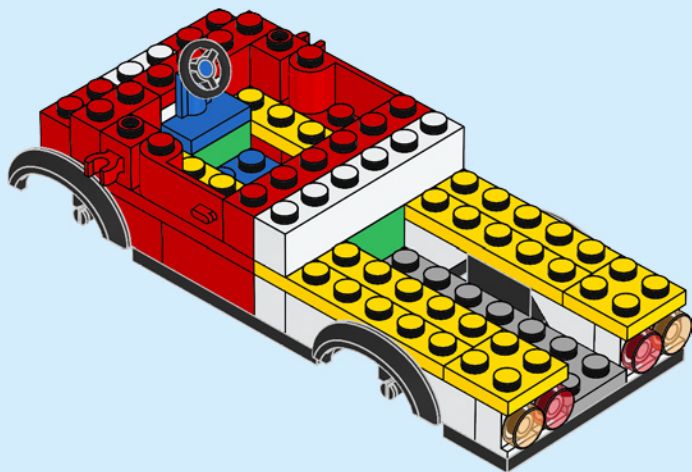

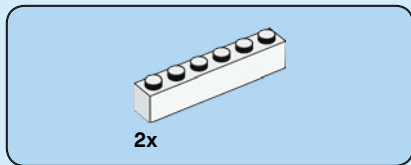

29

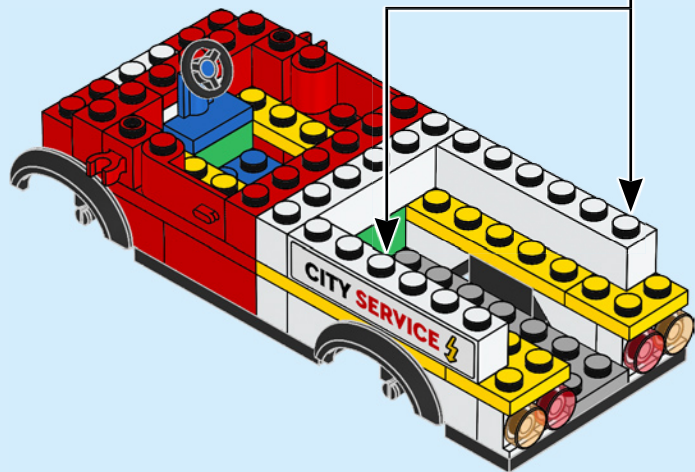
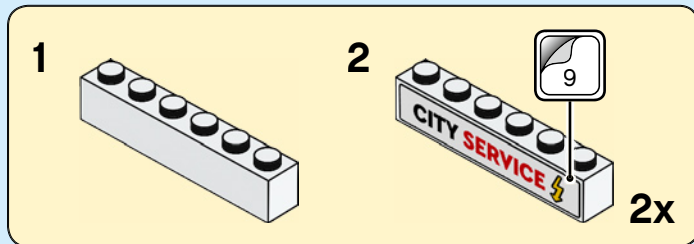

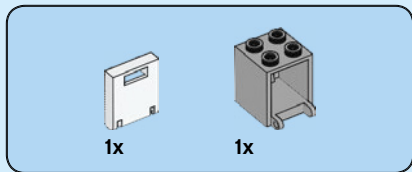

30

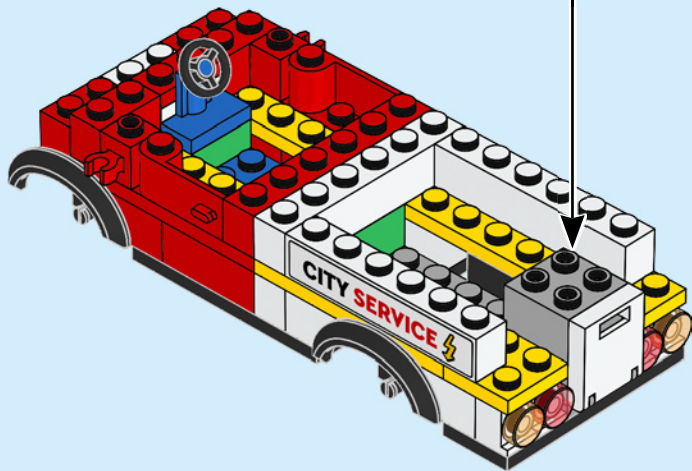
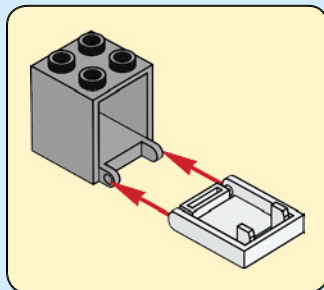



2x

31

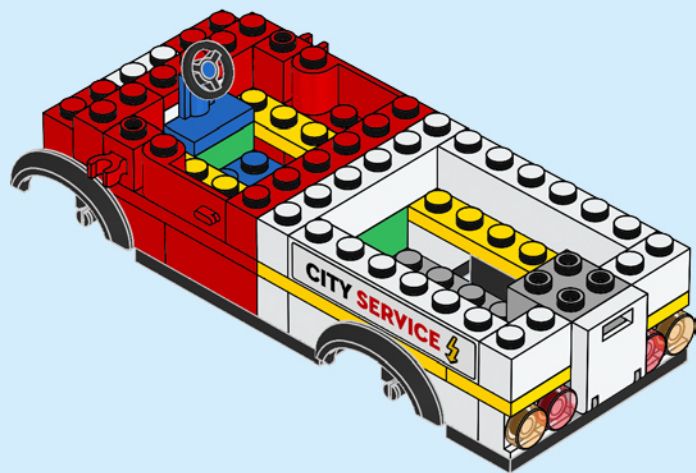

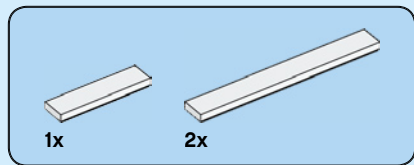

32

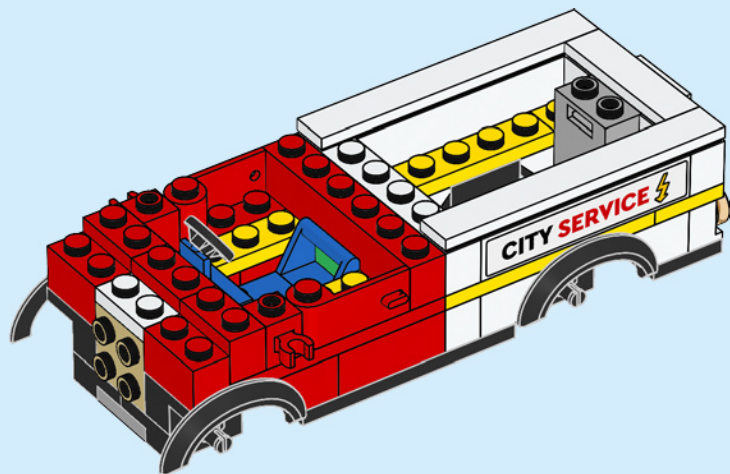



1x

33

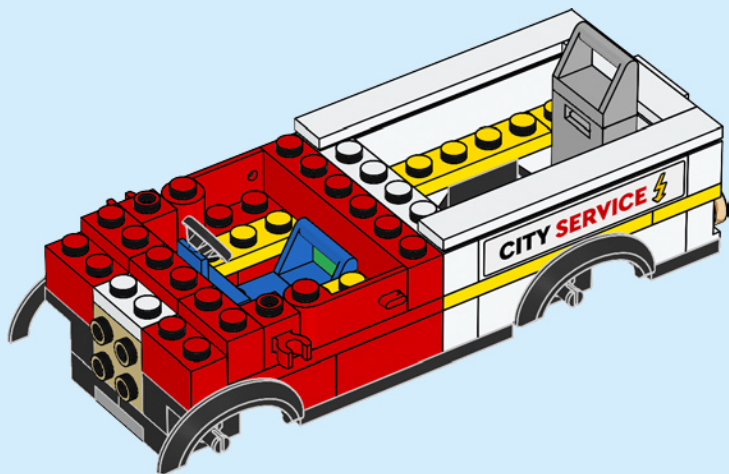



2x

34

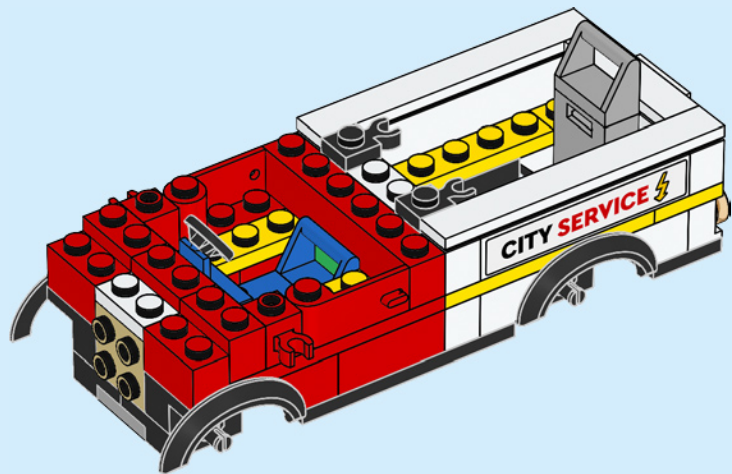

36

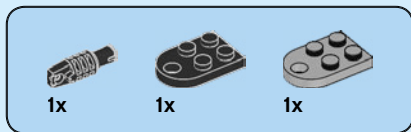

35

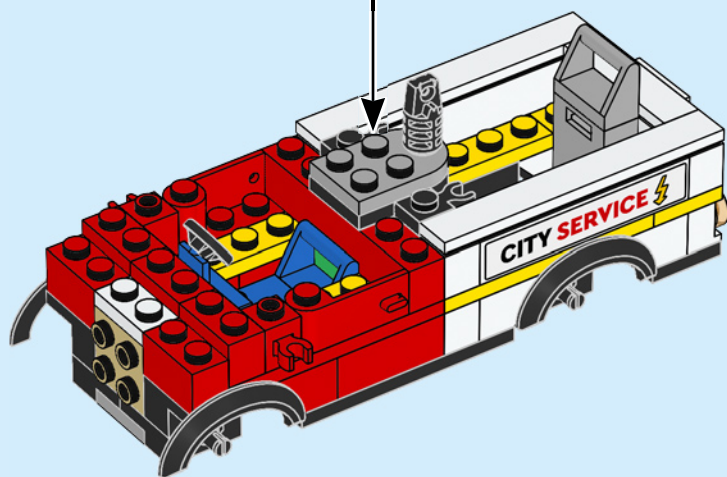
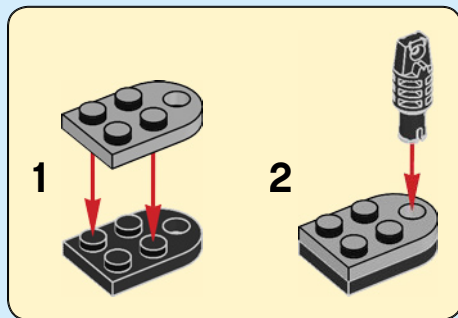



1x

36

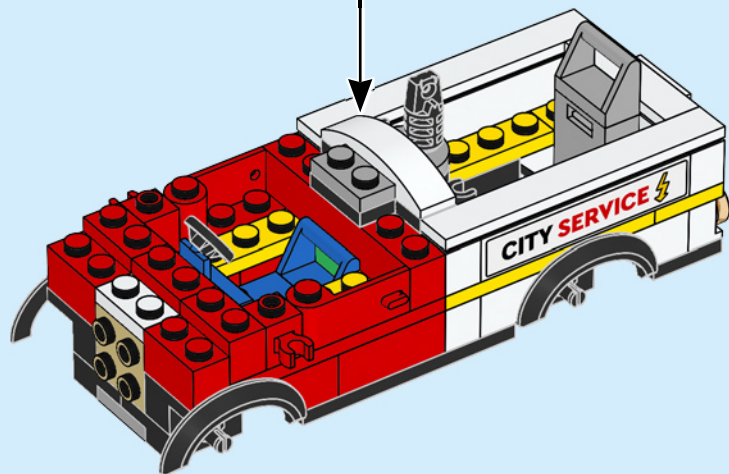
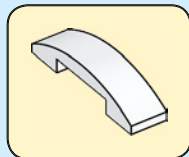

38



1x

37

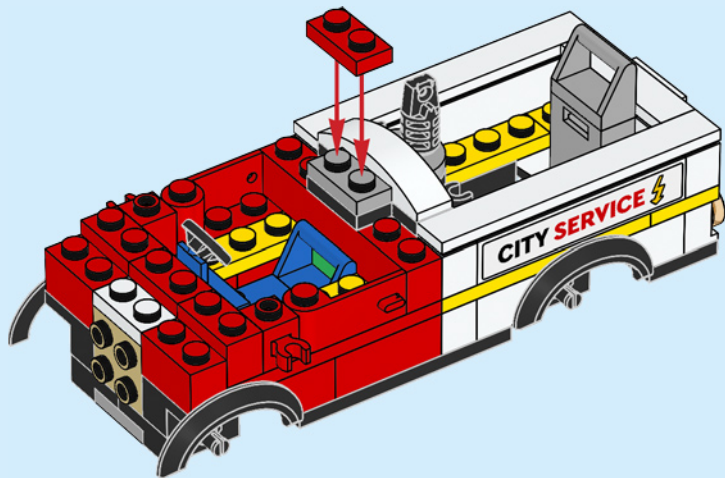



2x

38

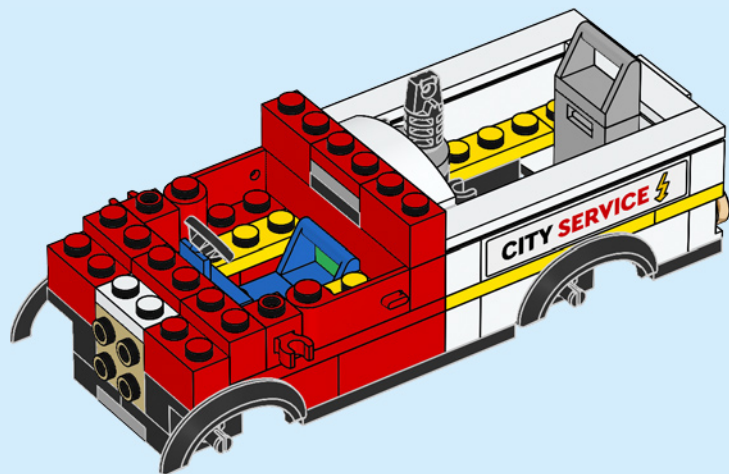



2x



1x

39

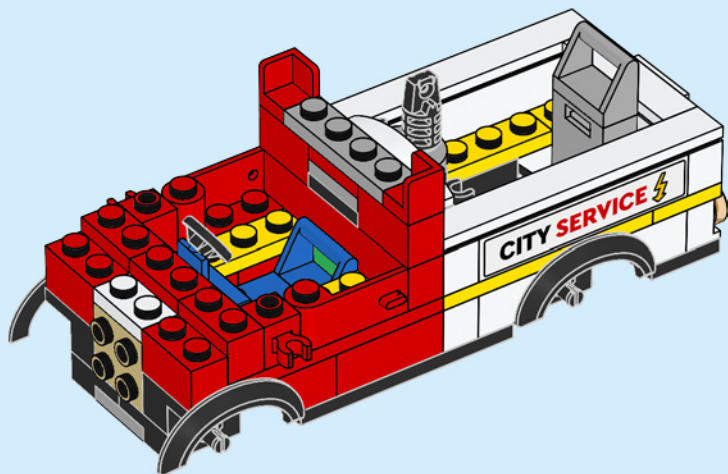

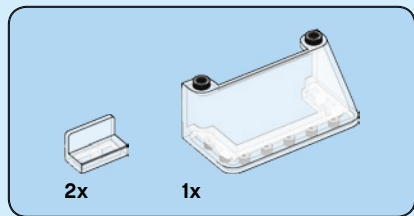

40

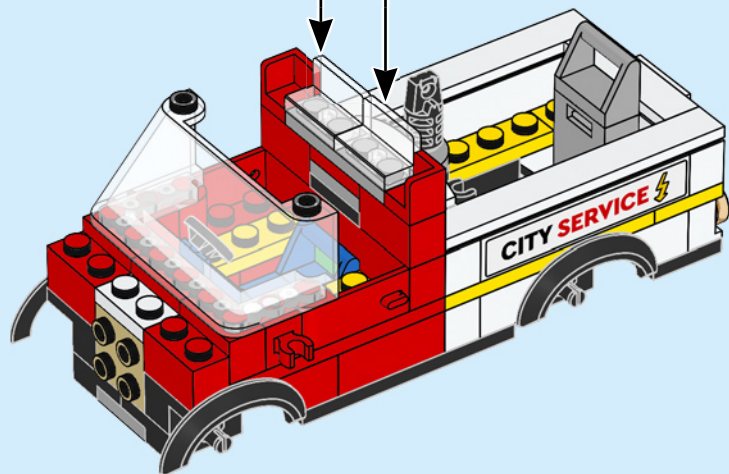

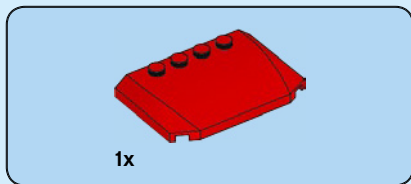

41

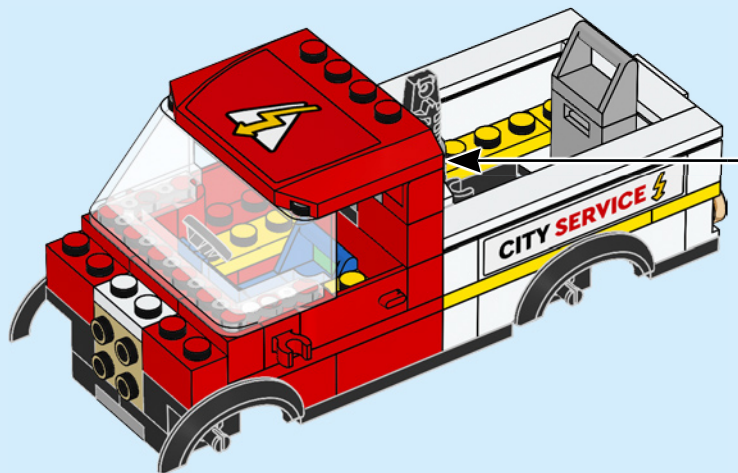
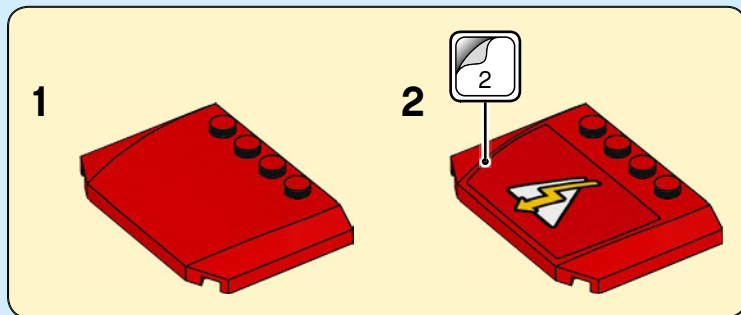



2x



1x



1x

42

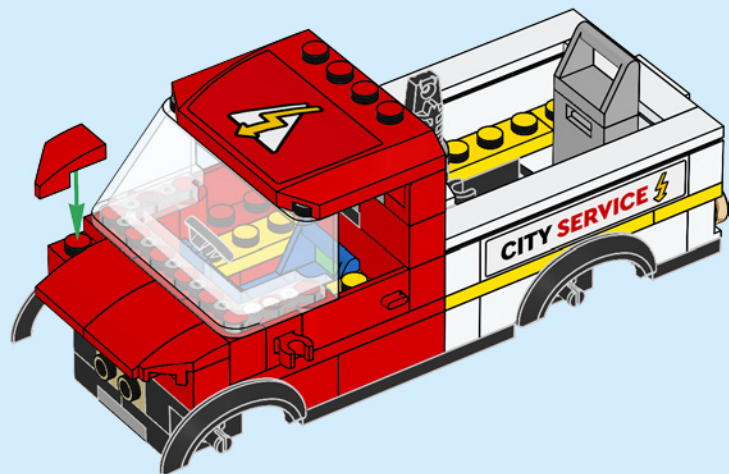

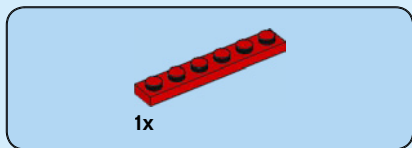

43

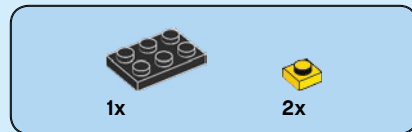
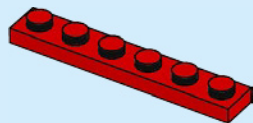

44

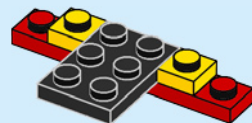



1x

45

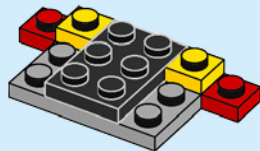

46



1x



2x

46

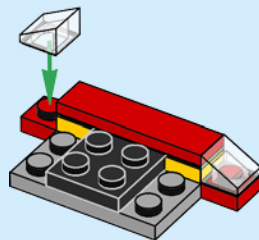



2x

47

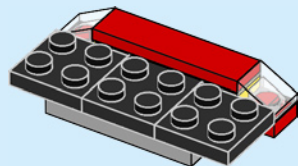

2x



2x

48

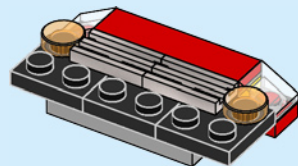



1x

49

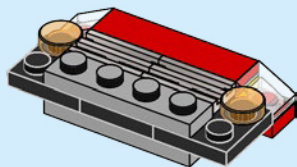

48



1x

50

1



2

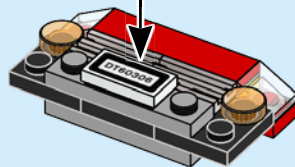



51

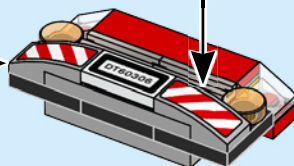
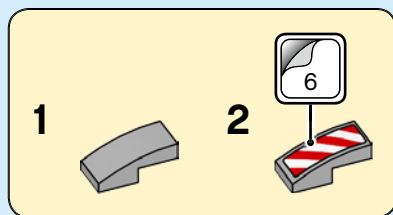
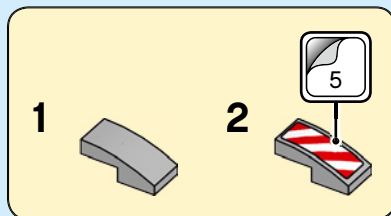

52

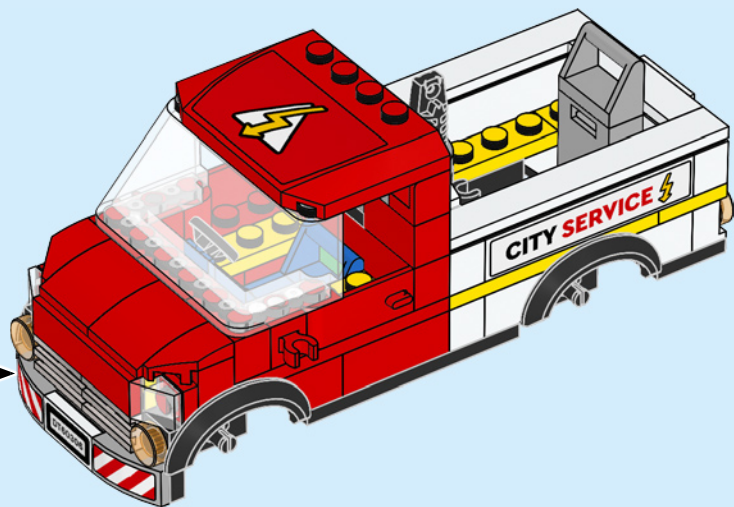



2x

53

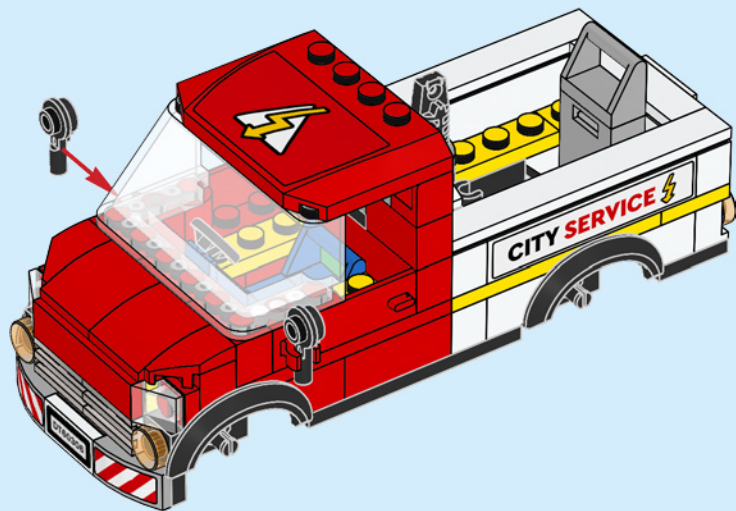

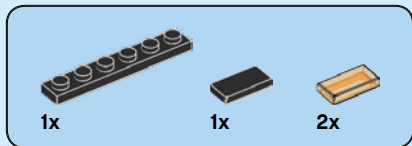

54

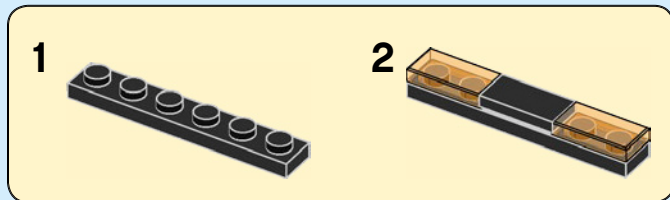



55

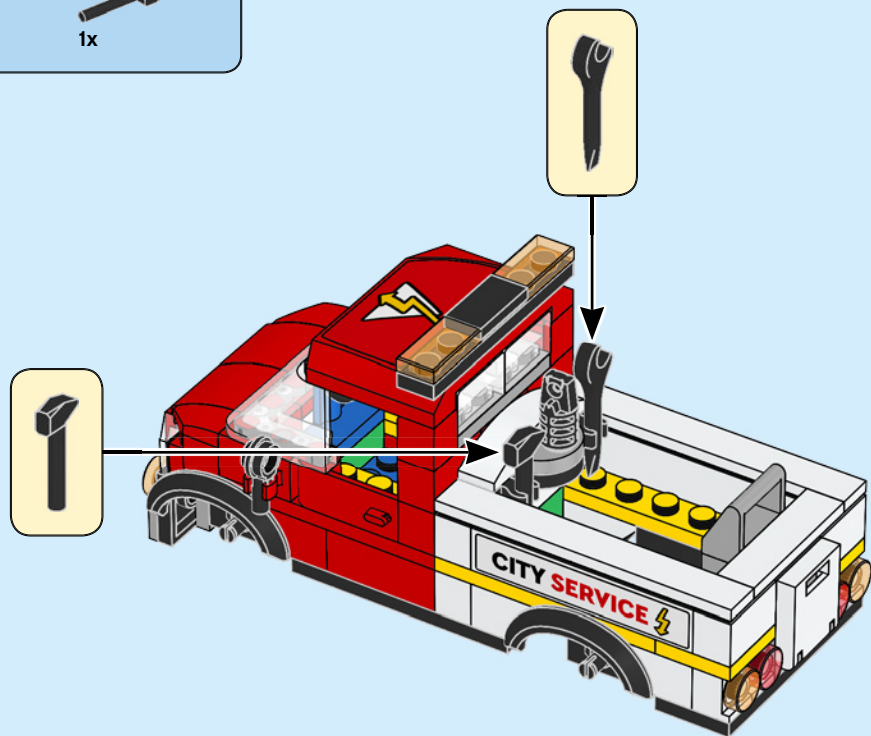

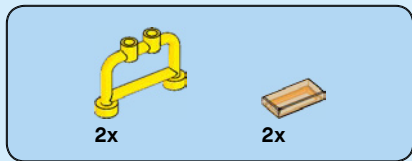

56

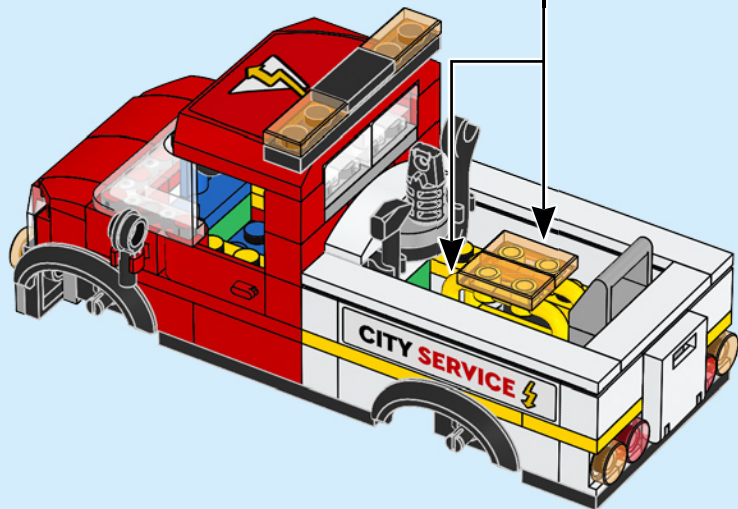
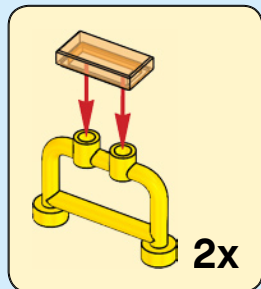



2x

57

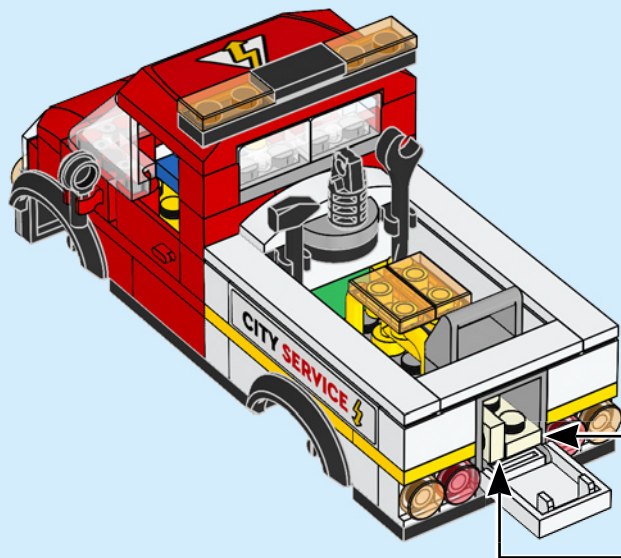

2x

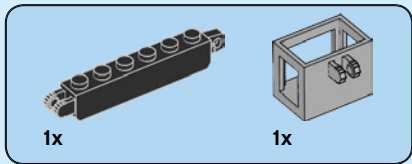
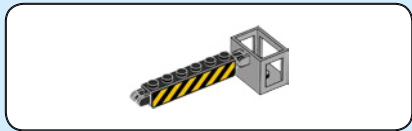

58

1

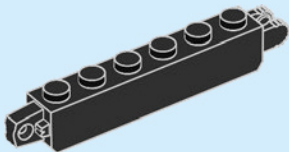

2

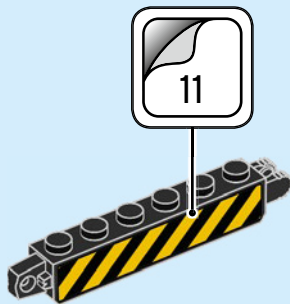

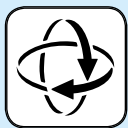

3



4

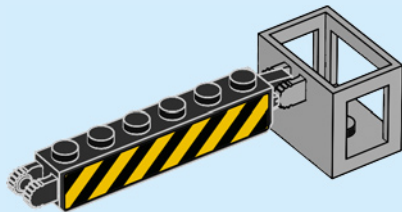

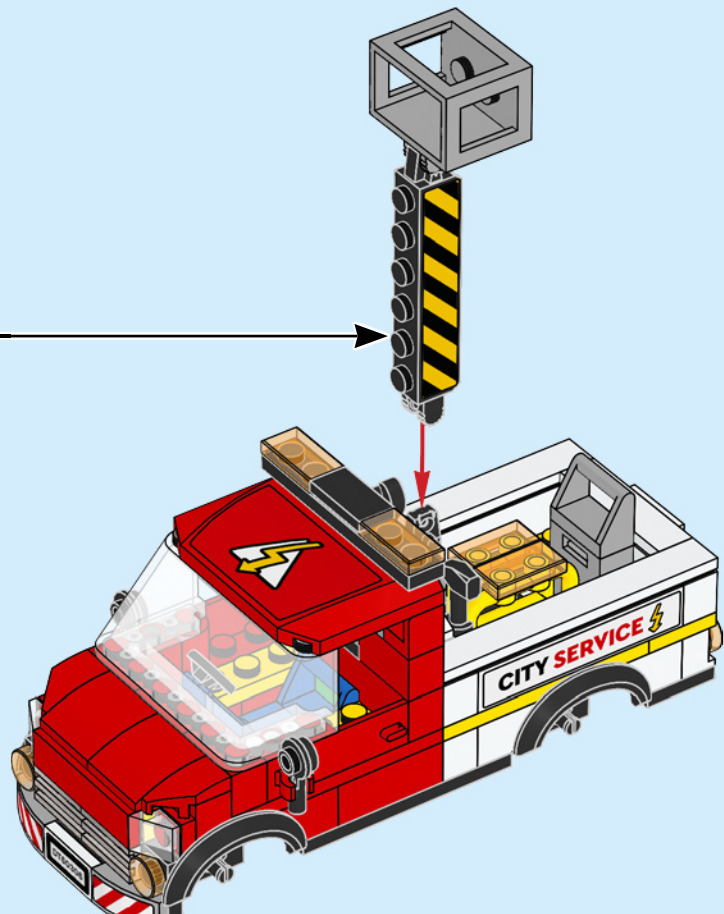



4x



4x

59

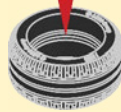
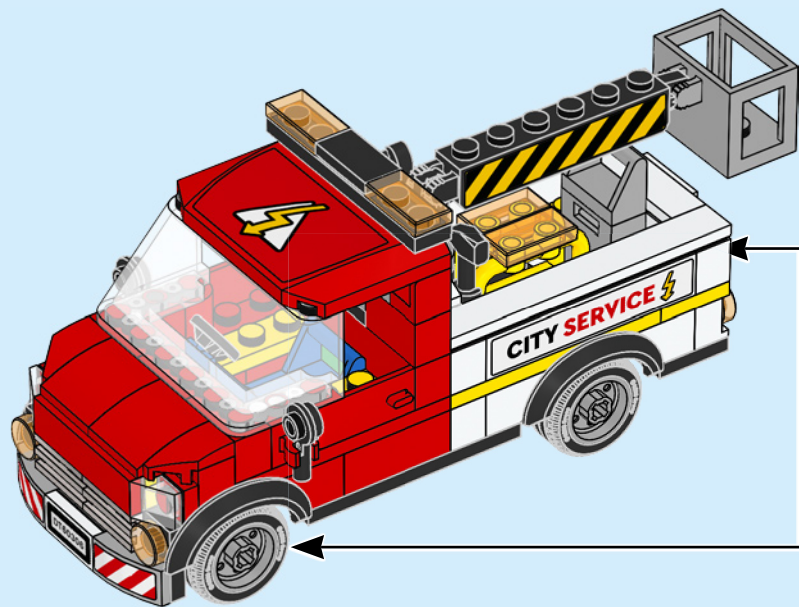

4x



CITY

CONNECT YOUR CITY

Connect your city
Verbinde deine Stadt
Connecte ta ville
Unisci la tua città
Conecta tu ciudad
Une a tua cidade
Bövitsd a város
Savieno savas
pilsētas daļas
连接你的城市



60292



60291



60290



60304