



# NINJAGO

30593



6394234



1

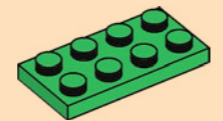

2

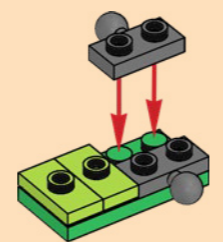

3

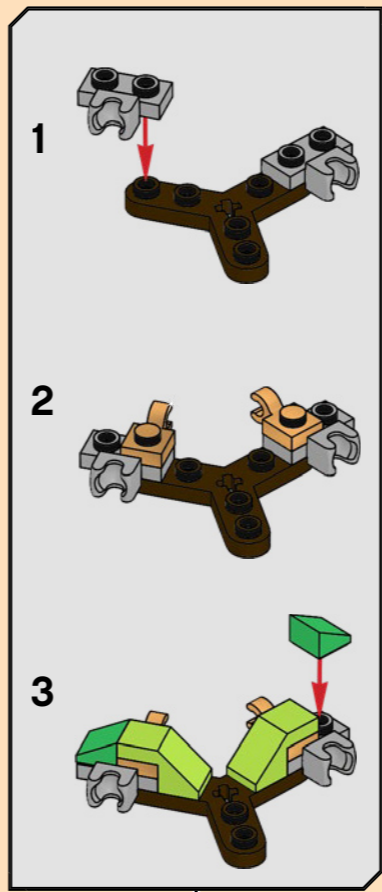
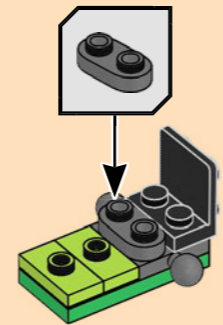

4

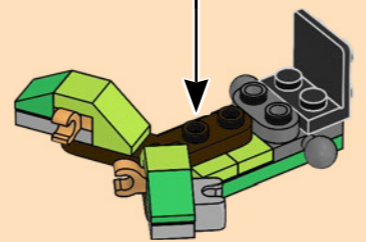

5

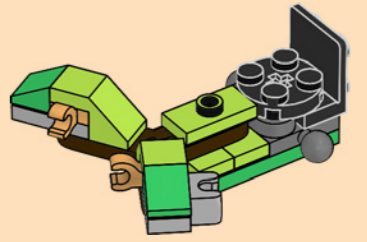

6

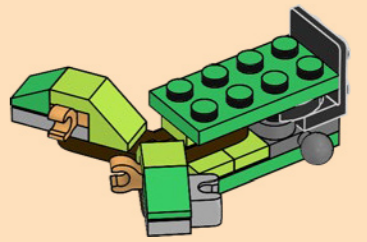

7

