



Taj Mahal:

AGRA, INDIA

LEGO

Architecture

Booklet available in English on
Heft in deutscher Sprache erhältlich auf
Livret disponible en français sur
Libretto disponibile in Italiano su
Folleto disponible en español en
如需中文版手册, 请访问

LEGO.com/service/buildinginstructions



Taj Mahal – The History

Located on the southern bank of the river Yamuna in the Indian city of Agra, the Taj Mahal is one of the great monuments of the world and a symbol of eternal love. The iconic ivory-white marble mausoleum is finally recreated here in LEGO® Architecture scale.

The Taj Mahal was commissioned in 1632 by the grief-stricken Mughal emperor Shah Jahan (1592–1666) to house the tomb of his beloved third wife, Mumtaz Mahal (1593–1631). Over 20,000 laborers and 1,000 elephants were involved in the ambitious construction, which took 22 years to complete at an estimated cost of 32 million Indian rupees (the equivalent of over US \$1 billion at the time).

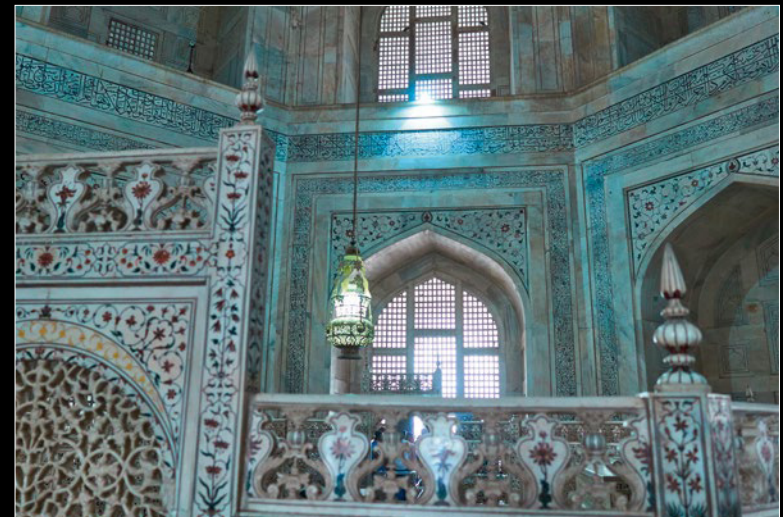

Chamber of Mughal emperor Shah Jahan and Mumtaz Mahal



Rok Zgalin Kobe, Senior Designer at the LEGO Group.

The Design Team

As both a trained architect and a LEGO® designer, Rok Zgalin Kobe has always been fascinated by the Taj Mahal and his goal was to recreate the details of this intricate monument. "The story of the Taj Mahal is hopefully mirrored here in LEGO bricks: you lift the roof with the onion dome and chatris, the four domed, columned kiosks, to expose the vaulted ceiling of the central chamber. Hidden beneath the removable central chamber is the crypt holding the tombs with the bodies of Mumtaz Mahal and Shah Jahan."

A golden LEGO® ski pole represents the ornament at the apex of the dome of the Taj Mahal.



The four slender minarets are divided into three parts by balconies created from LEGO gear elements.



The decorative spires that extend from the edges of the base walls are created using white LEGO ski poles.







LEGO.com/brickseparator

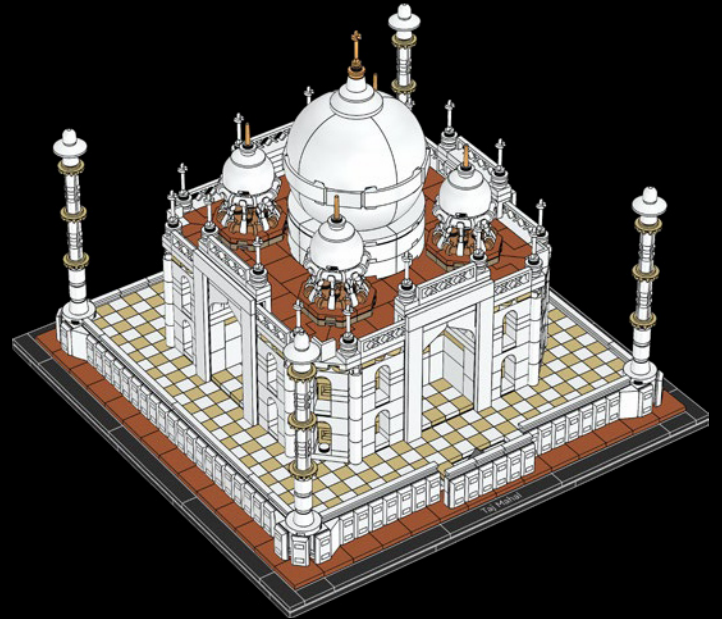
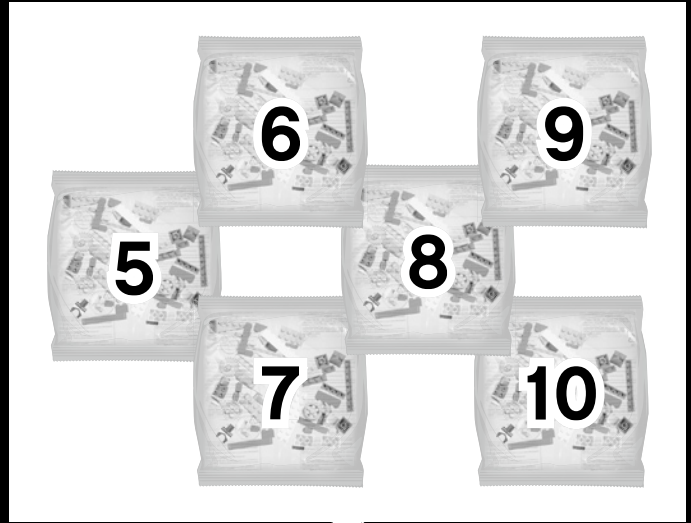
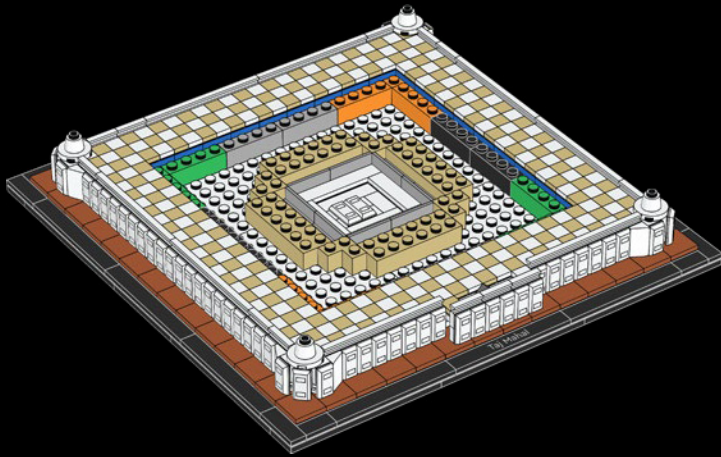

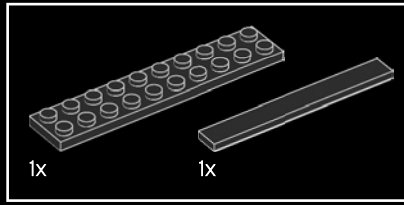
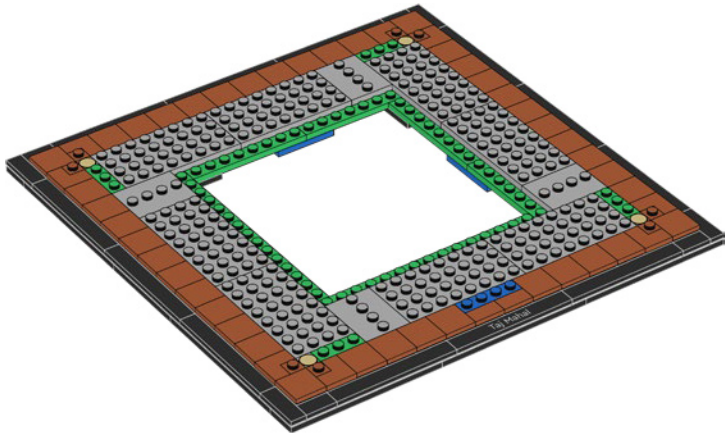
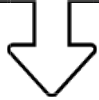

1

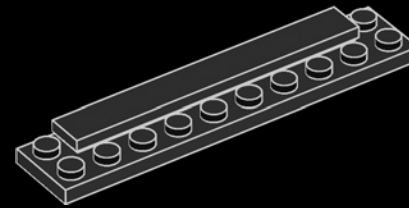

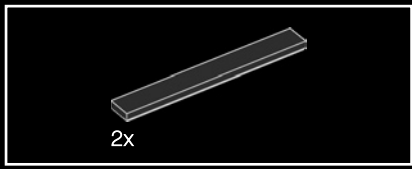

2

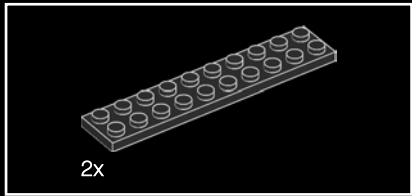
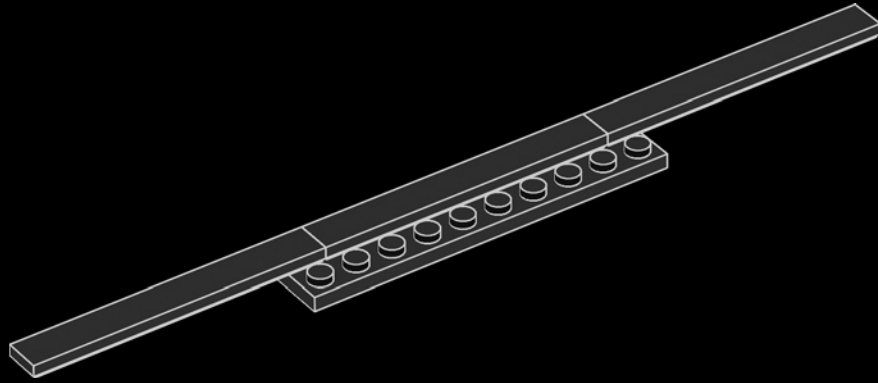

3

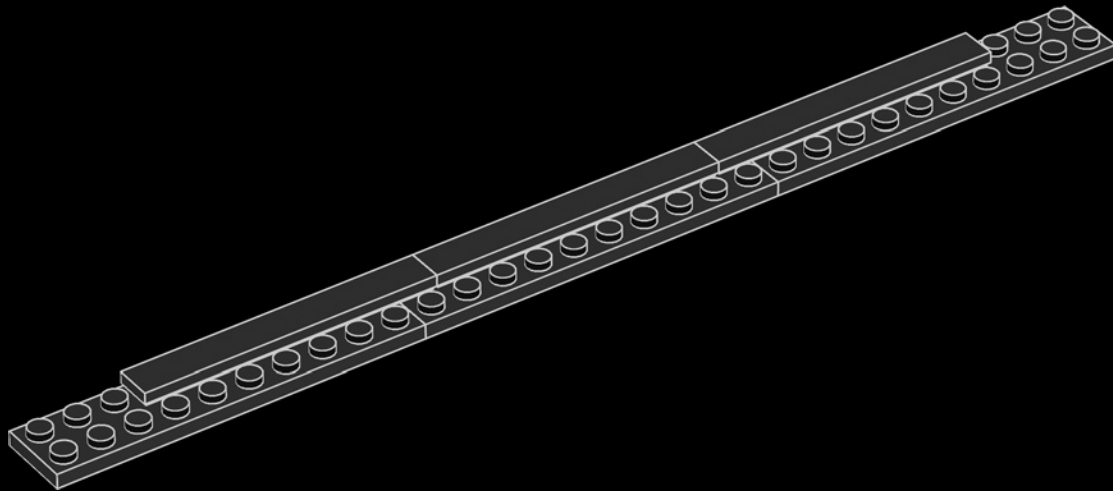

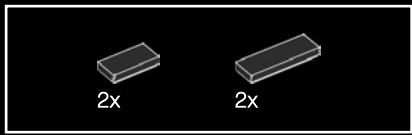

4

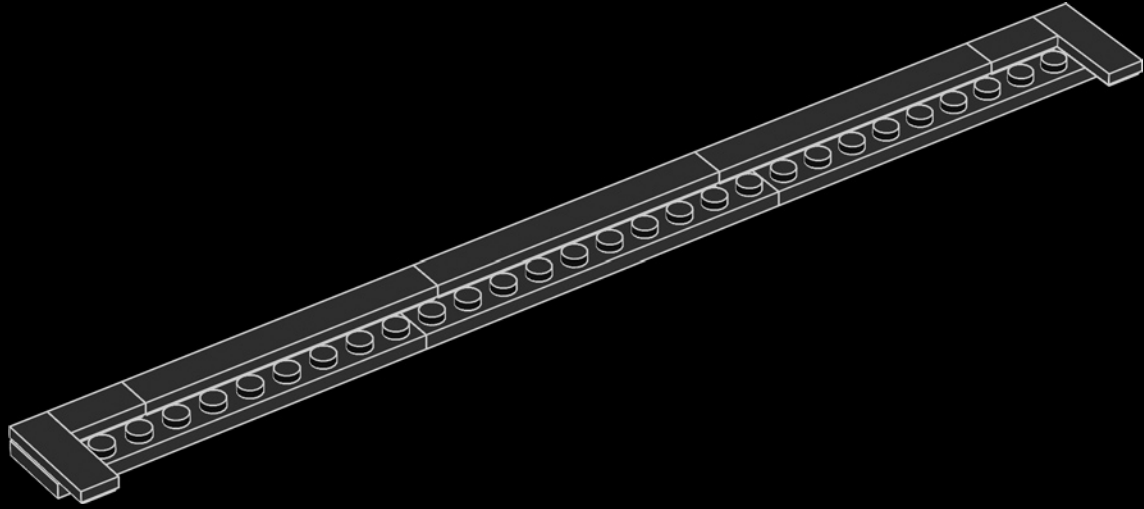

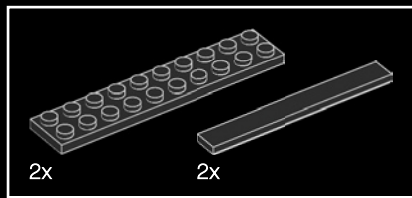

5

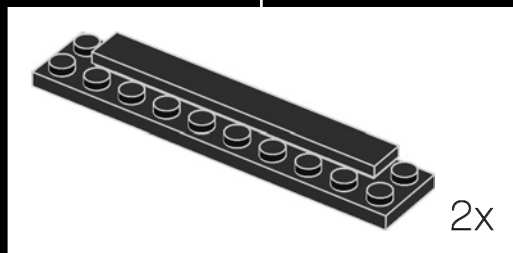
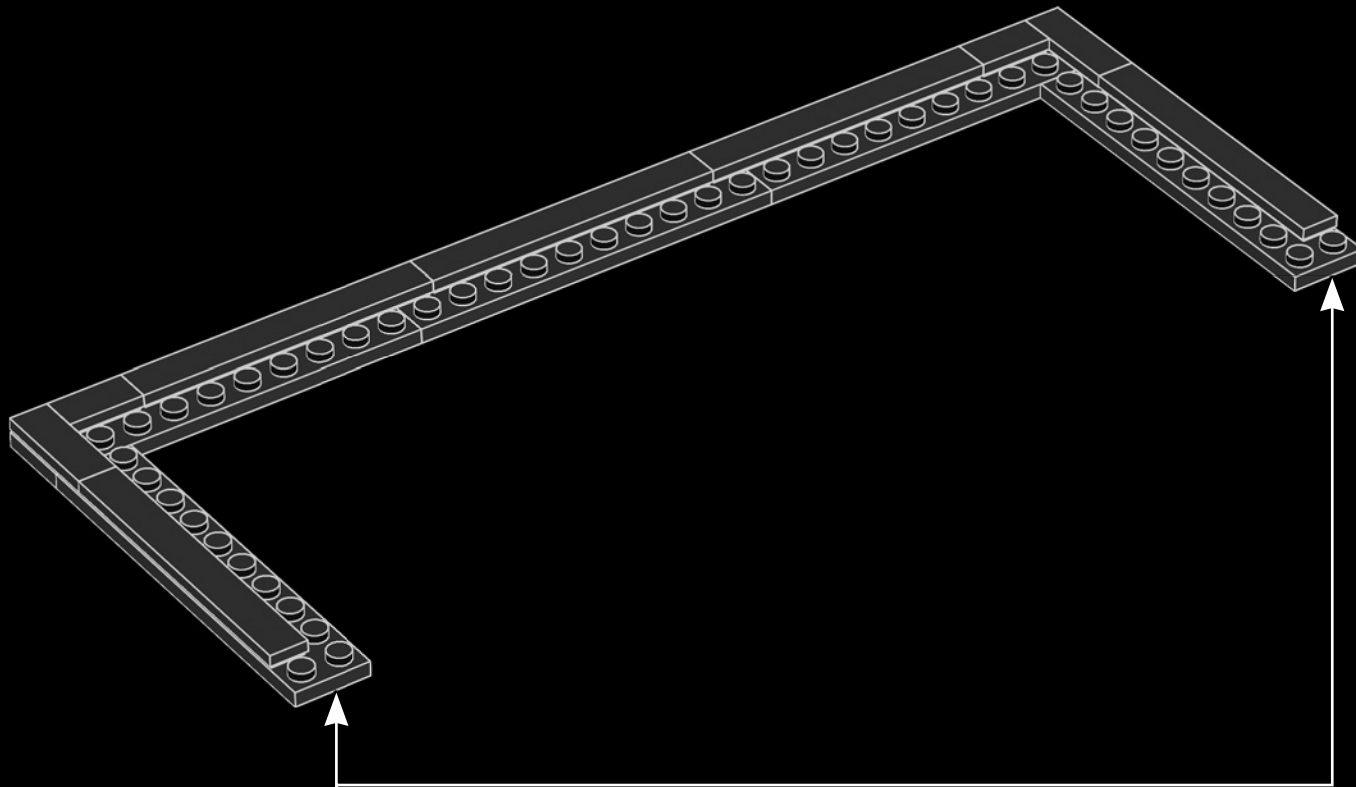

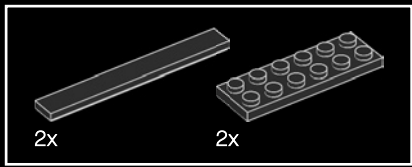

6

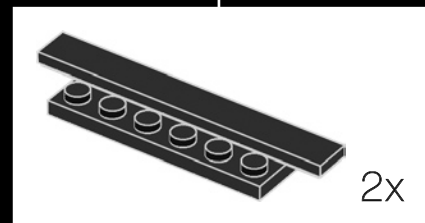
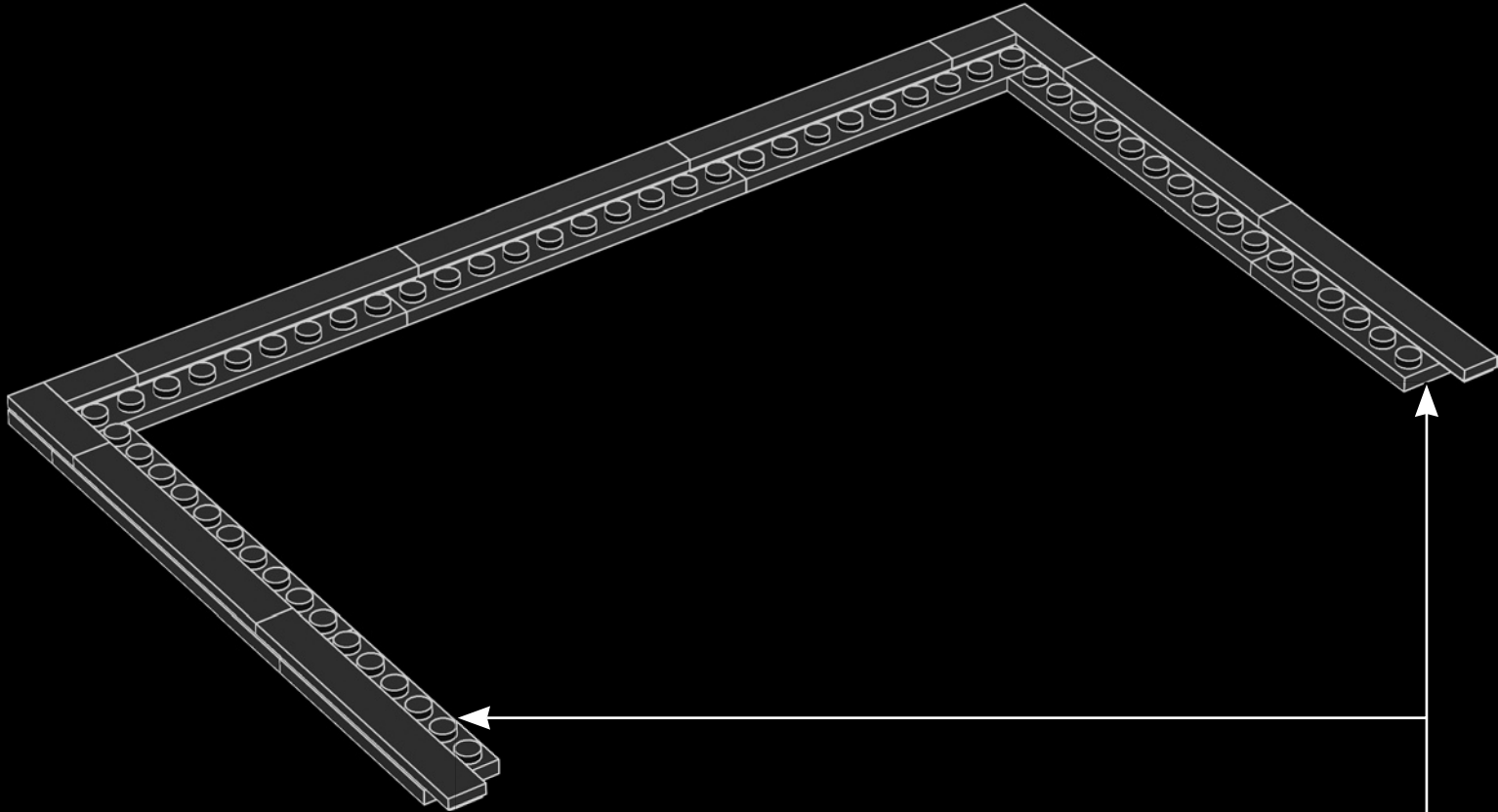

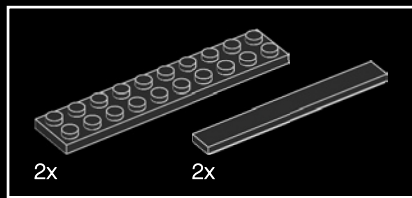

7

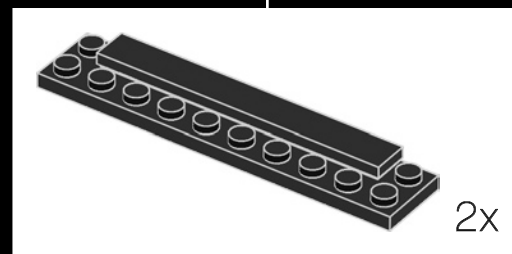
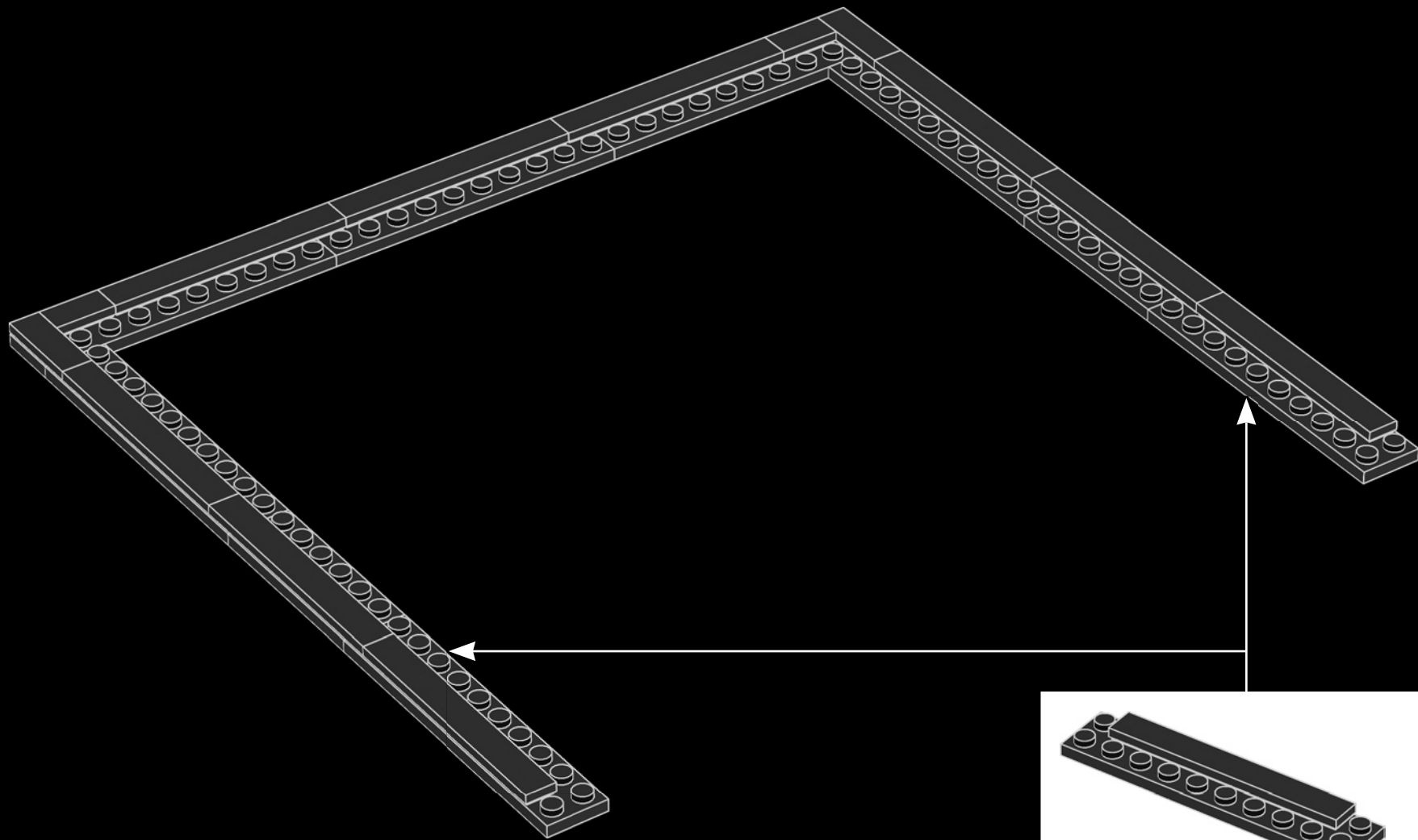

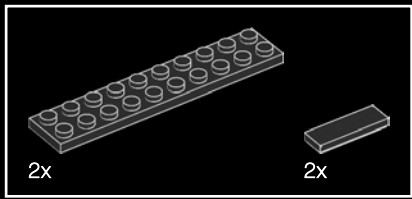

8

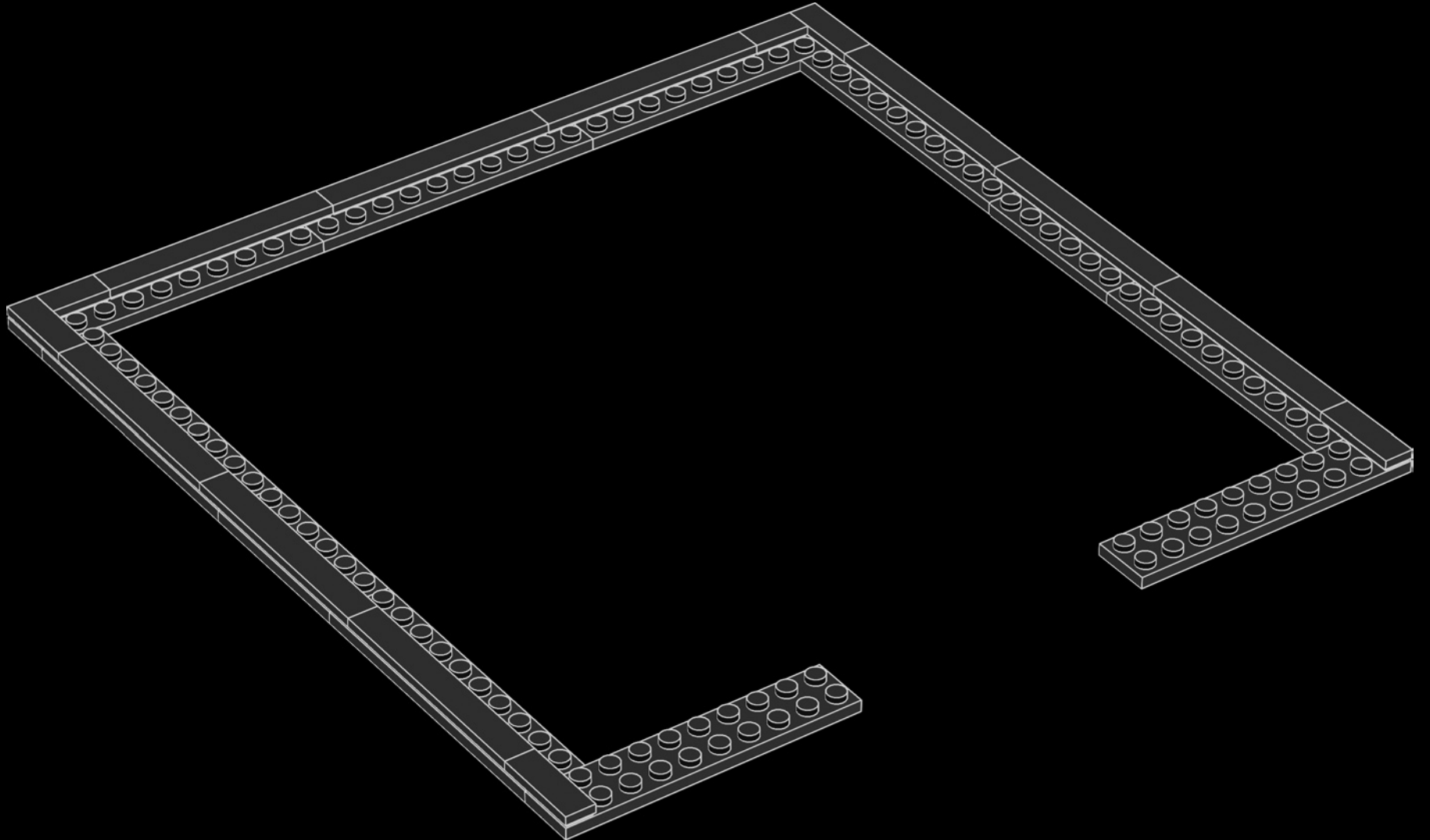

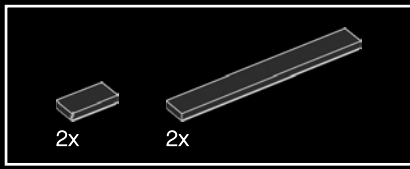

9

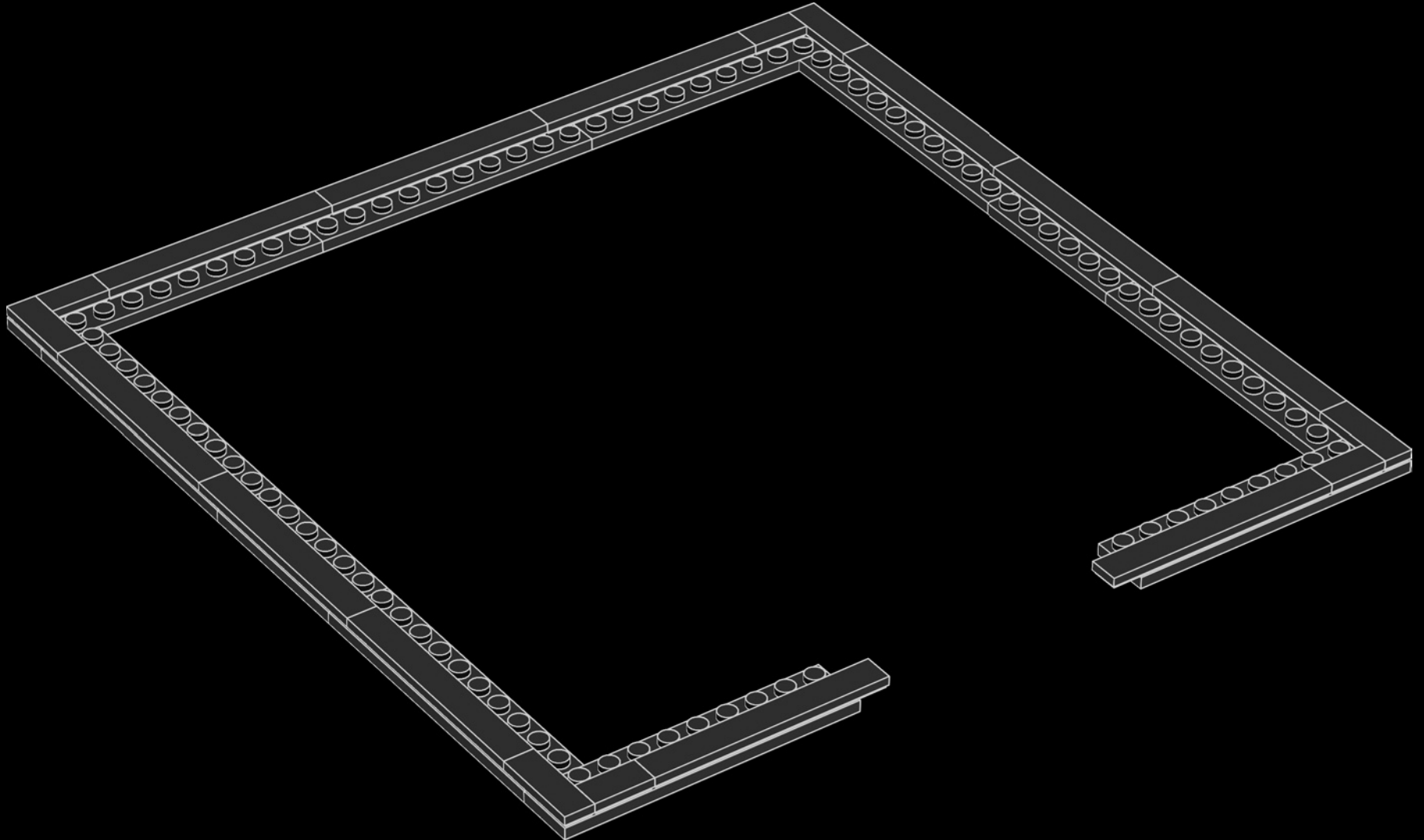

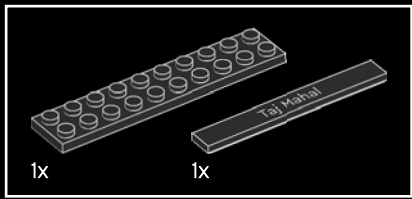

10

During British rule in India, the garden was landscaped to look more like the manicured lawns of England.

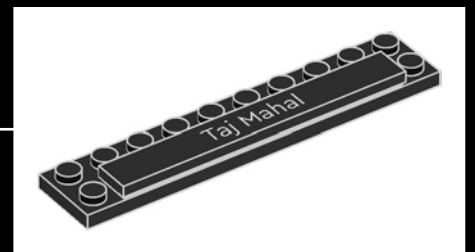
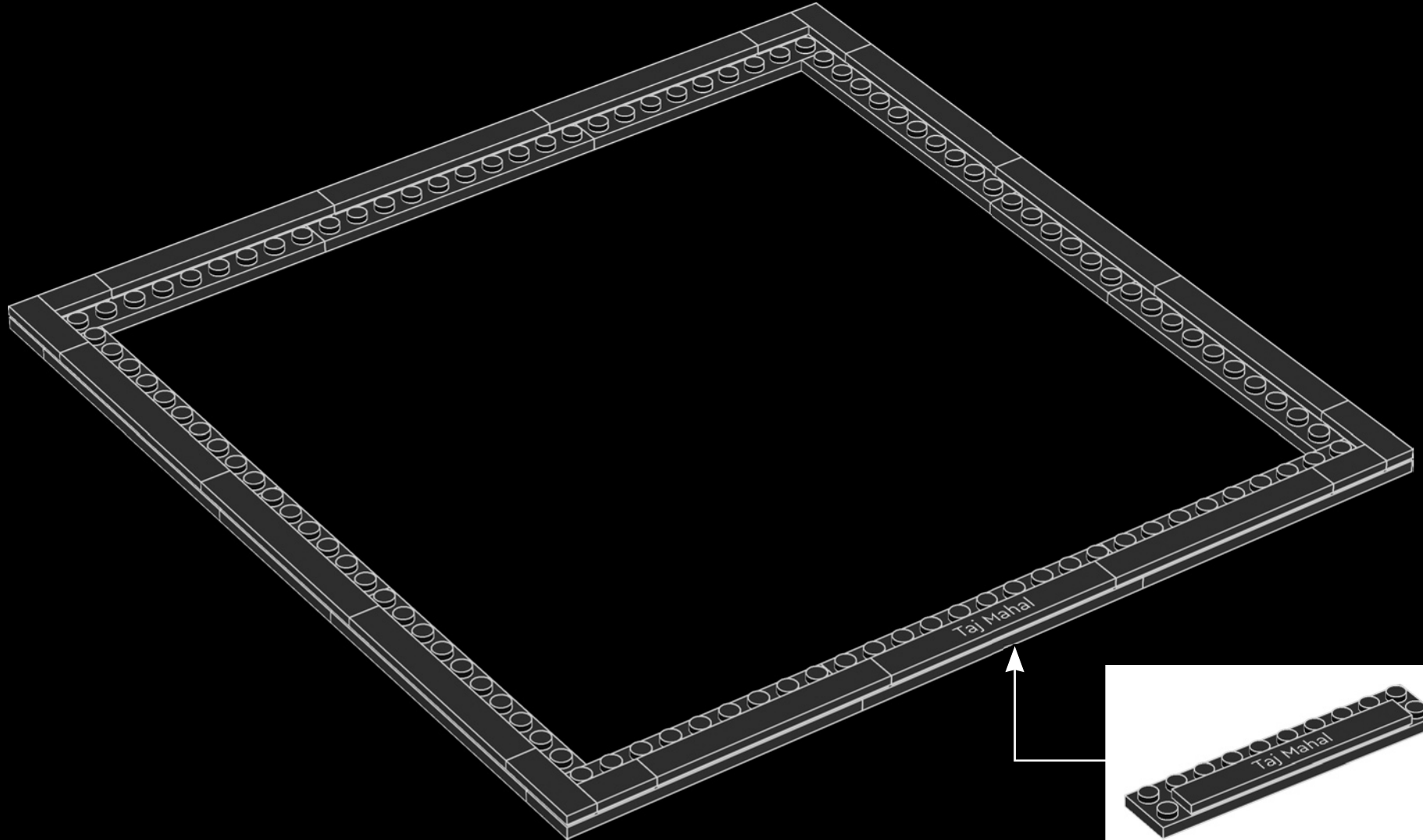

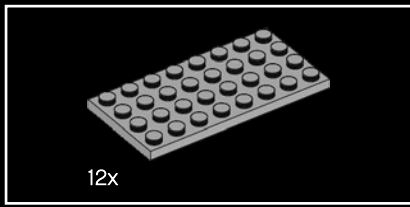

11

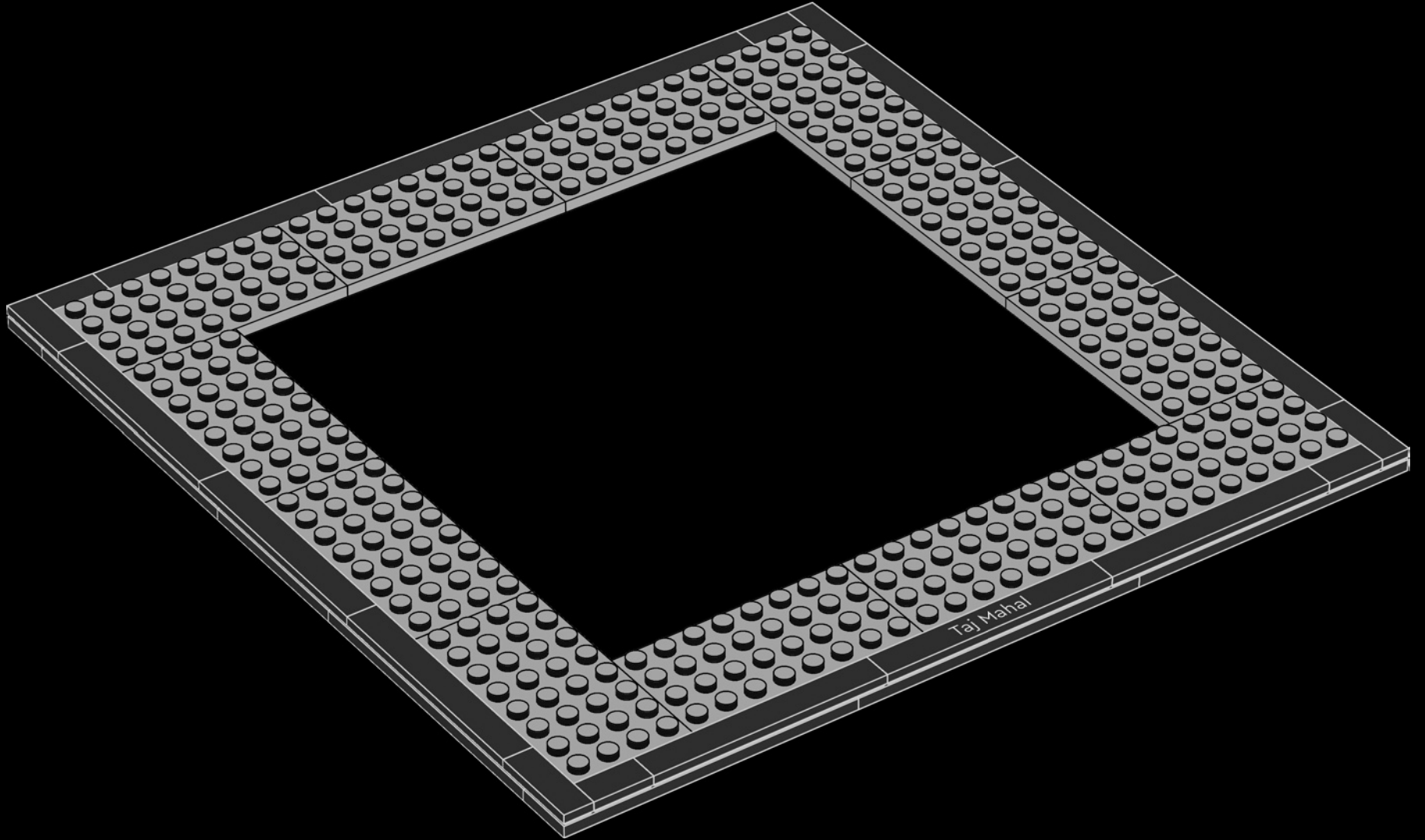

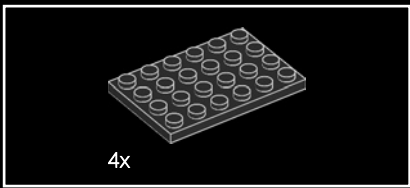

12

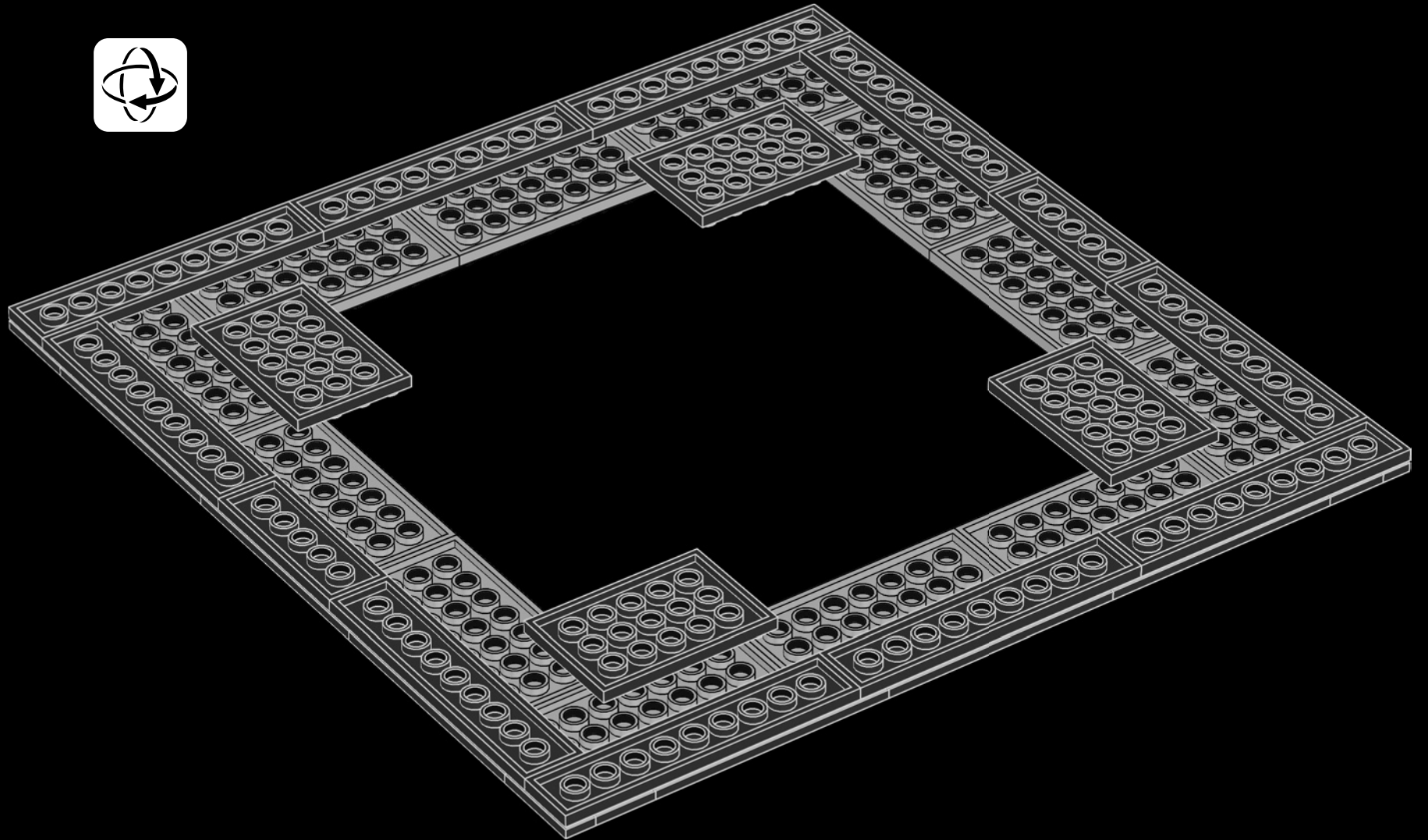

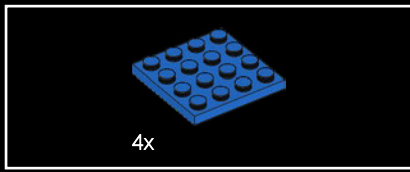

13

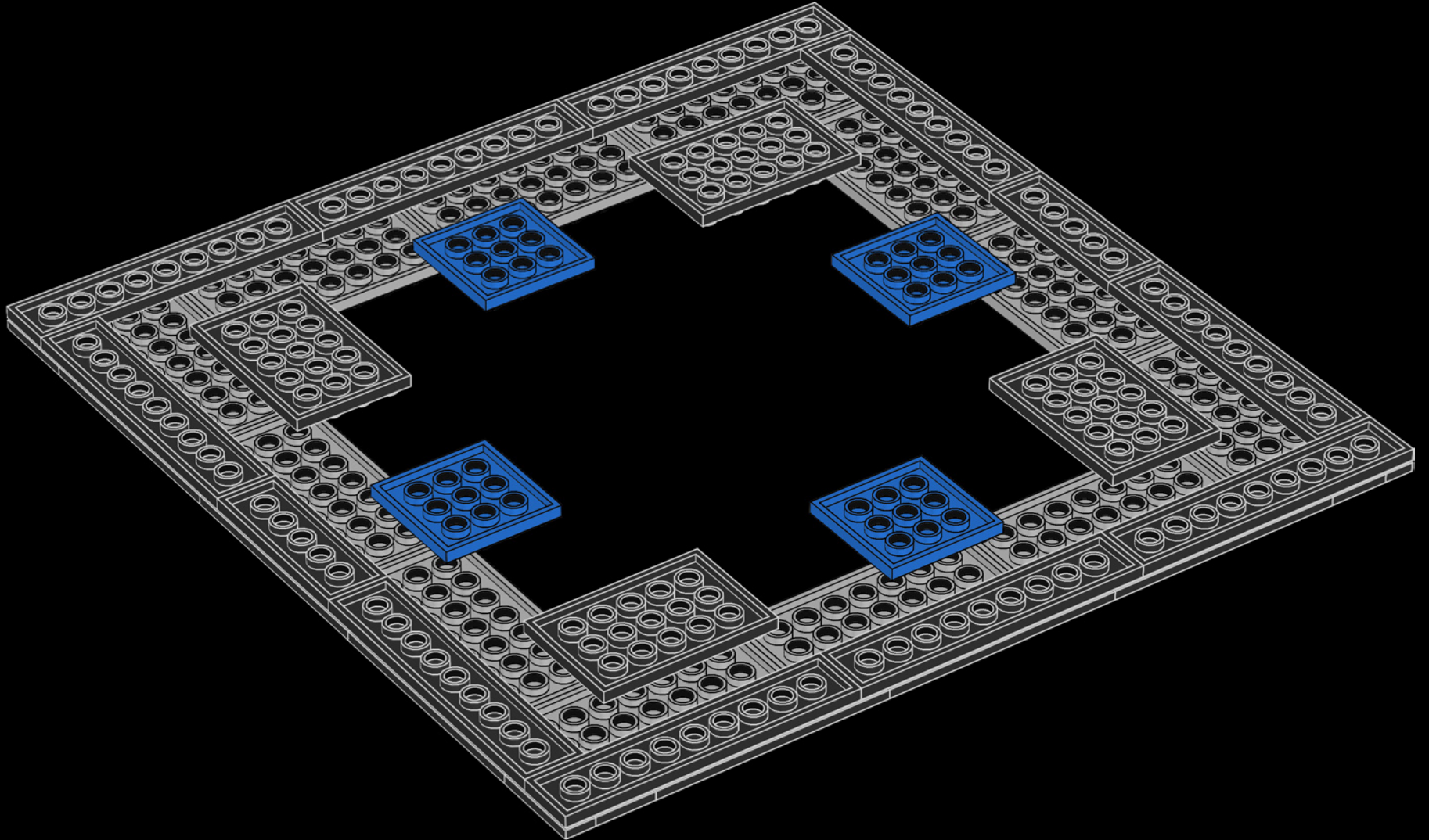

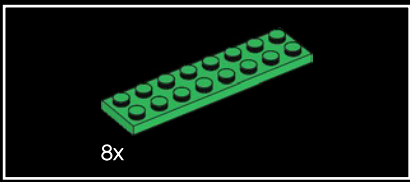

14

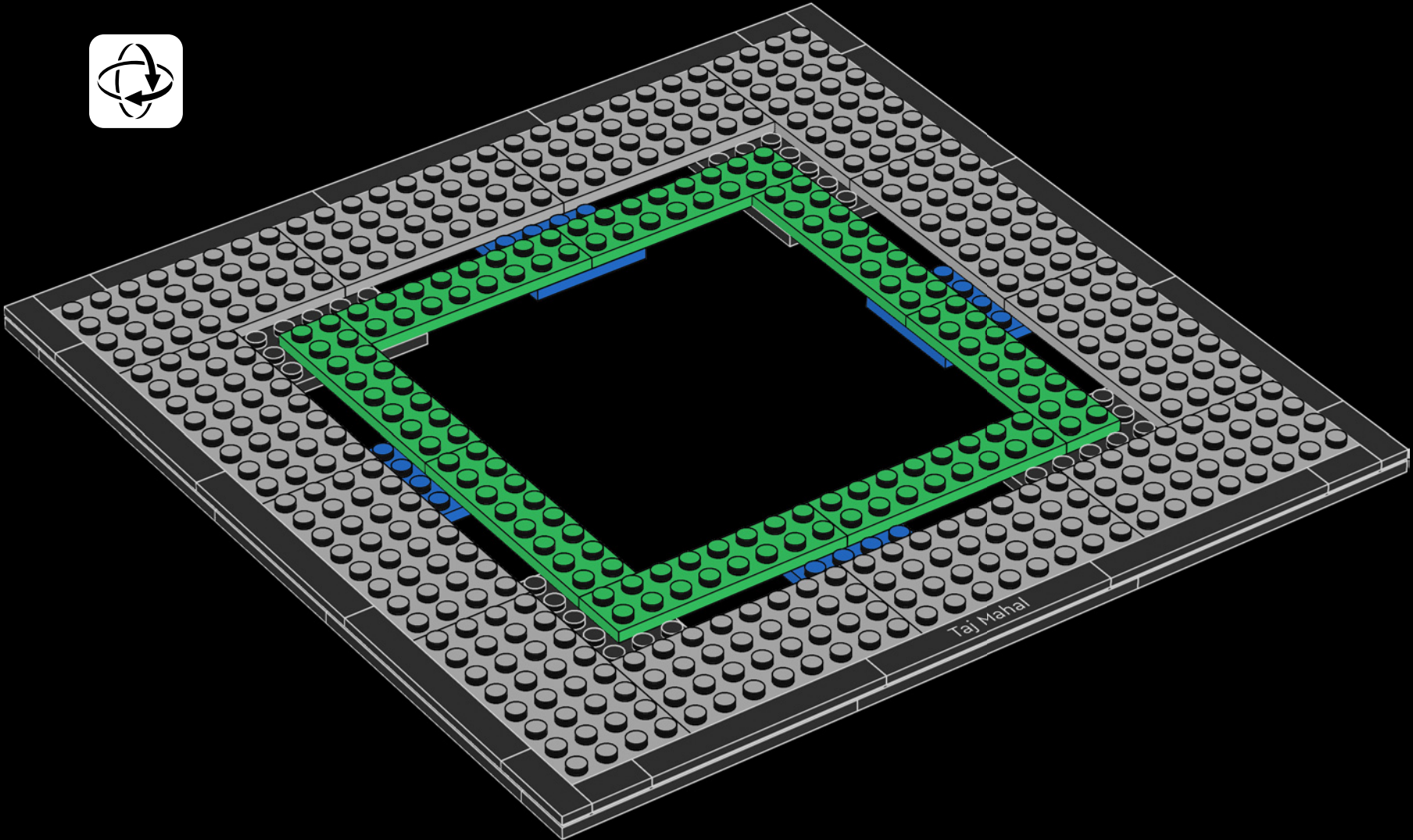

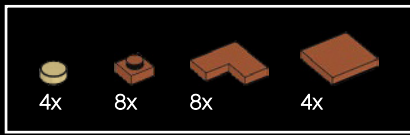

15

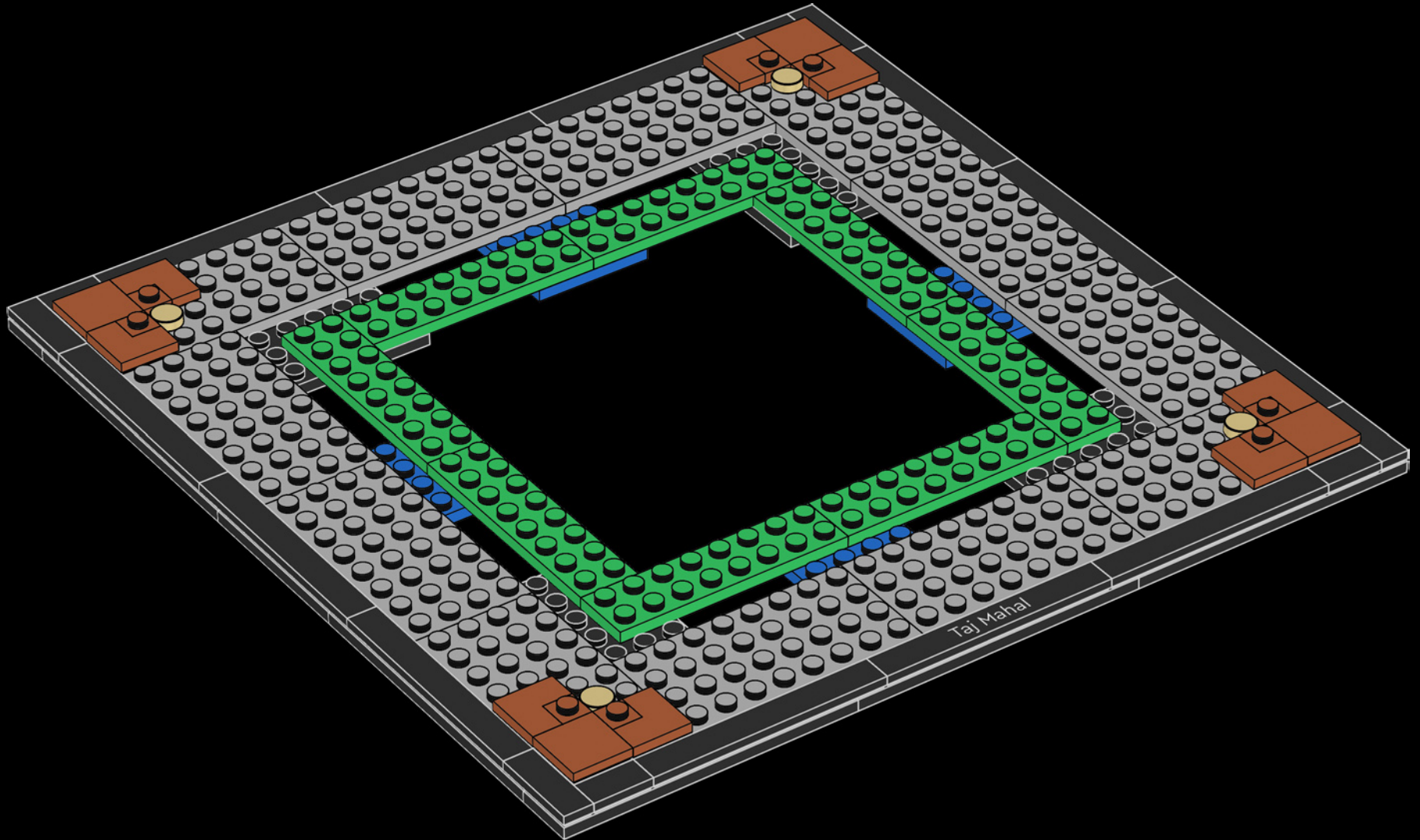



16

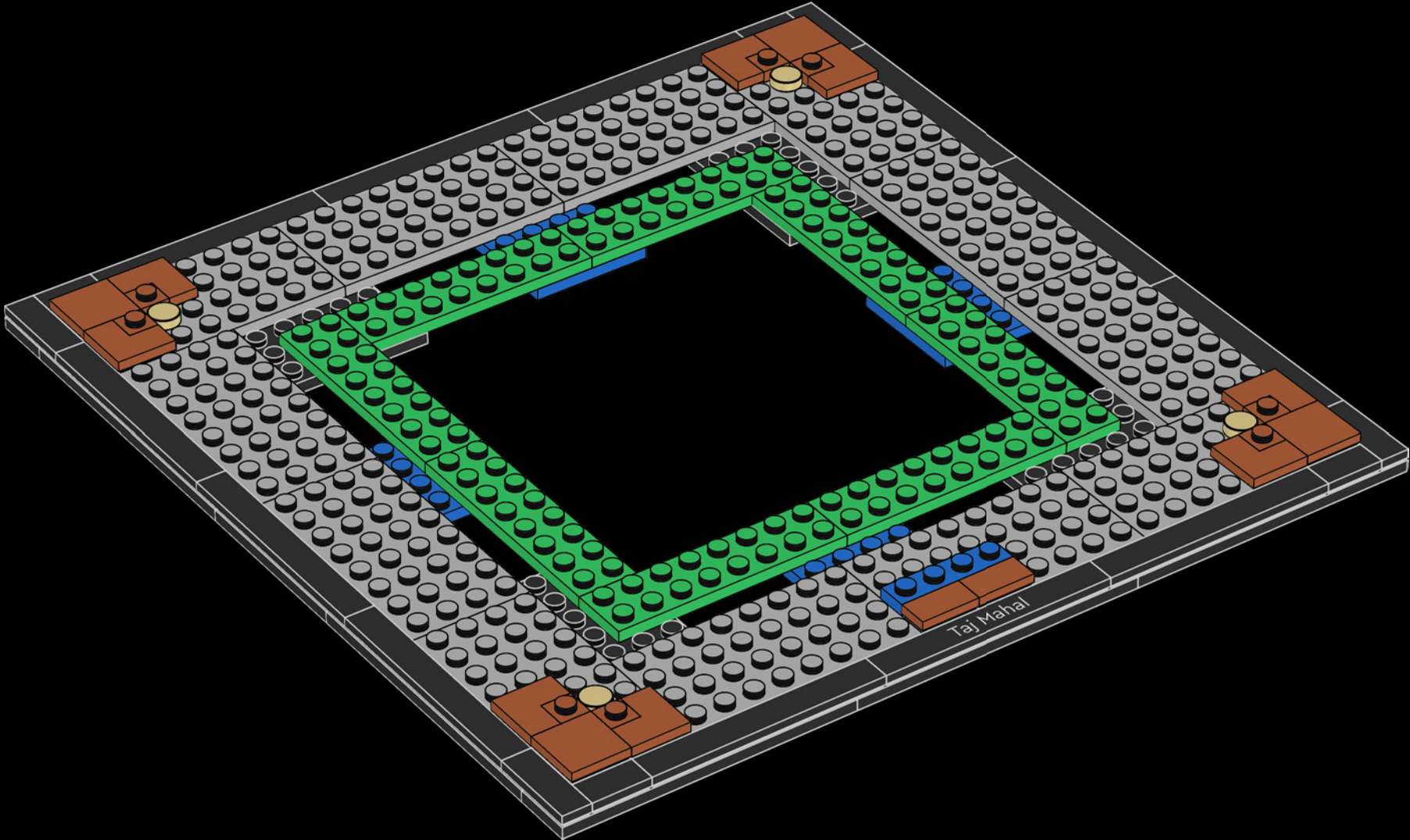



17

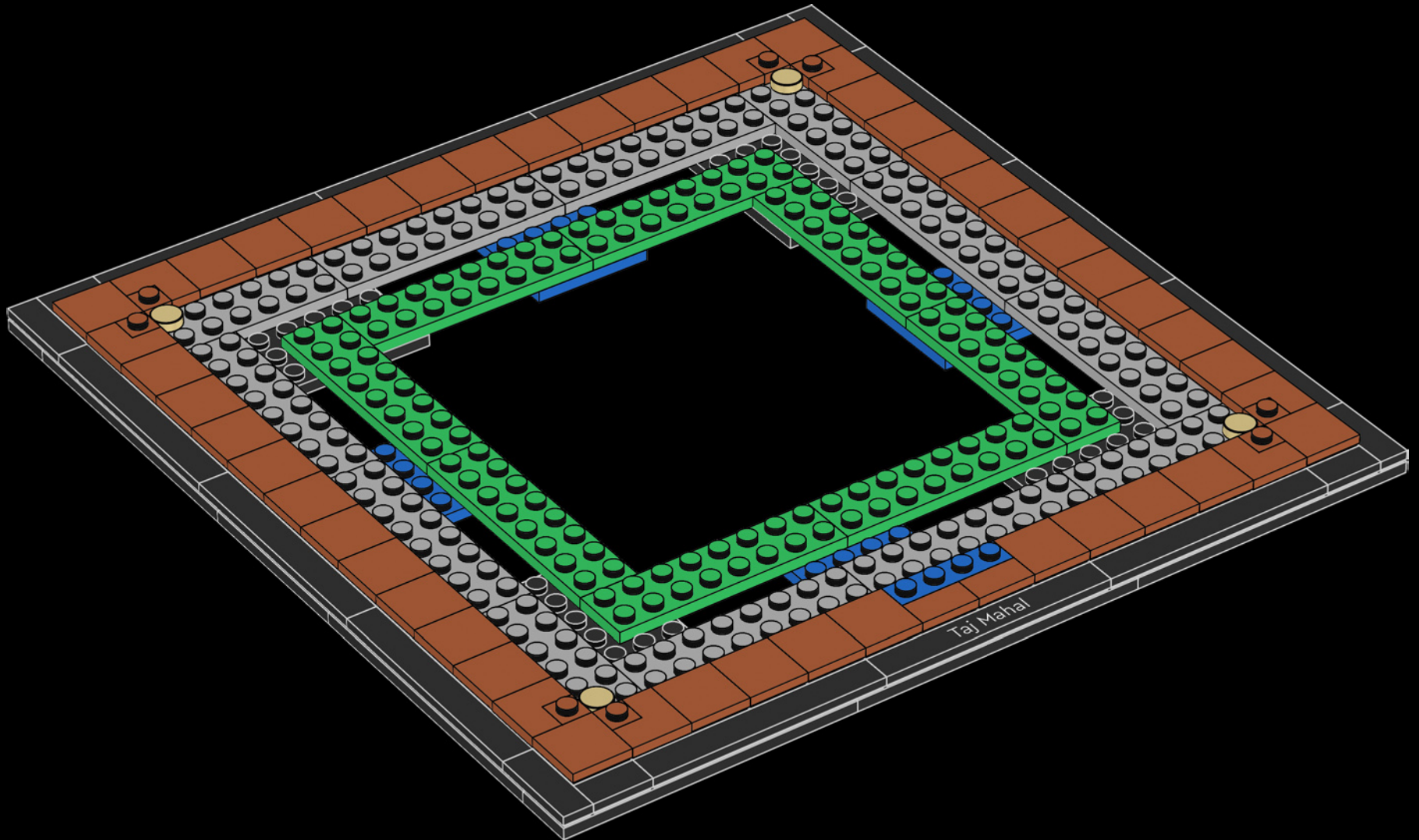

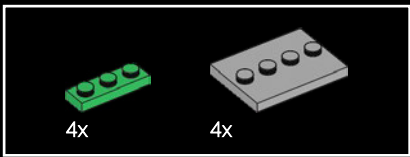

18

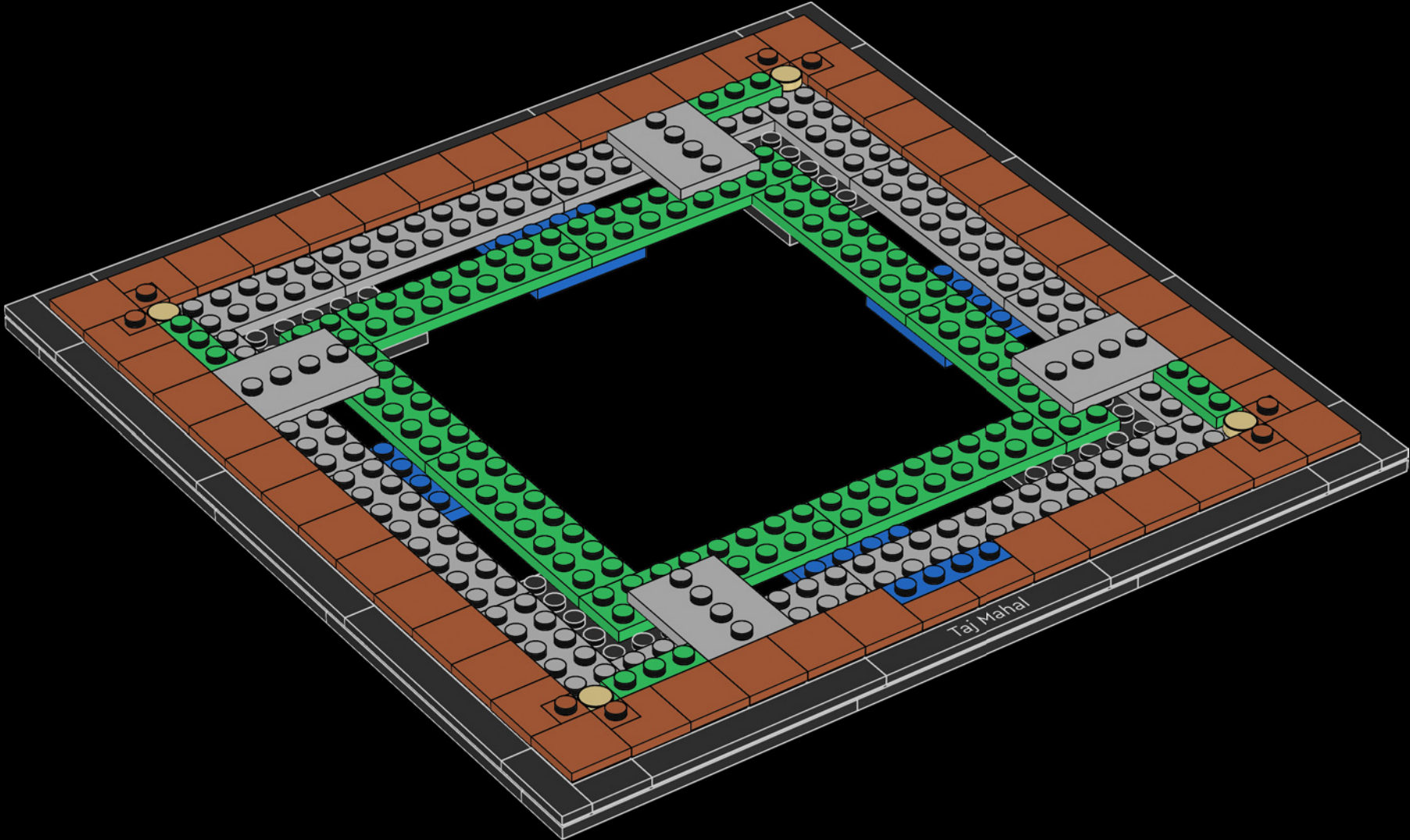

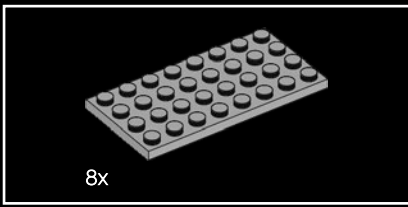

19

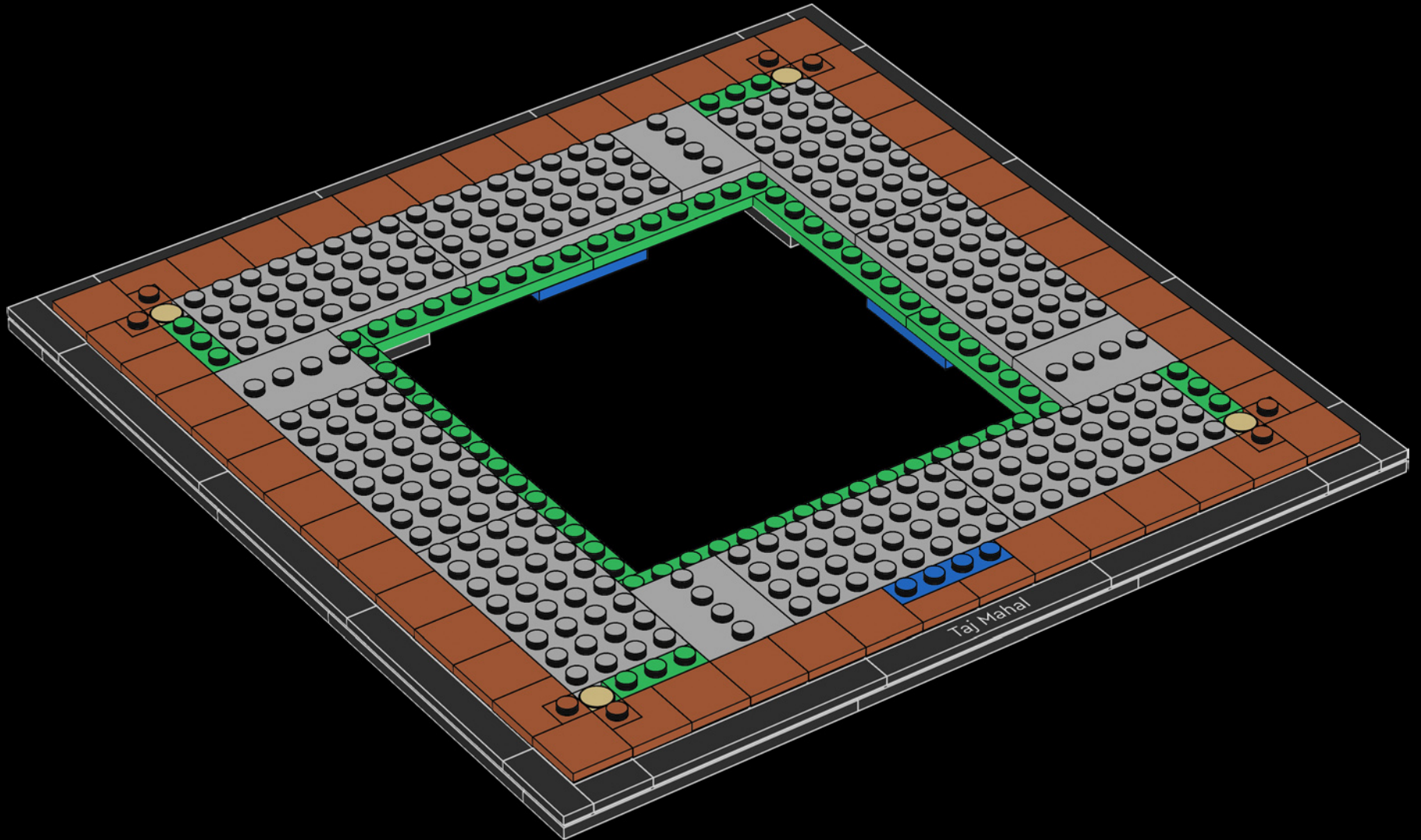

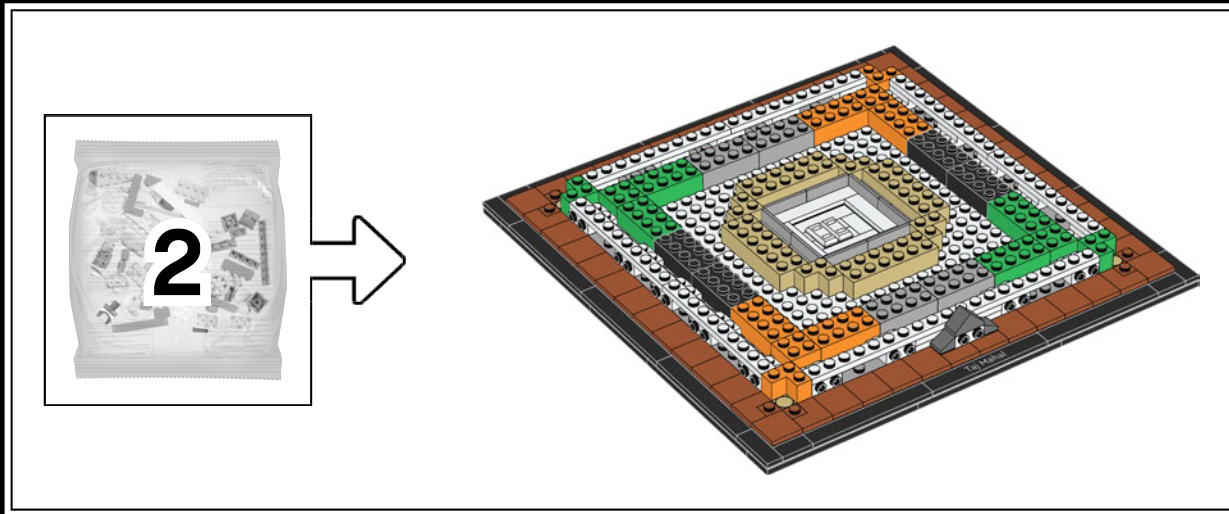

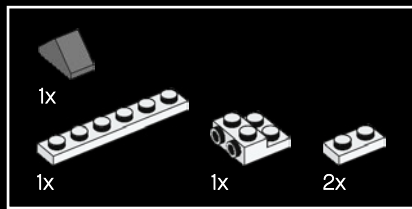

20

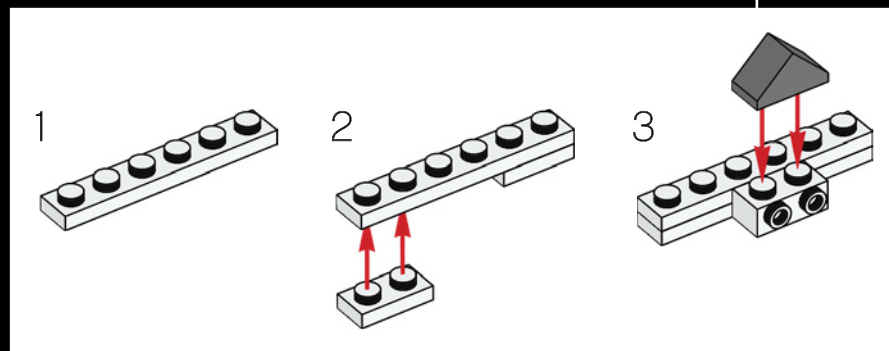
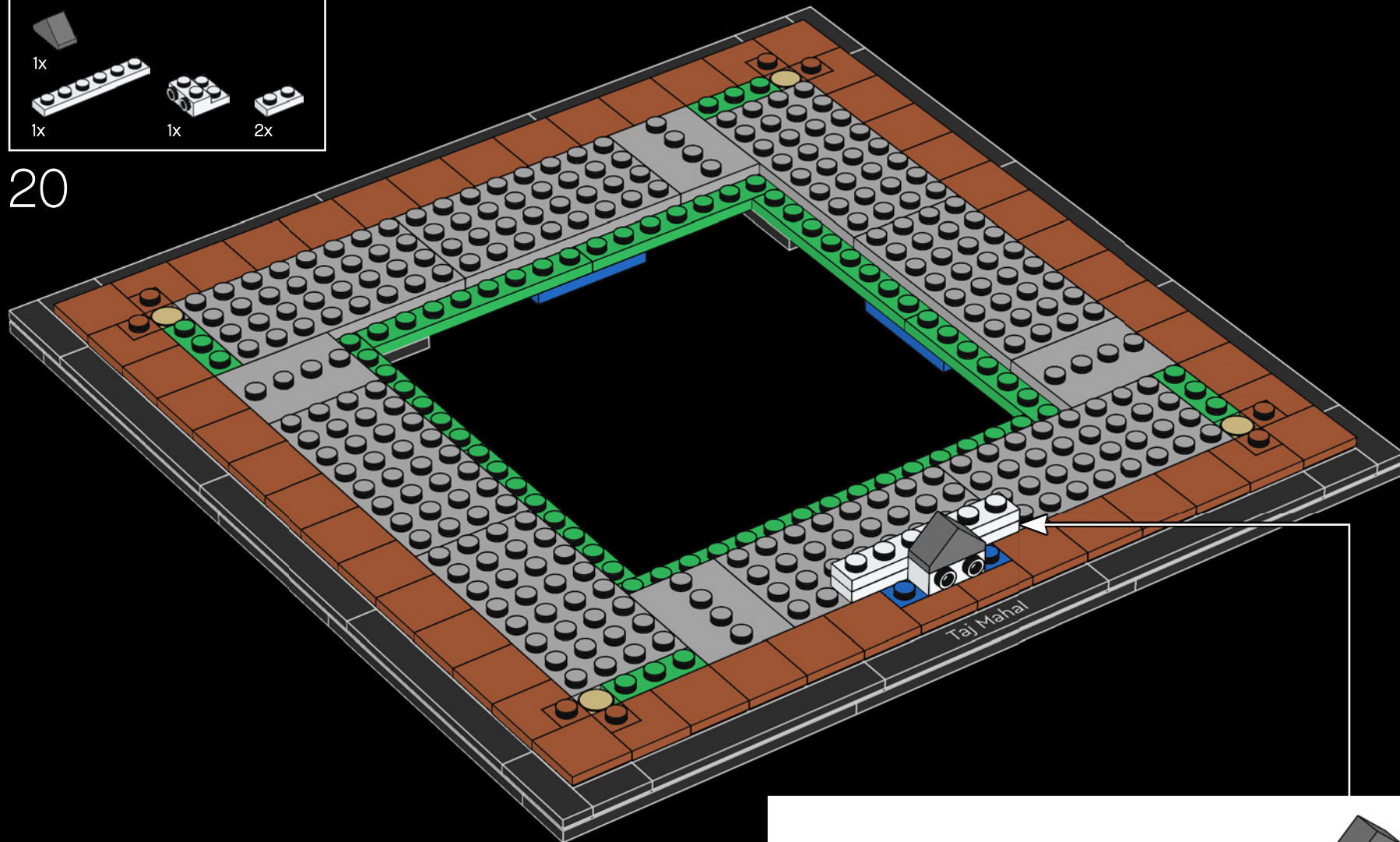

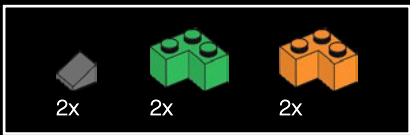

21

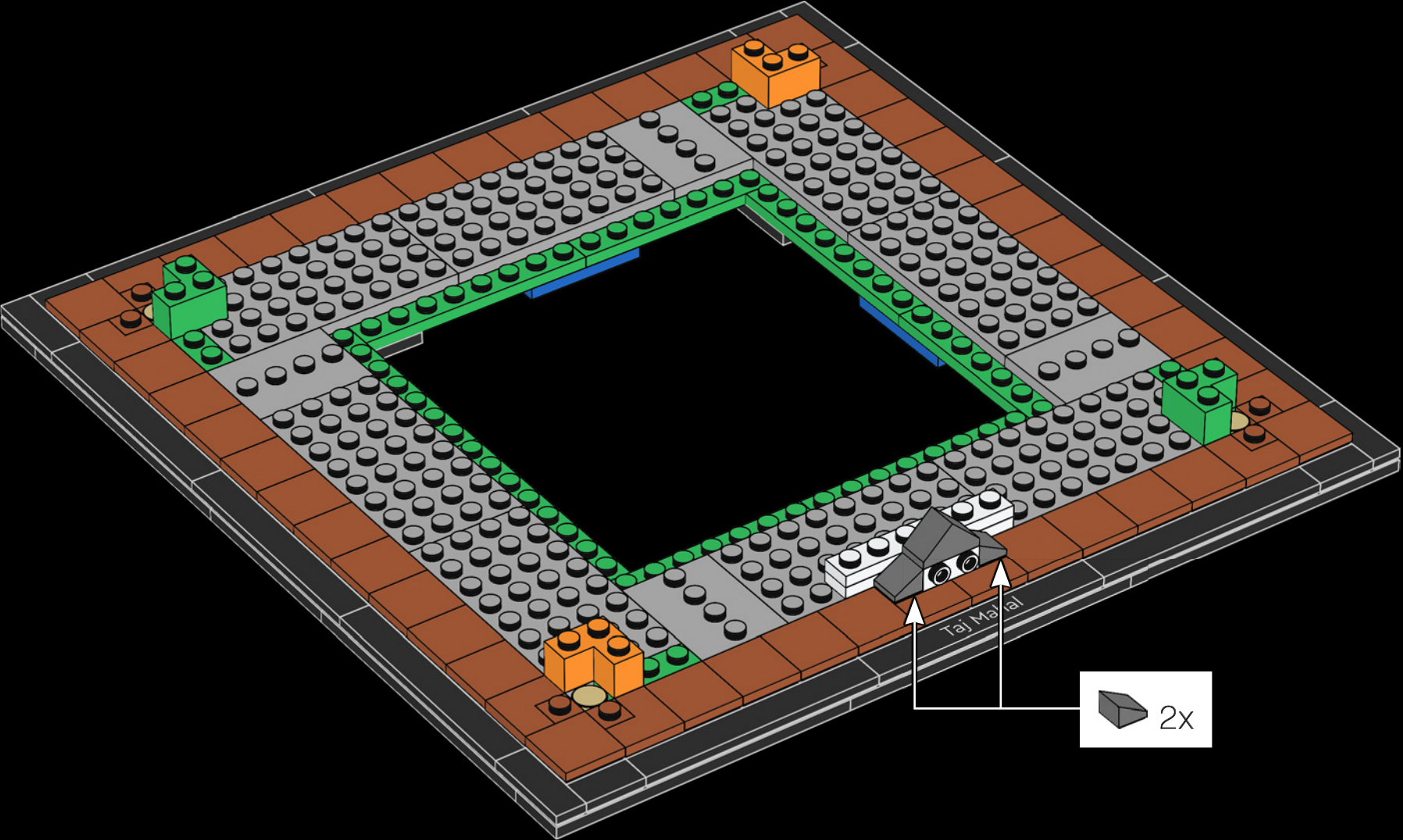

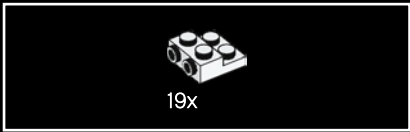

22

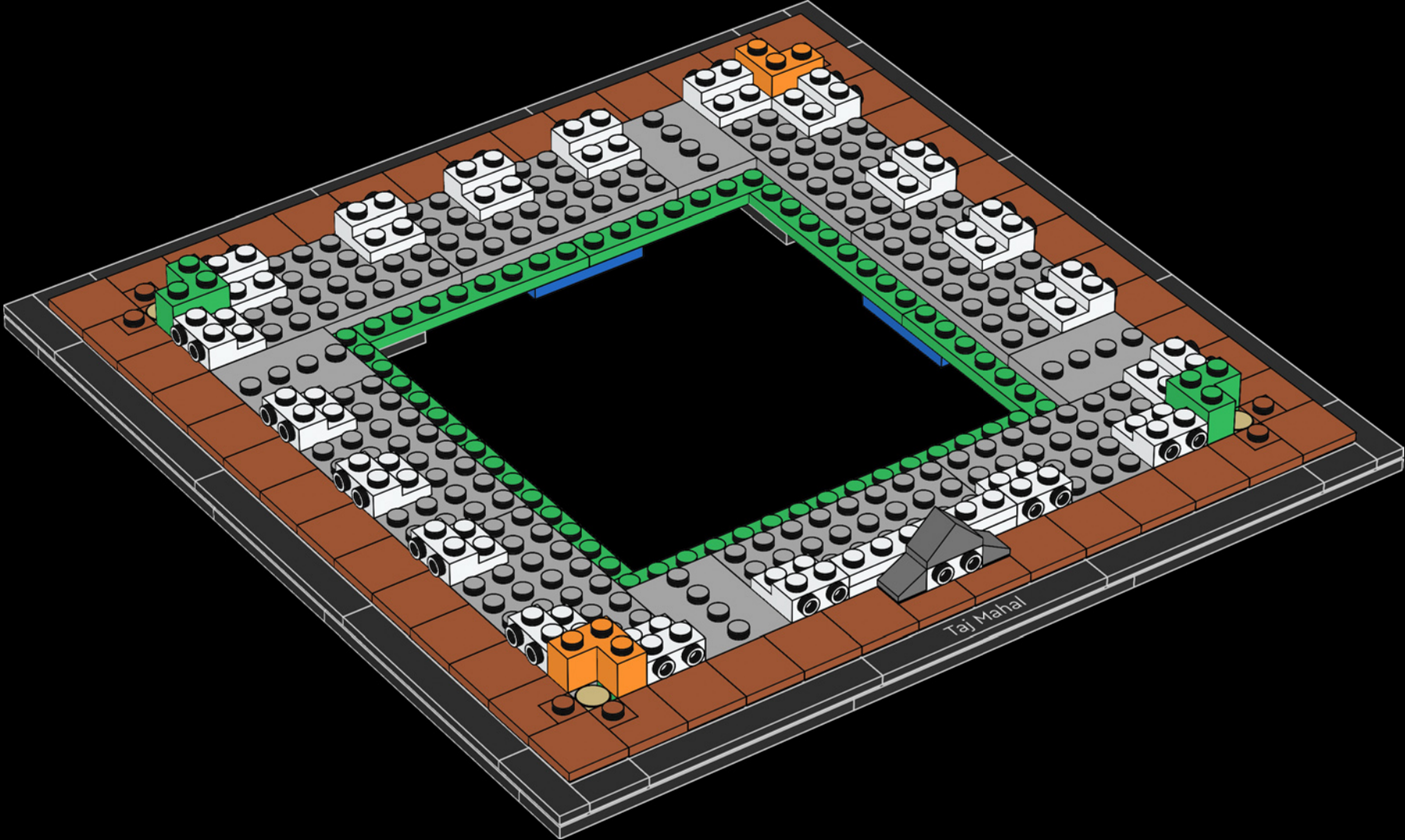

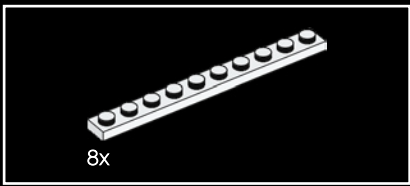

23

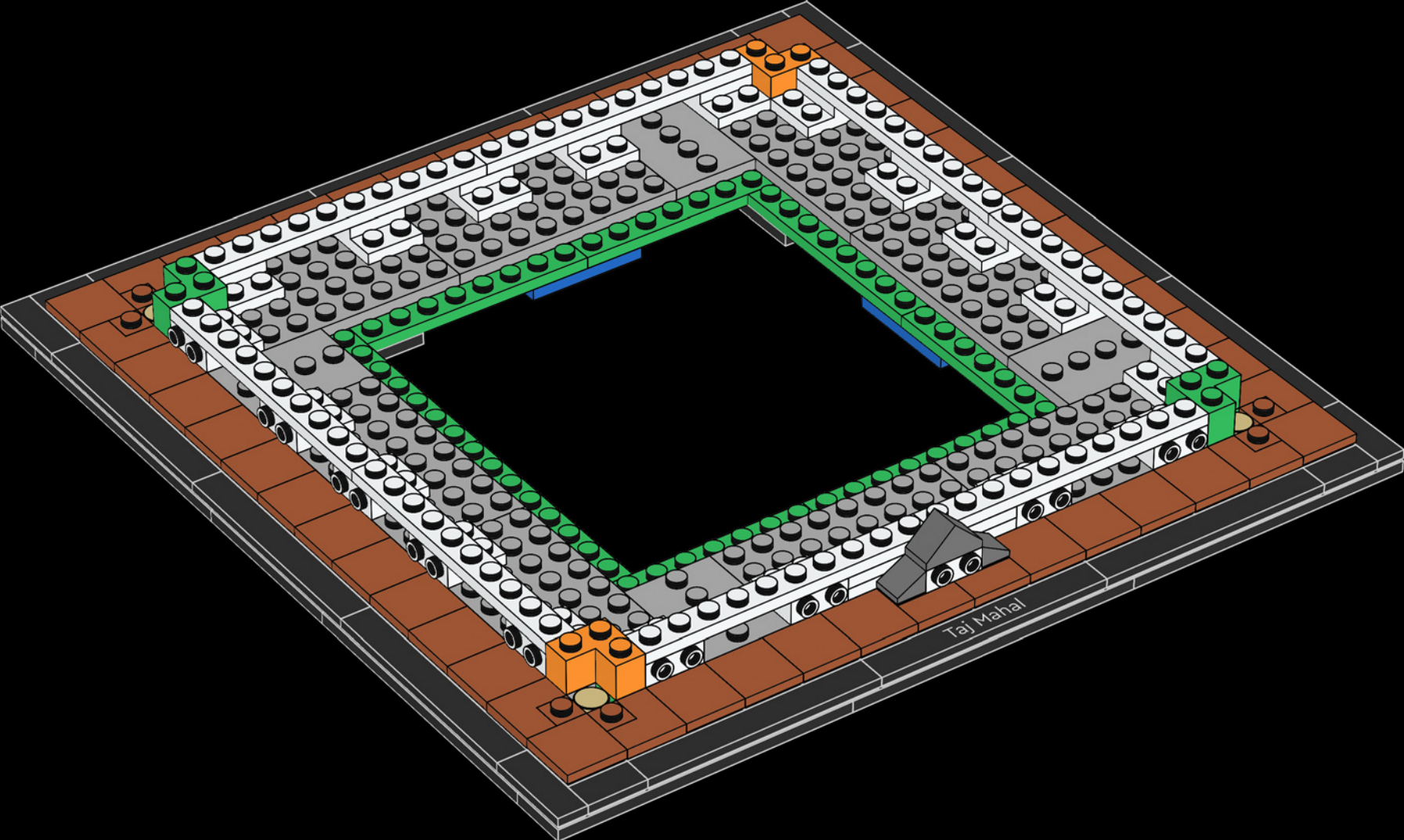

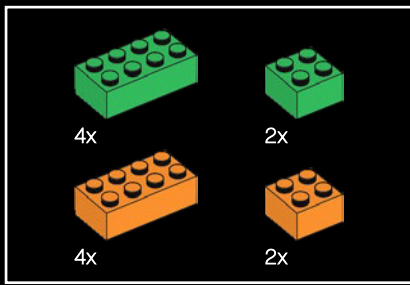

24

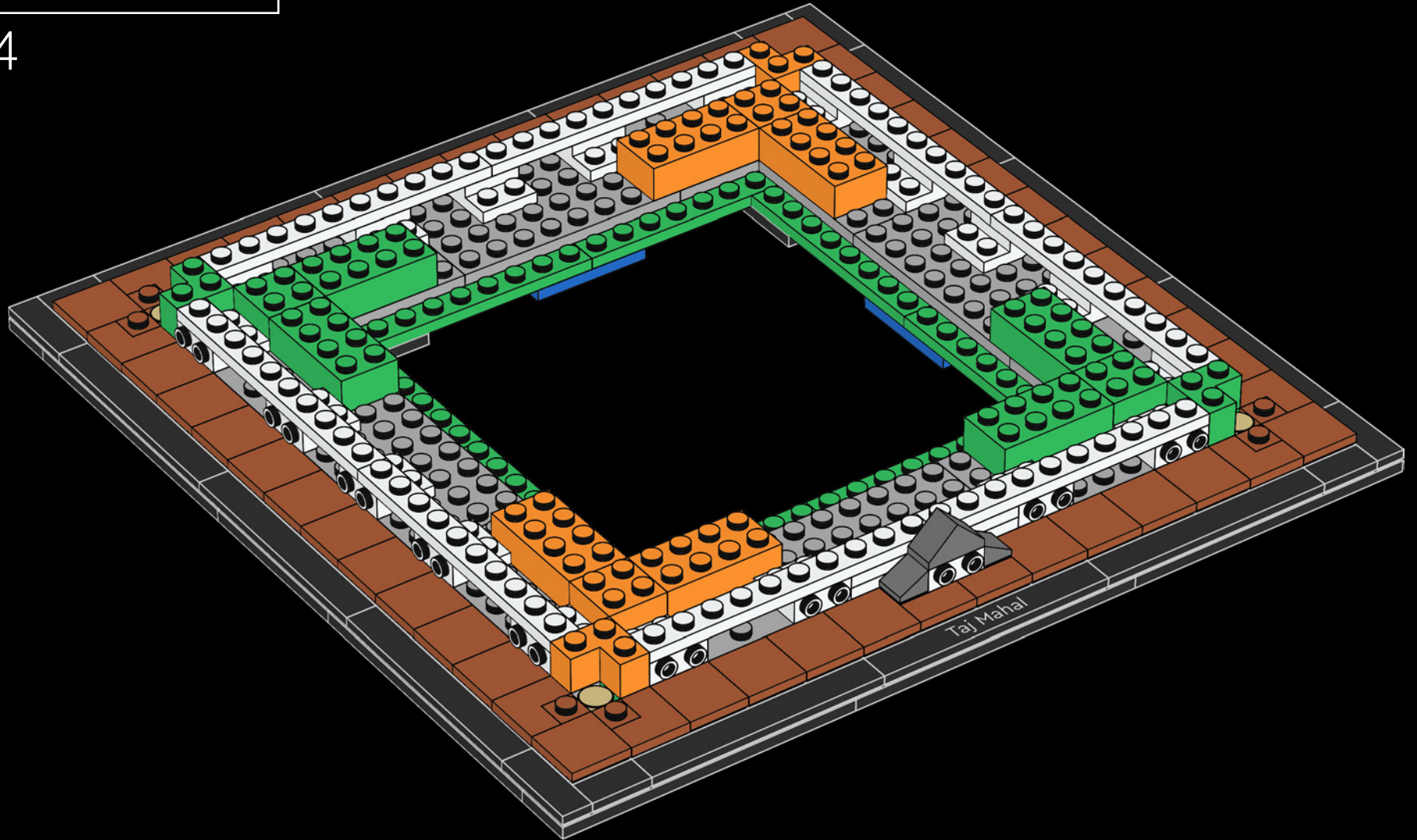

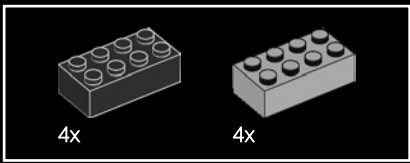

25

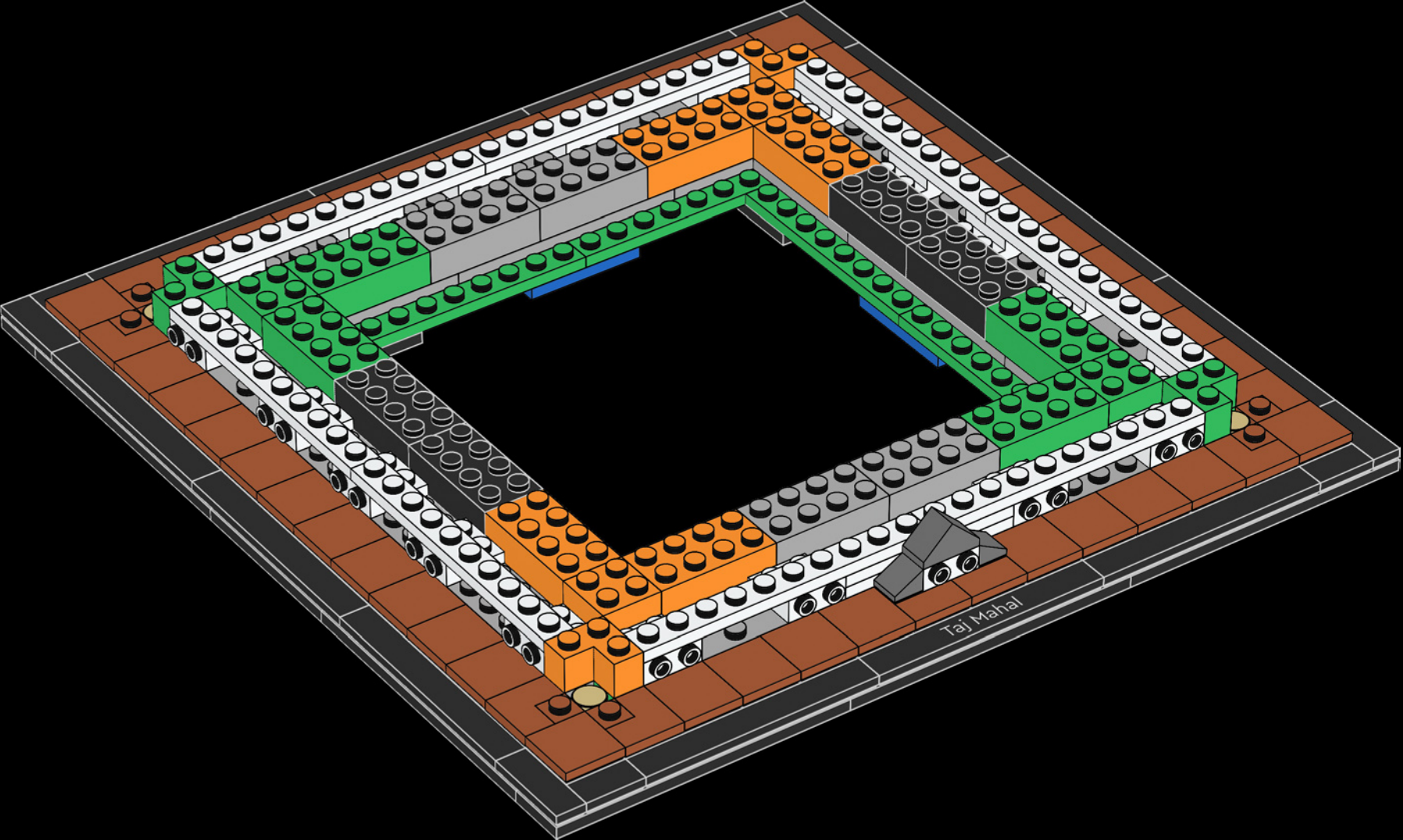

Ustad Ahmad Lahauri, generally regarded as the chief architect of the Taj Mahal, was not Indian but a Persian from Iran.

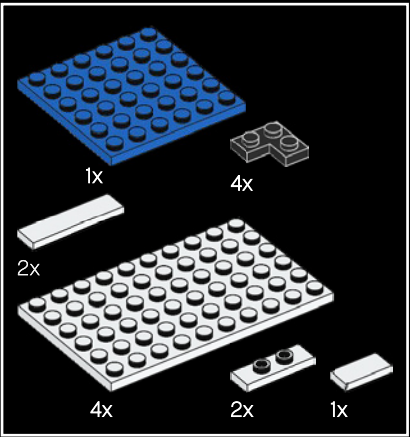
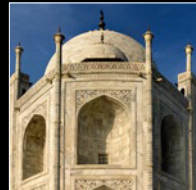

26

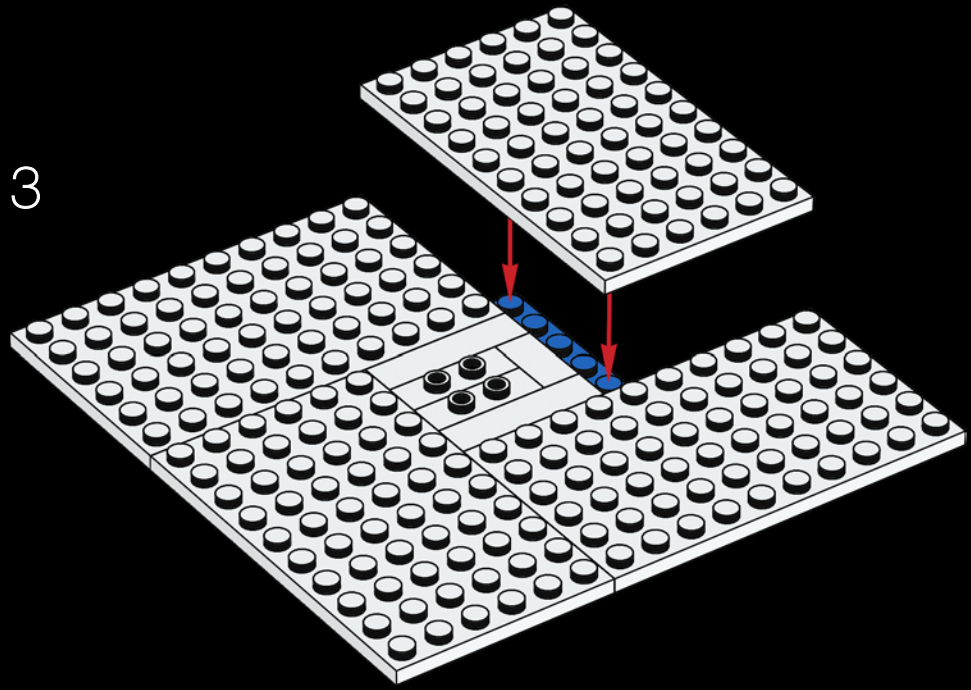
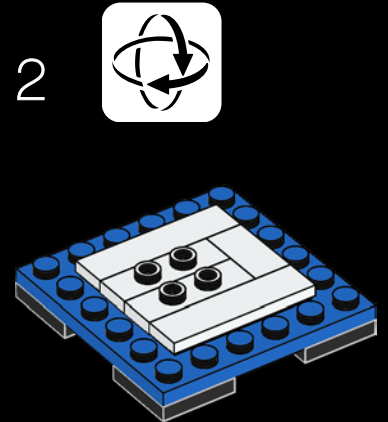
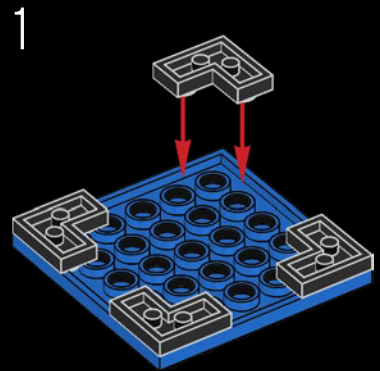

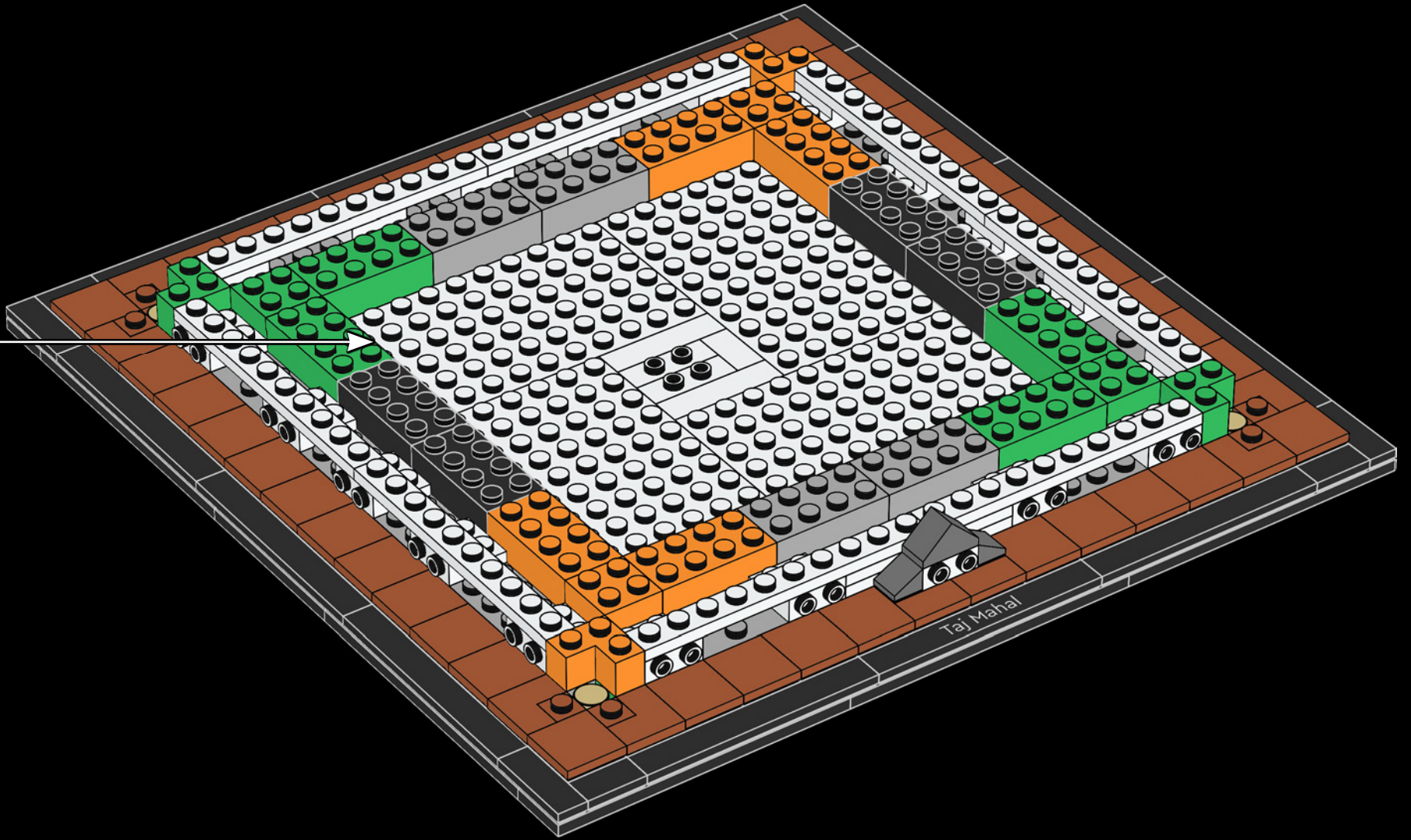

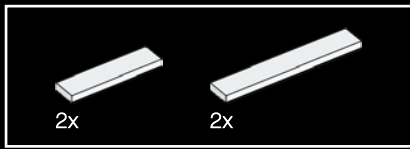

27

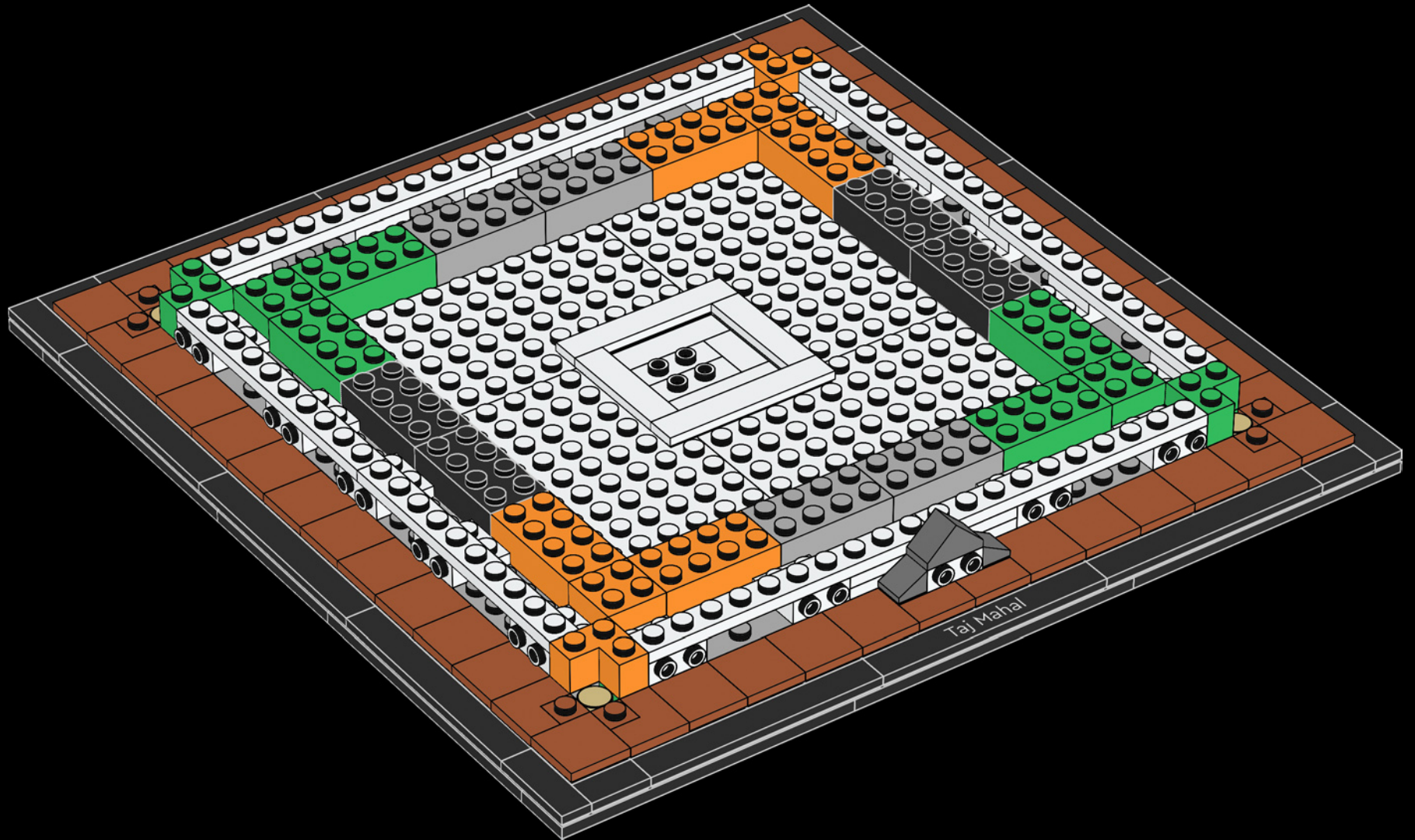

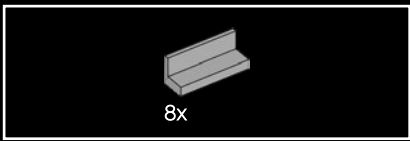

28

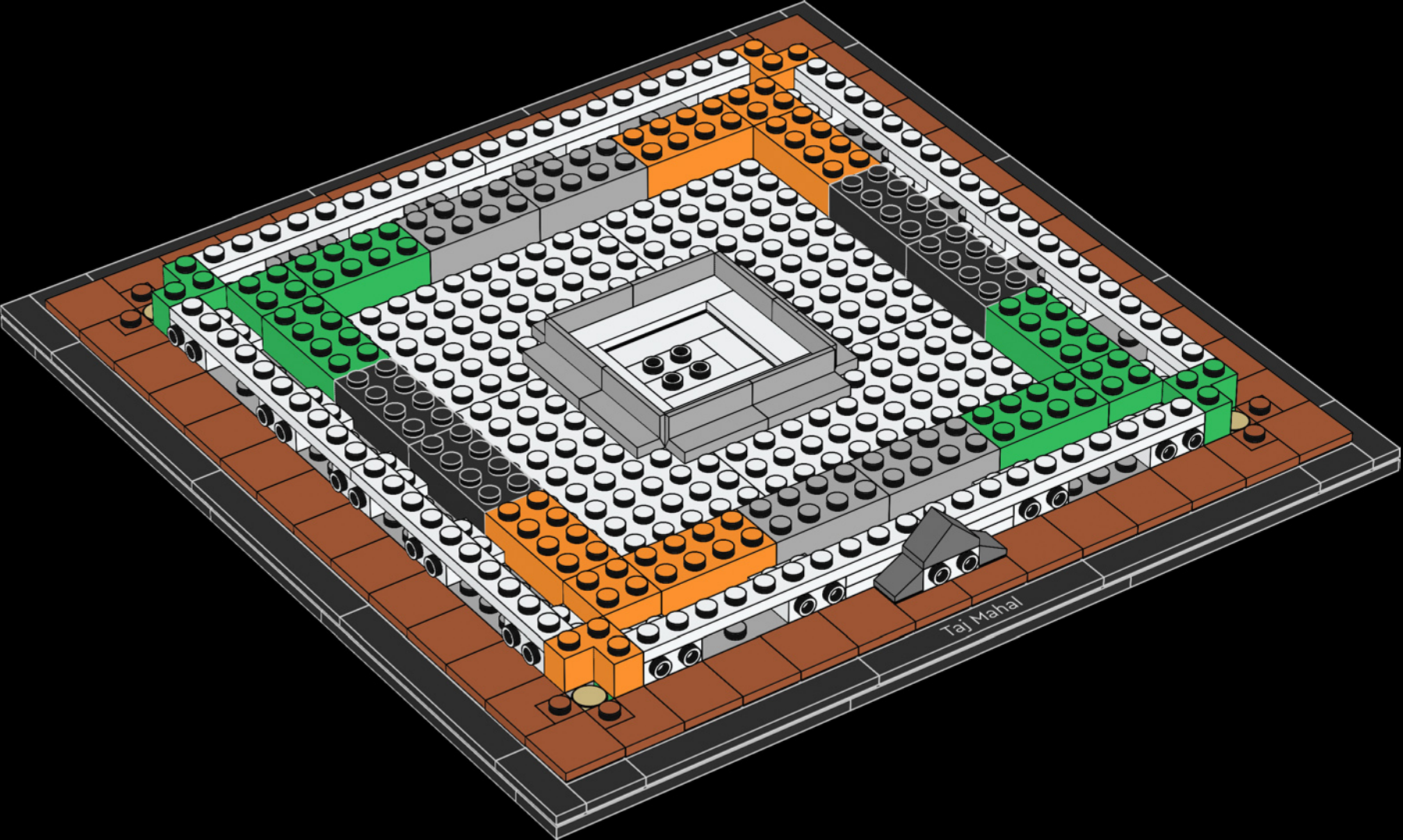

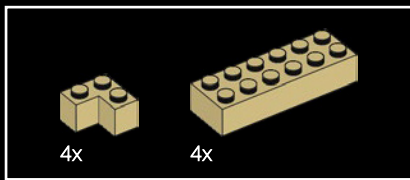

29

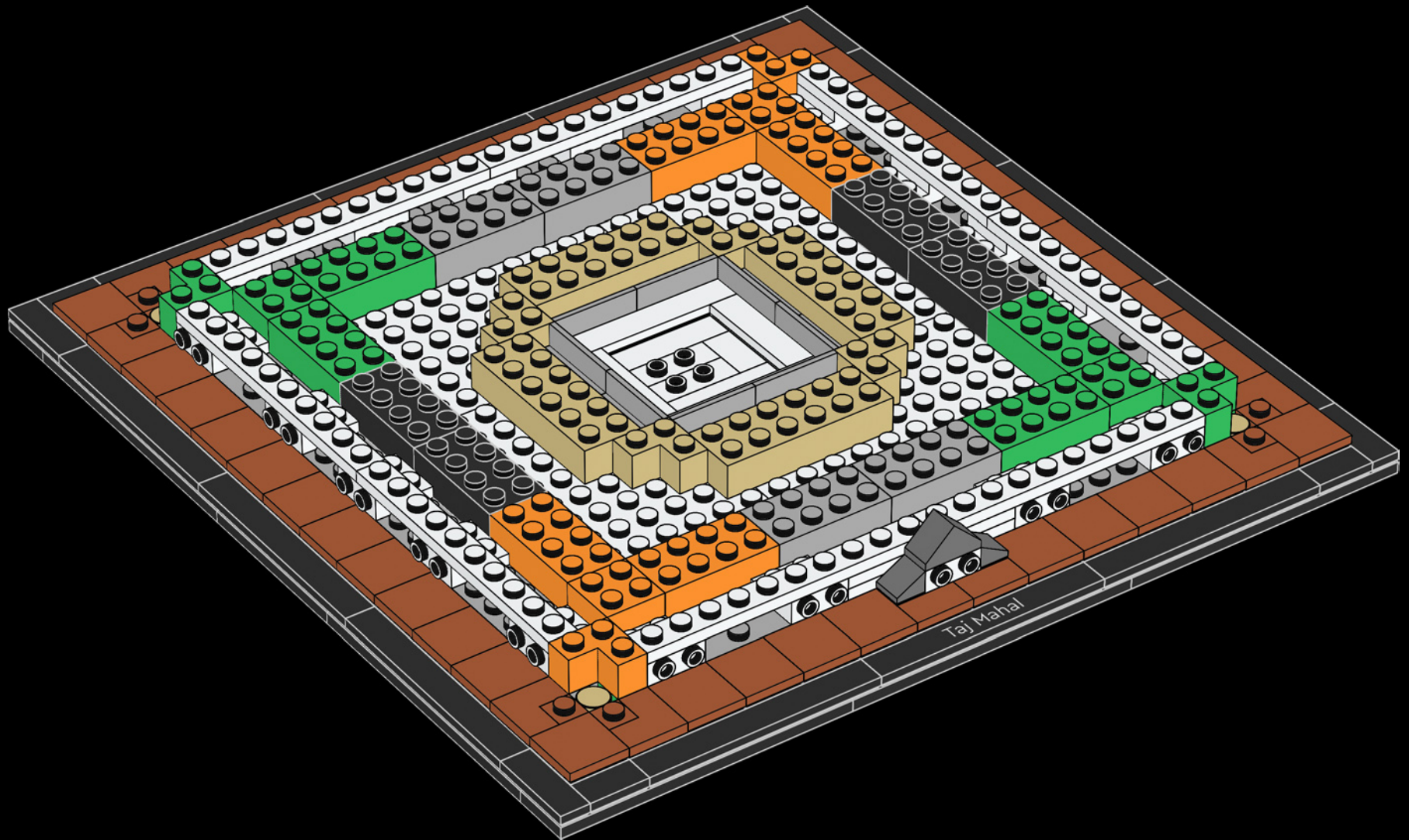



2x

30

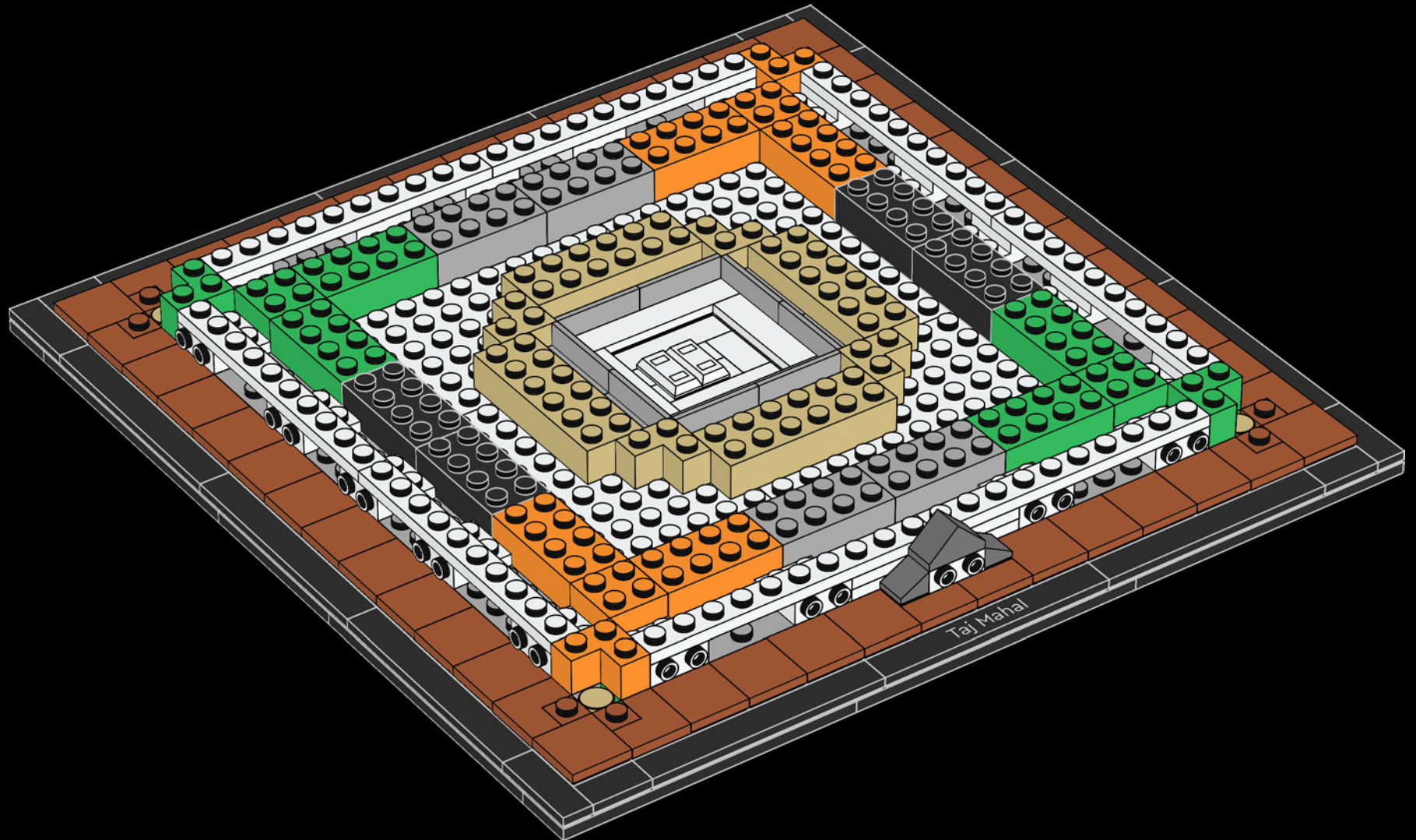

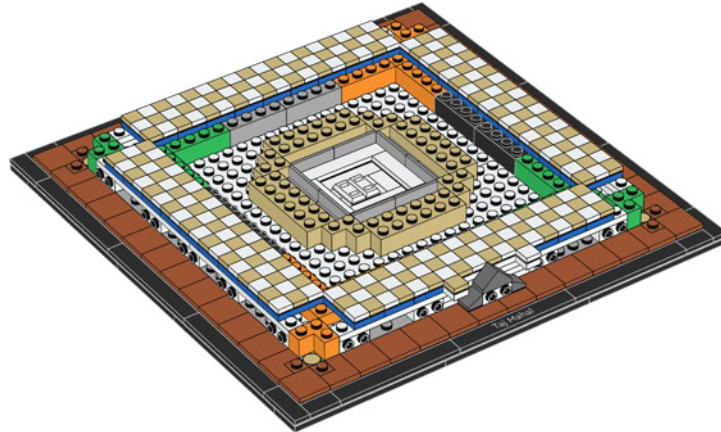
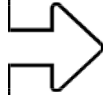



31

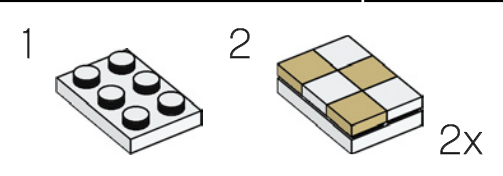
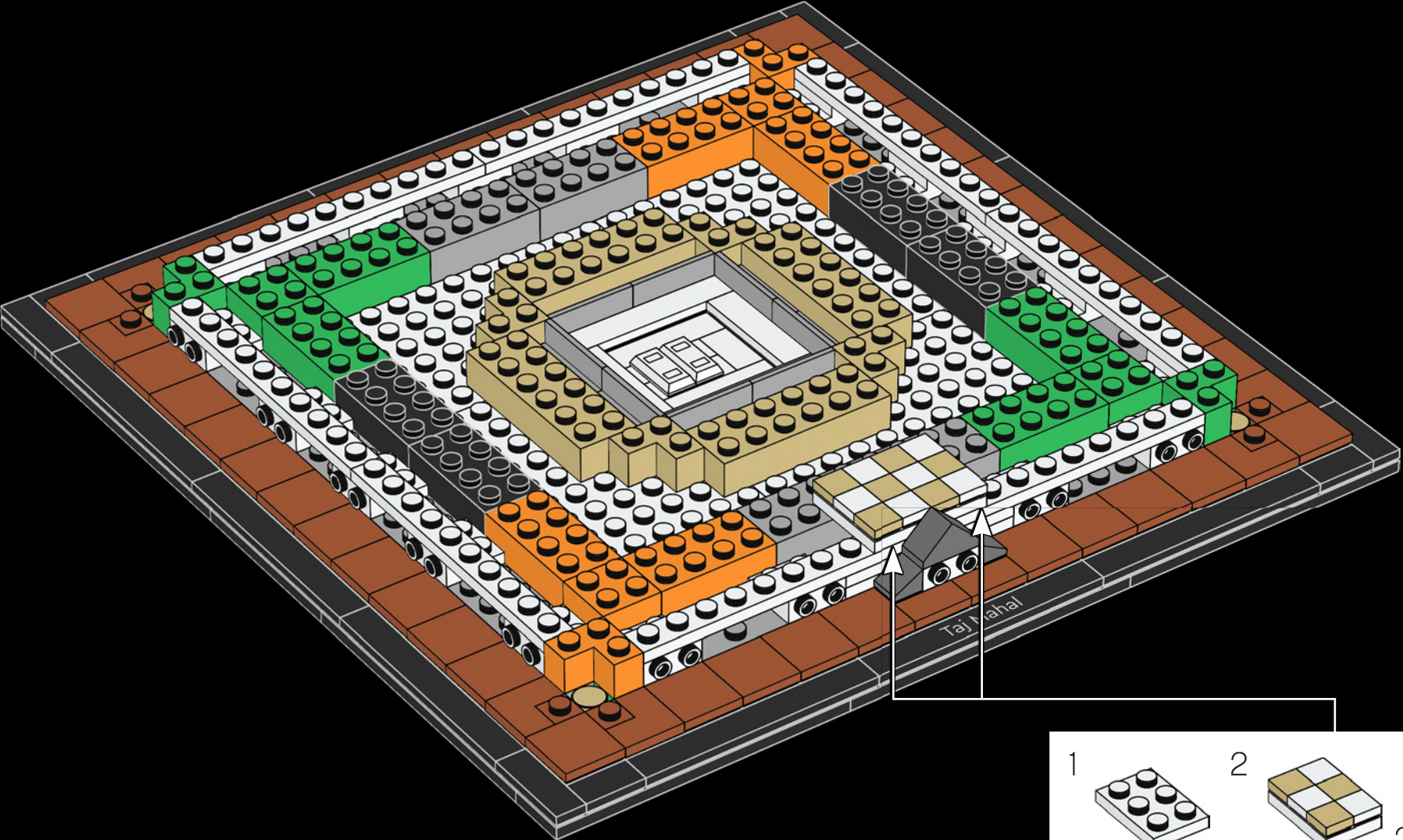



32

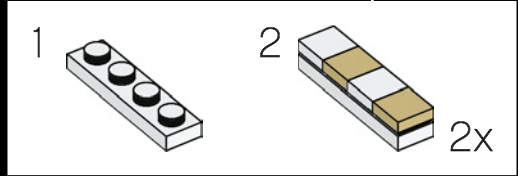
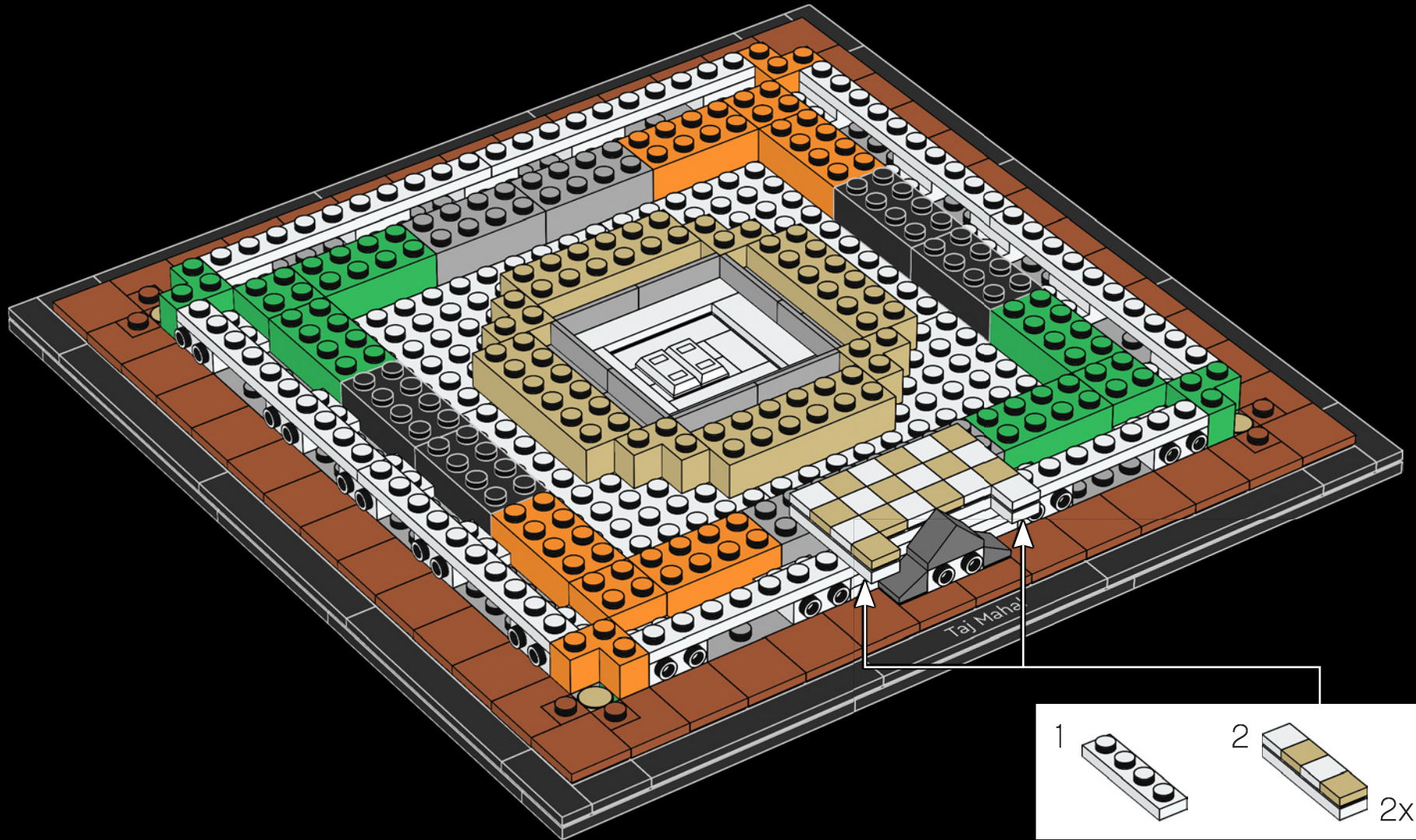

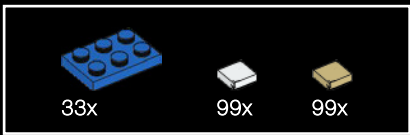

33

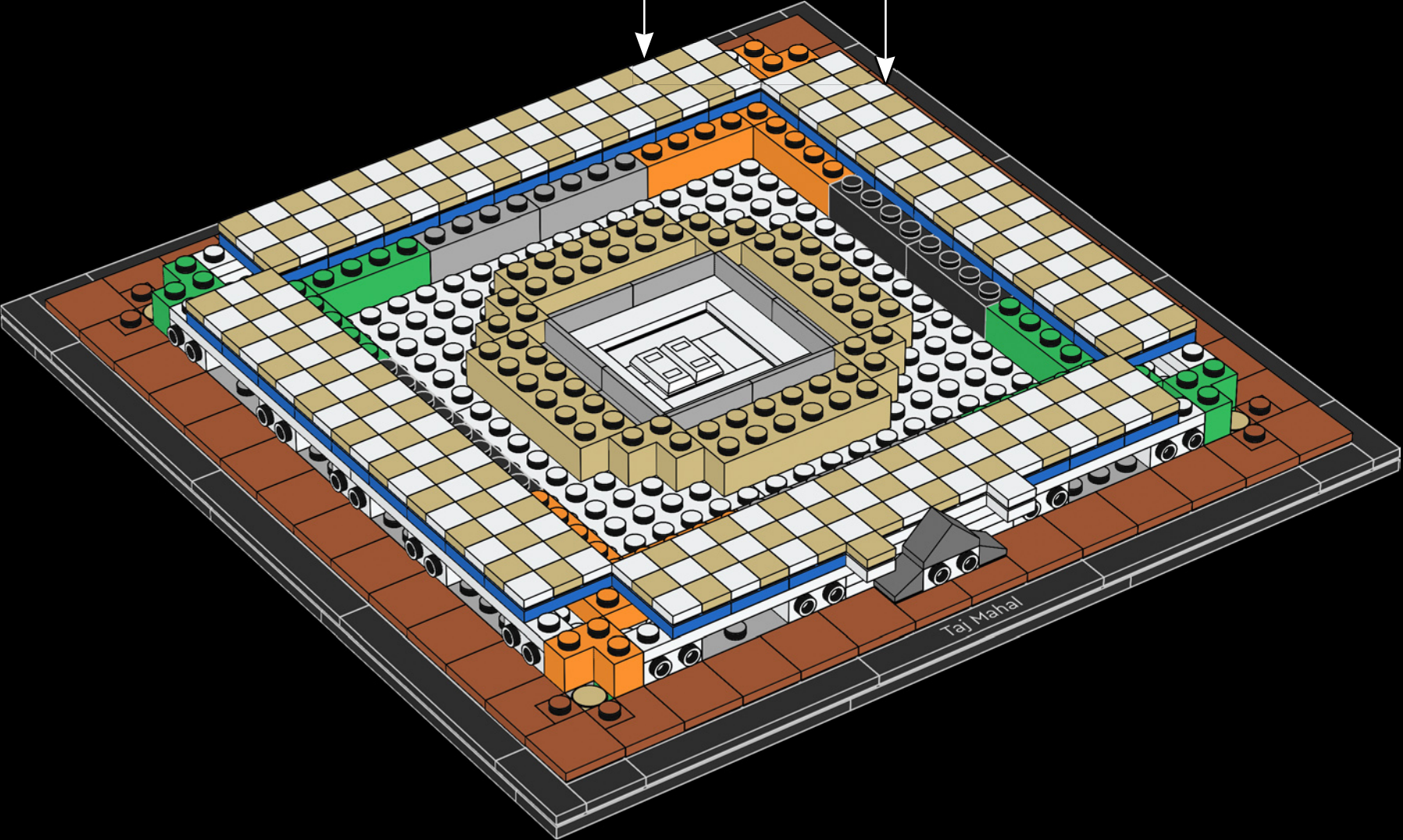
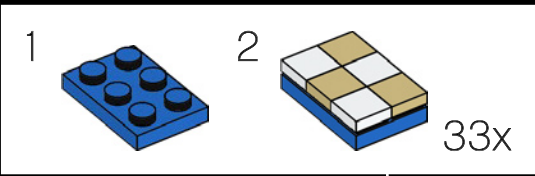

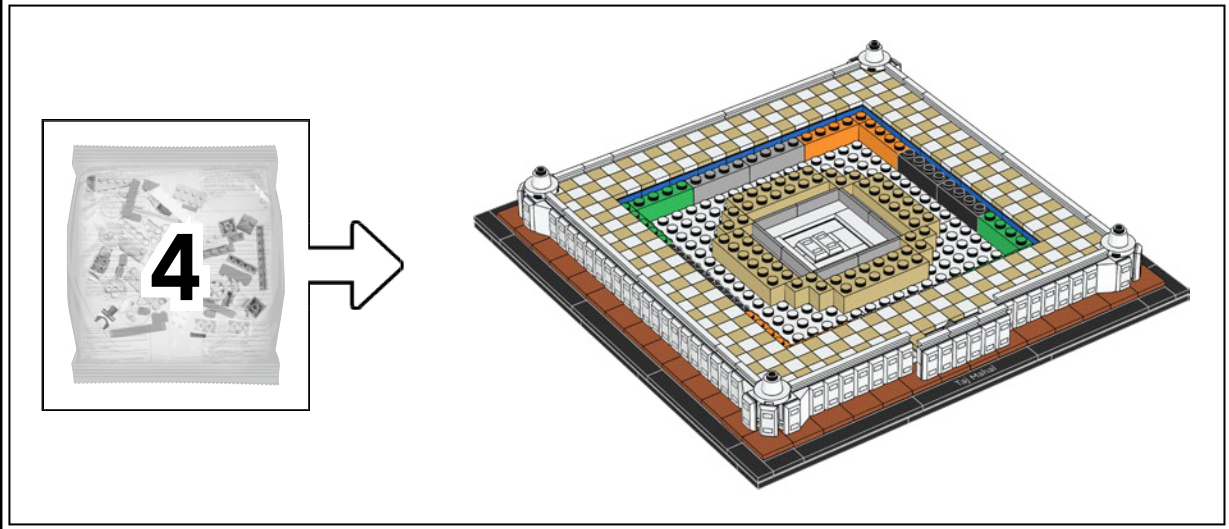



16x

34



8x

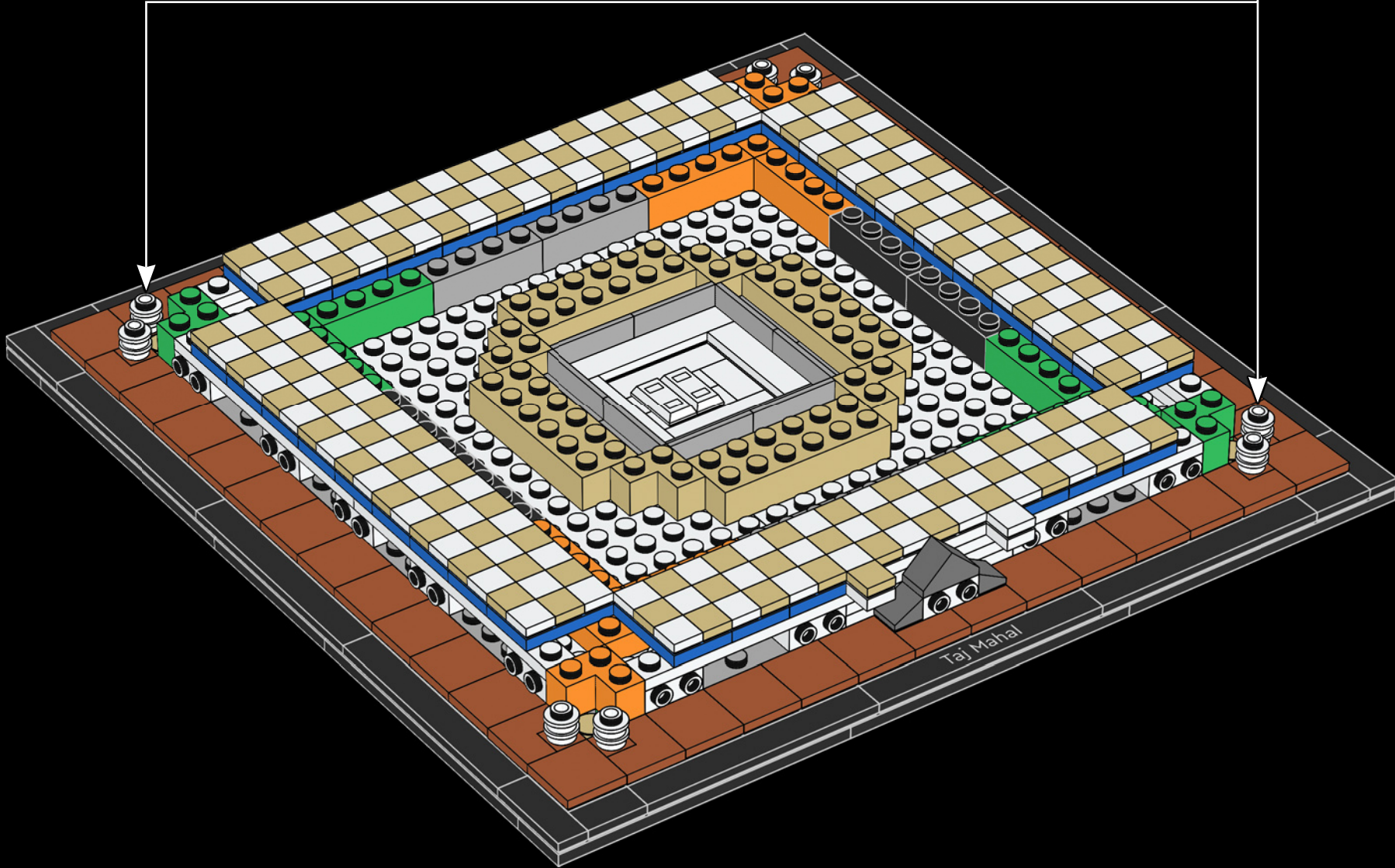

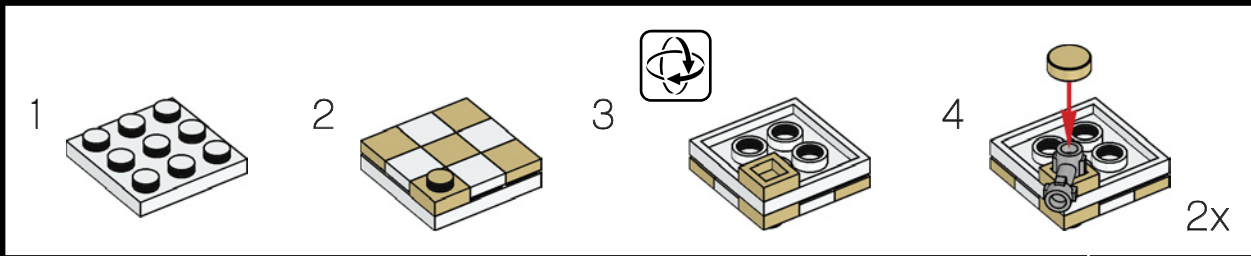
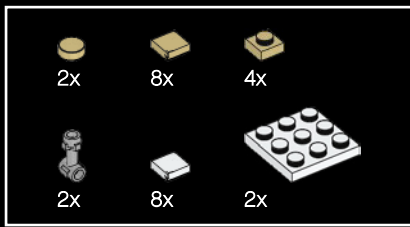

35

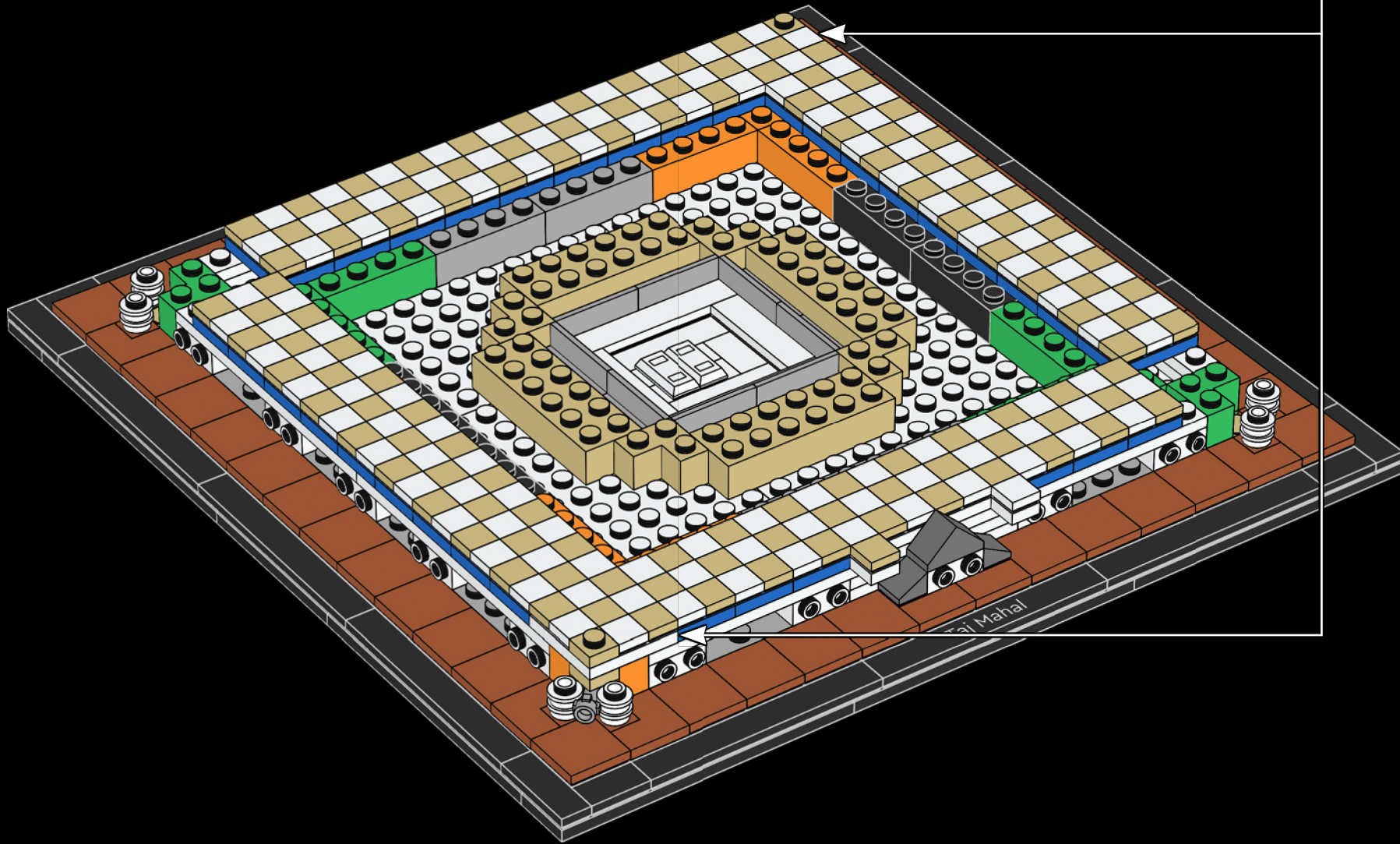

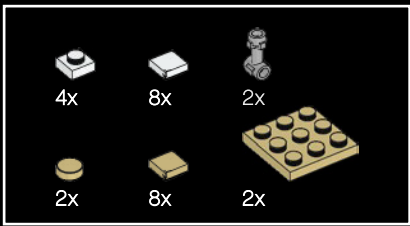

36

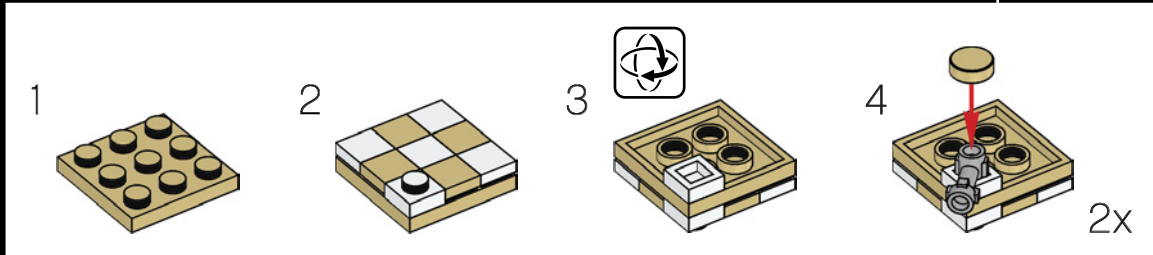
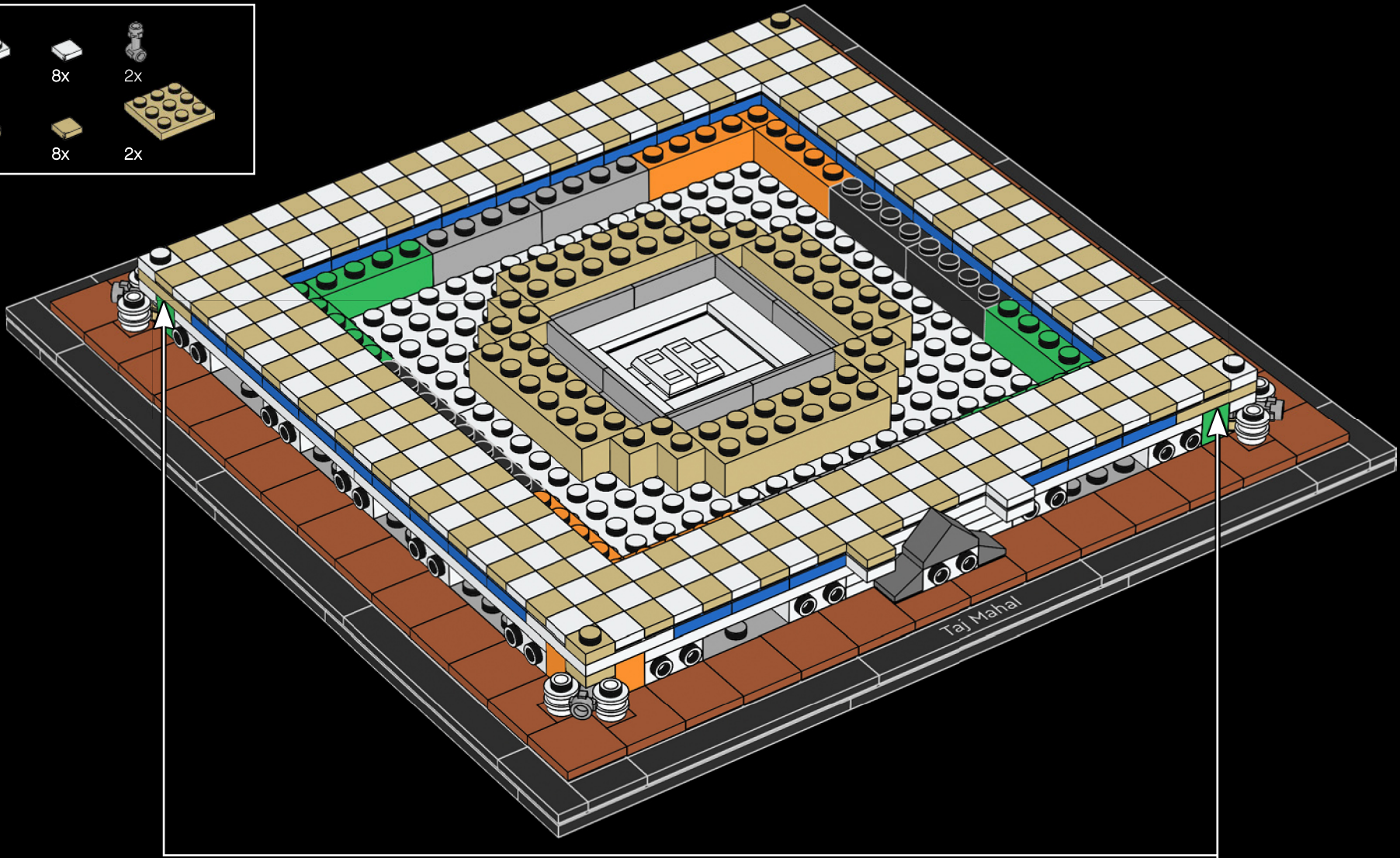

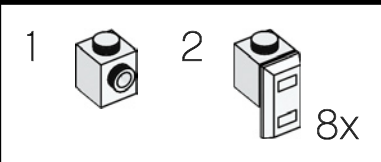
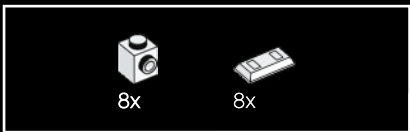

37

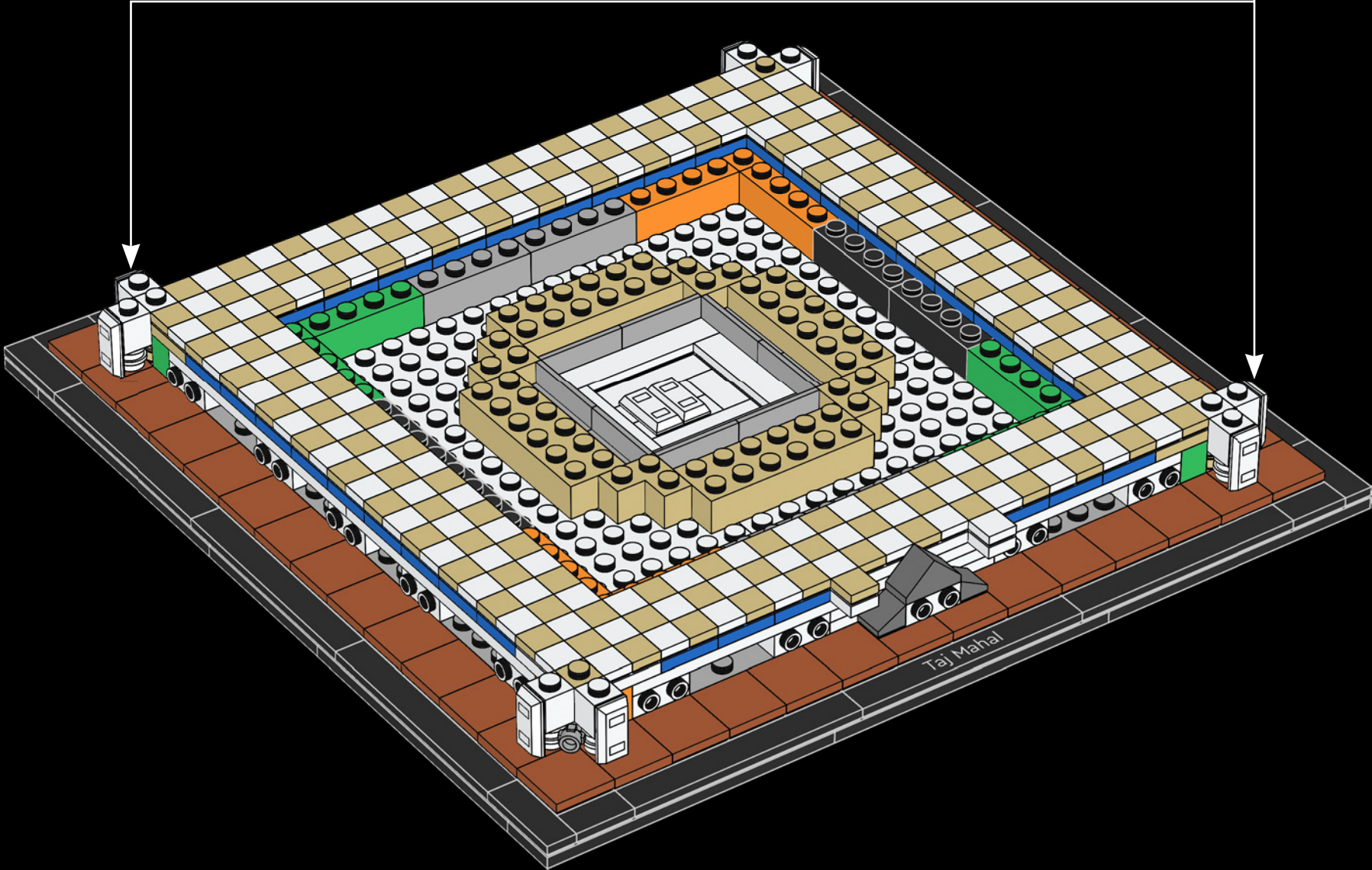



38

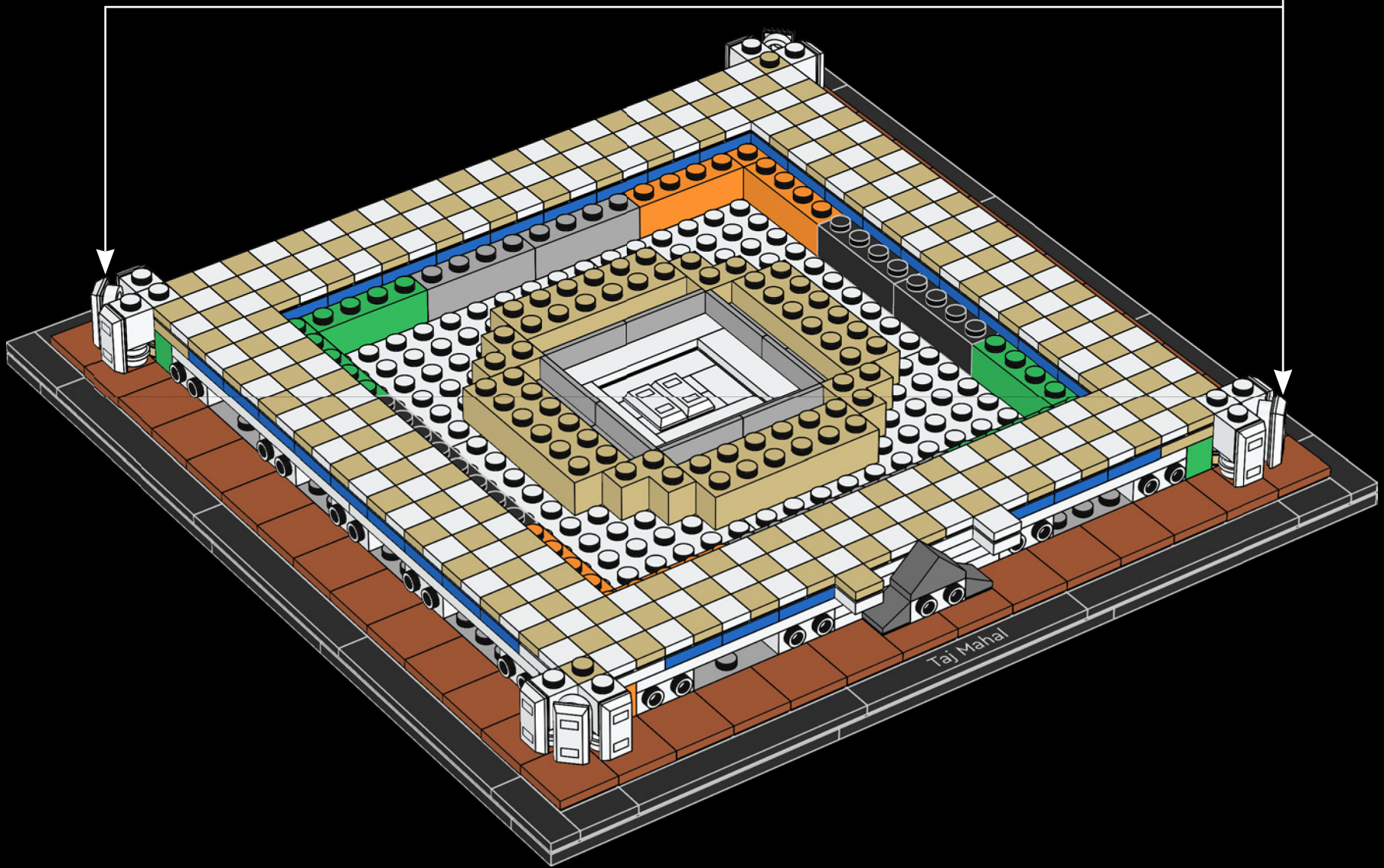
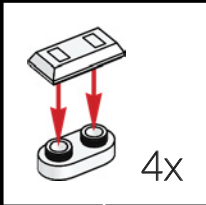



39

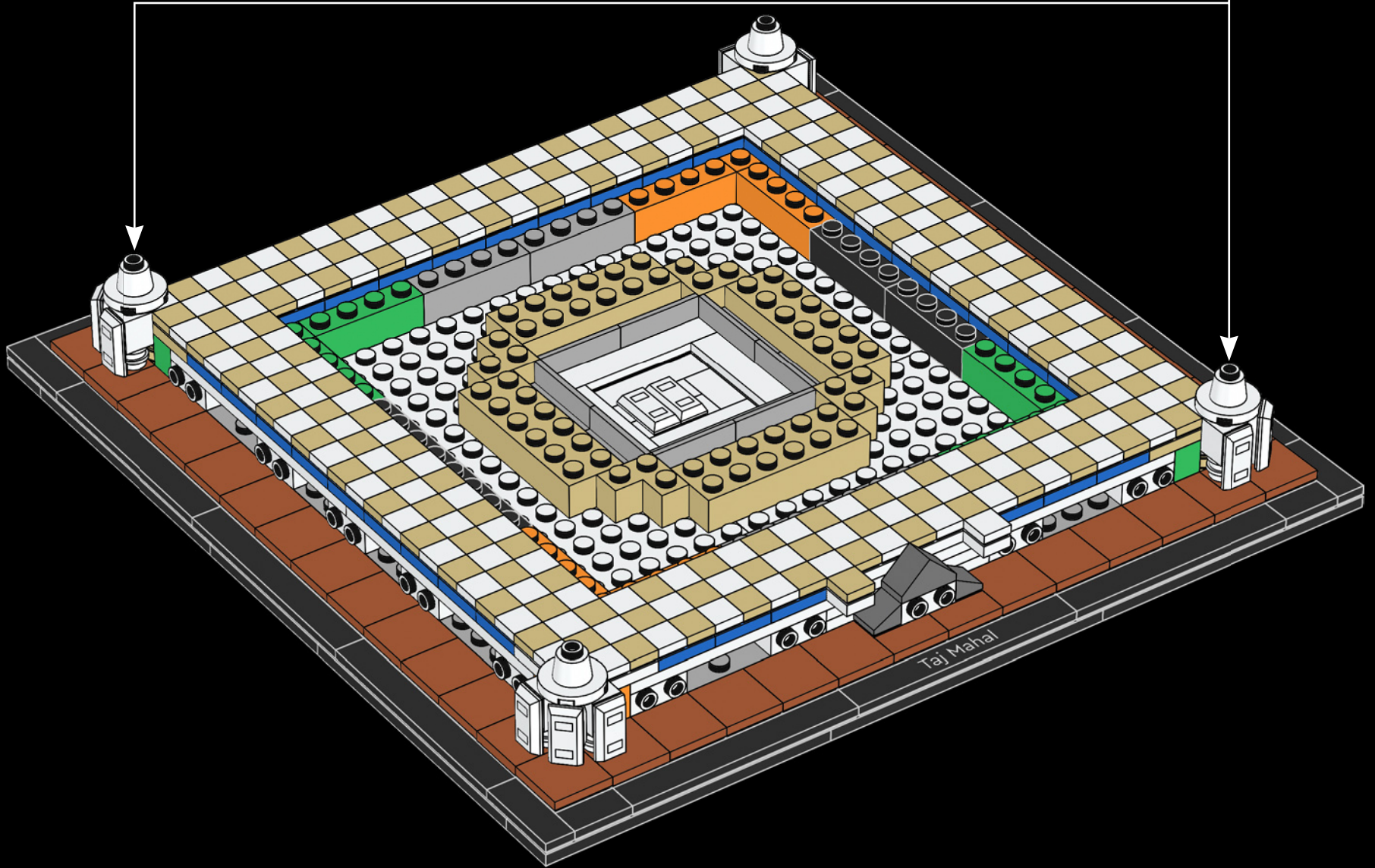
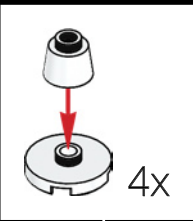

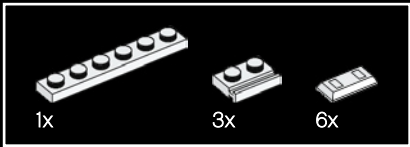

40

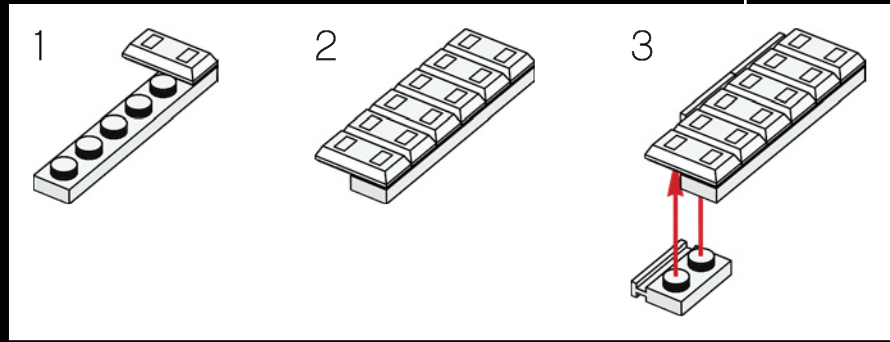
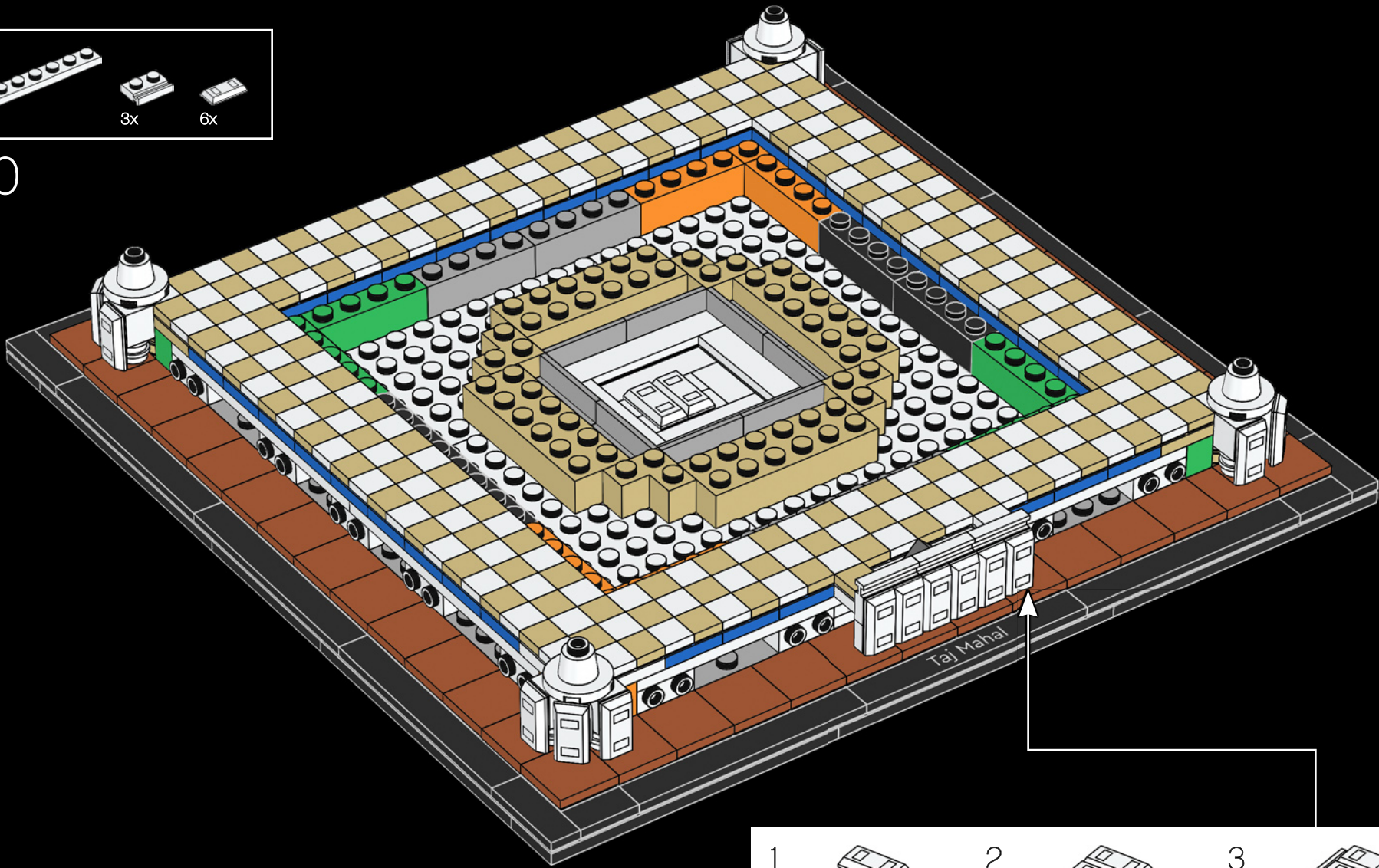

50

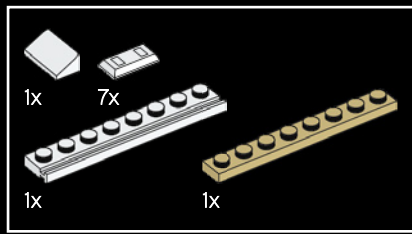

41

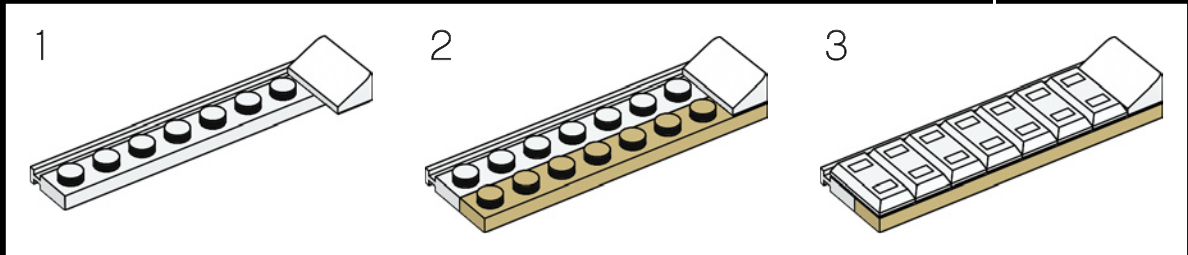
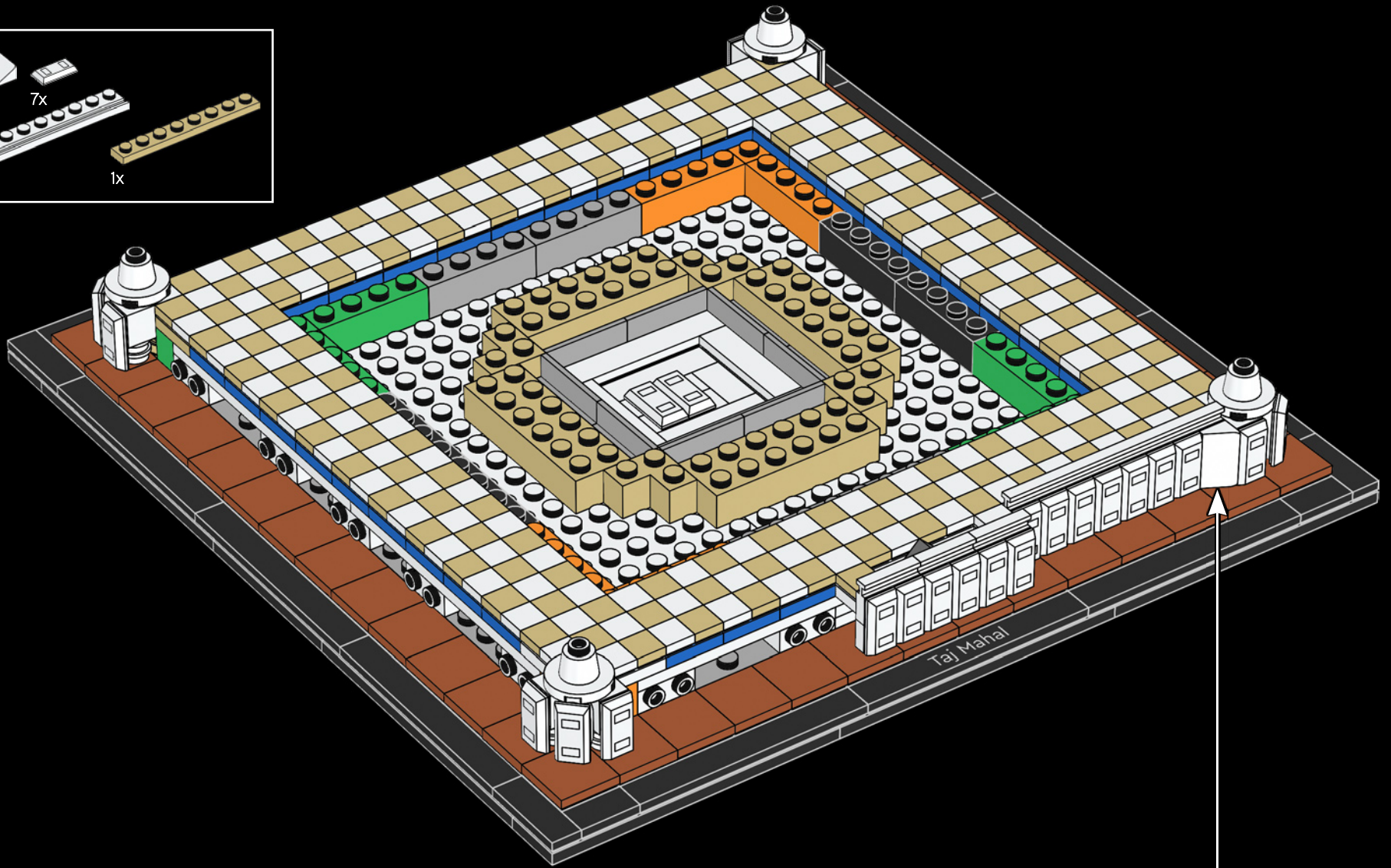

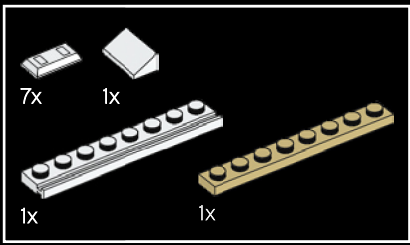

42

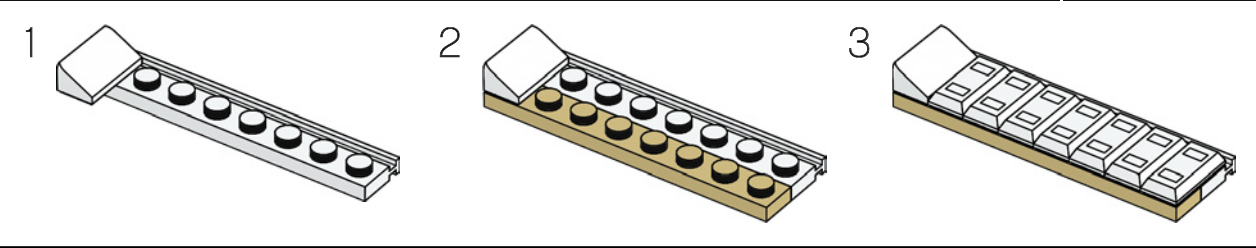
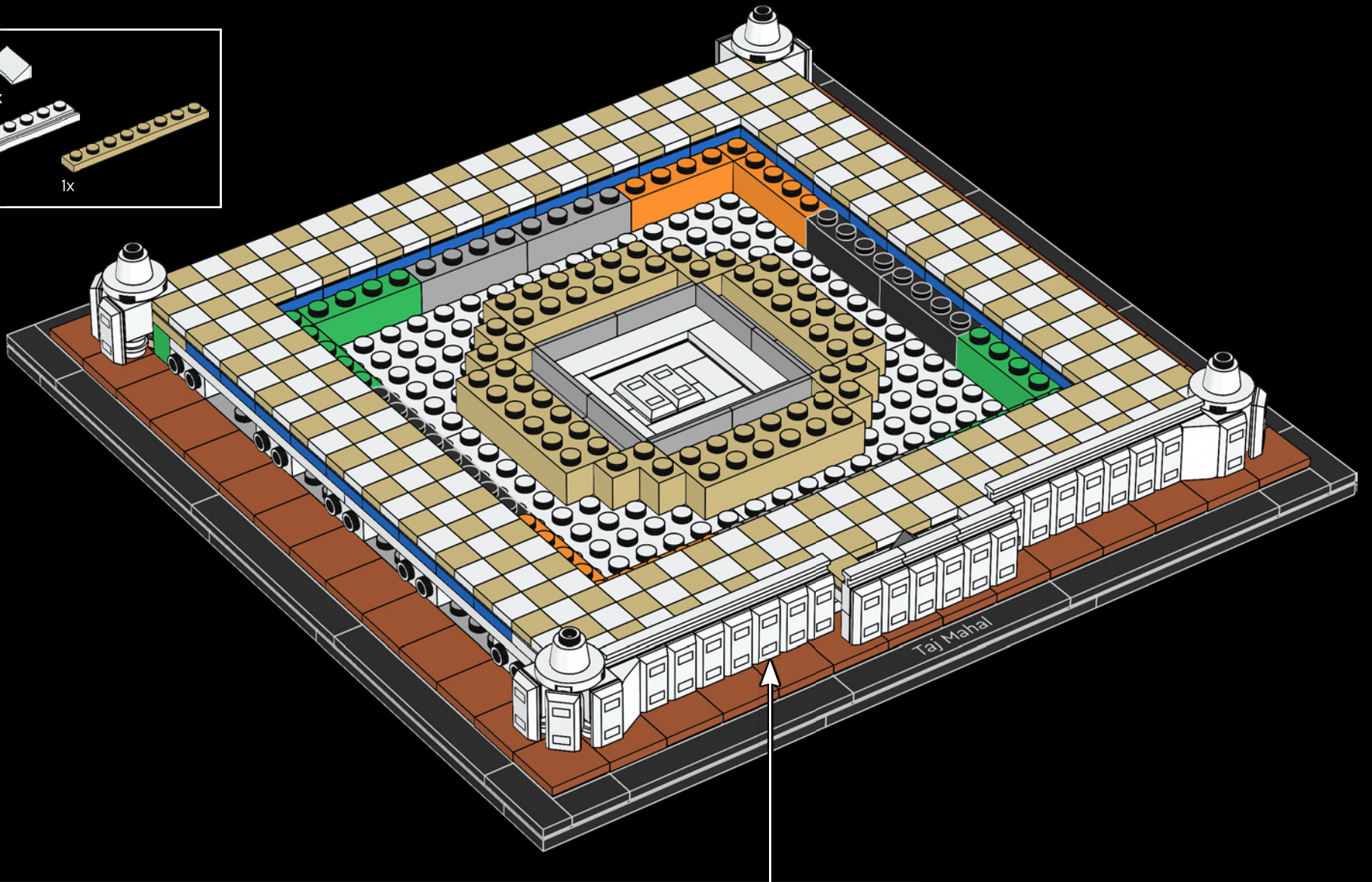

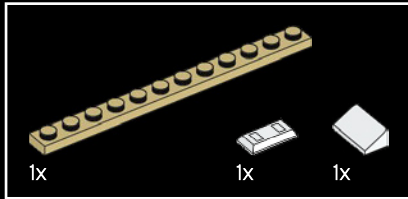
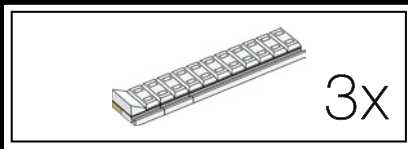

43

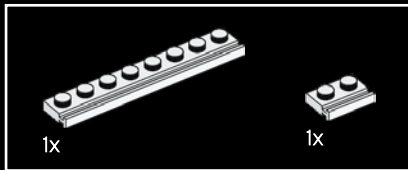
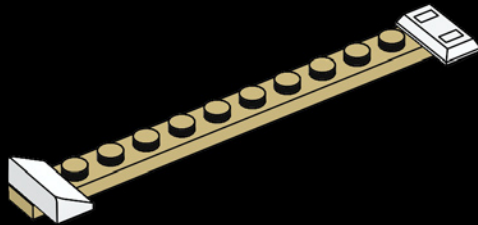

44

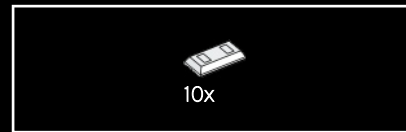
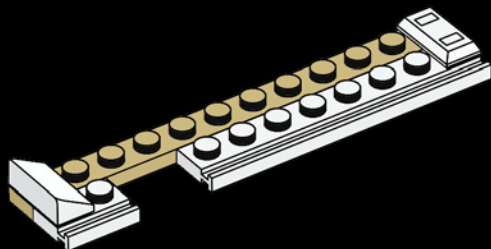

45

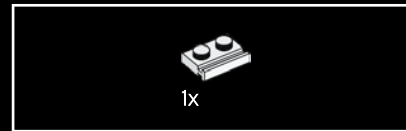
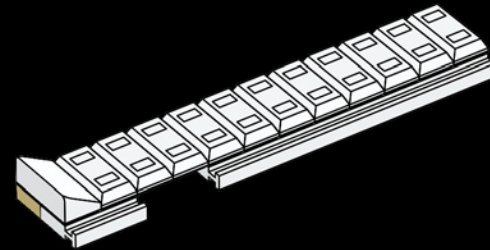

46

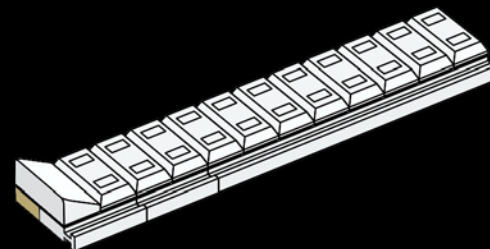

3x

47

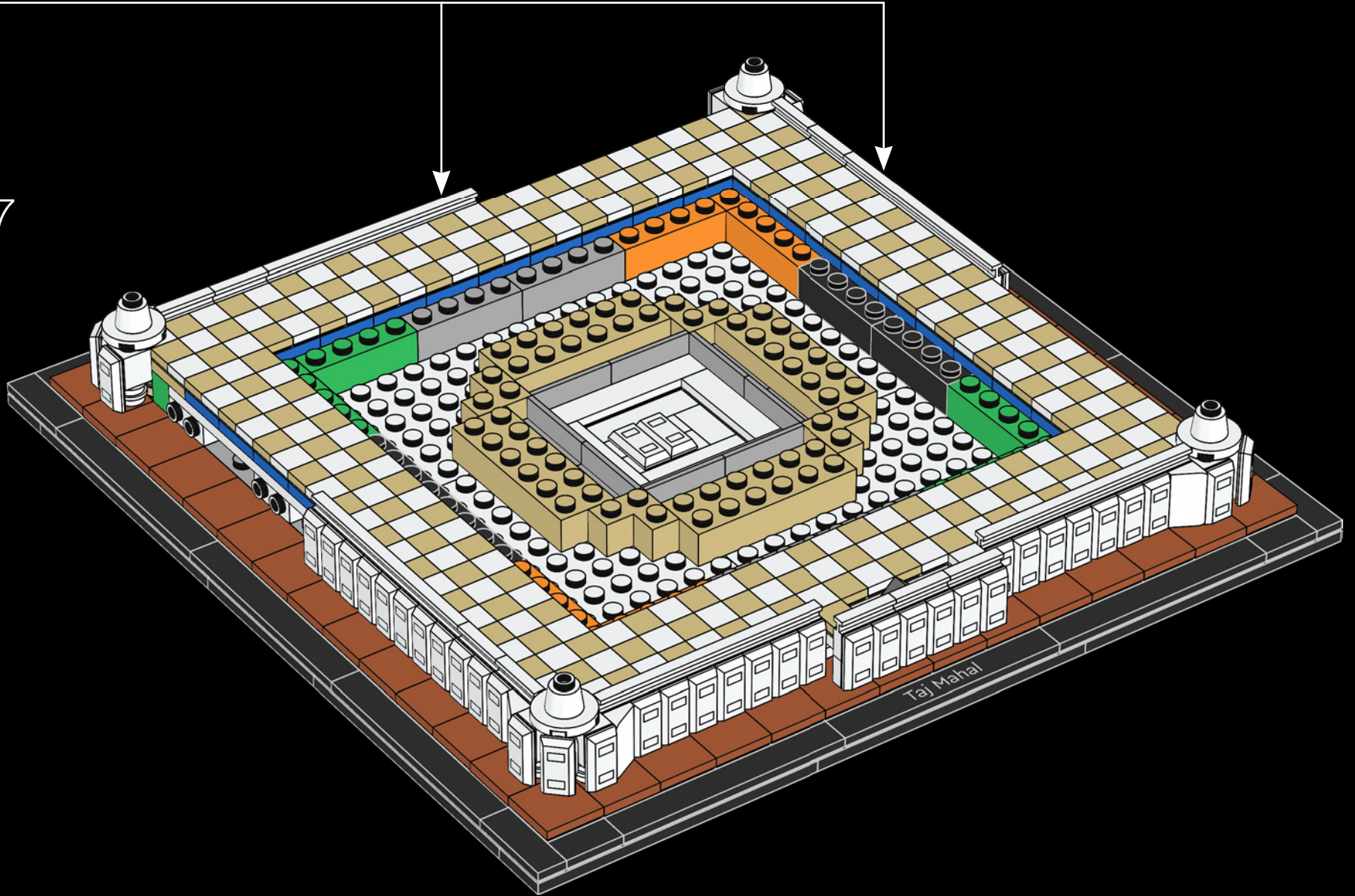

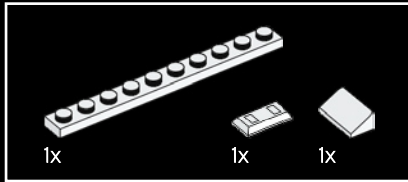
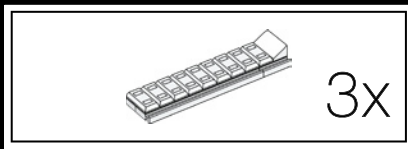

48

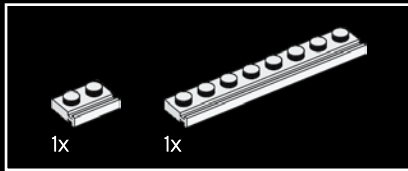
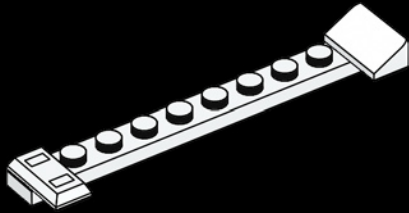

49

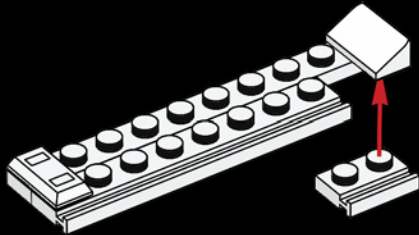

50

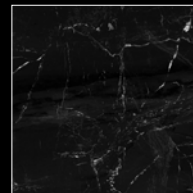
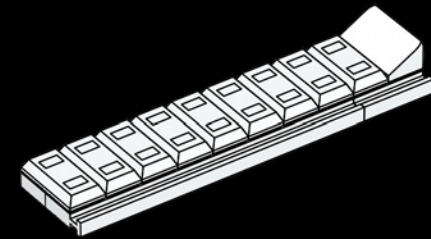

A longstanding myth holds that Shah Jahan planned a mausoleum to be built in black marble as a Black Taj Mahal across the Yamuna river.

51

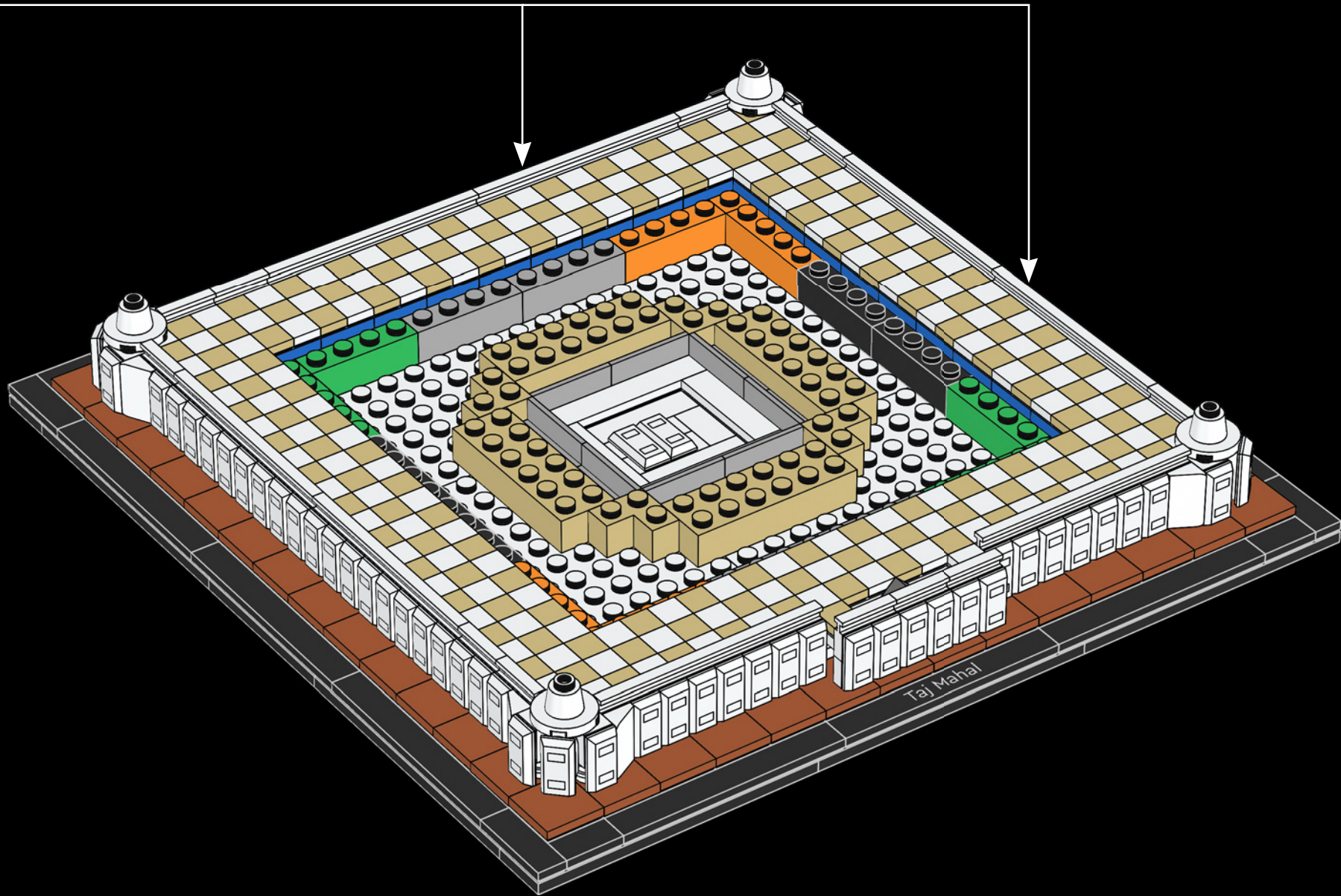

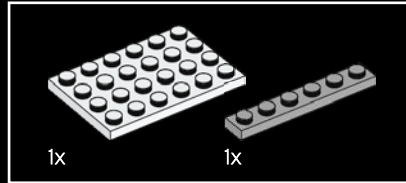
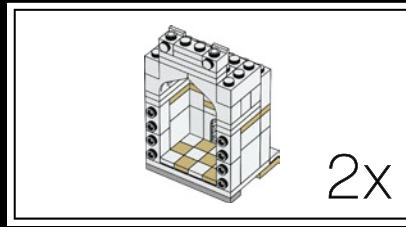
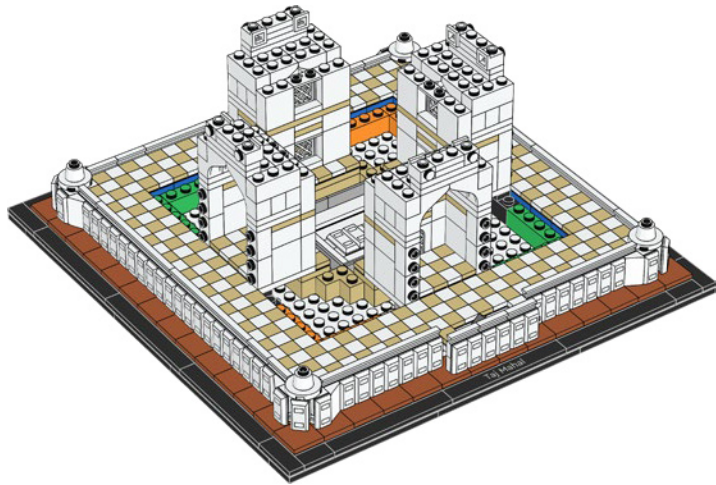
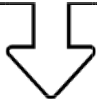

52

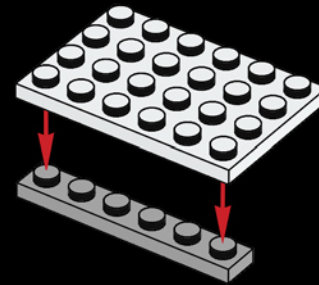

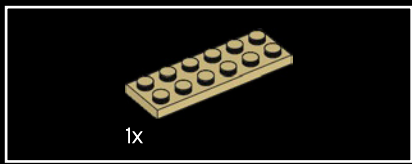

53

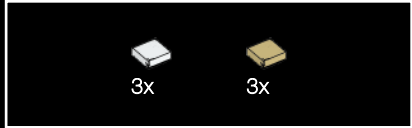
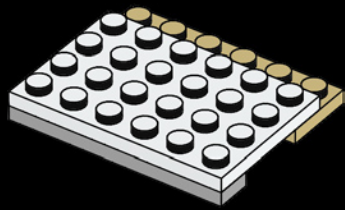

54

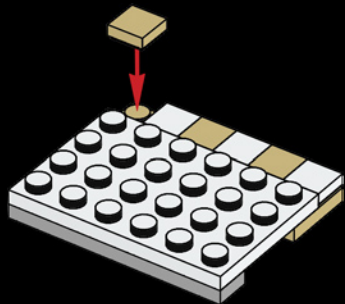

55

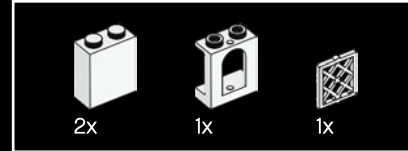
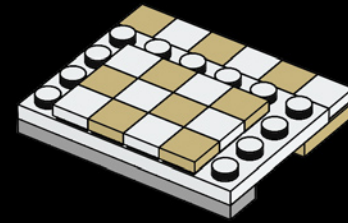

56

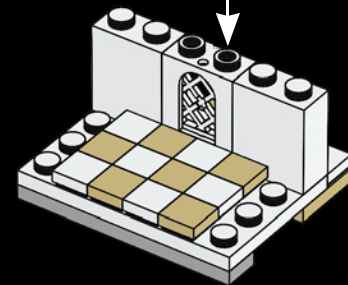
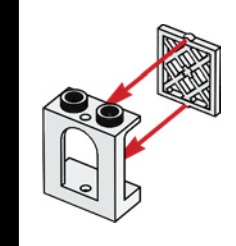



57

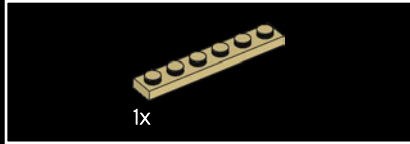
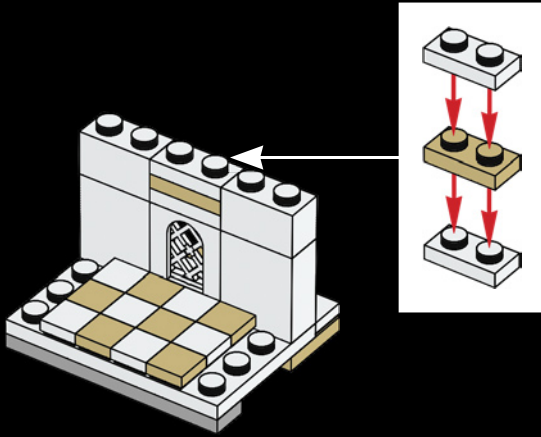

58

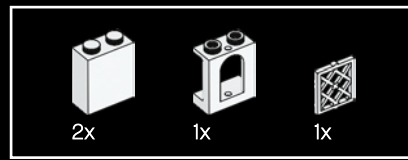
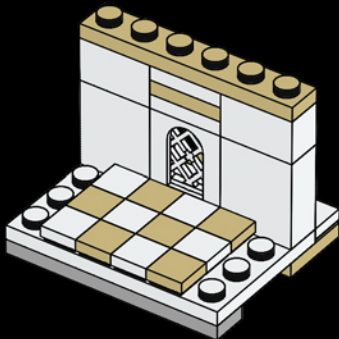

59

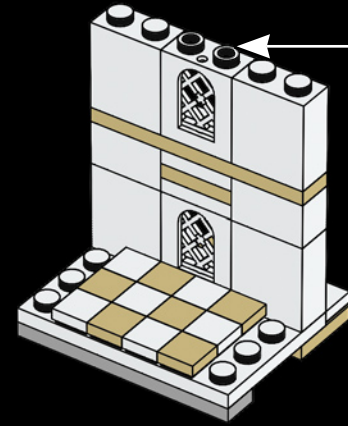

60

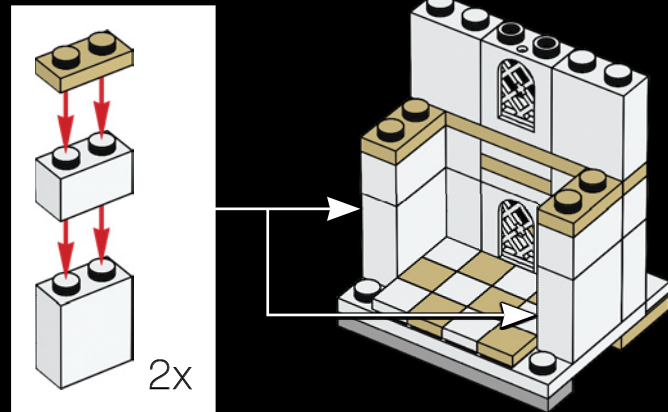



4x

61

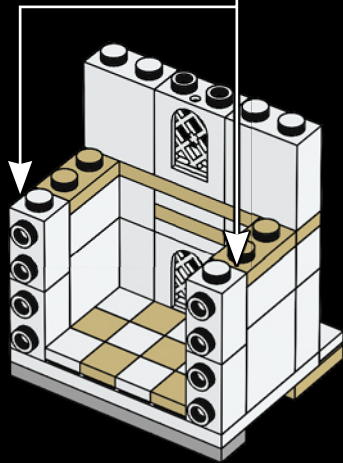
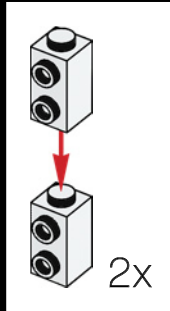

4x

62

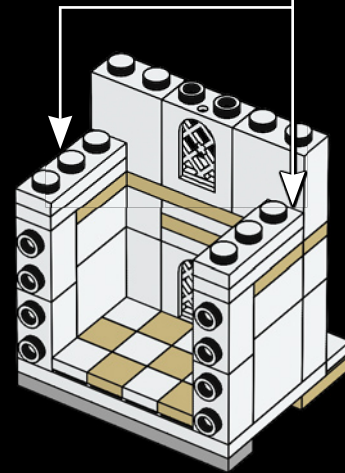
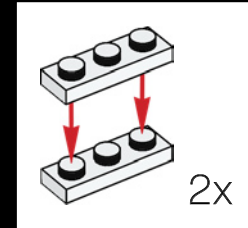

A total of 28 different types of precious and semiprecious jewels are set in the white marble.

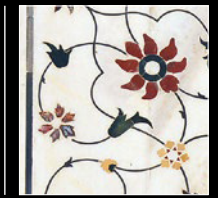

65

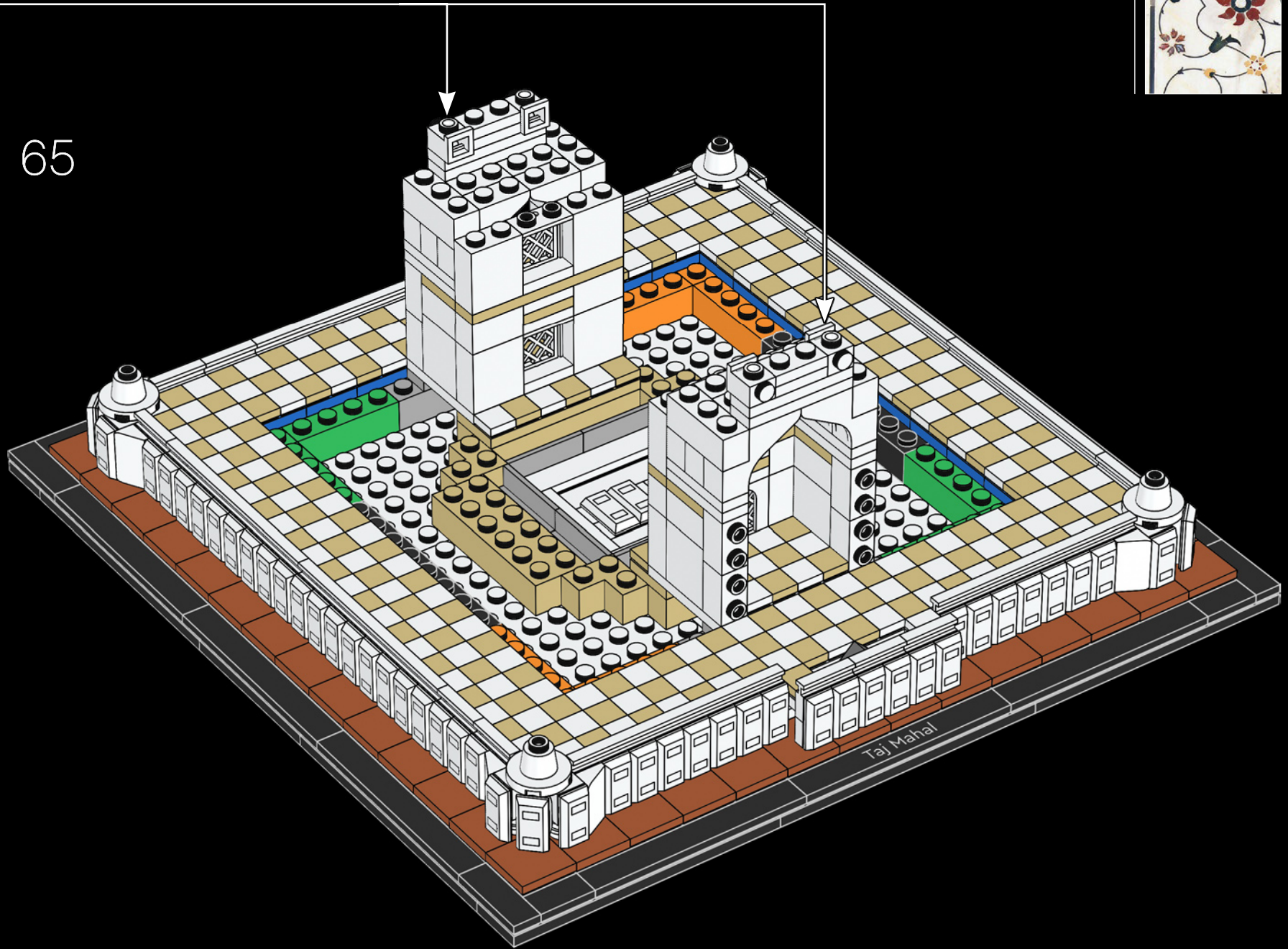

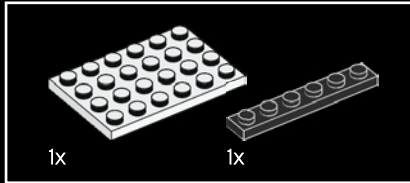
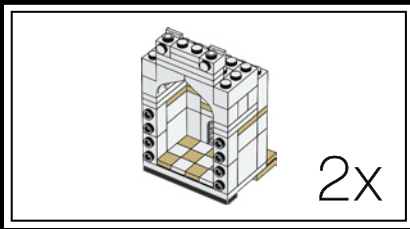

66

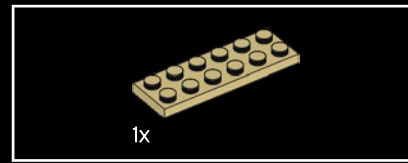
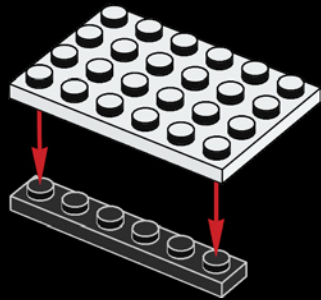

67

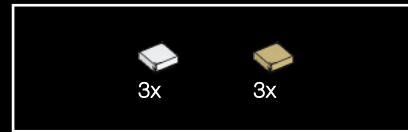
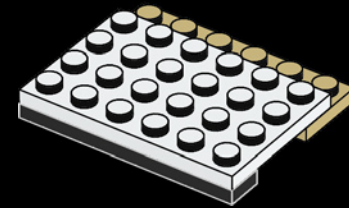

68

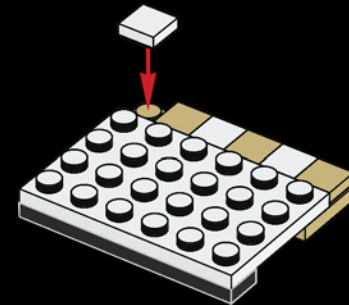

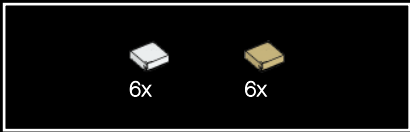

69

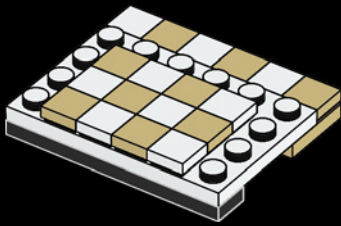

70

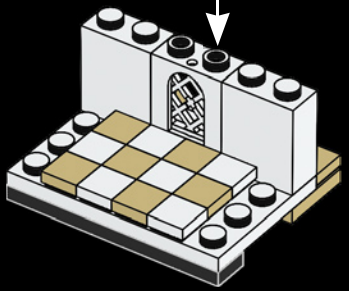
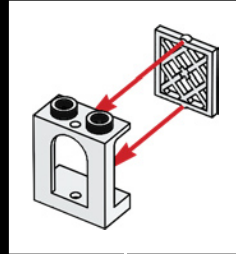



71

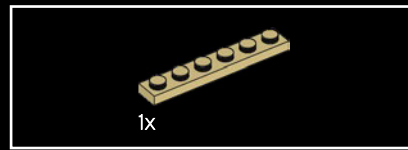
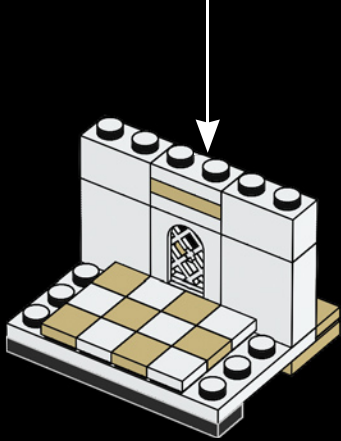
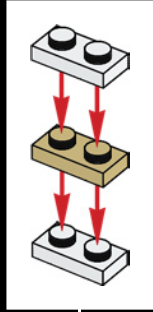

72

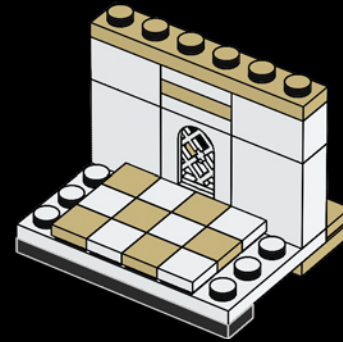

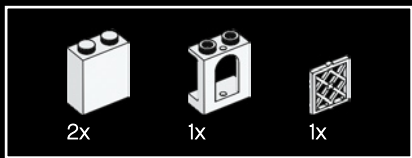

73

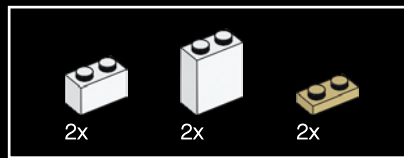
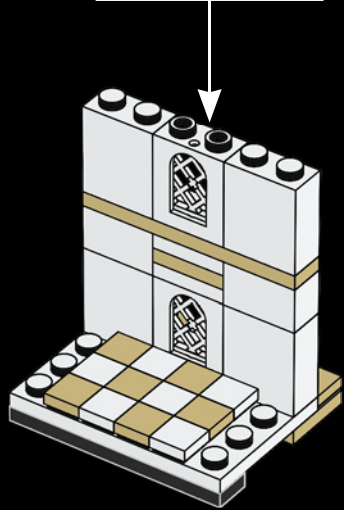
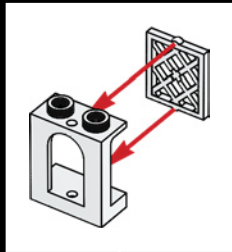

74

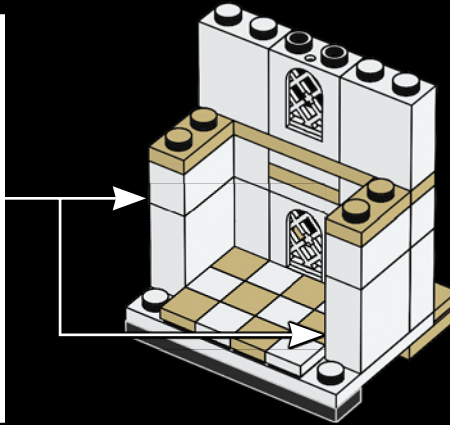
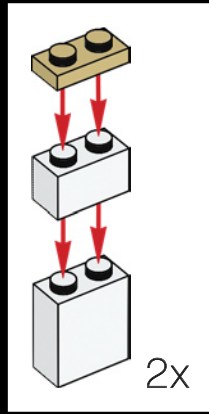

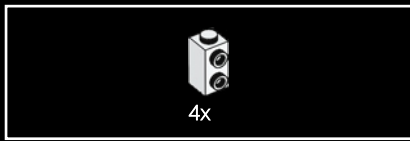

75

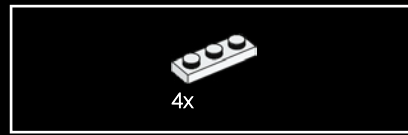
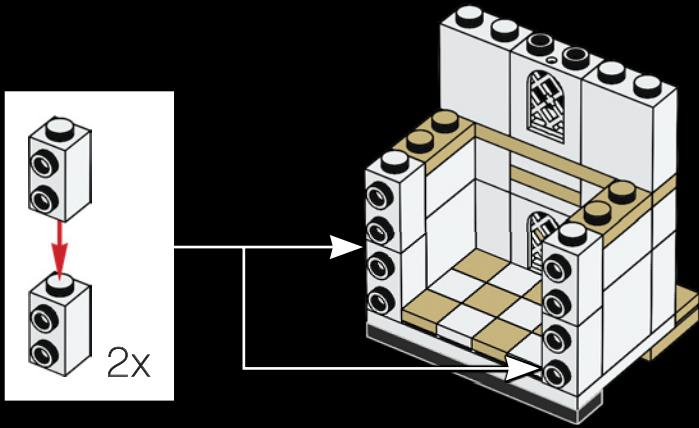

76

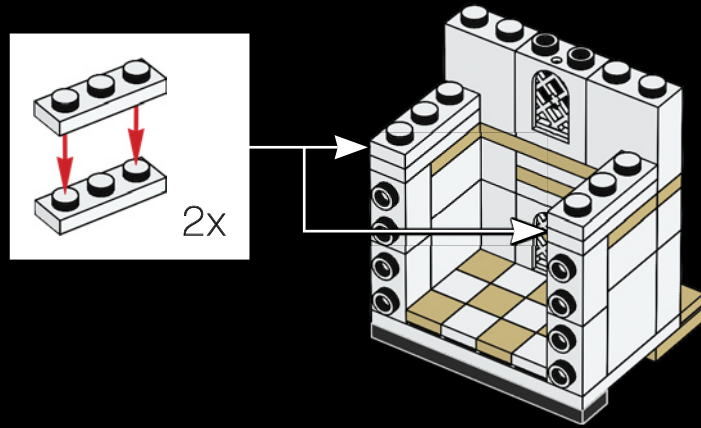

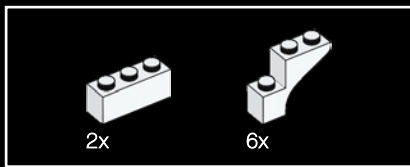

77

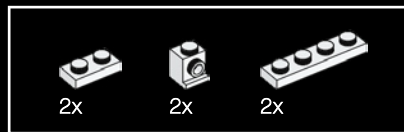
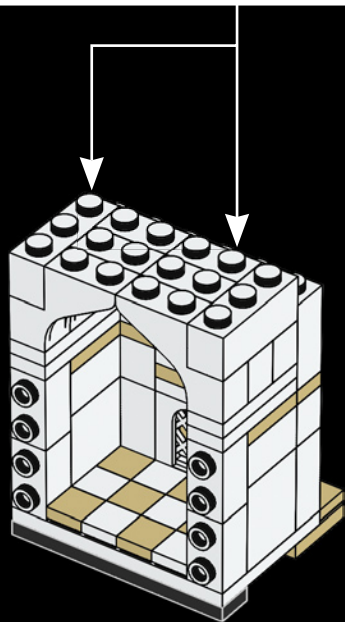
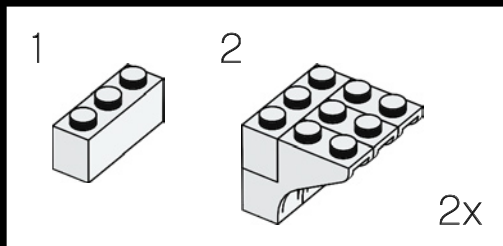

78

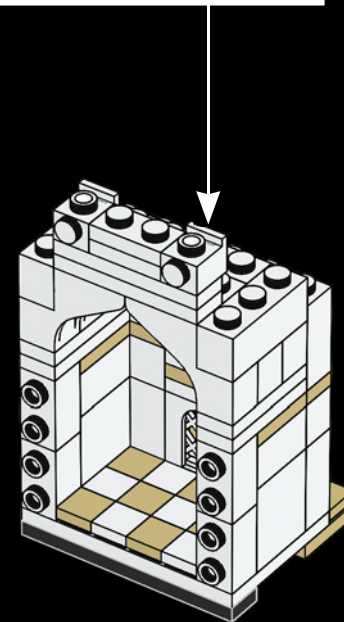
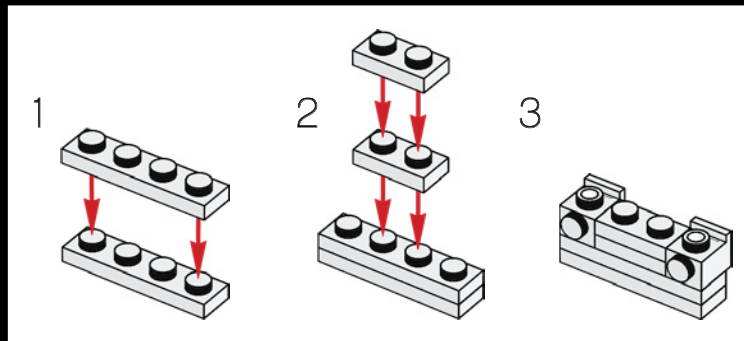

2x

79

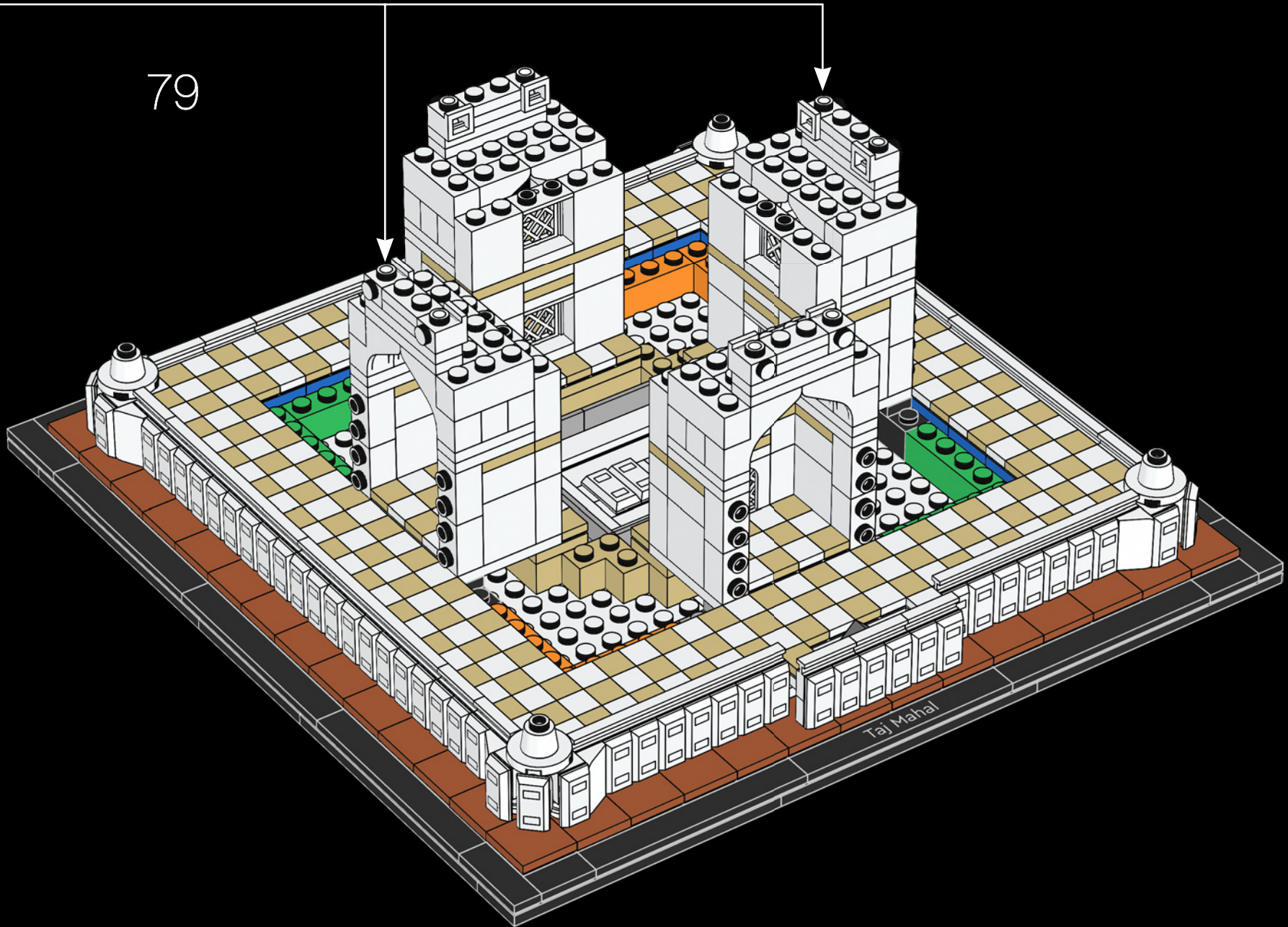

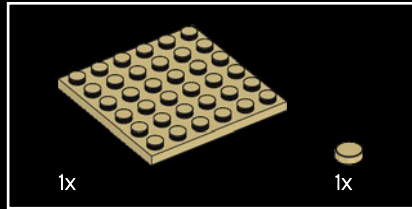
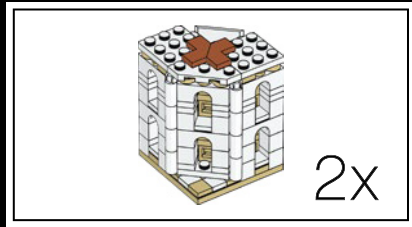
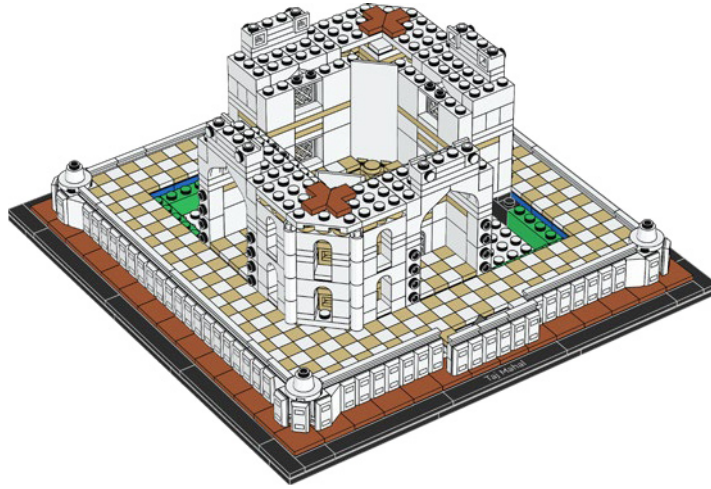
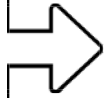

80

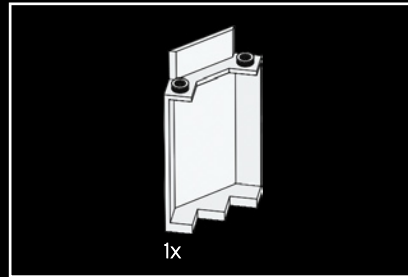
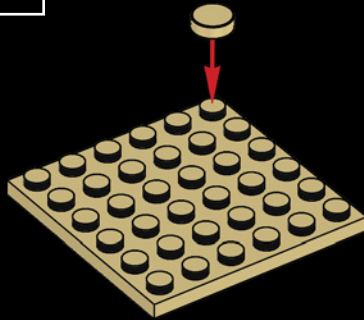

81

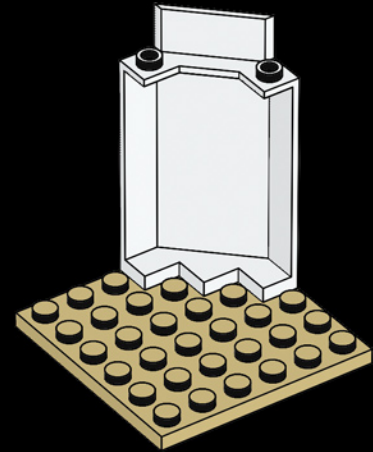



82

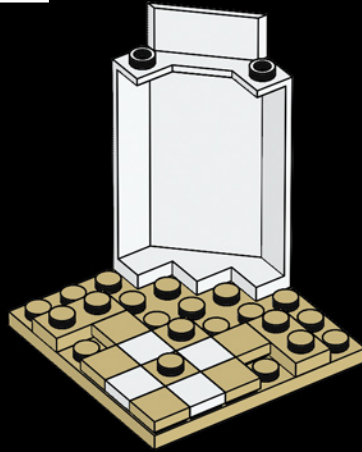

83

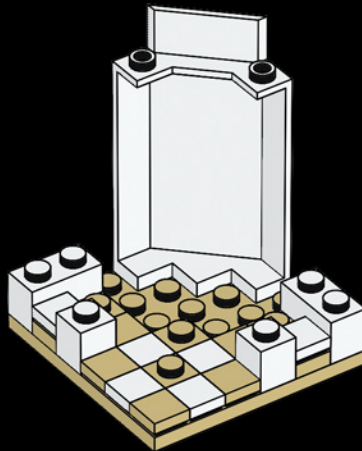

84

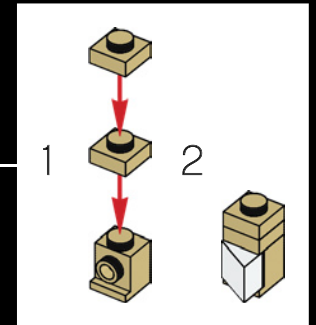
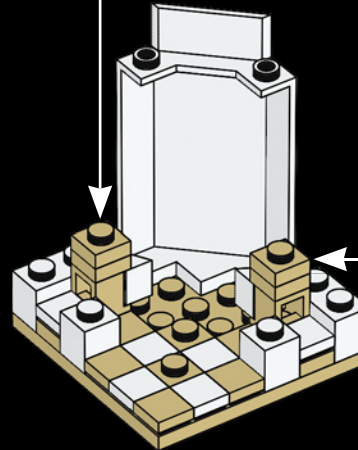
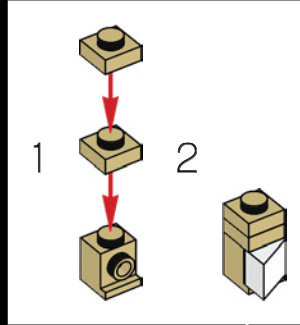

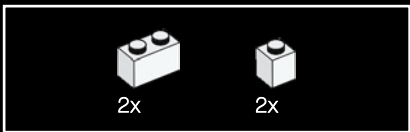

85

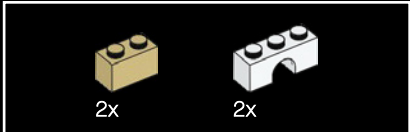
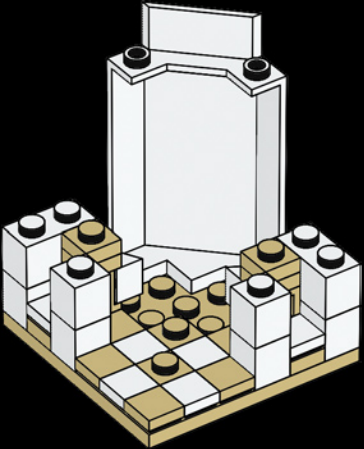

86

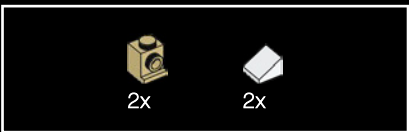
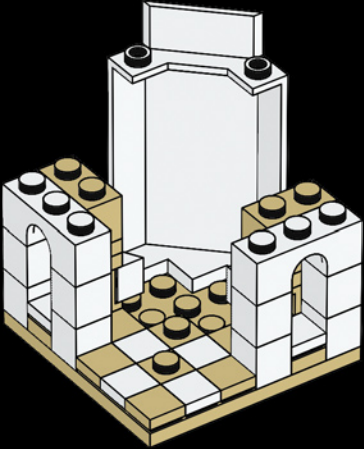

87

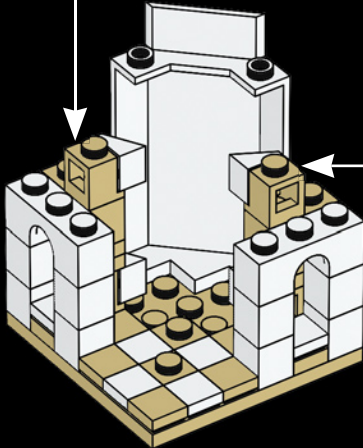
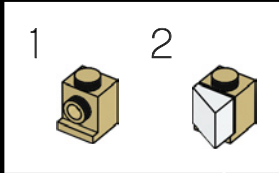
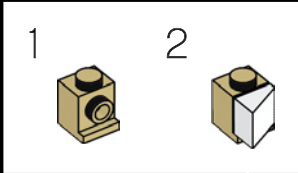



88

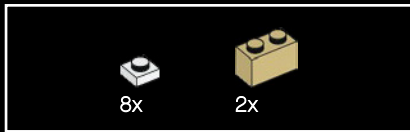
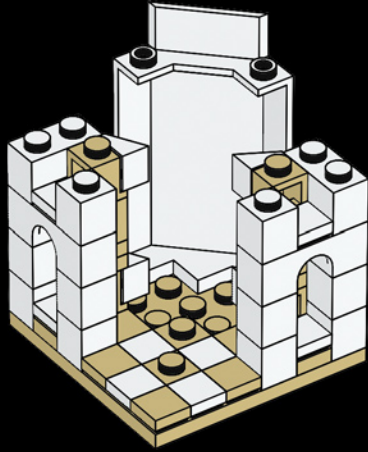

89

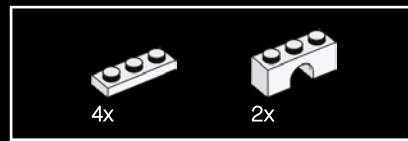
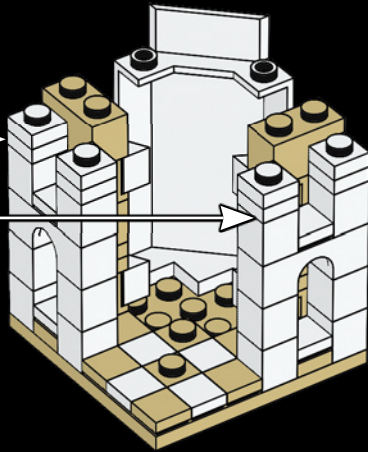
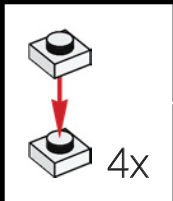

90

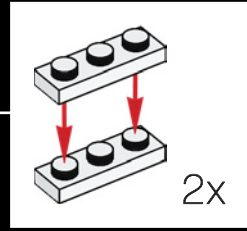
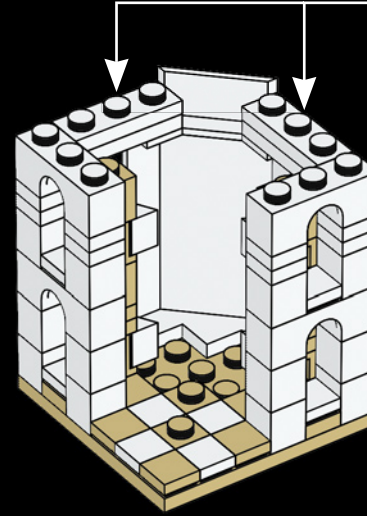

91

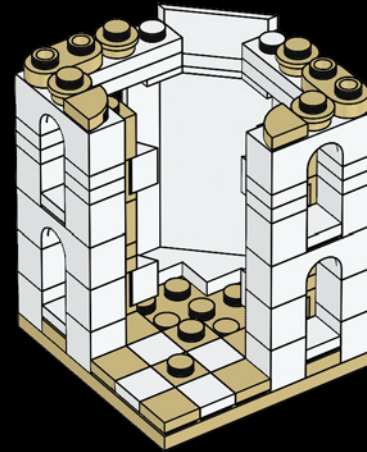

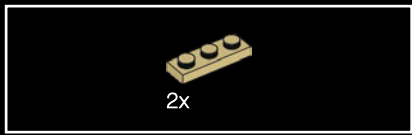

92

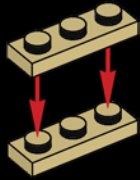

93

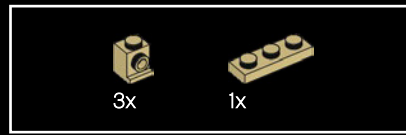
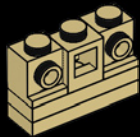

94

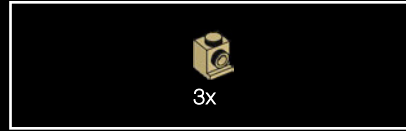
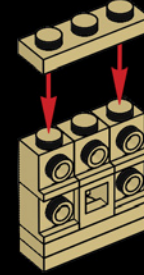

95

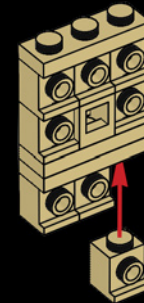

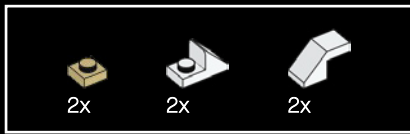

96

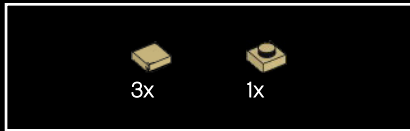
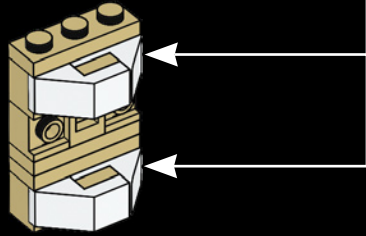
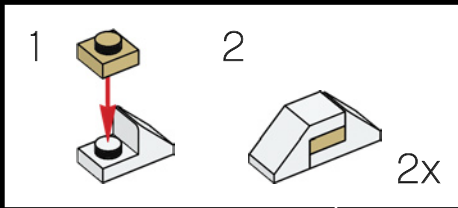

97

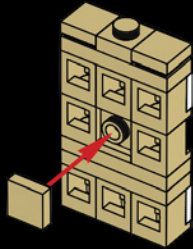

98

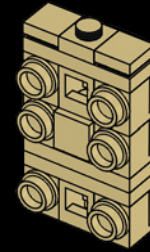

99

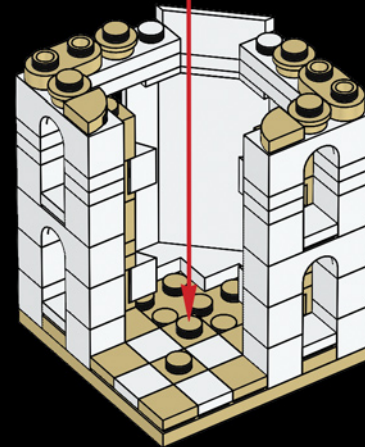
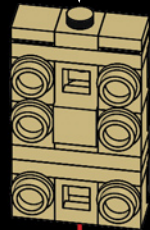

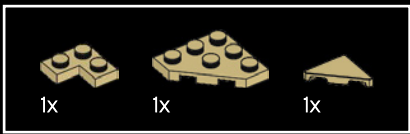

100

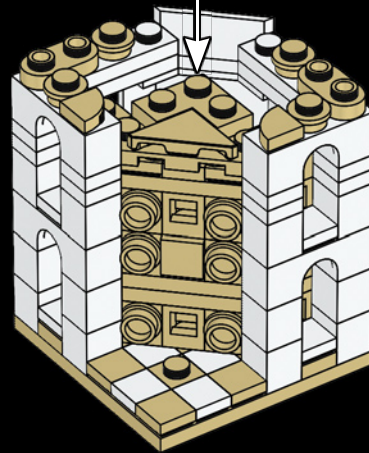
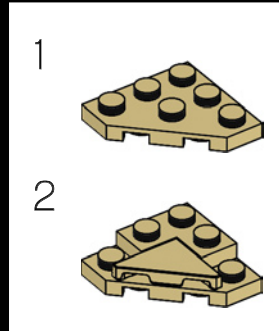



101

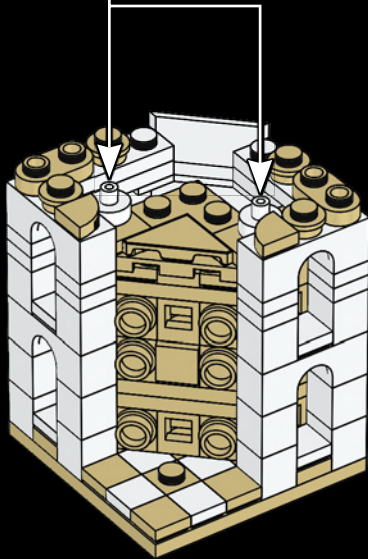
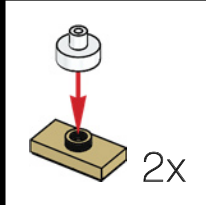

102

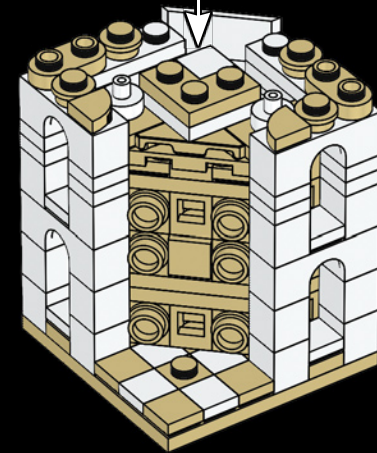
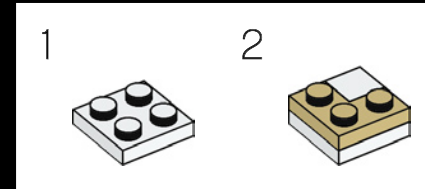

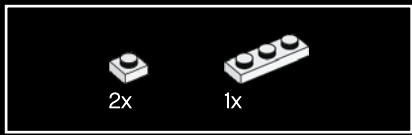

103

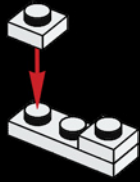

104

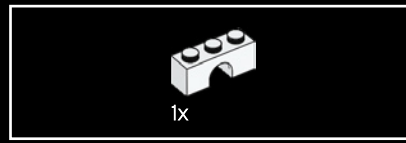
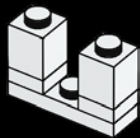

105



106

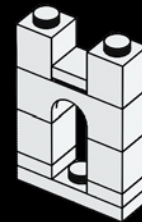



107

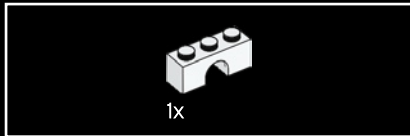
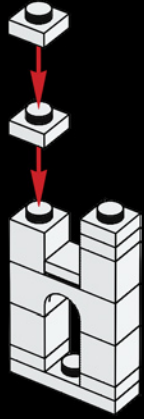

108

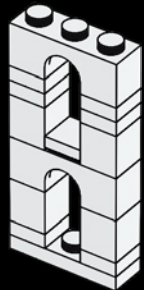

109



110

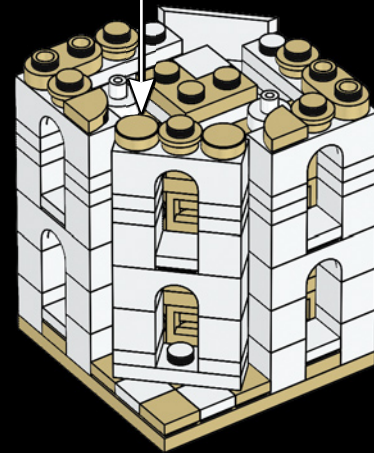

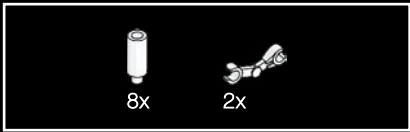

111

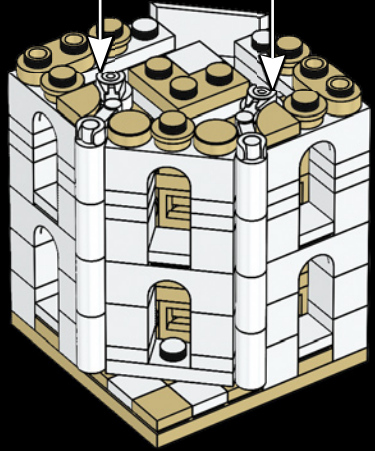
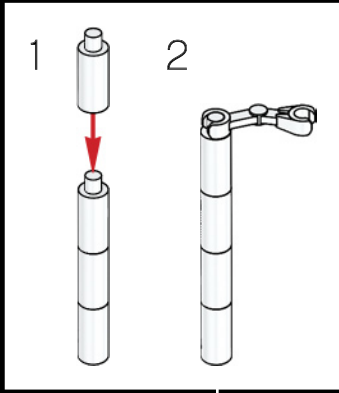
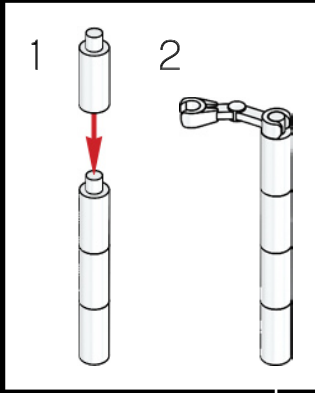

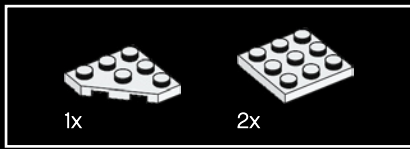

112

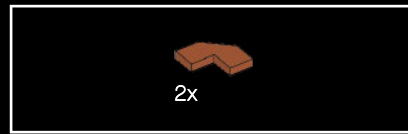
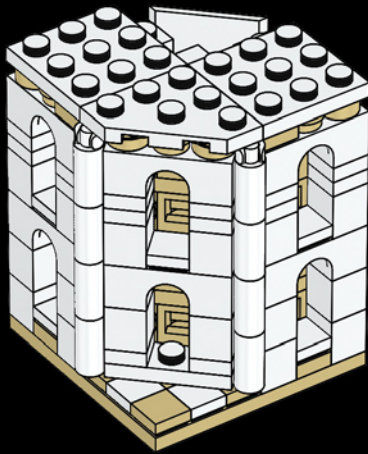

113

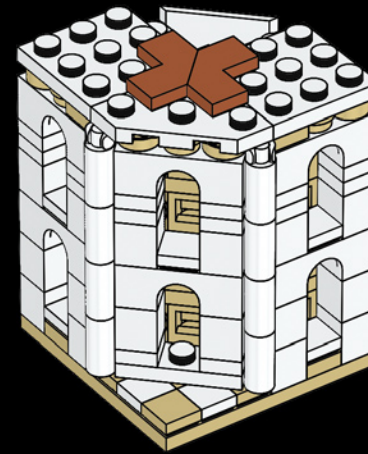

2x

114

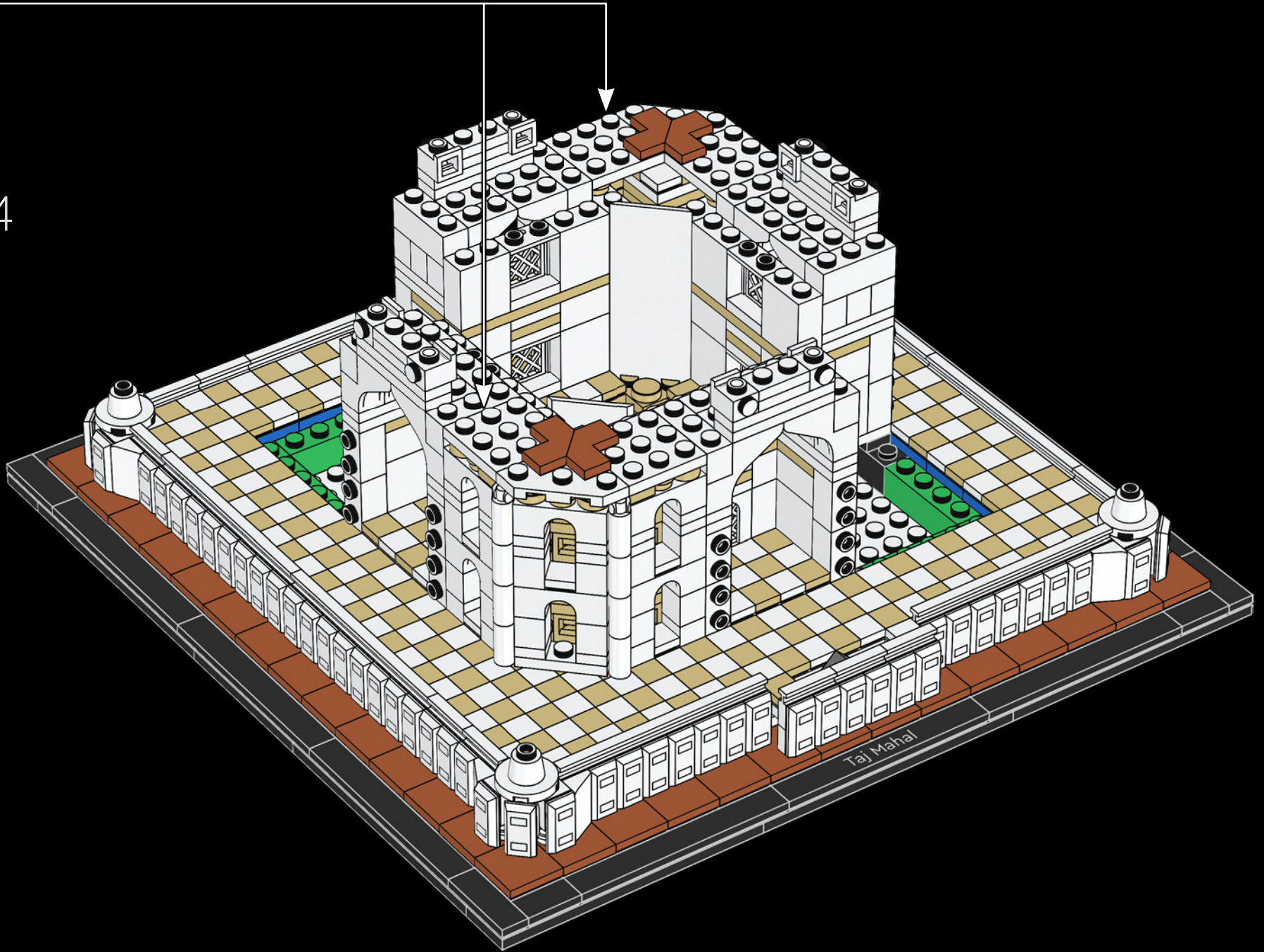

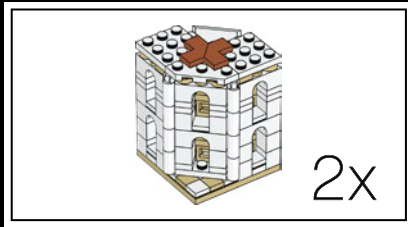
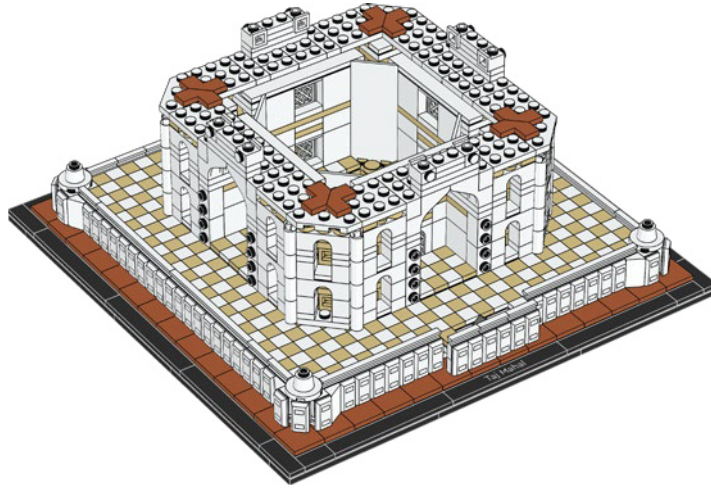
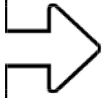

2x

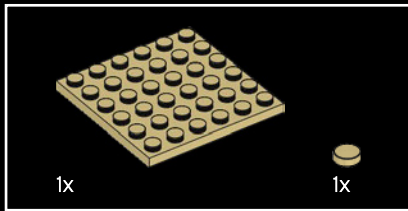

1x

1x

115

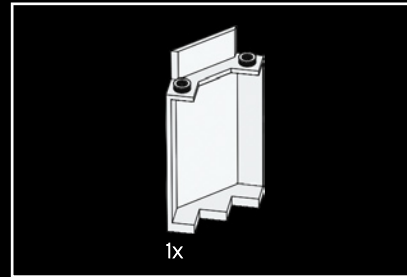
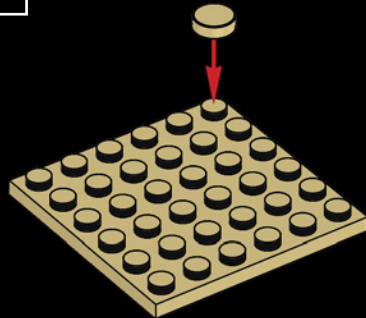

1x

116

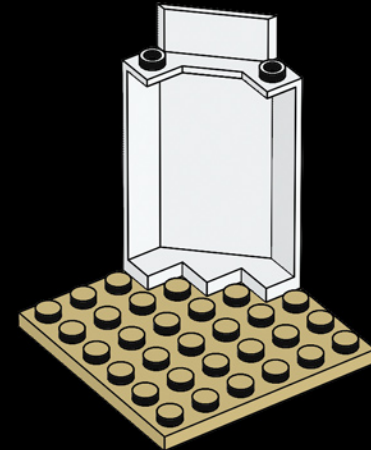



117

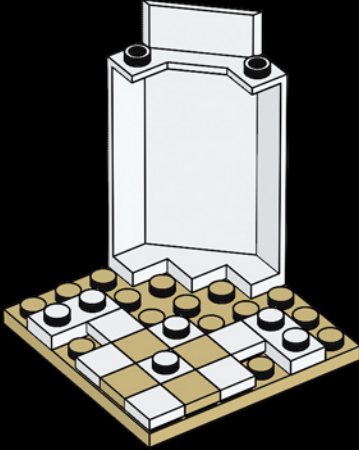

118

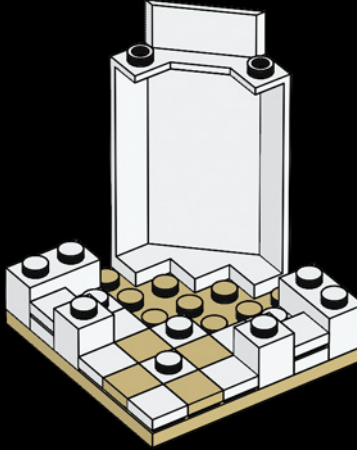



119

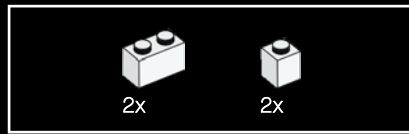
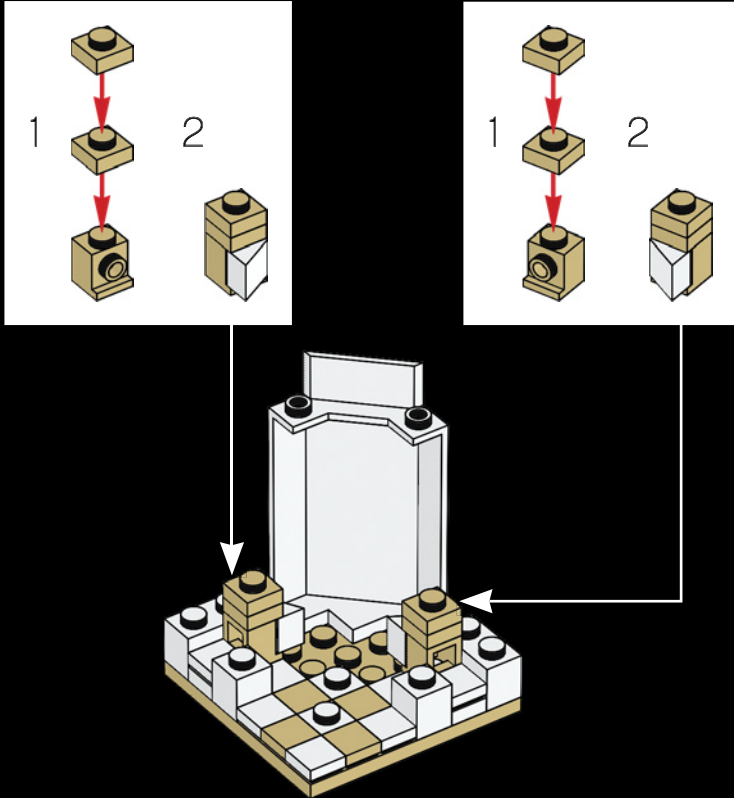

120

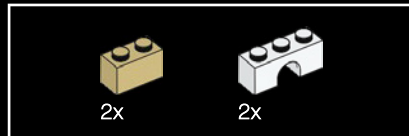
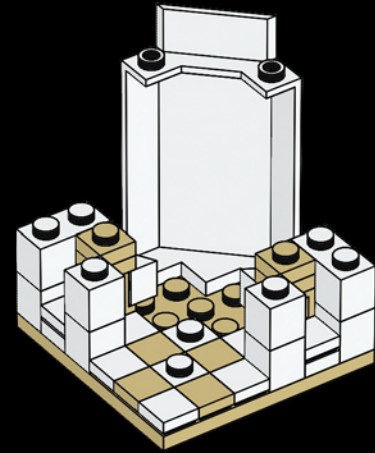

121

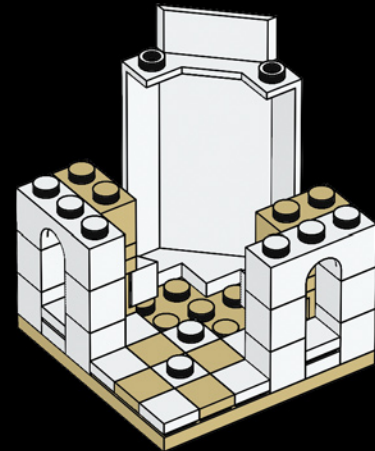

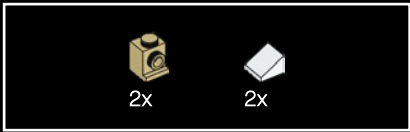

122

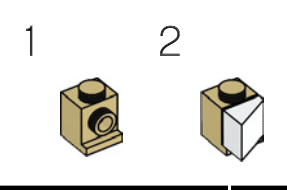

2

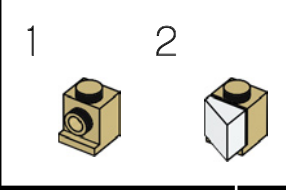

2

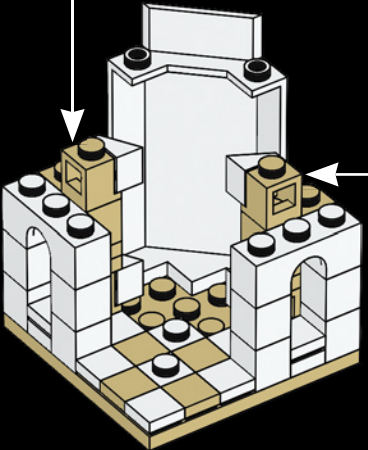

123

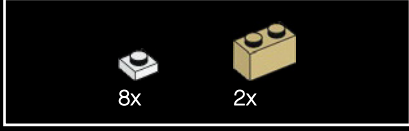
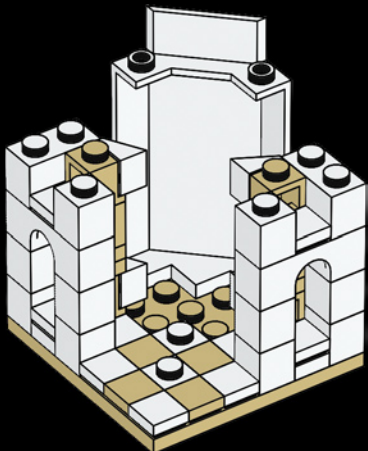

124

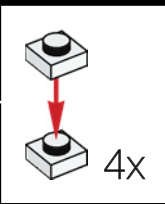
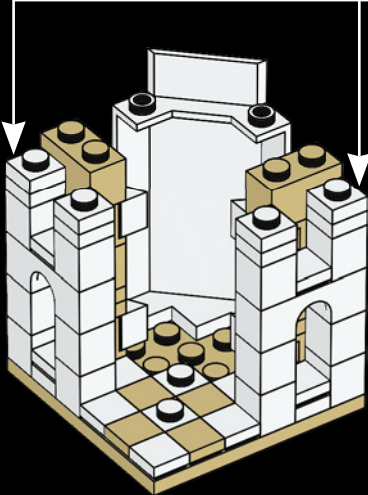

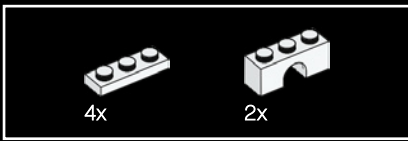

125

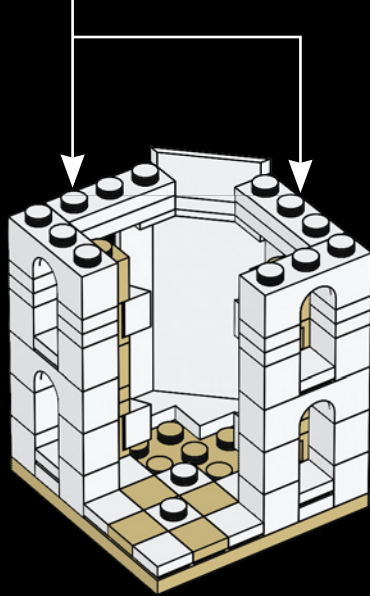
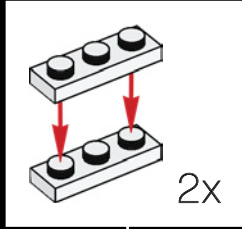

126

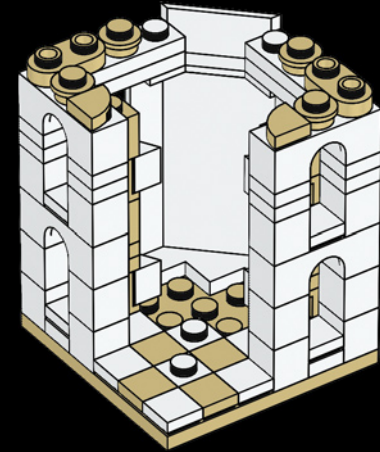



127

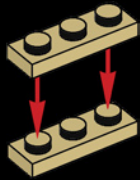

128

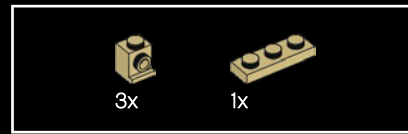
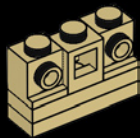

129

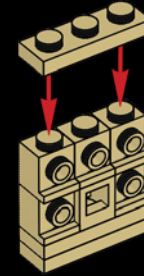

130

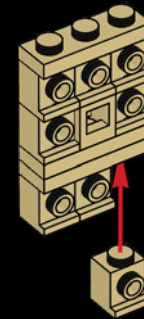



131

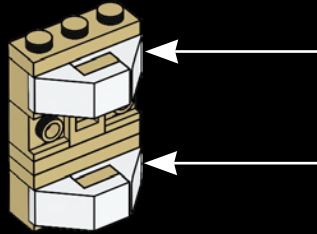
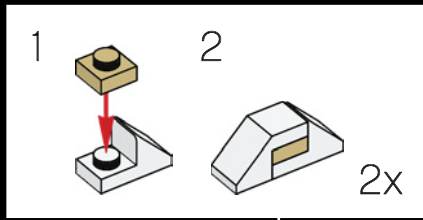

132

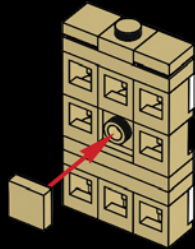

133

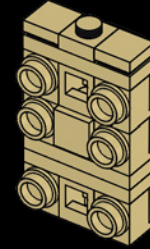

134

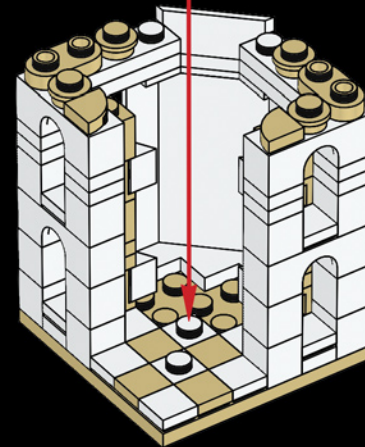
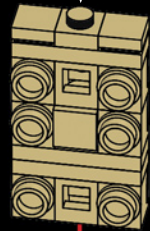

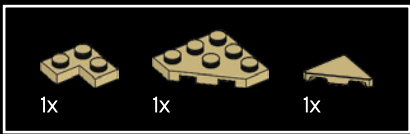

135

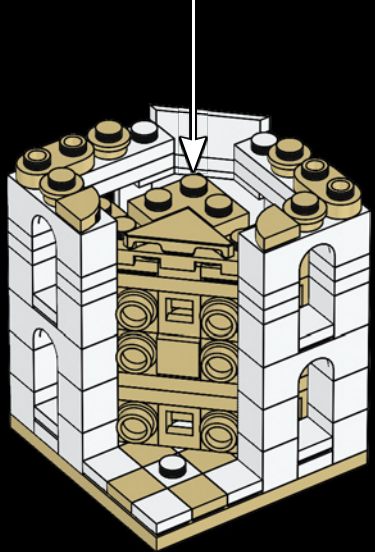
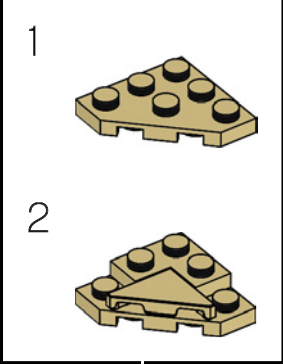



136

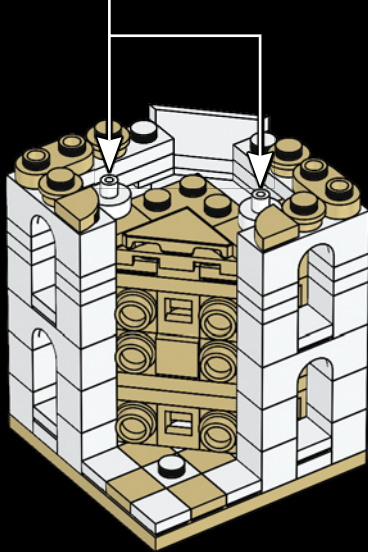
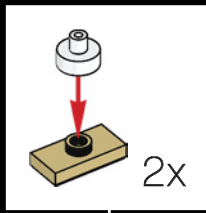

137

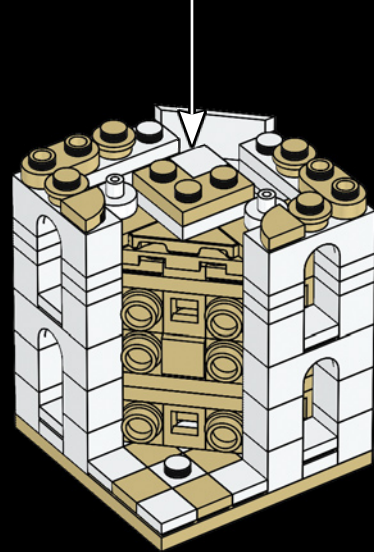
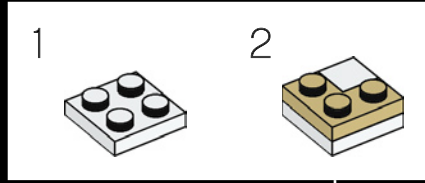

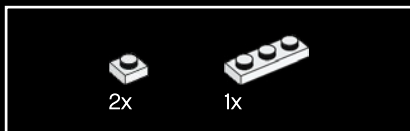

138

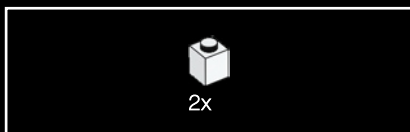
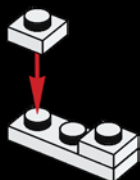

139

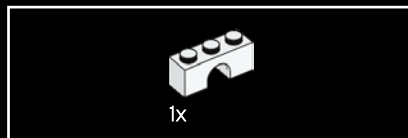

140

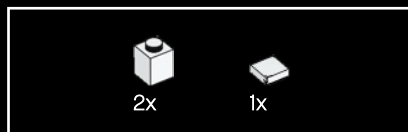

141





142

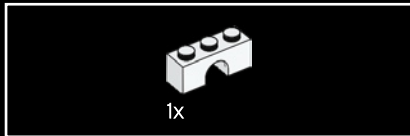
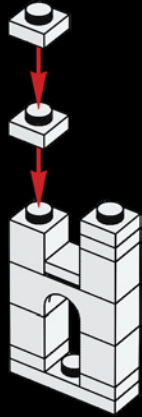

143

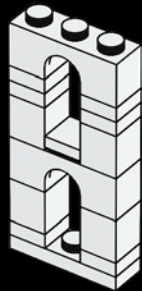

144



145

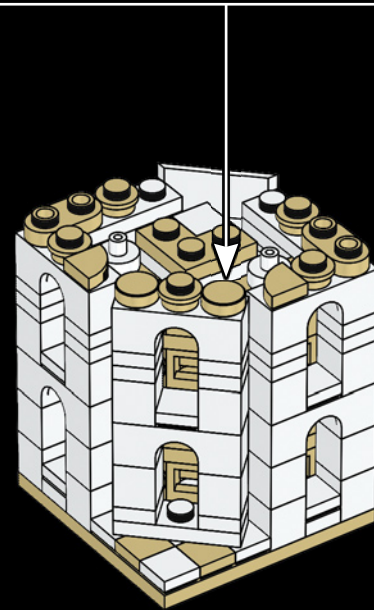

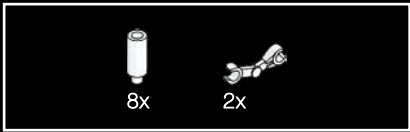

146

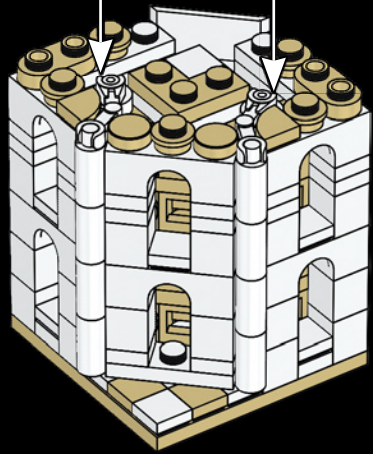
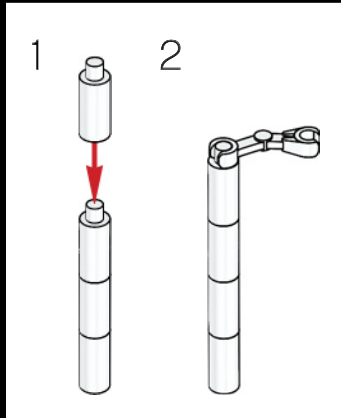
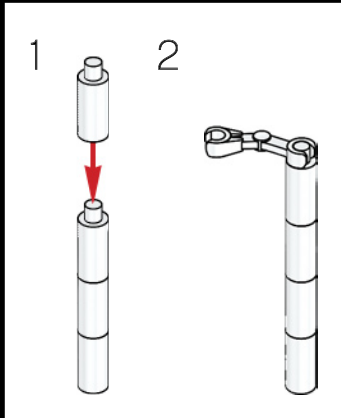

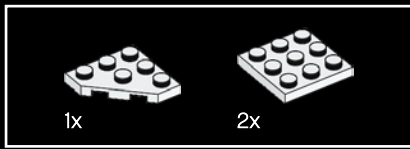

147

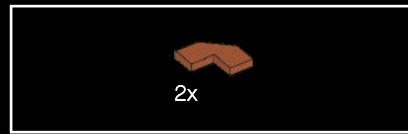
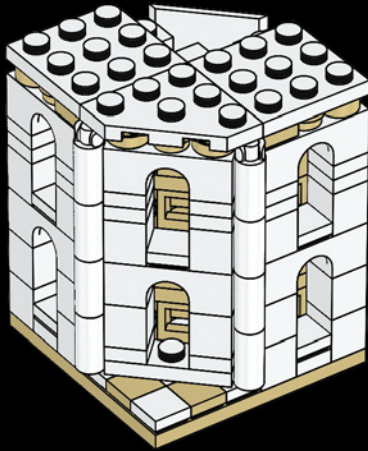

148

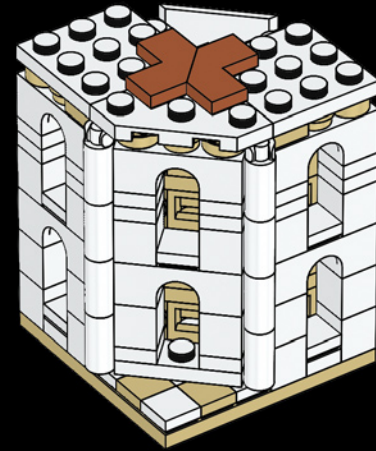

2x

149

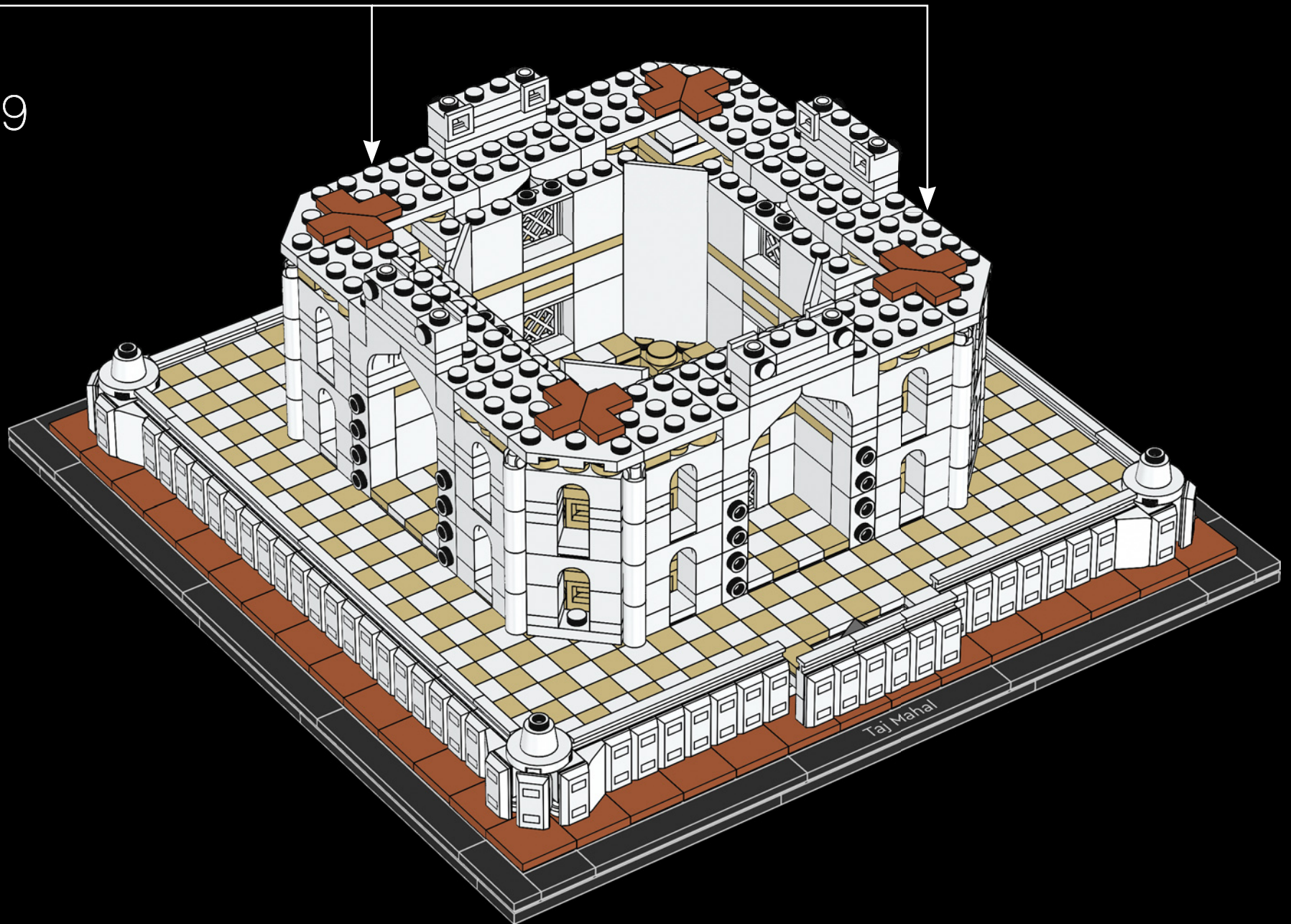

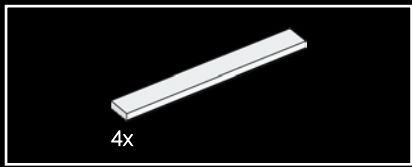

150

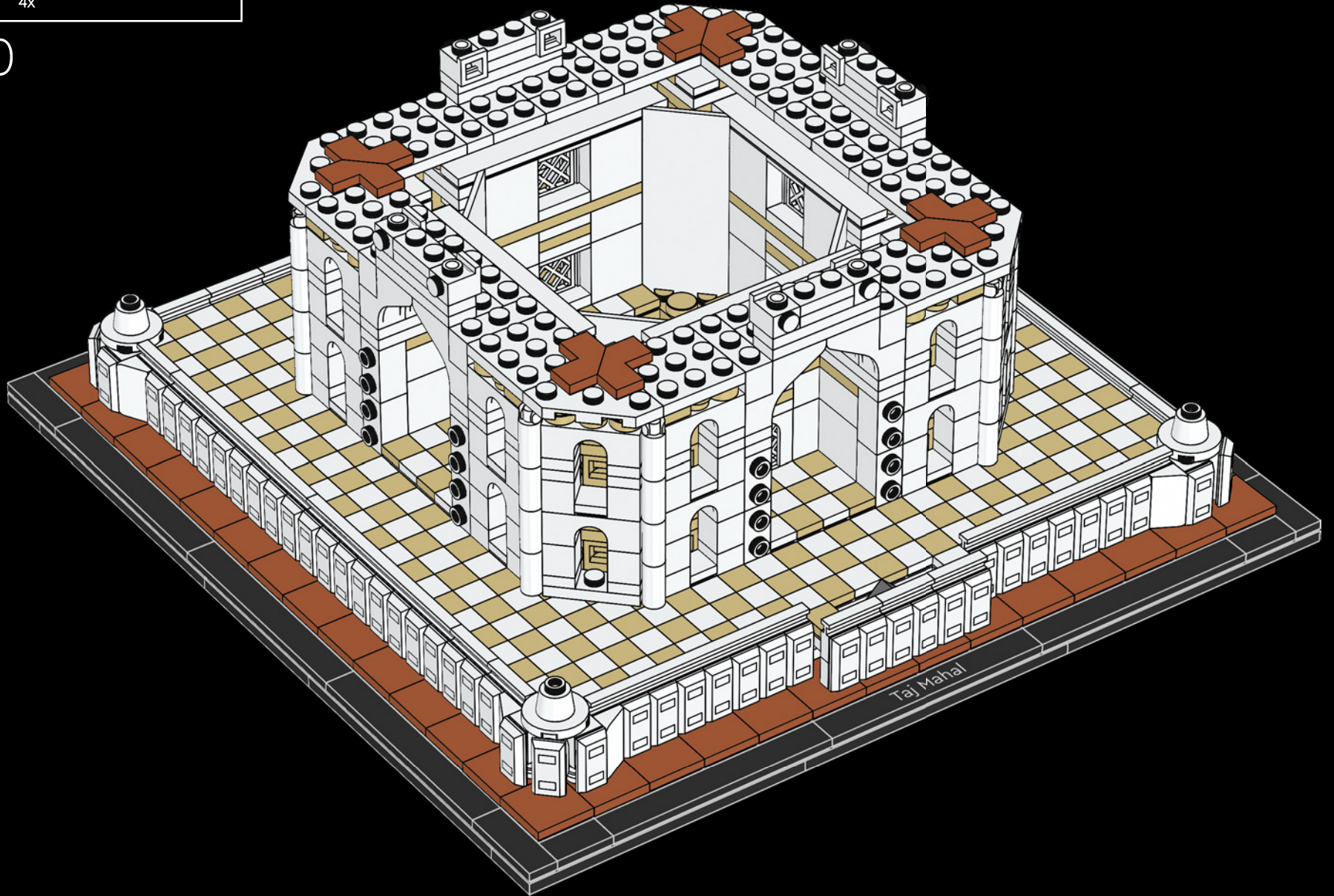

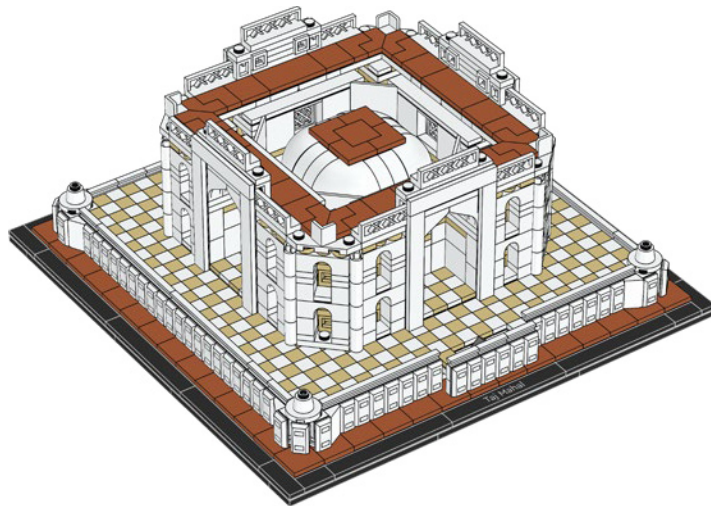
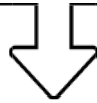

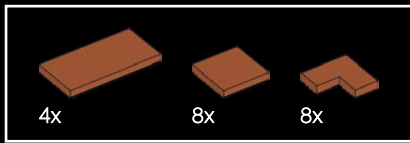

151

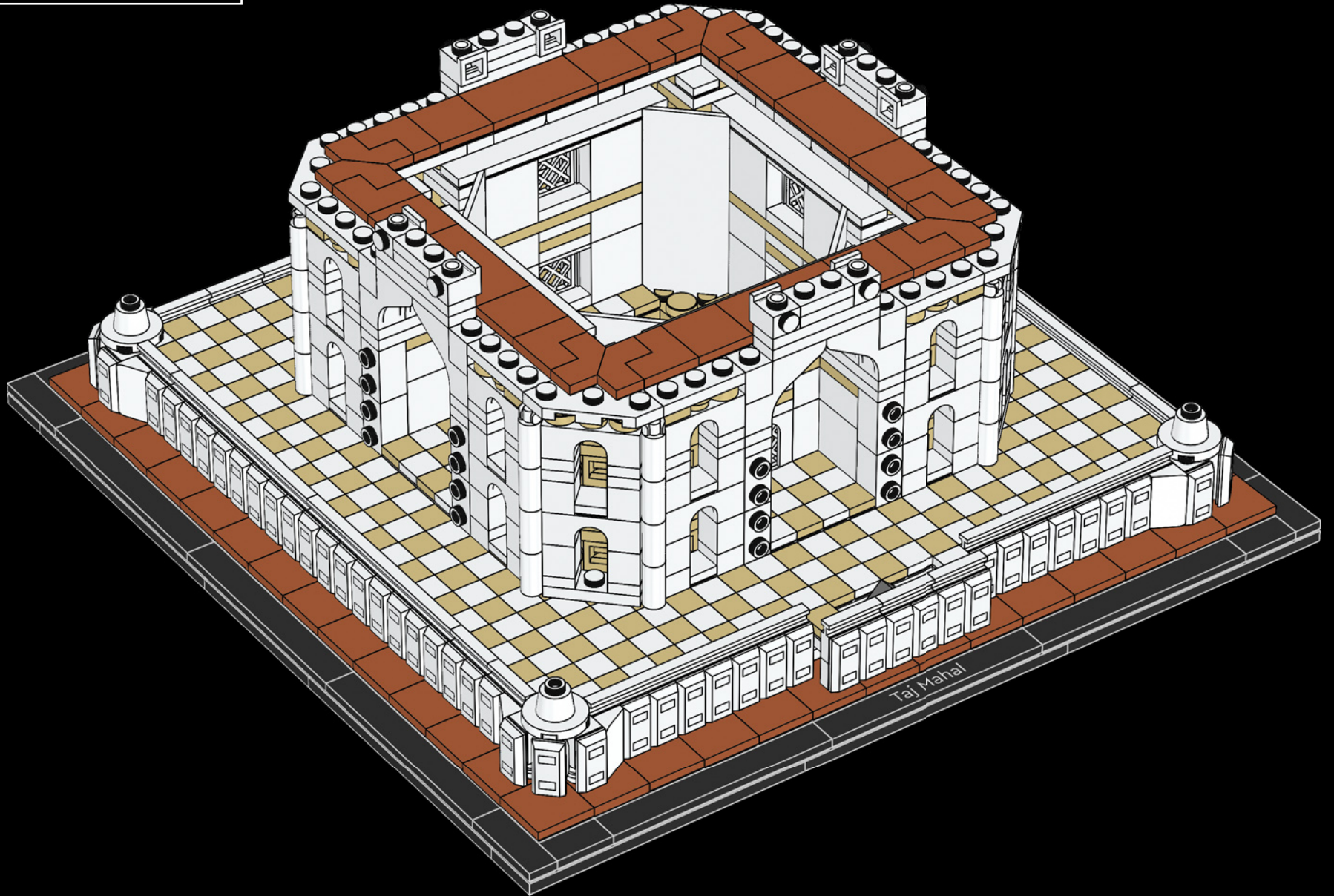

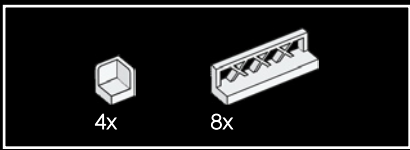

152

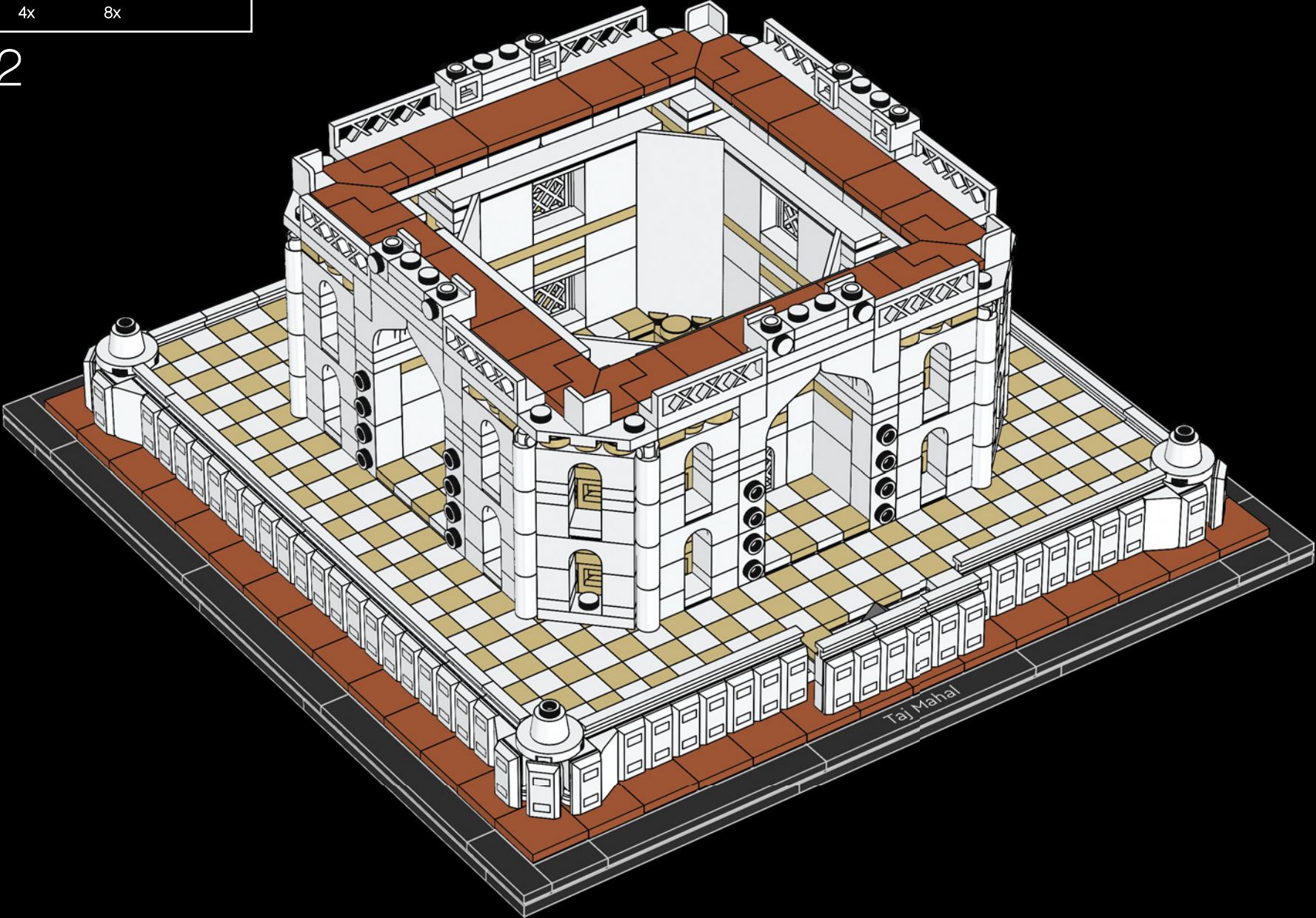

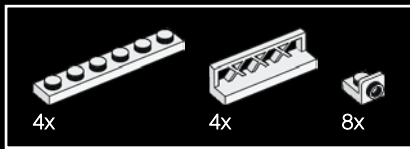

153

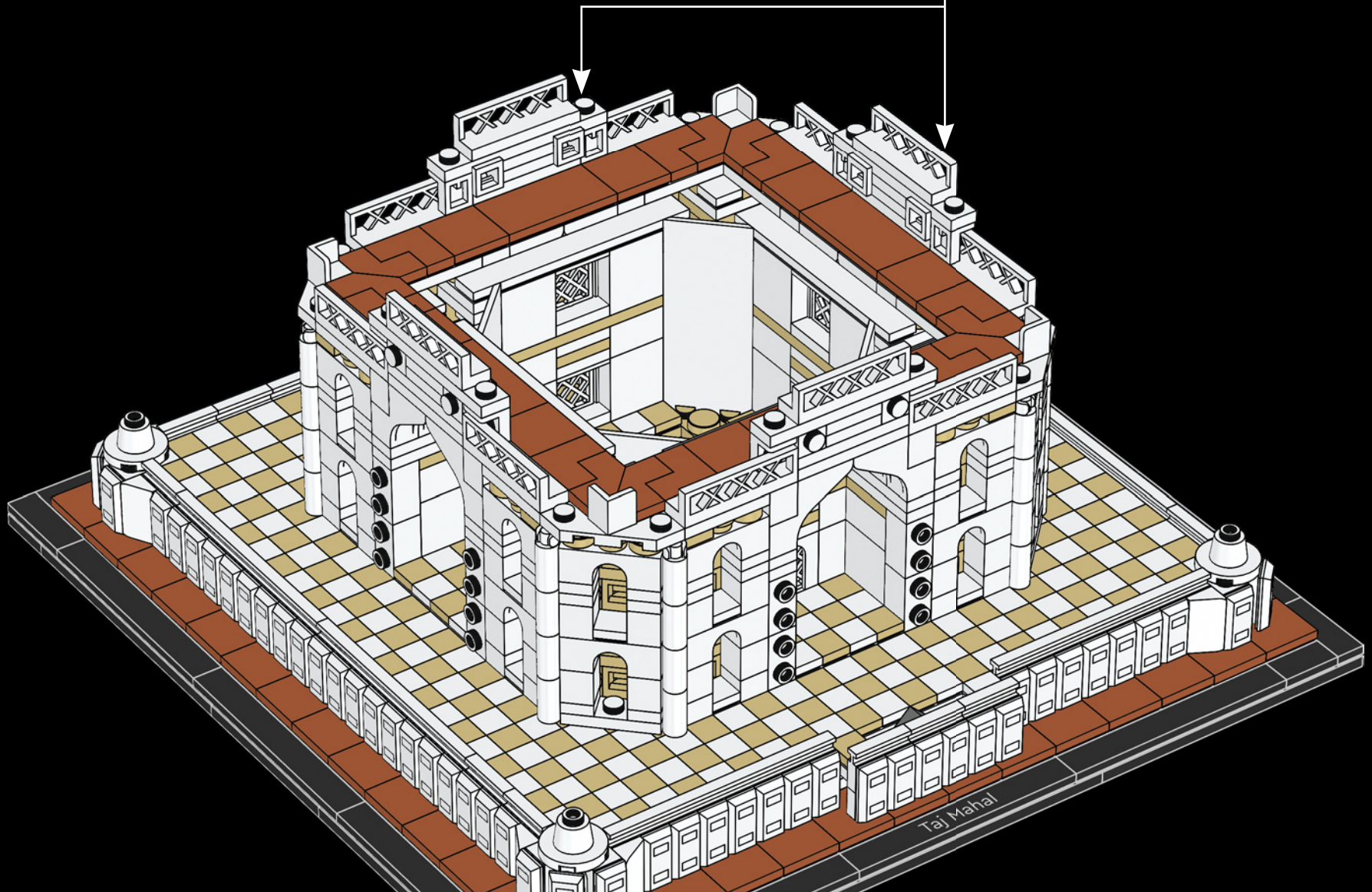
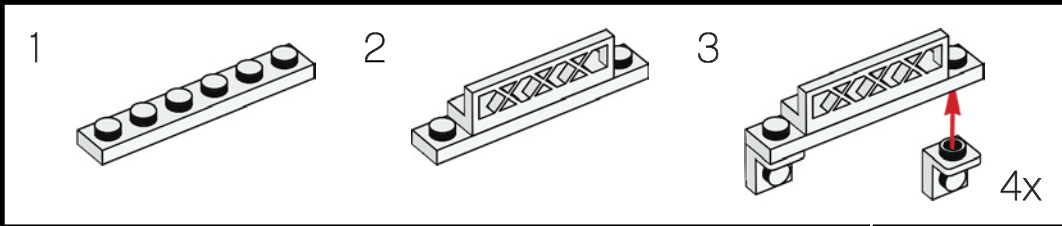

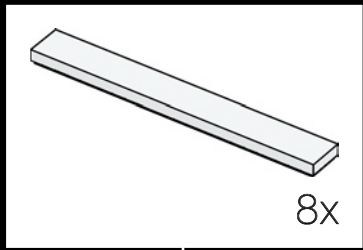
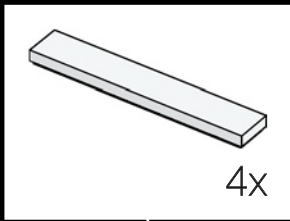
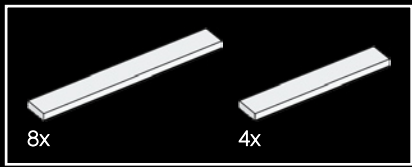

154

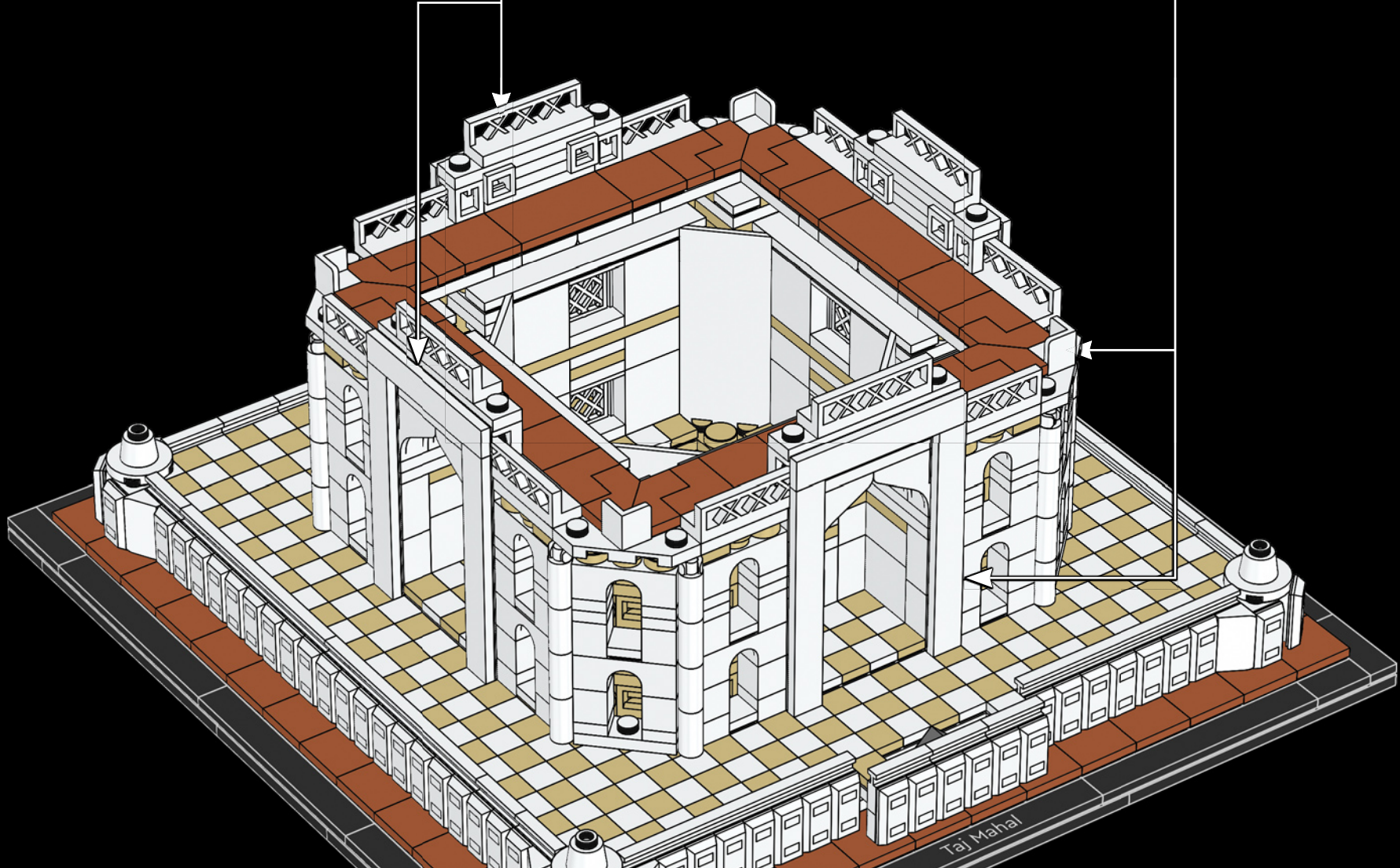

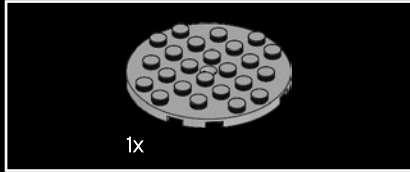

155

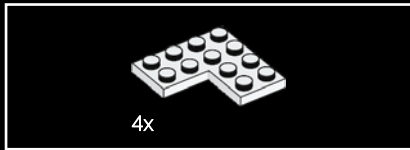
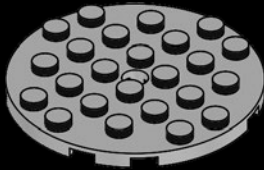

156

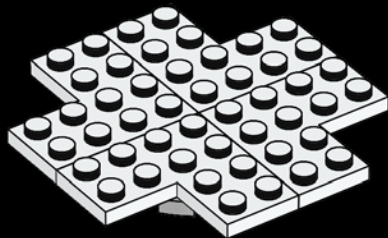

157

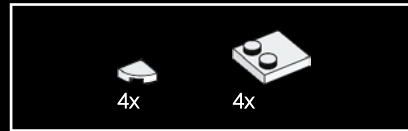
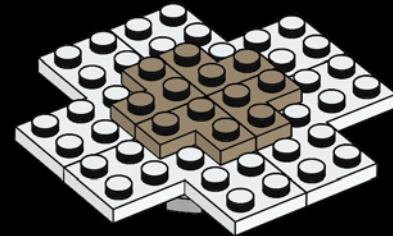

158

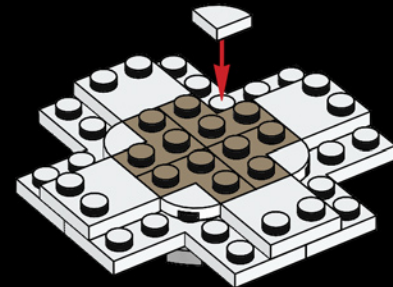



159

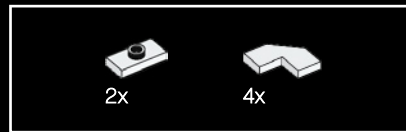
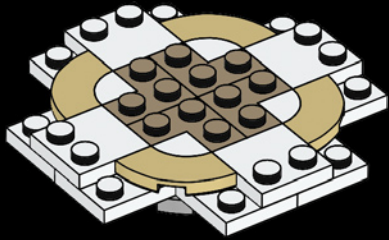

160

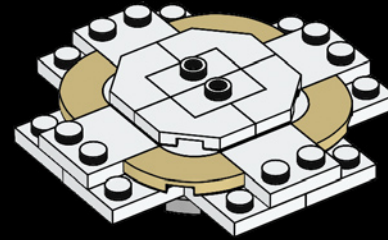



161

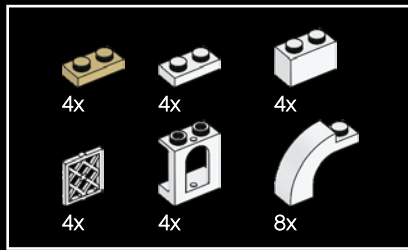
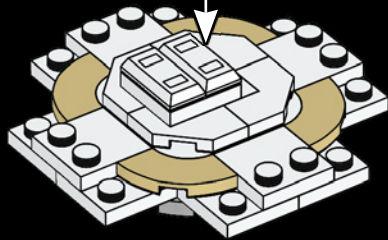
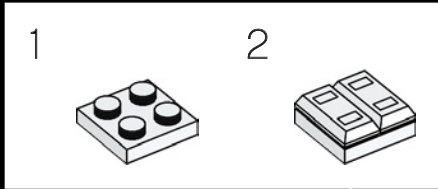

162

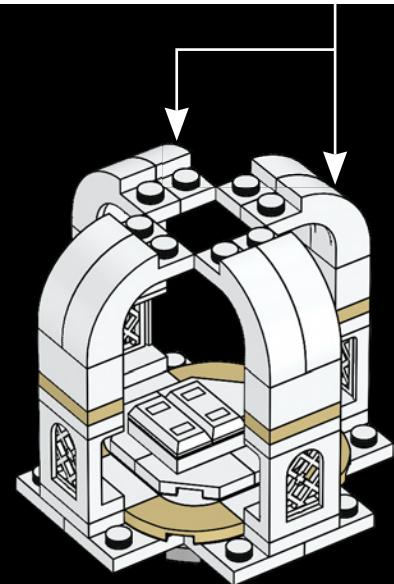
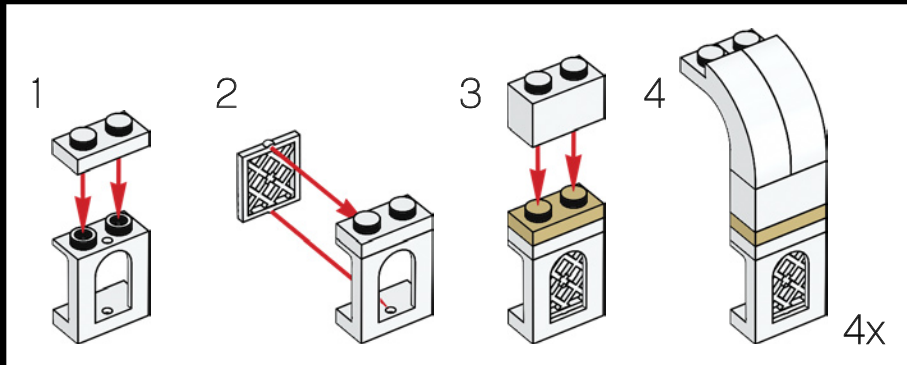

Shah Jahan's cenotaph is beside Mumtaz's and is the only visible asymmetric element in the entire complex.



163

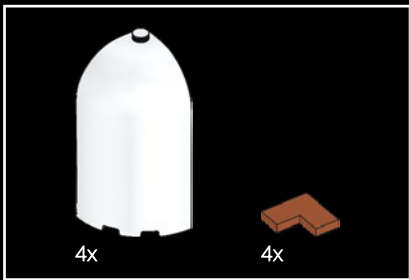
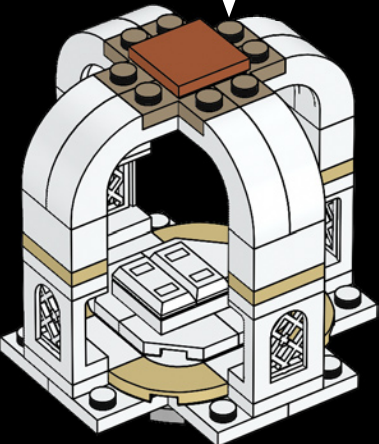
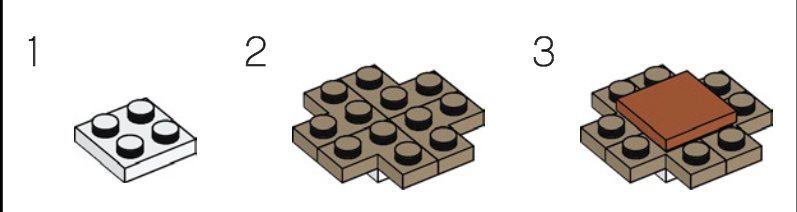

164

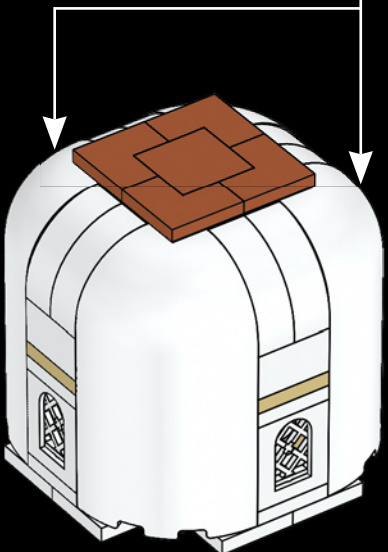
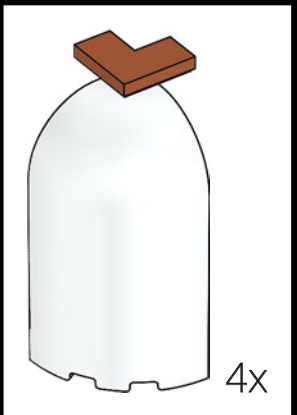

165

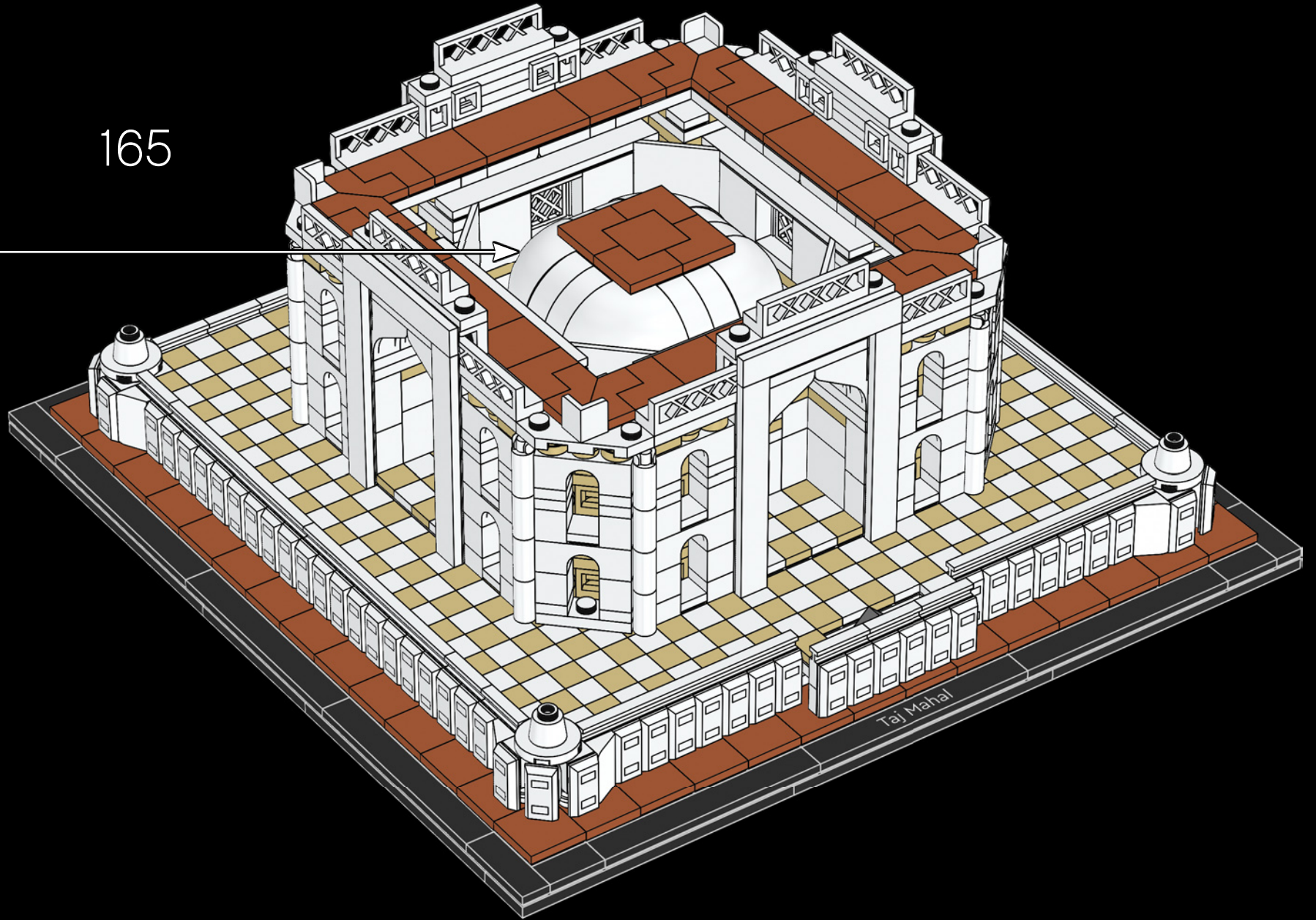

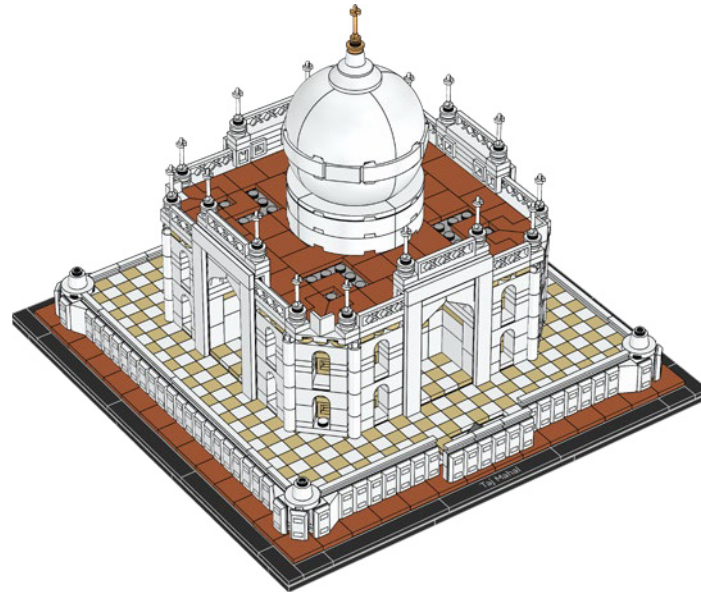
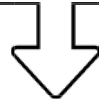

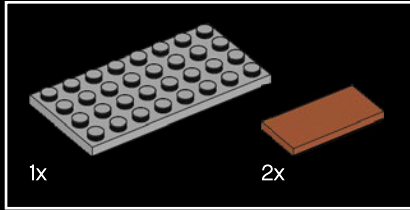
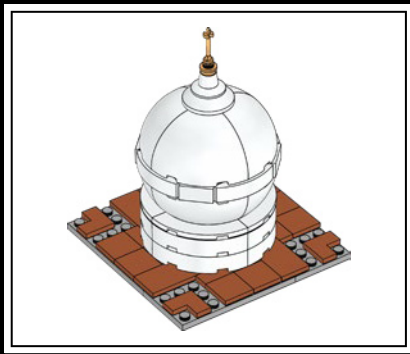

166

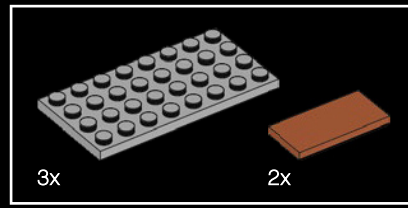
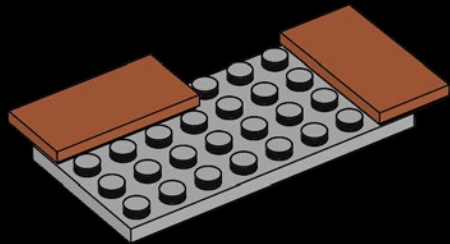

167

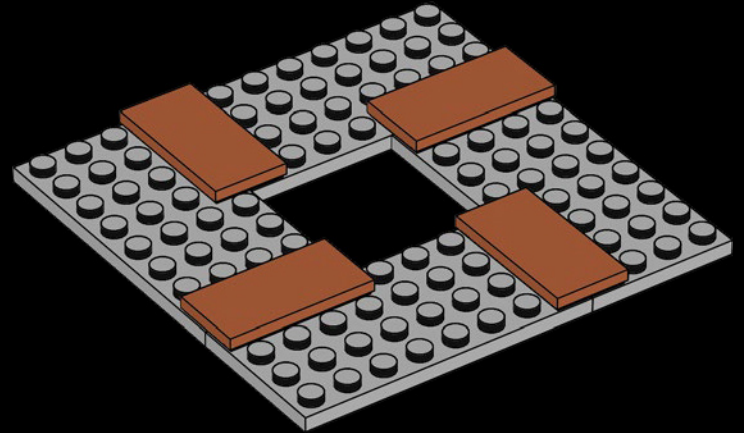

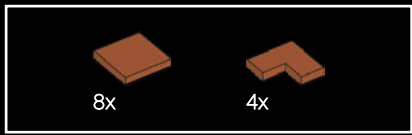

168

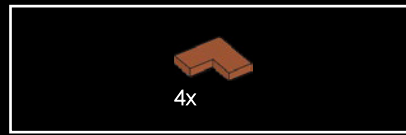
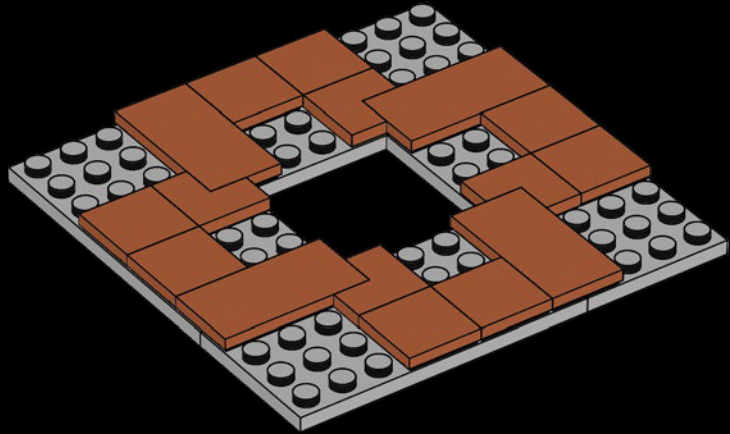

169

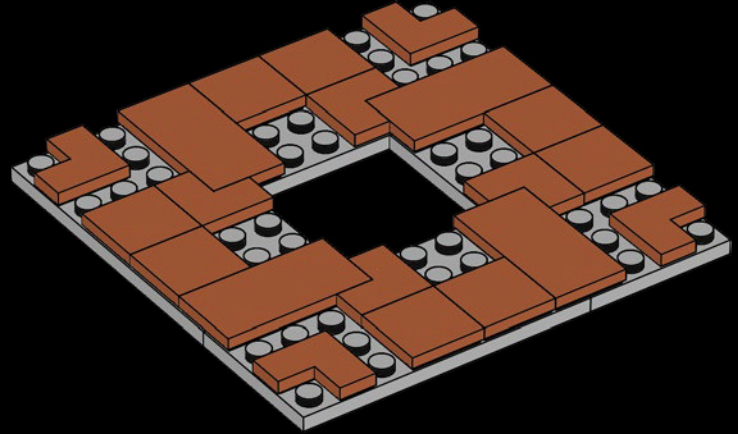

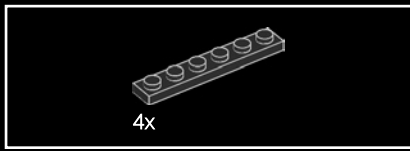

170

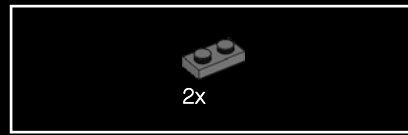
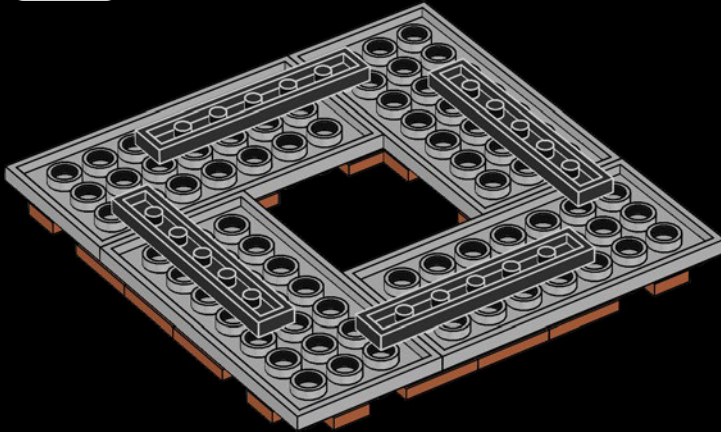

171

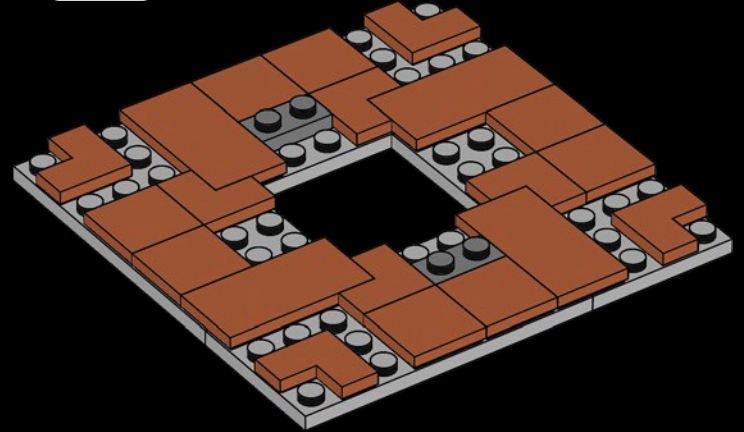

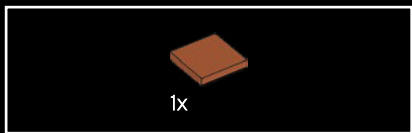

172

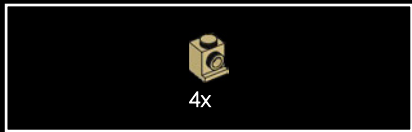
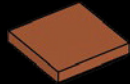

173

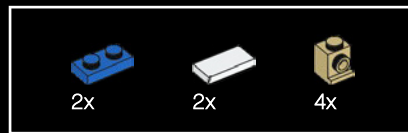

174

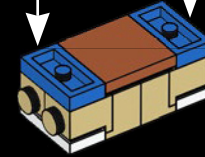
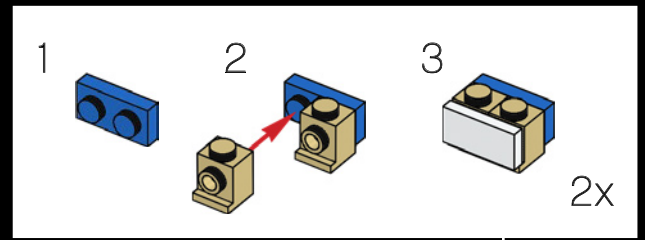

175

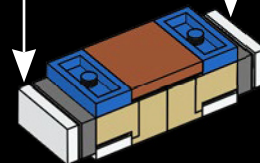
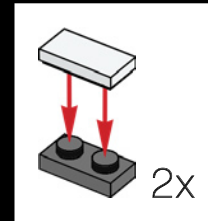

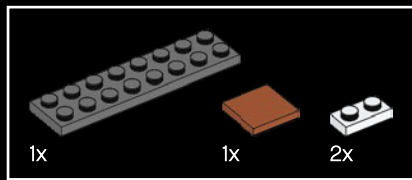

176

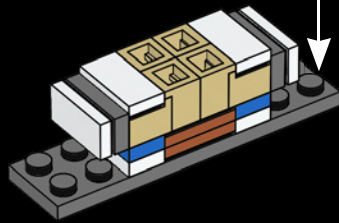
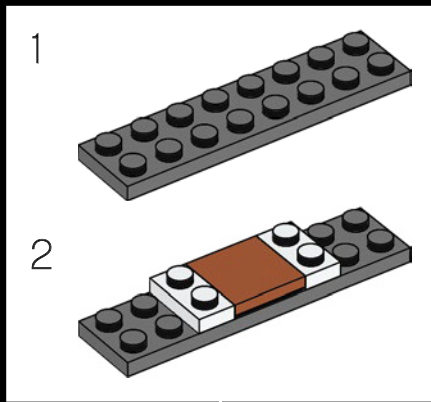

177

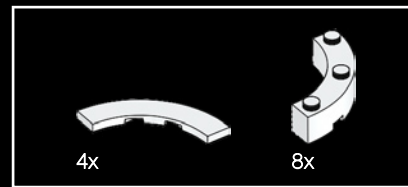
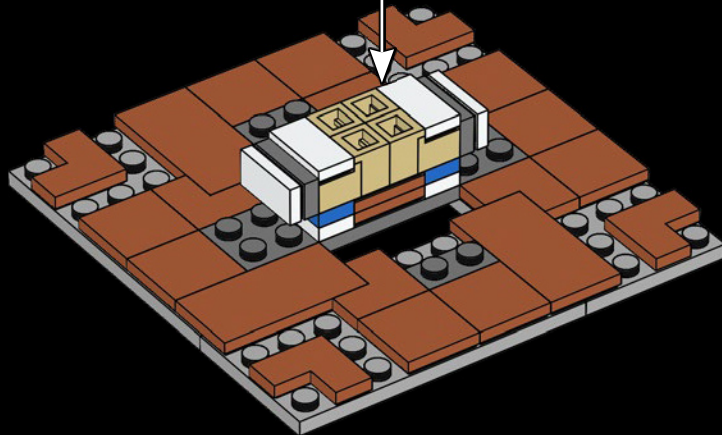

178

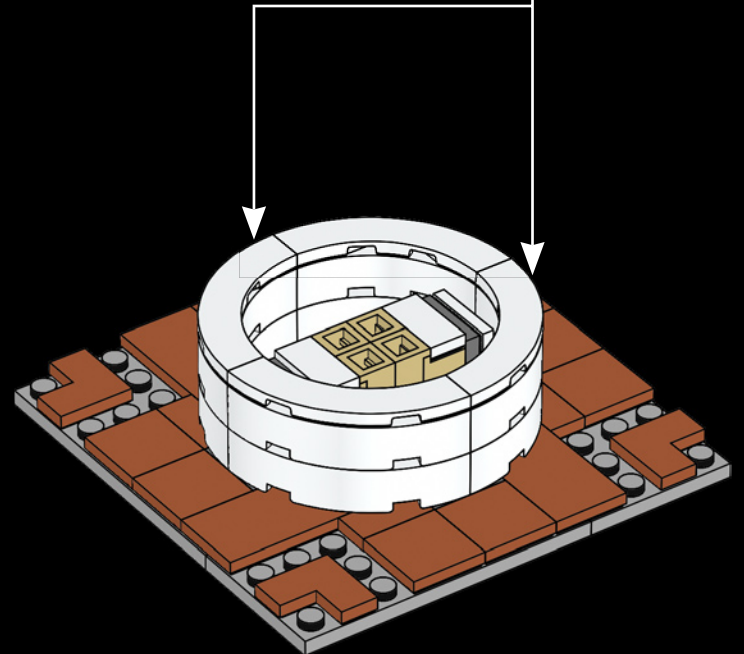
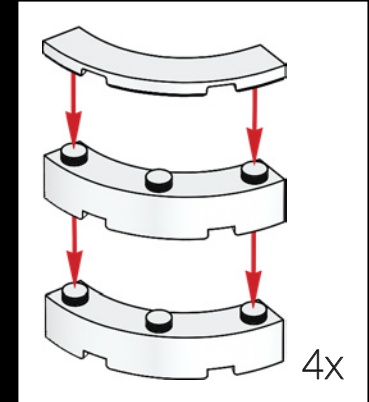

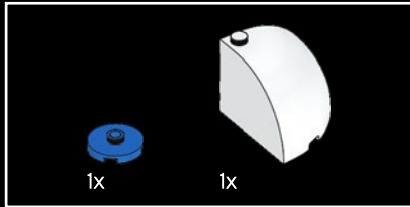

179

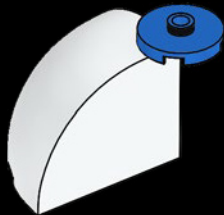

180

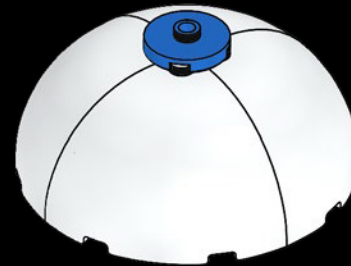

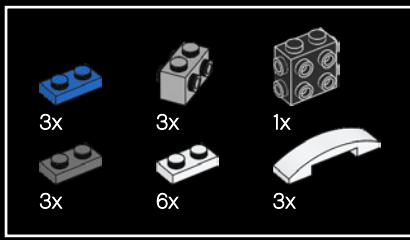

181

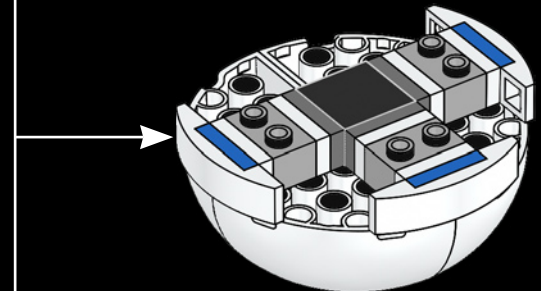
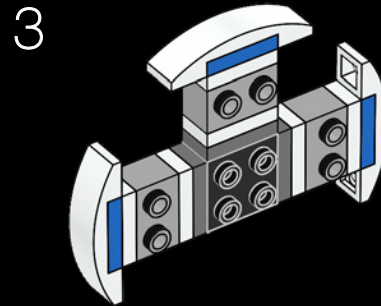
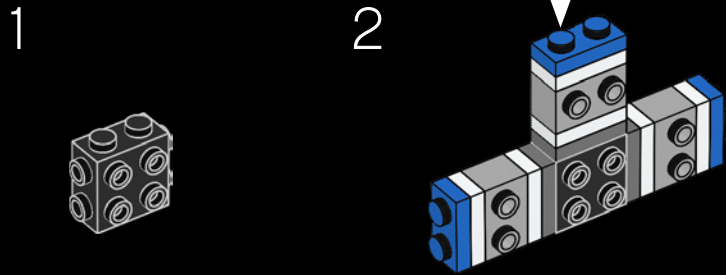
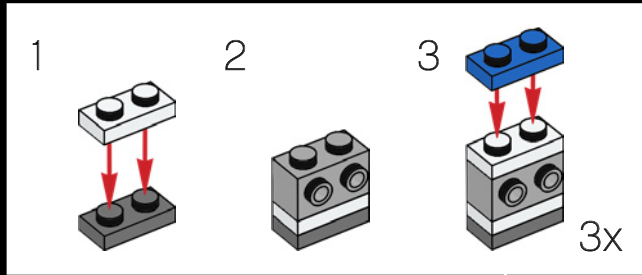

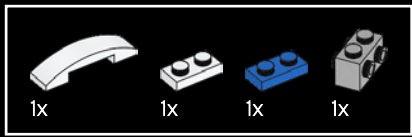

182

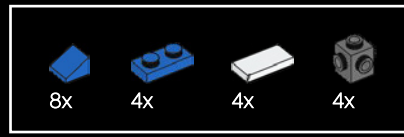
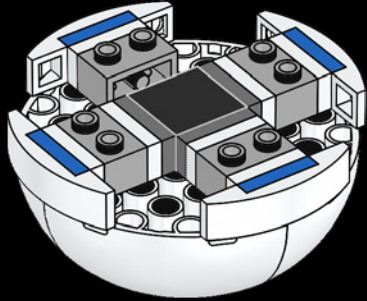
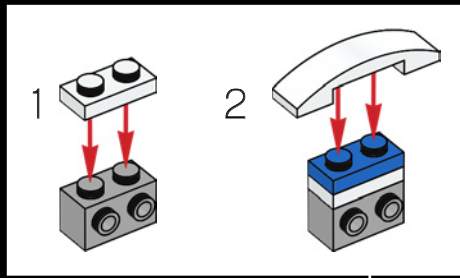

183

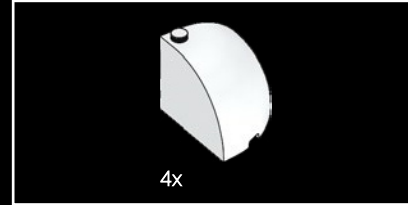
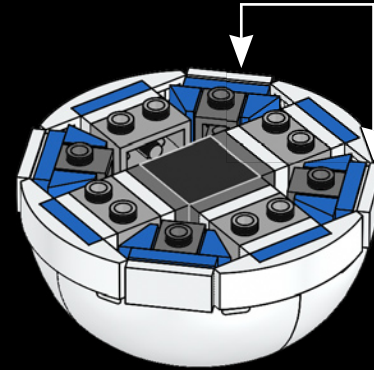
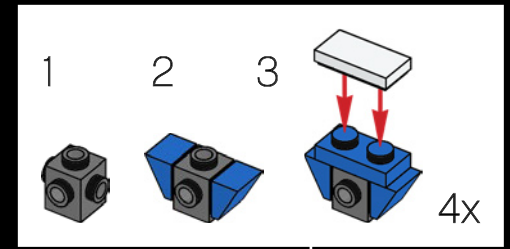

184

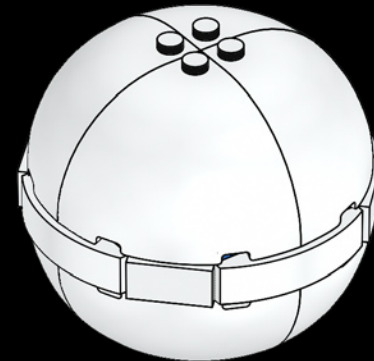

185

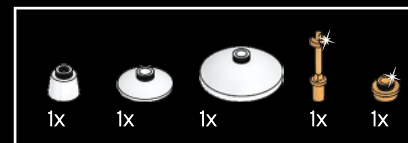
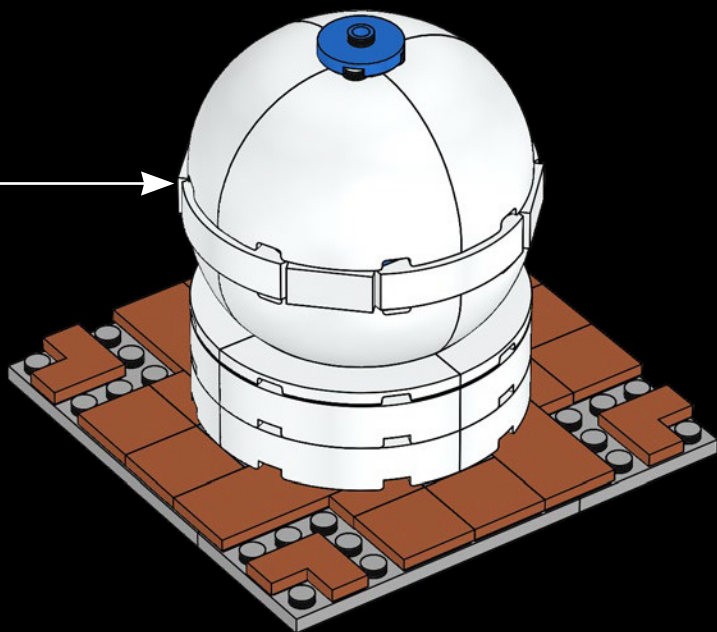

186

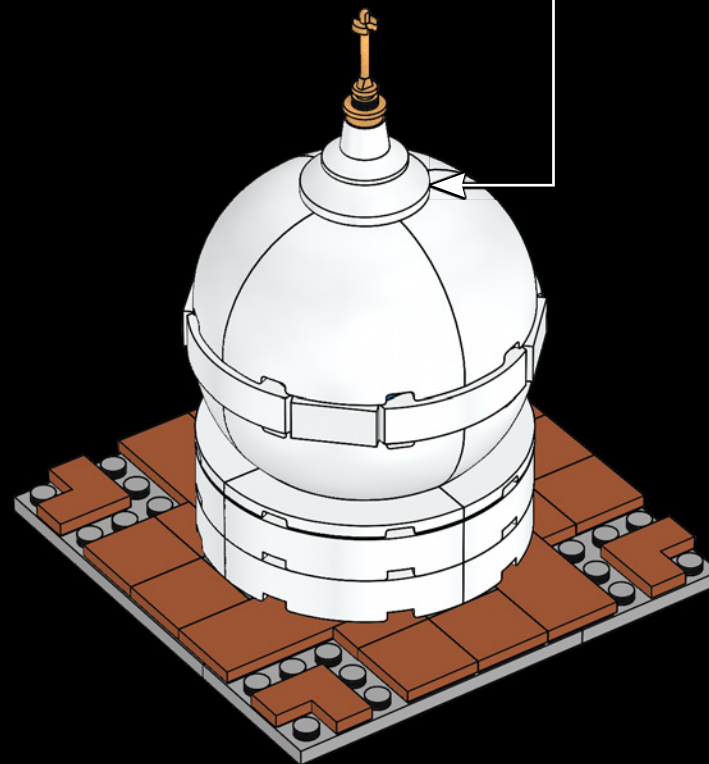
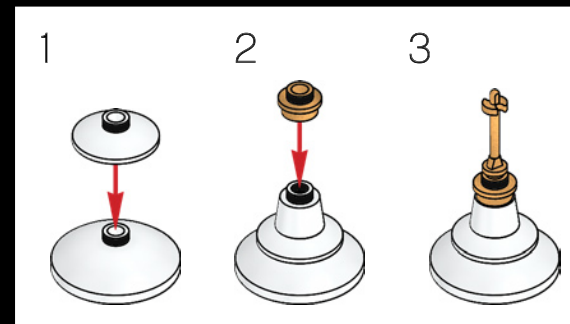

187

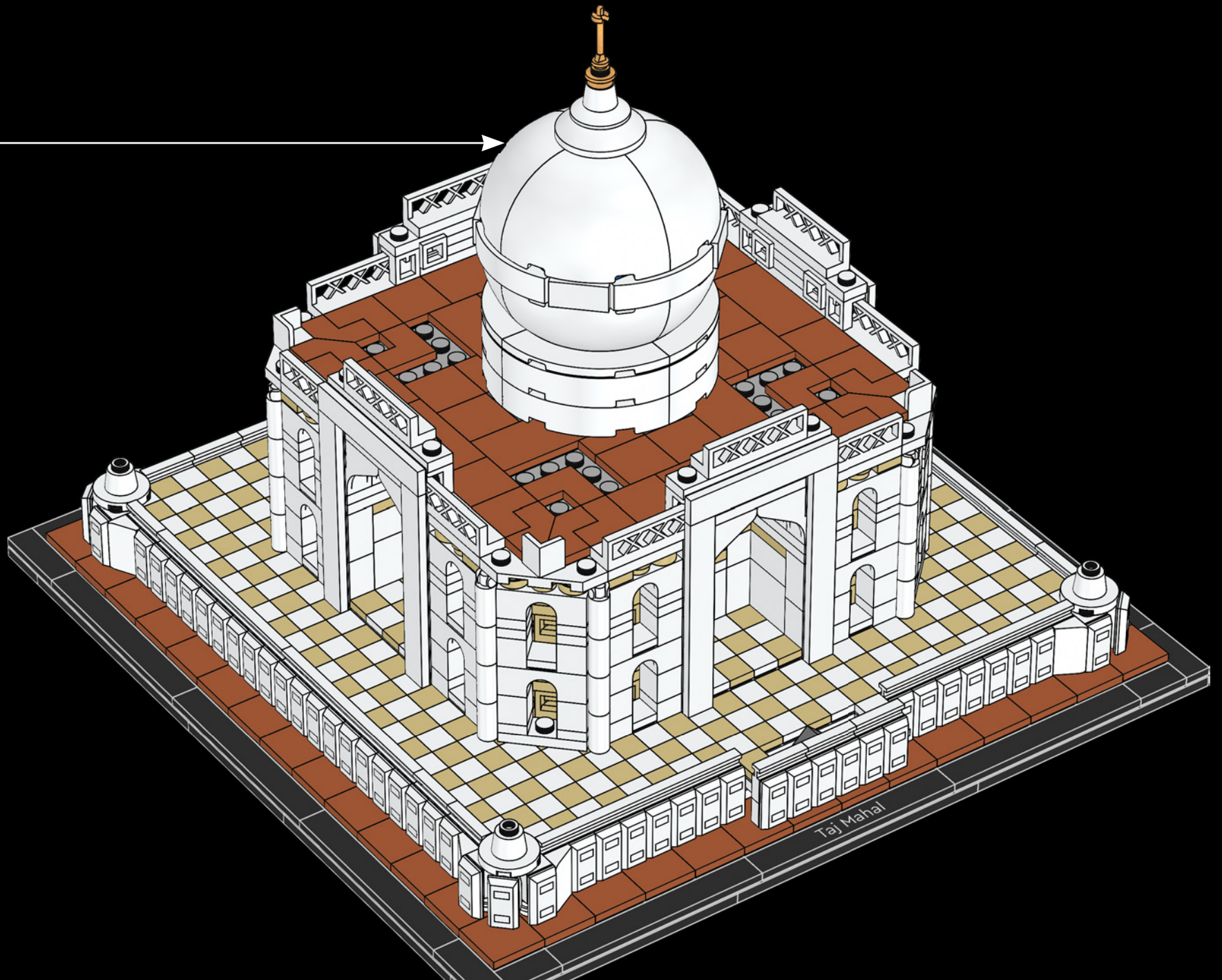

32x 16x 16x

188

16x

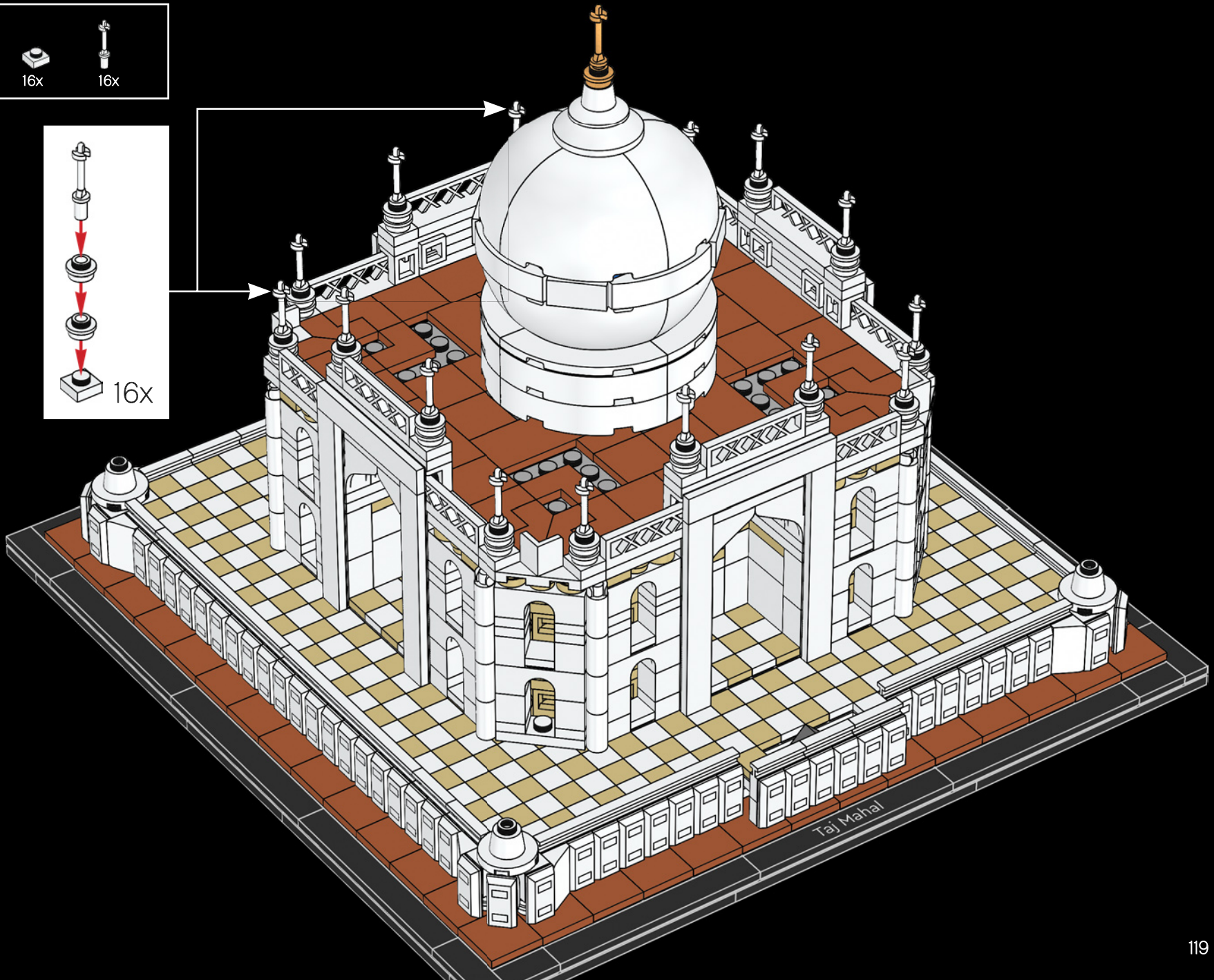

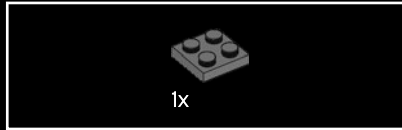
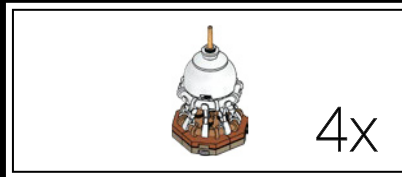
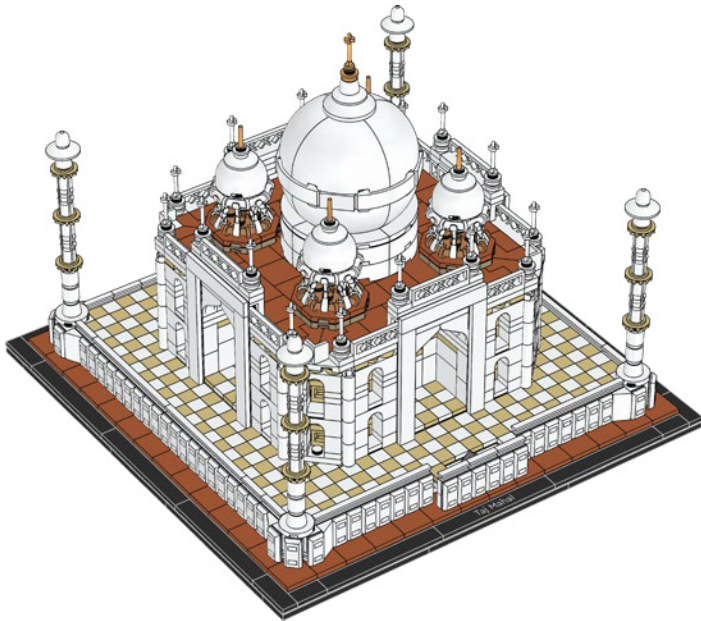
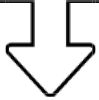

189





190

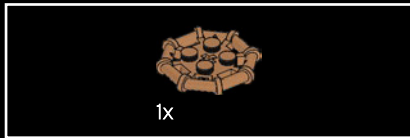
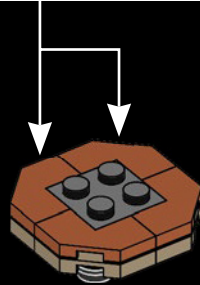
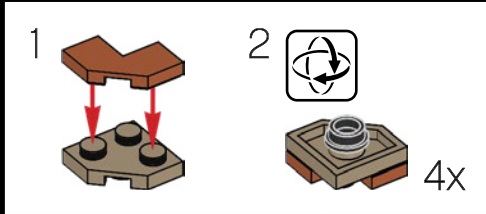

191

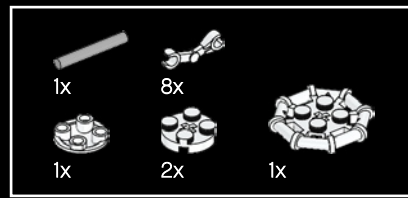

192

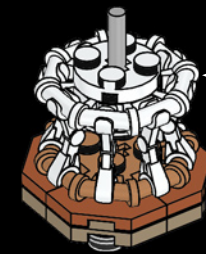
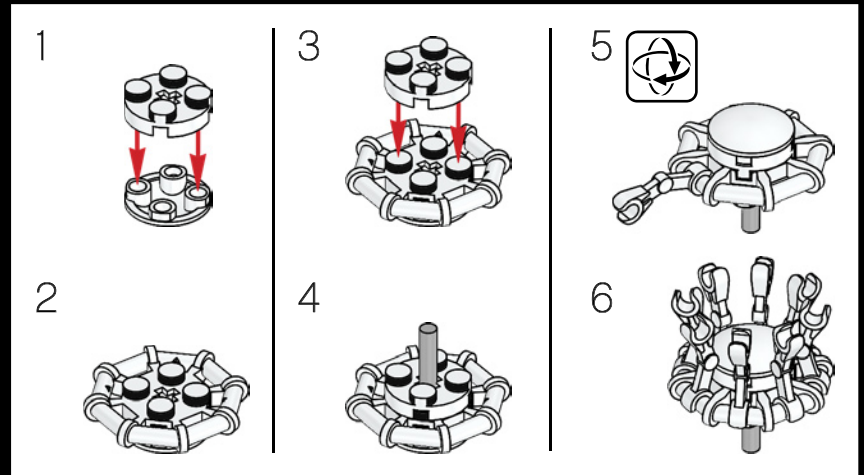



193

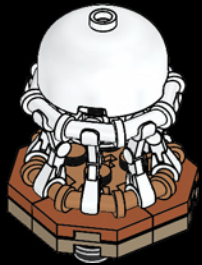

194



195

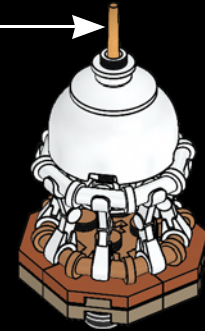

4x

196

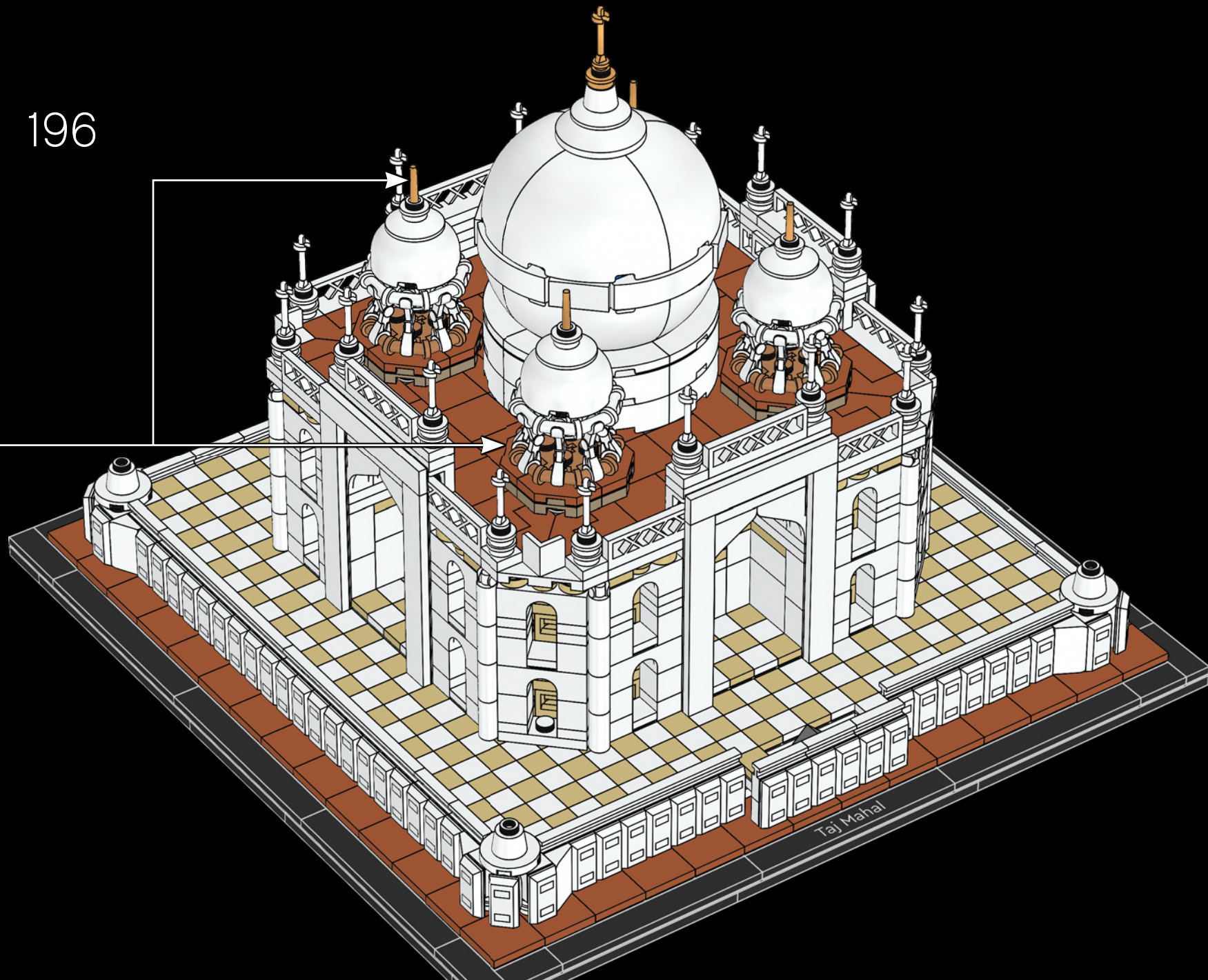

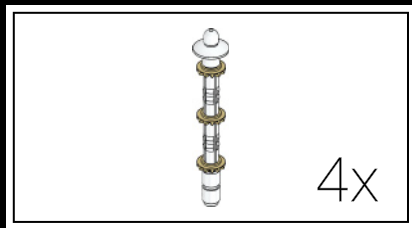

197

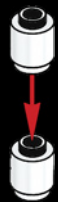

198

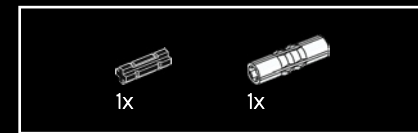

199



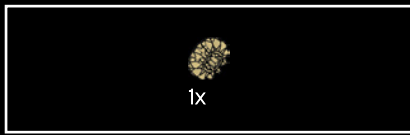

200

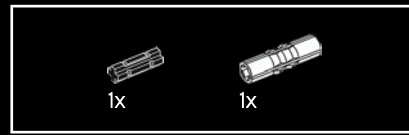

201





202

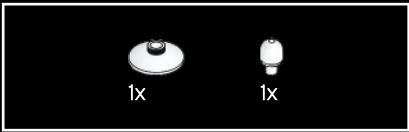

203



4x

As a safety measure, the four minarets lean slightly outward rather than stand straight. Thus, if any of them fell, they would fall away from the tomb.



204

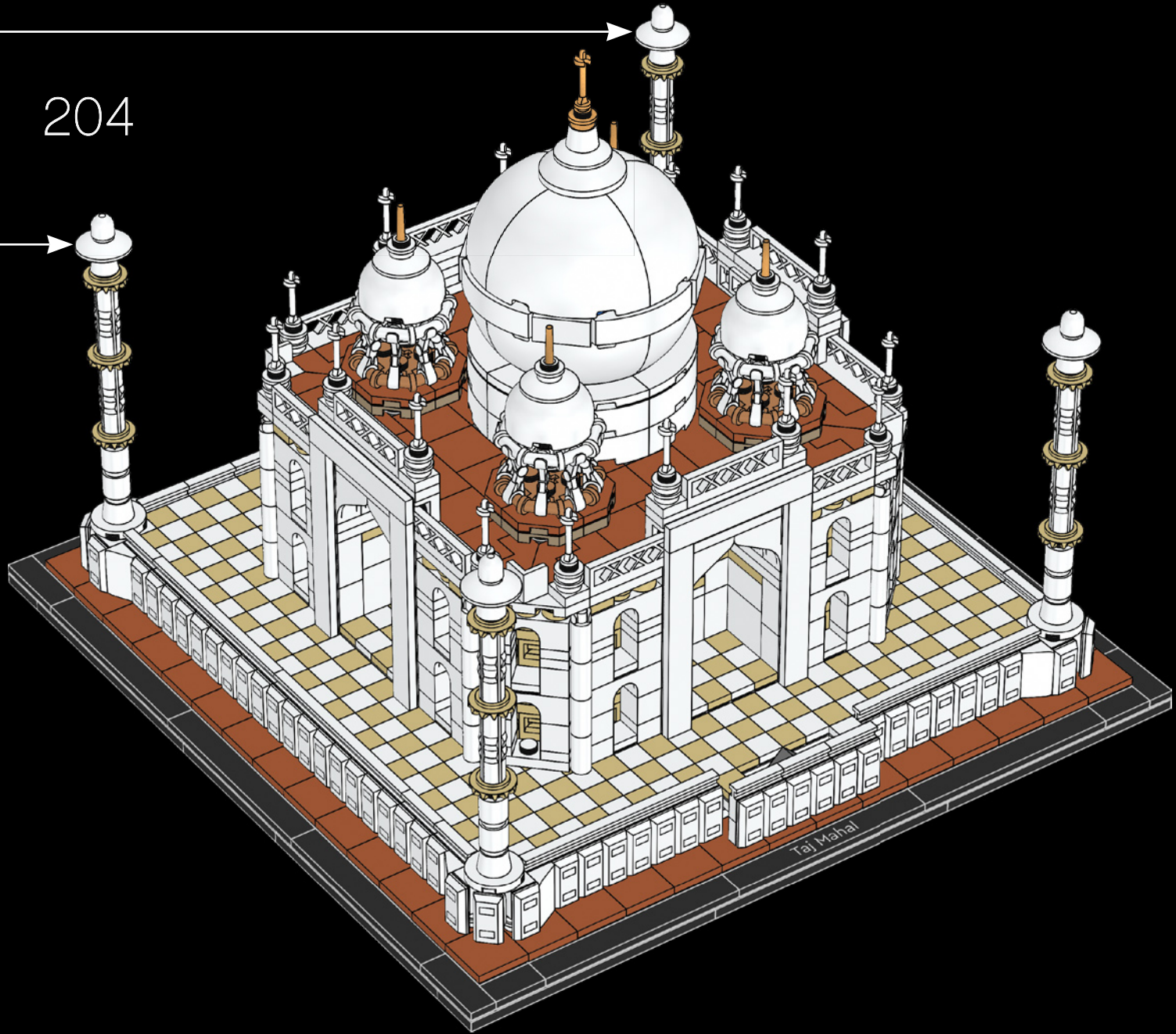

Celebrate the world of architecture and collect all the models

21045
Trafalgar Square



21042
Statue of Liberty

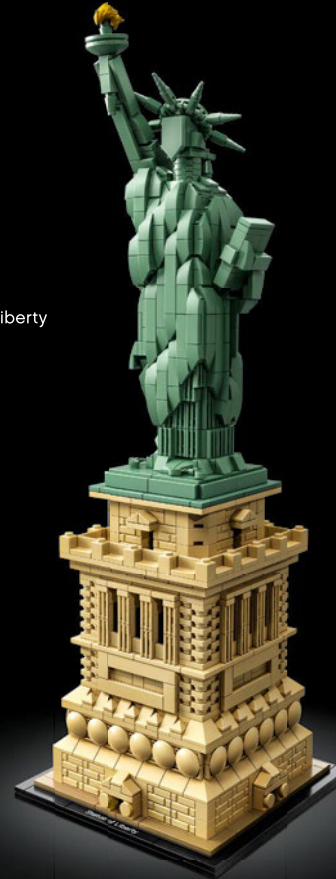

21046
Empire State Building



21054
The White House





21028
New York City

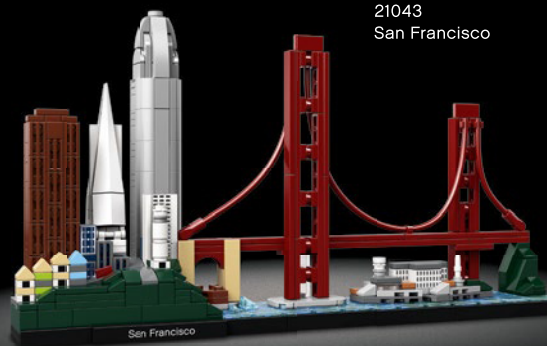

21043
San Francisco

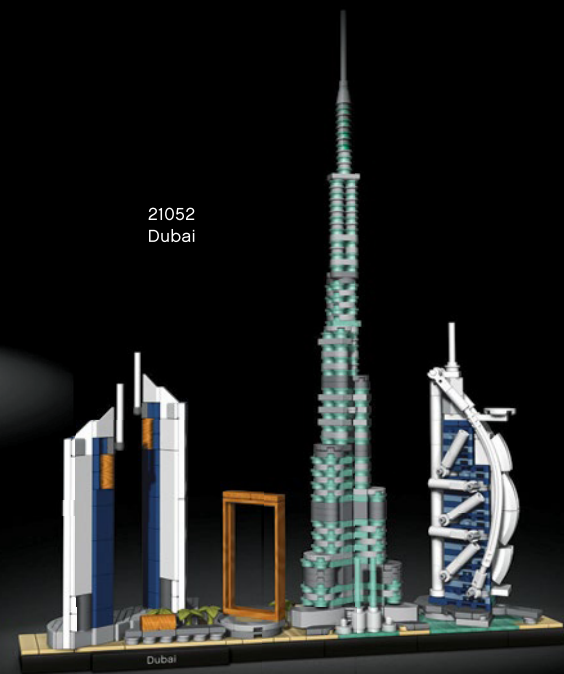

21052
Dubai



21044
Paris

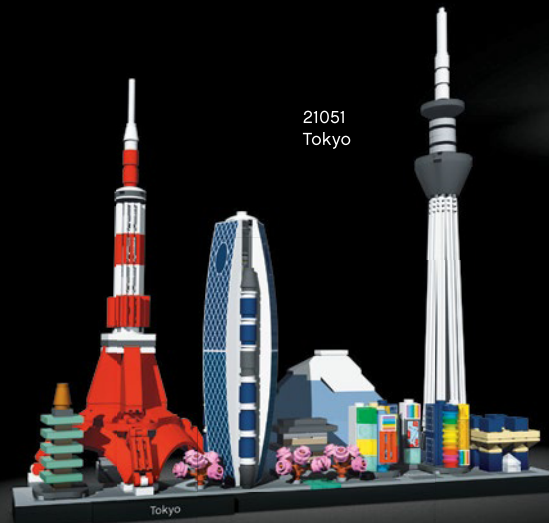

21051
Tokyo



21034
London

The Transamerica Pyramid Building is a registered service mark of Transamerica Corporation and is being used with permission.

© Pyramide du Louvre, architecte I. M. Pei, musée du Louvre.

© TOKYO-SKYTREE

東京スカイツリー®/东京晴空塔®/TOKYO SKYTREE

© Jumeirah International LLC







FEEDBACK AND WIN



FEEDBACK AND WIN

Your feedback will help shape the future development of this product series.

Please visit:

FEEDBACK UND GEWINNEN

Dein Feedback trägt zur Weiterentwicklung dieser Produktreihe bei.

Geh auf:

COMMENTEZ ET GAGNEZ

Vos commentaires nous aideront à concevoir les futurs produits de cette gamme.

Rendez-vous sur :

COMENTA Y GANA

Tu opinión nos ayudará a dar forma al desarrollo de esta serie de productos en el futuro.

Visita:

反馈有奖

您的反馈将有助于我们在今后改进本系列产品。

请访问：

[LEGO.com/productfeedback](https://www.lego.com/productfeedback)

By completing, you will automatically enter a drawing to win a LEGO® set.

Terms & Conditions apply.

Durch Ausfüllen nimmst du automatisch an der Verlosung eines LEGO® Preises teil.

Es gelten die Teilnahmebedingungen.

En envoyant vos commentaires, vous serez automatiquement inscrit(e) à un tirage au sort qui vous permettra de remporter un prix LEGO®.

Offre soumise à conditions.

Al contestar, participarás automáticamente en el sorteo y podrás ganar un set LEGO®.

Sujeto a Términos y Condiciones.

完成我们的反馈调查，即可自动进入抽奖环节，赢取乐高®套装。

适用《条款和条件》。

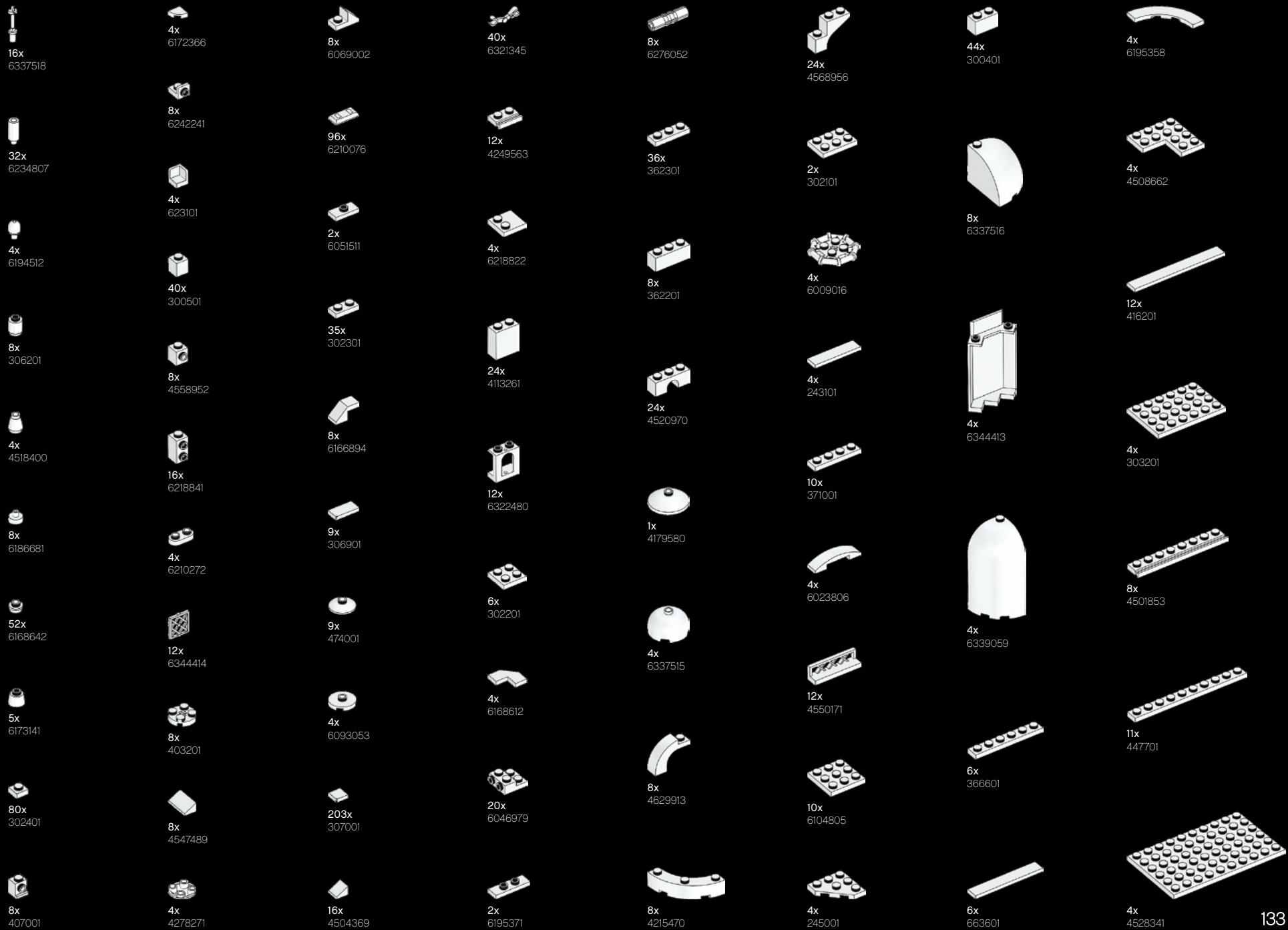

20x
6284573

16x
4109995

4x
4208072

8x
6186012

16x
6228921

44x
4161734

20x
4113917

4x
4124067

2x
4614158

8x
4550168

36x
4159553

4x
6314477

4x
4181134

61x
6186423

8x
6210581

60x
4118793

4x
6226565

4x
4113993

24x
6253425

4x
4211385

8x
6145570

4x
4124455

2x
4114324

28x
6341393

4x
6079461

191x
4125253

8x
4114077

4x
4125217

8x
6058089

2x
4211438

12x
4565452

12x
4121921

3x
6156462

4x
4640844

1x
6015349

8x
6212758

2x
6115031

3x
6156462

4x
4657459

24x
4211407

8x
6092587

134

1x
6292254

1x
6190252

2x
6342086

4x
6147169

4x
6177189

2x
4504378

4x
4210700

1x
4226221

7x
4211063

4x
4211094

1x
4210997

2x
300328

2x
4125281

4x
4107758

4x
4106356

8x
303428

2x
4153825

2x
6212079

4x
4153827

1x
6240515

8x
4504380

1x
6194417

10x
302323

33x
302123

1x
371023

4x
4243815

1x
4199519

16x
614126

8x
4109810

4x
306926

1x
6308883

4x
242026

4x
4558170

4x
300126

6x
366626

2x
379526

11x
416226

1x
6338083

4x
303226

10x
383226

Customer Service
Kundenservice
Service Consommateurs
Servicio Al Consumidor
LEGO.com/service or dial

🇧🇪 🇩🇪 🇪🇸 🇫🇷 🇮🇹 🇯🇵 🇰🇷 🇸🇪 🇸🇯
🇨🇦 🇨🇭 🇨🇯 🇩🇰 🇩🇪 🇪🇸 🇫🇷 🇮🇹 🇯🇵 🇰🇷 🇸🇪 🇸🇯
: 00800 5346 5555
: 1-800-422-5346



