



Booklet available in English on
Heft in deutscher Sprache erhältlich auf
Livret disponible en français sur
Libretto disponibile in italiano su
Folleto disponible en español en
如需中文版手册, 请访问



PRIZED FOR CENTURIES, FOREVER IN BLOOM

Theophrastus, a student of Aristotle, loved them. Confucius, the great philosopher, wrote poems for them. For centuries, orchids have found their way into the hearts of many, and today they find their way into yours. While other orchids require the highest levels of attention, the LEGO® Orchid will thrive even in low light, does not require extreme humidity and is probably the easiest to get to bloom again and again.





The three models cannot be built simultaneously.

FLOWERS JUST THE WAY YOU LIKE IT

Featuring six full blossoms and two smaller buds, you can trim stems to different lengths, rotate roots and leaves to keep them healthy, and get new arrangements simply by moving blossoms around any way you like.



FROM THE DESIGN TEAM

Mike has been designing LEGO® products for well over 9 years now. Creating the geometry of the pot was one of his favourite challenges in this model. *"Designing orchids that sit in a sand-blue fluted pot, that are not only fun to build but also beautiful to look at, was an exciting challenge for me. While real orchids were brought in to inspire me, I must admit that the LEGO Orchid is far easier to care for and is certainly a lot more enjoyable to be around."*

Michael Psiaki, Design Master

GROW YOUR COLLECTION OF LEGO® BOTANICAL MODELS



10280
Flower Bouquet



10289
Bird Of Paradise



10281
Bonsai tree



10309
Succulents

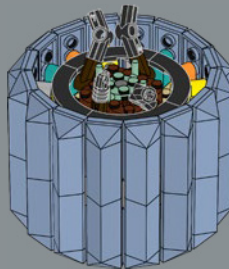
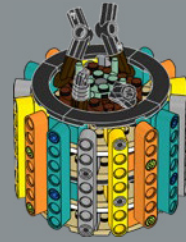
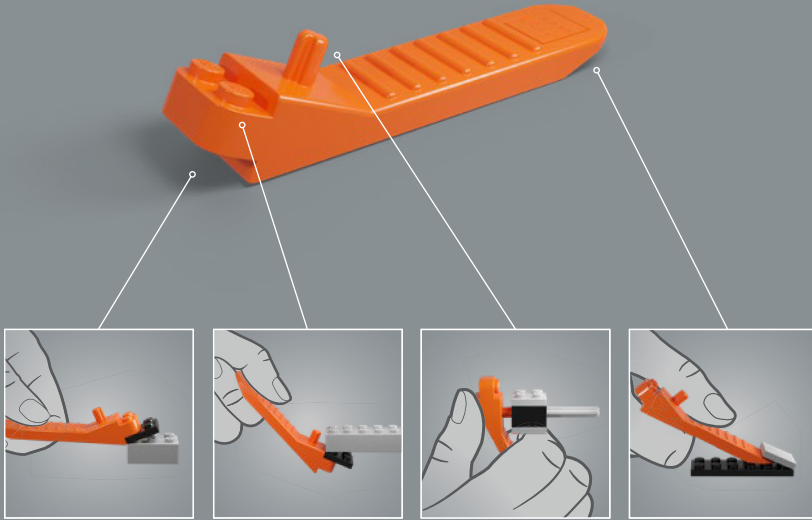

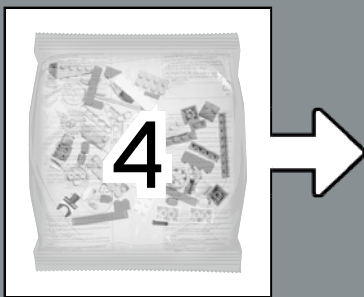
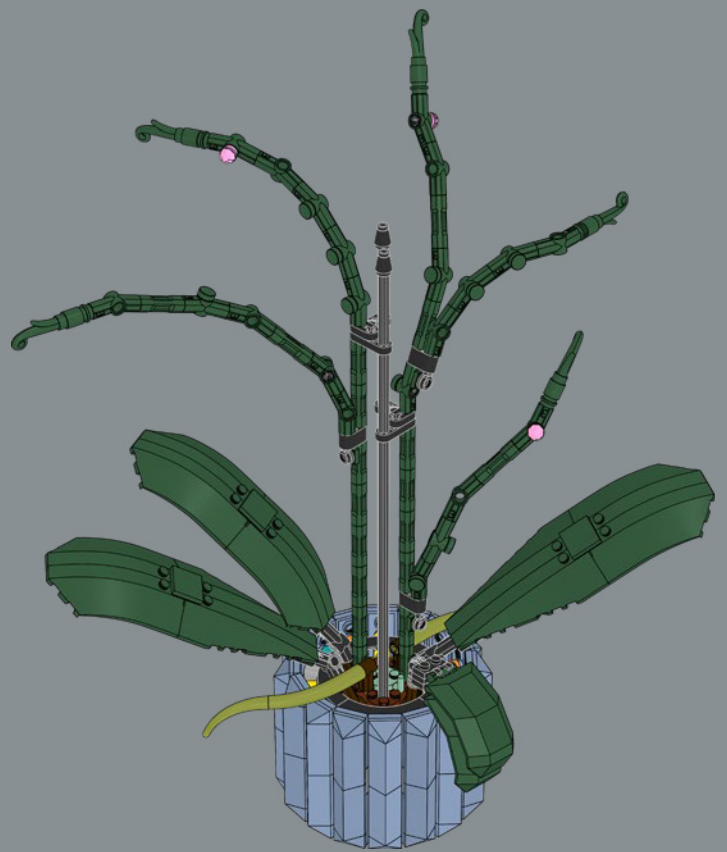
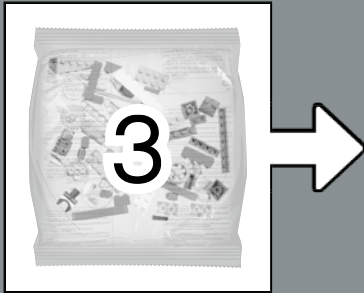

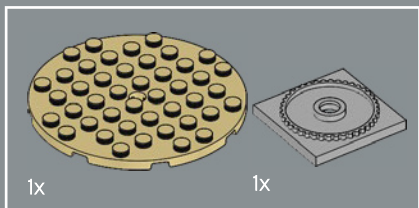

1

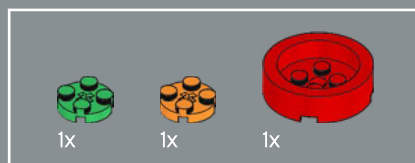
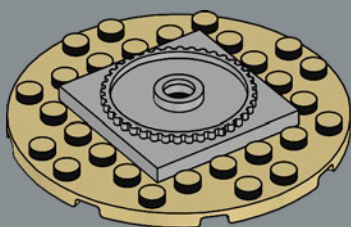

2

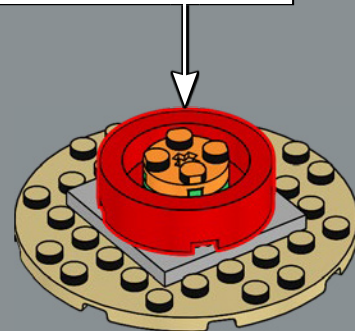
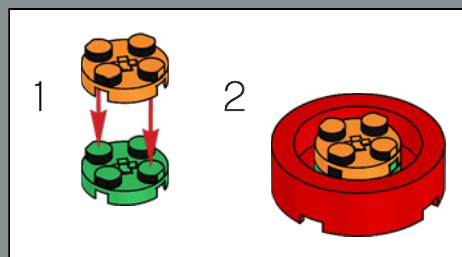



3

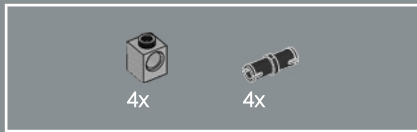
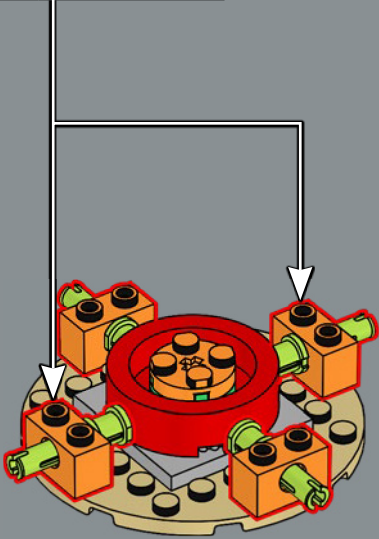
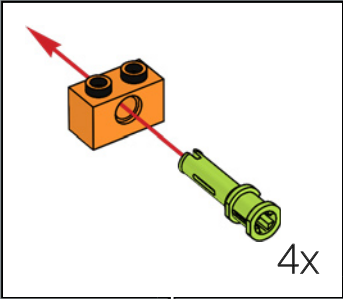

4

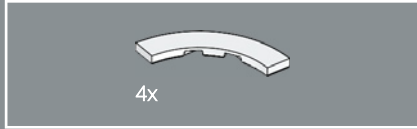
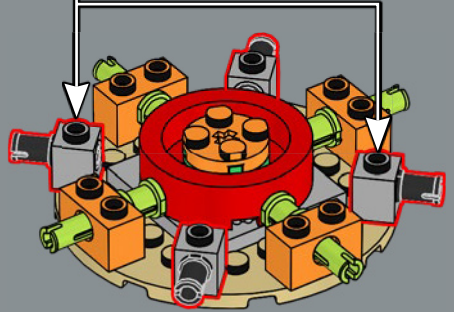
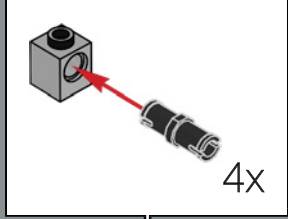

5



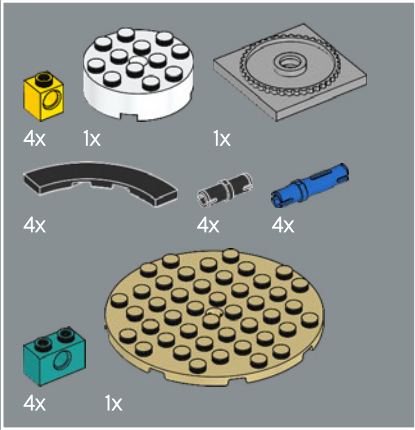
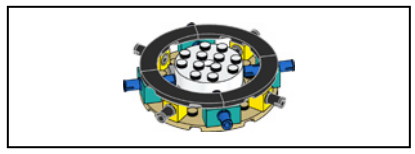

6

2

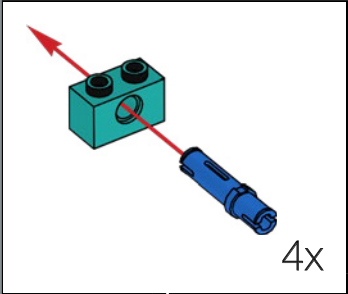
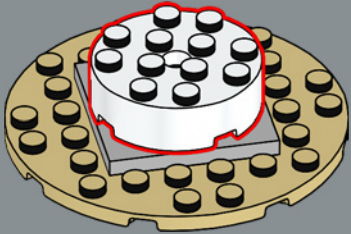

3

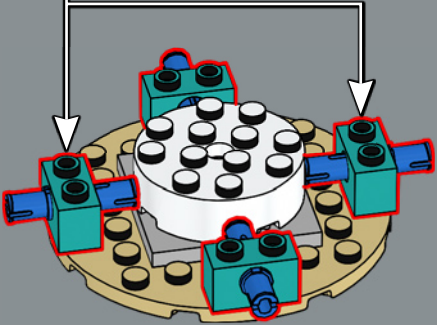

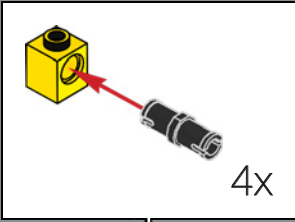

4

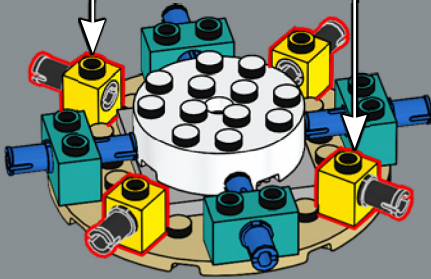

5

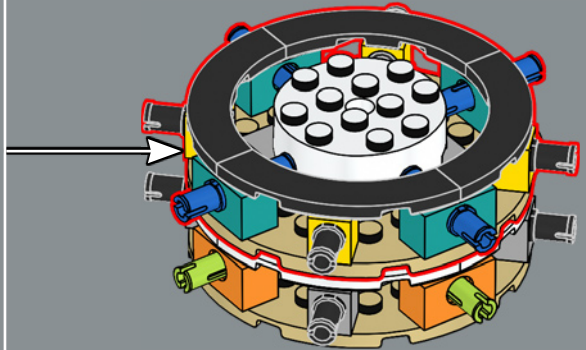
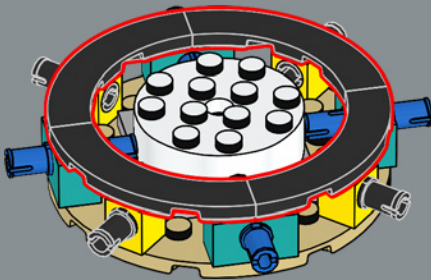

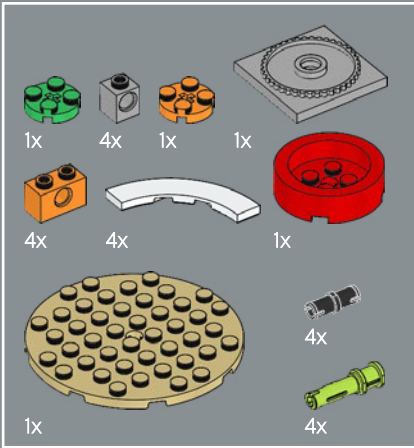
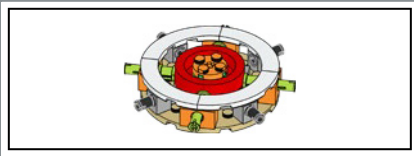

7

1

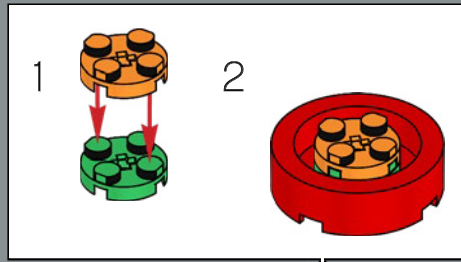
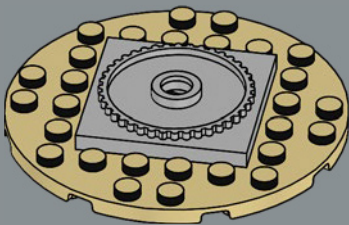

2

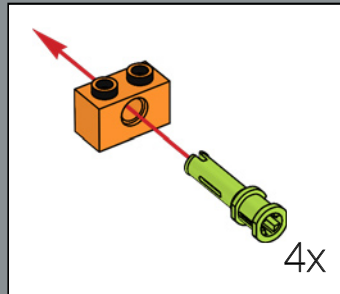
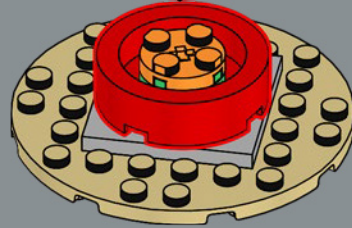

3

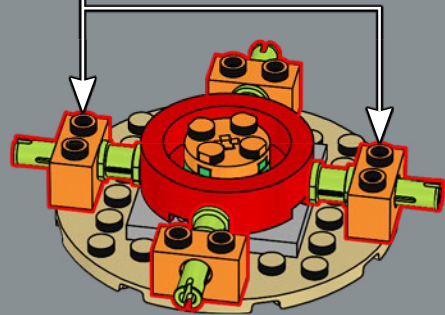



The core of the pot is a modified version of the core used in the large tower of the LEGO® Hogwarts™ Castle set – Professor Sprout would be tickled with this.

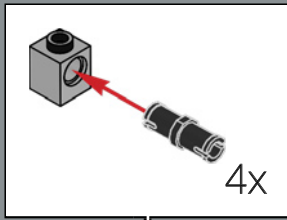

4

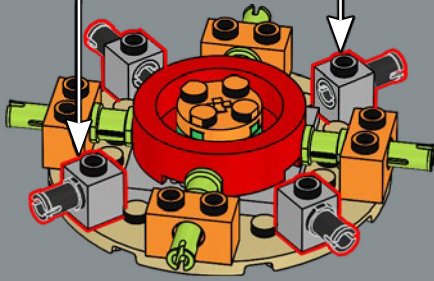

5

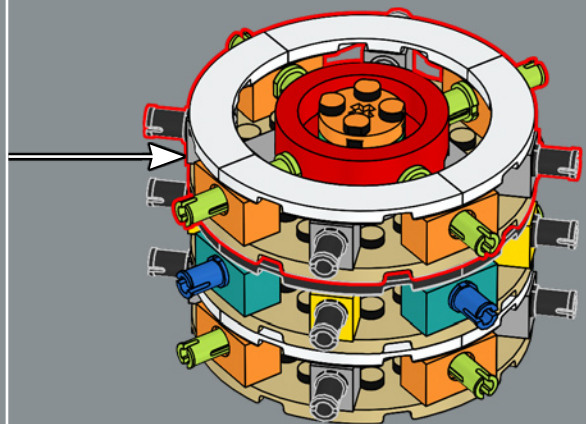
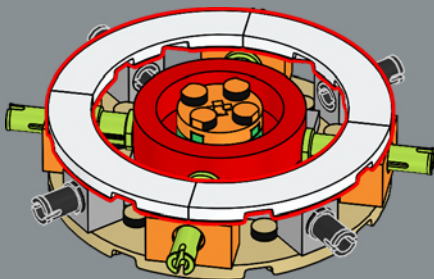

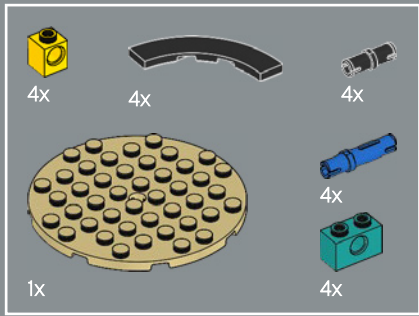

8

1

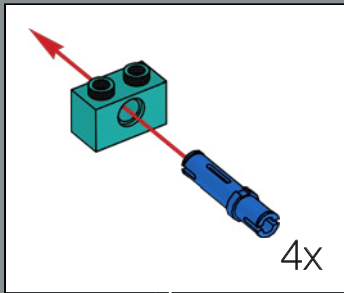
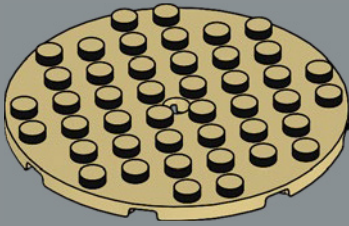

2

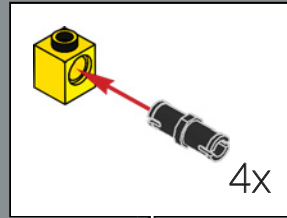
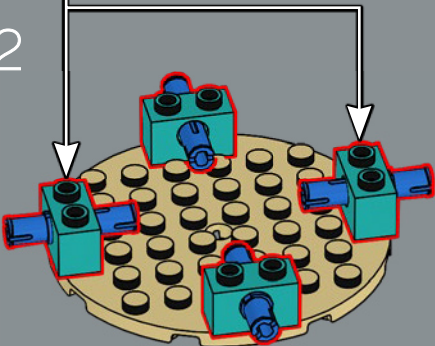

3

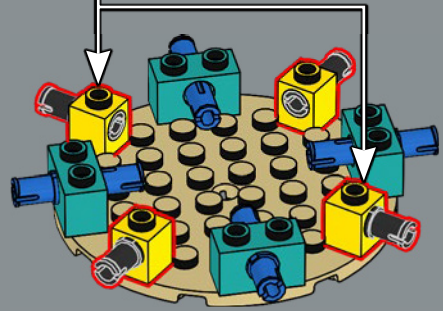

4

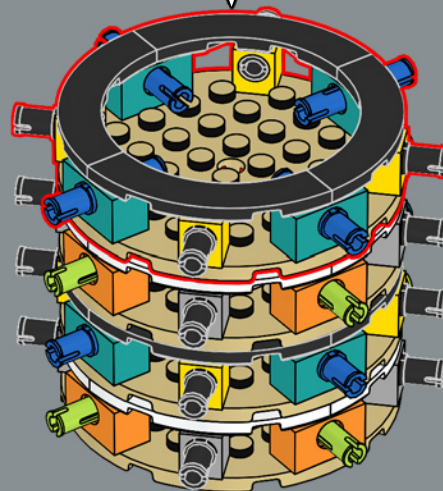
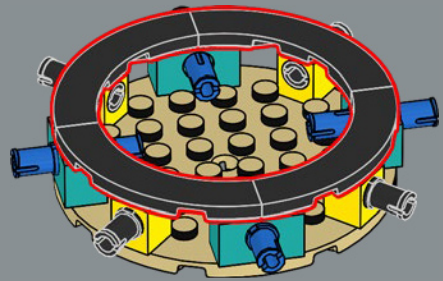

9

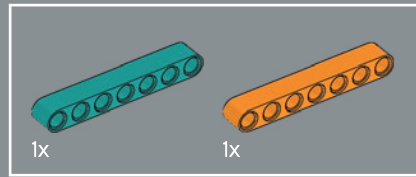
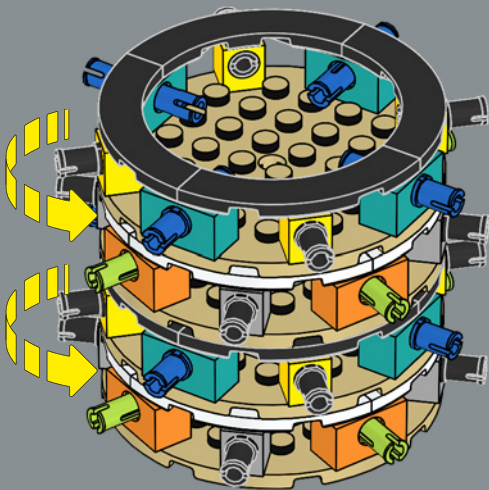

10

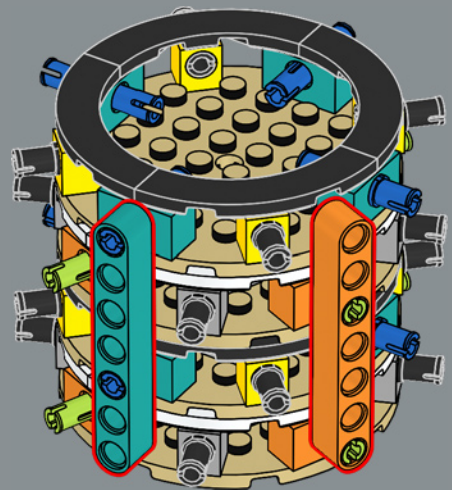

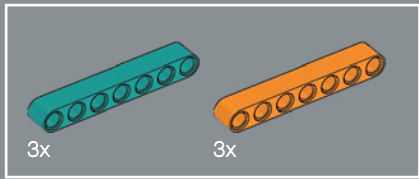

11

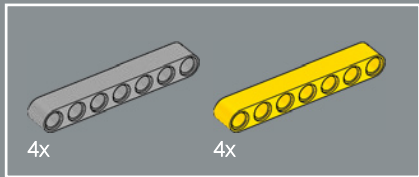
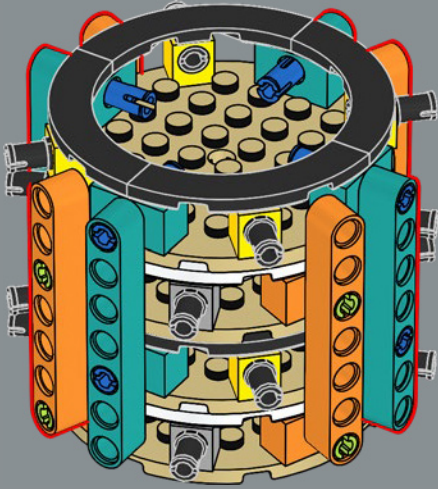

12

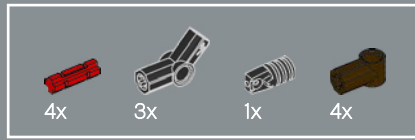
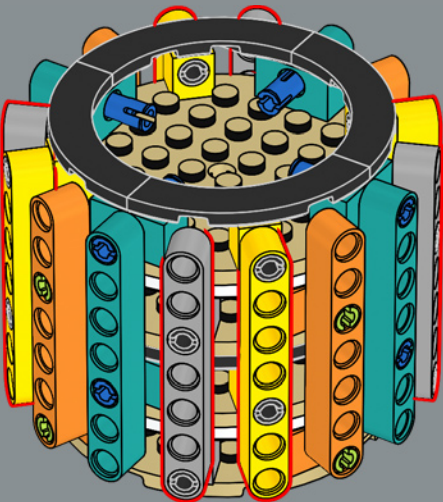

13

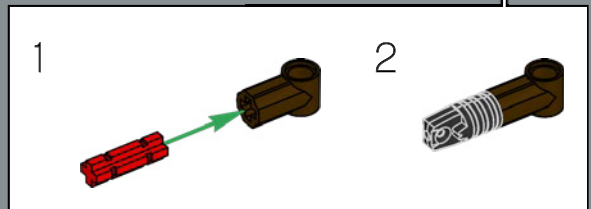
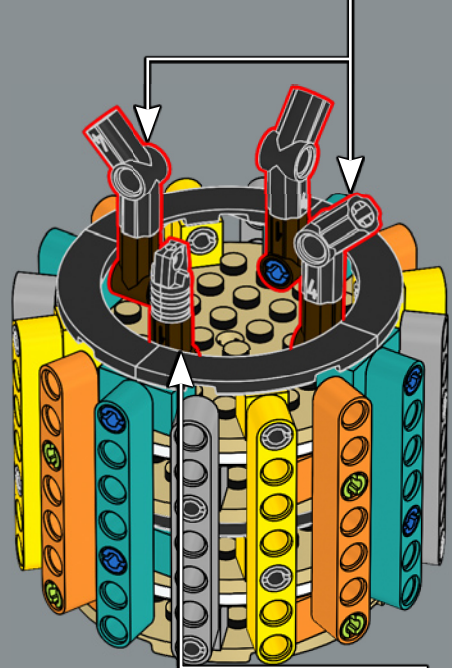
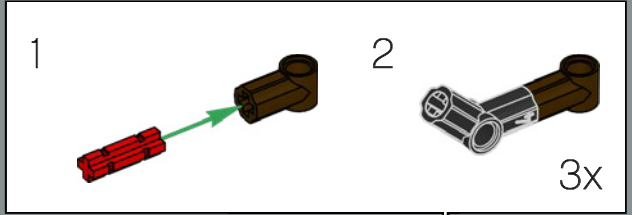



14

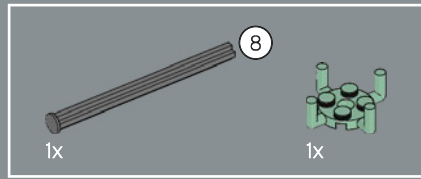
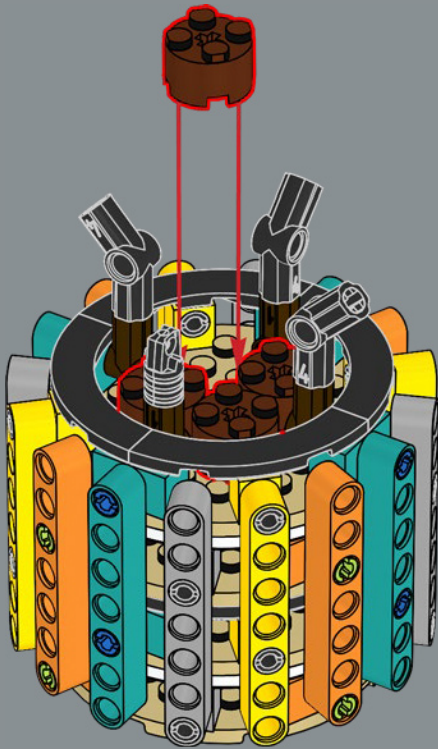

15

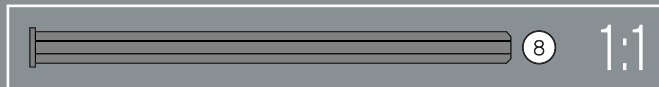
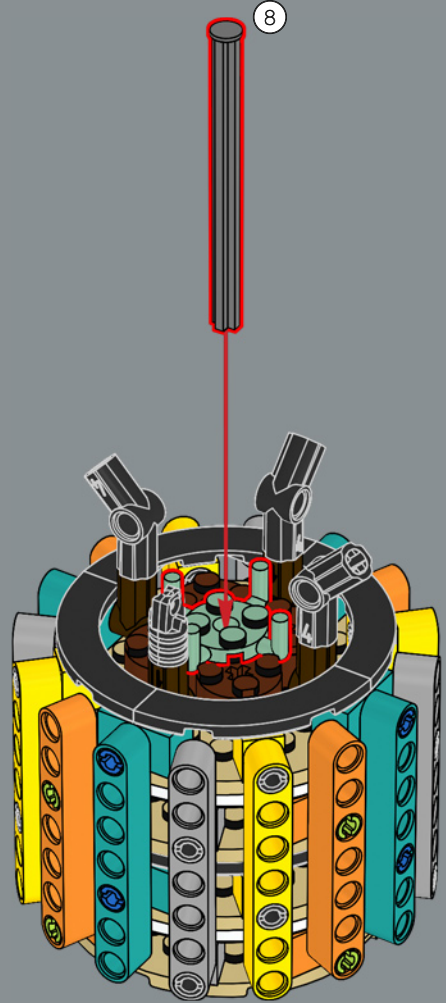



16

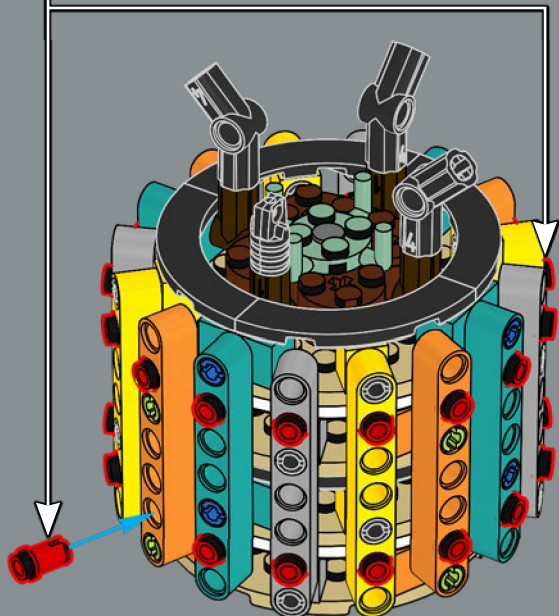
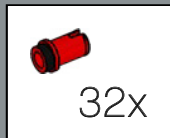

18

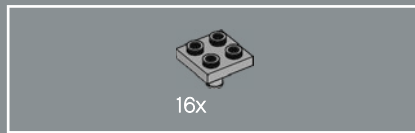

17

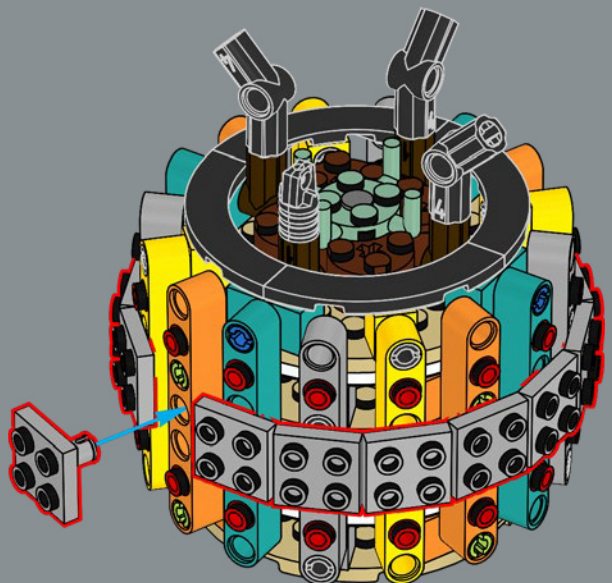

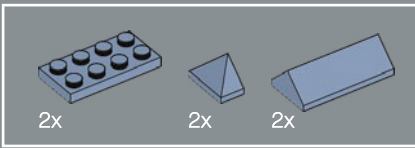

18

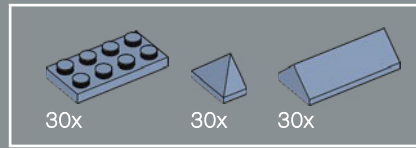
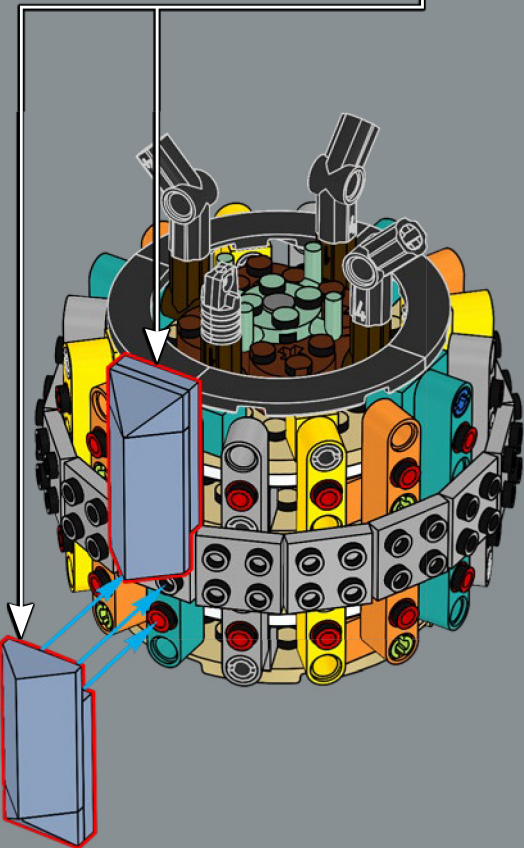
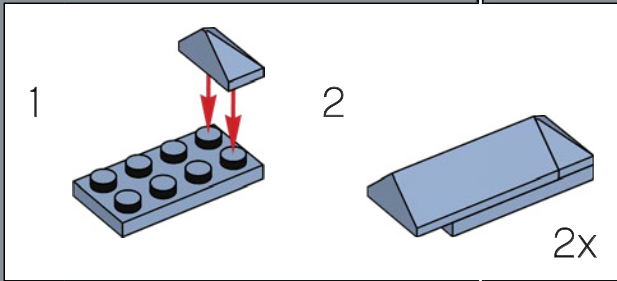

19

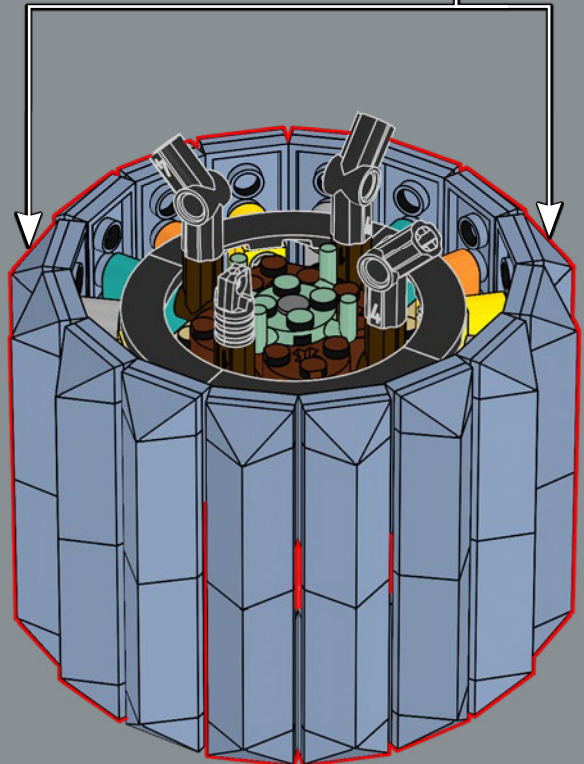
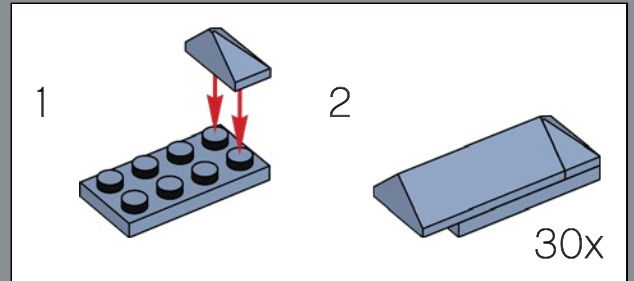

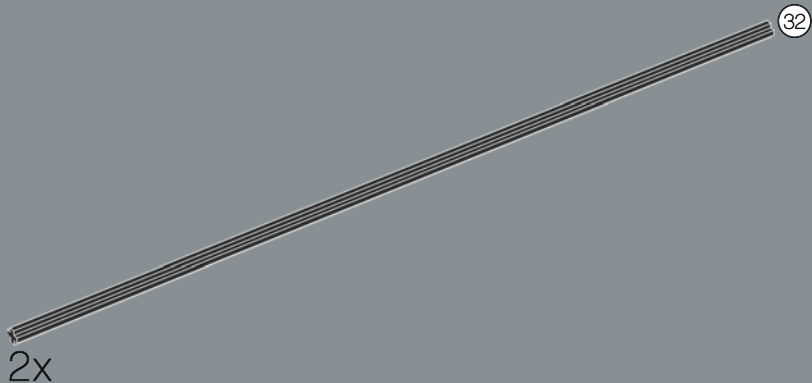
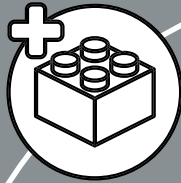



20

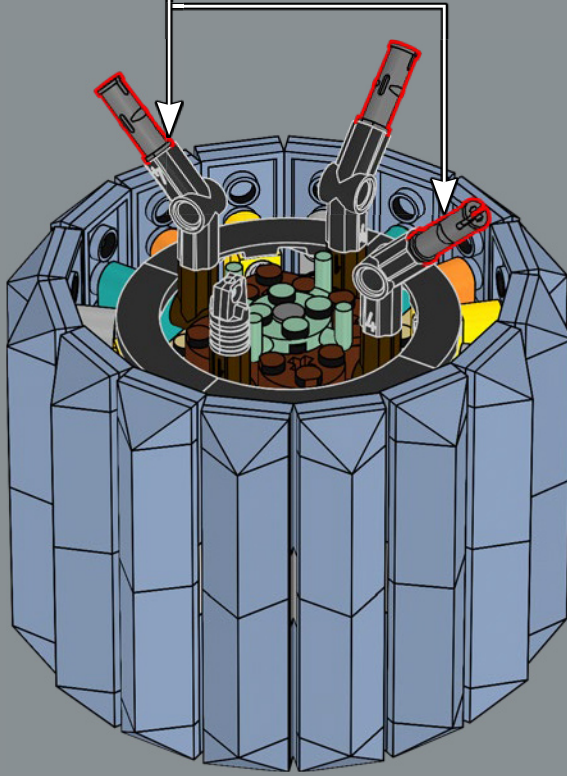
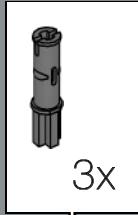

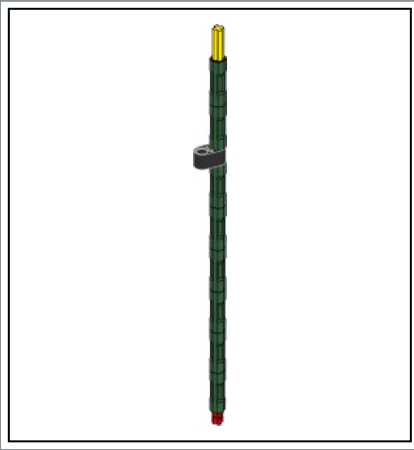

21



22

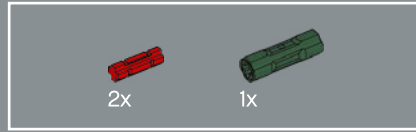
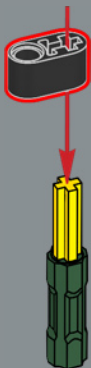

23



24

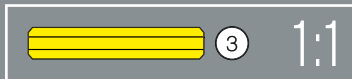

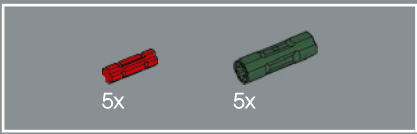

25

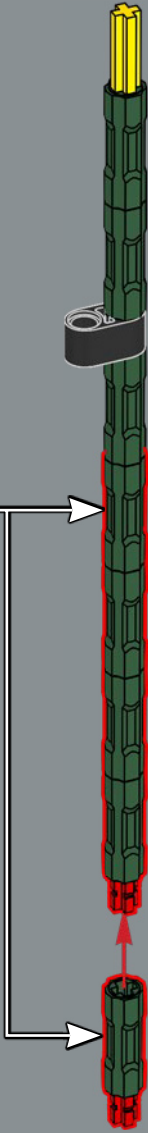
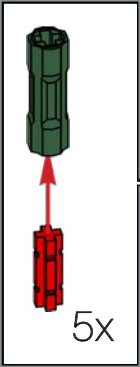

26

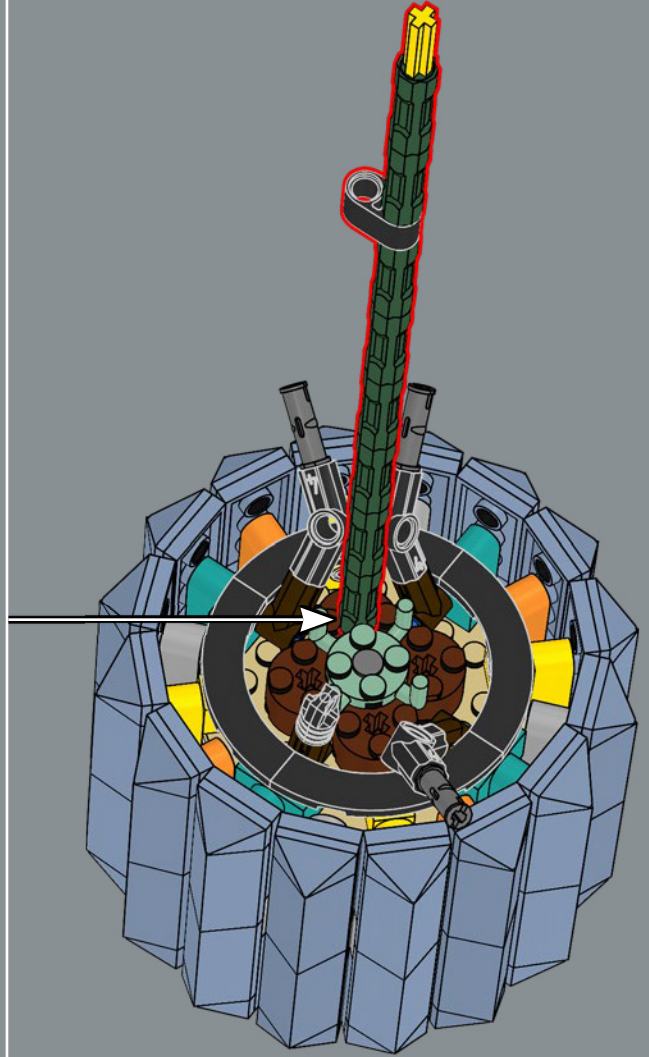

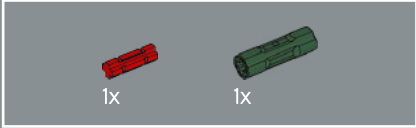
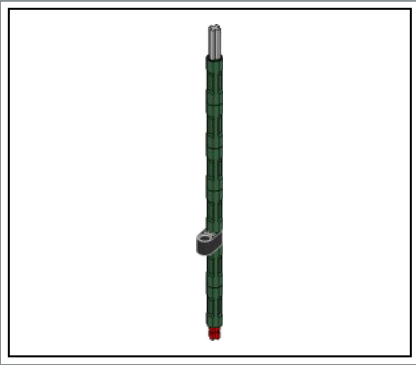

27

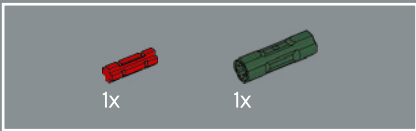
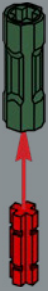

28

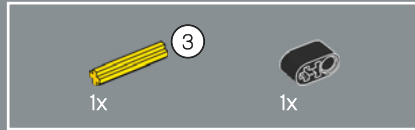

29

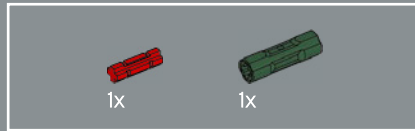
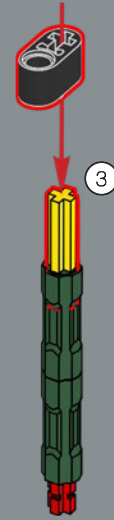

30

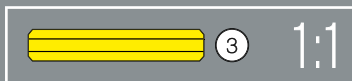

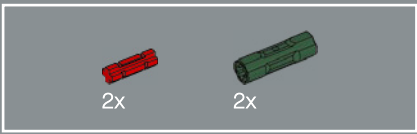

31

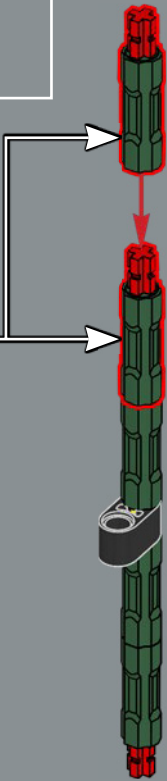
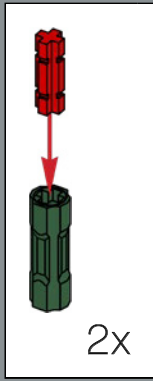

32



33

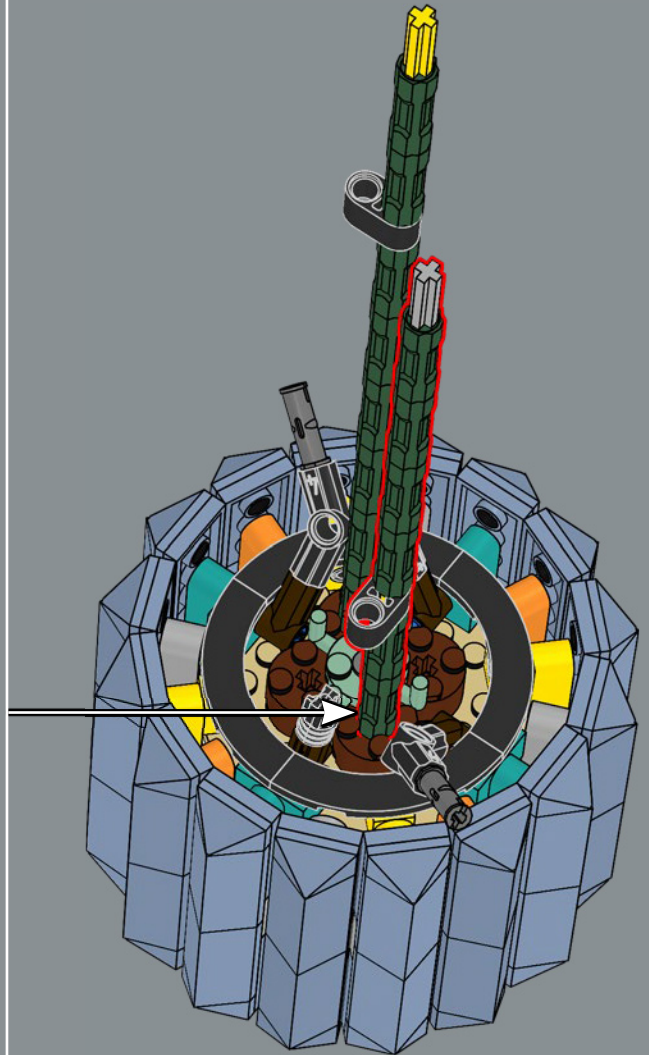

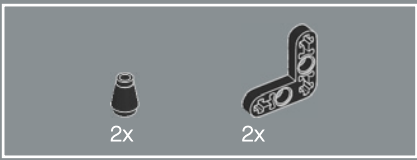

34

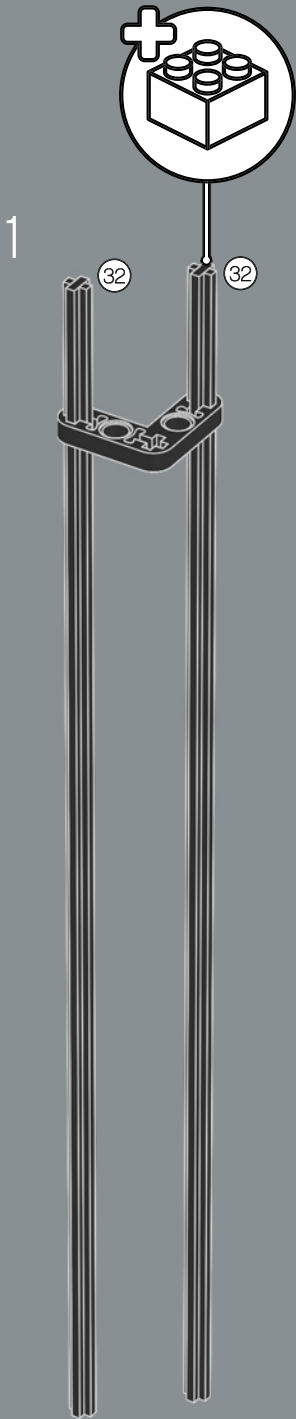

35

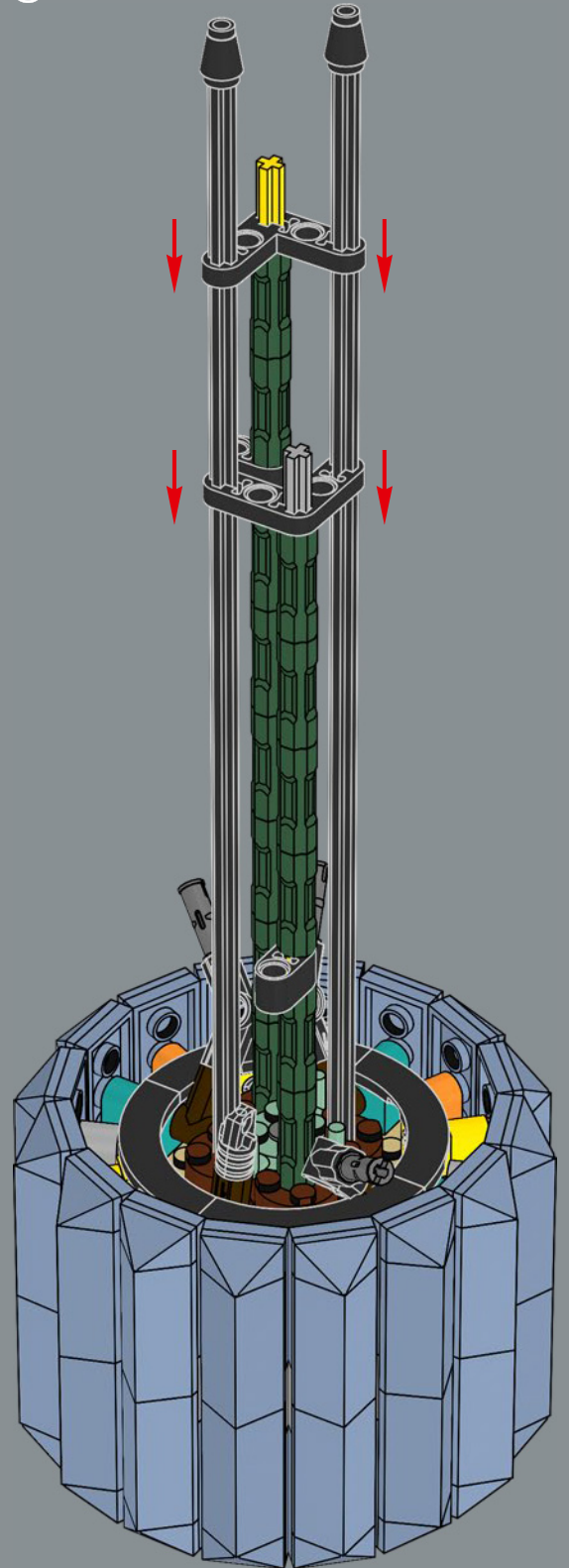
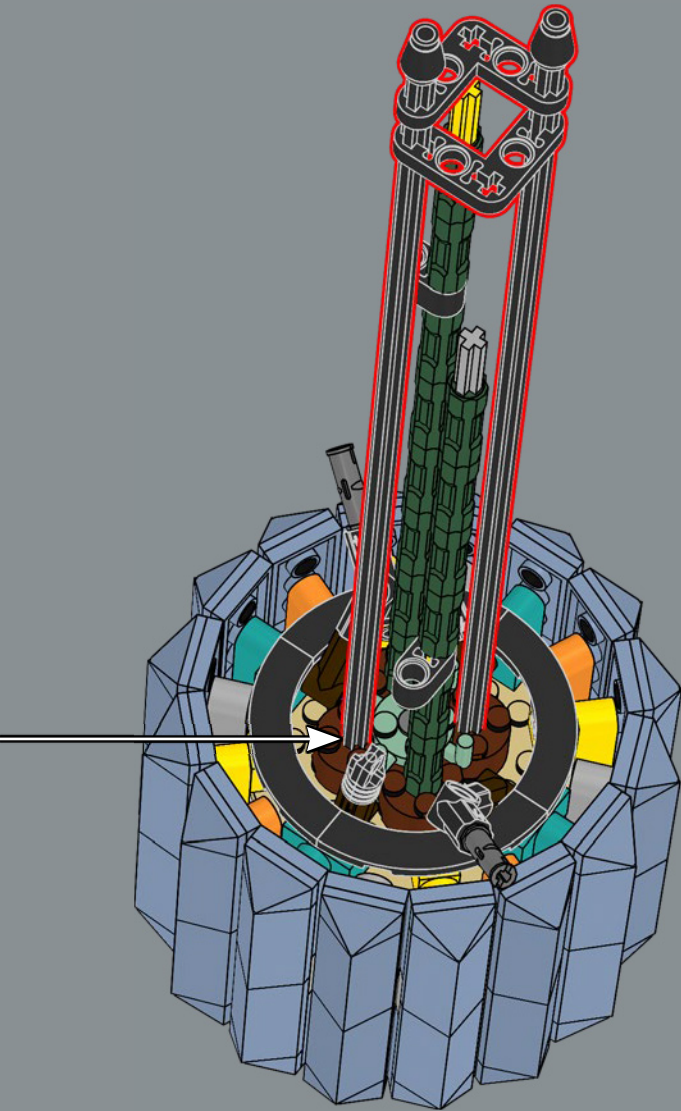



36

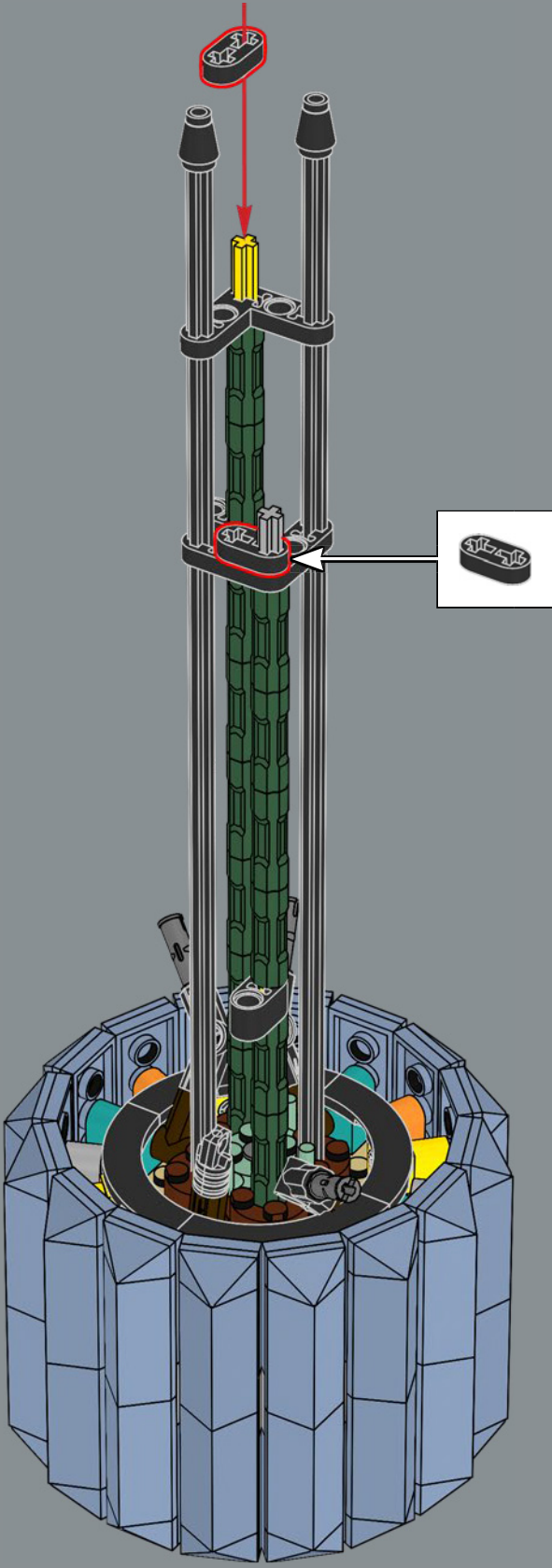

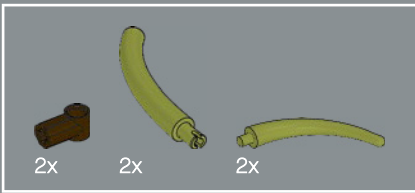

37

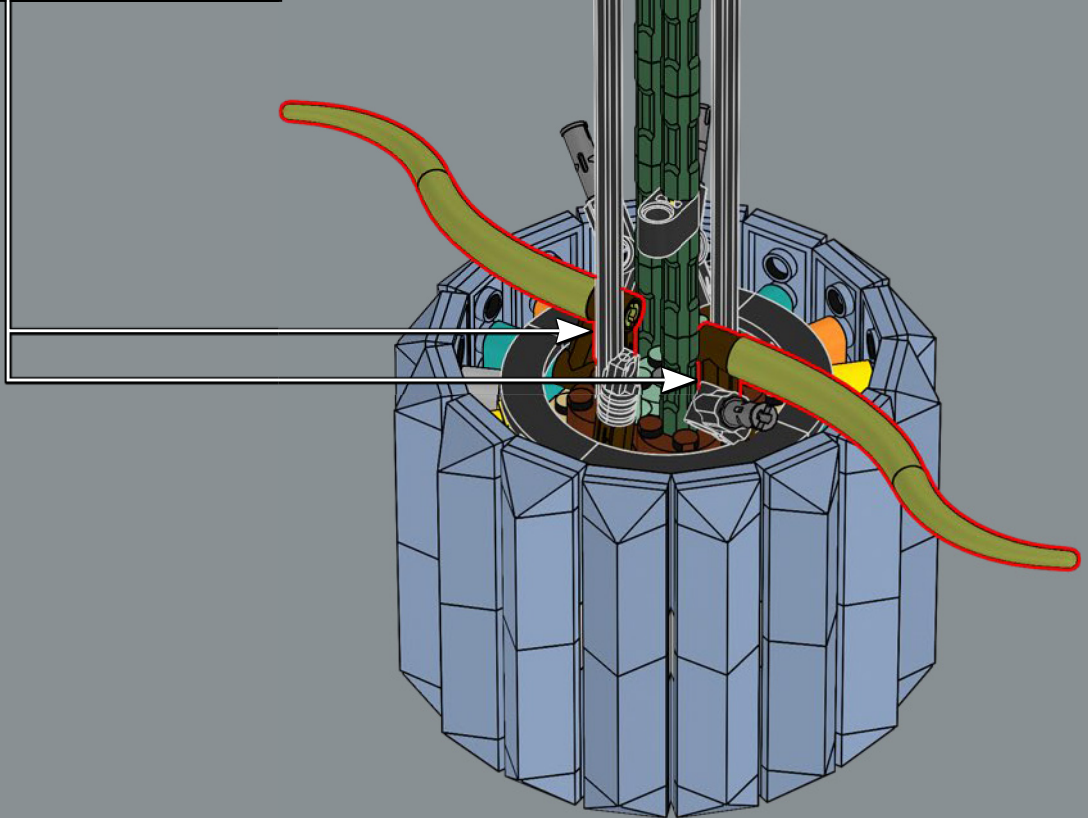
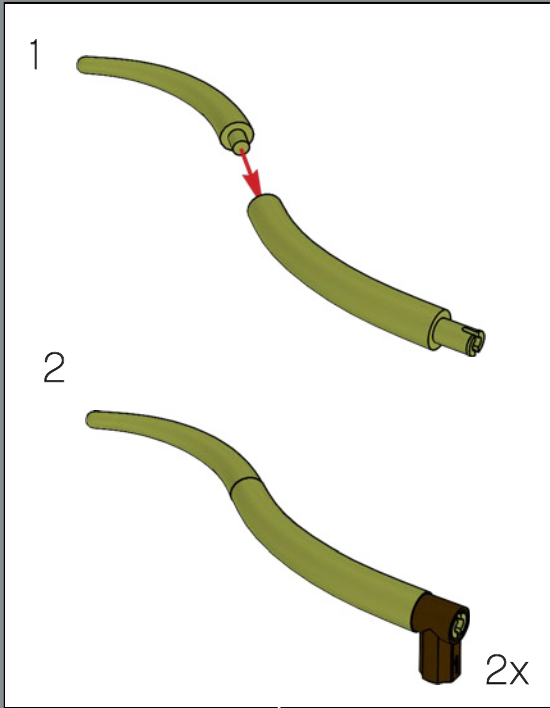

The orchid's air roots are made from dinosaur tail elements - RAWRR!

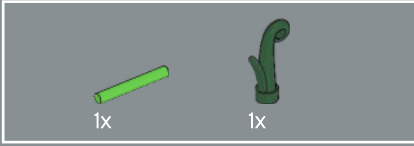
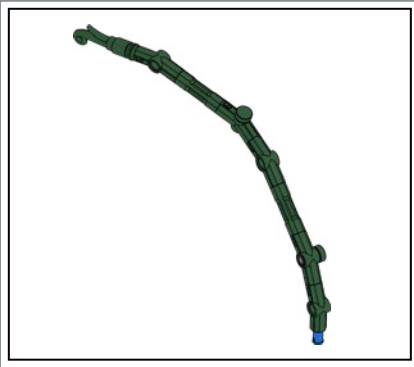

38

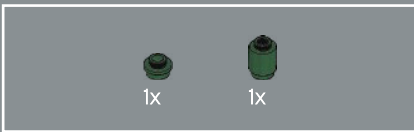
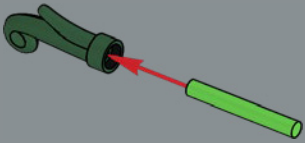

39

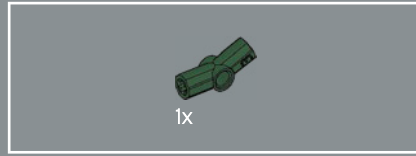
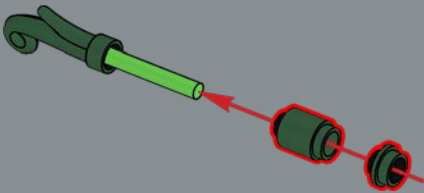

40

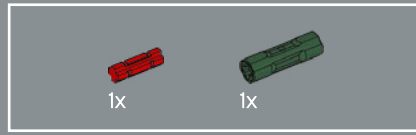
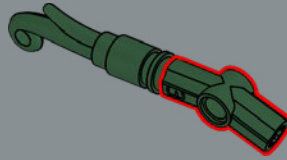

41

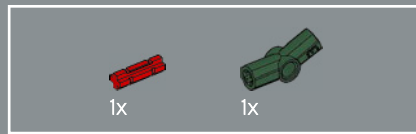
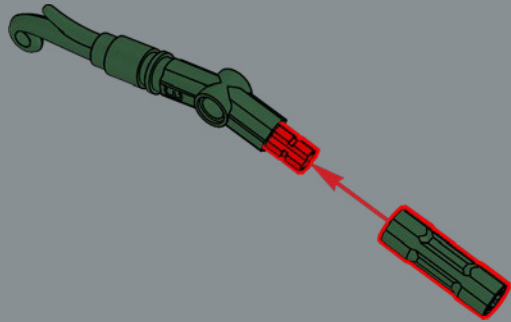

42

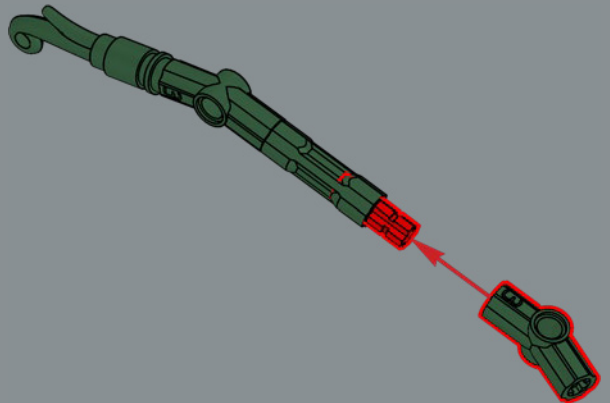

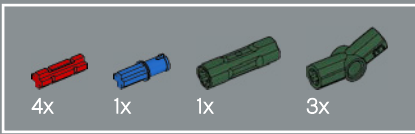

43

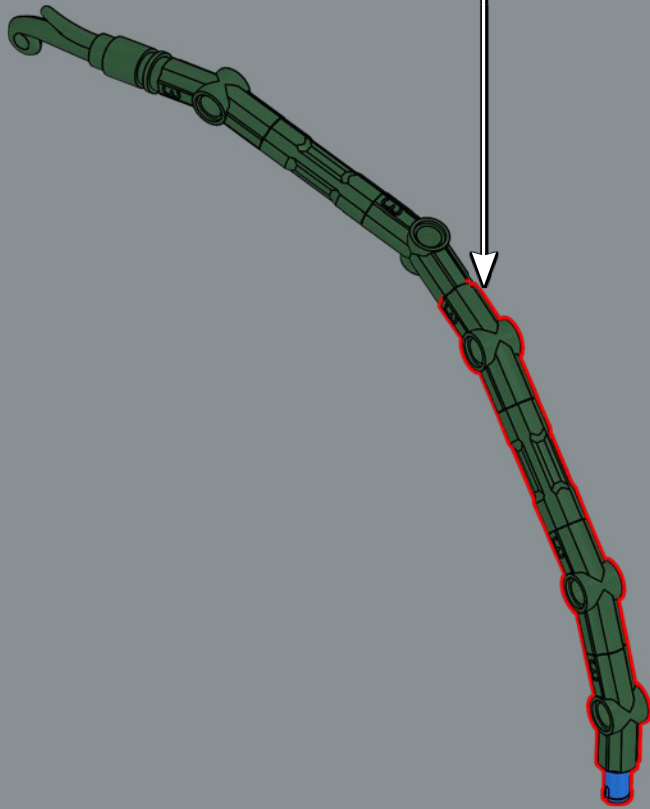
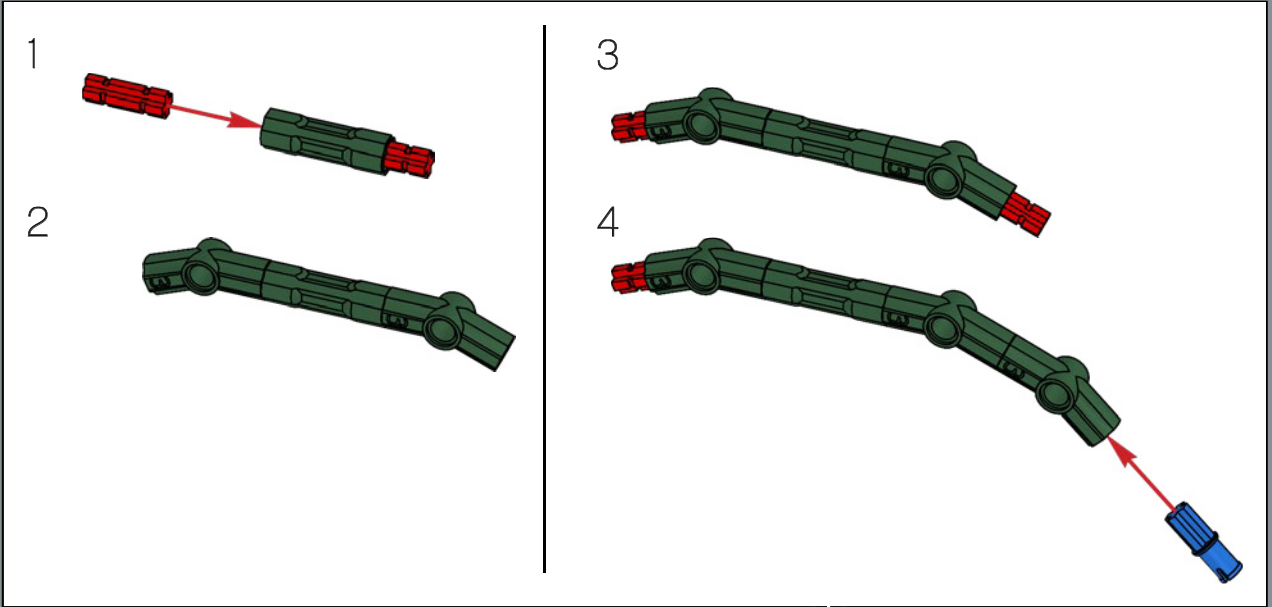



44

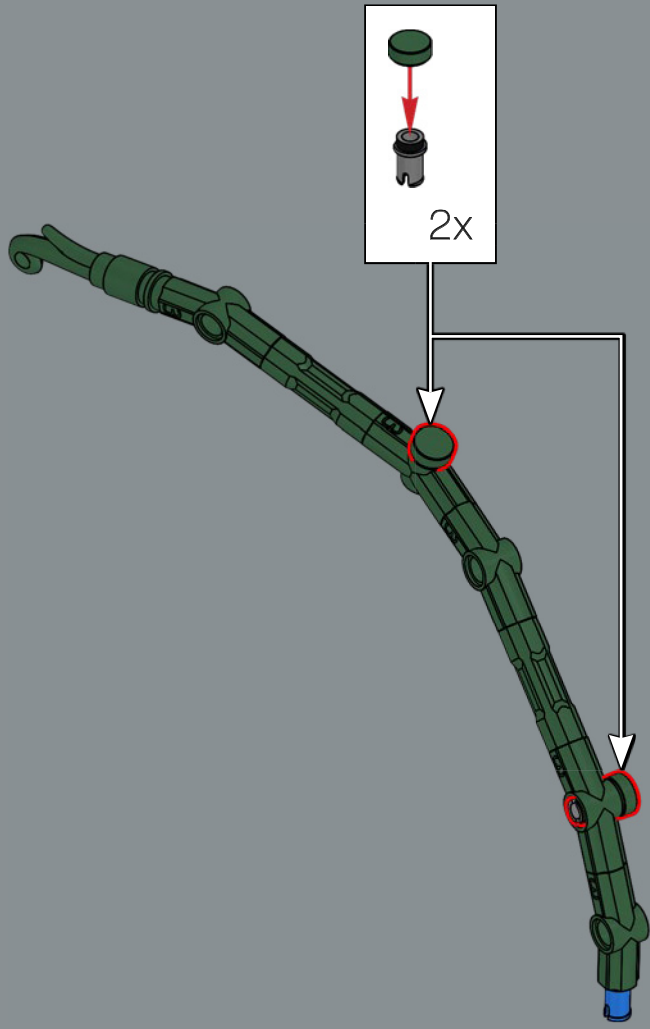

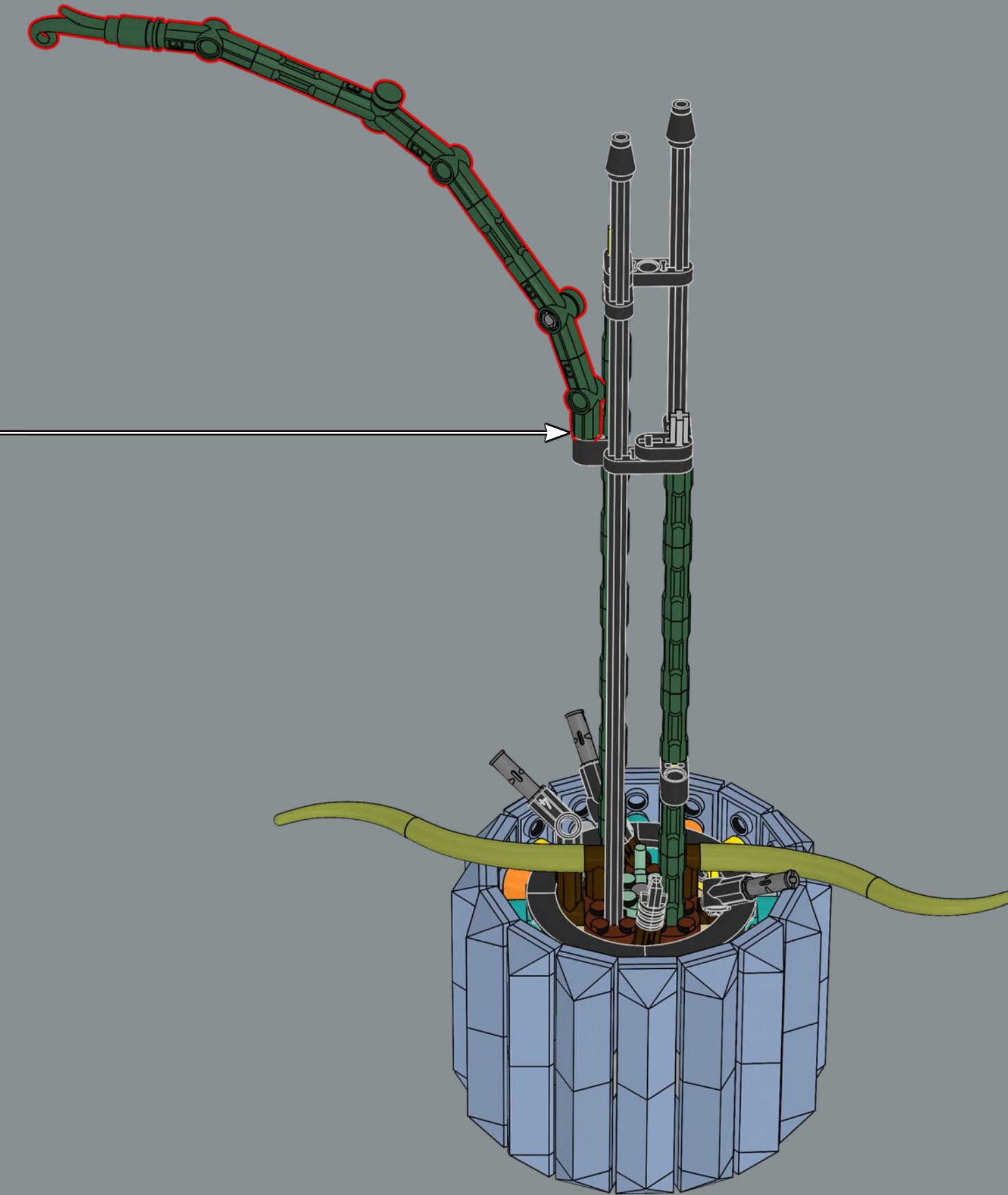

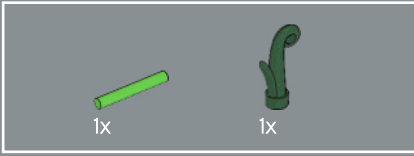
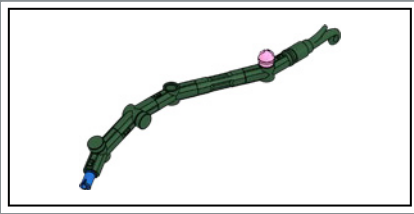

46

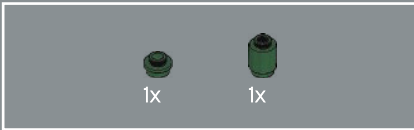
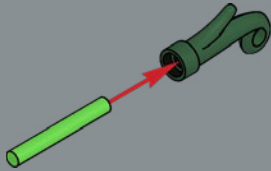

47

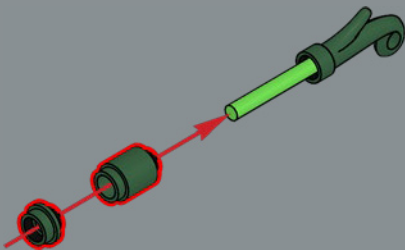

48

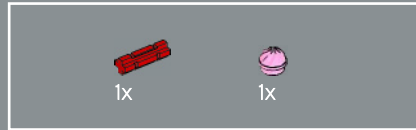
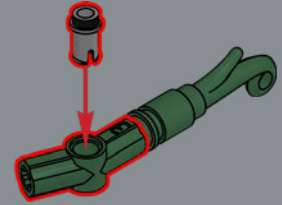

49

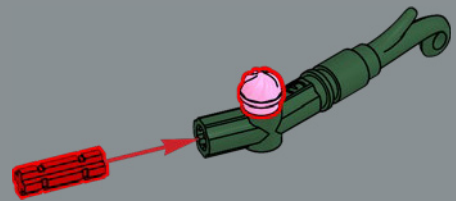

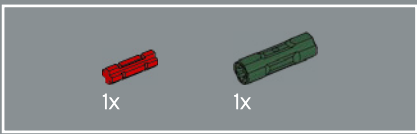

50

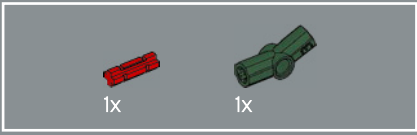
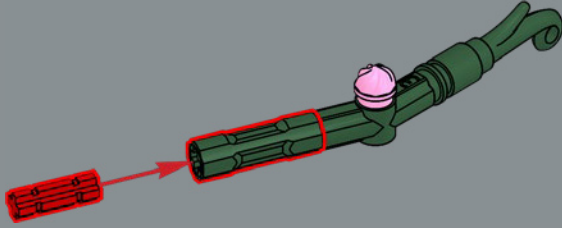

51

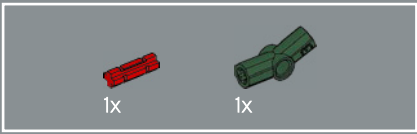
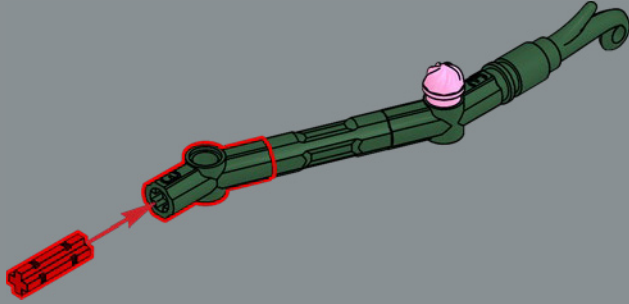

52

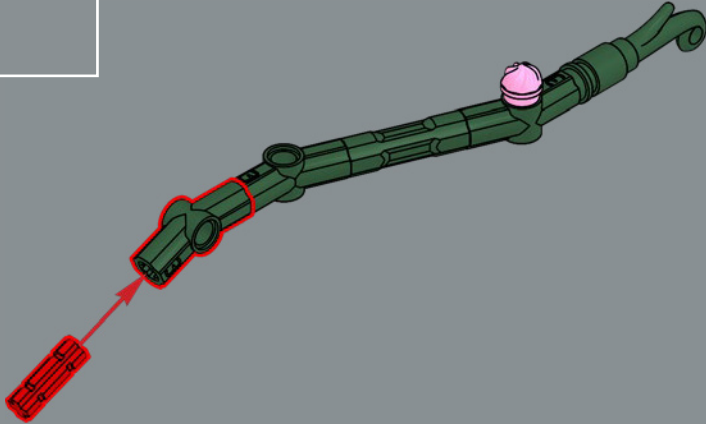

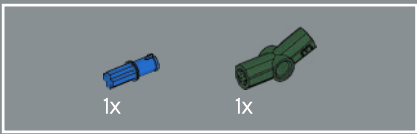

53

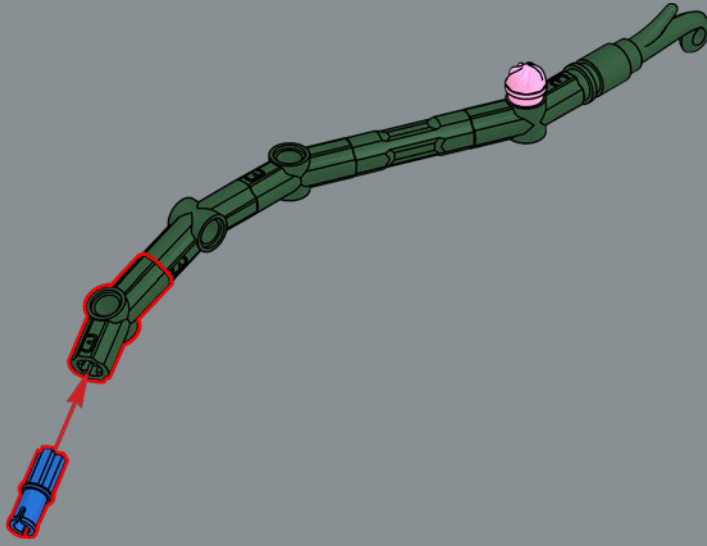

54

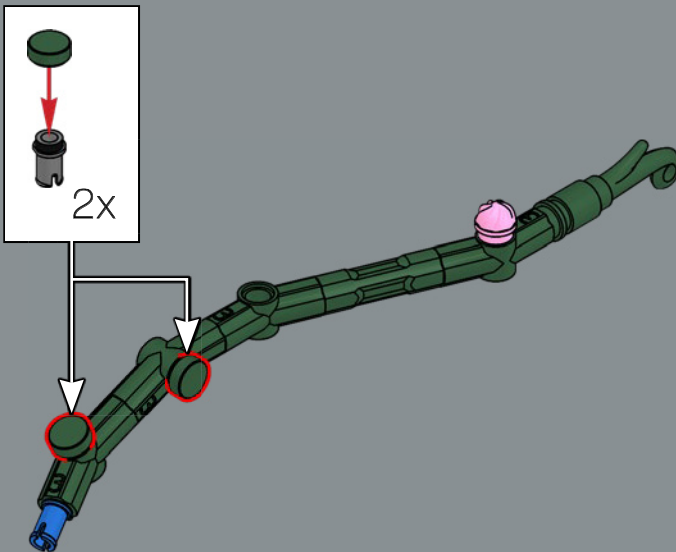



The orchid's stems are built from LEGO® Technic elements, making your orchid fully customisable to bloom all year round.

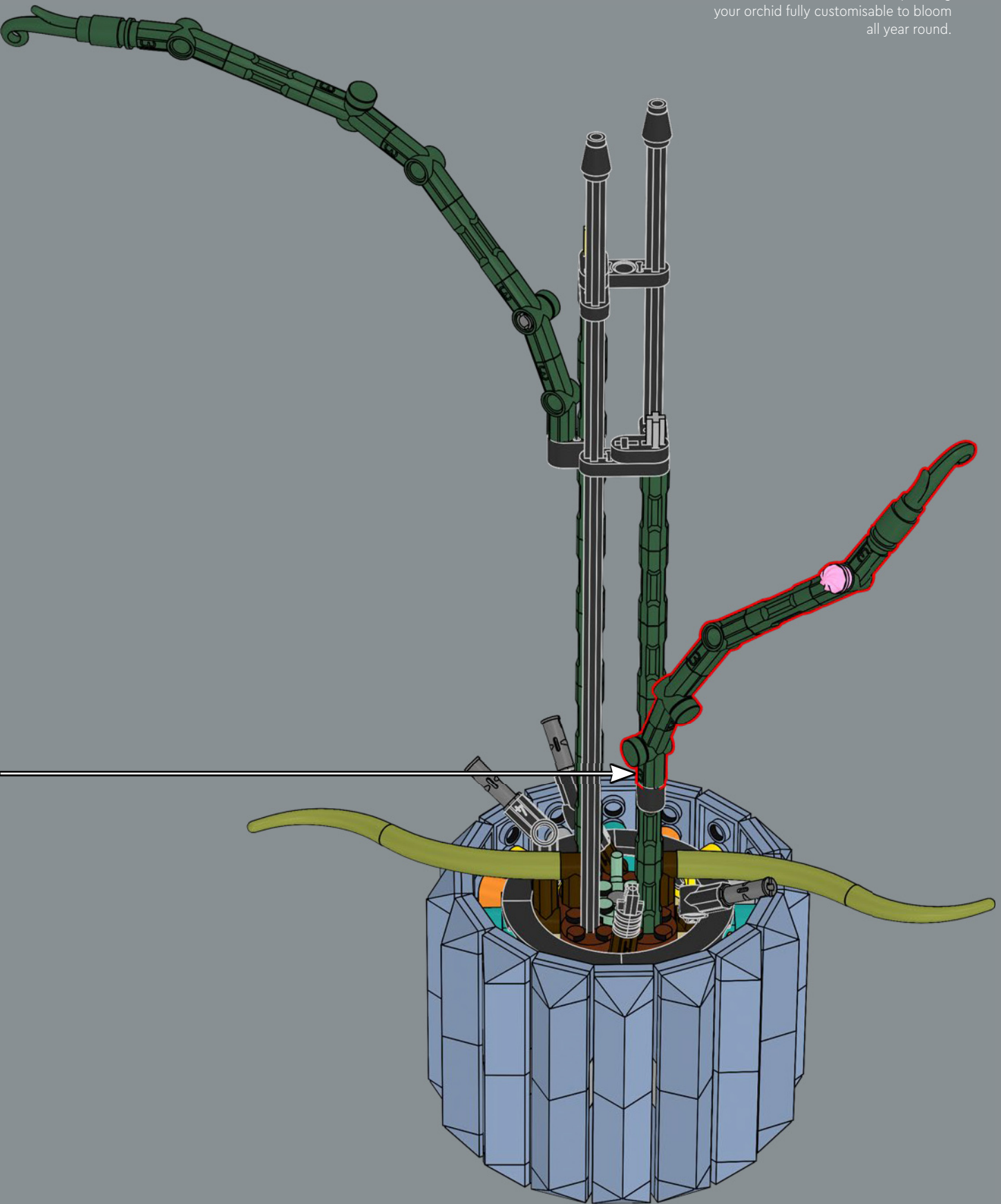

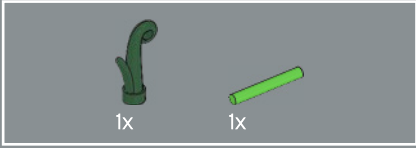
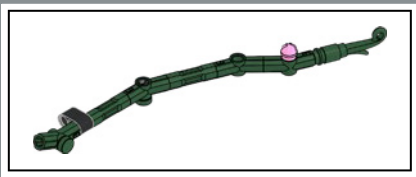

56

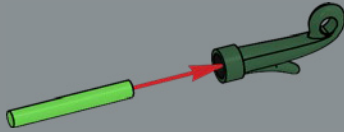

57

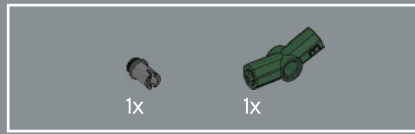
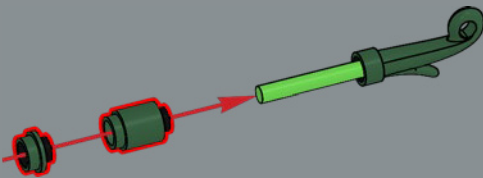

58

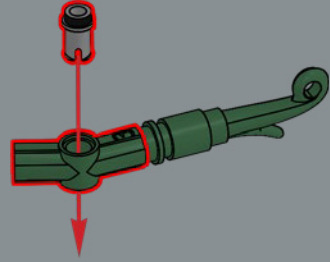

59

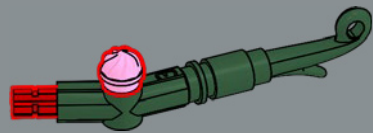

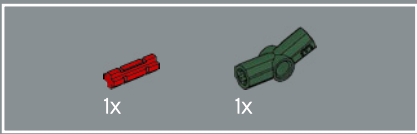

60

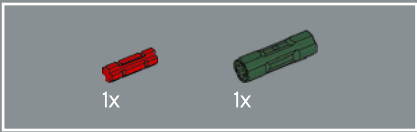
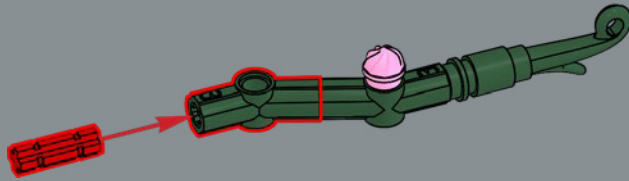

61

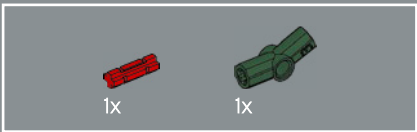
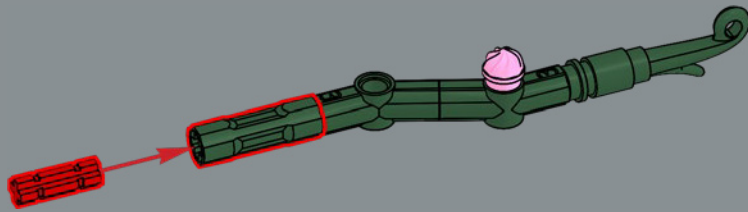

62

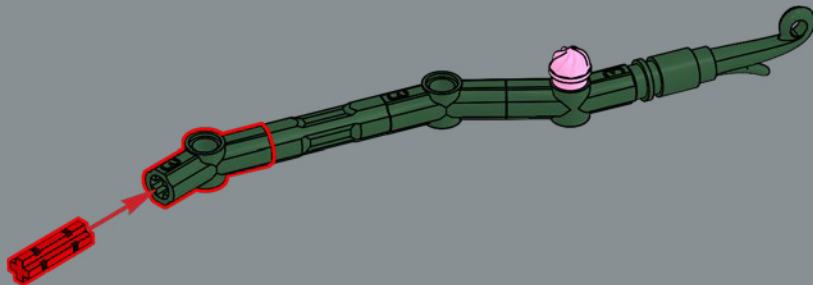

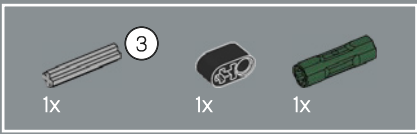

63

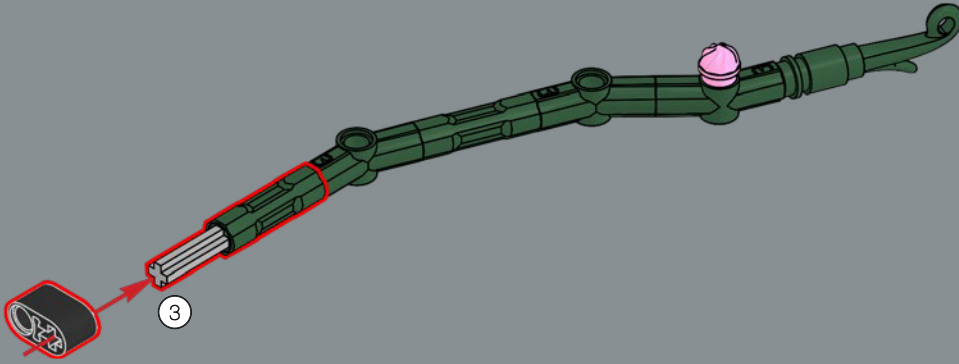

64

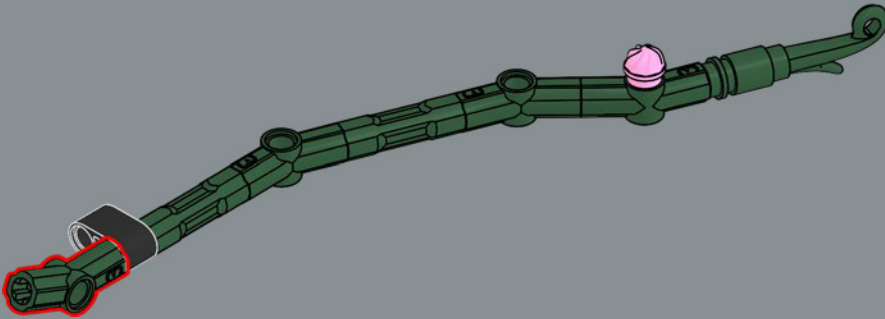

65

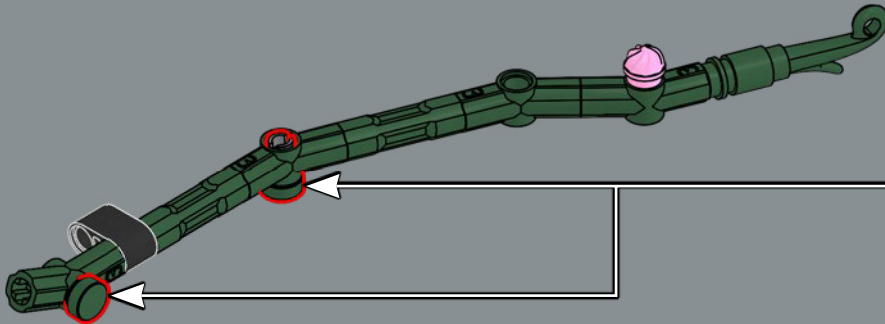

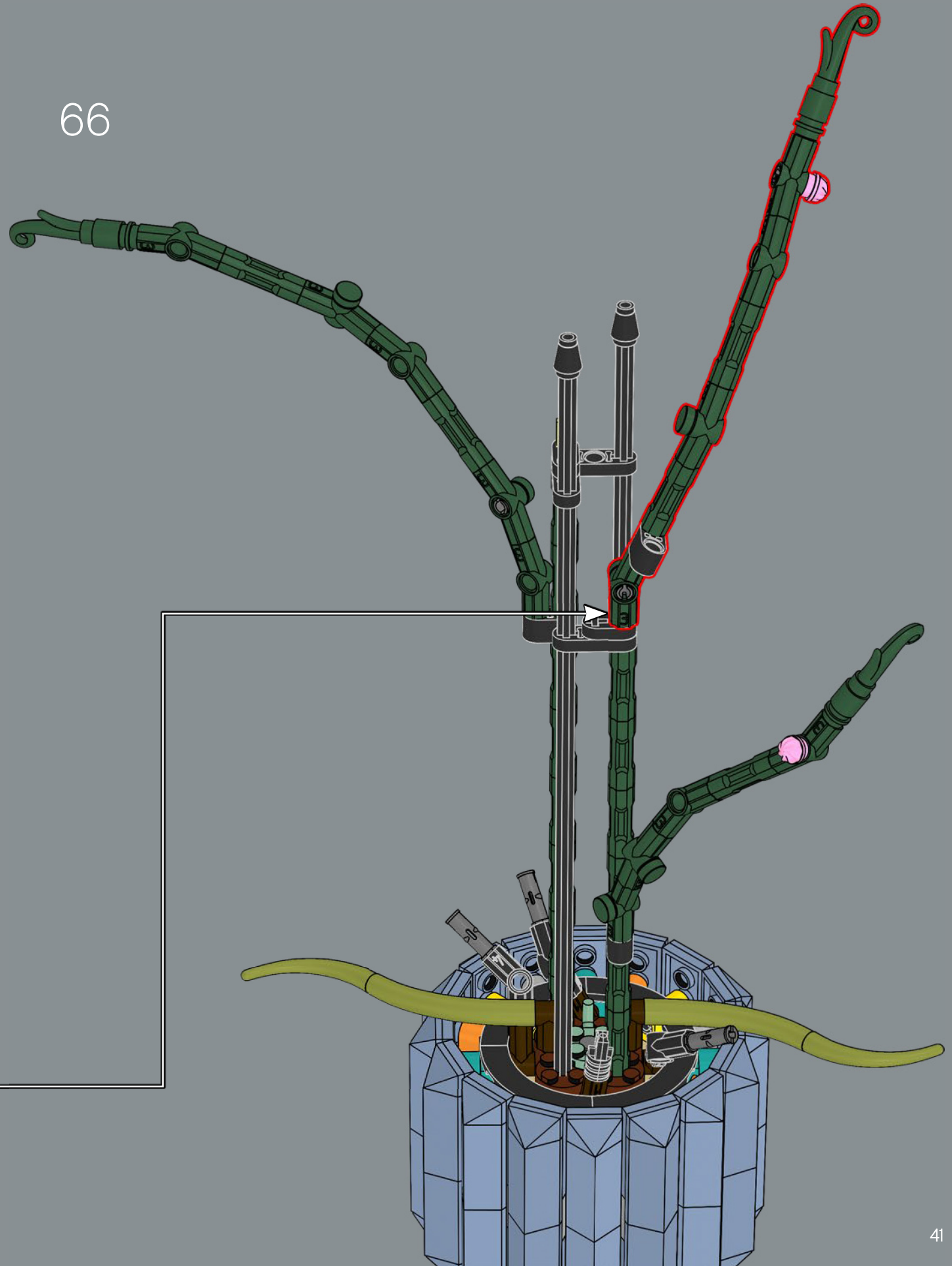

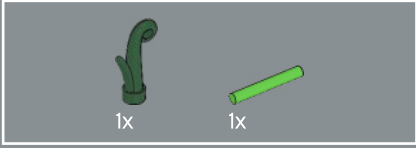
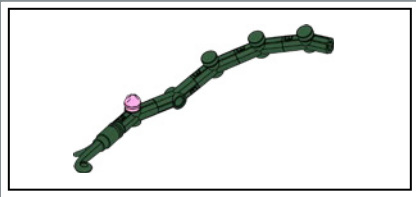

67

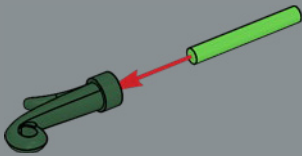

68

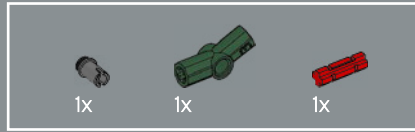
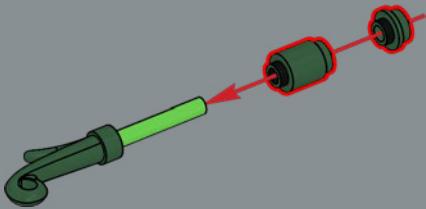

69

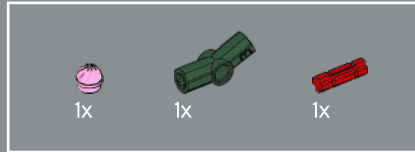
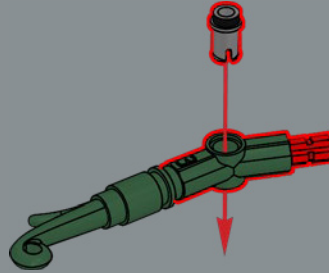

70

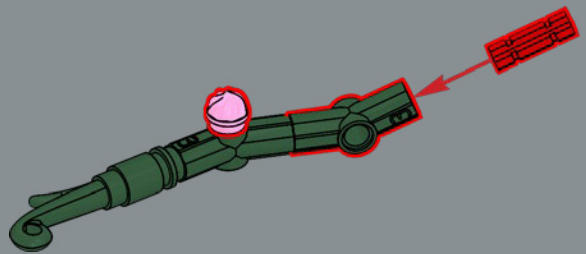

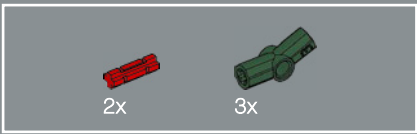

71

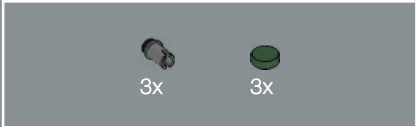
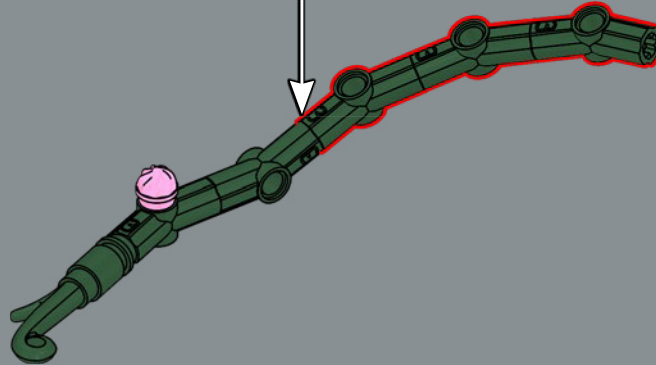
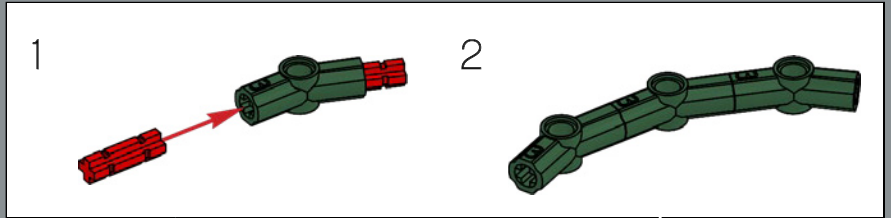

72

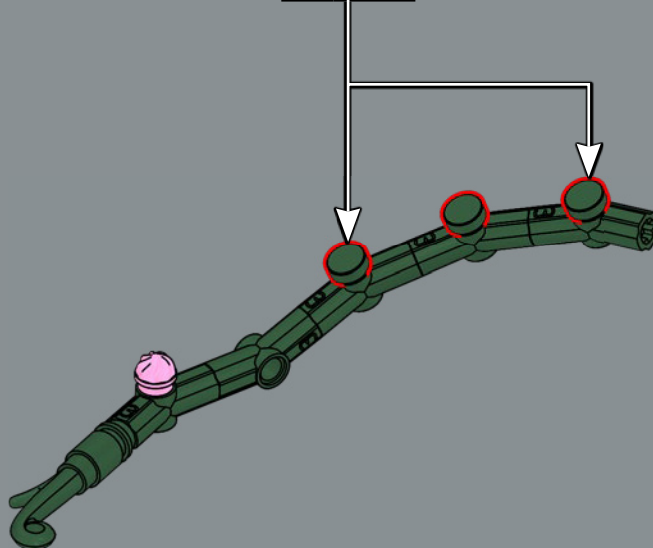
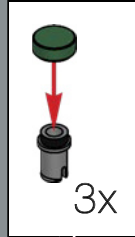

73

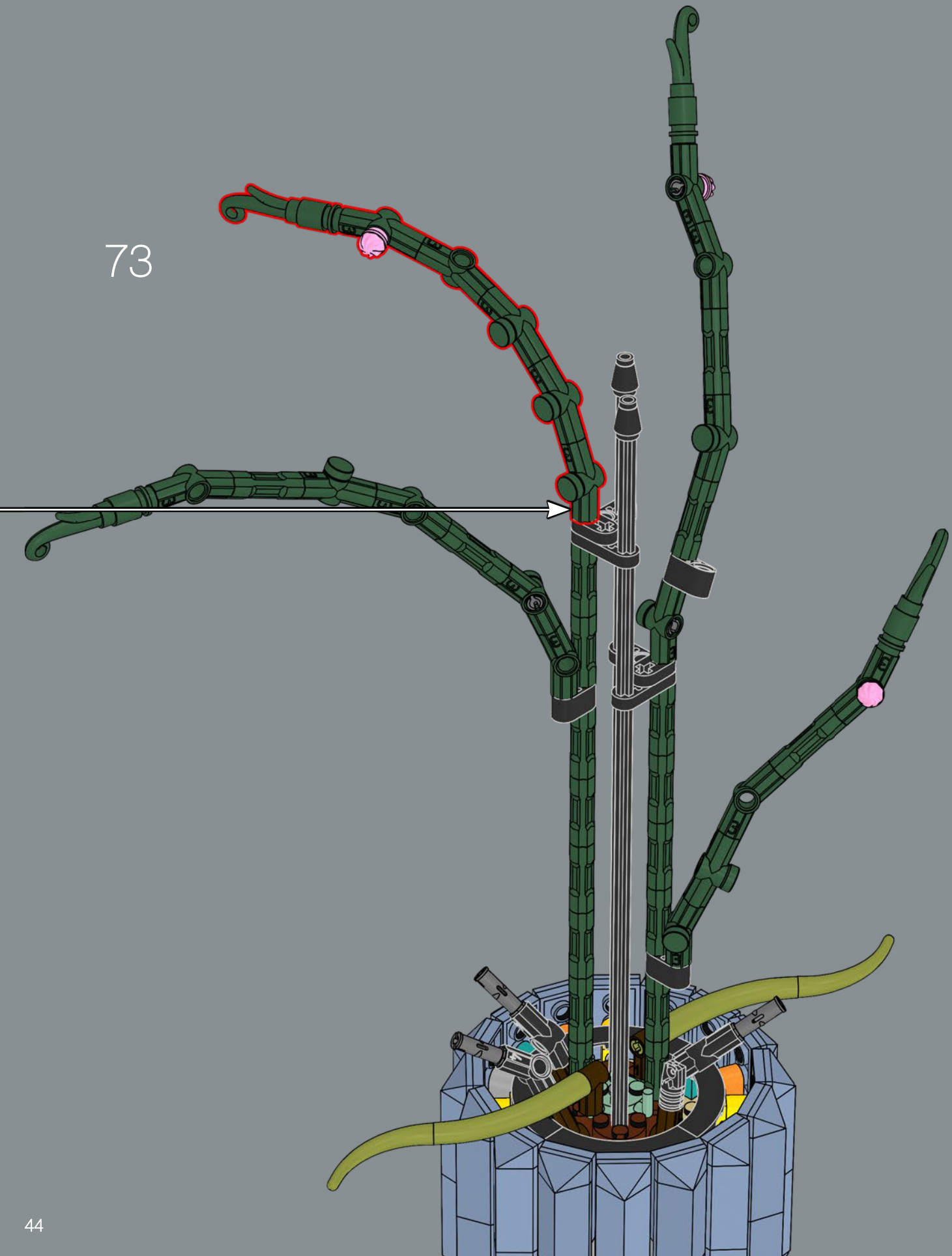

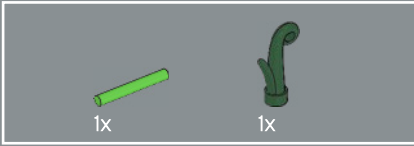
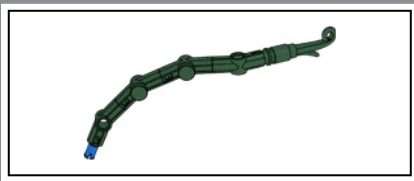

74

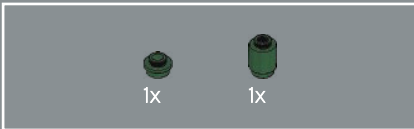
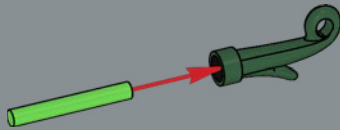

75

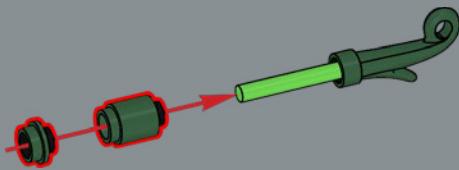

76

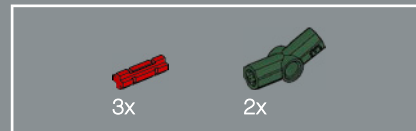
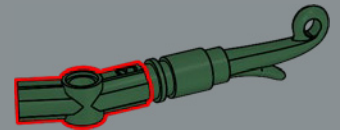

77

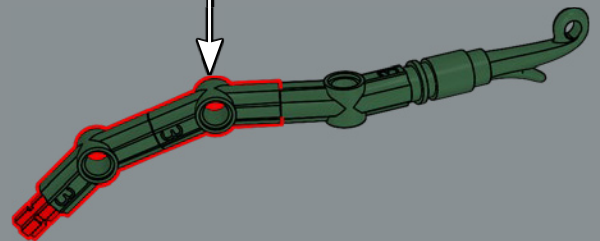
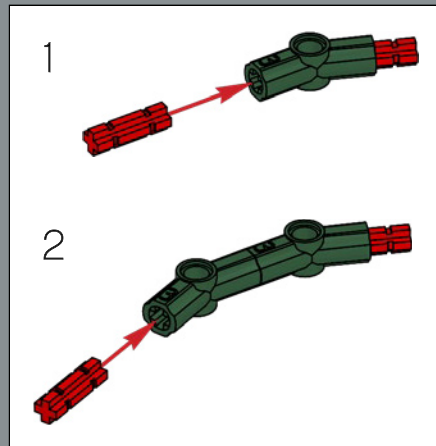

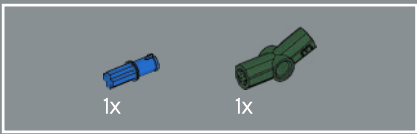

78

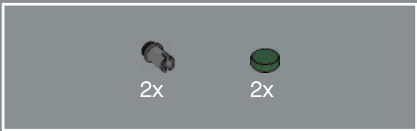
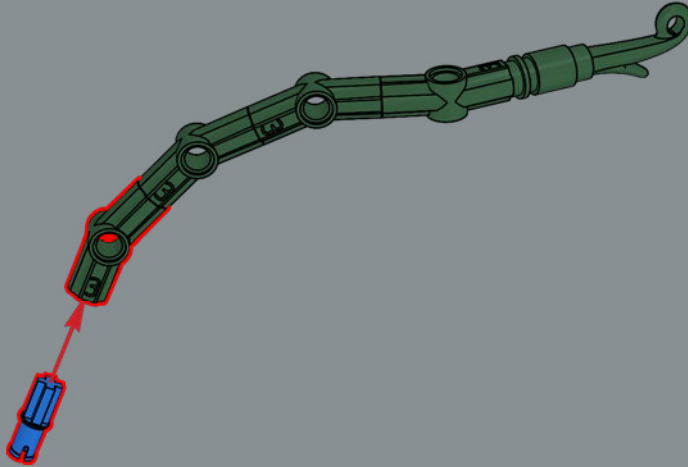

79

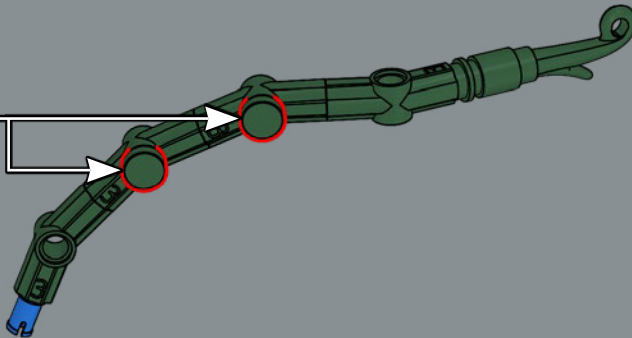
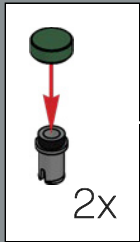

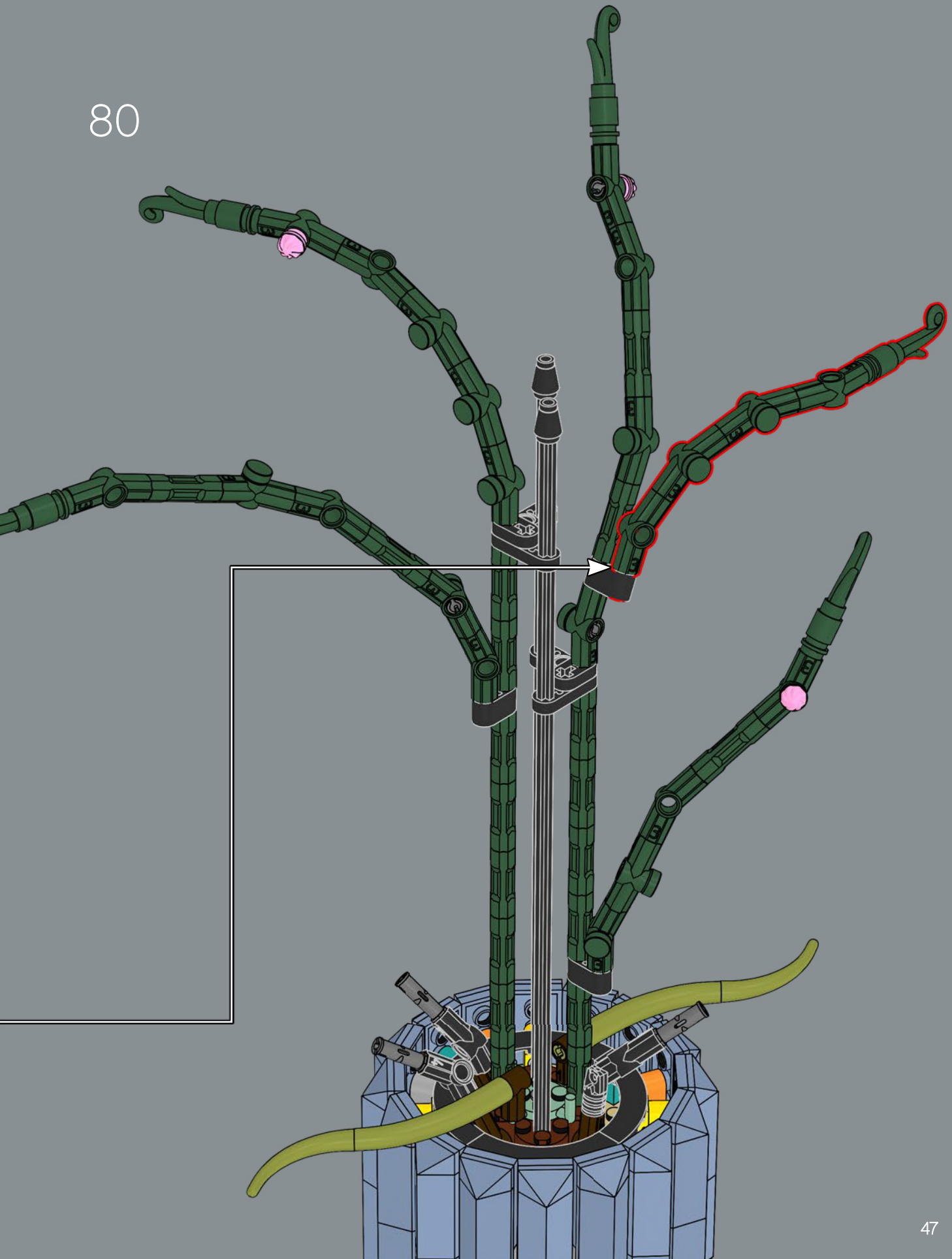



81

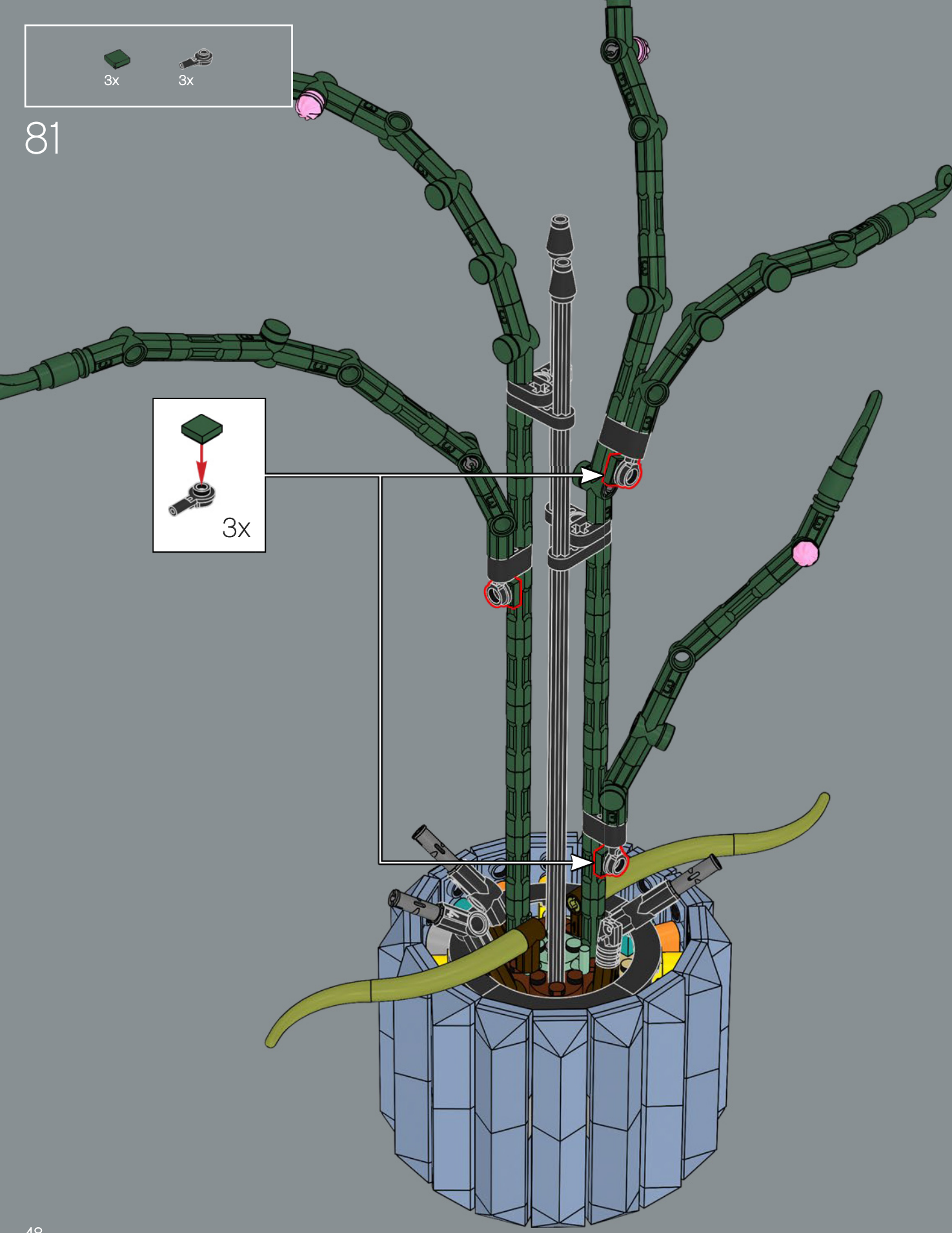
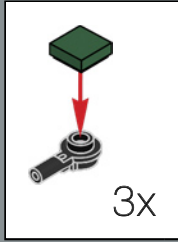

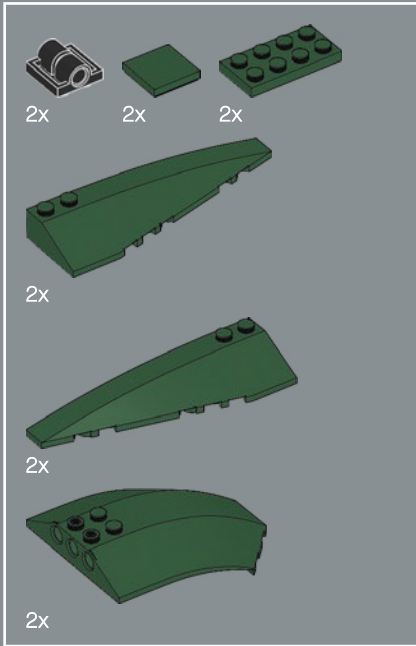
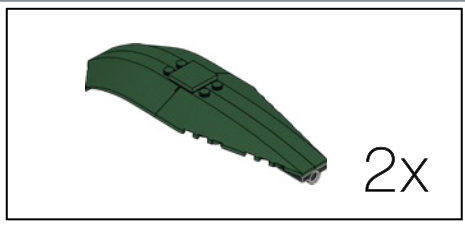

82

1

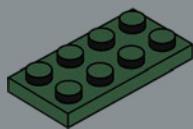

2

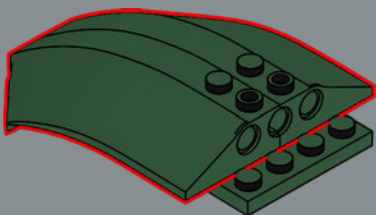

3

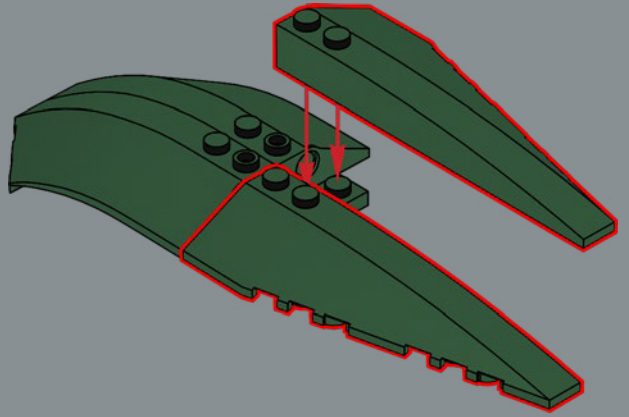

4

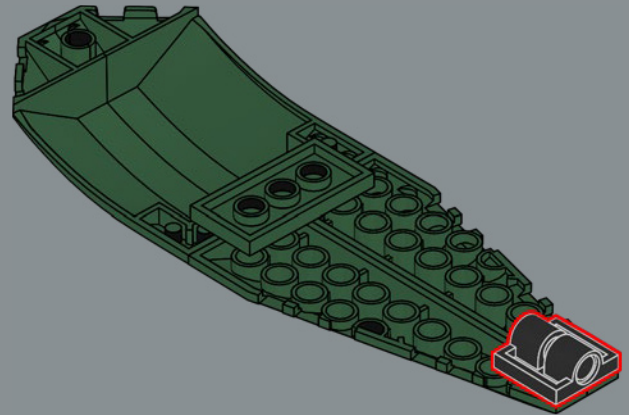

5

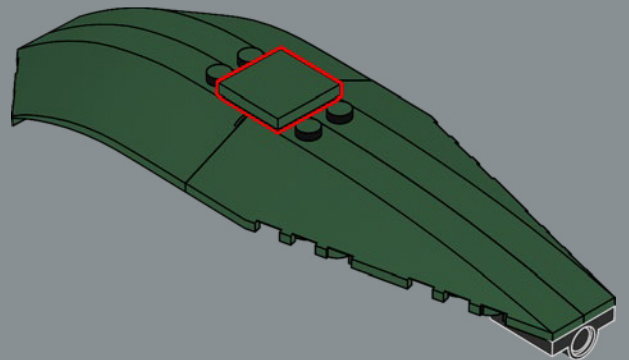

2x

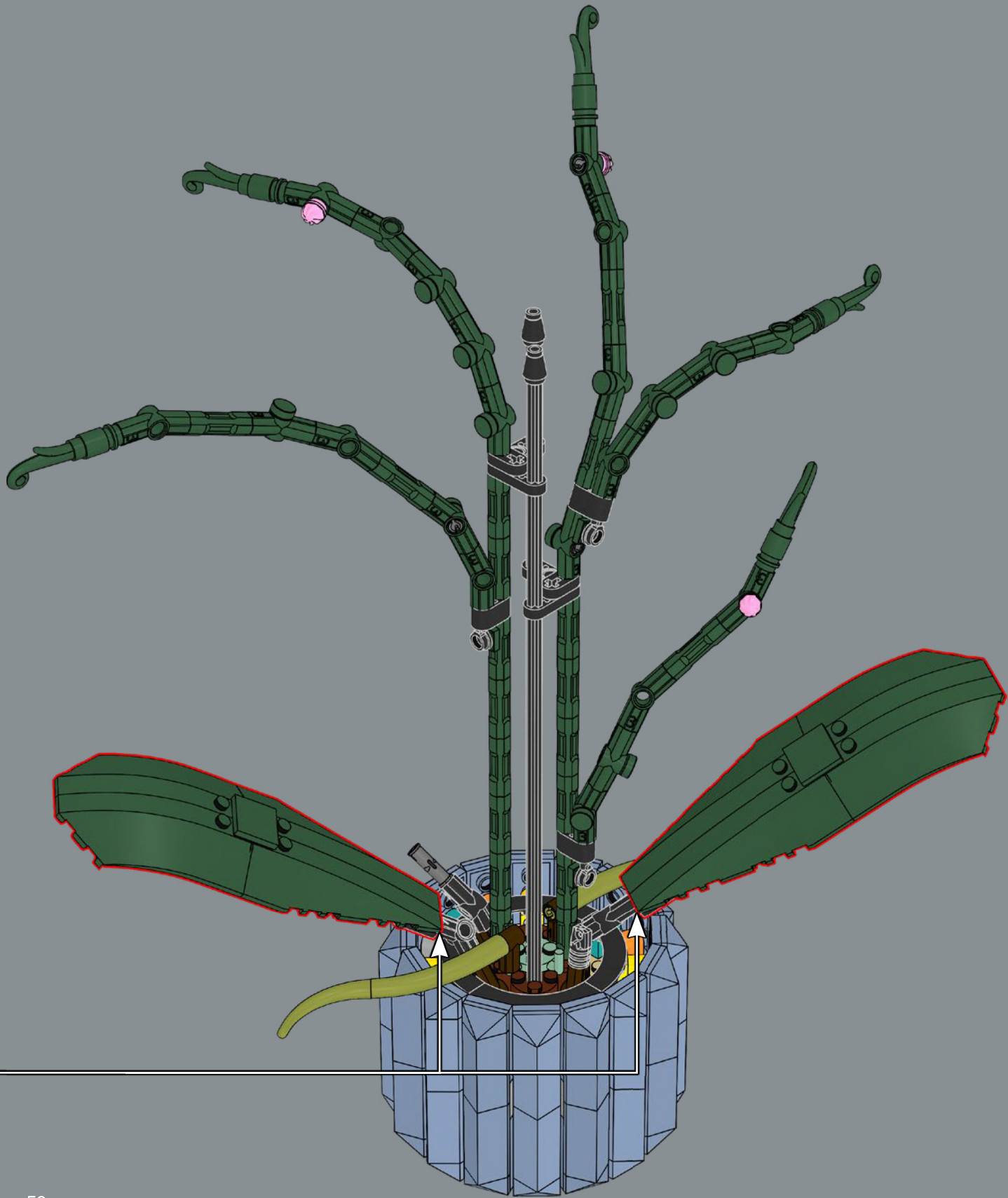

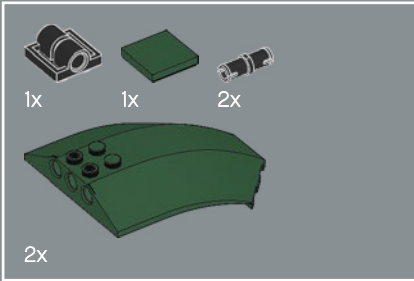
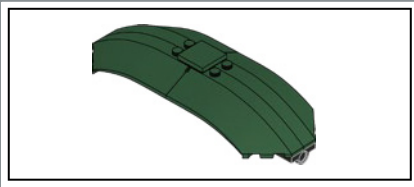

83

1

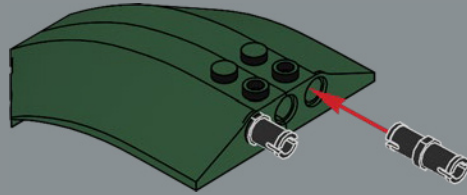

2

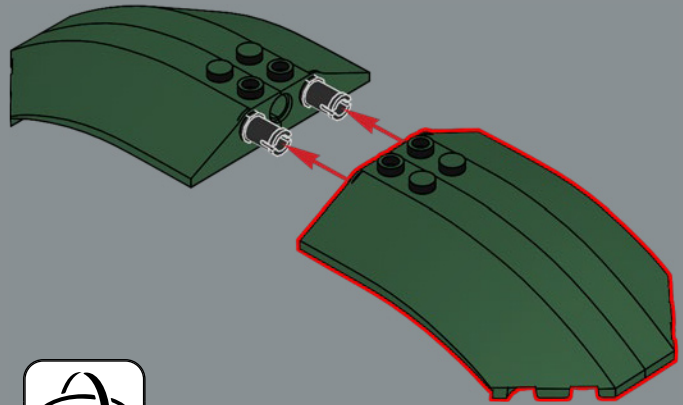

3

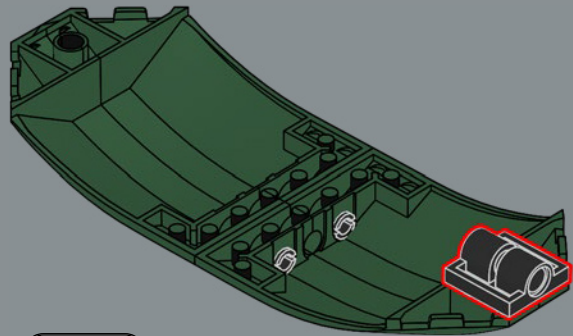

4

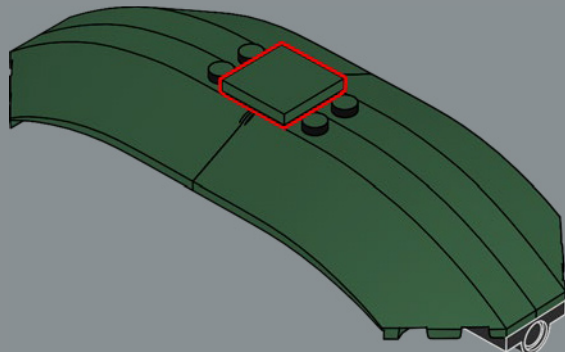

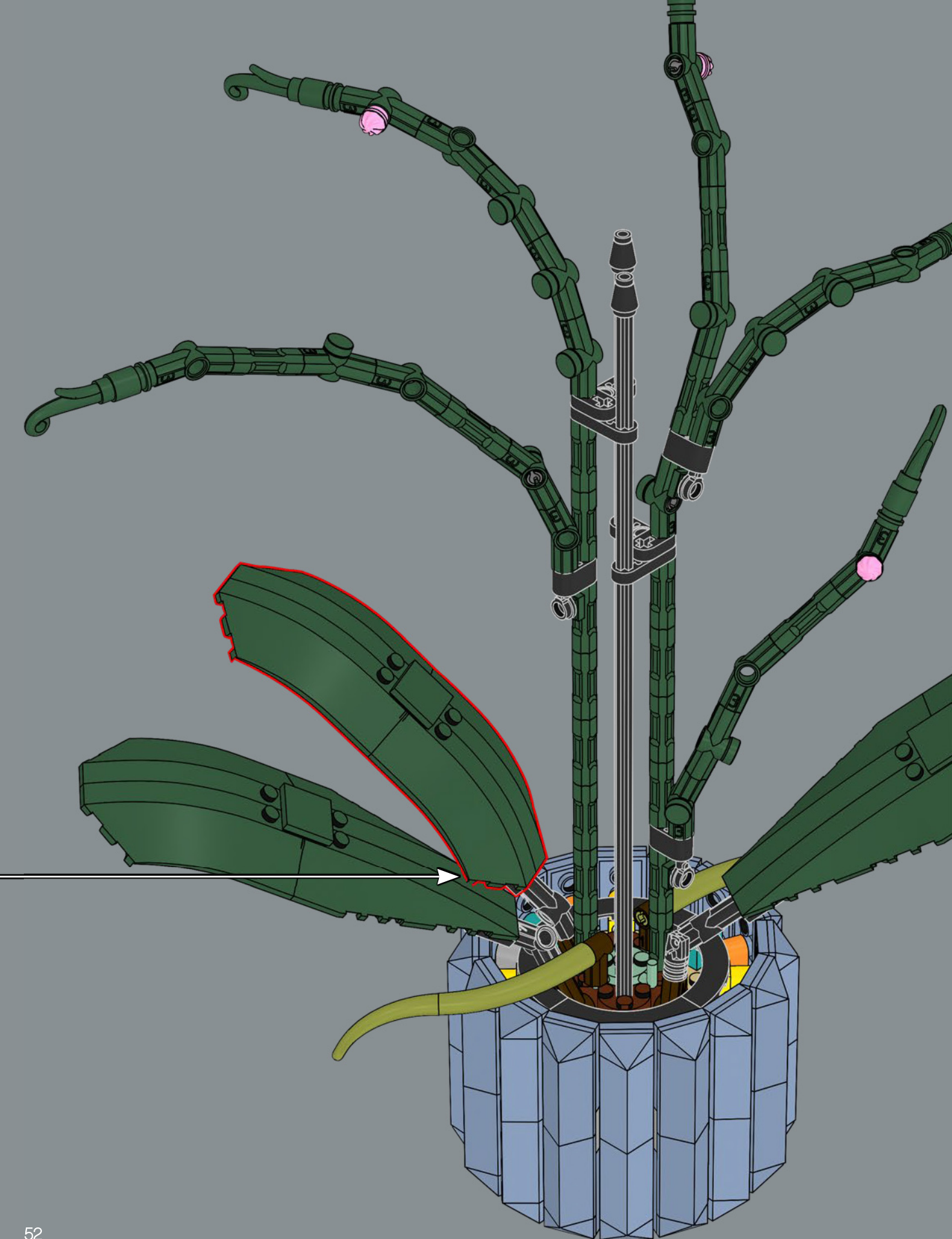

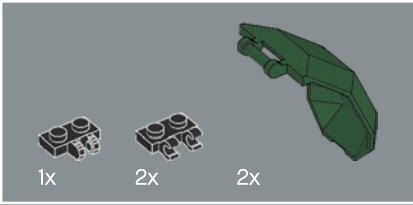

84

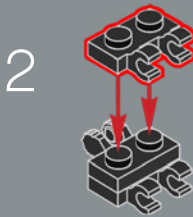
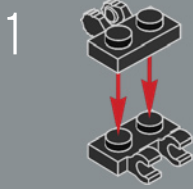

3

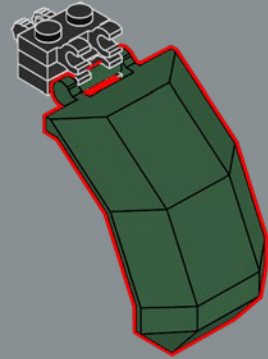

4

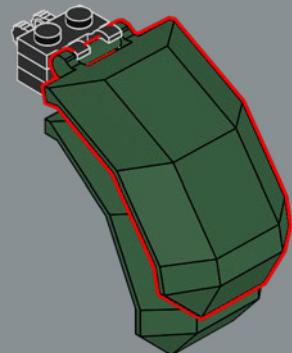

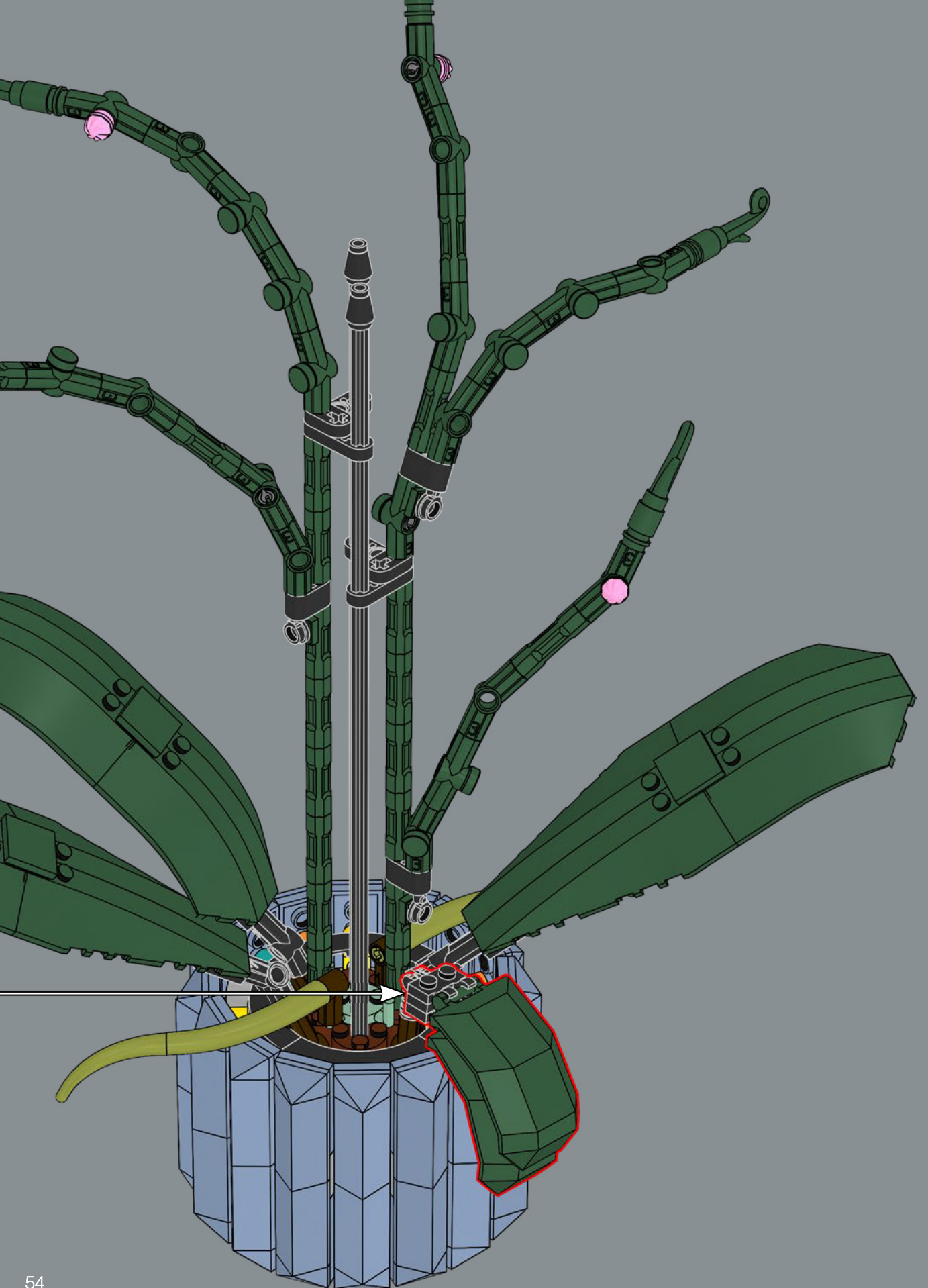



Demogorgon heads from the LEGO® Stranger Things set were used to make the small blossoms in this set.





85

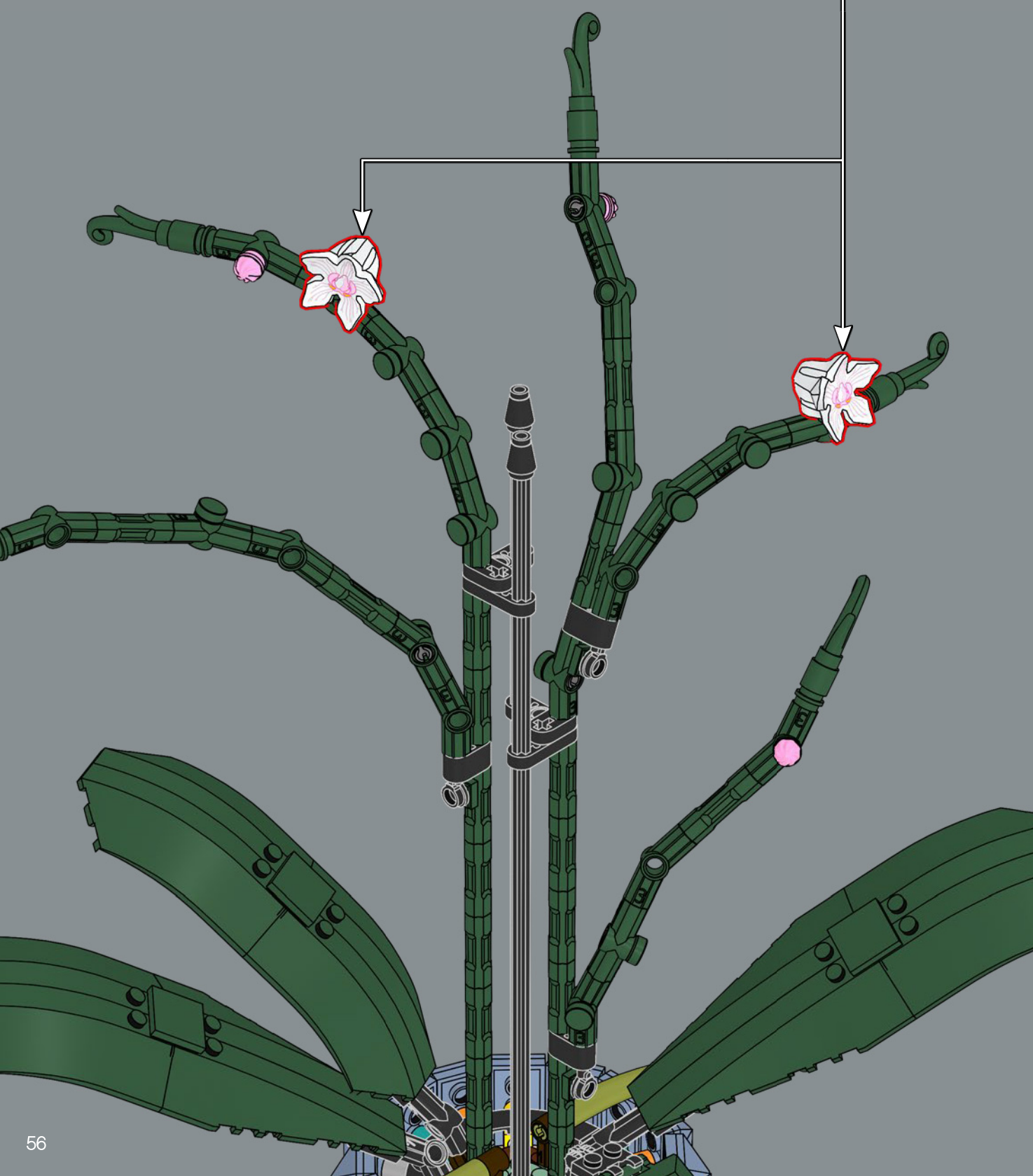
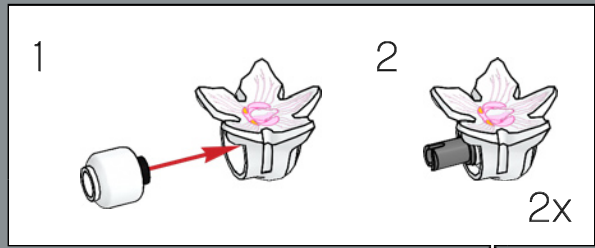

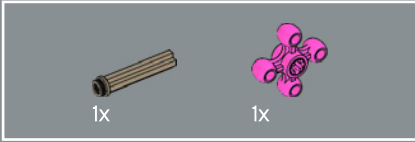

86

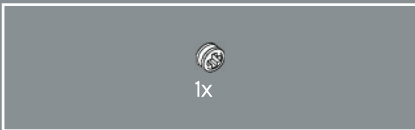
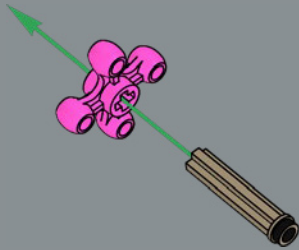

87

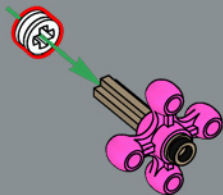

88

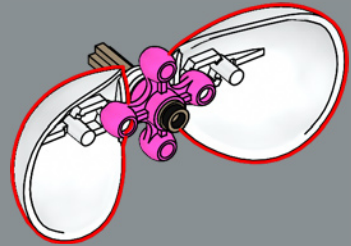

89

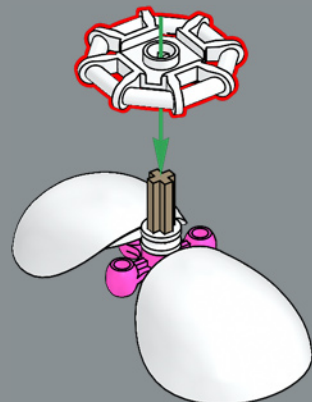

The orchid petals are built with shoulder pad elements from large LEGO® characters.

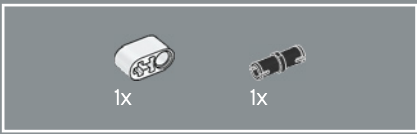

90

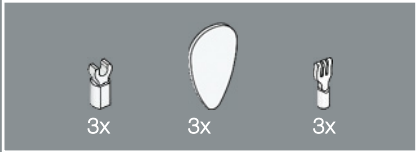
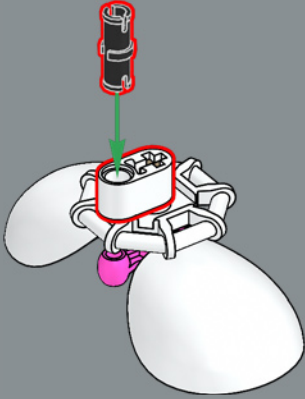

91

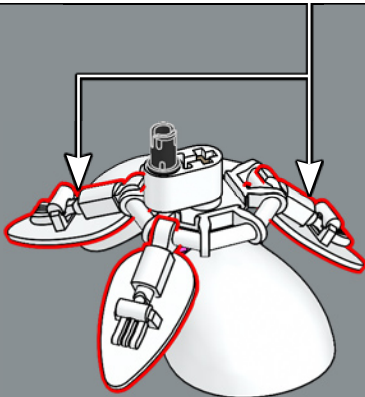
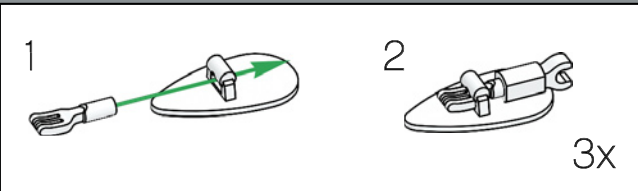

92

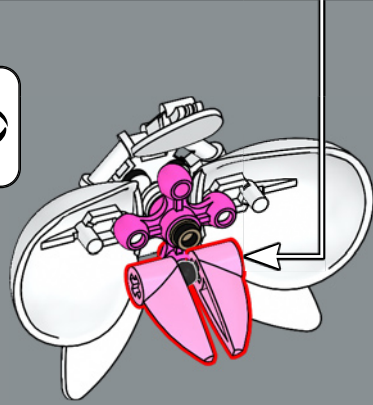
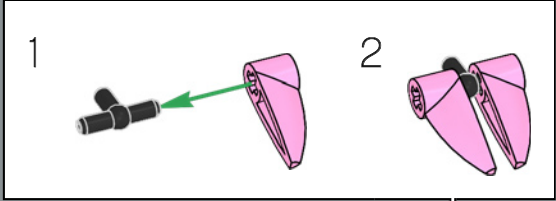

93

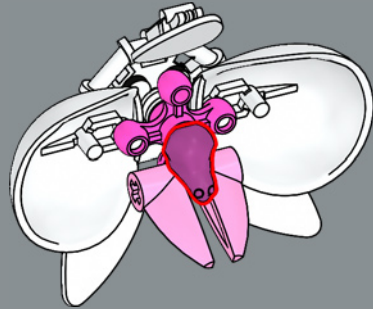

6x



The centre of the blossoms feature LEGO® frog elements – an homage to the pink frogs used as blossoms in the LEGO Bonsai Tree set.

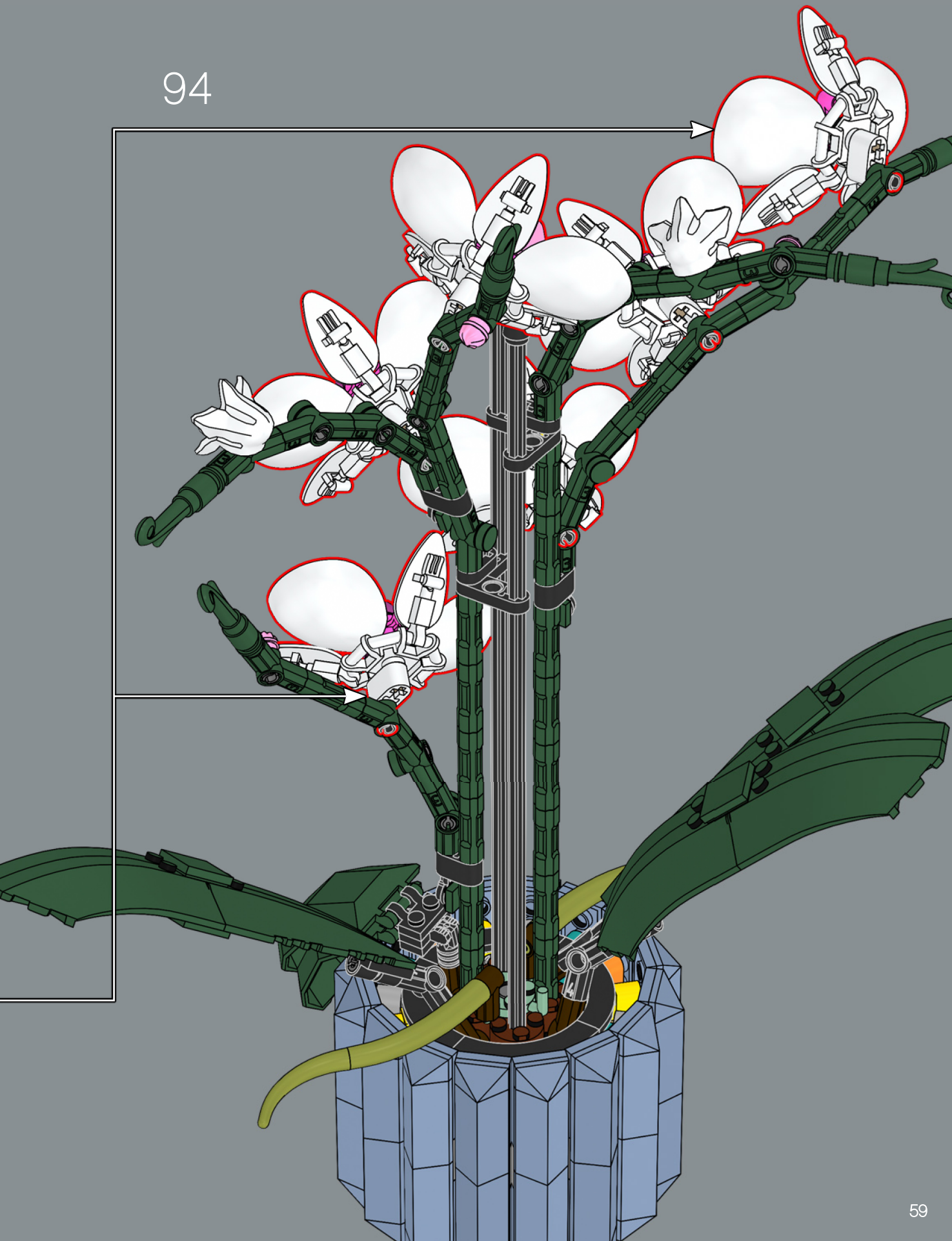



Minifigure shields originally developed for the 1995 LEGO® Castle Line make up the sepals of the orchid.

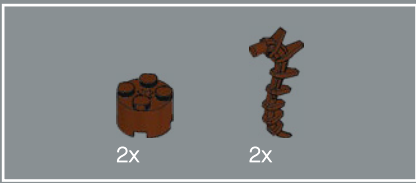

2x

2x

95

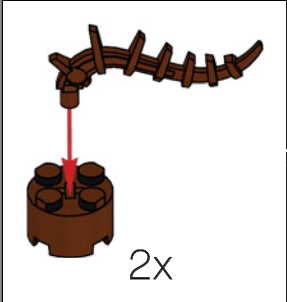
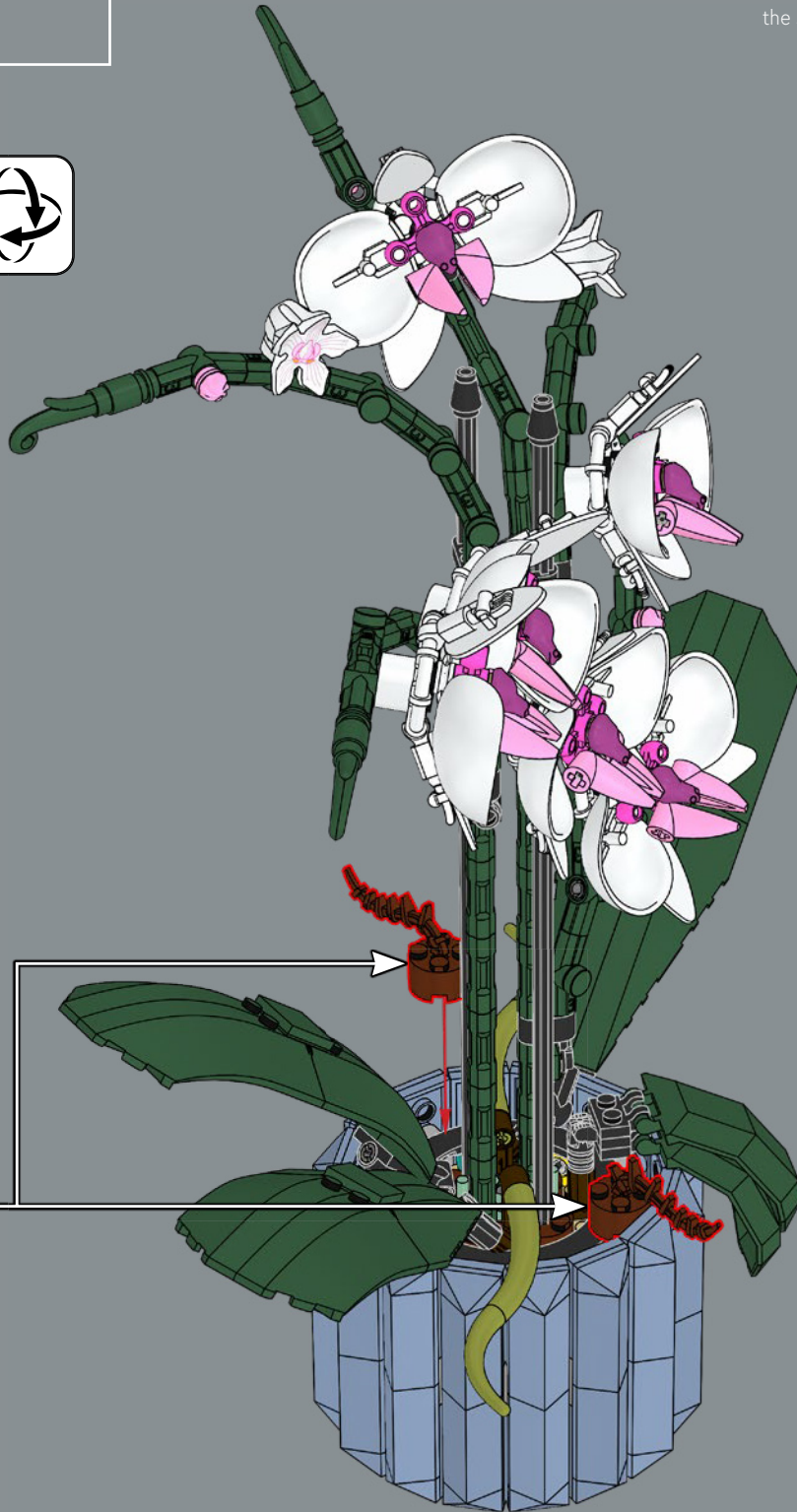

2x



Orchids are often potted with mulch to allow air flow and drainage for healthy roots. Here, the mulch is built from claw elements from LEGO® Nexa Knights sets.



96





1x
4558956



6x
6265135



6x
6009016



8x
6195358



2x
362601



2x
6302214



18x
6395857



18x
6395620



12x
6390377



18x
6341465



6x
6360263

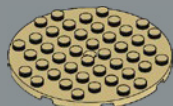

4x
6378358



3x
4206482



8x
6299413



8x
654124

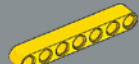

4x
4495934



3x
6130007



2x
4529236



3x
6265091



3x
6196548



1x
6266207



2x
6310268



3x
281726



8x
6171264



2x
6338428



2x
6271810



1x
6265699



24x
6279875



3x
6262897

7

3

7

7



6x
6104209



2x
403228



5x
6161772



8x
6136553

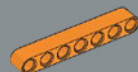

4x
6339024



2x
6030521

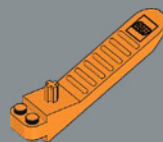

1x
6240515



8x
6345402

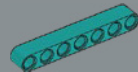

4x
6323477



8x
6325515



32x
6392959

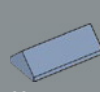

32x
6395798



32x
6248957

3.2



6x
6031821



5x
6253282

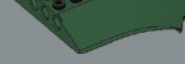

4x
6392976

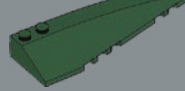

2x
6392970

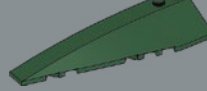

2x
6392971



3x
6055171



3x
4528778



2x
4586057



11x
6397157



5x
6230571



5x
6396754

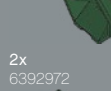

2x
6392972



22x
6344177



19x
6330196



1x
6329274



8x
4211535



4x
4495930



16x
6276848



2x
4211815

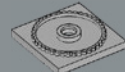

3x
6045718



16x
6395635



3x
6015356

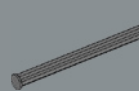

1x
4499858



6x
6380668



3x
6060795



12x
6395623



2x
6313597



32x
6378120



37x
4142865



6x
6395622

7

3

8



6x
4211166



6x
6075213



2x
6270052



7x
6251403



7x
6353396



6x
6332586



2x
6351430



2x
6351434

32

2x
6210821



Customer Service

Kundenservice

Service Consommateurs

Servicio Al Consumidor

LEGO.com/service or dial



00800 5346 5555 :



1-800-422-5346 :





FEEDBACK AND WIN

FEEDBACK AND WIN

Your feedback will help shape the future development of this product series.

Please visit:

FEEDBACK UND GEWINNEN

Dein Feedback trägt zur Weiterentwicklung dieser Produktreihe bei.

Geh auf:

COMMENTEZ ET GAGNEZ

Vos commentaires nous aideront à concevoir les futurs produits de cette gamme.

Rendez-vous sur :

COMENTA Y GANA

Tu opinión nos ayudará a dar forma al desarrollo de esta serie de productos en el futuro.

Visita:

反馈有奖

您的反馈将有助于我们在今后改进本系列产品。

请访问：

[LEGO.com/productfeedback](https://www.lego.com/productfeedback)

By completing, you will automatically enter a drawing to win a LEGO® set.

Terms & Conditions apply.

Durch Ausfüllen nimmst du automatisch an der Verlosung eines LEGO® Preises teil.

Es gelten die Teilnahmebedingungen.

En envoyant vos commentaires, vous serez automatiquement inscrit(e) à un tirage au sort qui vous permettra de remporter un prix LEGO®.

Offre soumise à conditions.

Al contestar, participarás automáticamente en el sorteo y podrás ganar un set LEGO®.

Sujeto a Términos y Condiciones.

完成我们的反馈调查，即可自动进入抽奖环节，赢取乐高®套装。

适用《条款和条件》。

