

Book 1



Booklet available in English on
Heft in deutscher Sprache erhältlich auf
Livret disponible en français sur
Libretto disponibile in Italiano su
Folleto disponible en español en
如需中文版手册, 请访问

The LEGO® Succulents

Some are prickly and still somehow adorable: Others are plumply and still look so chic. Home design gurus say they can easily perk up any corner of your room. And they are the perfect houseplants that make even a newbie plant parent look like a pro. Meet the LEGO® Succulents.

Succulents make fabulous table centrepieces, can dress up windowsills, and make any space instantly, insta-worthy.



They say having succulents in a room helps you focus, and building this set is likely to give you the same feeling. On the plus side, you don't have to water them!





*Build pot by pot, or
group them all together,
either way is smile
inducing.*

There's a succulent for everyone

Unlike other plants in the LEGO® Botanical Series, each LEGO Succulent can be built in its own individual little pot, which can be either connected to make a beautiful group of succulents or showcased separately. Instructions to build also come in separate booklets so that family and friends can all enjoy the LEGO building experience together.

From the Design Team

Andy comes from Southern California, where succulent gardens thrive and are known for their beauty. "My friends are all expert keepers of these desert jewels while I, on the other hand, never had such luck. So, being able to pay tribute to my home with this LEGO® set was indeed a dream project. No succulent was harmed in the making of this set!" said Andy, which was a happy first for him.

*Anderson Ward Grubb
Senior Designer*



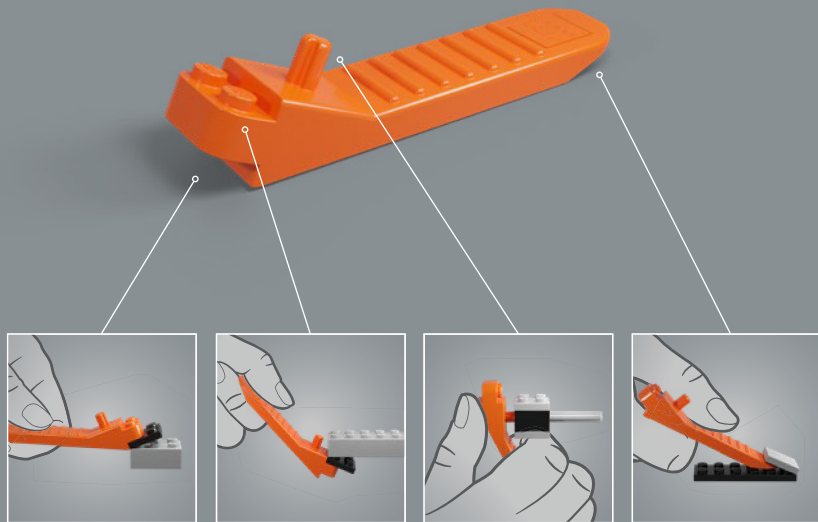



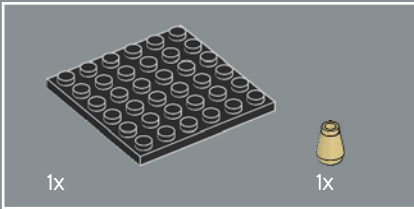
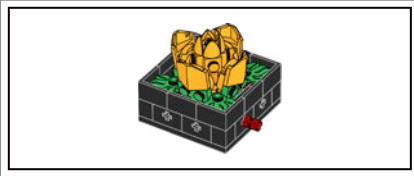

1

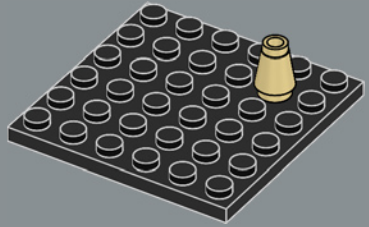

2

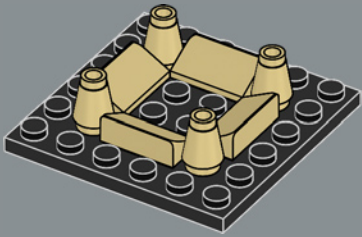

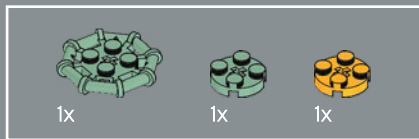

3

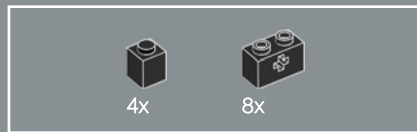
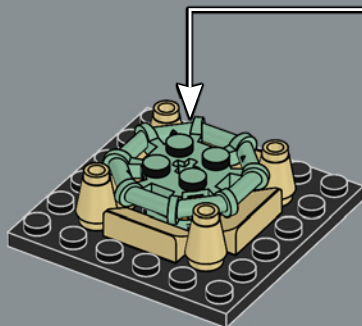
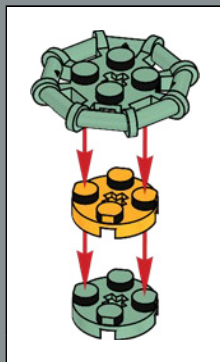

4

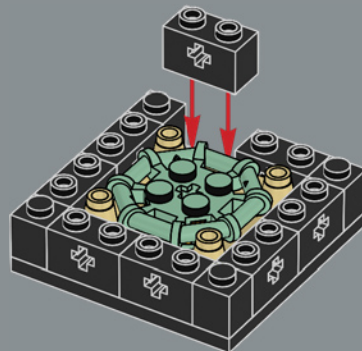

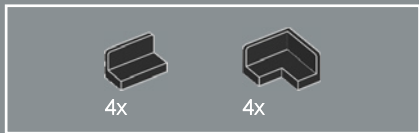

5

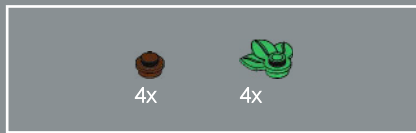
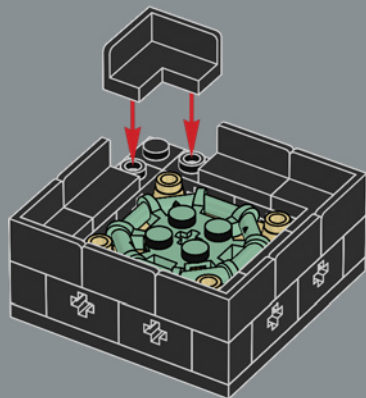

6

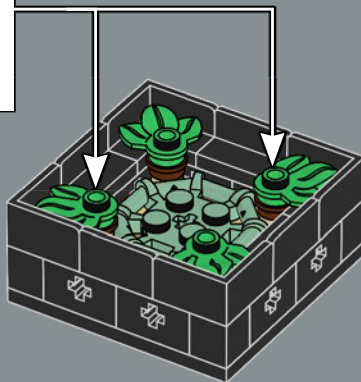
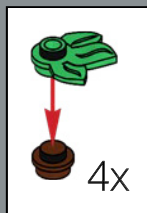

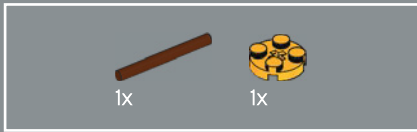

7

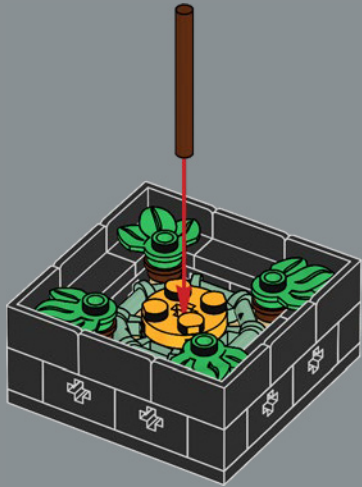

8

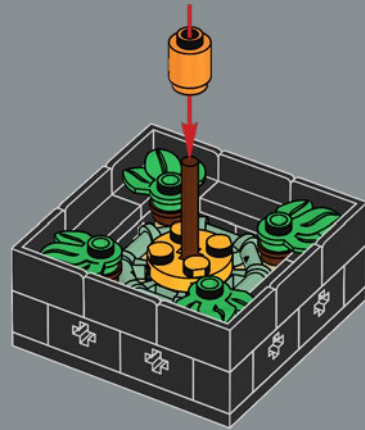



9

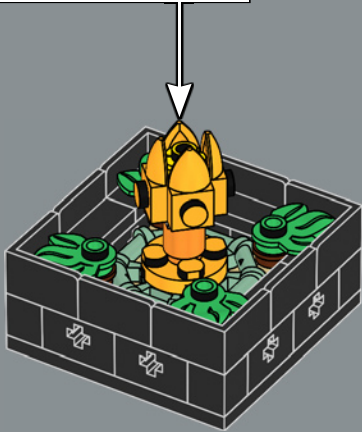
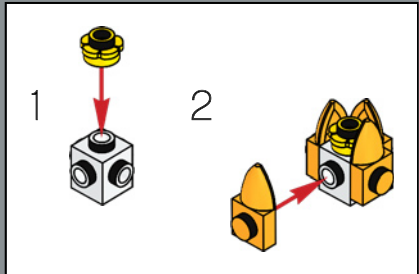

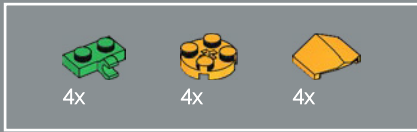

10

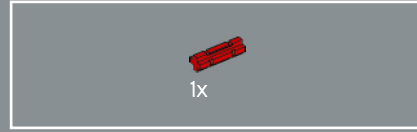
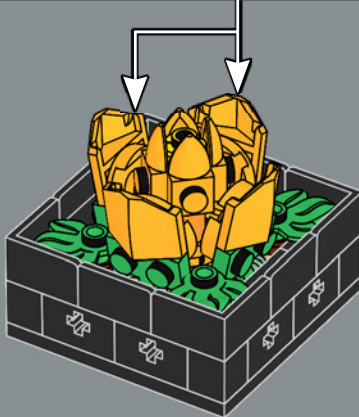
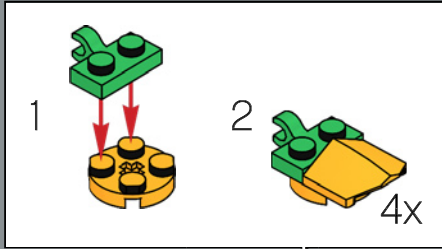

11

Orange Echeveria
Also known as the Orange Monroe, this succulent boasts adorable rosettes in varying shades of green and orange.

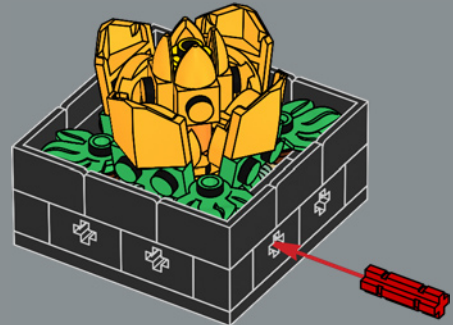

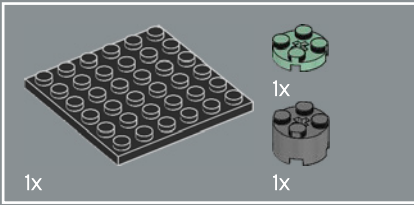
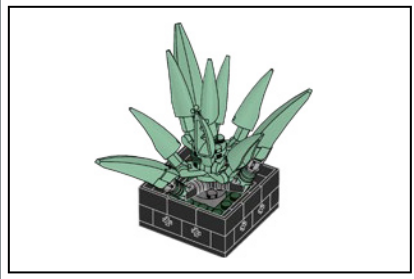

1

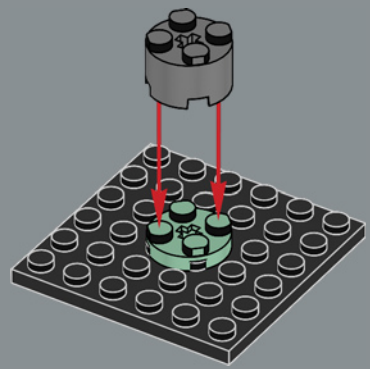

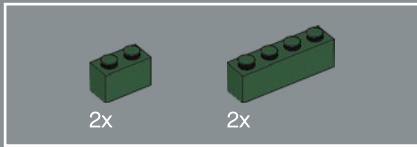

2

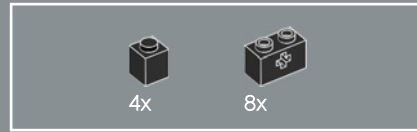
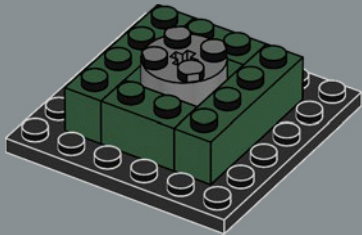

3

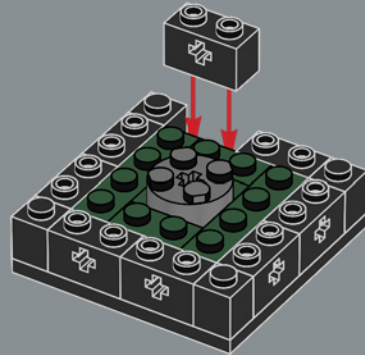

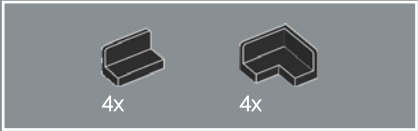

4

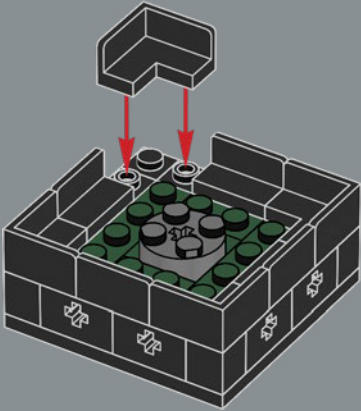



5

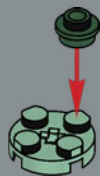

6



7

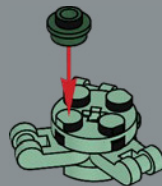



8

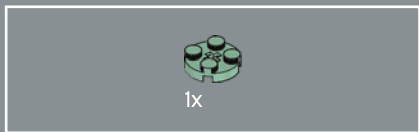

9



18

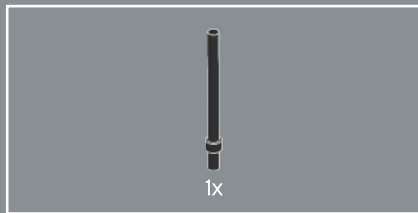

10

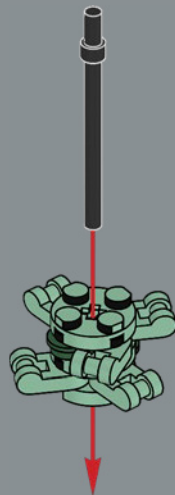

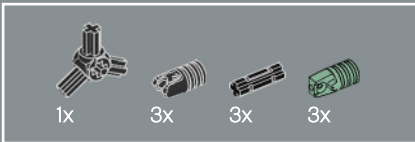

11

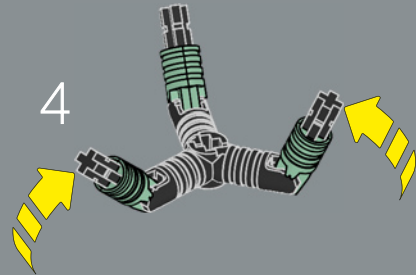
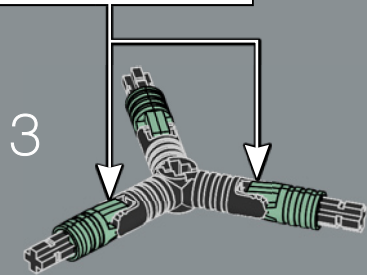
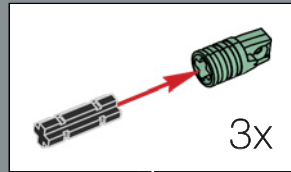
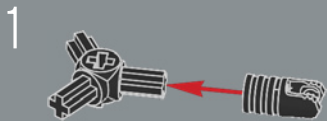

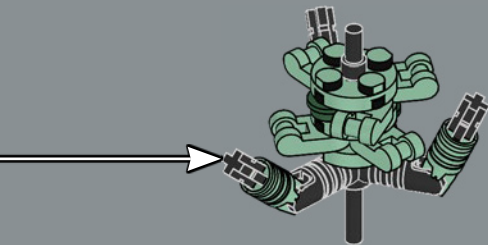

12

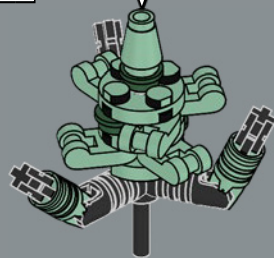
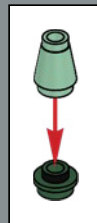

13

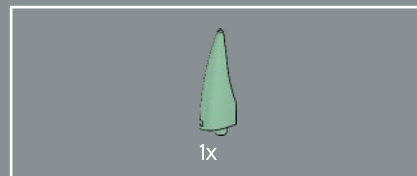
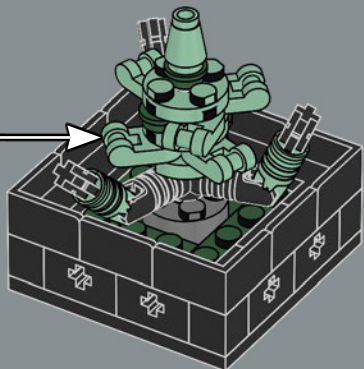

14

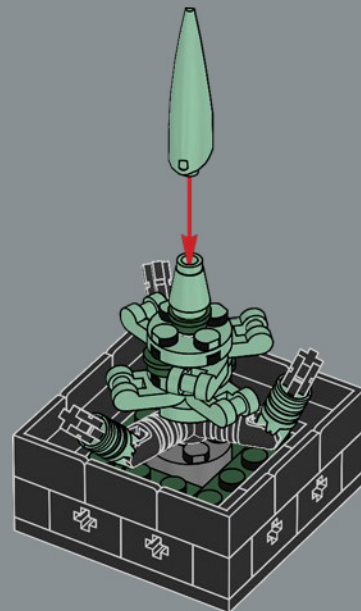

From claw-like to succulents we like
LEGO® claw elements from fantastic creatures
make up the spikey Aloe.

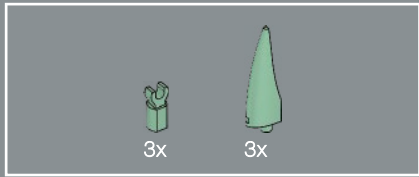

15

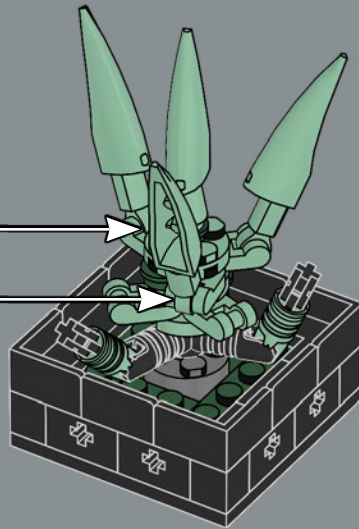
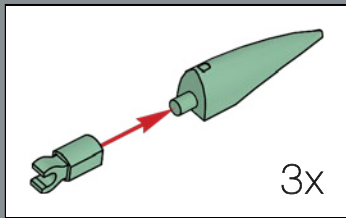

Aloe Plant
Cleopatra applied Aloe plant gel to her body as
part of her beauty regimen!

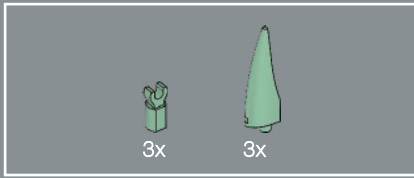

16

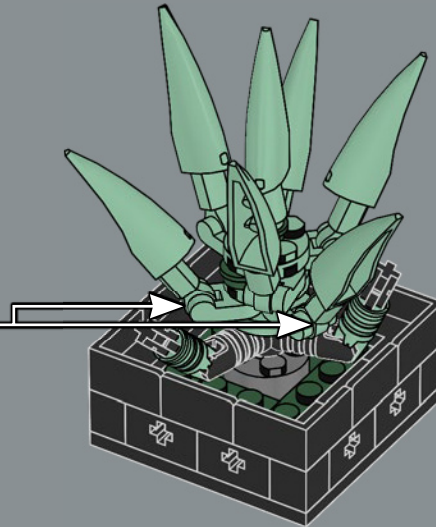
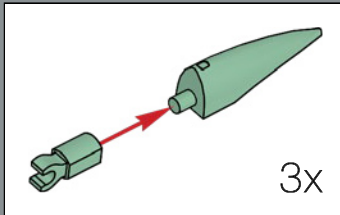

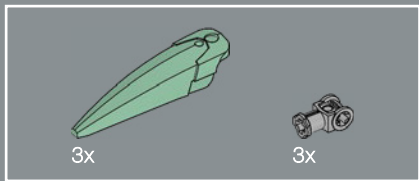

17

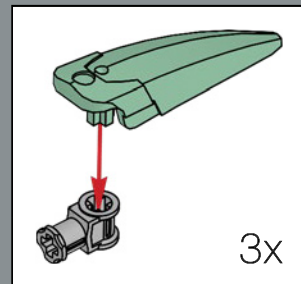
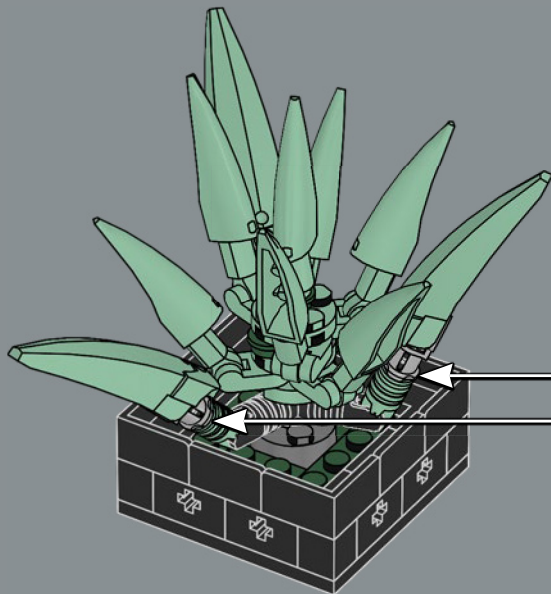

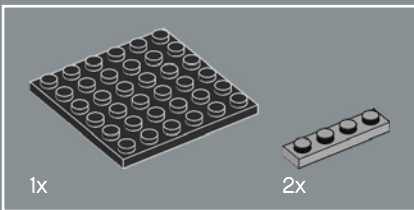
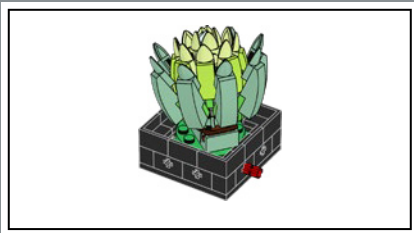

1

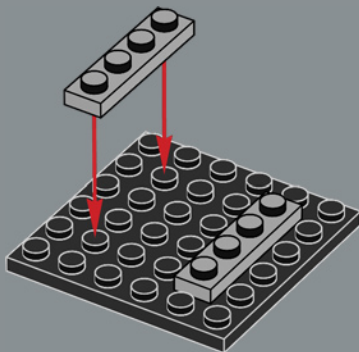

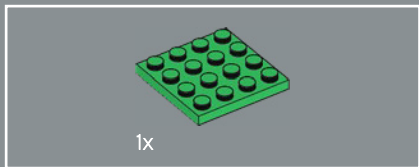

2

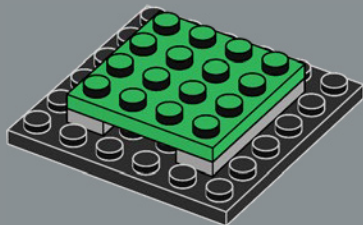

3

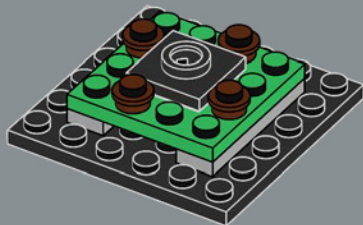

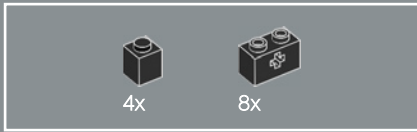

4

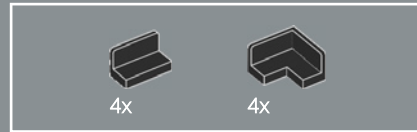
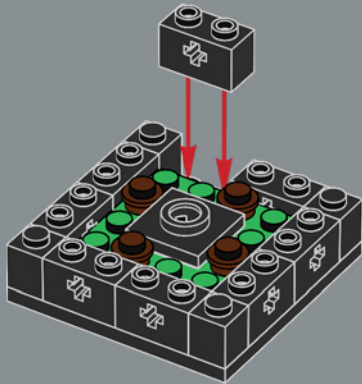

5

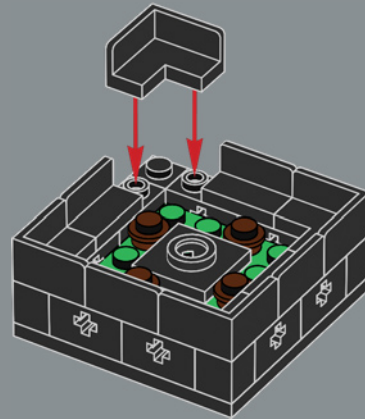

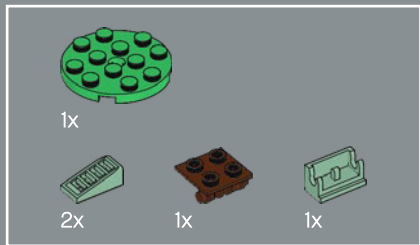

6

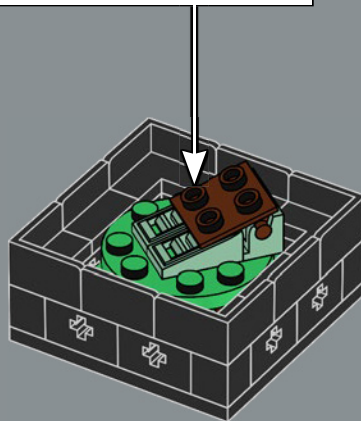
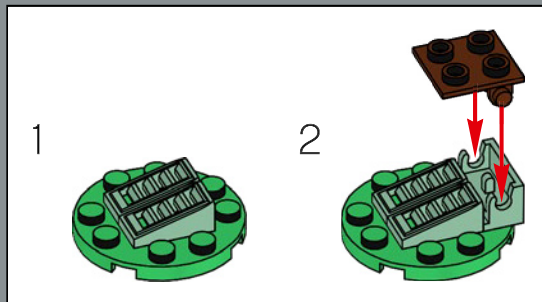

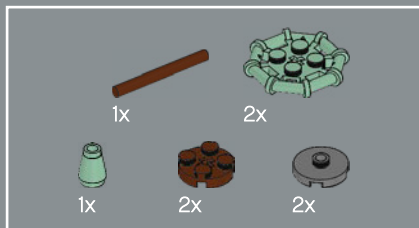

7

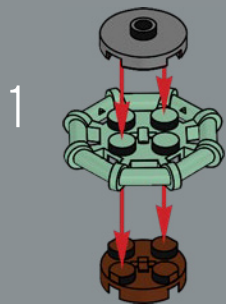

2

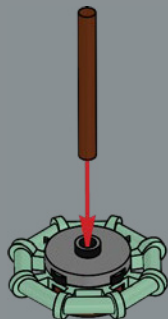

3

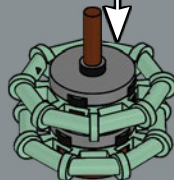

4

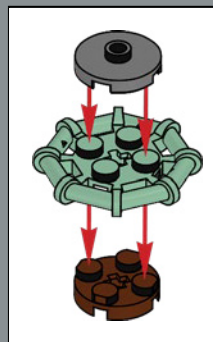
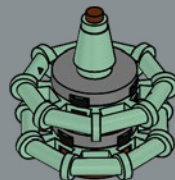

Leaves made from ice cream cones
Inspired by 'Hens and Chicks', the leaves
arranged in a rosette pattern originate from the
swirl top of an ice cream cone.

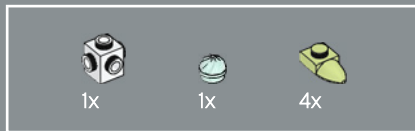
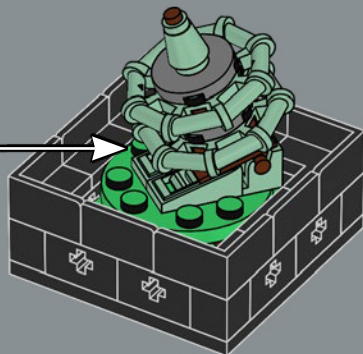

8

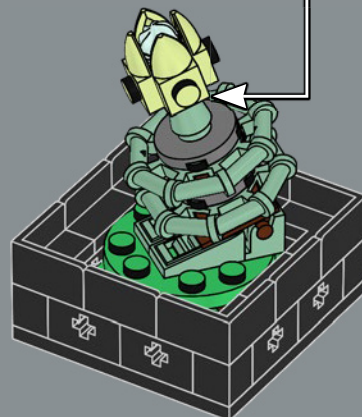
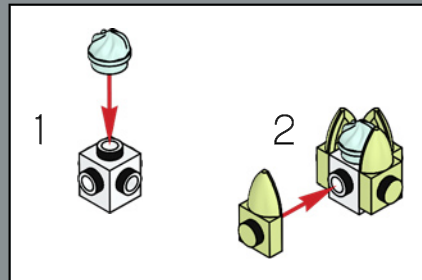



9

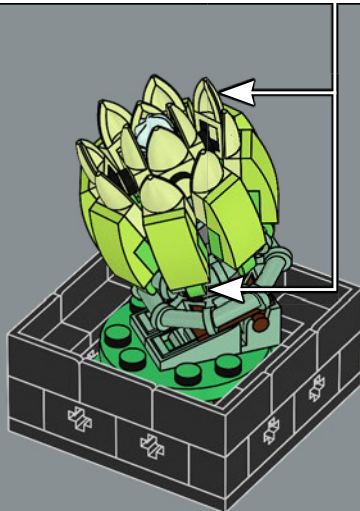
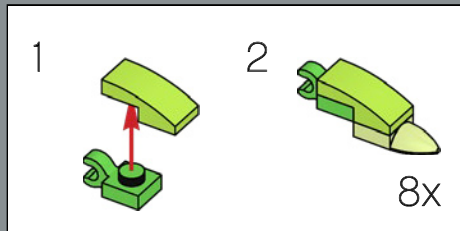

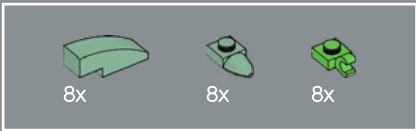

10

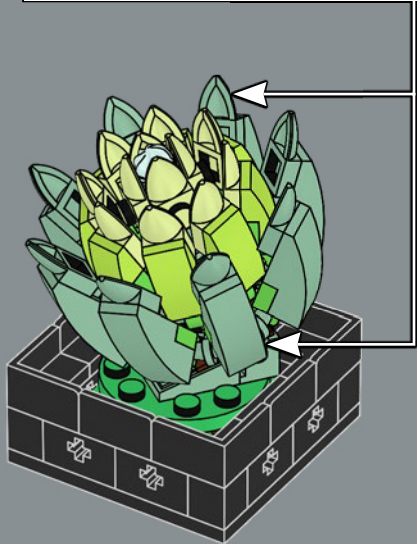
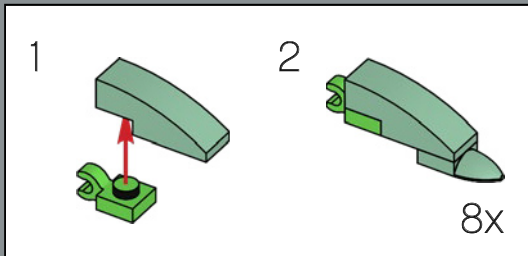

Hens and Chicks

Hens and Chicks plants are called such because they can quickly produce numerous babies.



1x

11

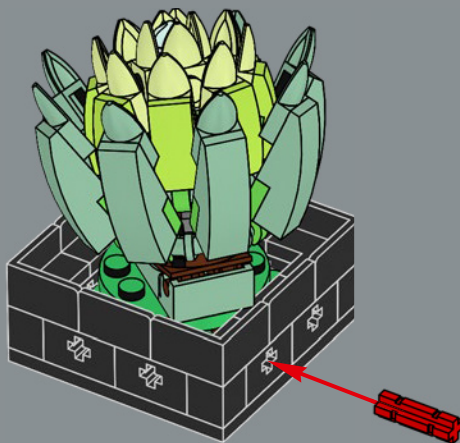

12

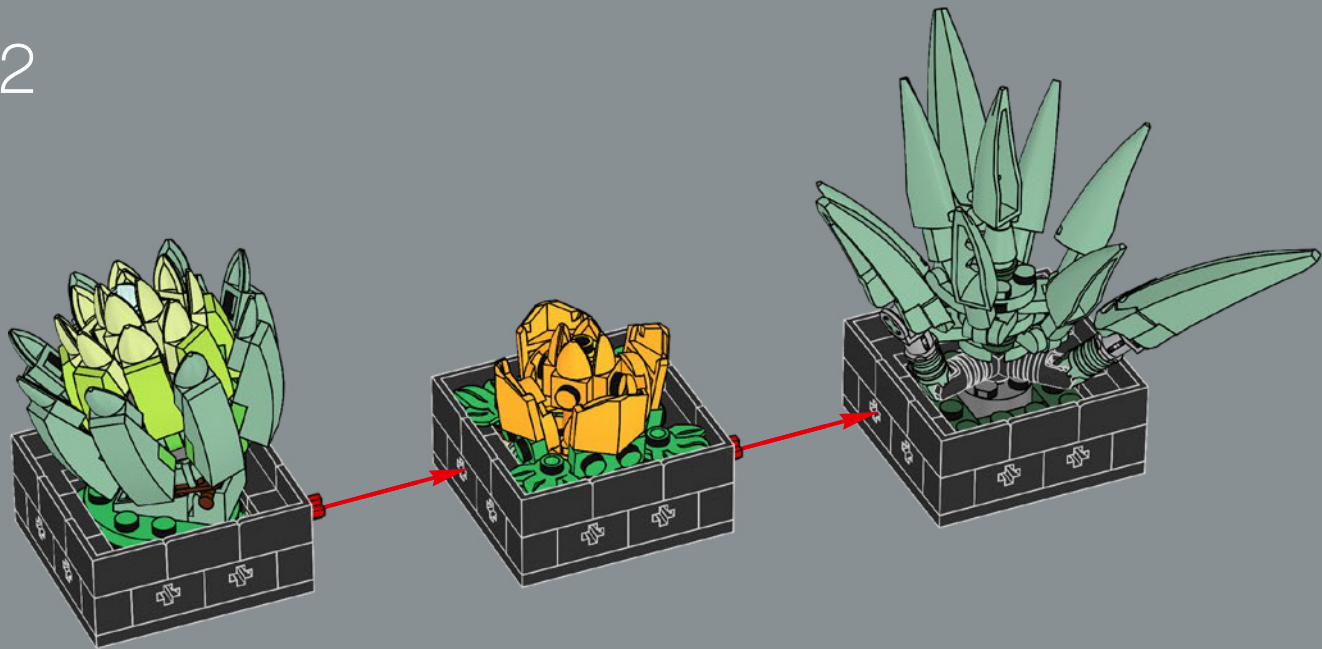

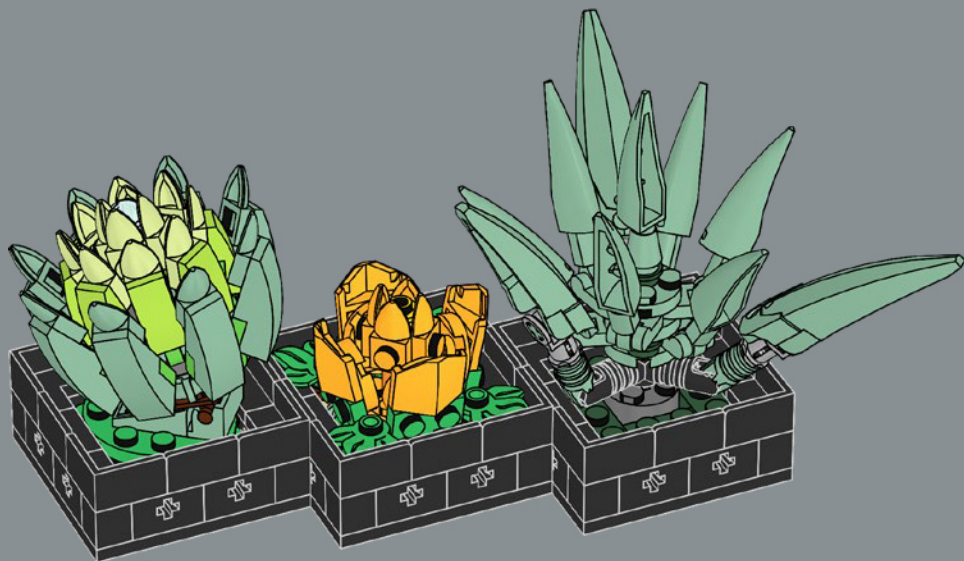

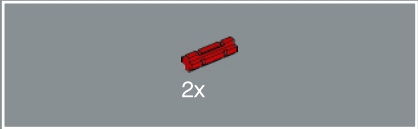

13

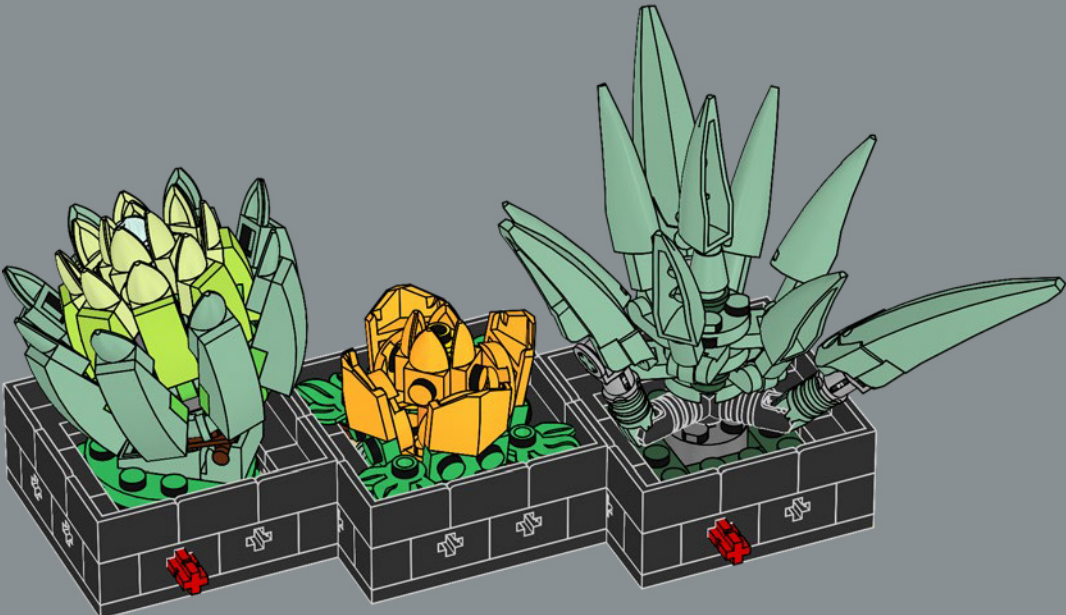



2x
4111971



4x
4529237



4x
4624086



16x
6212758



4x
6181752



8x
6324176



36x
300526



72x
6178922

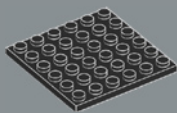

9x
395826



36x
6146220



36x
6344005



1x
6170421



1x
6371584



6x
6103643



2x
6323668



1x
6325254



3x
4109810



3x
6271535



1x
6390386



1x
6089119



1x
6310981



1x
4107736



4x
4112838



4x
4106356



1x
6244915



1x
4251378



1x
6270719

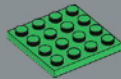

1x
4243821



6x
6253140



4x
6313123



1x
6353423



4x
6229130



4x
6395137



20x
6382575



1x
6398492



16x
6347296



4x
6138624



1x
6345196



1x
6161772



8x
6254271



13x
6174006



8x
6069006



2x
6264062



8x
6190251



2x
6209692



12x
6400305



4x
6400307



2x
6092591



11x
6300322



1x
6132790



2x
4245570



2x
4245571



2x
4260493



2x
6055169



2x
6013102



4x
4650244



1x
6253285



10x
6230571



1x
6035029



1x
4651524



4x
614121



8x
6378120



12x
4142865



1x
6299813



1x
6220715



9x
6214234

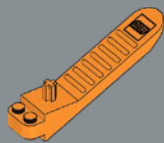

1x
6240515

 1x 6349342	 1x 6400309	 10x 6341975	 12x 6000752	 2x 4211159	 2x 4211445	 4x 6347780	 12x 6031787
 2x 6134280	 3x 6329298	 3x 6348250	 12x 4539097	 2x 6102360	 1x 6116608	 1x 6206151	 4x 6058245
 8x 6100237	 7x 6398464	 1x 6223234	 4x 6313126	 3x 6170468	 3x 6380605	 1x 6249118	 4x 6278089
 6x 6278550	 8x 6186079	 12x 6311108	 2x 6219658	 2x 6116613	 1x 4211881	 8x 6398491	 8x 6258091
 5x 6223219	 2x 6155256	 7x 6398466	 6x 6385485	 1x 6349130	 1x 4249139	 4x 6223506	 8x 6258075
 6x 6223237	 6x 6312350	 4x 4282860	 1x 6186045	 3x 6115080	 35x 6398468	 8x 6258098	 8x 6258094
 4x 6400434	 4x 4211183	 1x 6167644	 2x 6278155	 12x 6267420	 8x 6258095	 16x 4216581	 1x 6398490
 1x 6167644	 4x 6316692	 8x 6398465	 1x 6398490				



Customer Service

Kundenservice

Service Consommateurs

Servicio Al Consumidor

LEGO.com/service or dial



00800 5346 5555 :



1-800-422-5346 :





FEEDBACK AND WIN



FEEDBACK AND WIN

Your feedback will help shape the future development of this product series.

Please visit:

FEEDBACK UND GEWINNEN

Dein Feedback trägt zur Weiterentwicklung dieser Produktreihe bei.

Geh auf:

COMMENTEZ ET GAGNEZ

Vos commentaires nous aideront à concevoir les futurs produits de cette gamme.

Rendez-vous sur :

COMENTA Y GANA

Tu opinión nos ayudará a dar forma al desarrollo de esta serie de productos en el futuro.

Visita:

反馈有奖

您的反馈将有助于我们在今后改进本系列产品。

请访问:

[LEGO.com/productfeedback](https://www.lego.com/productfeedback)

By completing, you will automatically enter a drawing to win a LEGO® set.

Terms & Conditions apply.

Durch Ausfüllen nimmst du automatisch an der Verlosung eines LEGO® Preises teil.

Es gelten die Teilnahmebedingungen.

En envoyant vos commentaires, vous serez automatiquement inscrit(e) à un tirage au sort qui vous permettra de remporter un prix LEGO®.

Offre soumise à conditions.

Al contestar, participarás automáticamente en el sorteo y podrás ganar un set LEGO®.

Sujeto a Términos y Condiciones.

完成我们的反馈调查,即可自动进入抽奖环节,赢取乐高®套装。

适用《条款和条件》。

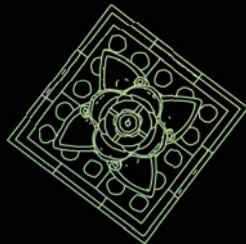
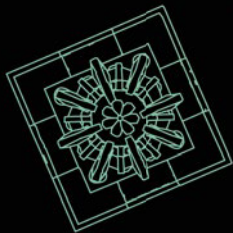
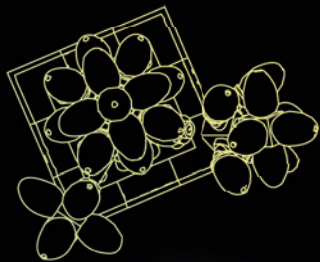

Book 2

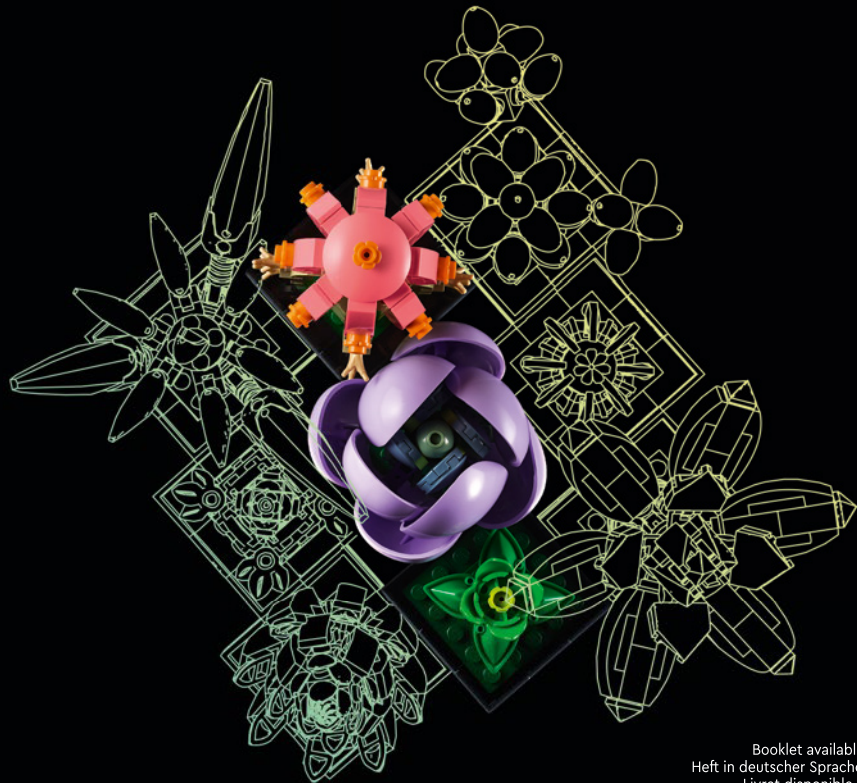

Booklet available in English on
Heft in deutscher Sprache erhältlich auf
Livret disponible en français sur
Libretto disponibile in Italiano su
Folleto disponible en español en
如需中文版手册, 请访问

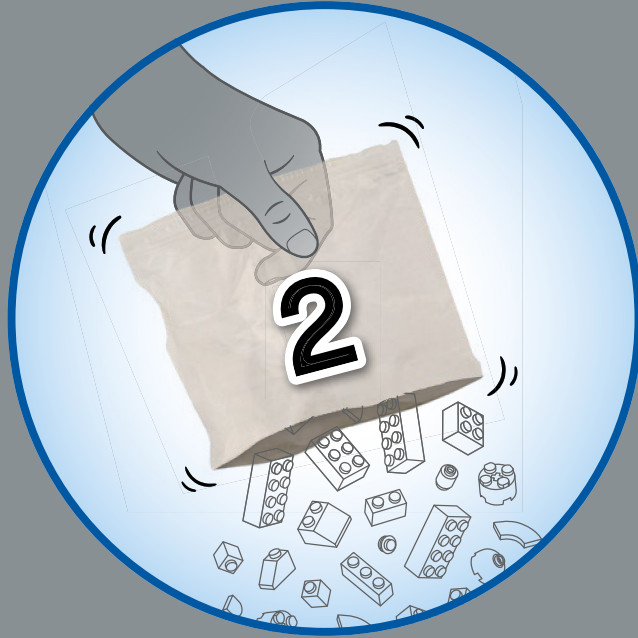

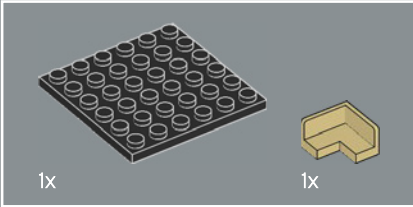
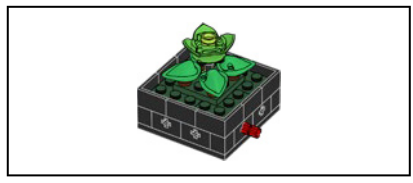

1x

1x

1



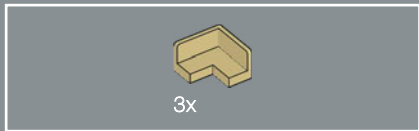

2

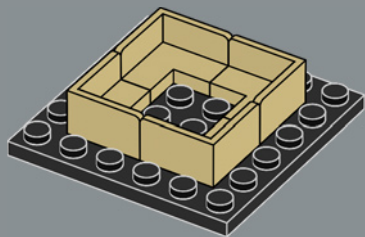

4

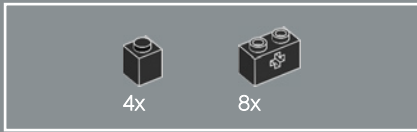

3

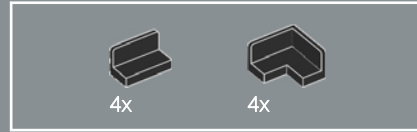
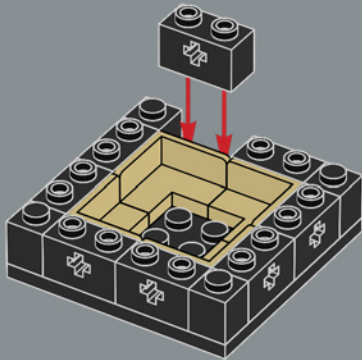

4

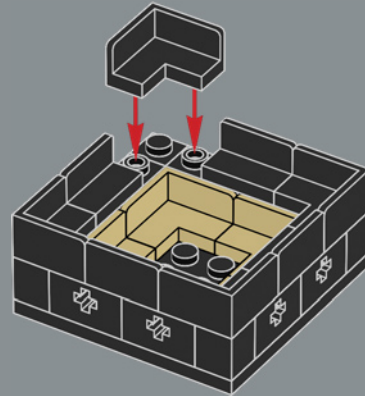

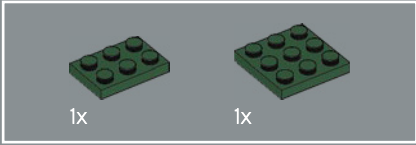

5

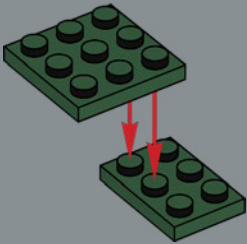

6

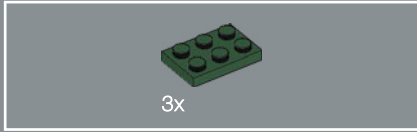

6

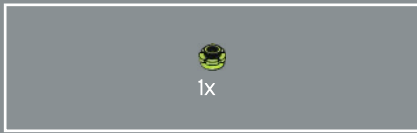
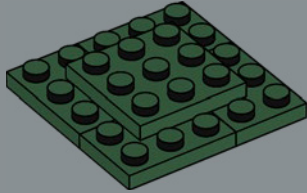

7

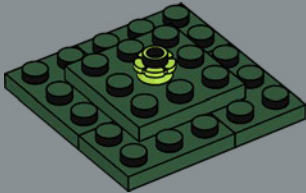



8

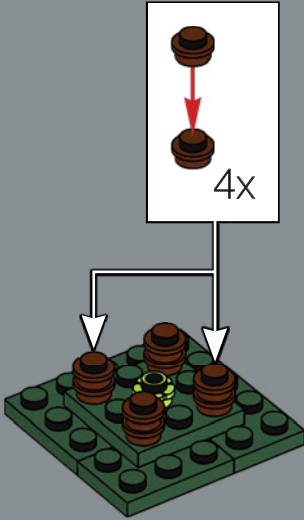

9

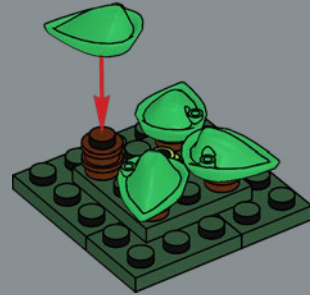



10

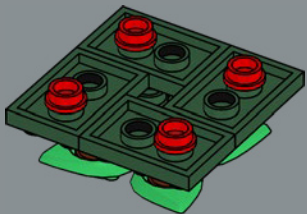

11

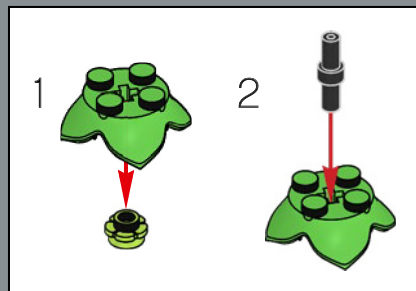

12

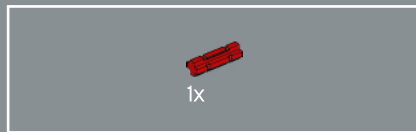
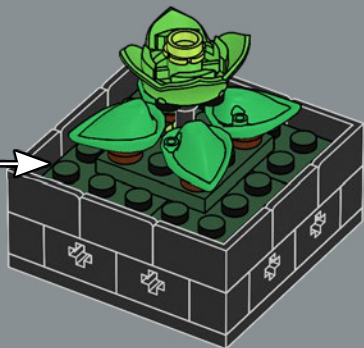

13

There are approximately 10,000 types of succulents that you can grow. The fun LEGO® Succulents are a great way to start your collection.

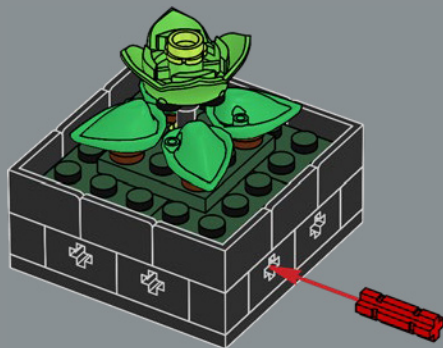

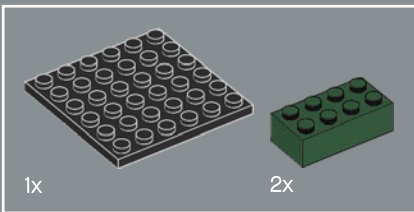
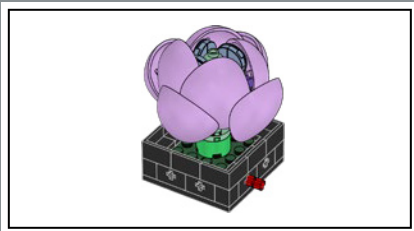

1

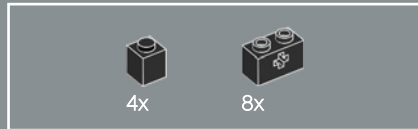
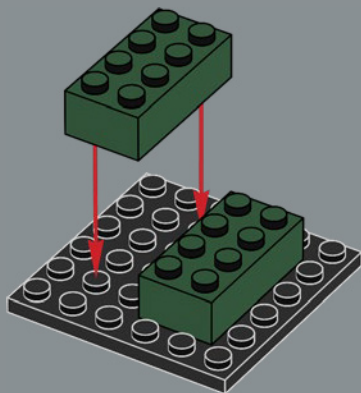

2

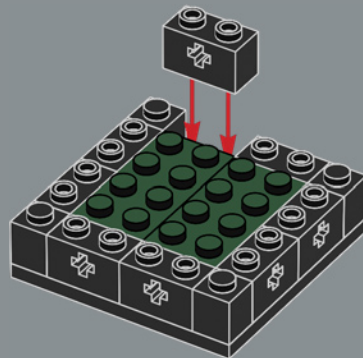

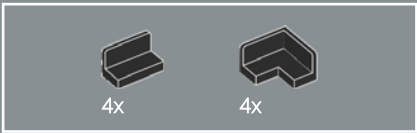

3

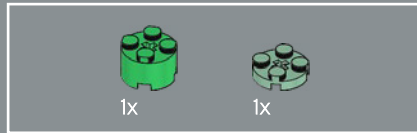
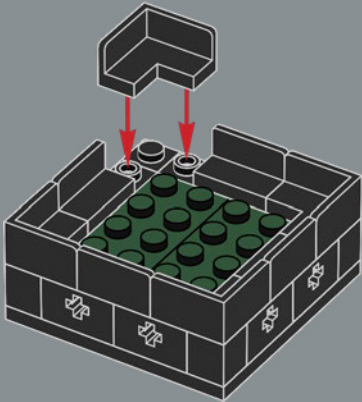

4

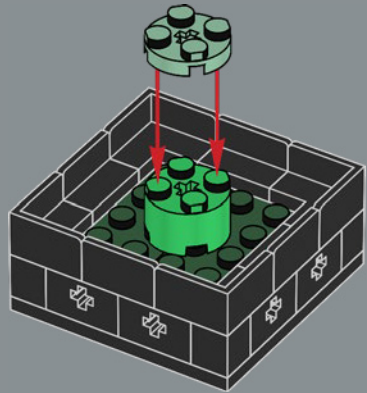

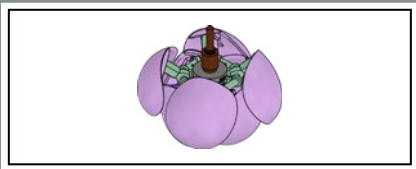

5



12

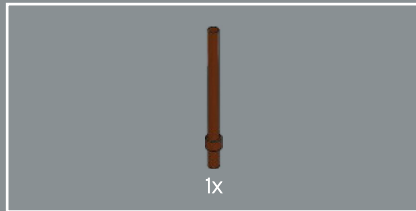

6

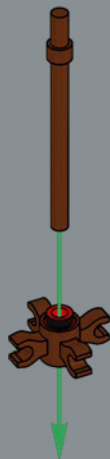

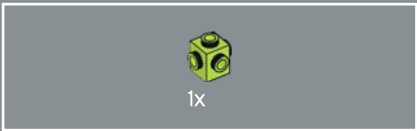

7

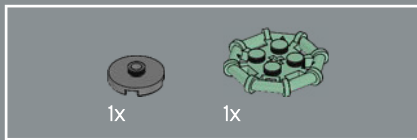

8

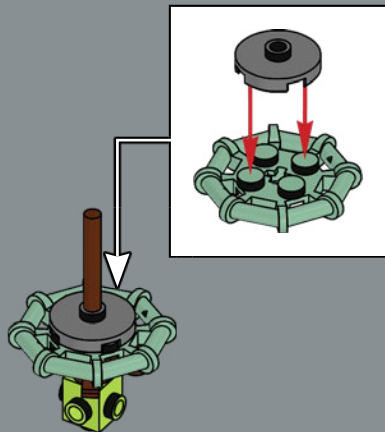



9

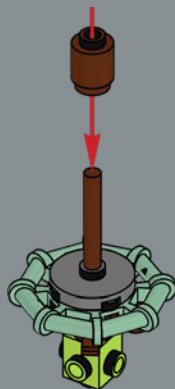

14



10

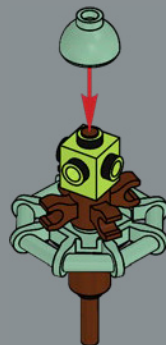



11

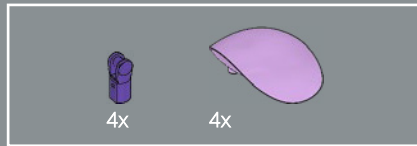
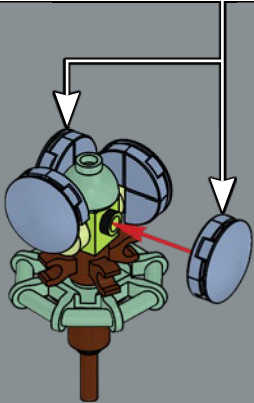
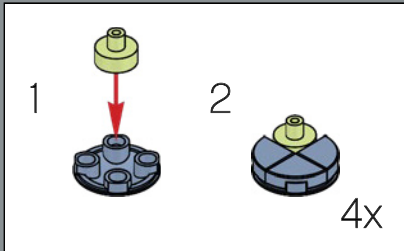

12

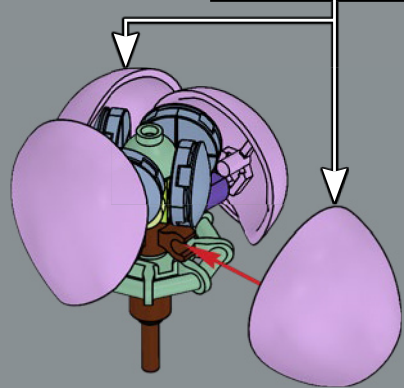
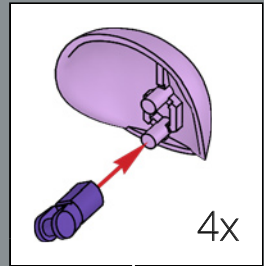

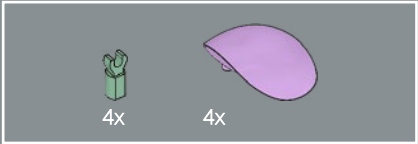

13

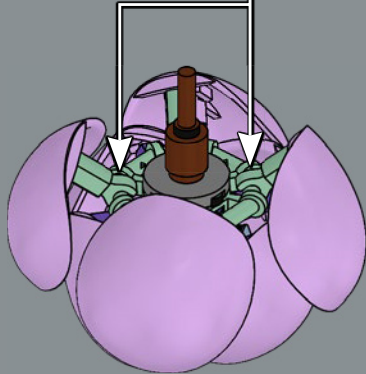
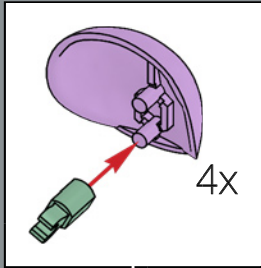

Lavender Echeveria
The lavender varieties of Echeveria have some fun names like 'Afterglow' and 'Cubic Frost.'
What would you name yours?

14

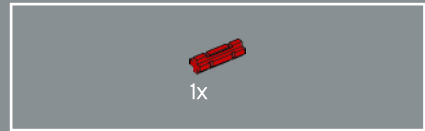
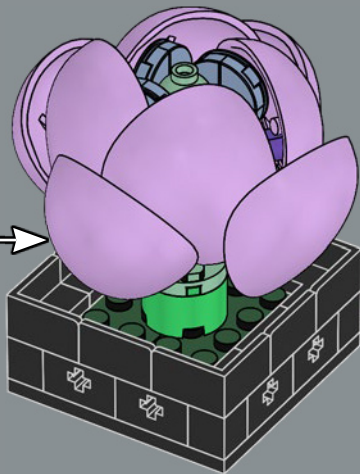

15

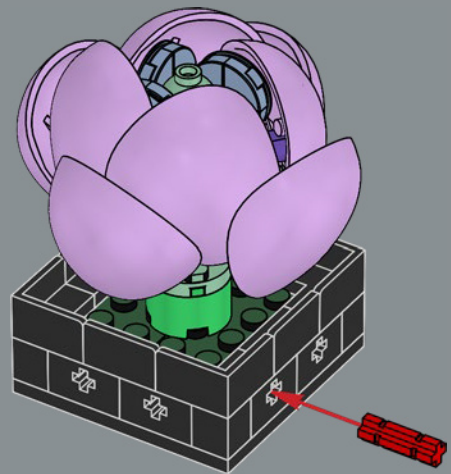

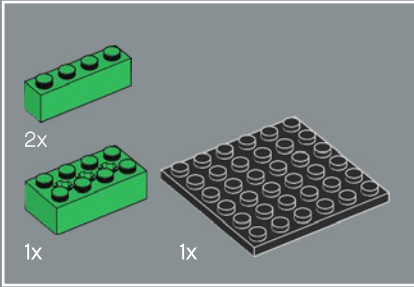
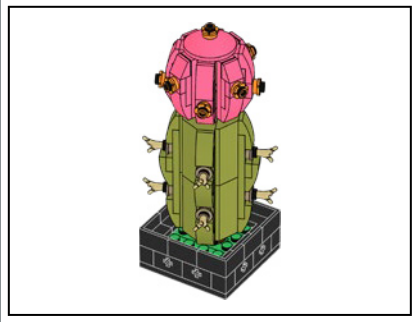

1

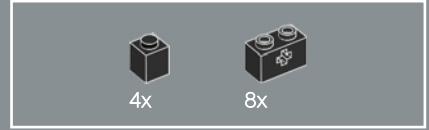
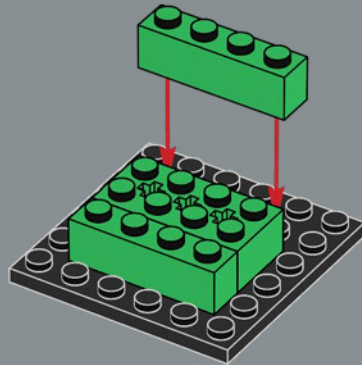

2

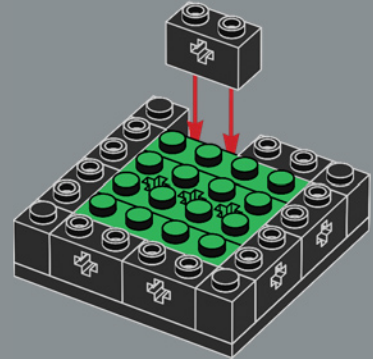

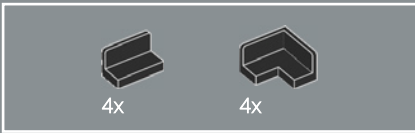

3

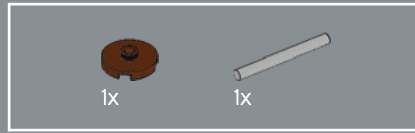
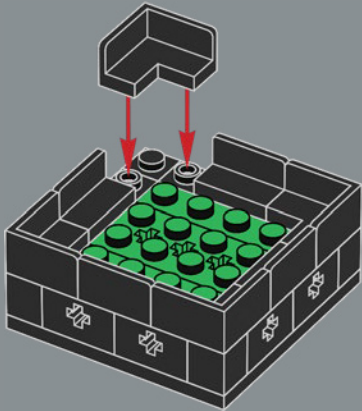

4

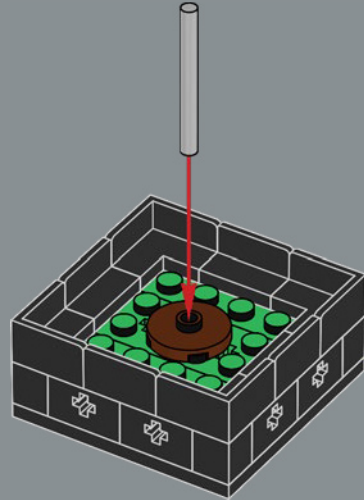

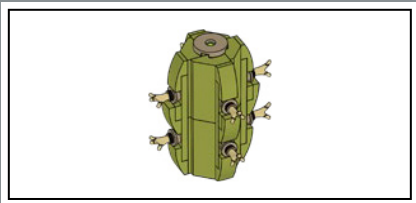

1x

1x

5

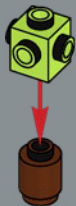

2x

6





7



8



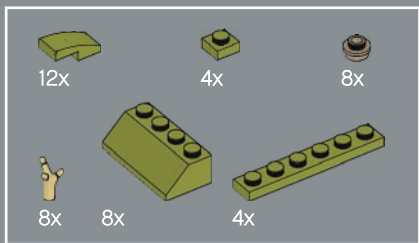
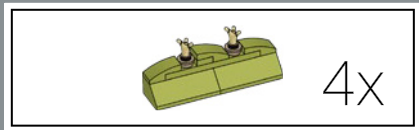

9

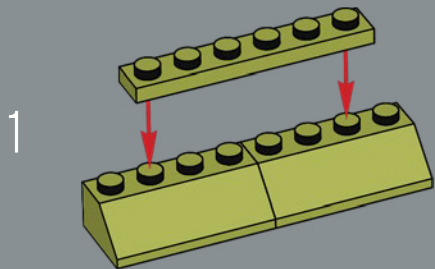

2

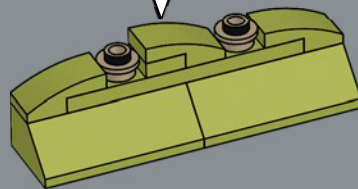

3

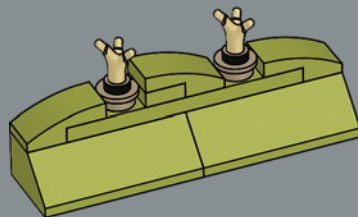

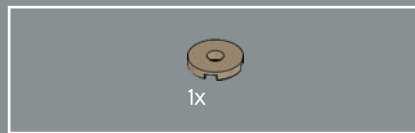
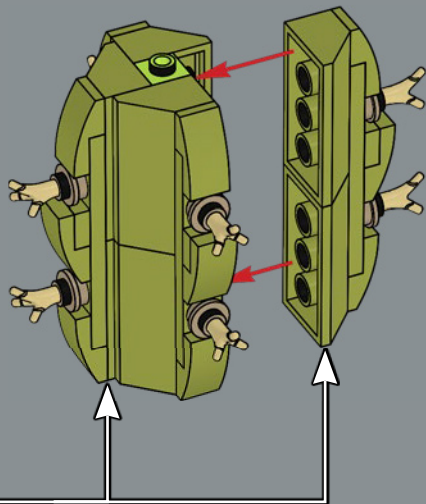

10

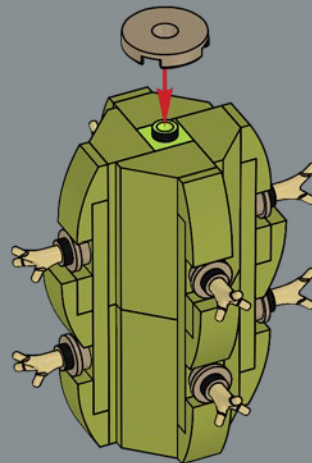

11

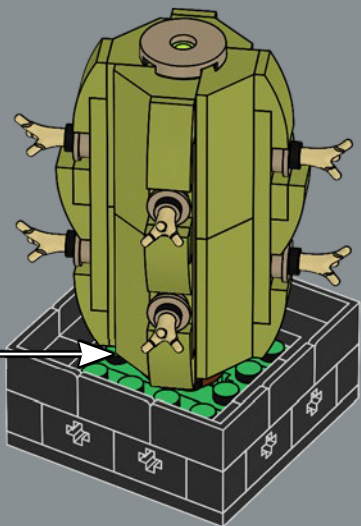

24

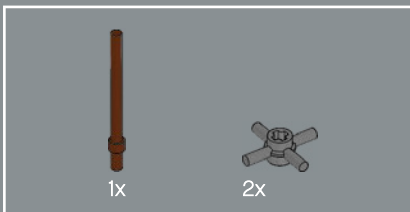
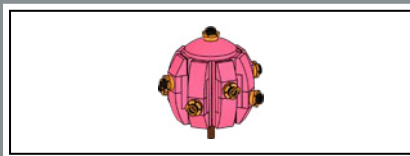

12

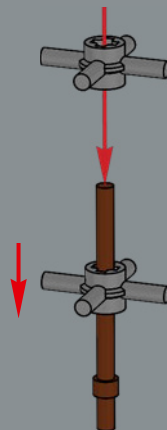



13

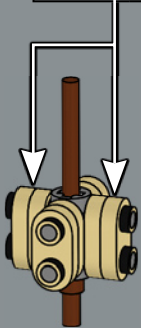
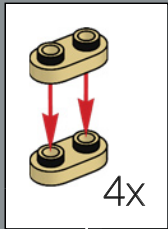

14

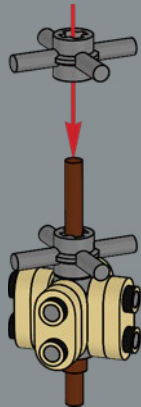



15

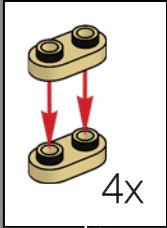

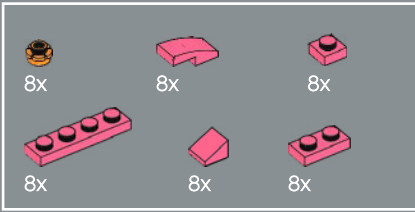

16

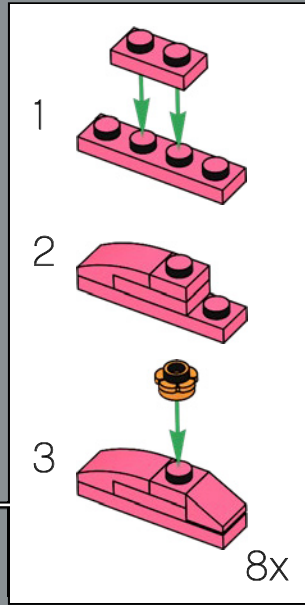
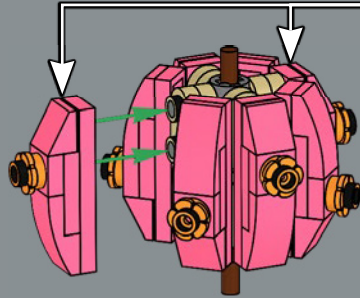



17

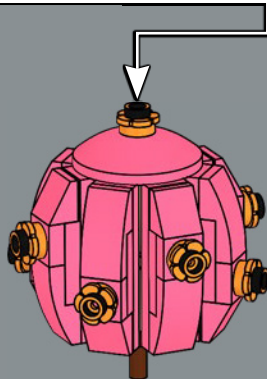
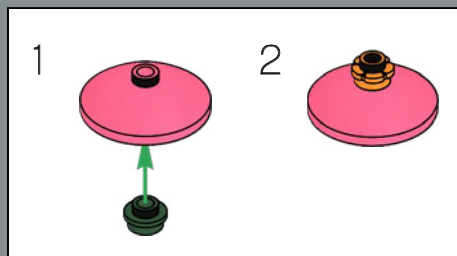

Moon Cactus
The Moon Cactus glows red because it lacks chlorophyll and must be grafted onto other cacti for it to grow.

18

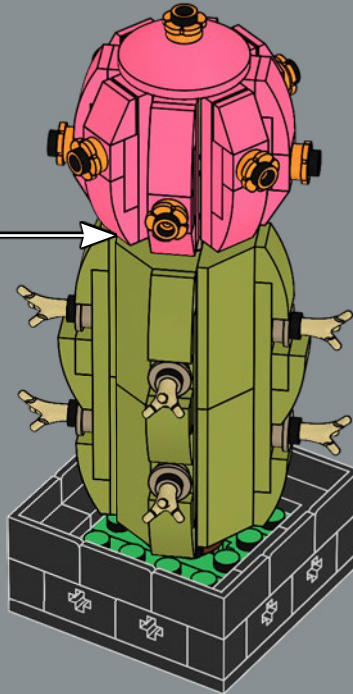

19

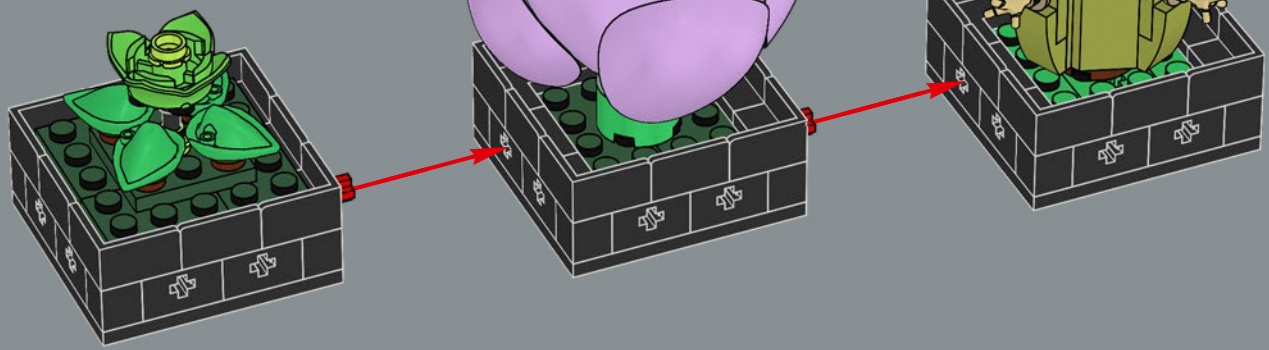



2x

20

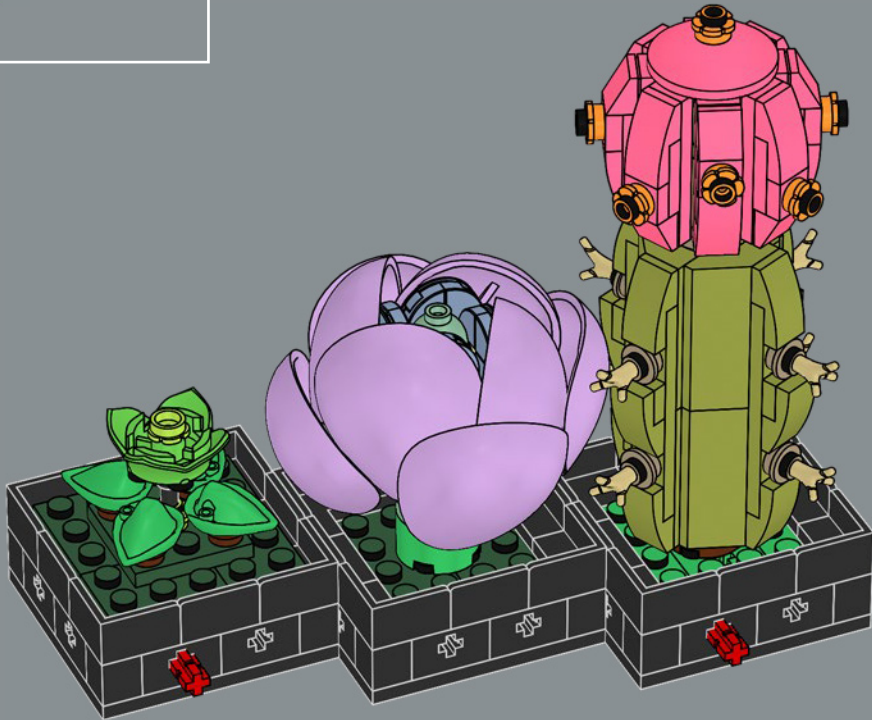

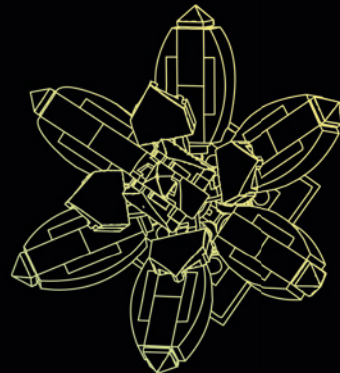
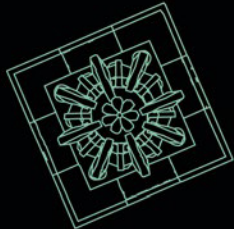
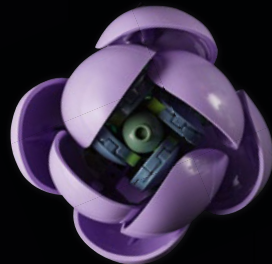
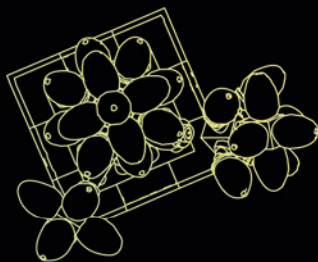
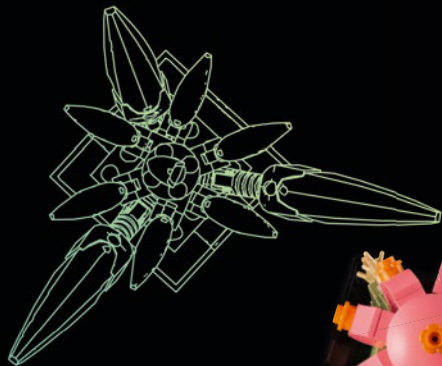

Book 3



Booklet available in English on
Heft in deutscher Sprache erhältlich auf
Livret disponible en français sur
Libretto disponibile in Italiano su
Folleto disponible en español en
如需中文版手册, 请访问



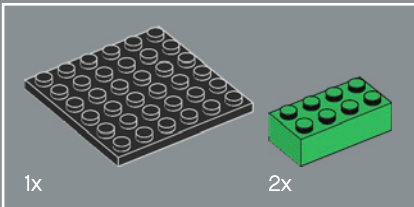

1

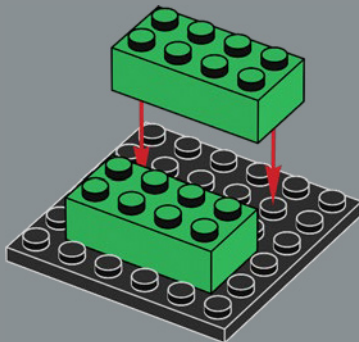

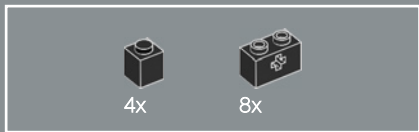

2

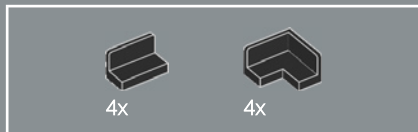
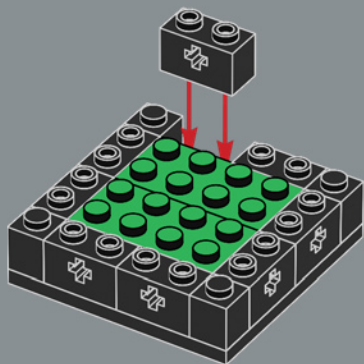

3

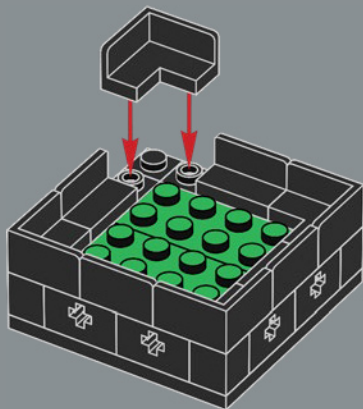

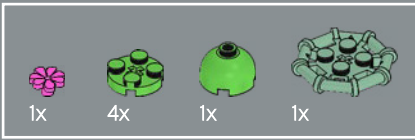

4

1

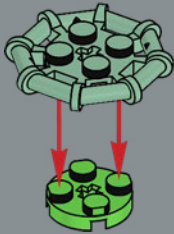

2

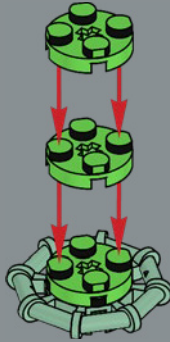

3

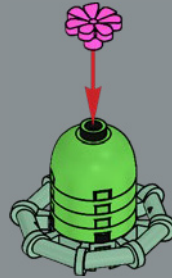

5

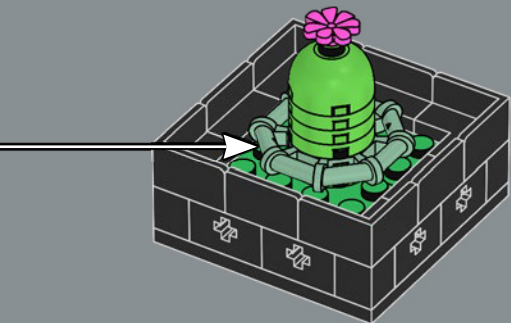

6



6

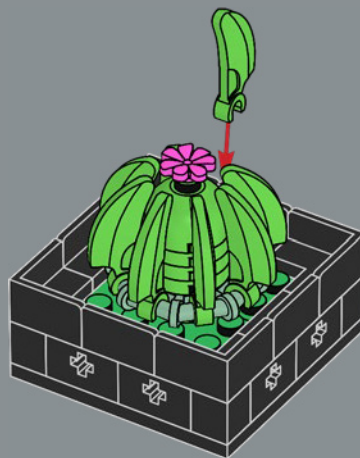

Ball Cactus
Cacti - including the Ball Cactus can live from
10 to 200 years! And we bet LEGO® Succulents
could beat that record.

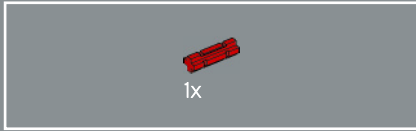

7

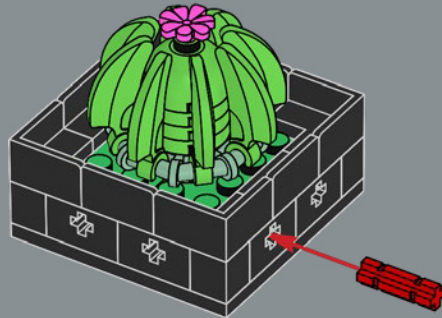

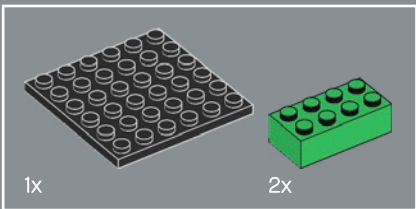
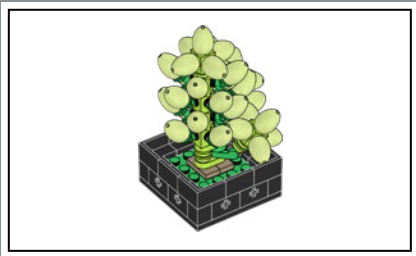

1

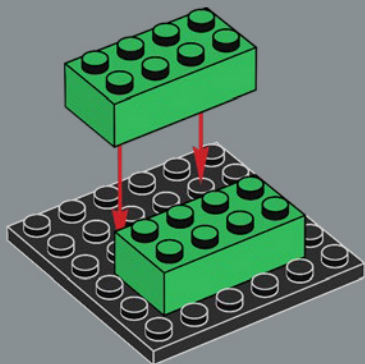

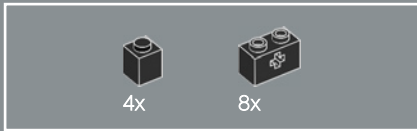

2

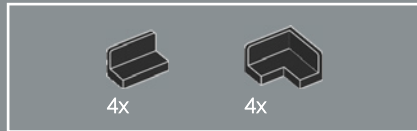
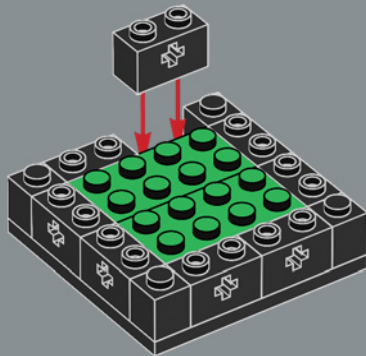

3

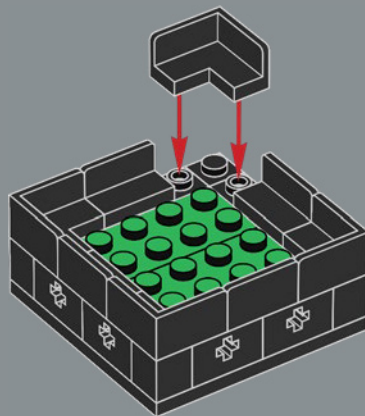

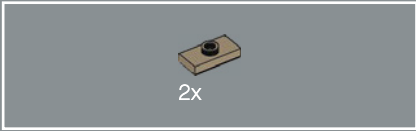

4

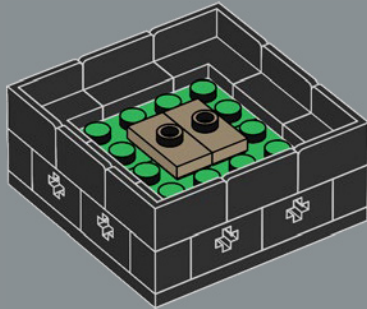



5

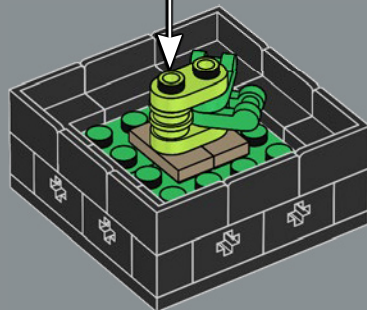
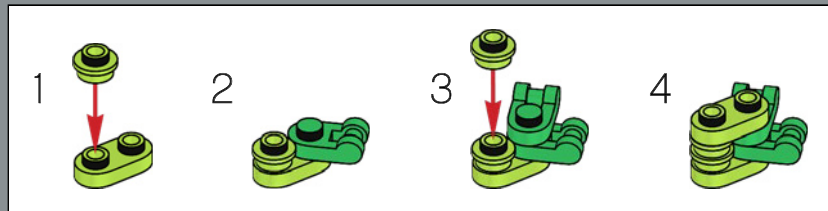



6

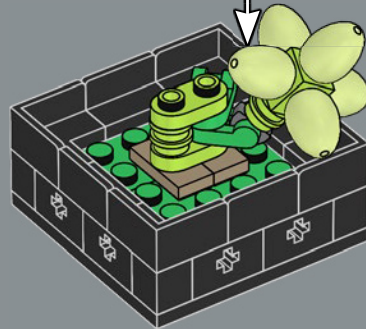
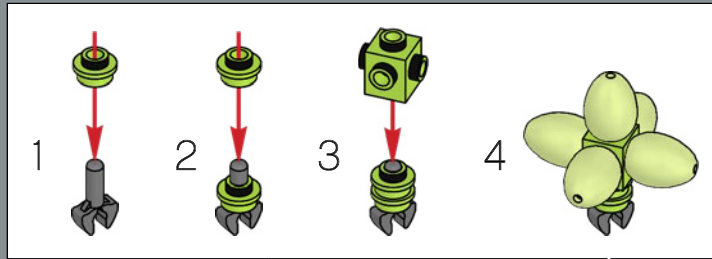

Rawr-some leaves
The Burro's Tail plant with its plump green leaves, are made from elements commonly used in LEGO® sets as dinosaur eggs.

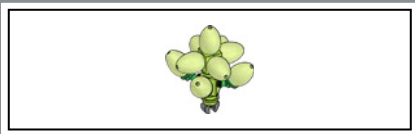

7

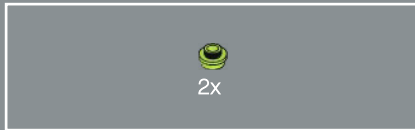

8



9





4x

10



1x

11

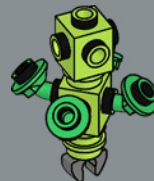



12

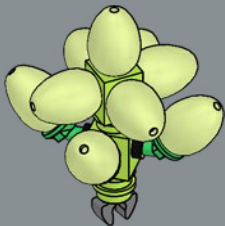

13

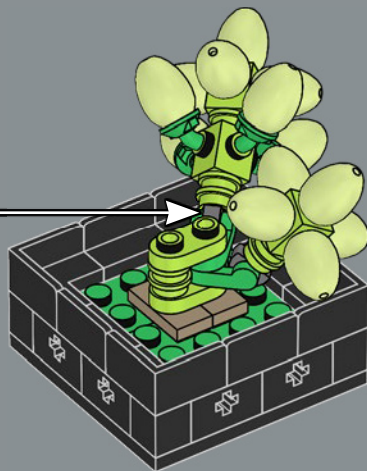

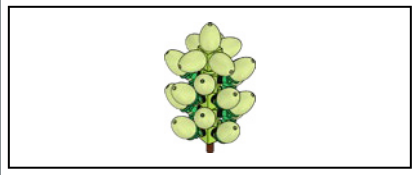

2x

14

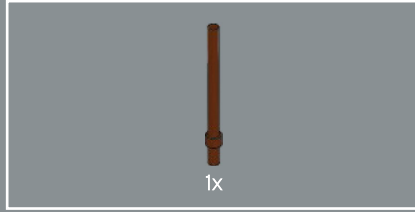
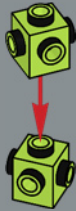

1x

15

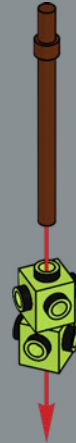



16



17





16x

18



16x

19

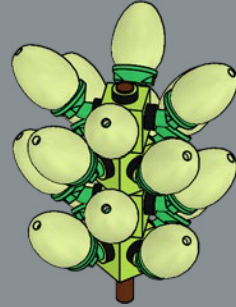



20

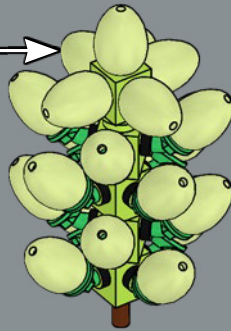
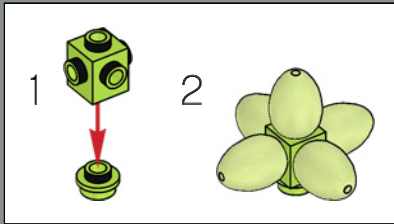

21

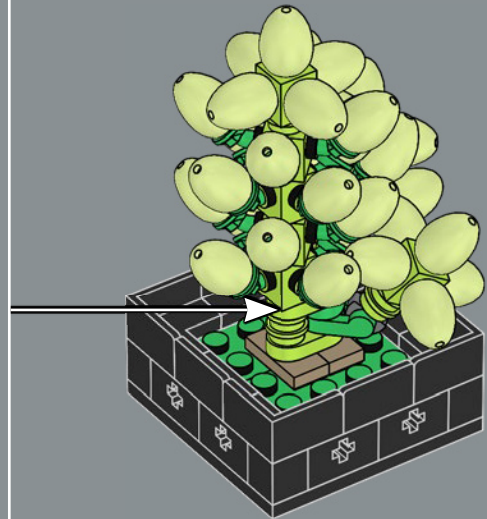

Burro's Tail
The Burro's Tail or the Donkey Tail is a tropical plant native to Mexico and Central America.

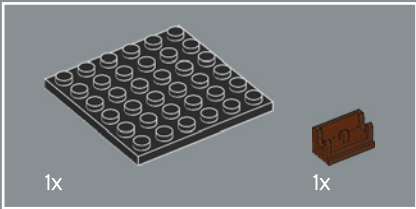
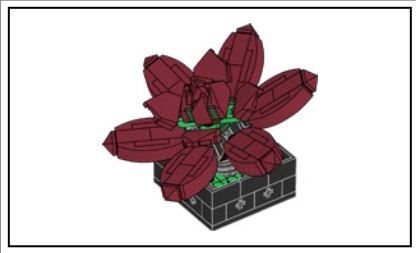

1

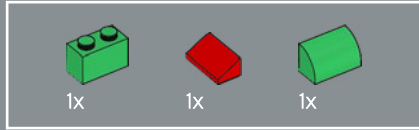
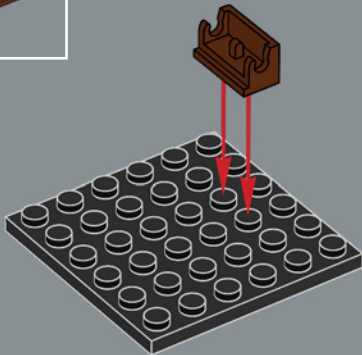

2



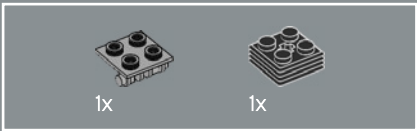

3

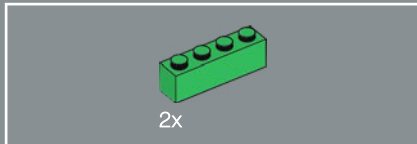
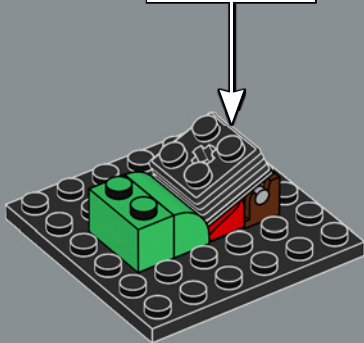
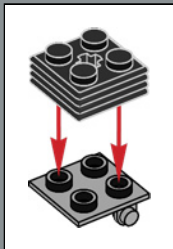

4

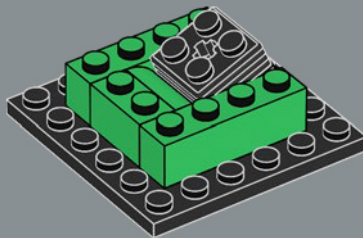

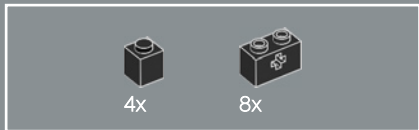

5

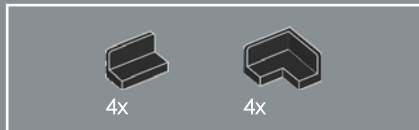
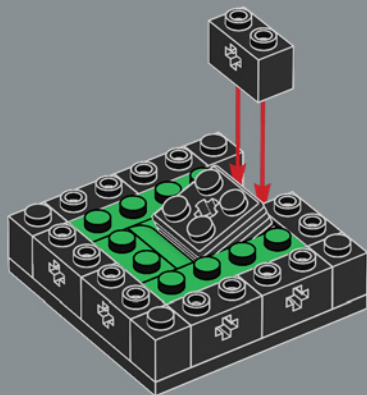

6

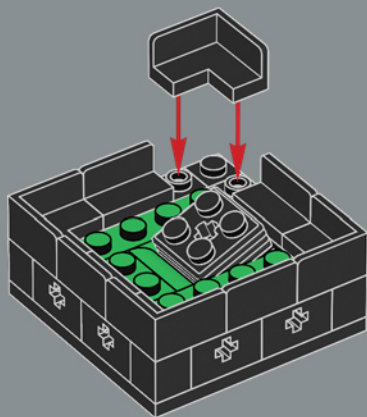

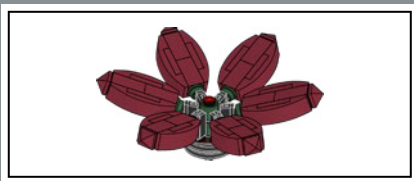

7

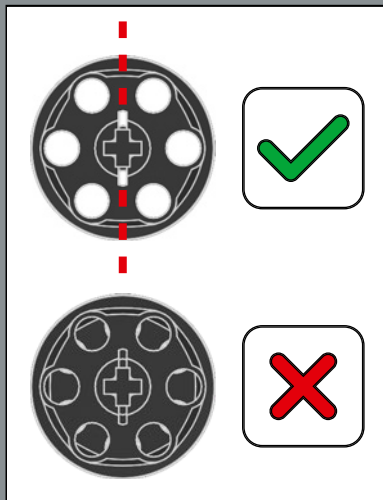
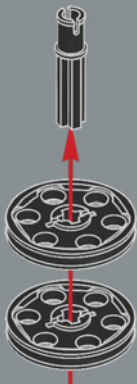

8





9

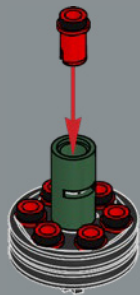

10



11

1

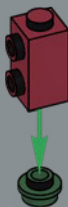

2



3

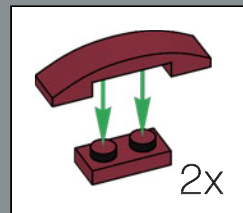

6x

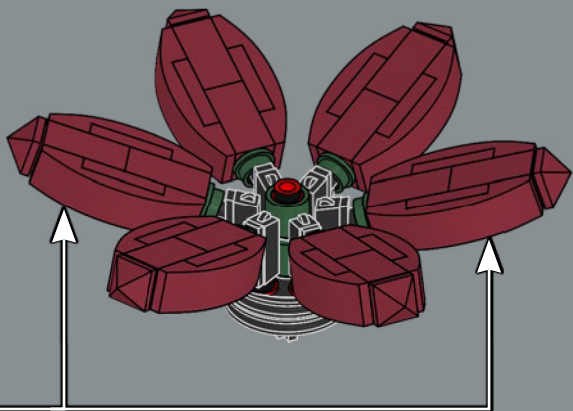

12

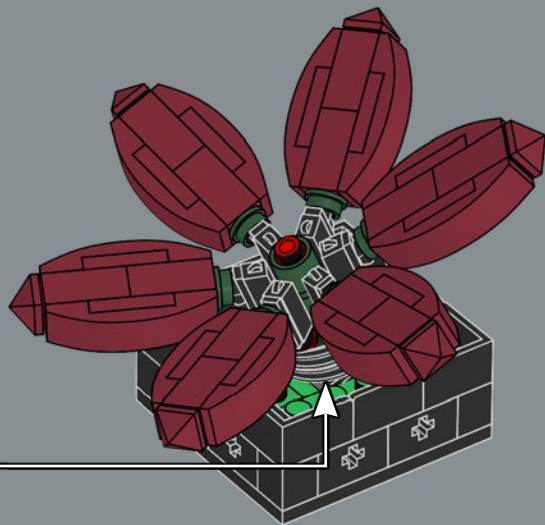



13

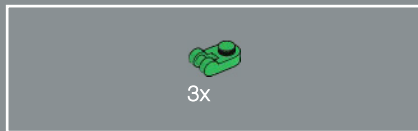
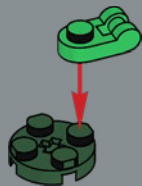

14

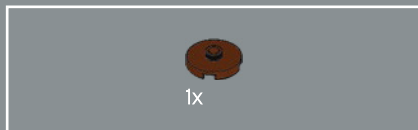
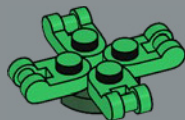

15



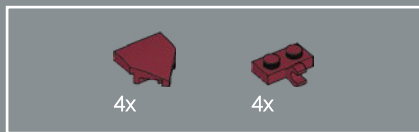

16

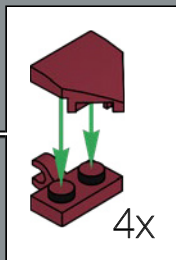
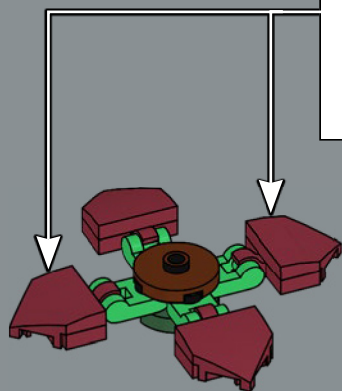

17

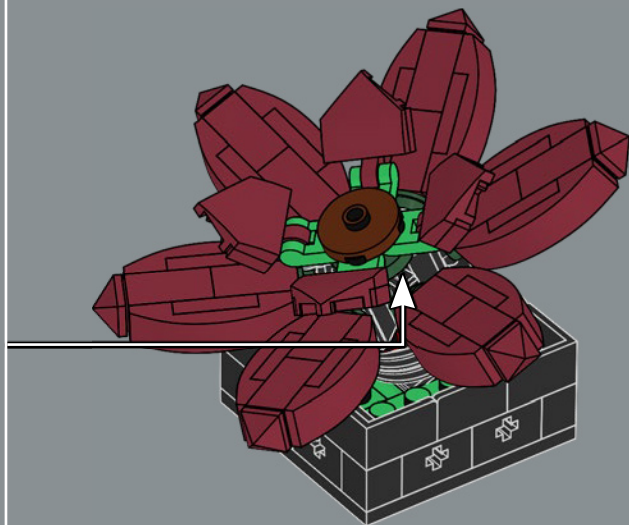

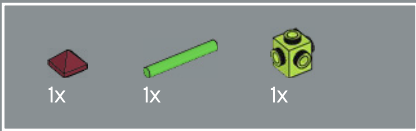

18

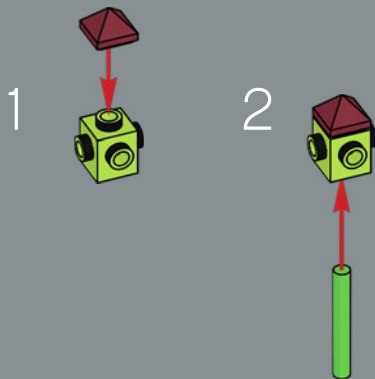

Knights of the succulents
The ruby red Echeveria has small pyramid elements at the tips of its leaves that first appeared as detail elements in LEGO® NEXO KNIGHTS™ sets.

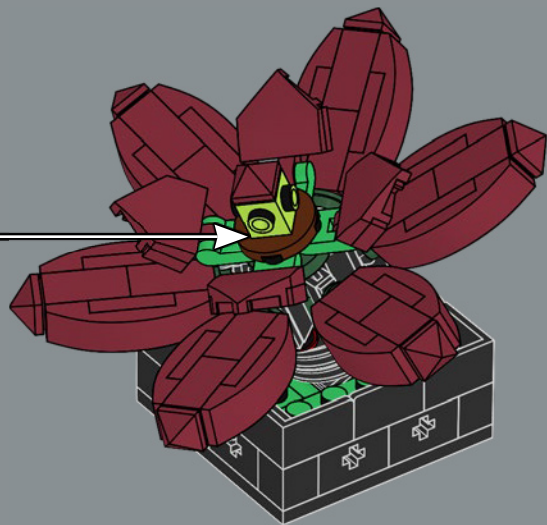

Red Echeveria

Red is the colour of love. Next Valentine's Day skip the roses and give a LEGO® Red Echeveria instead!

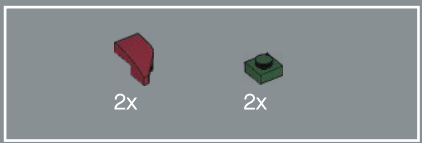

19

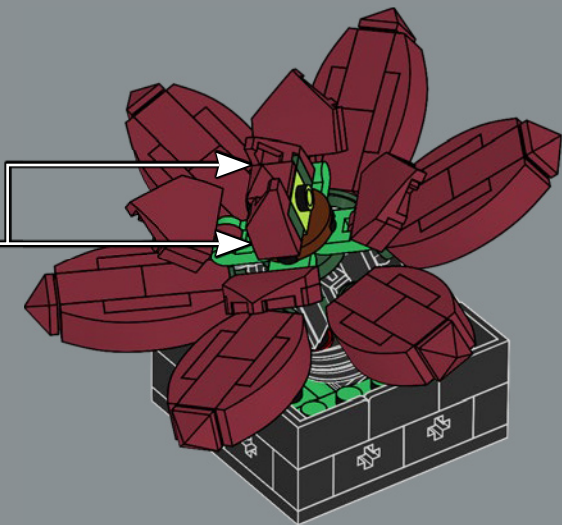
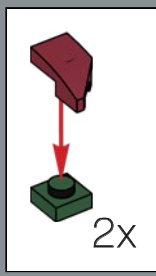



20

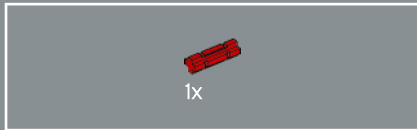
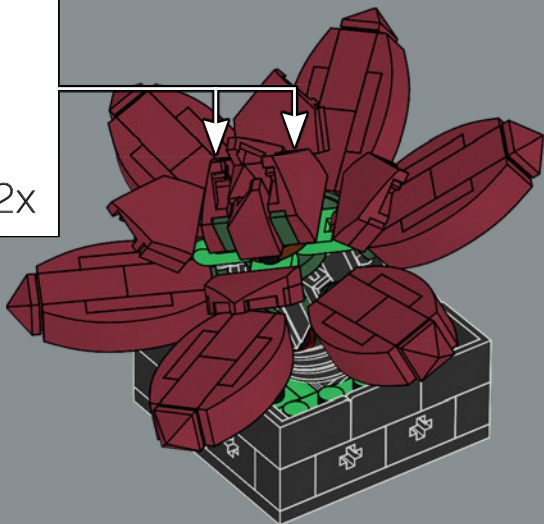
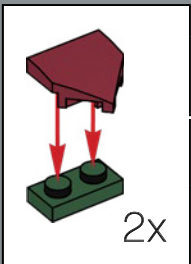

21

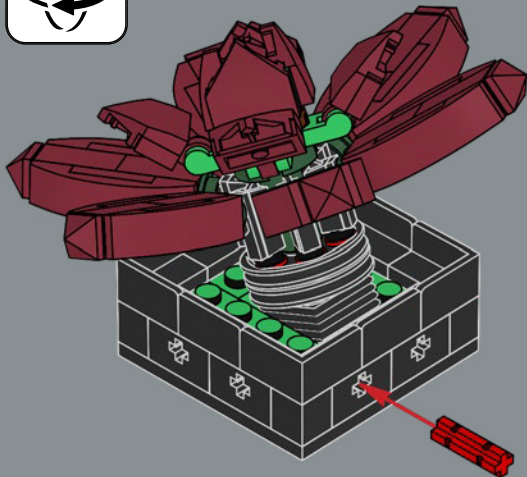

22

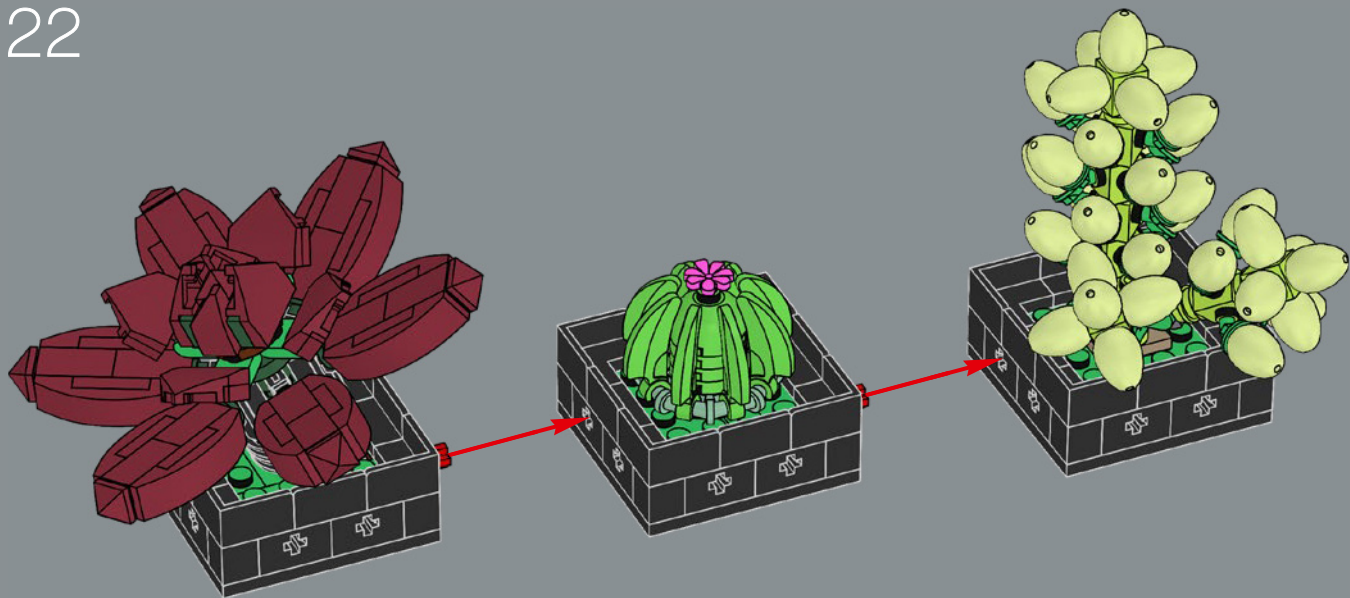

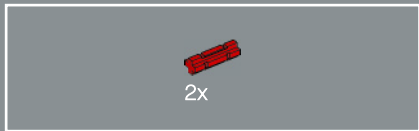

23

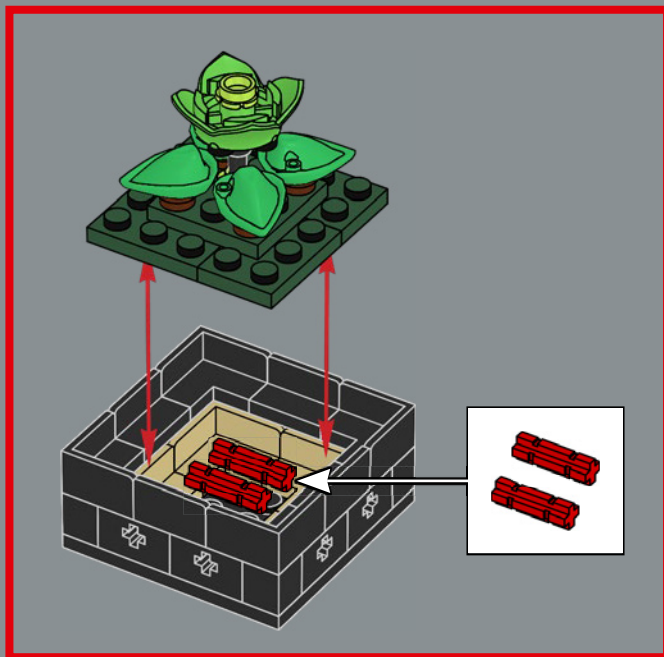

24

