



40639





LEGO.com/sustainable-packaging

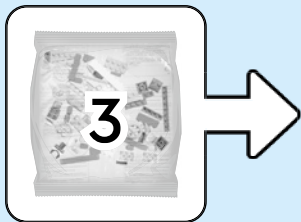
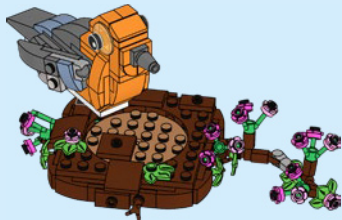
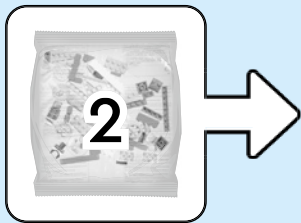
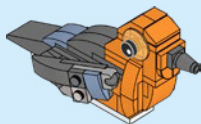
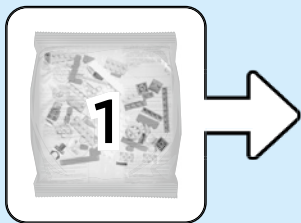



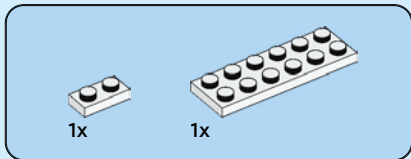
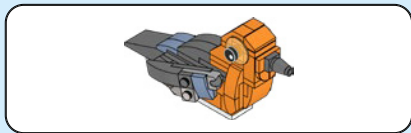

1

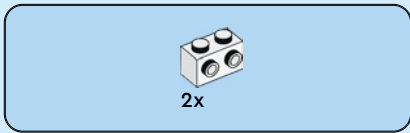
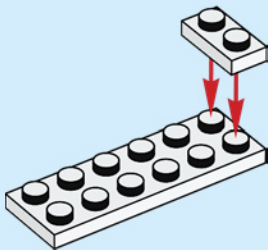

2

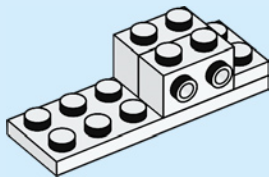



1x



1x

3

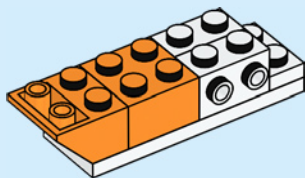

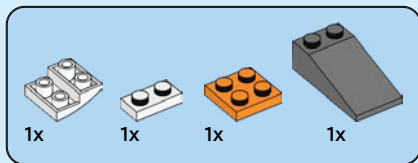

4

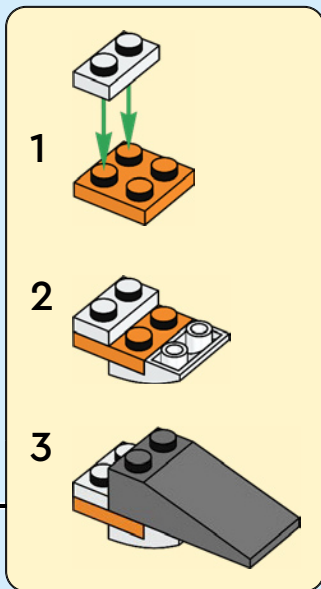
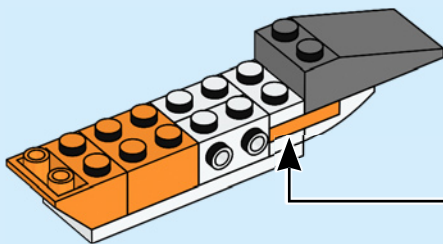



1x



1x

5

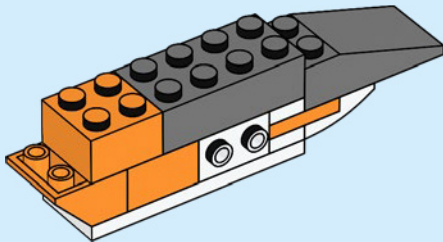



1x



2x



2x

6

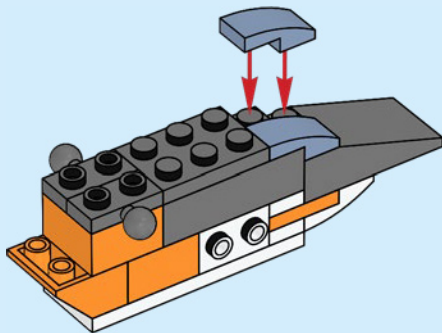

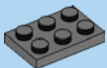

1x

7

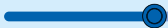
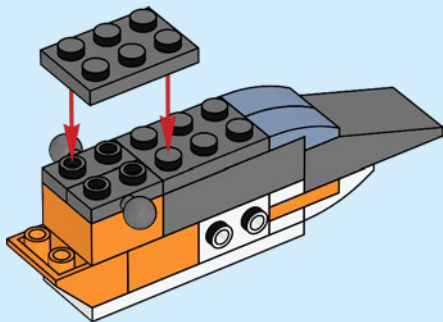



2x

8

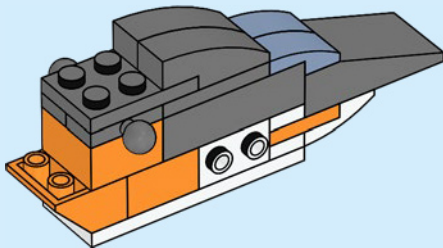

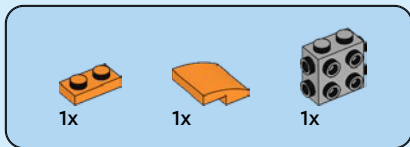

9

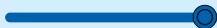
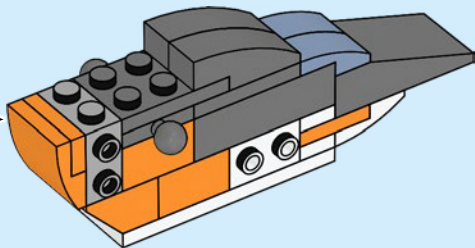
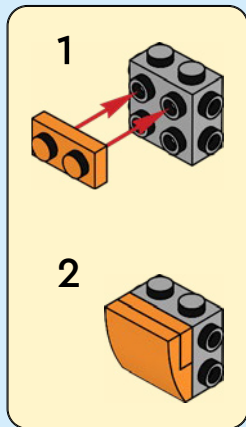

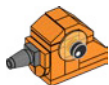

1x



1x

10

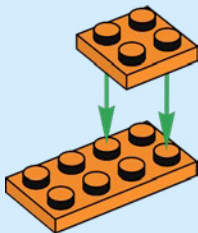

1x



1x

11

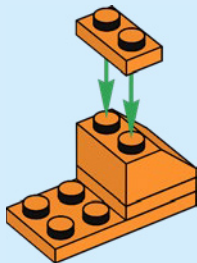



1x

12

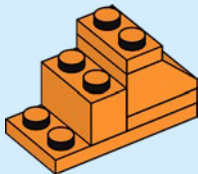

14



1x



2x

13

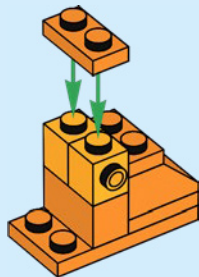



2x

14

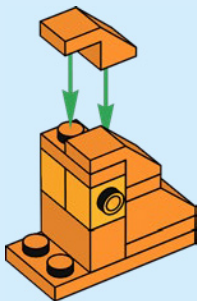

2x

15

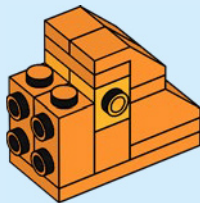



1x



1x

16

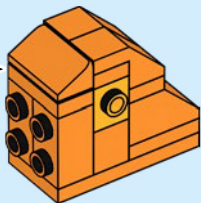
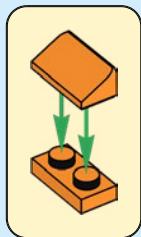

1x



2x

17

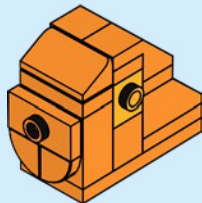



18

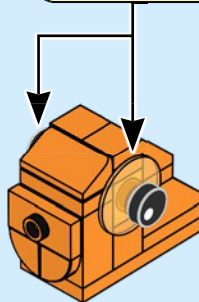
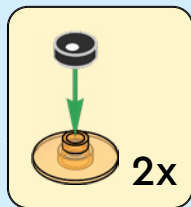



1x



1x

19

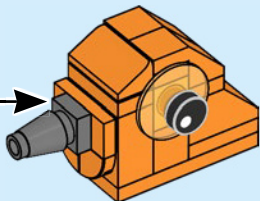
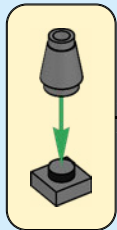

20

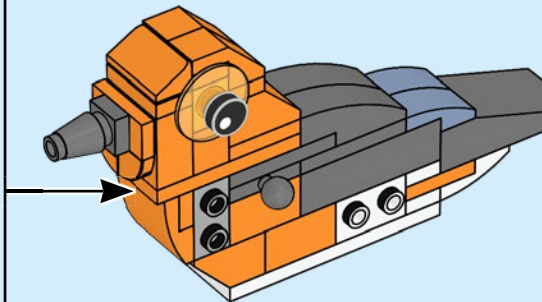



1x



1x



1x

21



1

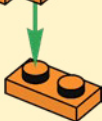

2

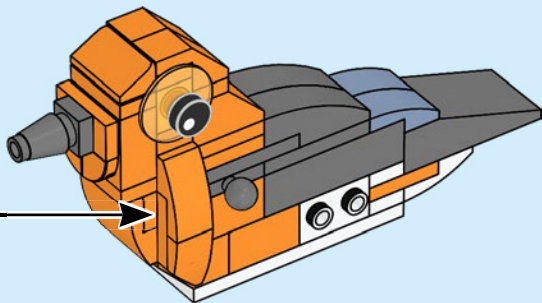

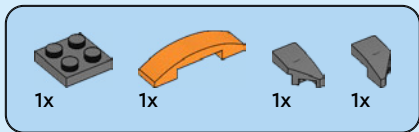

22

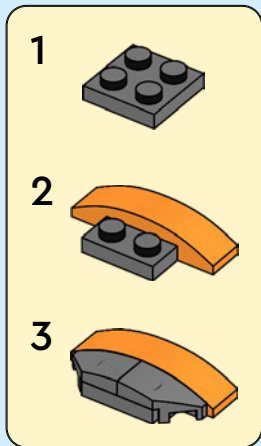
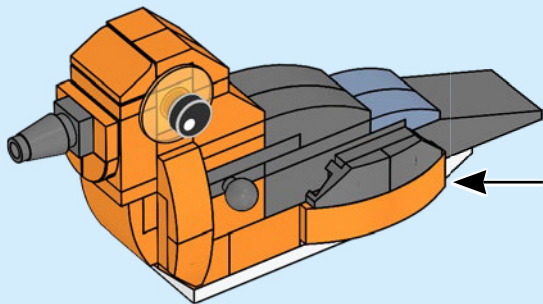

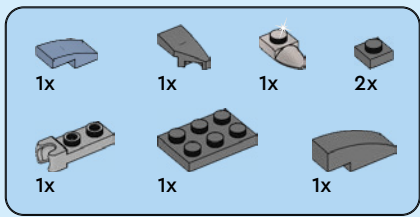

23

1

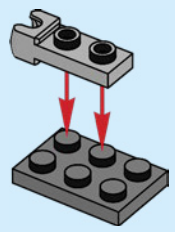

2

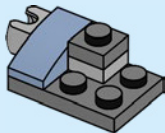

3

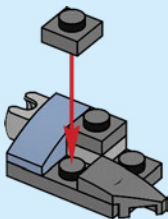

4

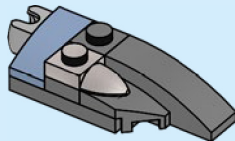

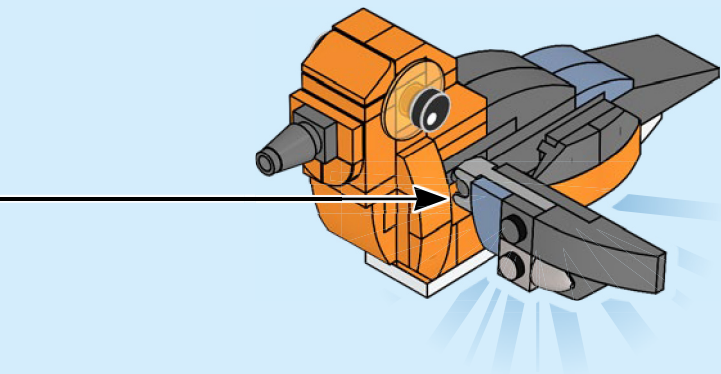

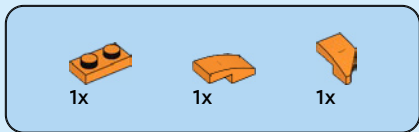

24

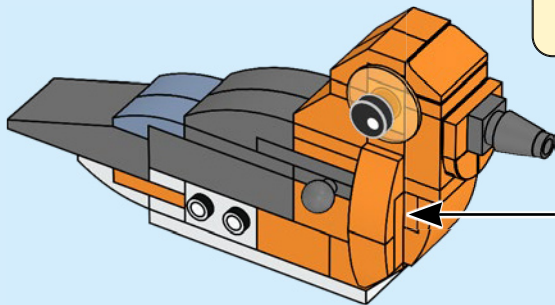
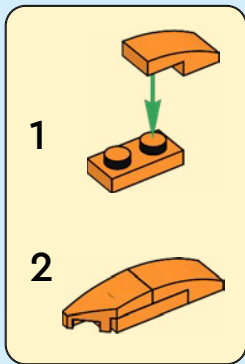

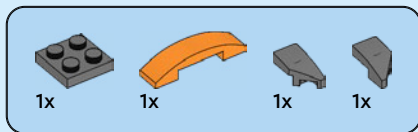

25

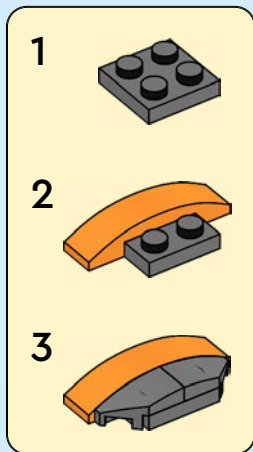
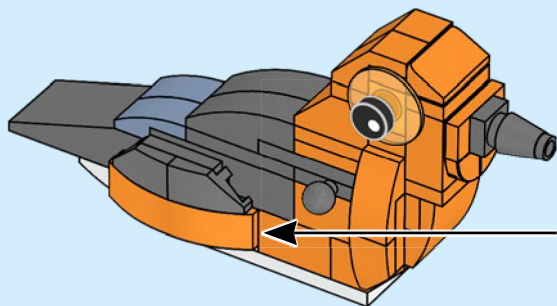



1x



1x



1x



2x



1x

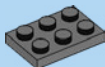

1x



1x

26

1

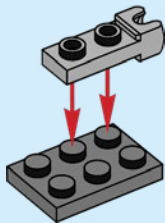

2

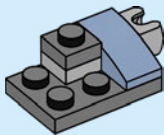

3

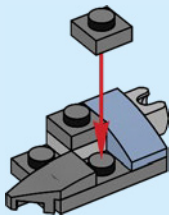

4

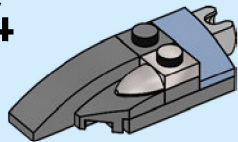

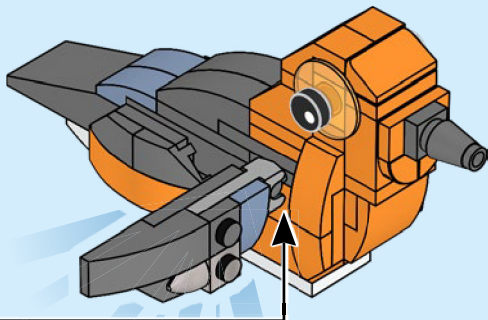

27

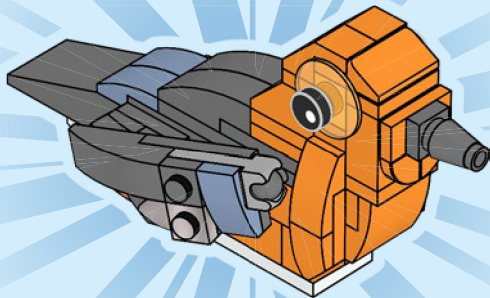

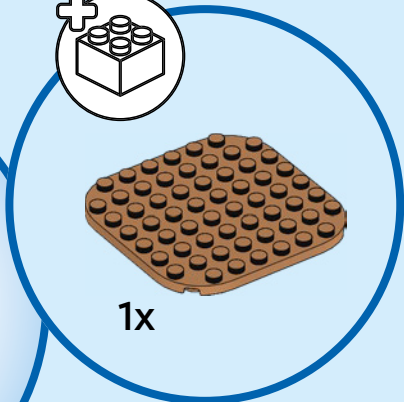

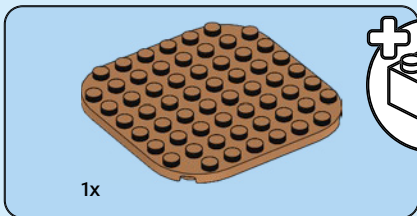
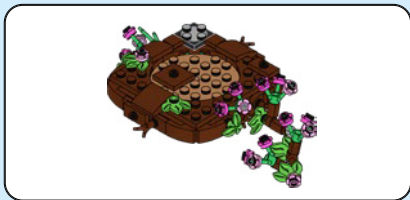

28

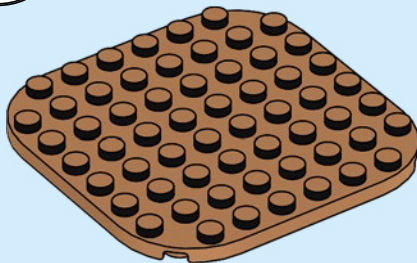



4x

29

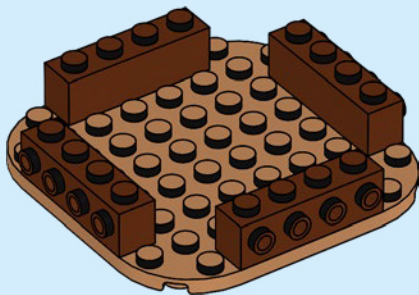



8x

30

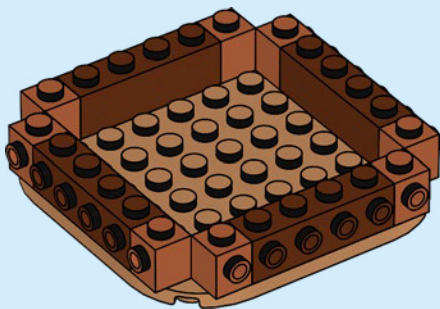



4x



4x

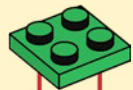

4x

31

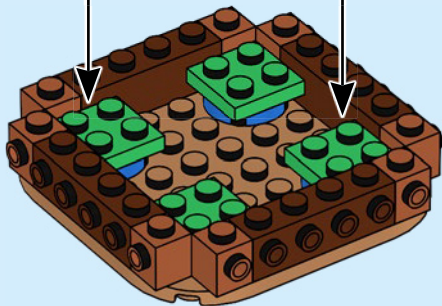



1x



1x

32

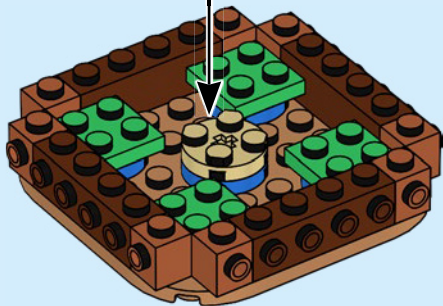
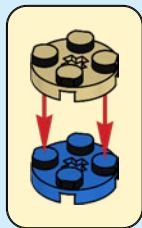

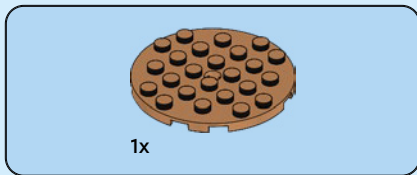

33

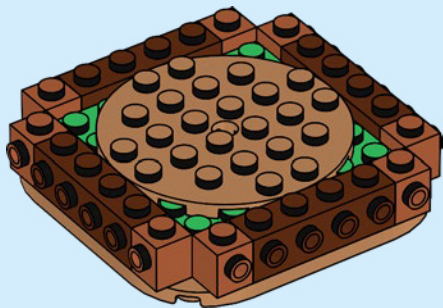



4x

34

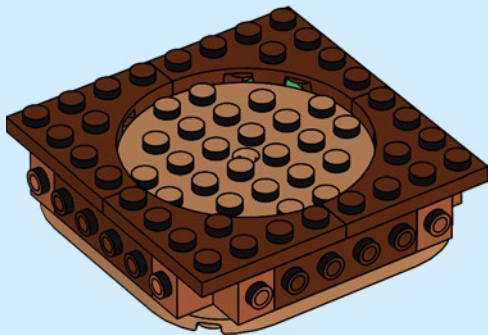



2x



2x



4x



6x



2x

35

1

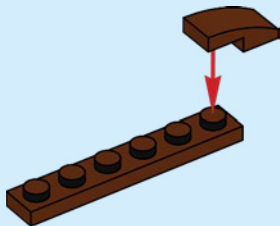

2

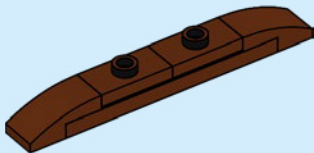

3

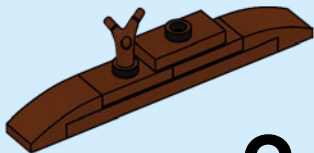

2x

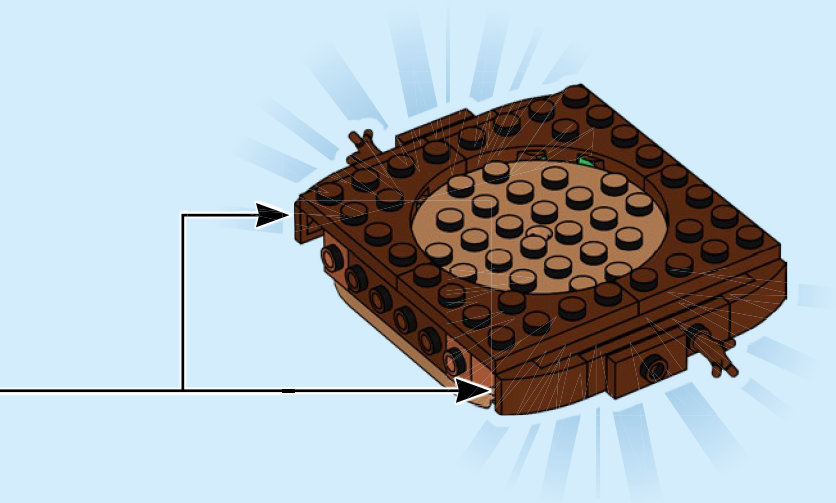



1x



1x

36

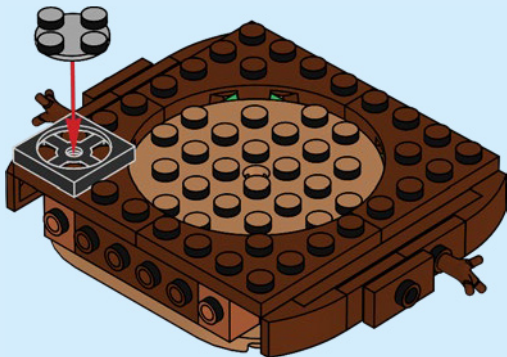



2x



1x



1x



1x

37

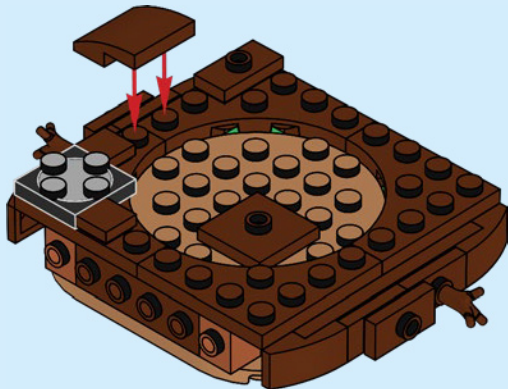



3x

38

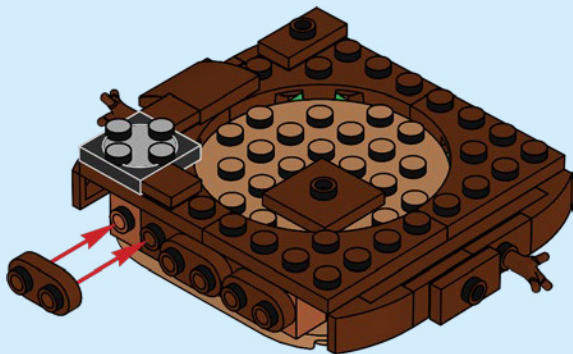



2x



1x



1x

39

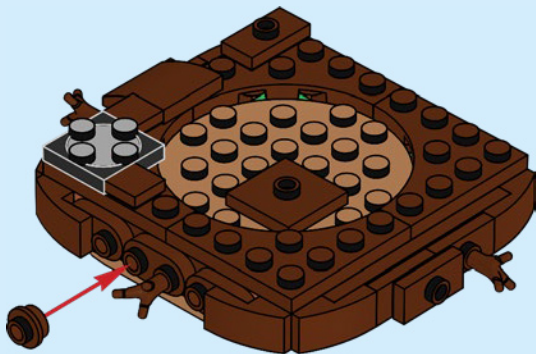



2x



2x



1x

40

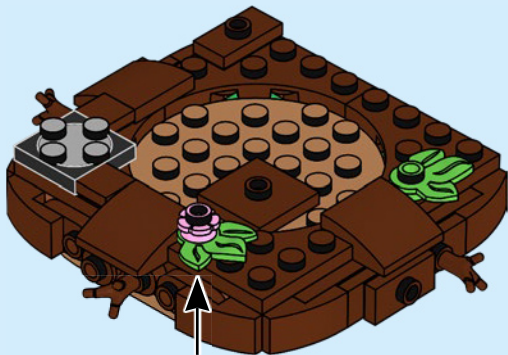



1x



1x

41





2x



1x



1x

42

1



2





3x

43

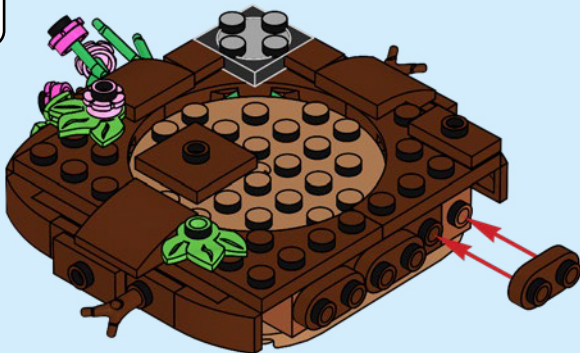



2x



2x



1x

44

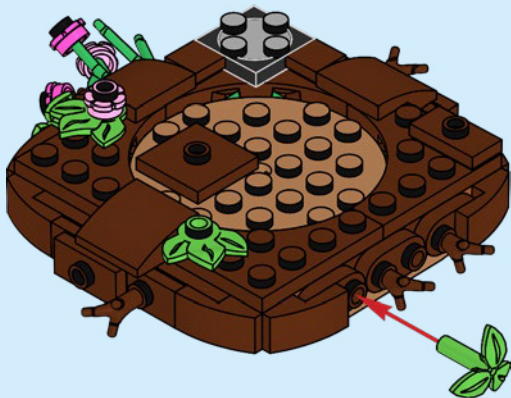

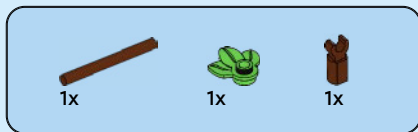

45

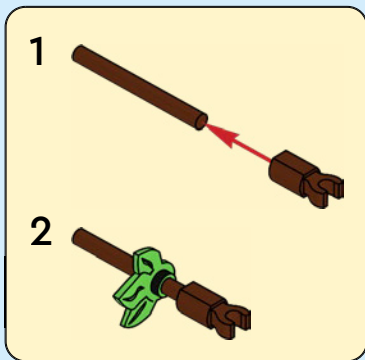

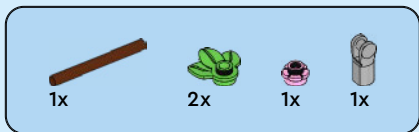

46

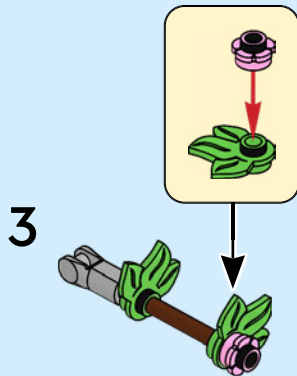
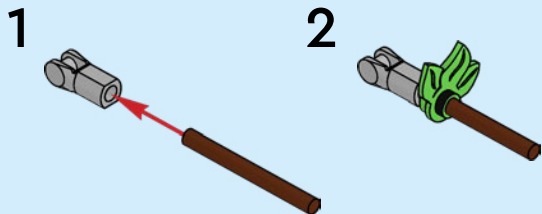

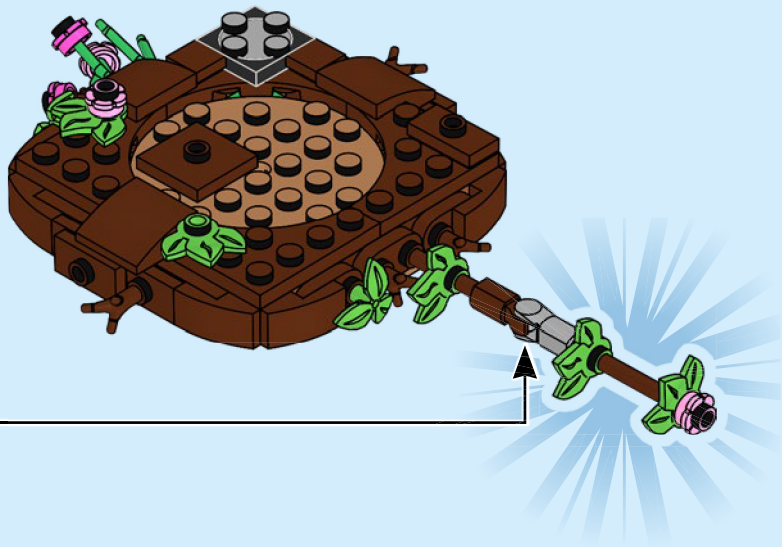

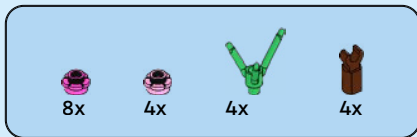

47

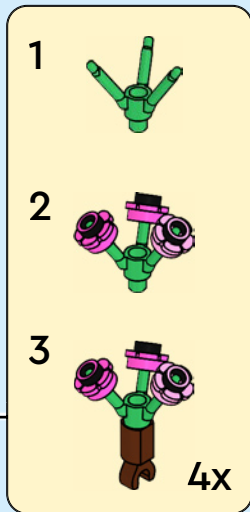
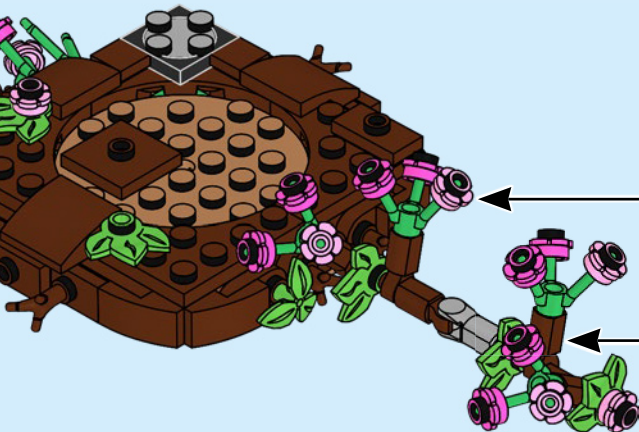

48



49

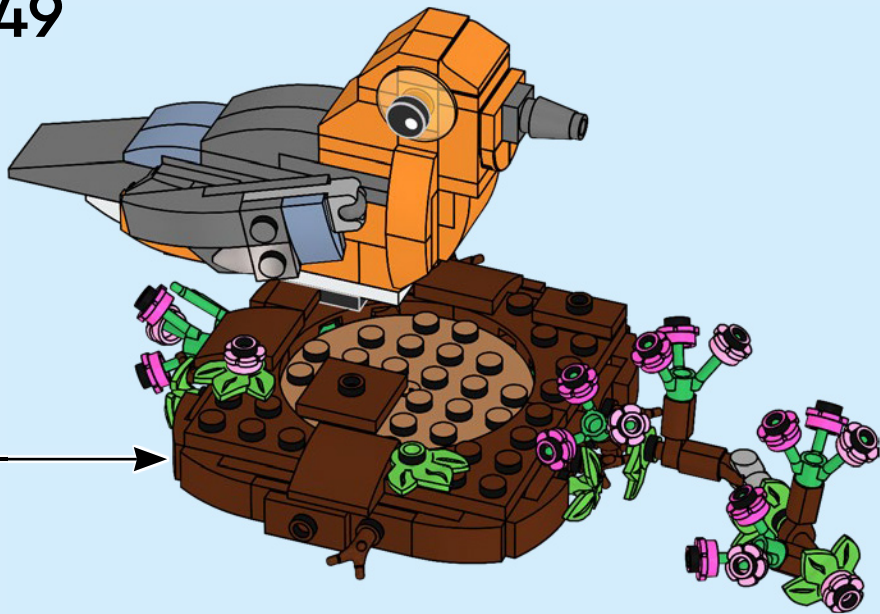





1x

50

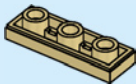

1x



1x

51

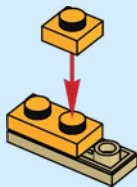



1x



1x

52

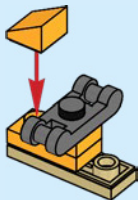

1x

53

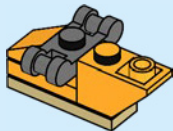



1x

54

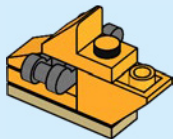

1x

55

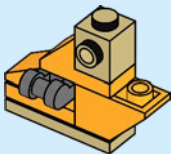



1x



2x

56

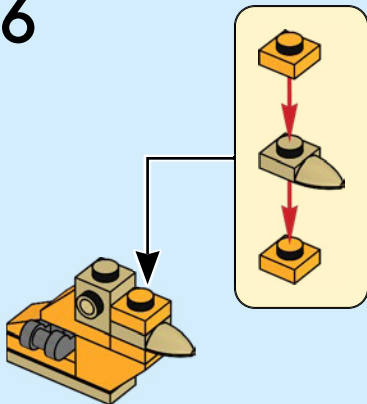

1x

57

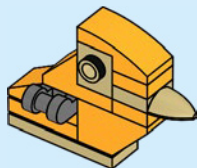

2x



2x

58

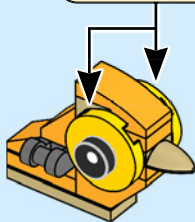
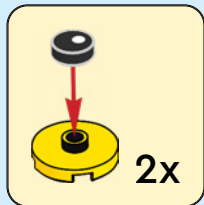

1x



1x



59

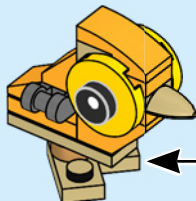
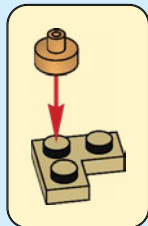



2x



2x

60



2x

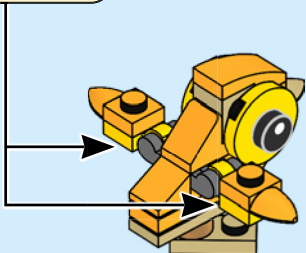

61





1x

62

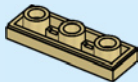

1x



1x

63

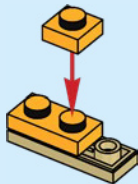



1x



1x

64

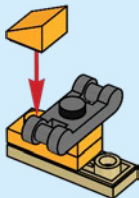

1x

65

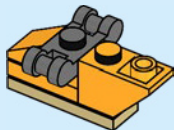



1x

66

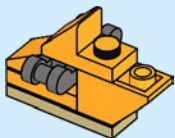

1x

67

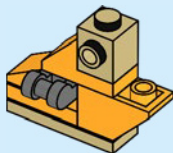



2x



1x

68

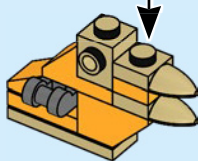
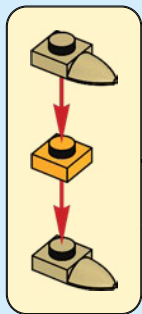

1x

69

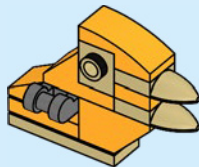

2x



2x

70

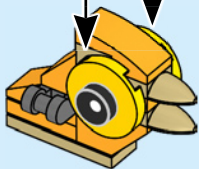
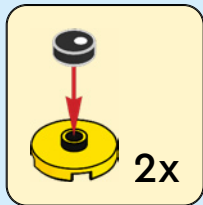

1x



1x

71

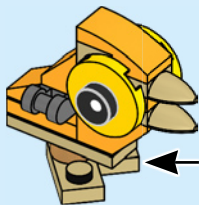
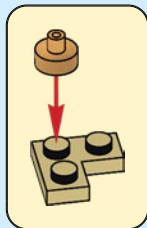



2x



2x

72



2x

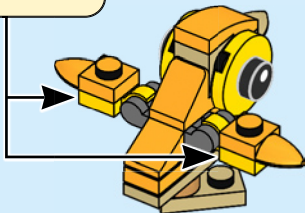

73





74



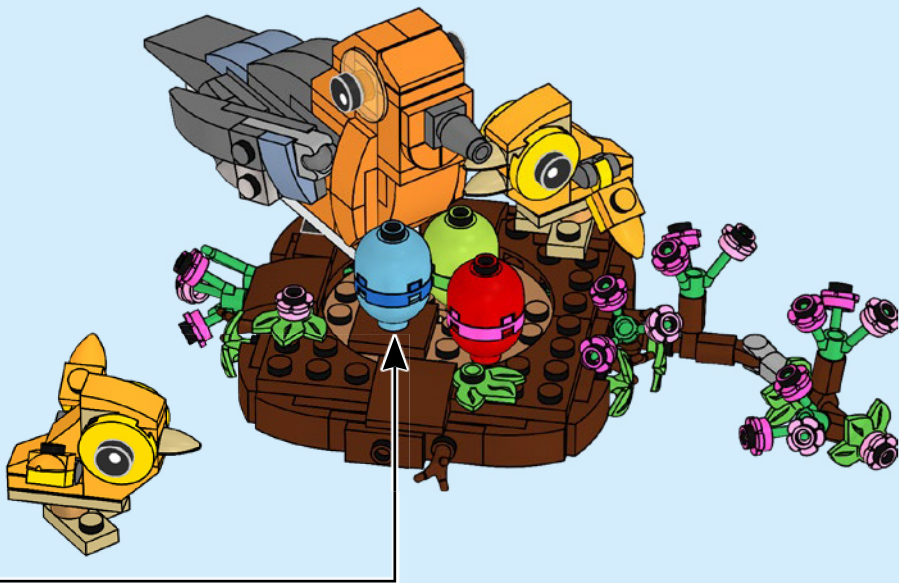





2x
302301



2x
6058177



1x
6210385



1x
379501



2x
4213568



3x
4224793



1x
4140562



2x
4114077



2x
6410762



1x
6065839



1x
4216657



6x
403223



4x
6179812



8x
4666322



6x
6269971



4x
302228



2x
6235080



5x
6182261



1x
6138624



1x
6214557



1x
4279734



1x
6177499



1x
6177490



1x
6068996



6x
4177932



1x
4121739



1x
6092599



2x
6055069



1x
4158355



2x
6181314



2x
4159007



1x
4118828



1x
6067913



1x
4118829



2x
4153825



2x
4650977



2x
6261640



2x
6173925



6x
6284072



1x
368026



2x
6023173



2x
6099728



2x
6028736



5x
6073040



4x
4282860



2x
6092035



2x
6330901



2x
6136455



1x
6343976



1x
4540203



1x
6301870



2x
6043639



4x
6347294



4x
6299764



5x
6341968



5x
6345847



1x
6215659



2x
4211288



6x
6248944



7x
6092590



8x
6069984



1x
4565394



3x
6146858



2x
6116613



4x
6153594



2x
4221590



4x
6228841



1x
4529240



3x
6204668



5x
4210719



3x
6204667



2x
6039479



2x
6352600



2x
4211094



4x
4246896



4x
4211043



1x
4210637



1x
4211085



1x
6345302

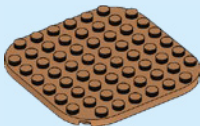

1x
6350709



1x
6132411



1x
6036500



2x
6245310



10x
6209679



1x
6326495



7x
6212501



2x
4625146



2x
6186672



[LEGO.com/service](https://www.LEGO.com/service)

YOU COULD

WIN



Scan this QR code or go to
LEGO.COM/PRODUCTFEEDBACK and give us
your short feedback about this LEGO® set
for a chance to win a cool LEGO prize.

Terms and Conditions apply*

DE: Du könntest GEWINNEN. Es gelten die Teilnahmebedingungen* **FR: Tu pourrais GAGNER.** Des conditions s'appliquent* **IT: Potresti VINCERE tu.** Termini e condizioni sono applicabili* **ES: Puedes GANAR.** Aplican términos y condiciones* **PT: Poderá GANHAR.** Aplicam-se termos e condições* **JA: プレゼント付き! 利用規約が適用されます*** **ZH: 轻松获奖. 条款和条件适用*** **KO: 상품의 주인이 되어보세요. 소정의 약관이 적용됩니다*** **RU: Вы можете ВЫИГРАТЬ.** Действуют положения и условия* **PL: Szansa na WYGRANĄ.** Obowiązują warunki korzystania* **CS: Máte šanci VYHRÁT.** Platí všeobecné smluvní podmínky* **SK: Máte šancu VYHRATĚ.** Platia všeobecné zmluvné podmienky* **HU: TE IS NYERHETSZ.** Felhasználási feltételek érvényesek* **RO: Ai putea CÂȘTIGA.** Se aplică termenii și condiții* **BG: Можете да СПЕЧЕЛИТЕ.** Има определени правила и условия* **LV: Tu vari LAIMĒT.** Ir spēkā noteikumi un nosacījumi.* **ET: Sul on võimalus VÕITA.** Kehtivad tingimused* **LT: Jūs galite LAIMĖTI.** Taikomos sąlygos*

*[LEGO.com/productfeedback-terms](https://www.lego.com/productfeedback-terms)