



Friends

41745



1



FR
DONNEZ
OU
RECYCLEZ

 OU  OU 

ASSOCIATION MAGASIN DÉCHÈTERIE

Adresses sur quefairedemesdechets.fr



LEGO.com/sustainable-packaging

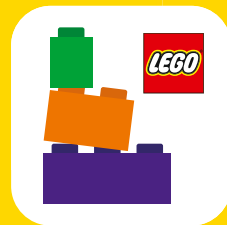

BUILDER



Apple and the Apple logo are trademarks of Apple Inc., registered in the U.S. and other countries and regions. App Store is a service mark of Apple Inc. Google Play and the Google Play logo are trademarks of Google LLC. Tencent and the Tencent logo are trademarks of Tencent Inc.

[LEGO.com/devicecheck](https://www.lego.com/devicecheck)

EN Ask parents' permission before going online | **DE** Eltern um Erlaubnis bitten, bevor du online gehst | **FR** Demande l'autorisation d'un parent avant d'aller en ligne | **IT** Chiedi il permesso ai tuoi genitori prima di andare online | **ES** Pídeles permiso a tus papás antes de conectarte a Internet | **PT** Pede autorização aos pais antes de acederes online | **JA** オンラインになる前に ほか者の方のきよかをもらおう | **ZH** 上网前应先征得父母的同意 | **KO** 온라인 접속 전에 보호자 동의가 필요합니다 | **RU** Спроси разрешения у родителей, прежде чем заходить в интернет | **PL** Poproś rodziców o zgodę, zanim wejdziesz do Internetu | **CS** Než půjdeš na internet, požádej rodiče o svolení | **SK** Skôr než pôjdeš na internet, vypýtaj si povolenie od rodičov | **HU** Kérj szülői engedélyt, mielőtt online csatlakoznál! | **RO** Cere permisiunea părinților înainte de a te conecta online | **BG** Поискайте разрешение от родител, преди да влезете онлайн | **LV** Pirms došanās tiešsaistē palūdz atļauju vecākiem | **ET** Enne Interneti kasutamist küsi vanematelt luba | **LT** Prieš prisijungdami prie interneto, atsklauskite tėvų

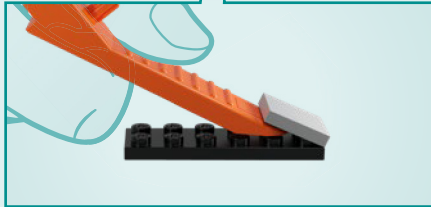
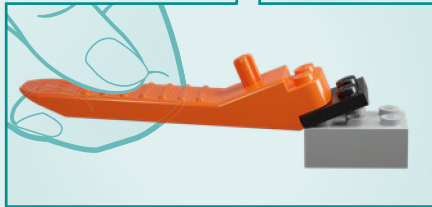
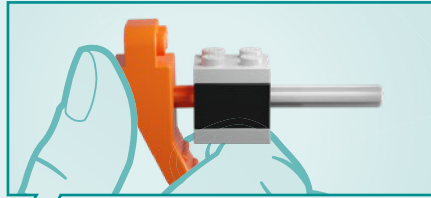
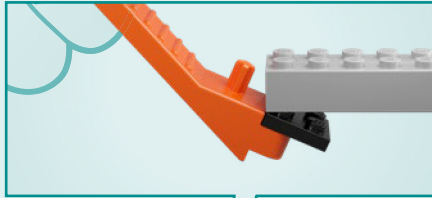



AUTUMN

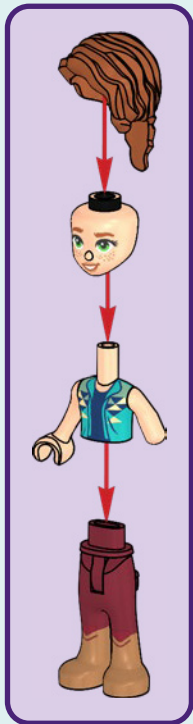
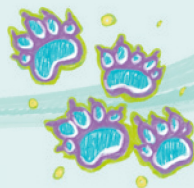

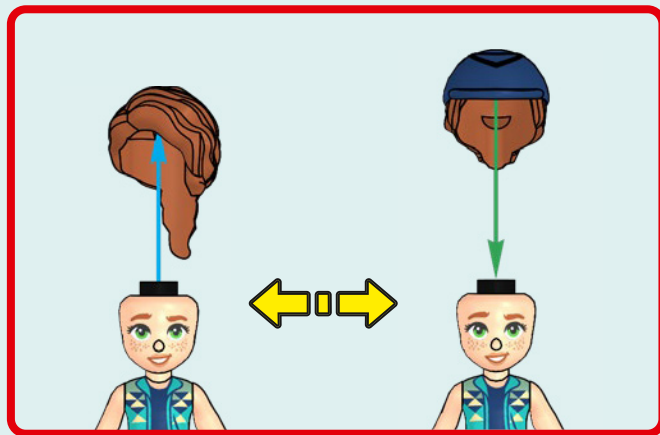
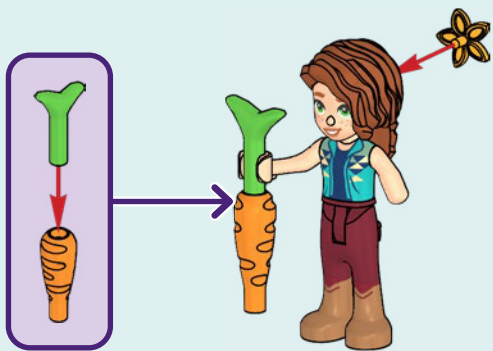

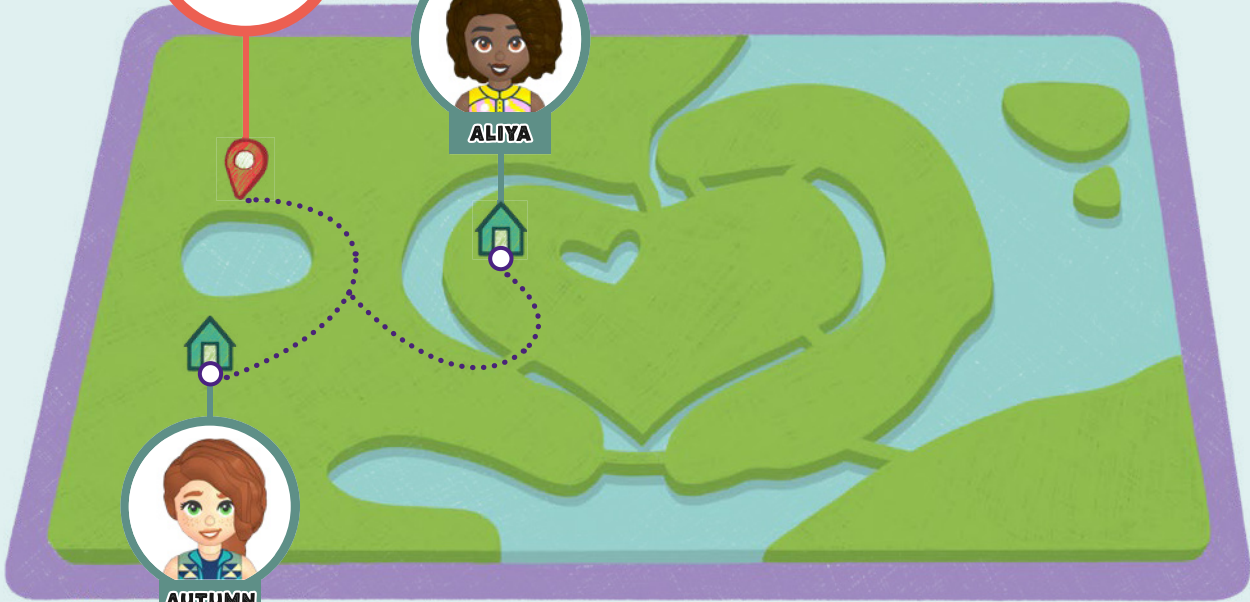

1

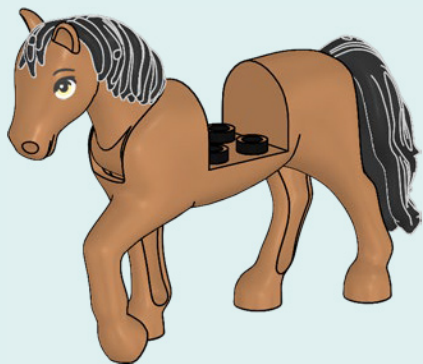

2

SPRING

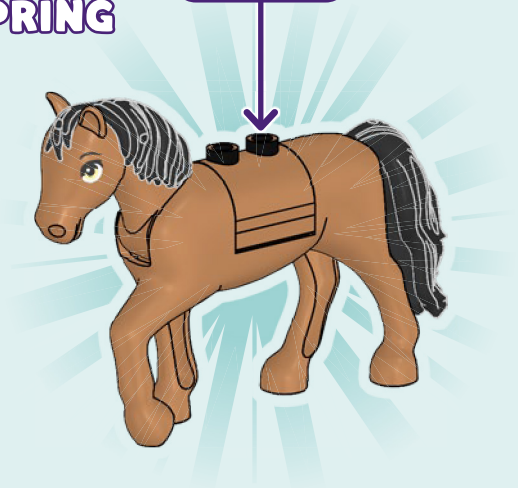
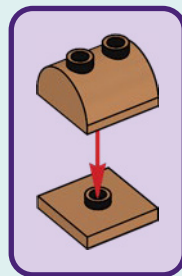

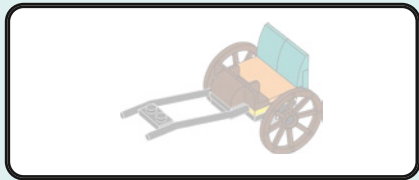

1x



1x

1

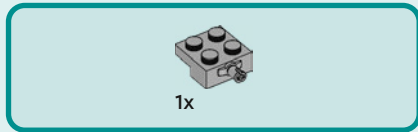
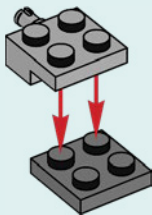

1x

2

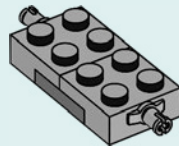



1x

3

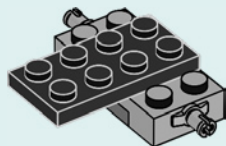

2x

4

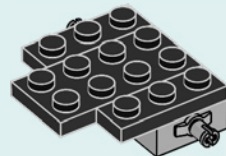



2x

5

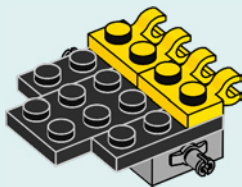

2x

6

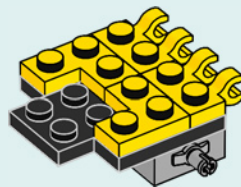

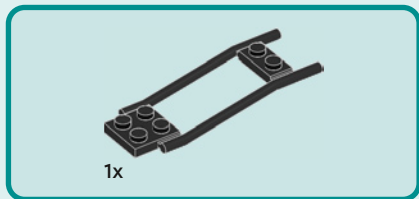

7

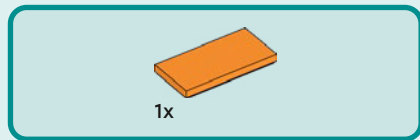
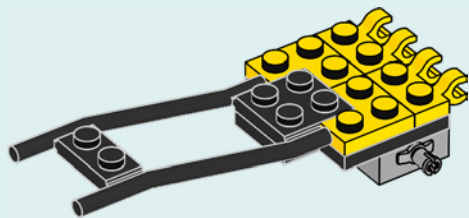

8

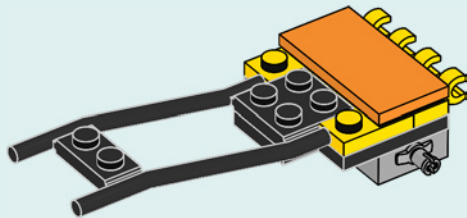



2x

9

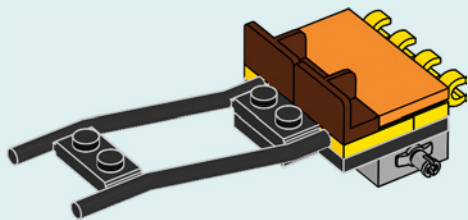

1x

10

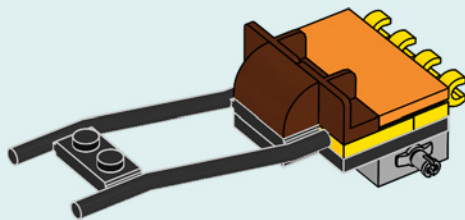

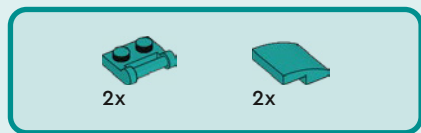

11

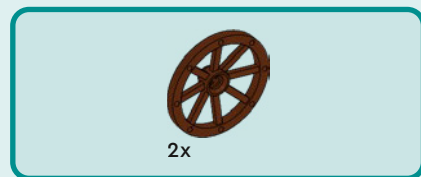
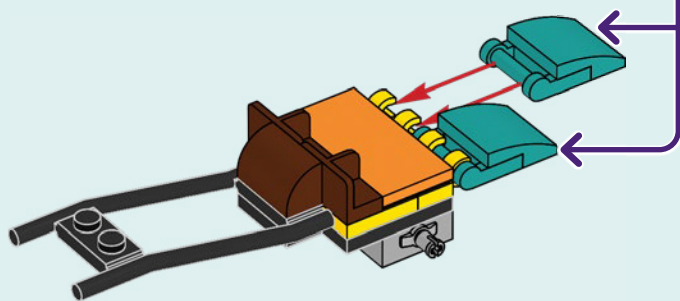
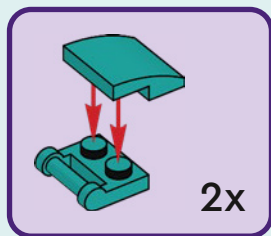

12

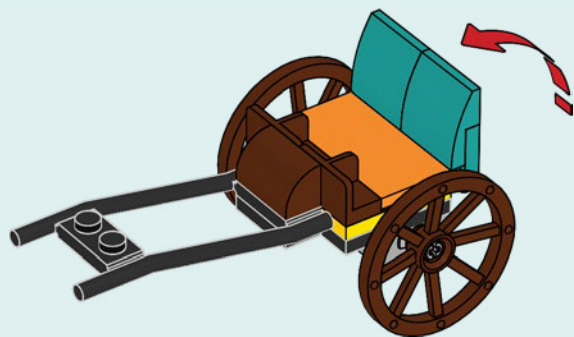

13

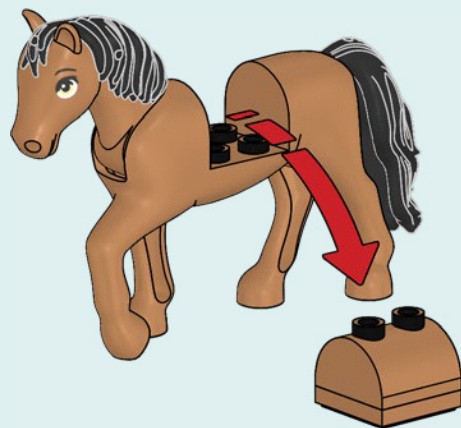



1x

14



15

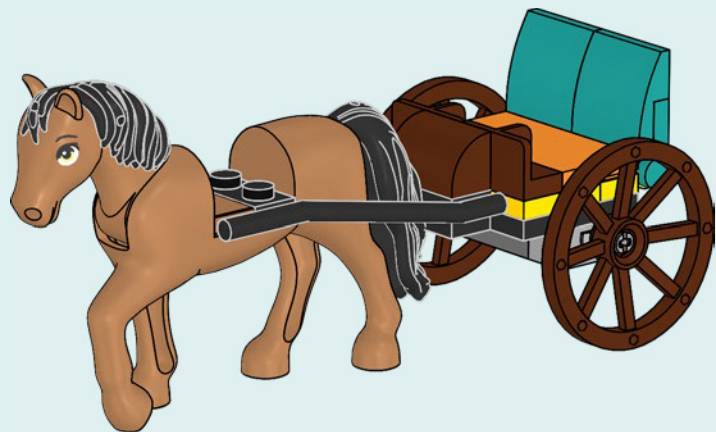

16

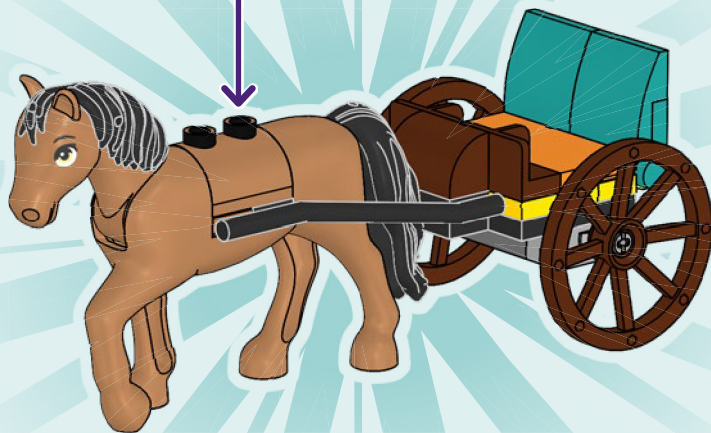
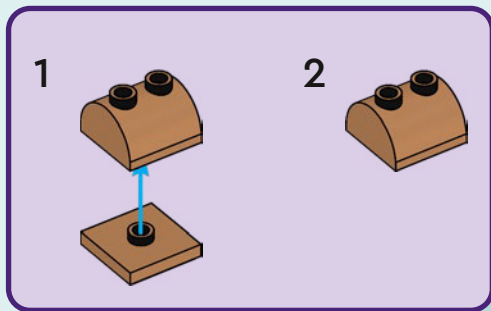

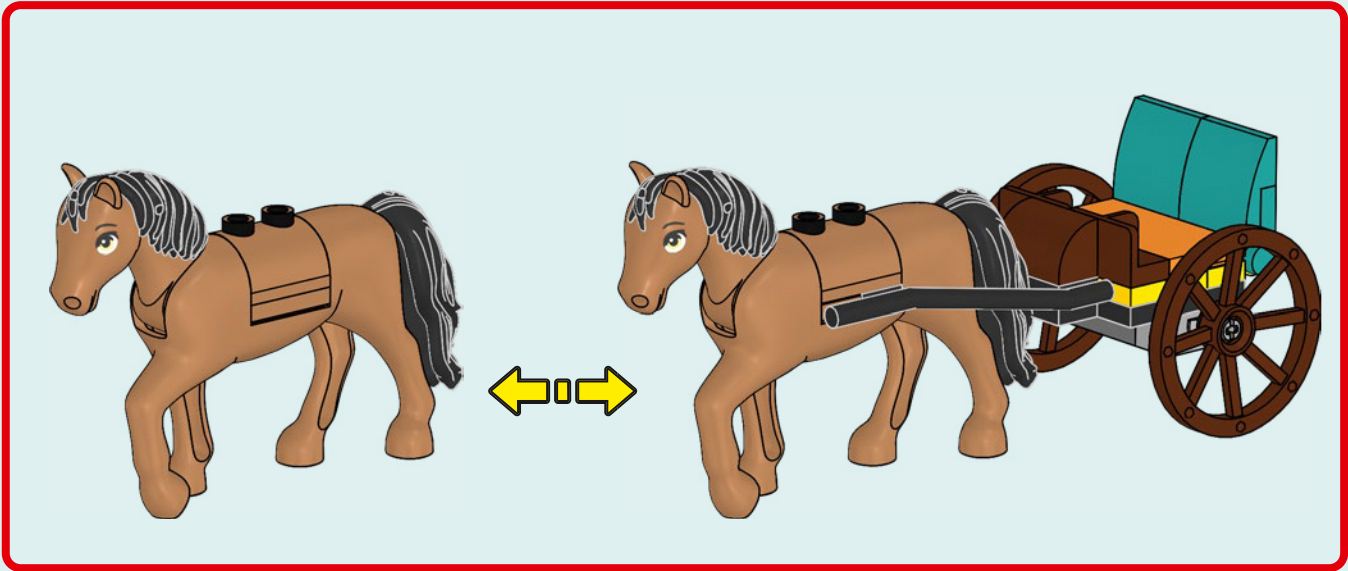

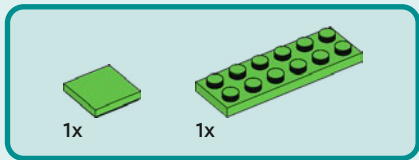
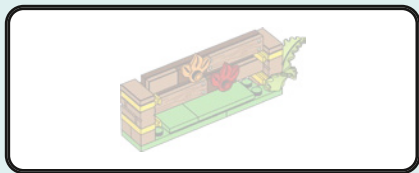

1

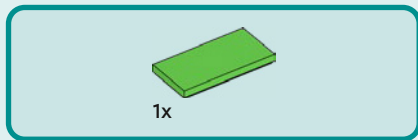
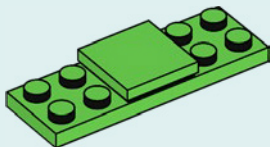

2

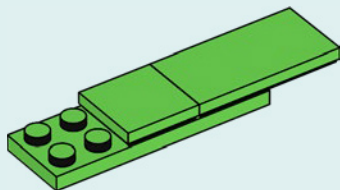

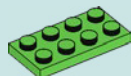

1x

3

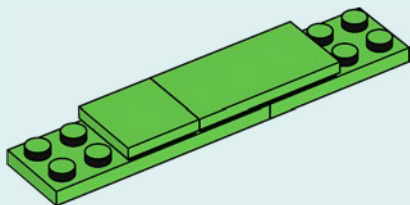

3x

4

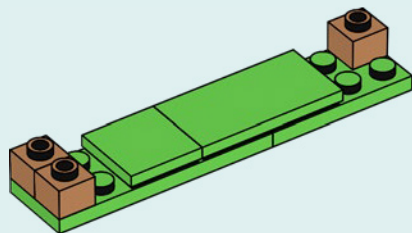



2x

5

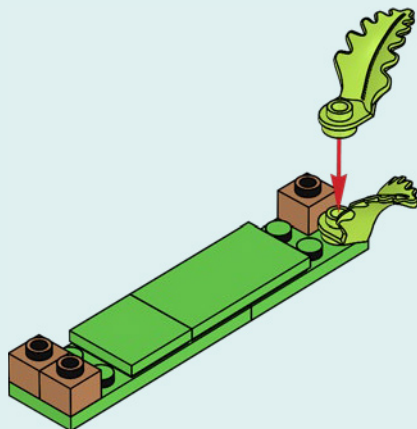

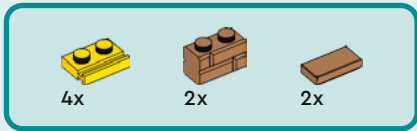

6

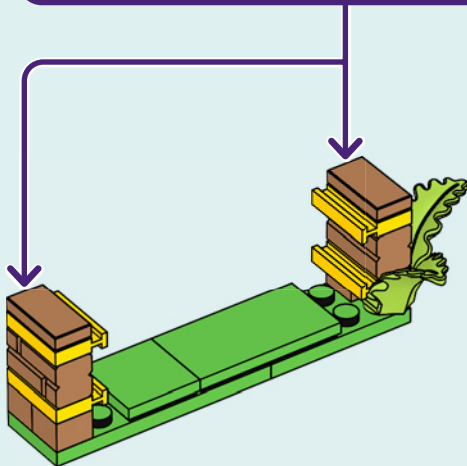
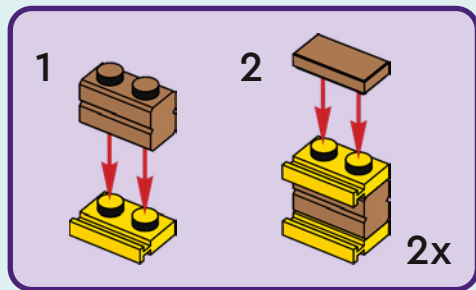

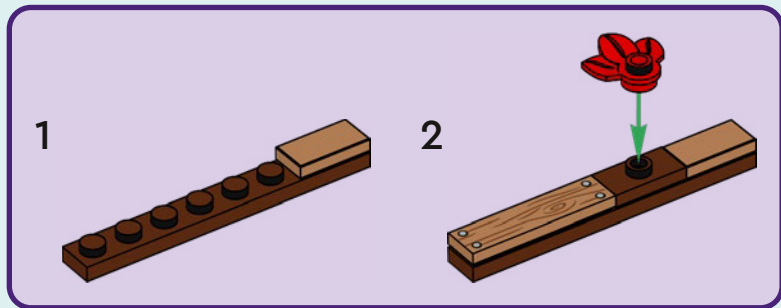
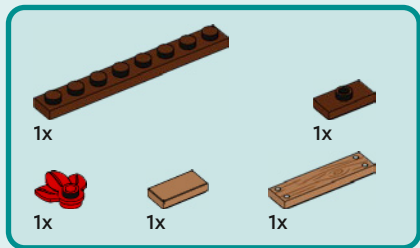

7

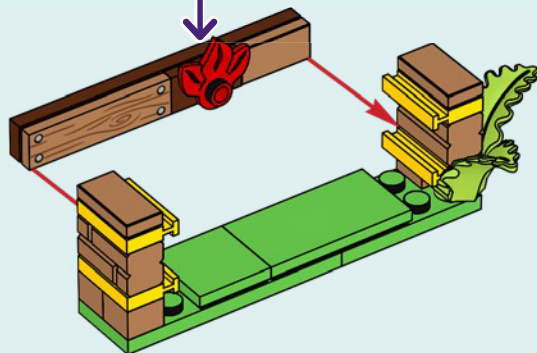

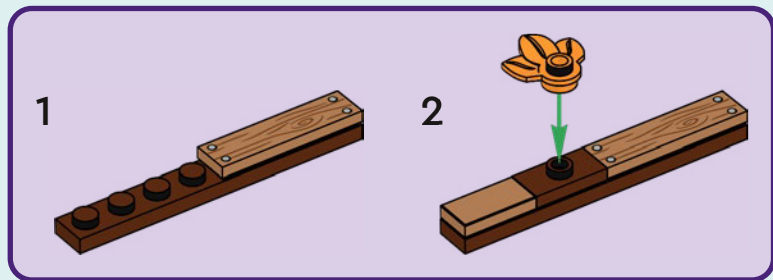
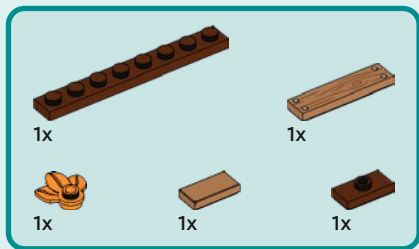

8

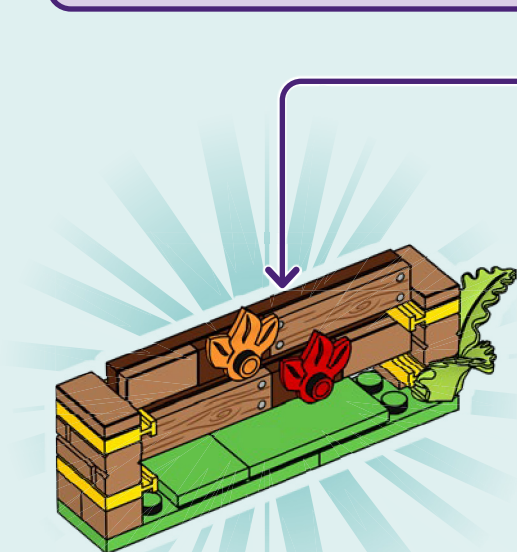

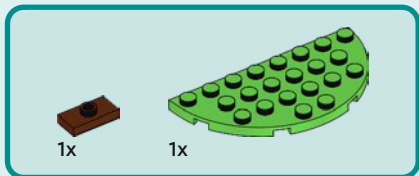
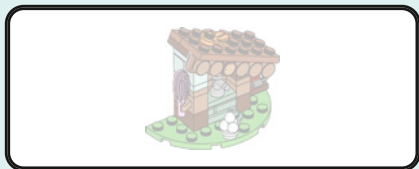

1

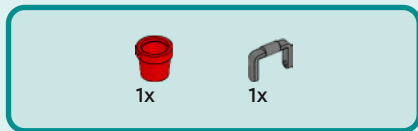
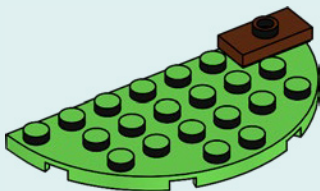

2

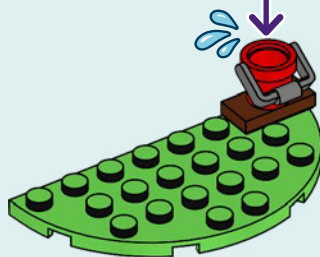



2x

3

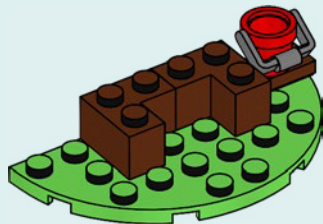

1x

4

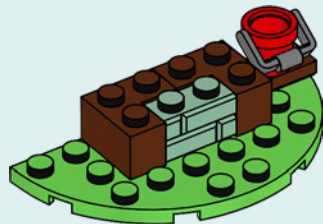



1x



2x

5

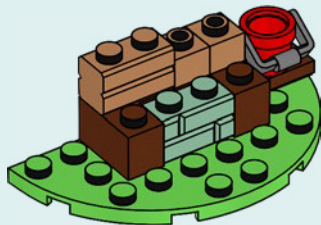

1x



1x



1x

6

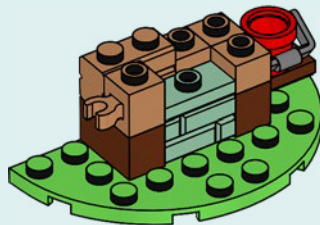



1x

7

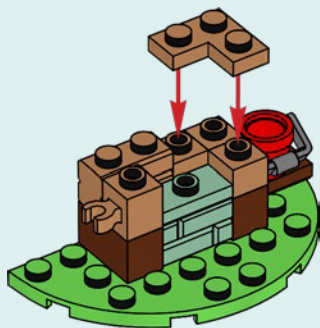

1x



1x



1x

8

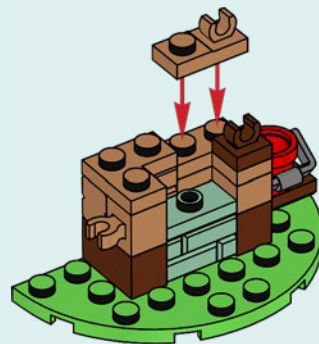



1x



1x

9

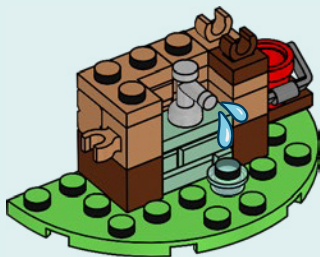

2x



1x

10

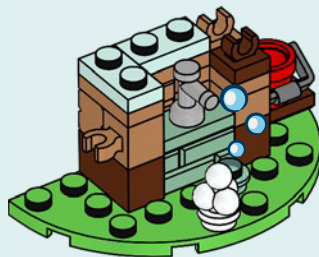



1x



1x

11

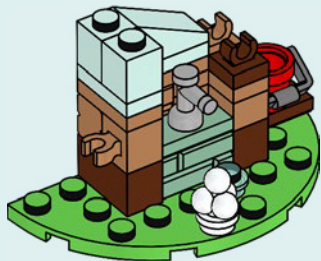

1x

12

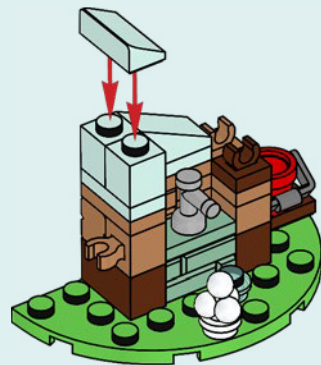



1x

13

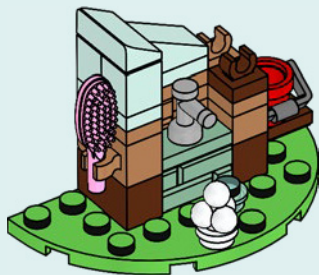

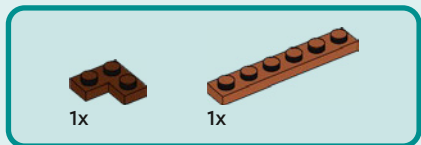

14

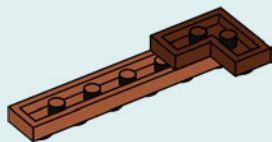

15

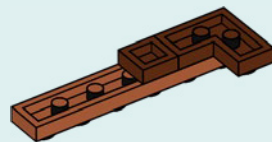



1x

16

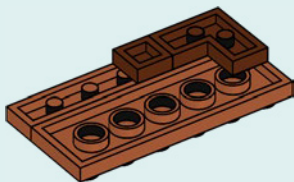

1x

17

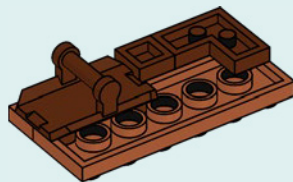



1x

18

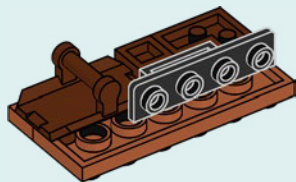

19

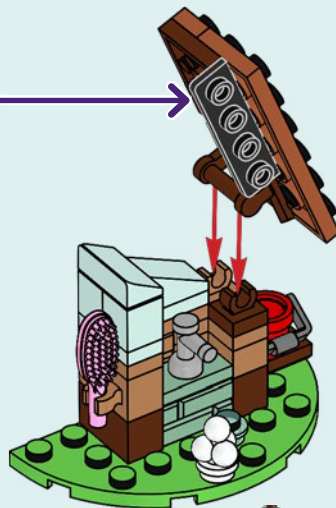

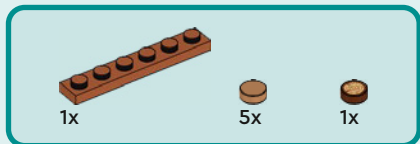

20

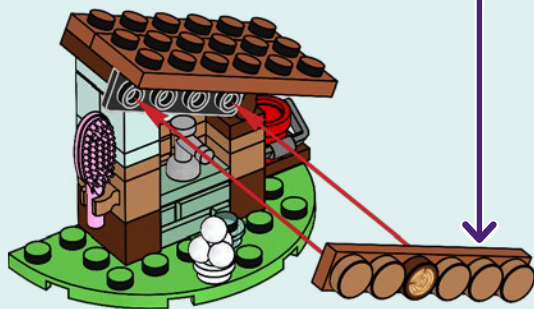
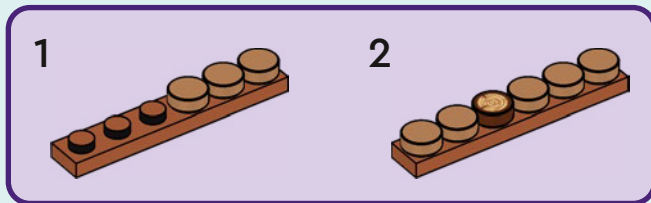



1x

21





Friends

AUTUMN

ALIYA

PAISLEY

ZAC



LEO

LIANN

OLLY

NOVA



YOU COULD **WIN**



Scan this QR code or go to **LEGO.COM/PRODUCTFEEDBACK** and give us your short feedback about this LEGO® set for a chance to win a cool LEGO prize.

Terms and Conditions apply*

EN: YOU COULD WIN. Terms and Conditions apply* **DE: Du könntest GEWINNEN.** Es gelten die Teilnahmebedingungen* **FR: Tu pourrais GAGNER.** Des conditions s'appliquent* **IT: Potresti VINCERE tu.** Termini e condizioni sono applicabili* **ES: Puedes GANAR.** Aplican términos y condiciones* **PT: Poderá GANHAR.** Aplicam-se termos e condições* **ZH: 轻松获奖. 条款和条件适用*** **PL: Szansa na WYGRANĄ.** Obowiązują warunki korzystania* **CS: Máte šanci VYHRÁT.** Platí všeobecné smluvní podmínky* **SK: Máte šancu VYHRAŤ.** Platia všeobecné zmluvné podmienky* **HU: TE IS NYERHETSZ.** Felhasználási feltételek érvényesek* **RO: Ai putea CÂȘTIGA.** Se aplică termenii și condiții* **BG: Можете да СПЕЧЕЛИТЕ.** Има определени правила и условия* **LV: Tu vari LAIMĒT.** Ir spēkā noteikumi un nosacījumi.* **ET: Sul on võimalus VÕITA.** Kehtivad tingimused* **LT: Jūs galite LAIMĖTI.** Taikomos sąlygos*

*LEGO.com/productfeedback-terms



Friends

41745



2

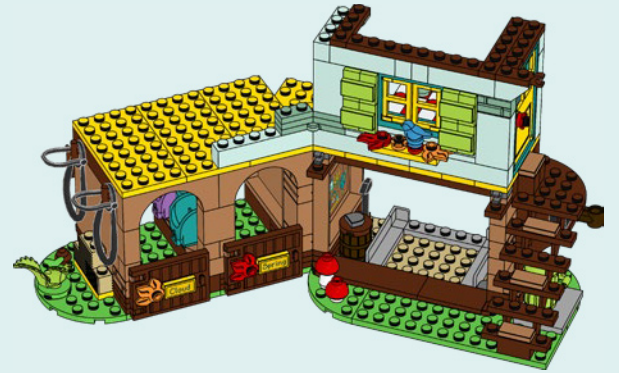
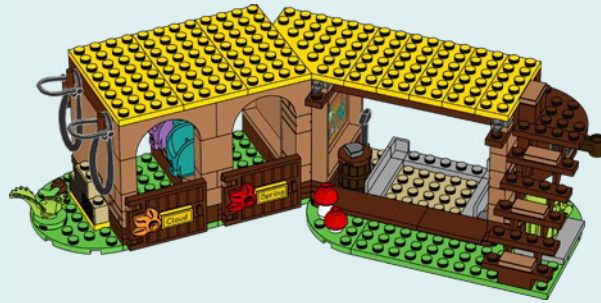
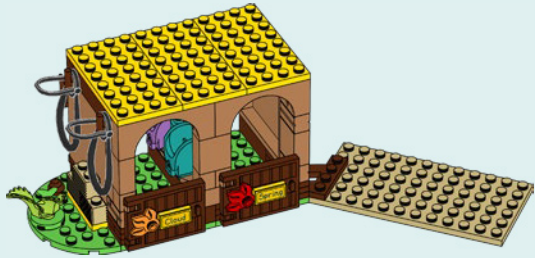
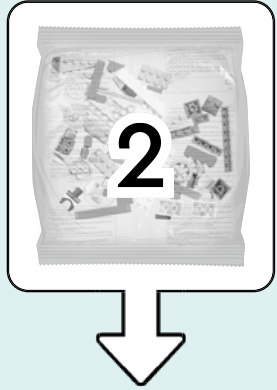

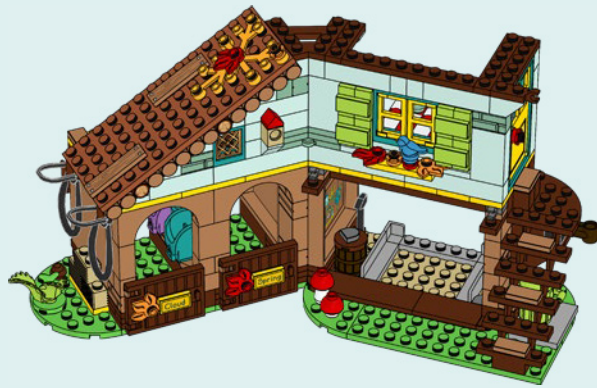



ALIYA

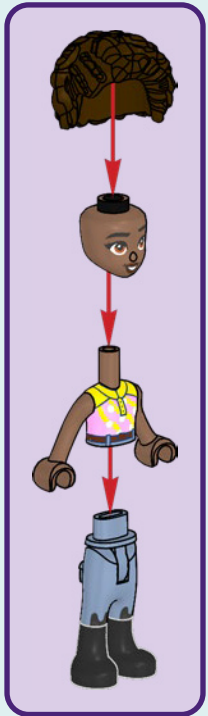

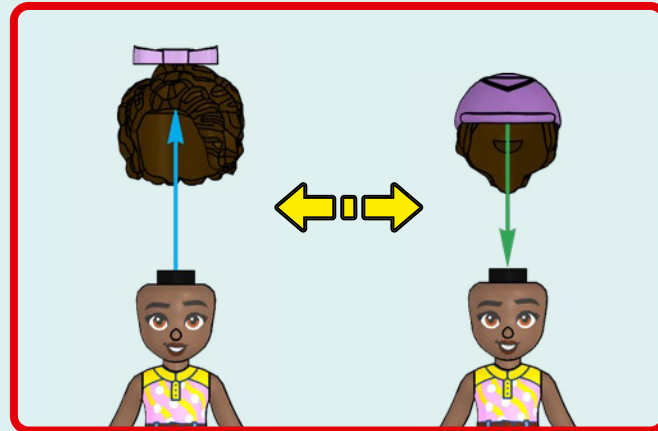

1

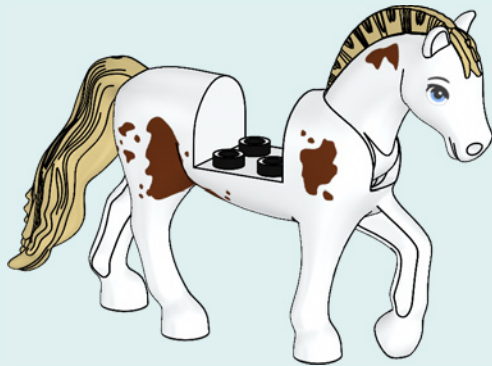

2

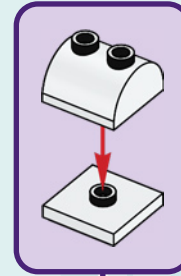

CLOUD

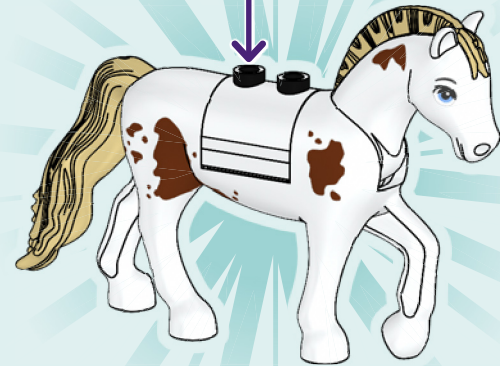

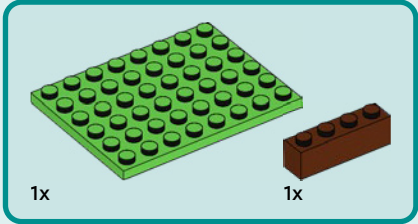
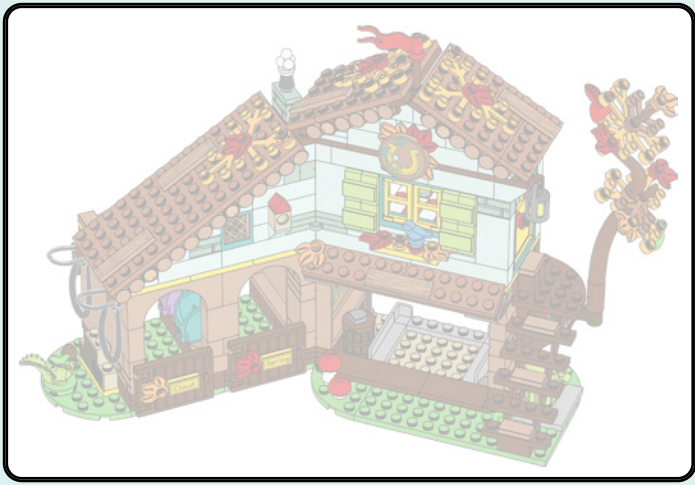

1

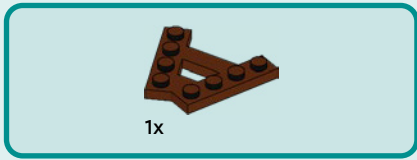
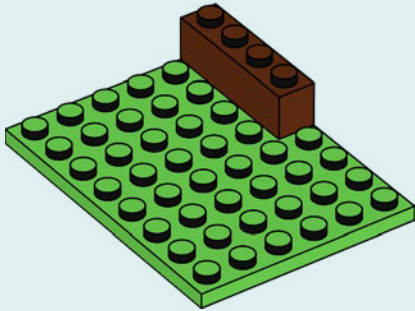

2

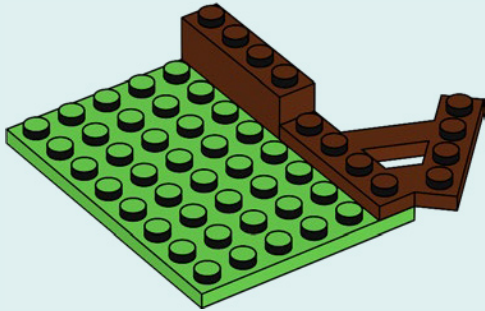

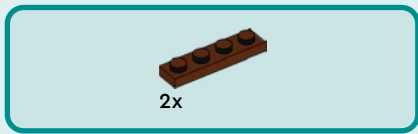

3

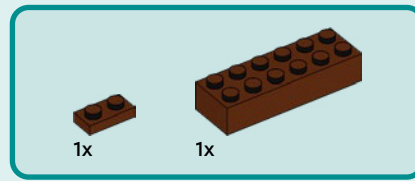
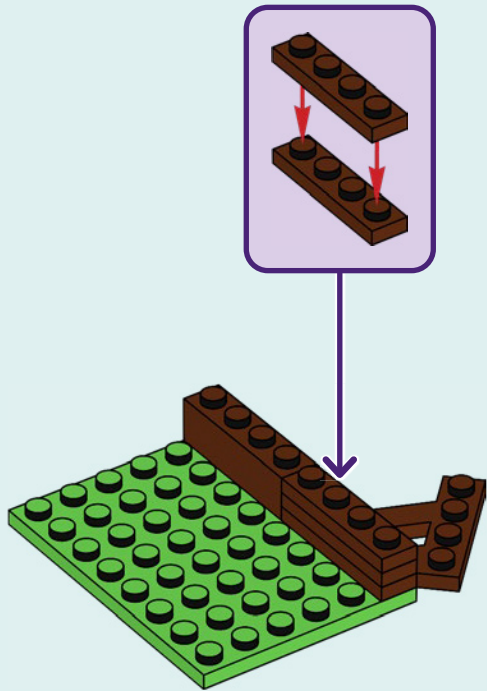

4

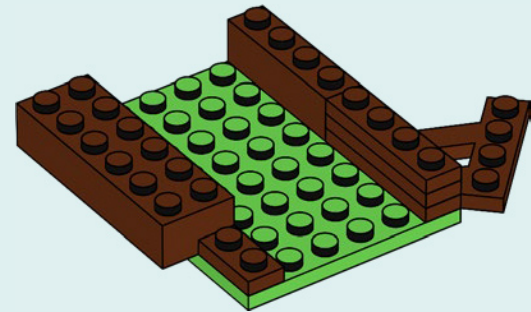

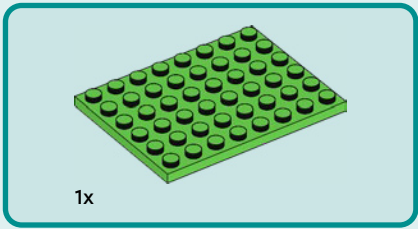

5

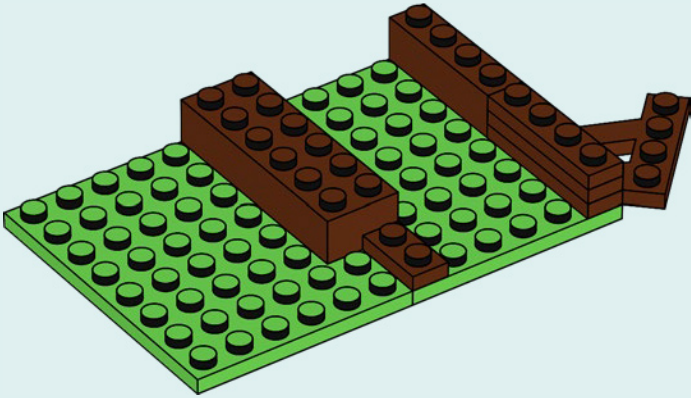

6

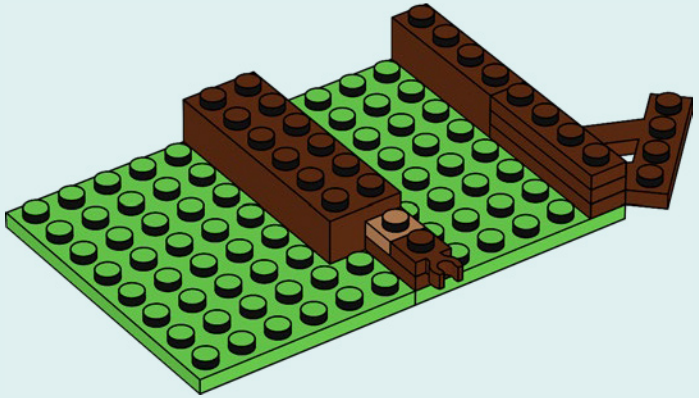

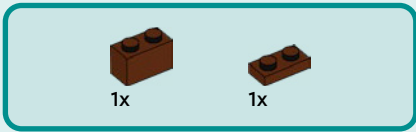

7

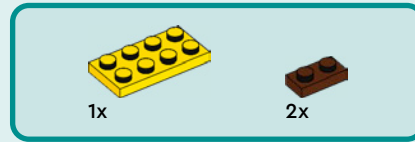
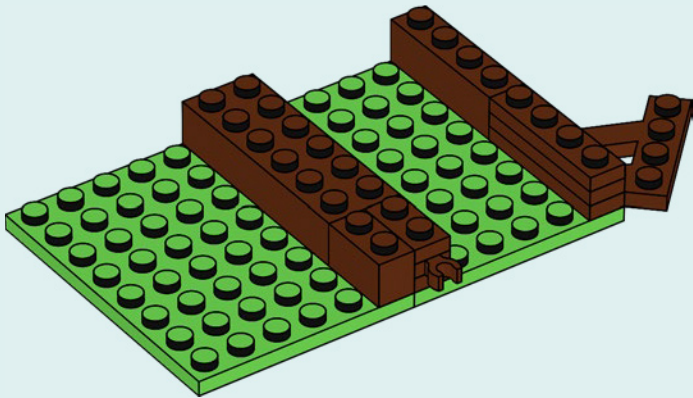

8

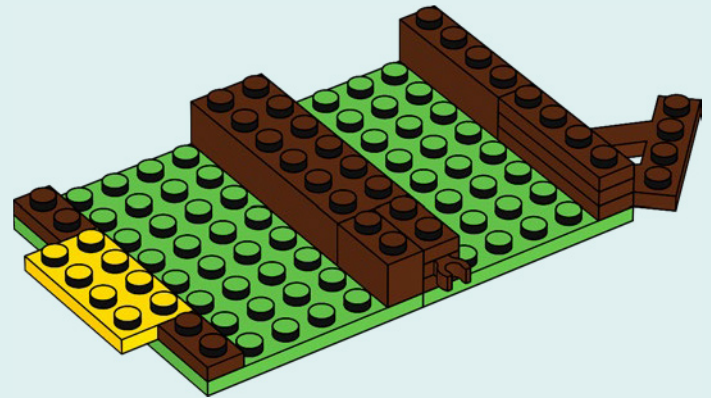

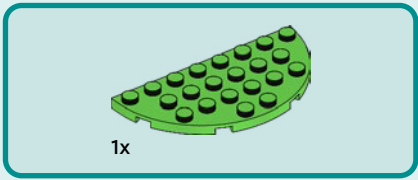

9

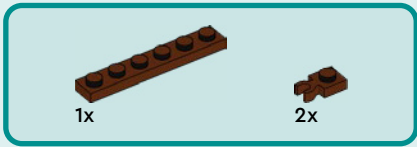
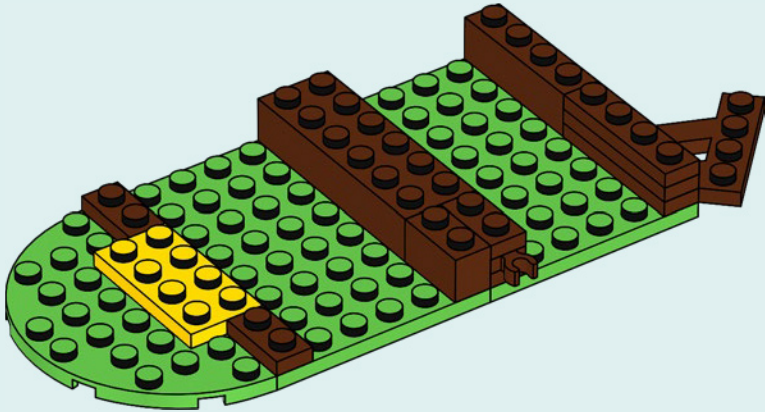

10

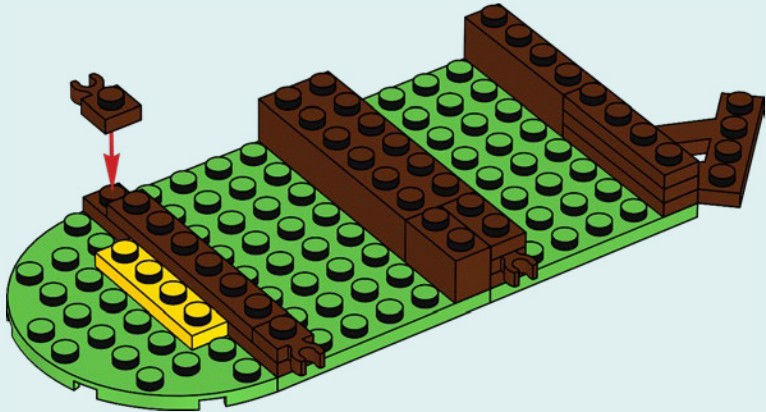

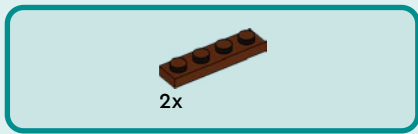

11

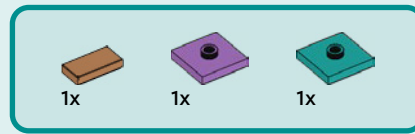
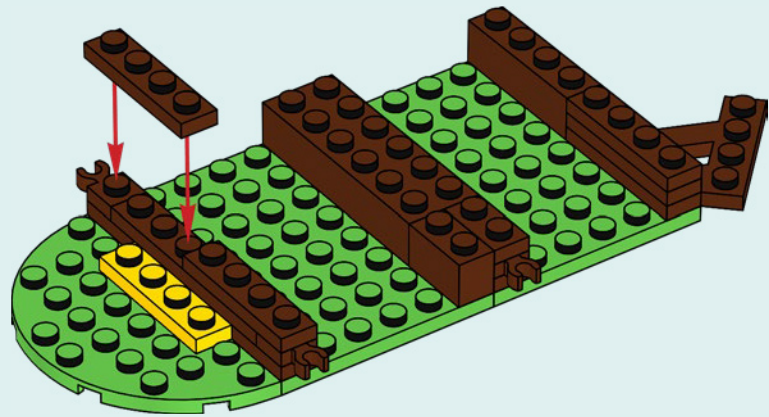

12

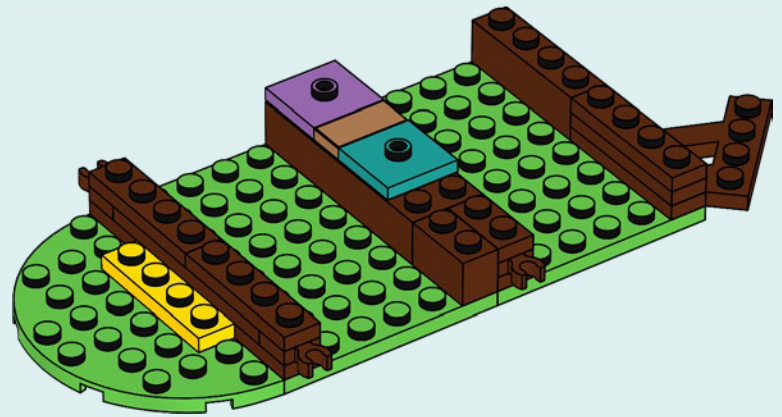

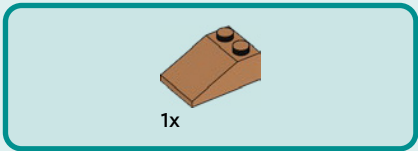

13

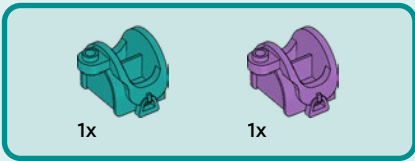
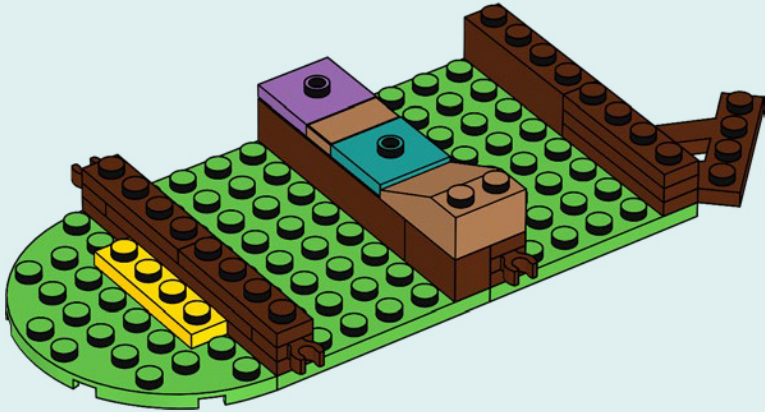

14

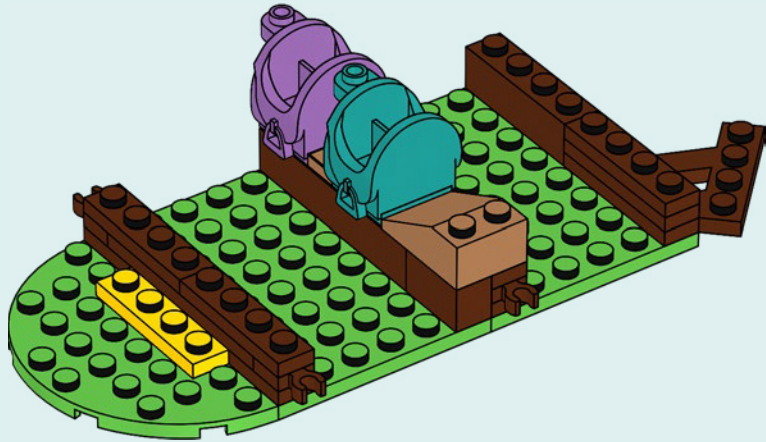

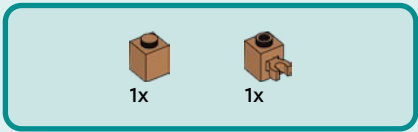

15

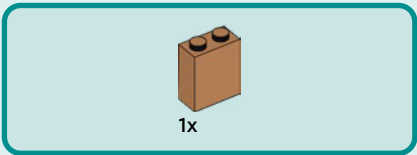
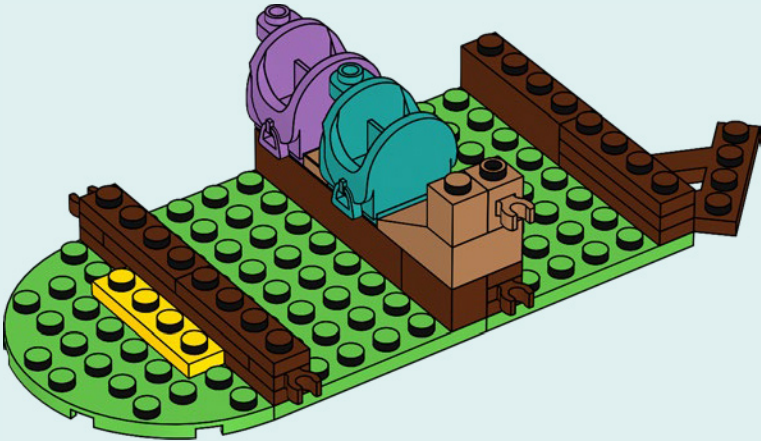

16

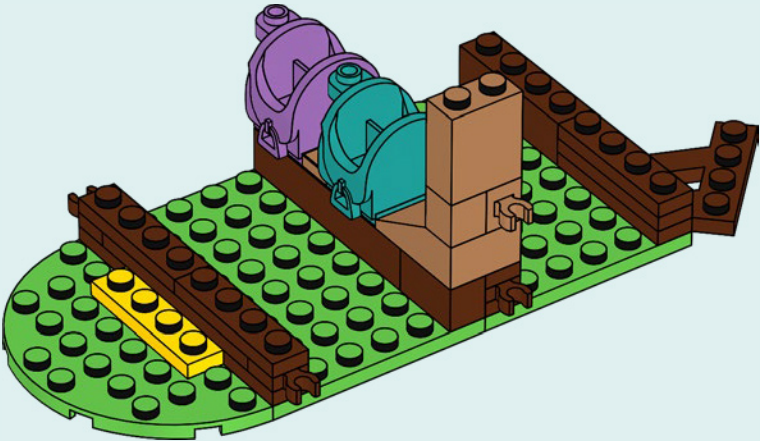

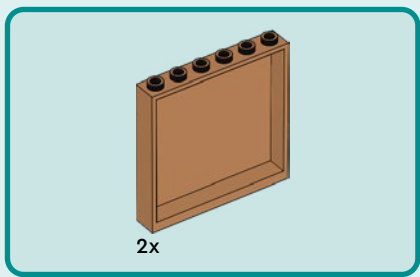

17

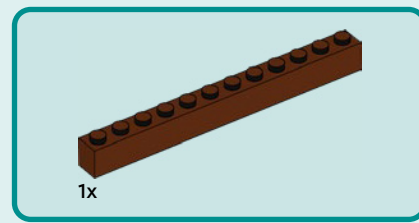
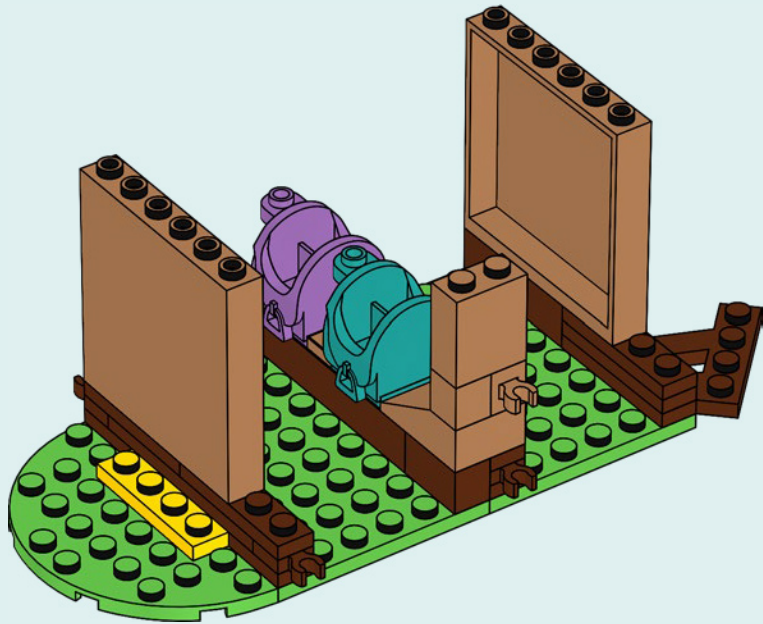

18

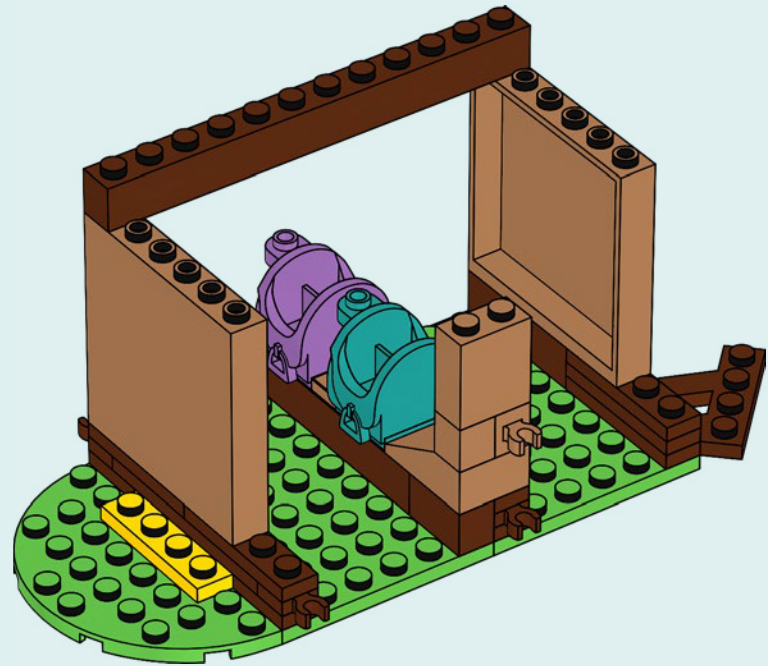

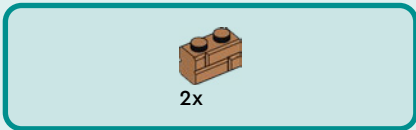

19

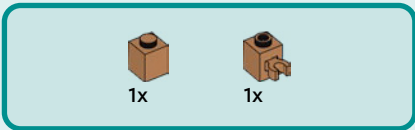
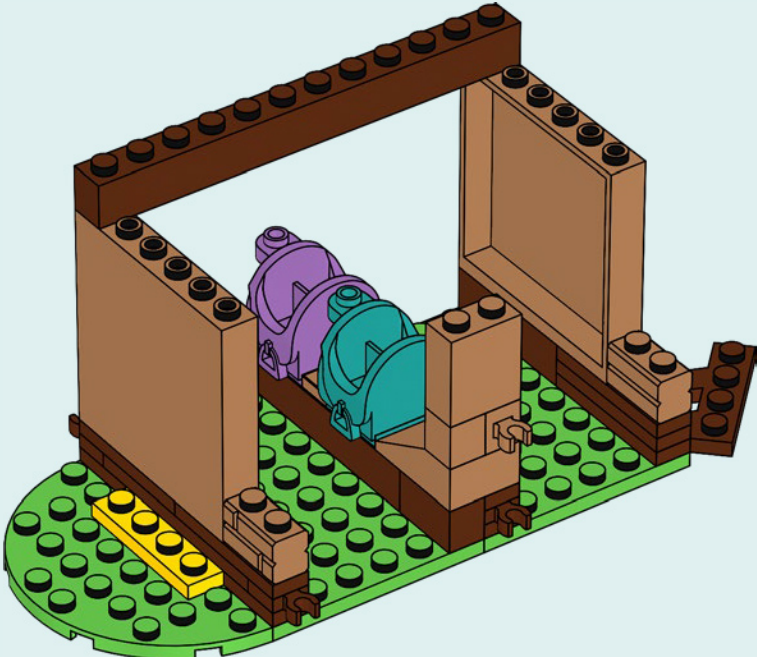

20

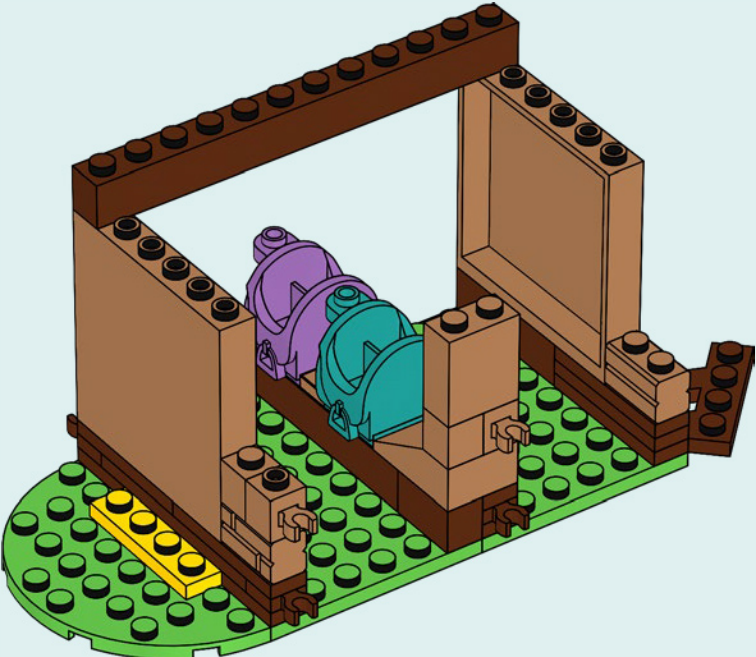

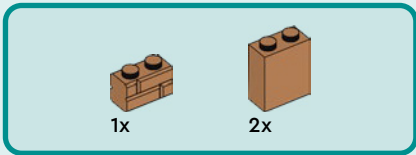

21

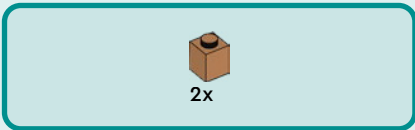
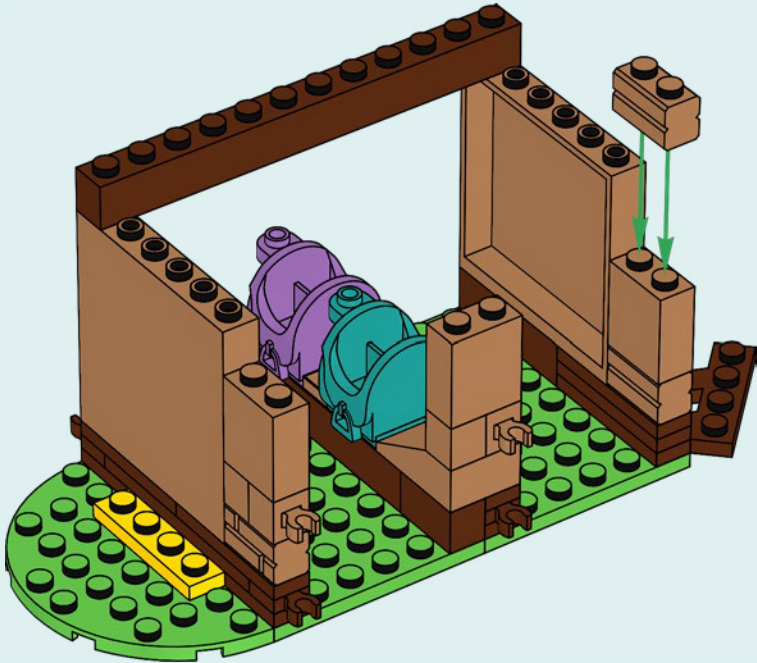

22

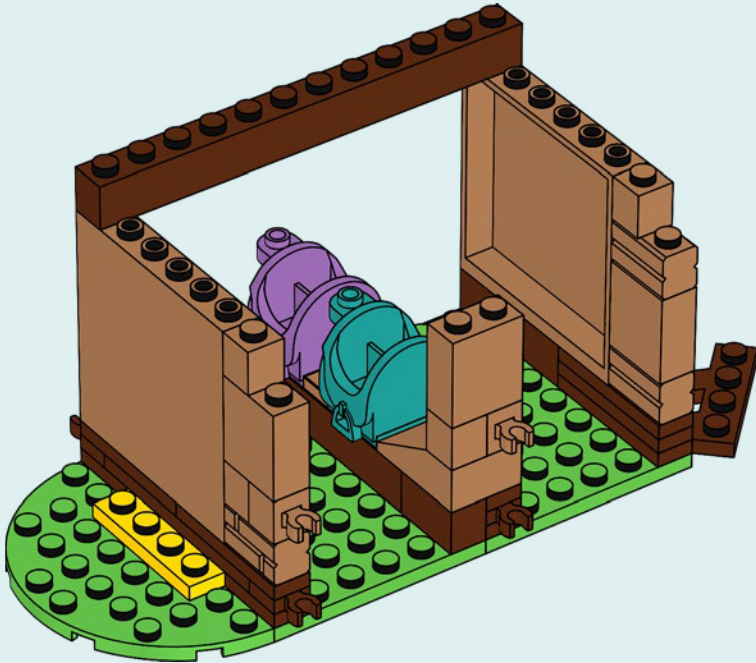

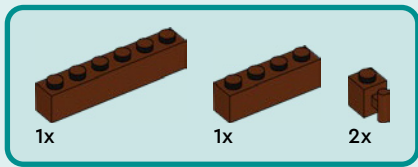

23

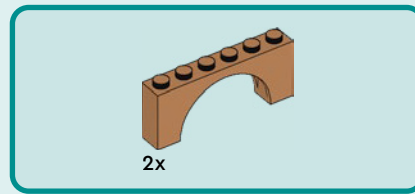
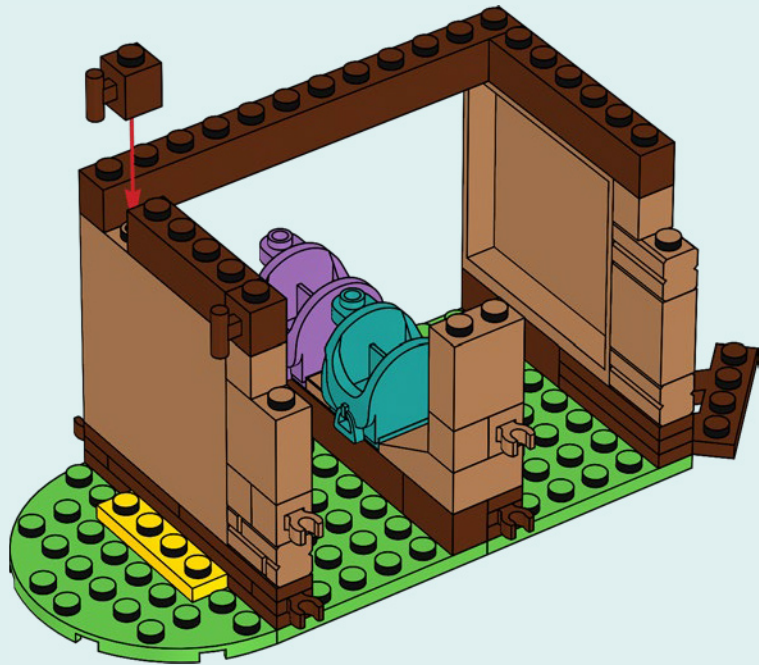

24

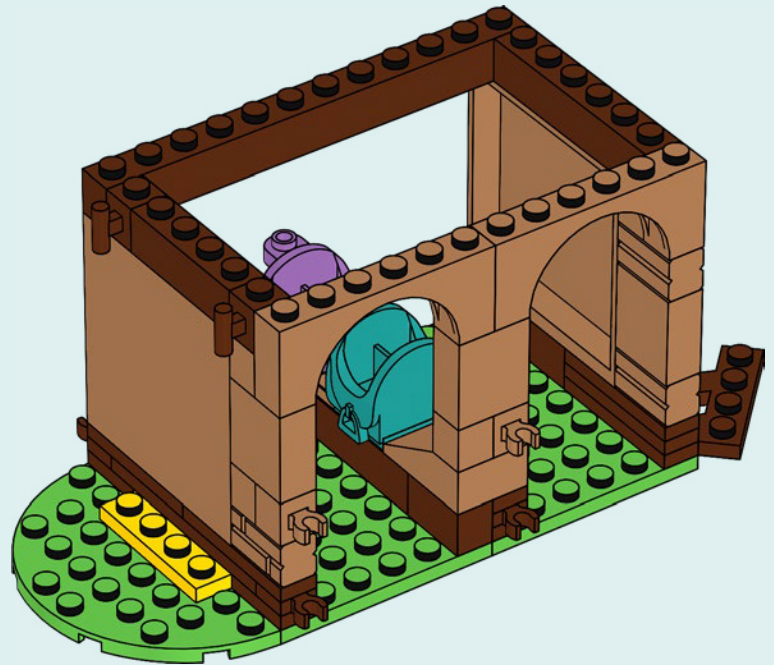

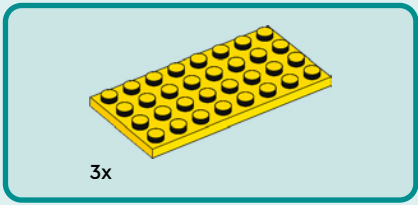

25

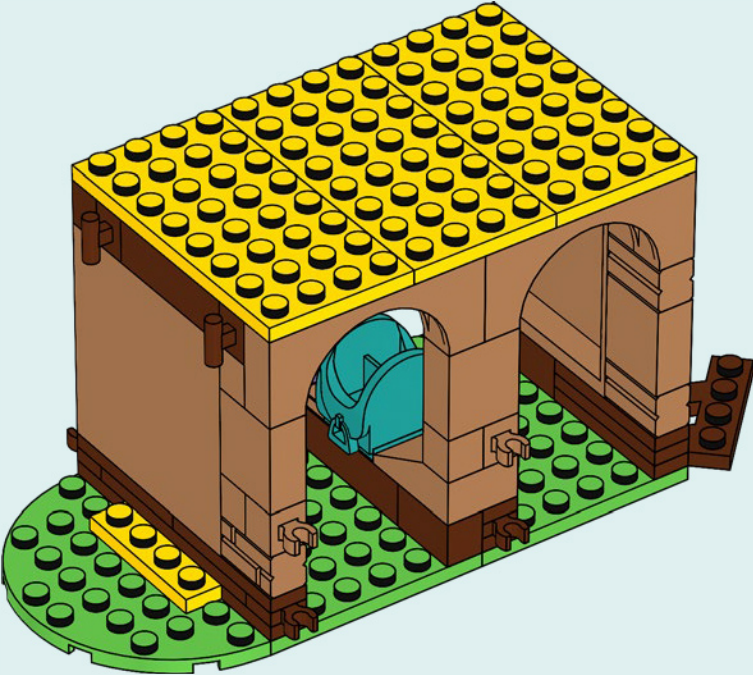

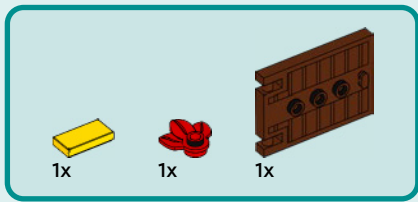

26

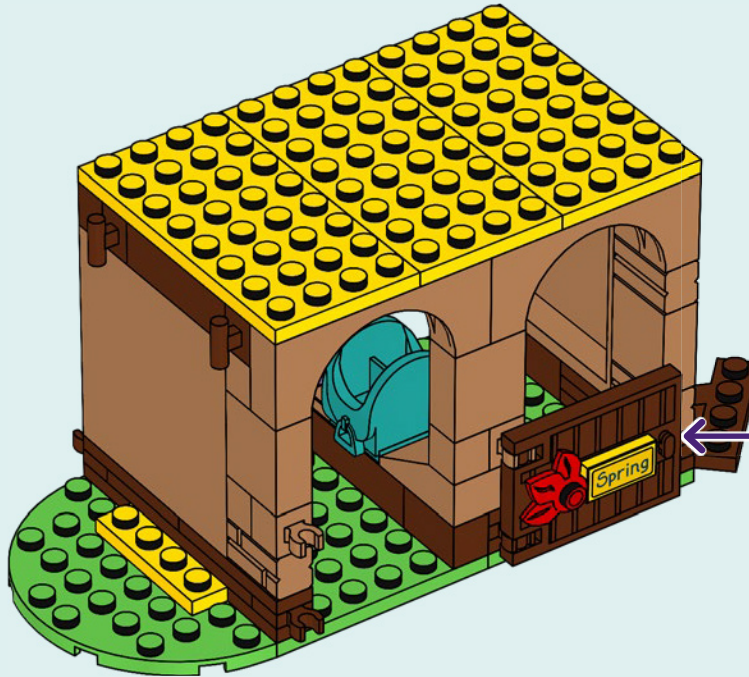
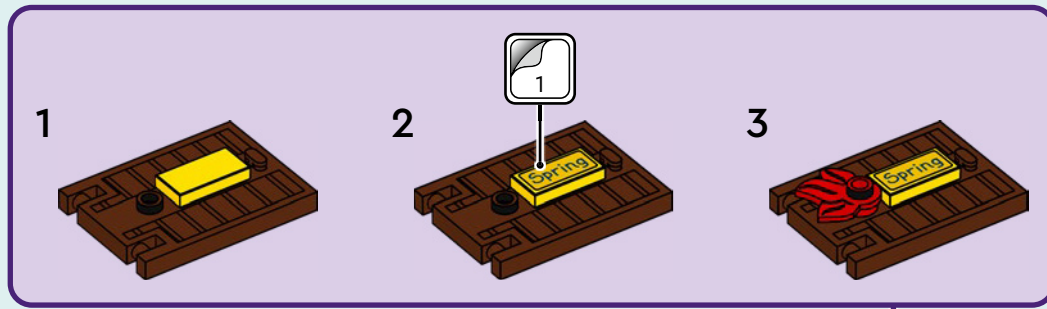

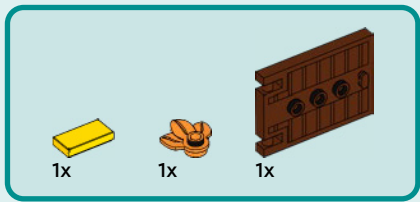

27

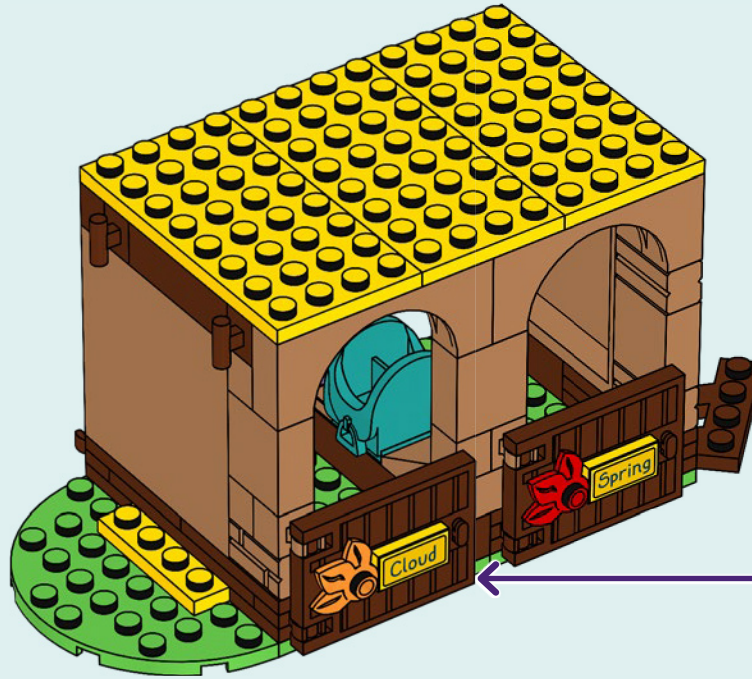
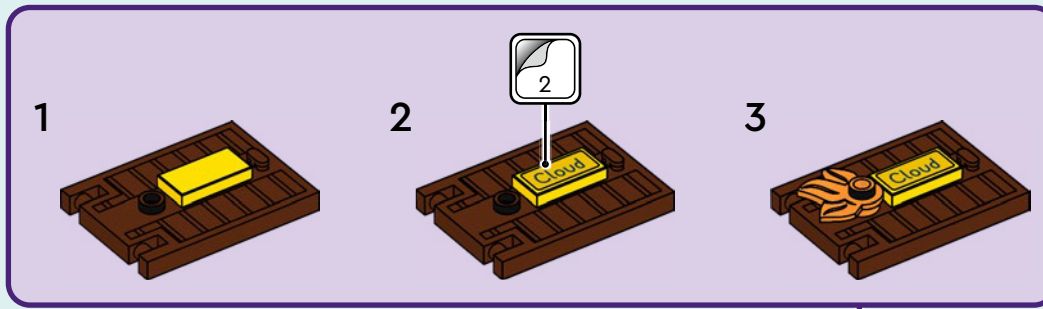



28

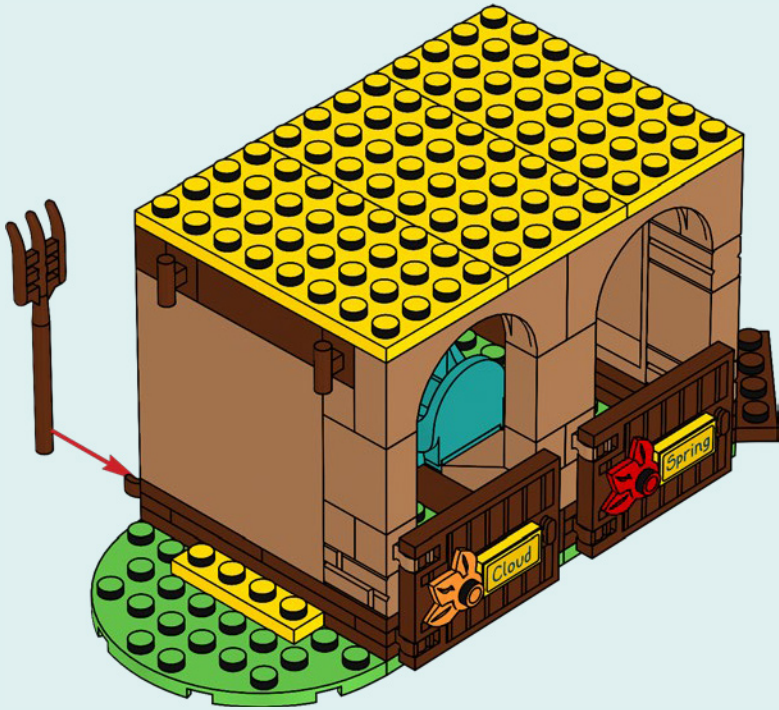

29

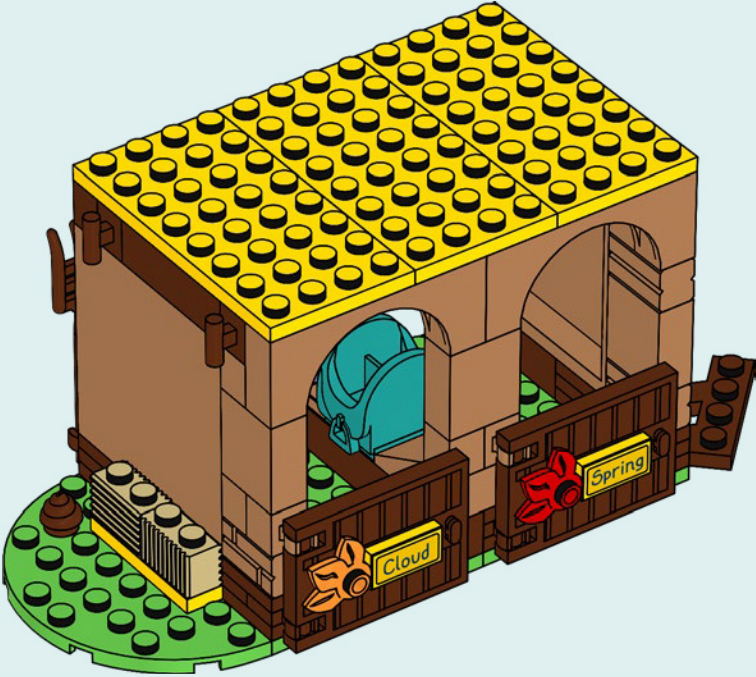



1x

30

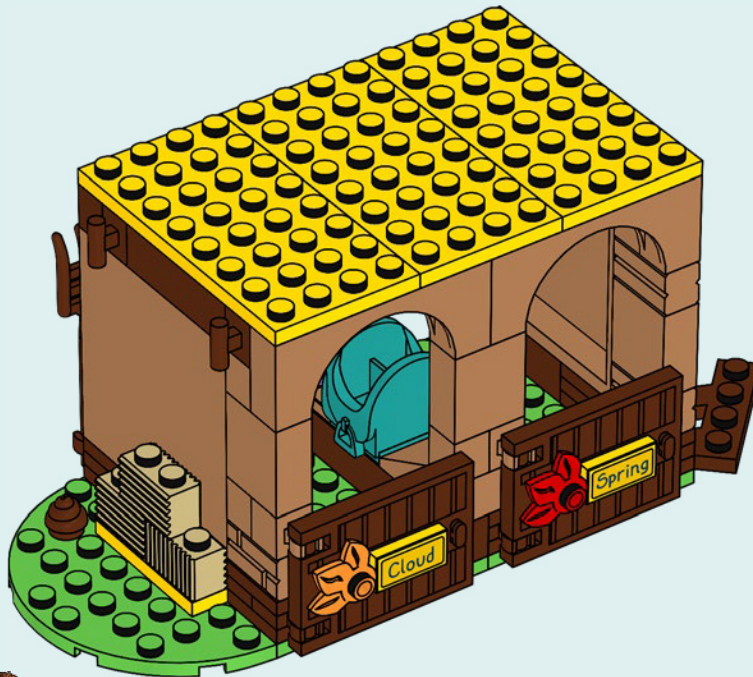

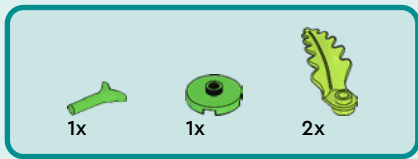

31

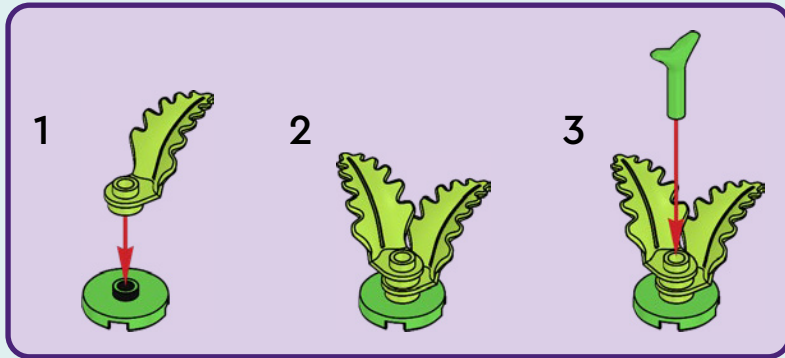

32

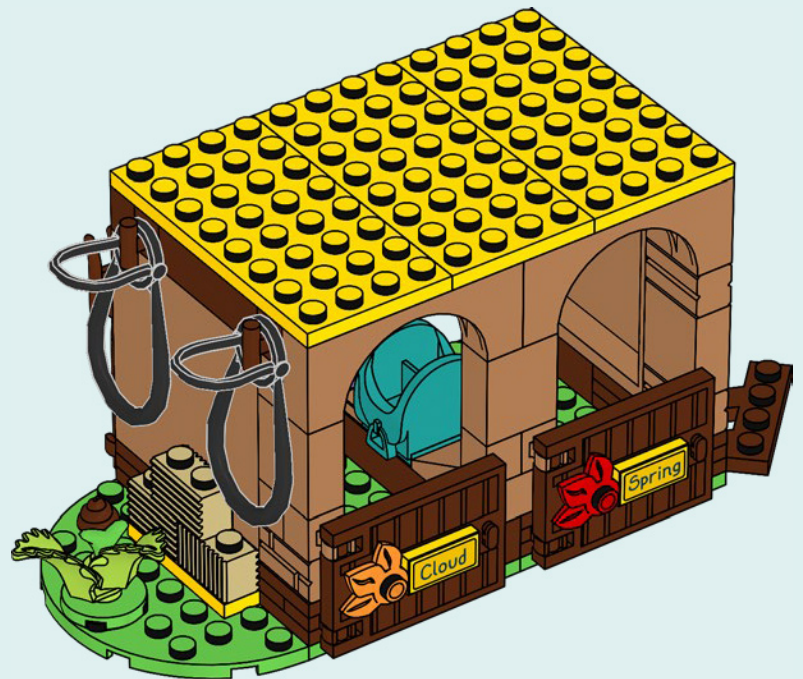

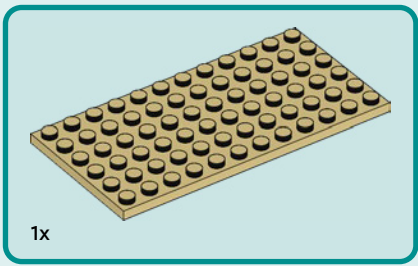

33







1x

34





35

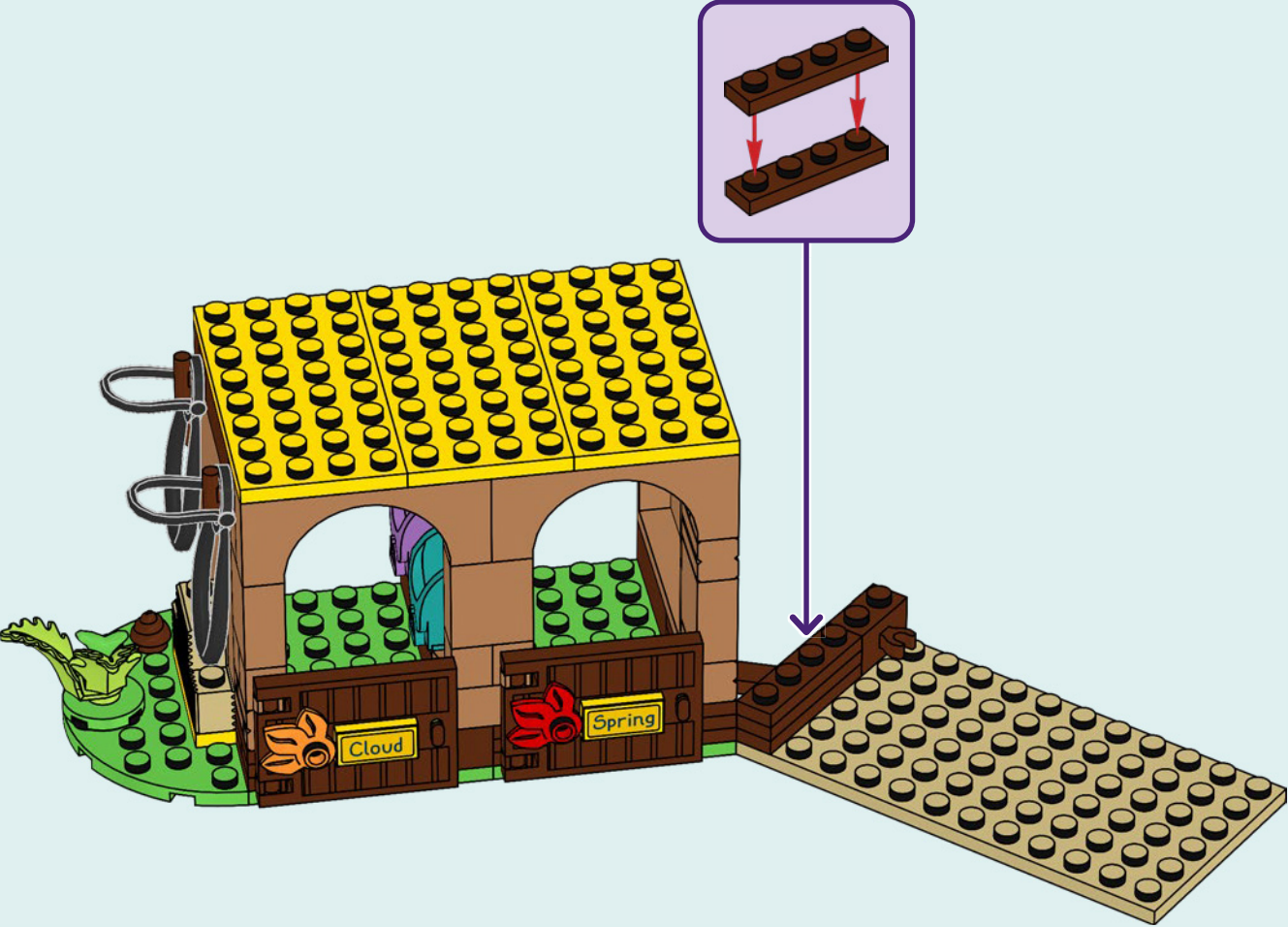

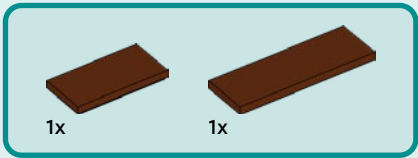

36



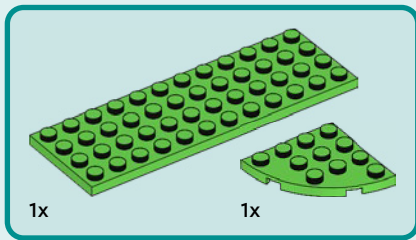

37

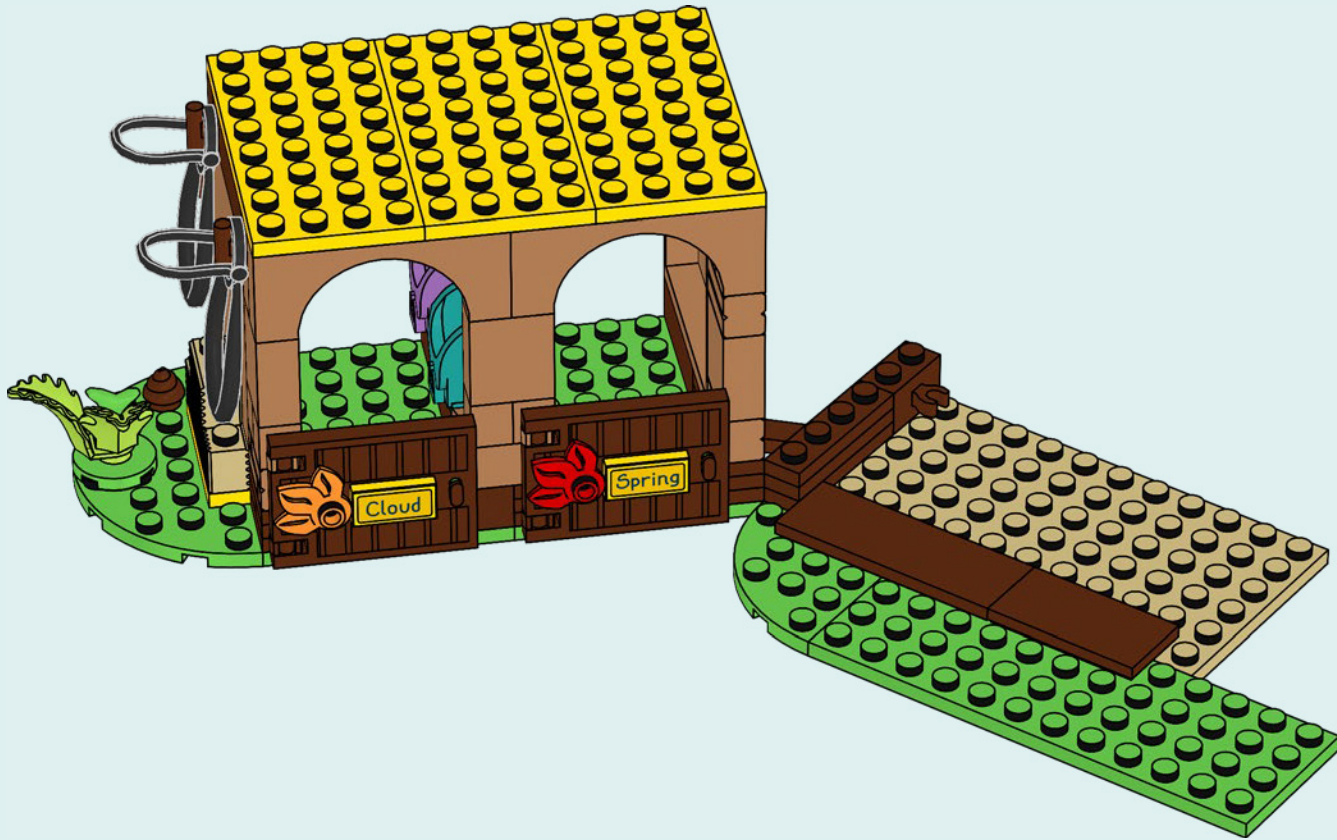

2x

38

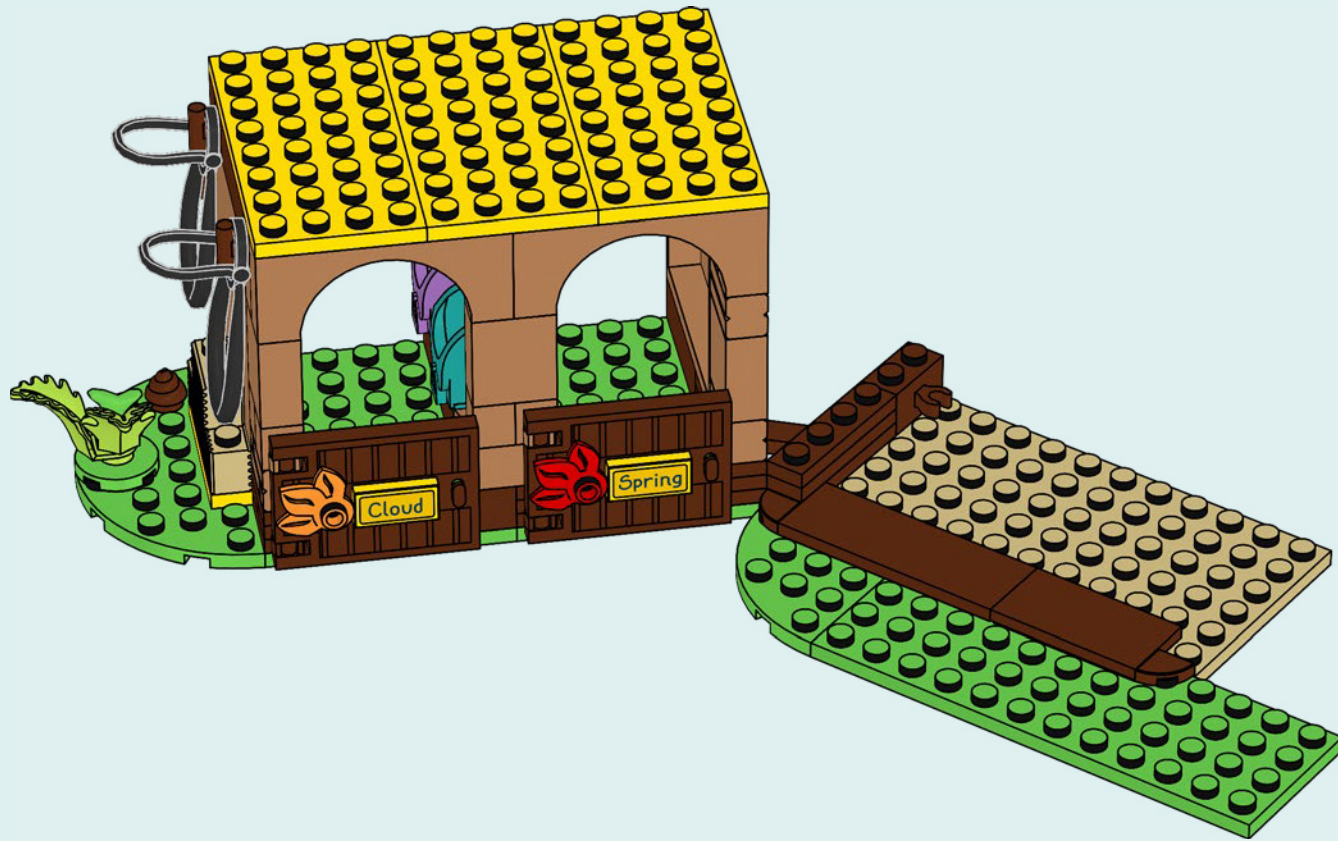



39

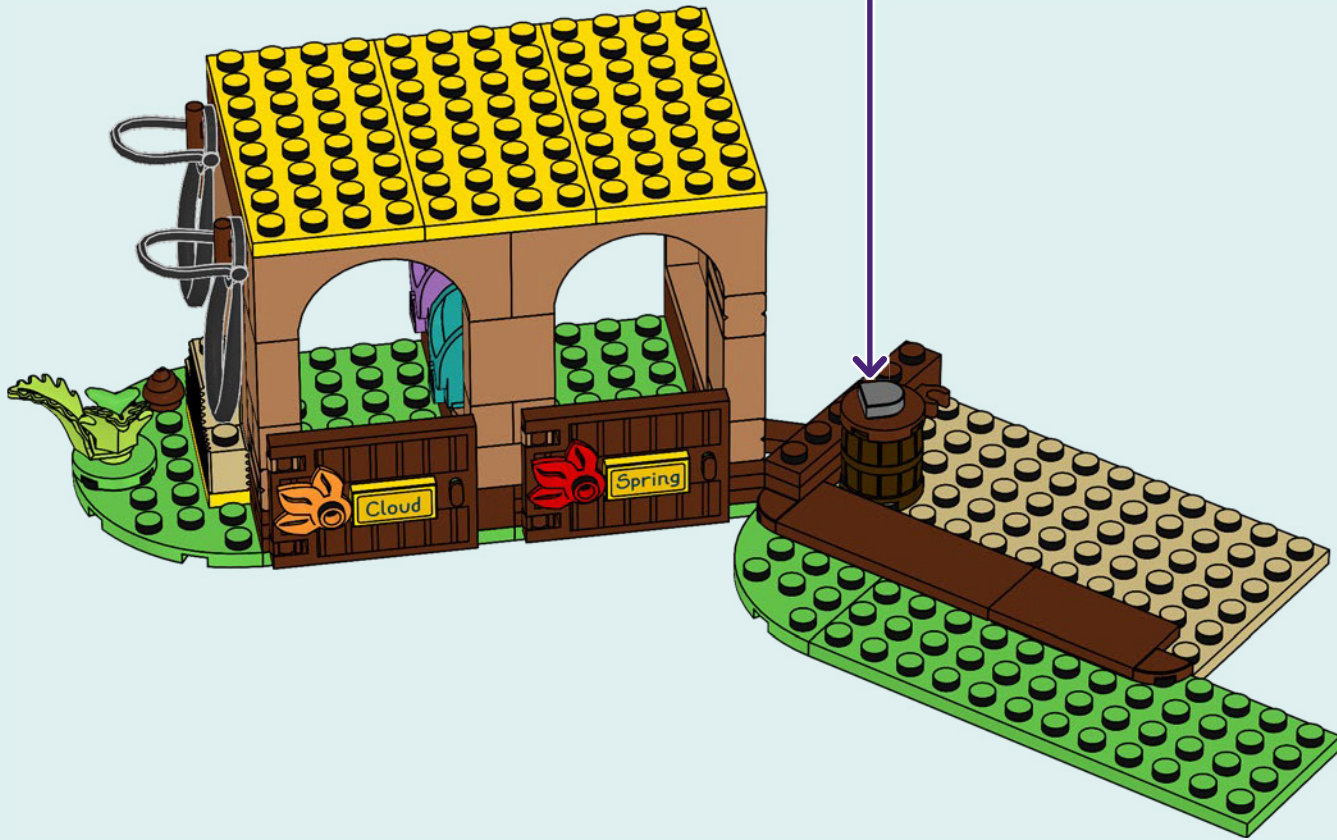
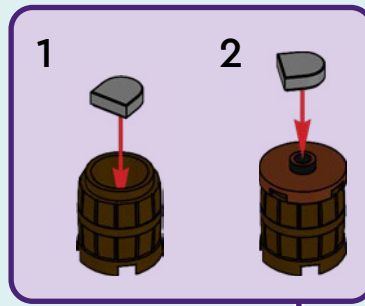

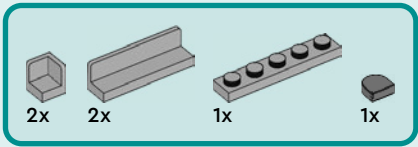

40

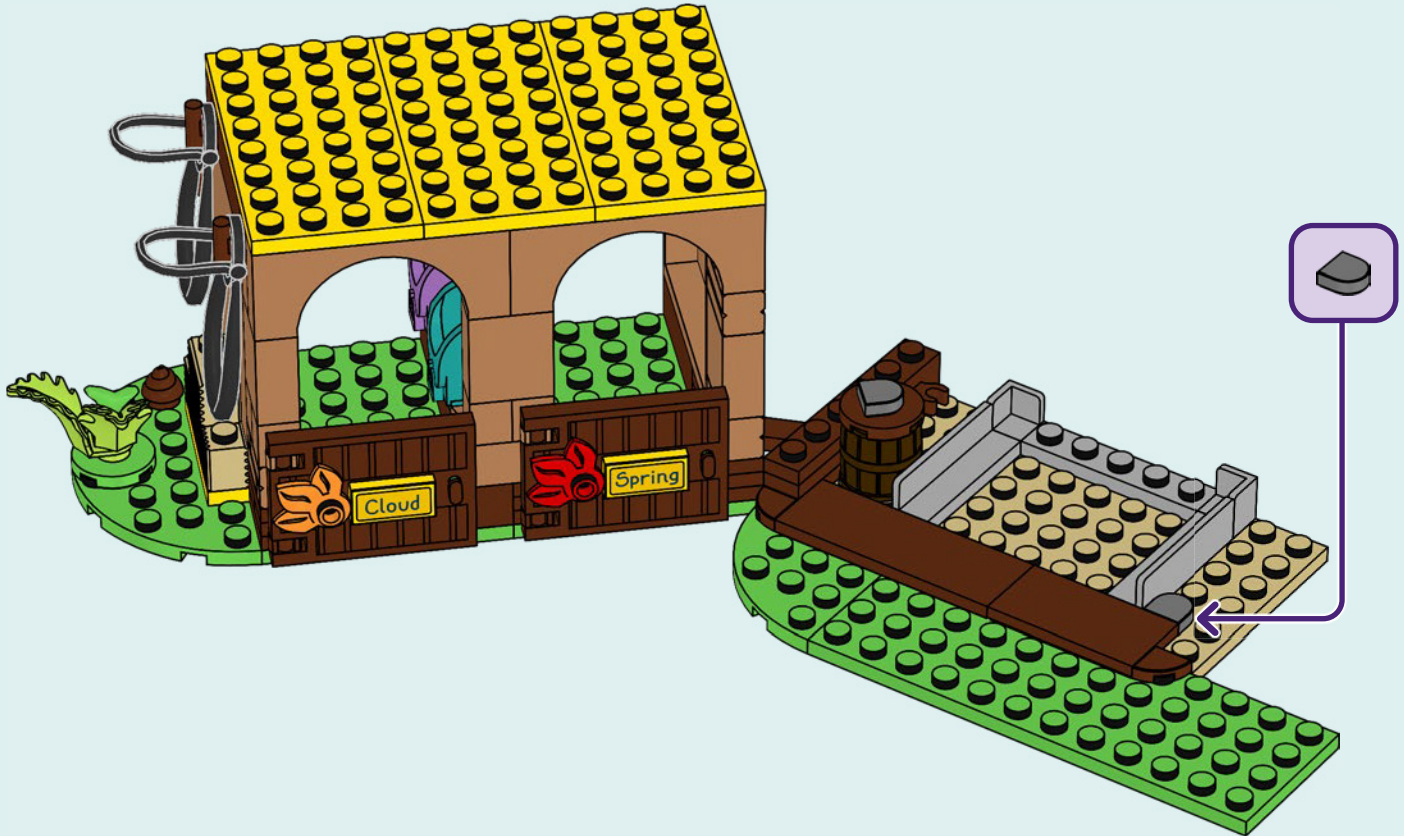

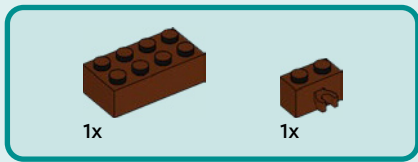

41

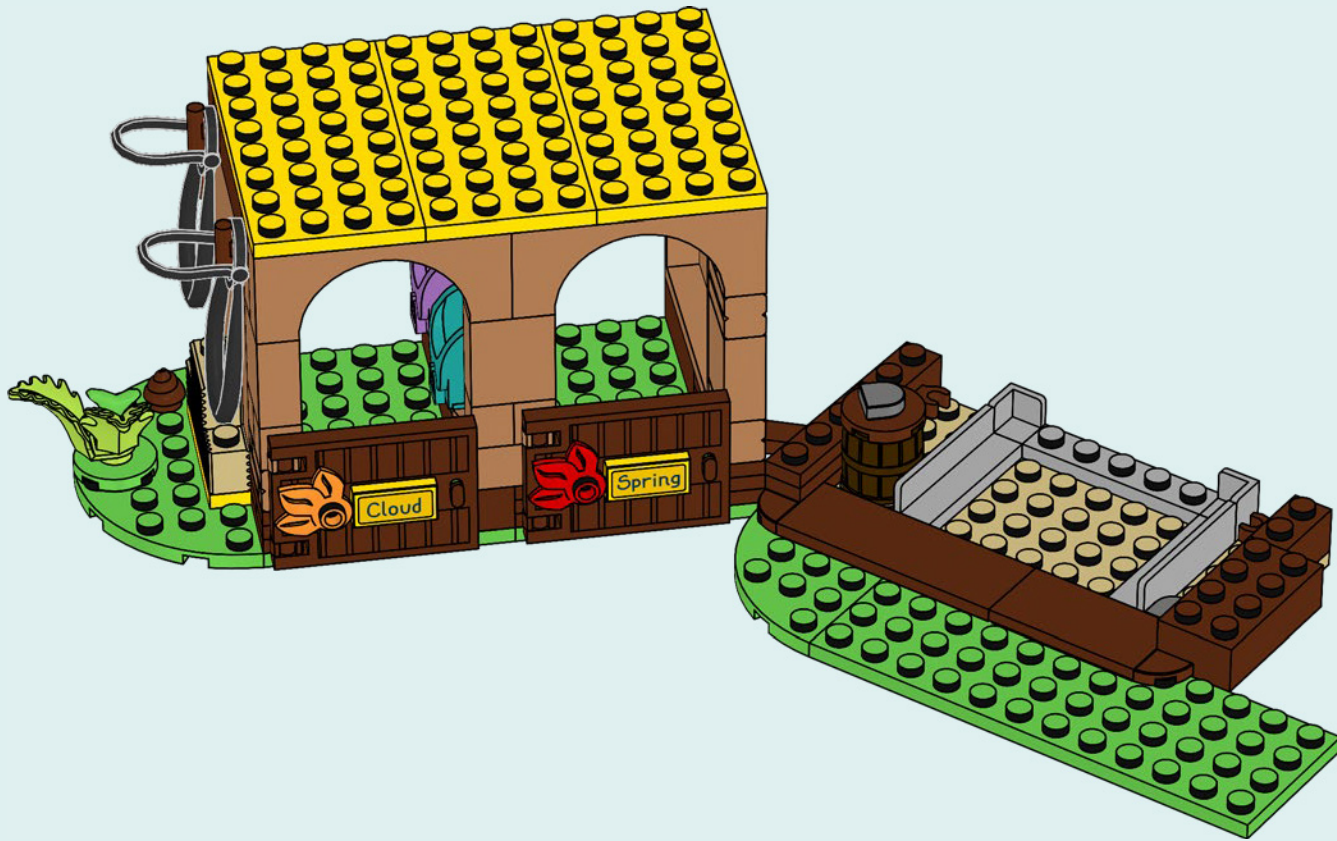

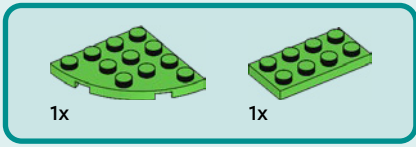

42

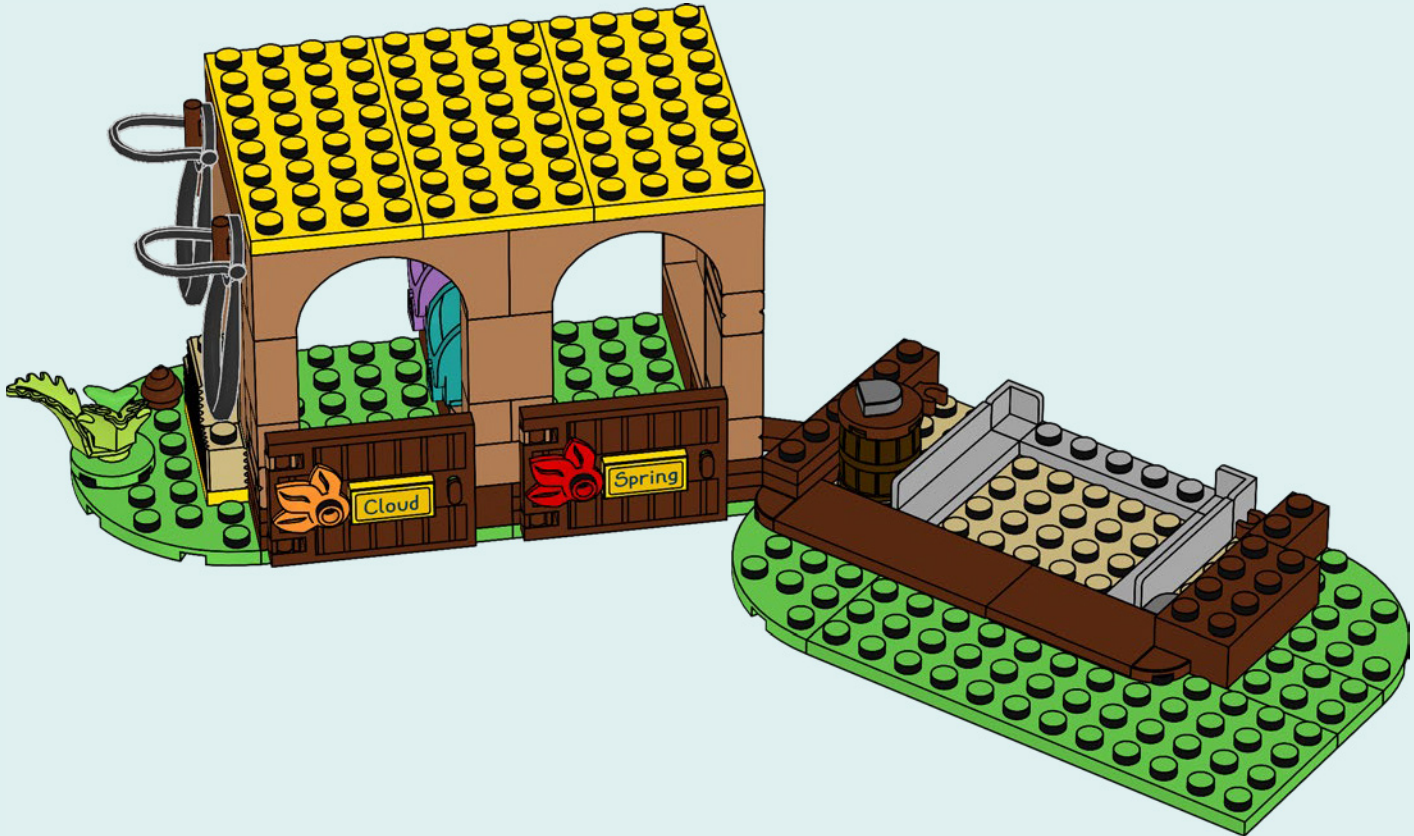

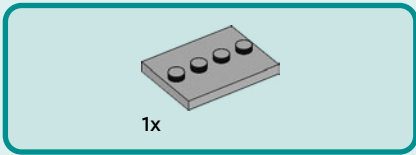

43

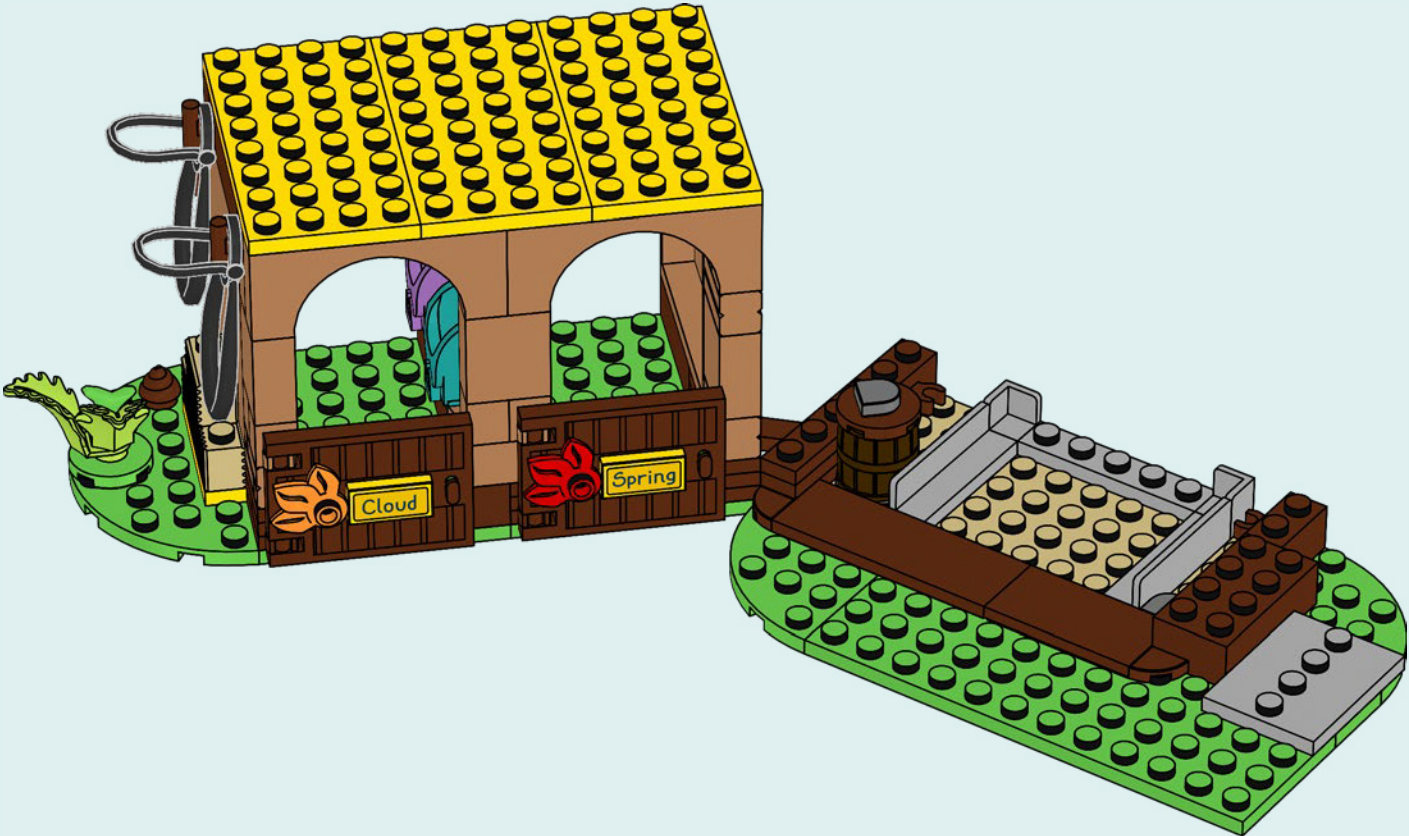

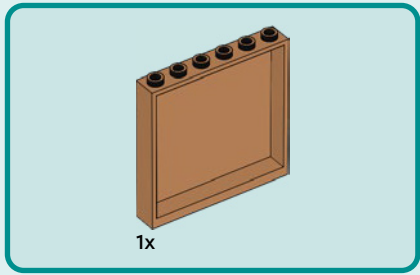

44

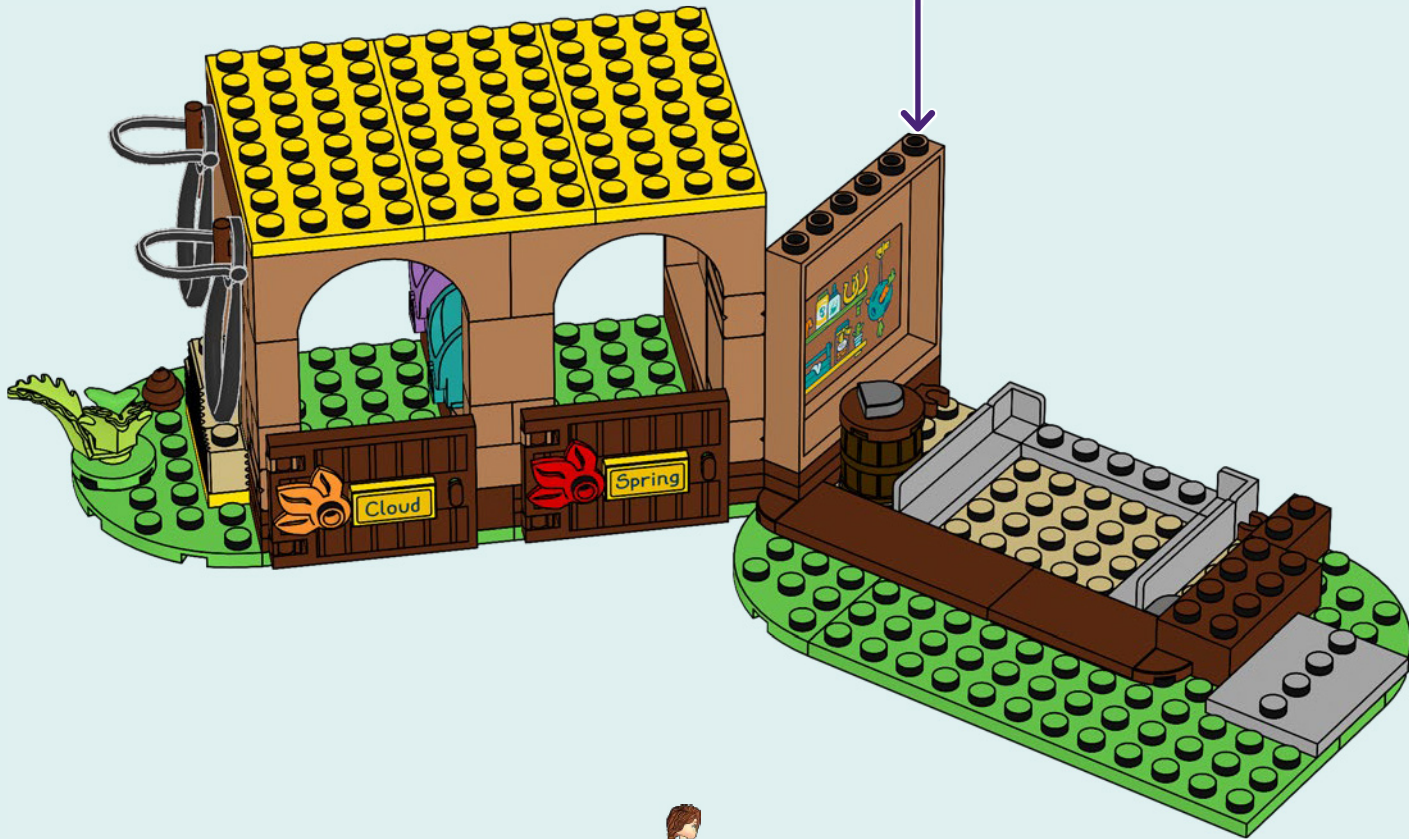
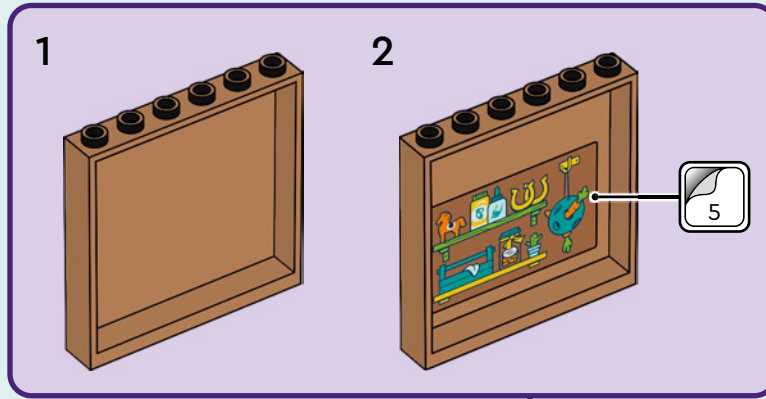

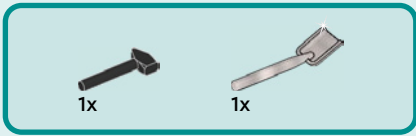

45

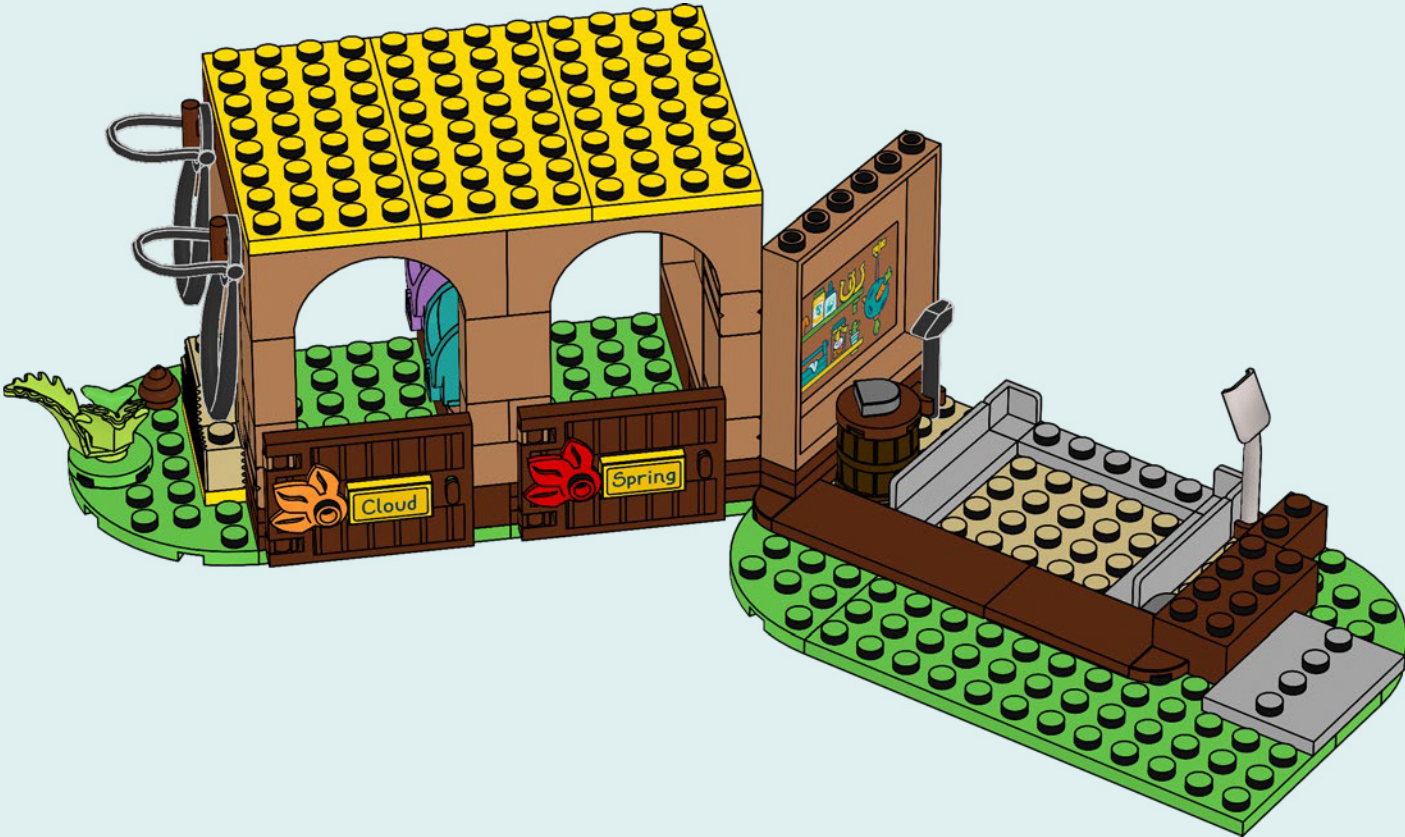

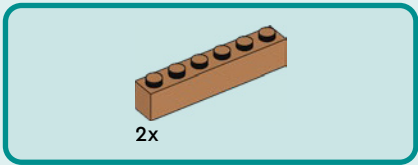

46



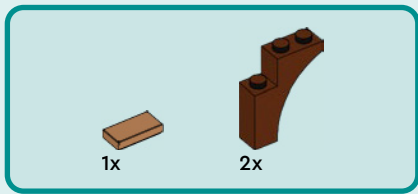

47

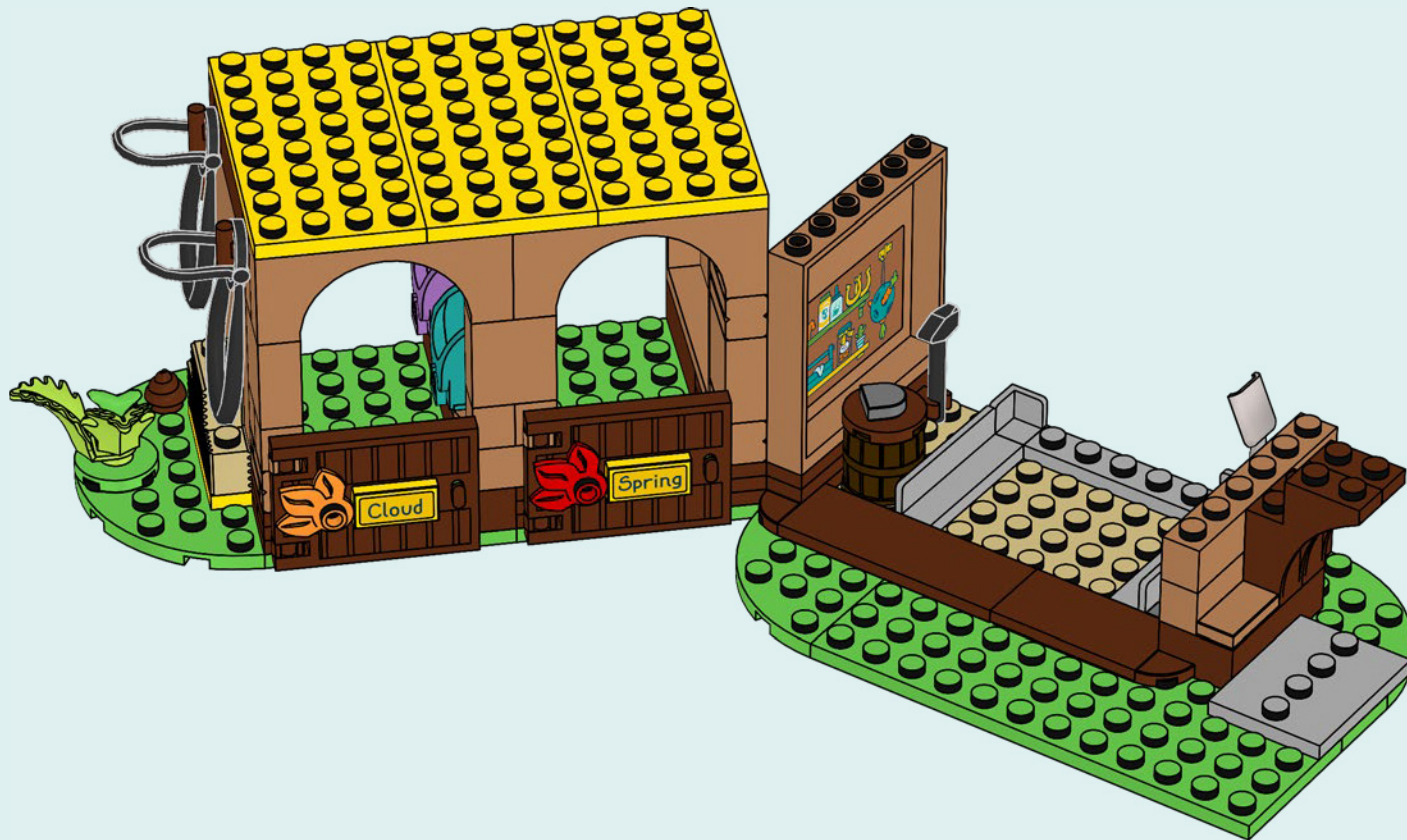



1x



2x

48

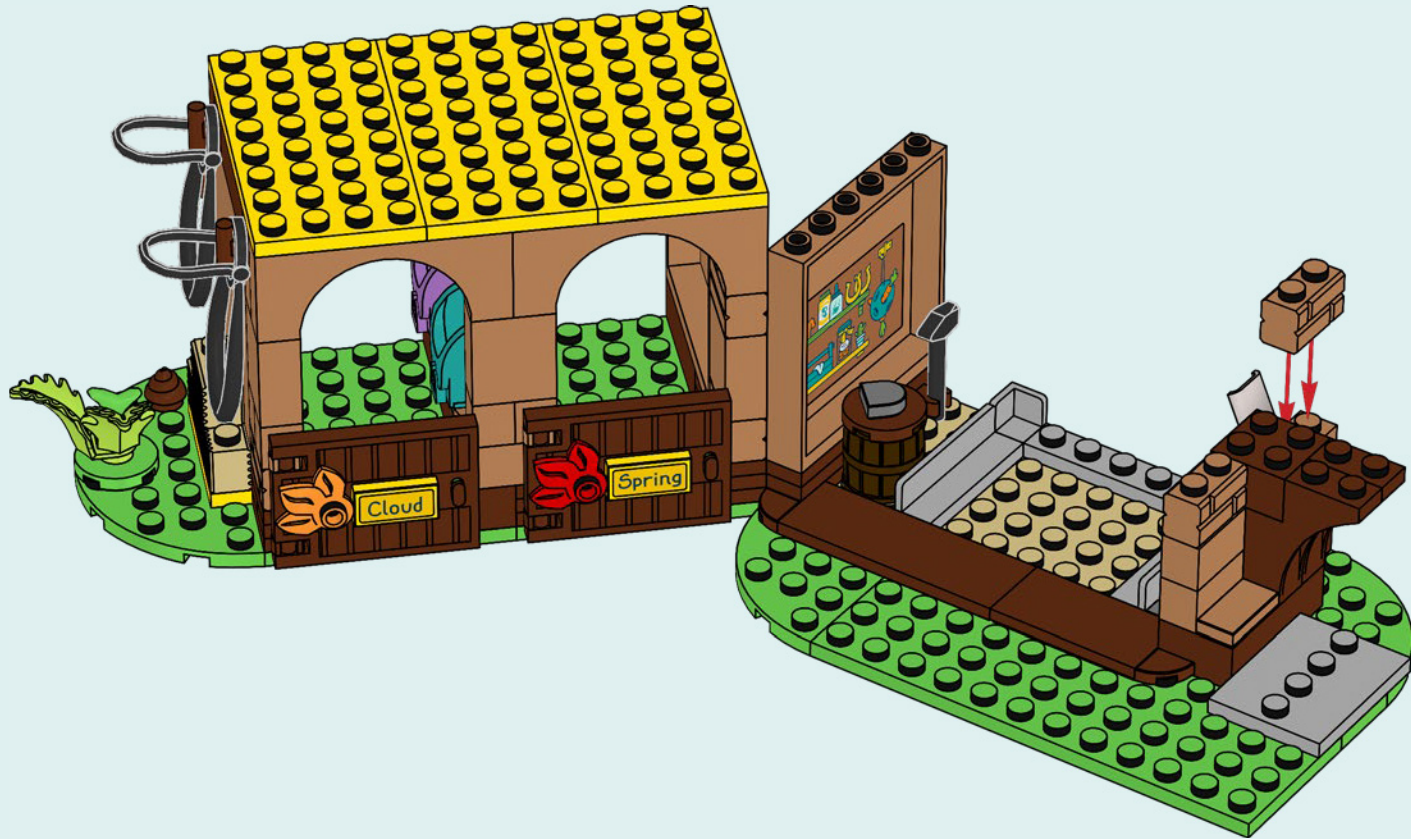

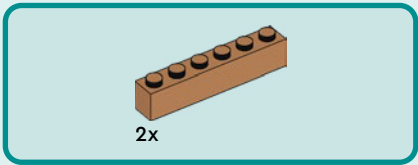

49

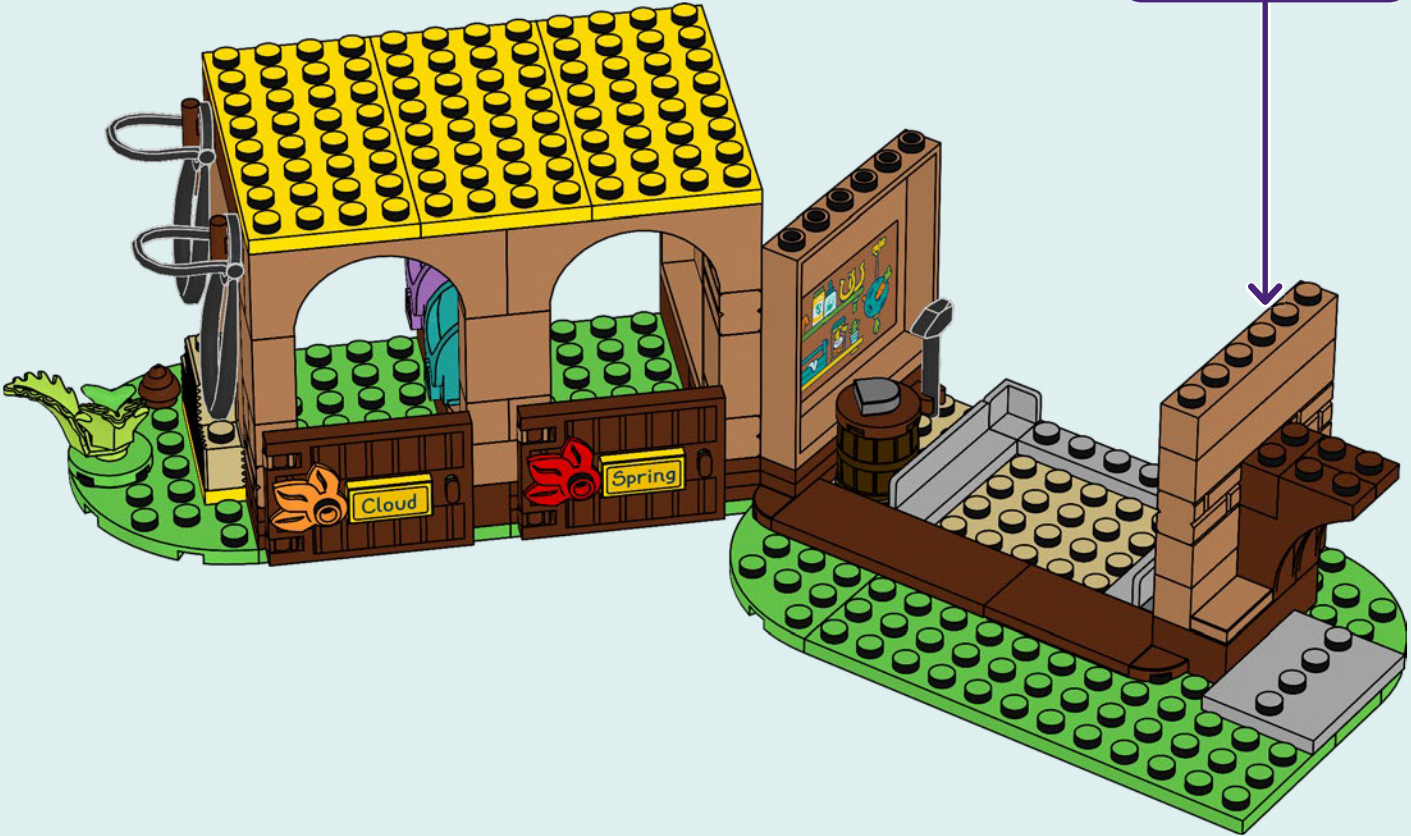
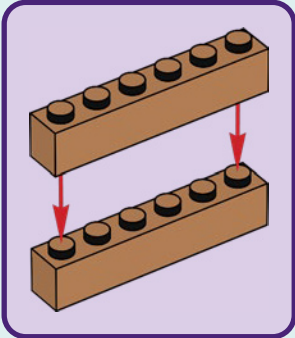

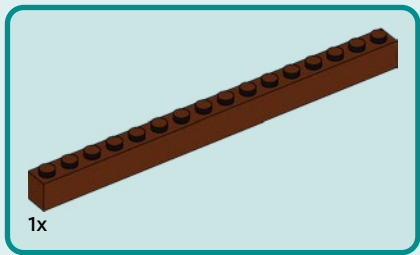

50

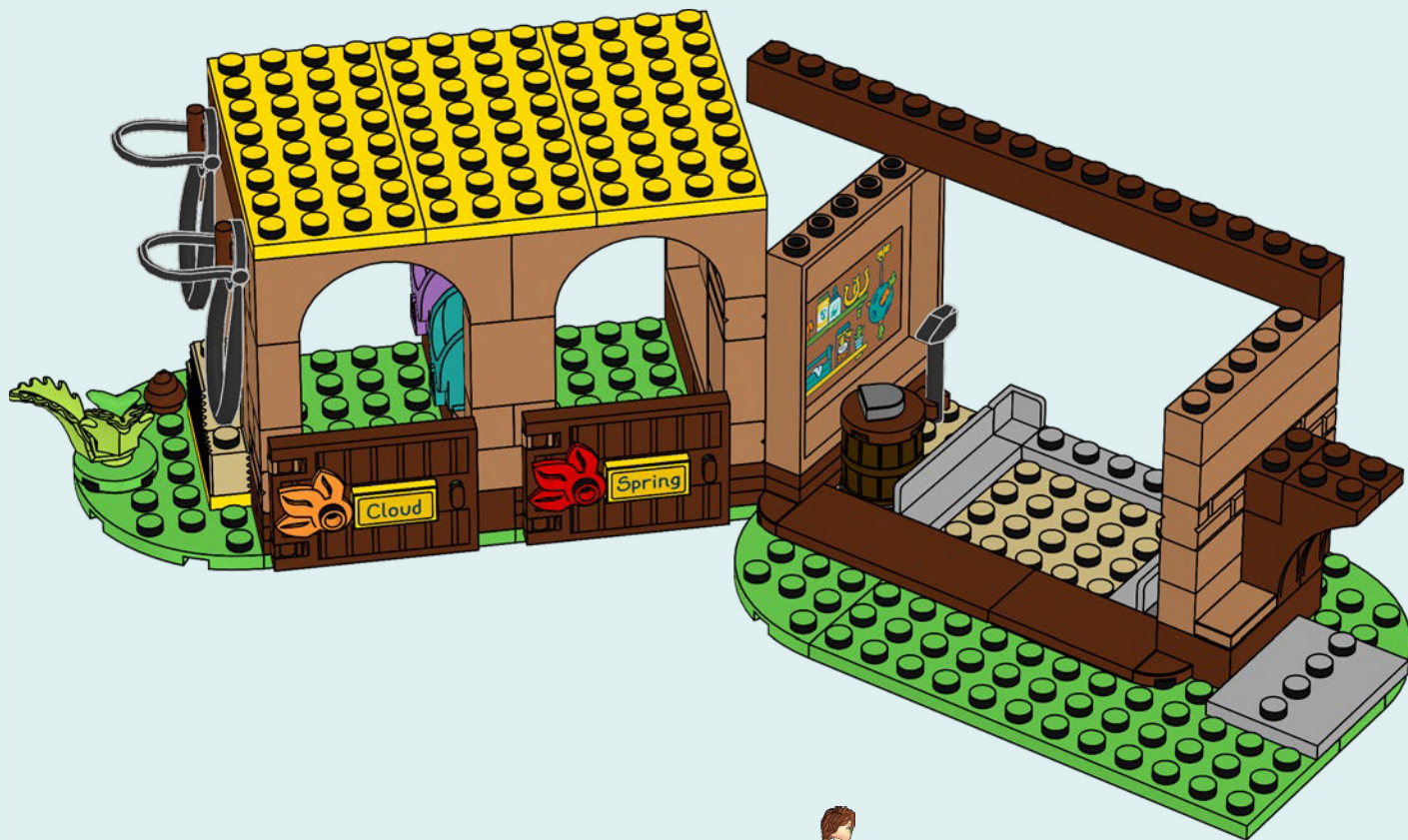

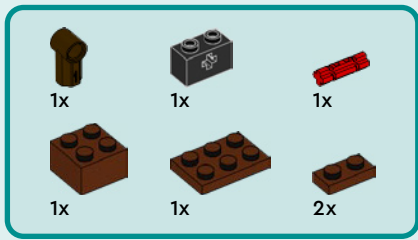

51

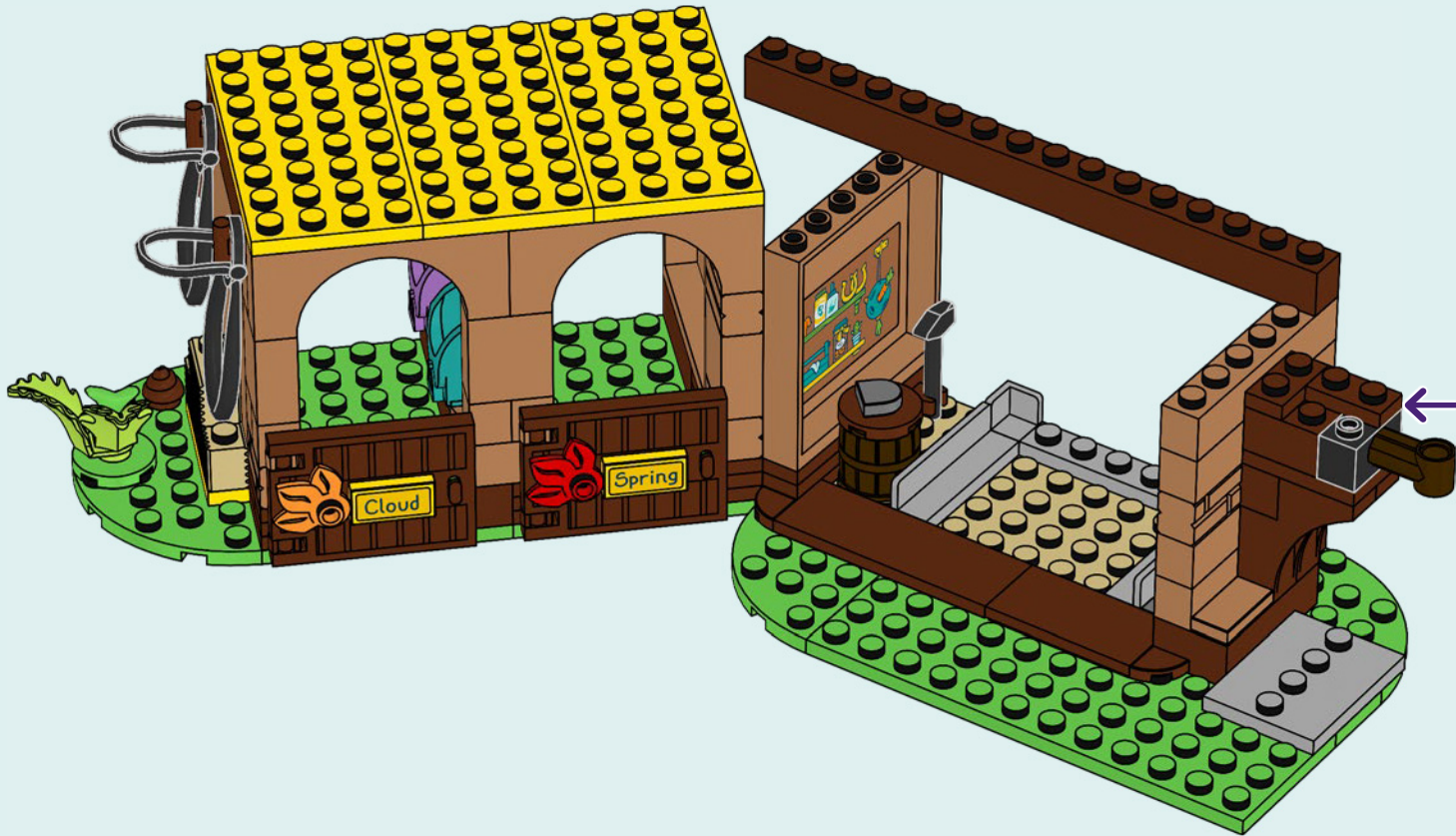
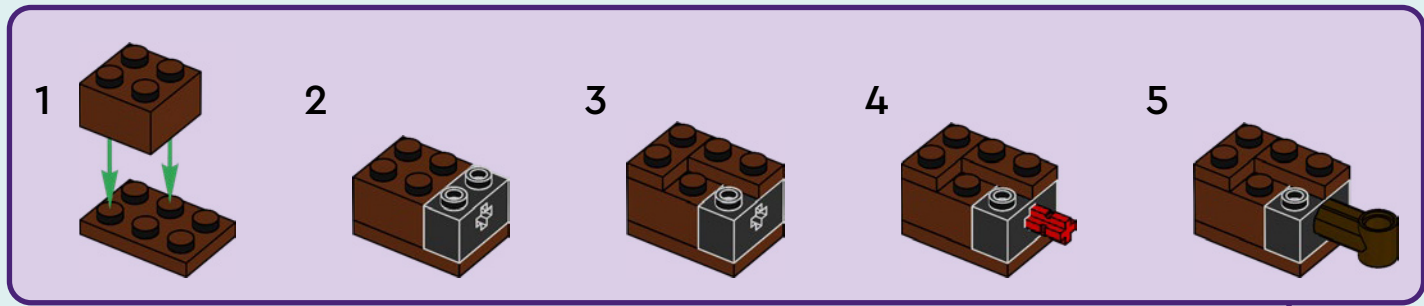

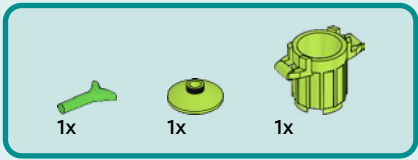

52

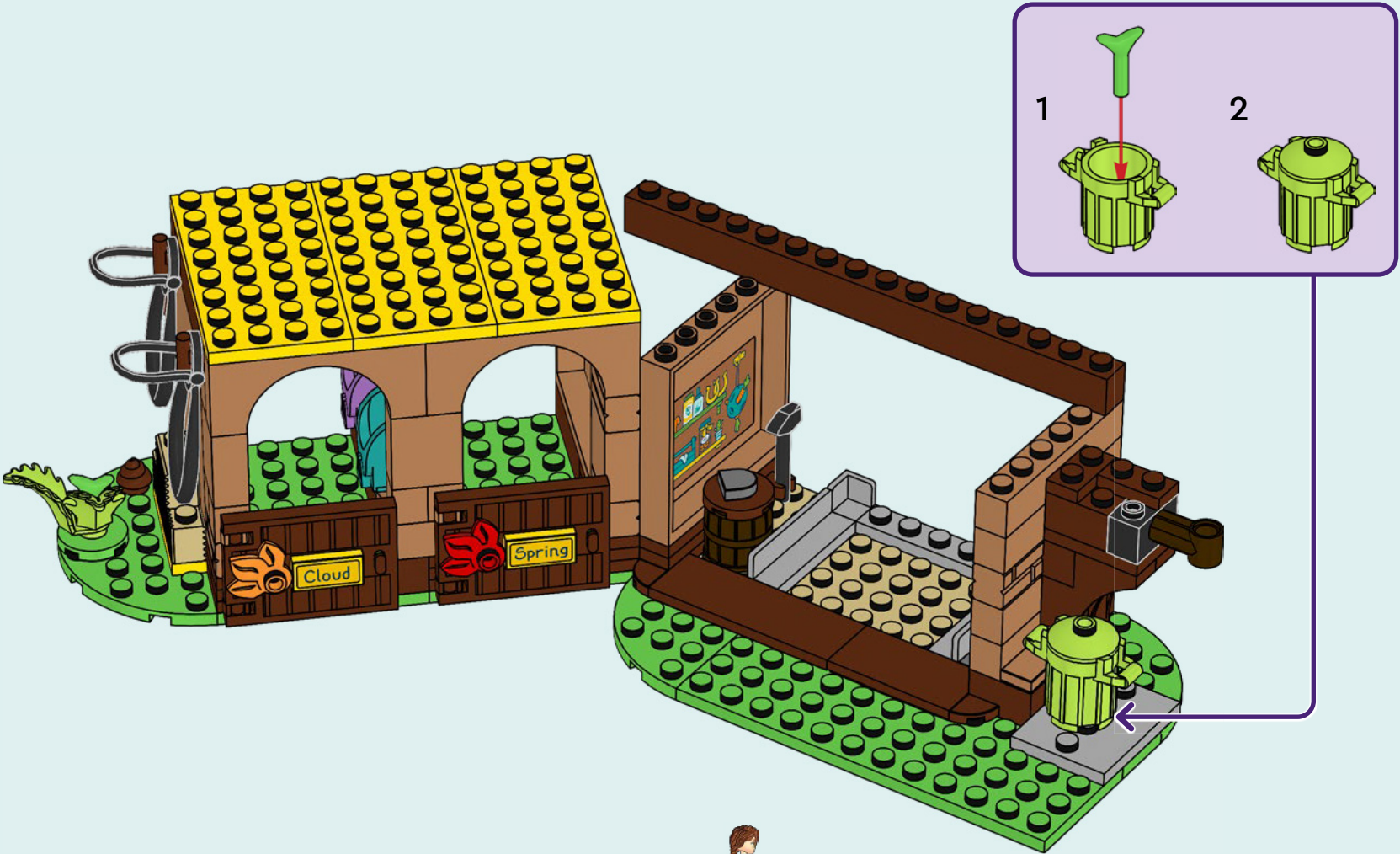

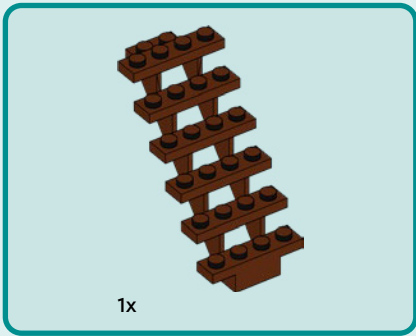

53

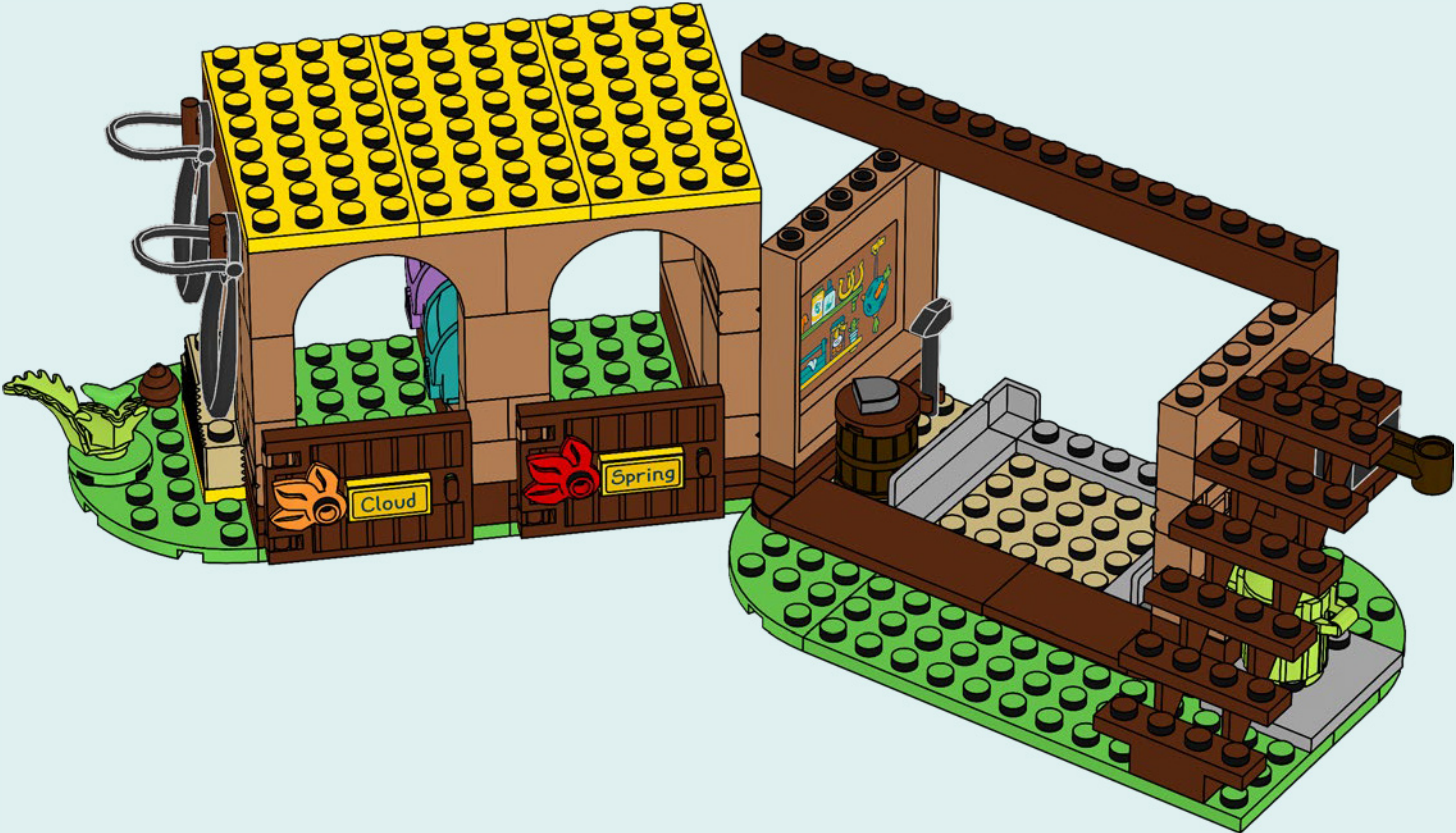

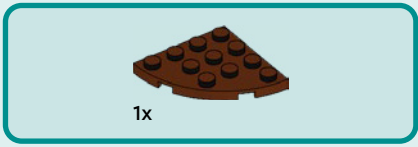

54



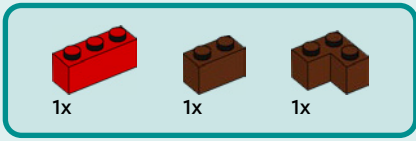

55

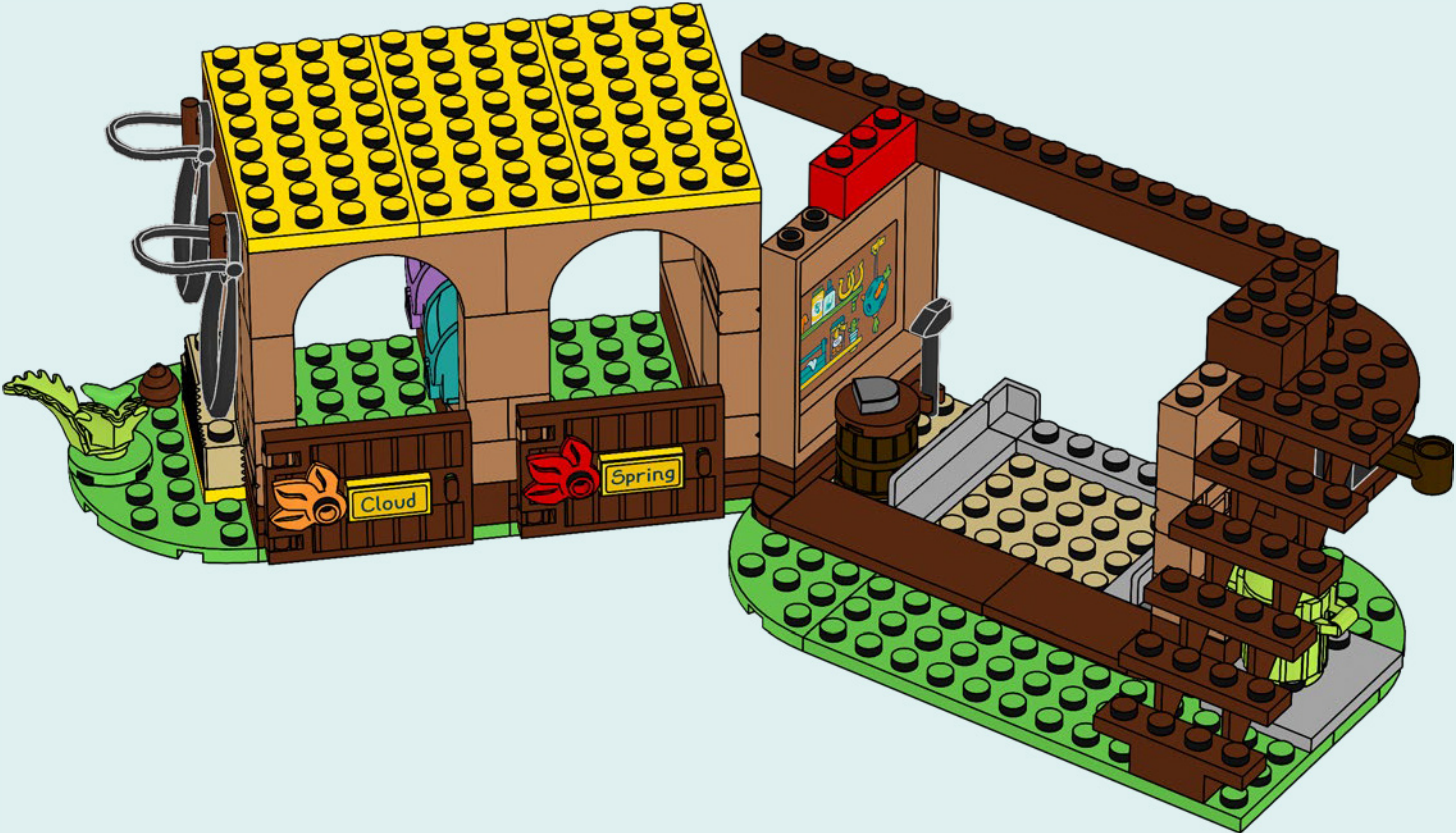

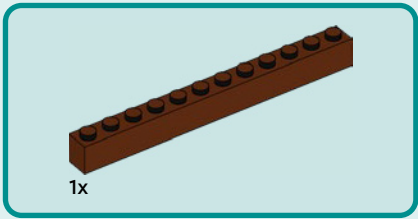

56

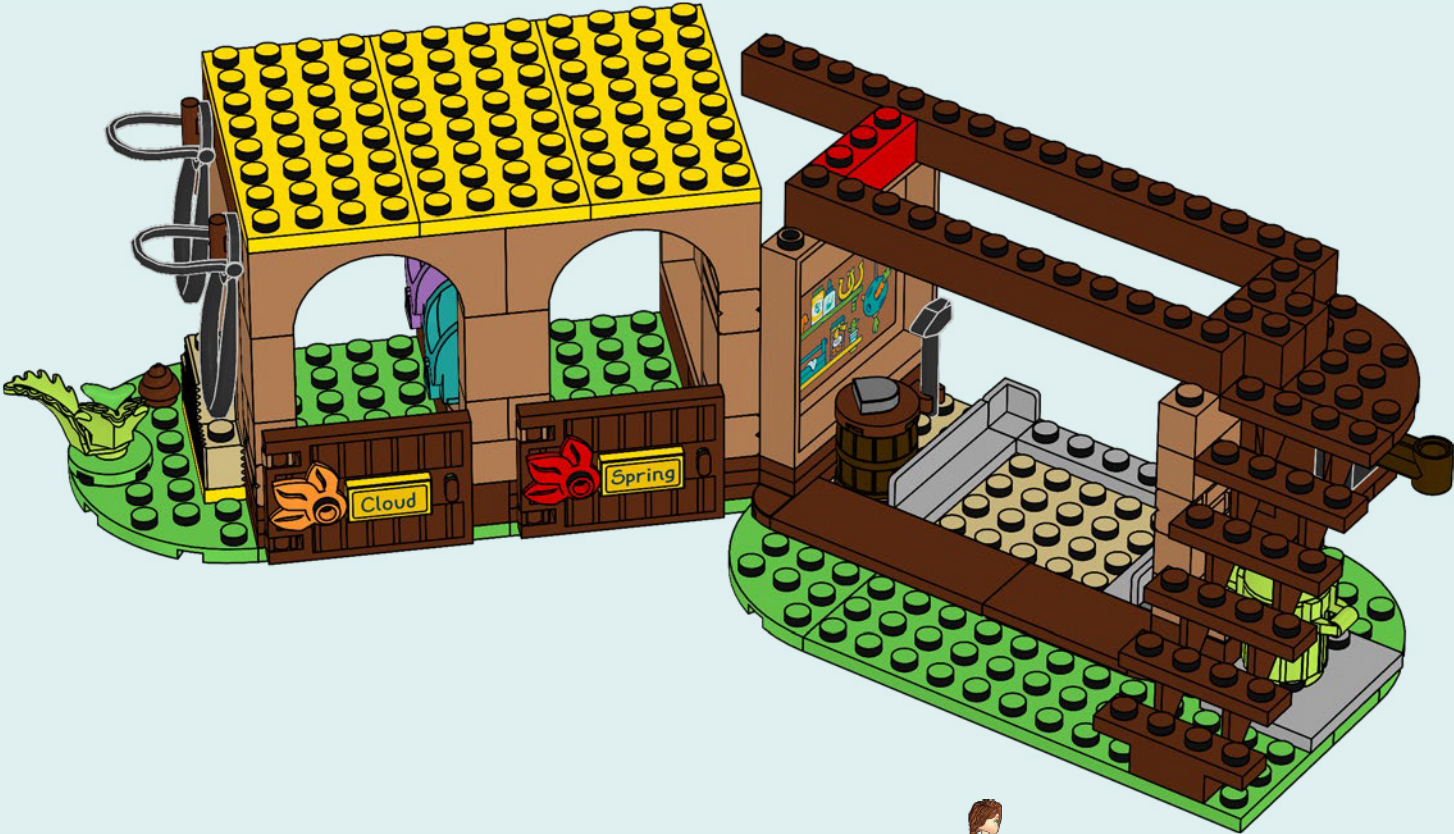



57

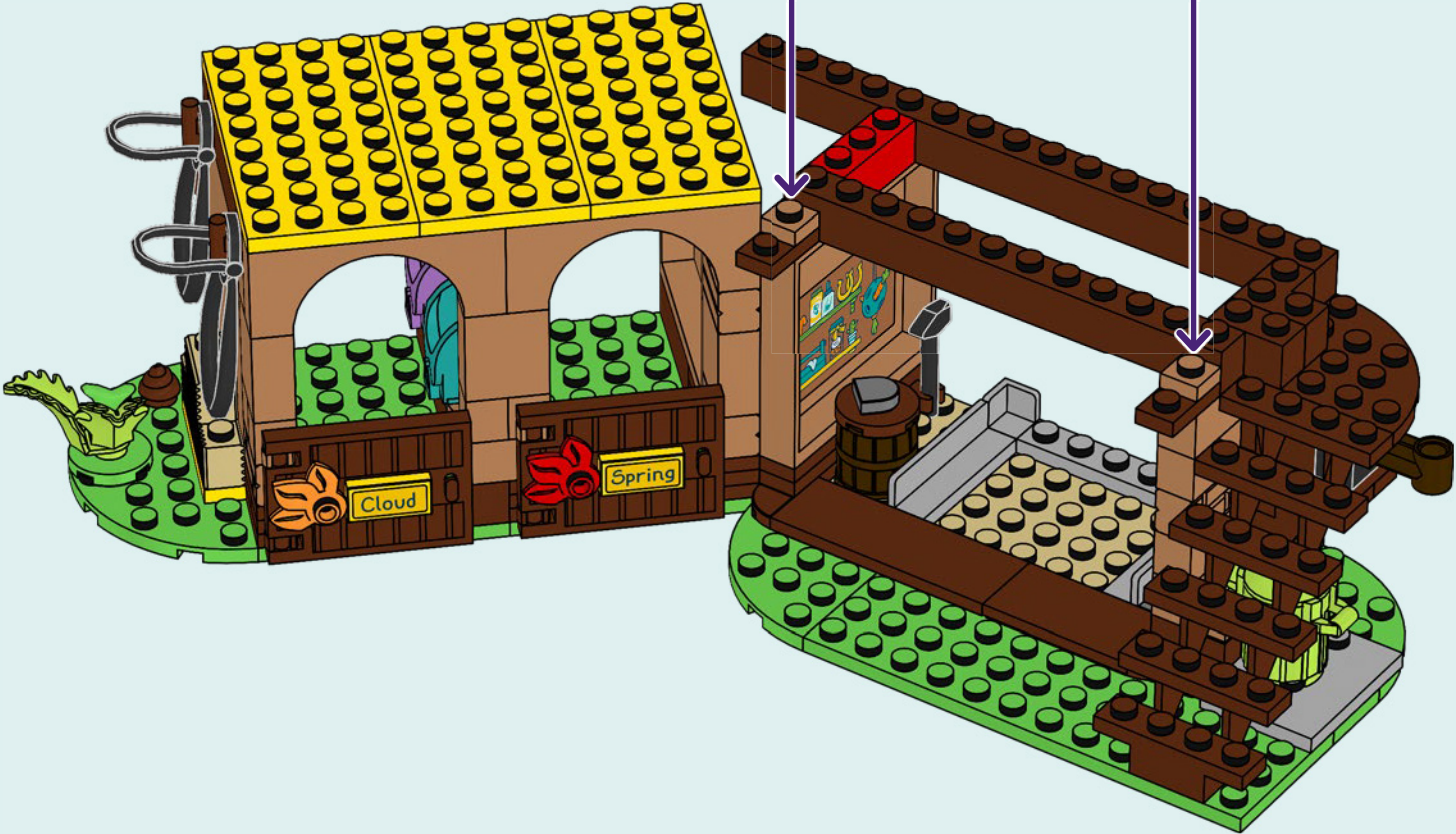
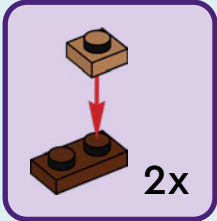



2x

58

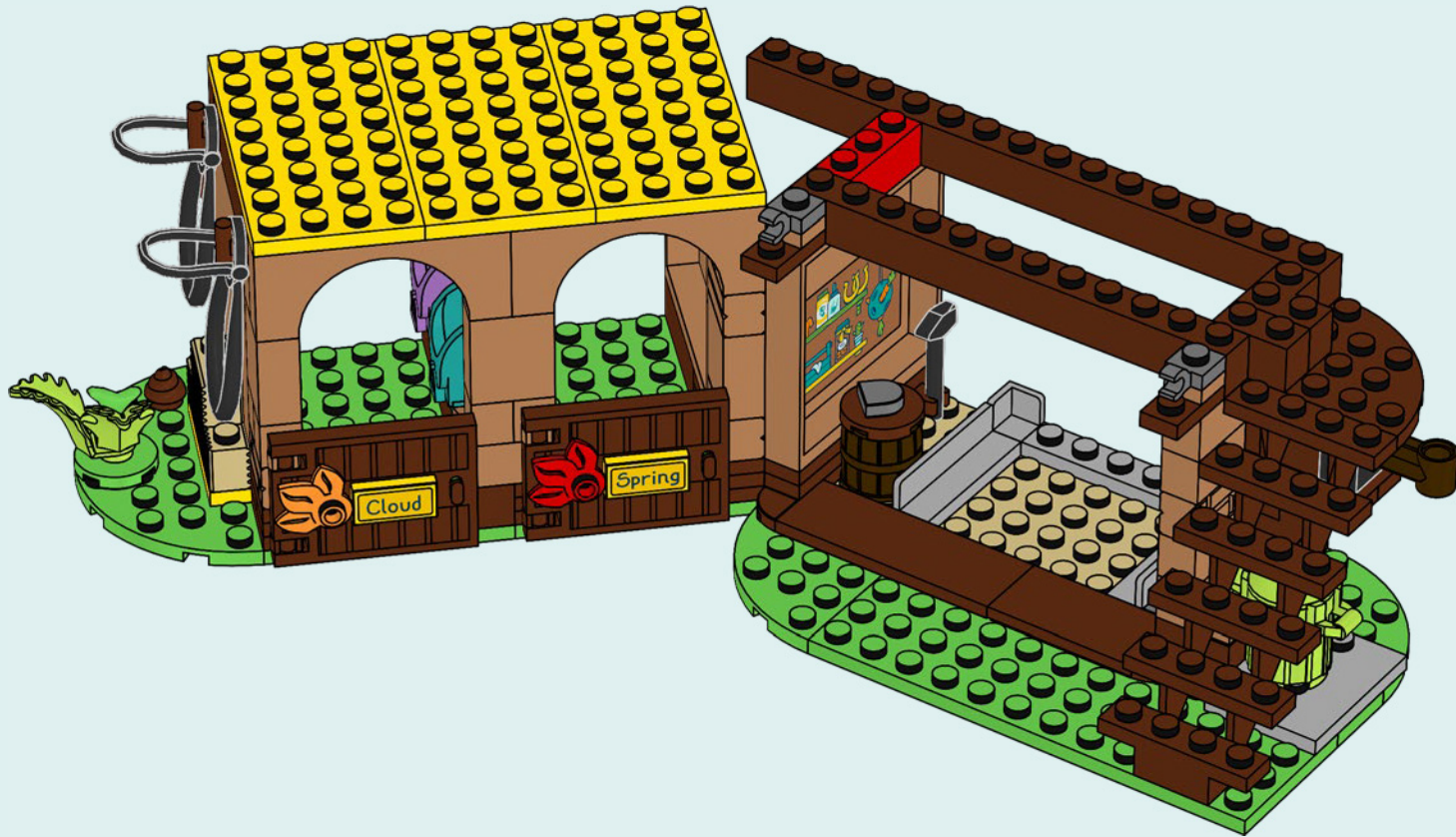

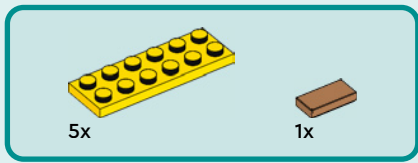

59

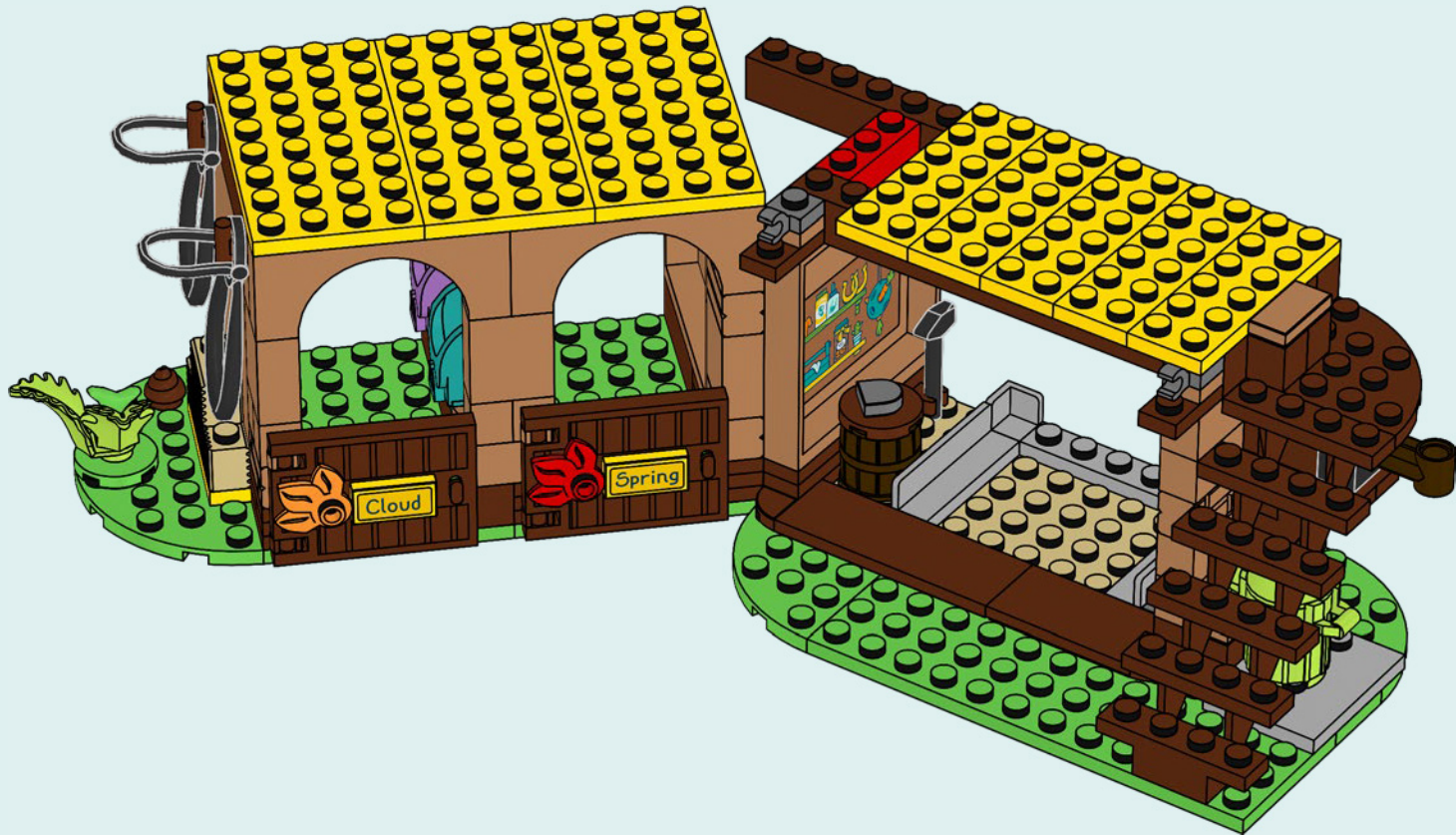

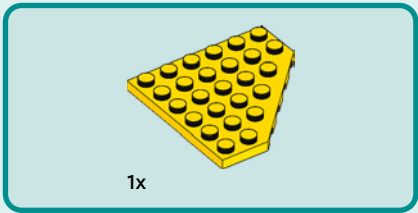

60

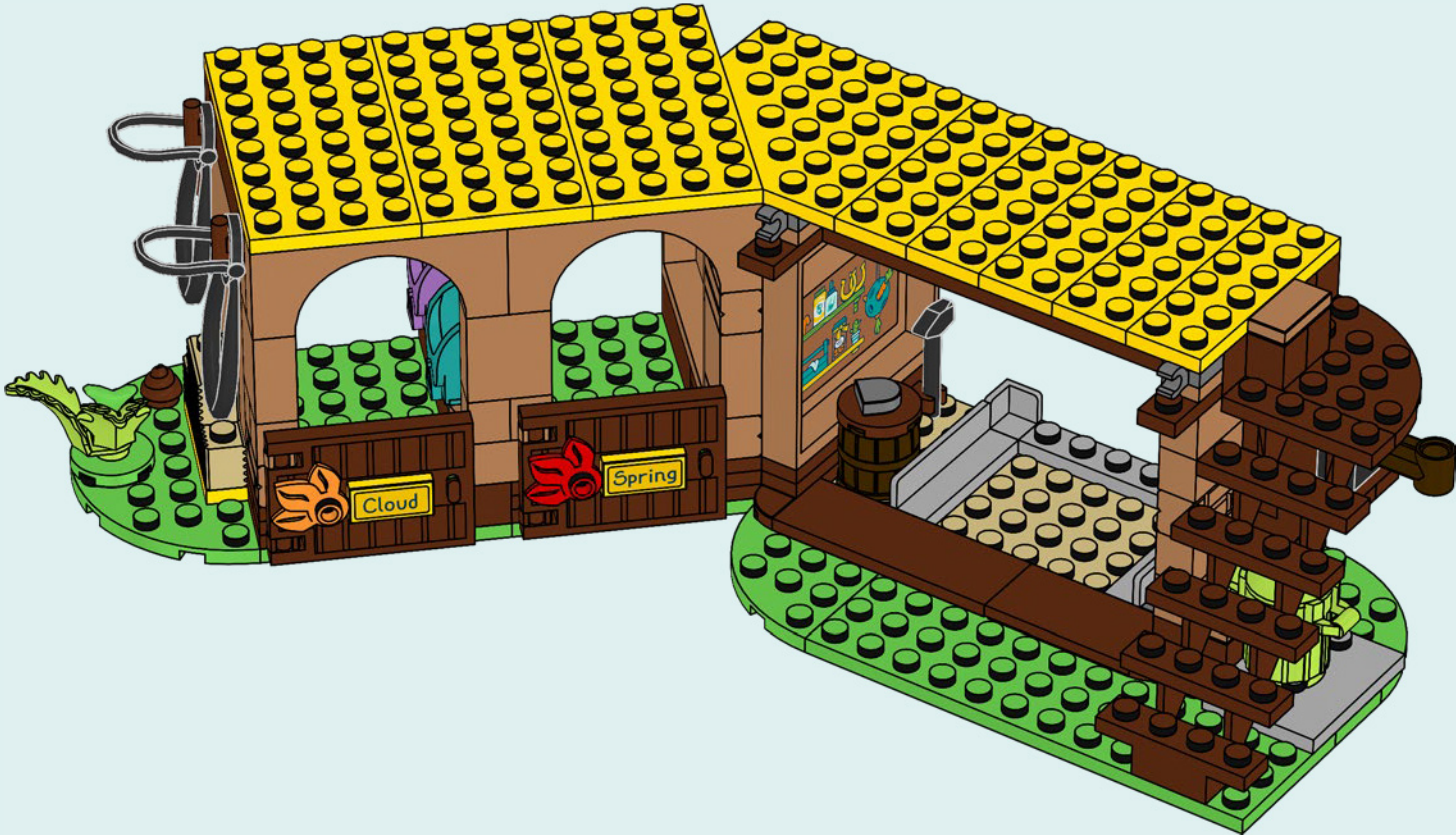



3x

61

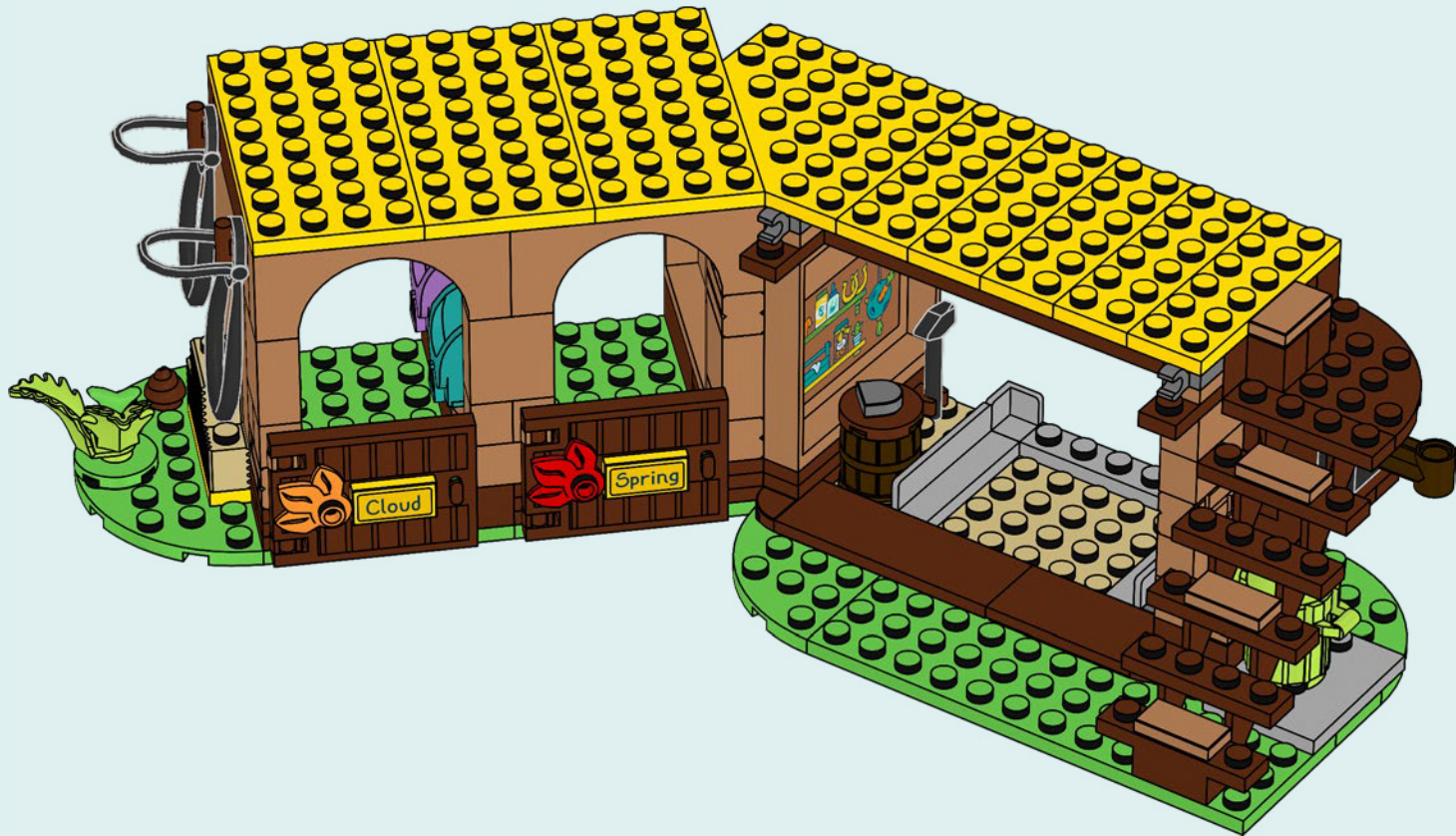



1x



1x

62





2x

63

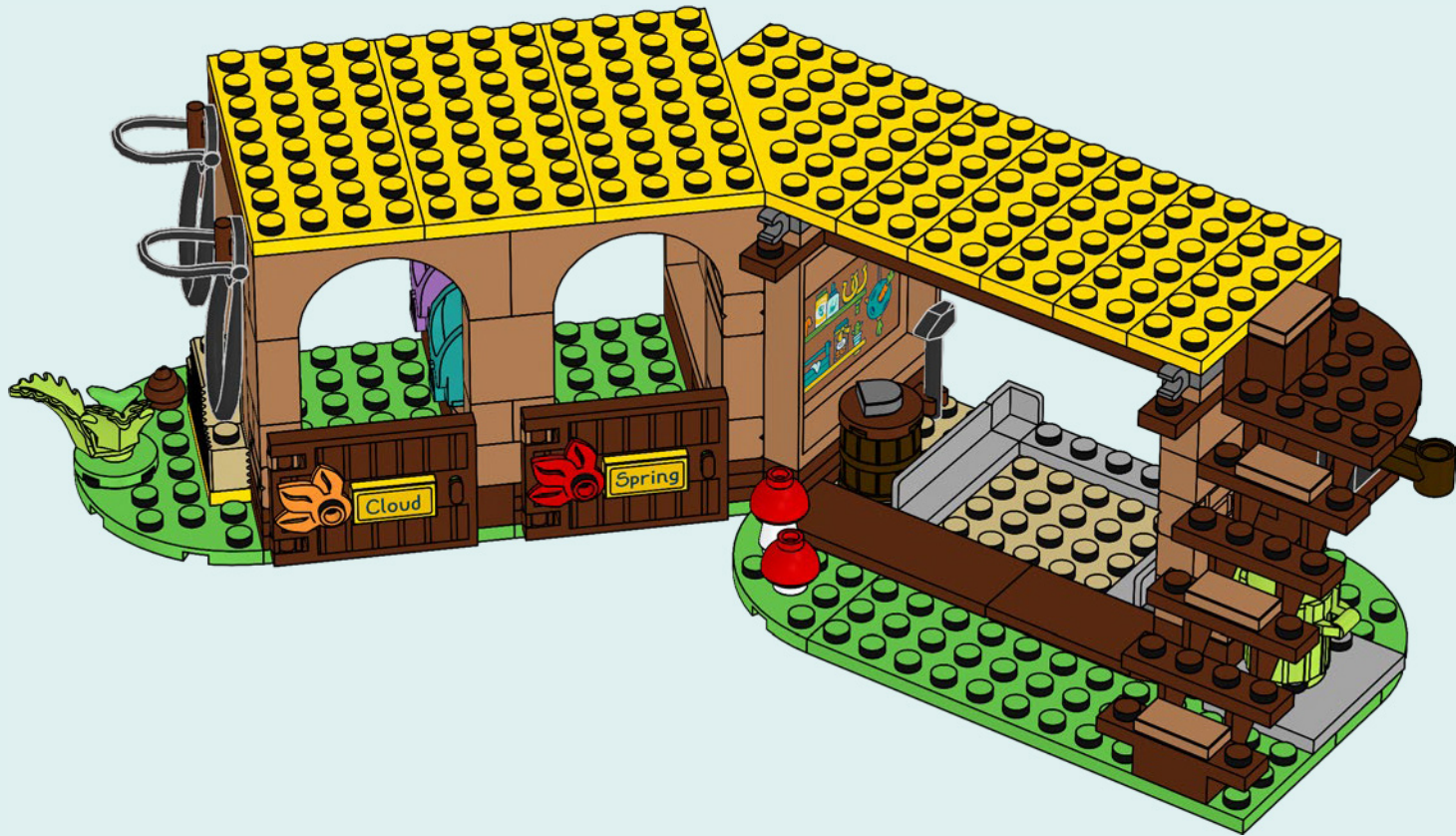



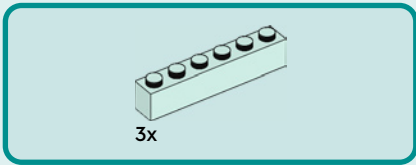

64

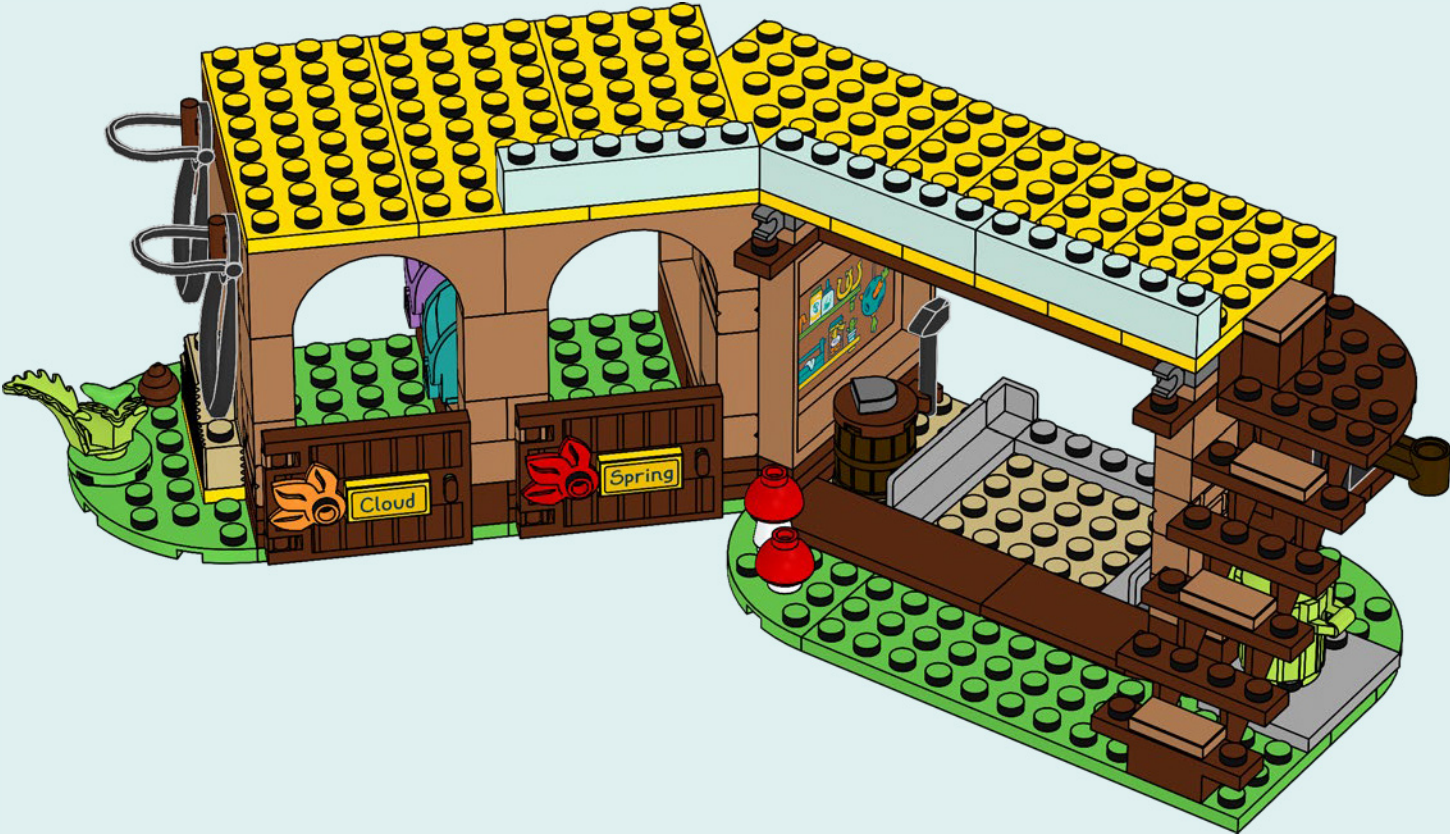

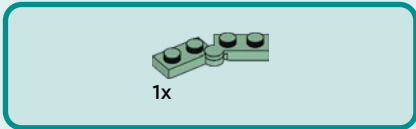

65

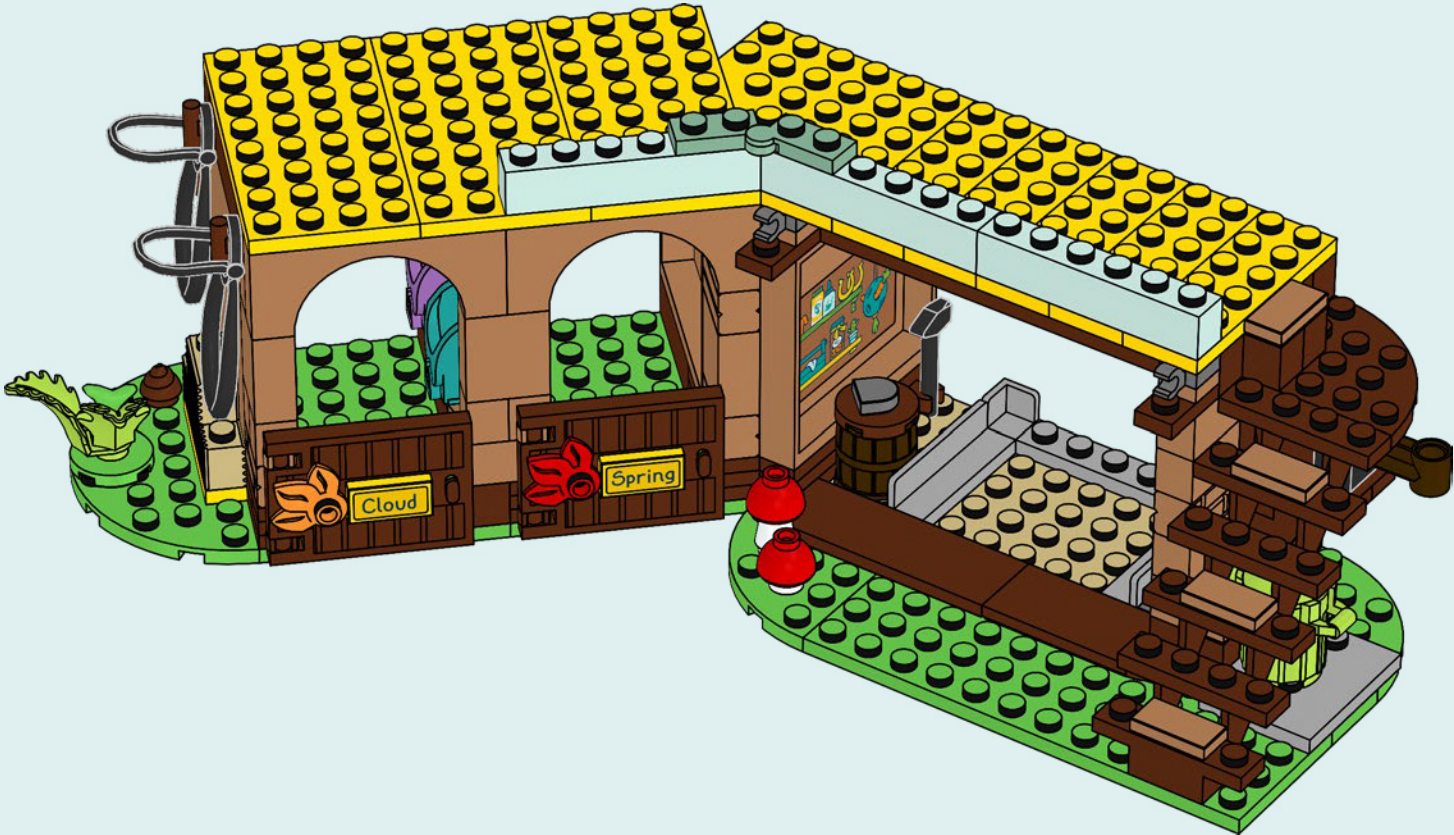

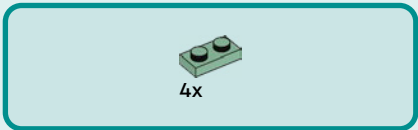

66

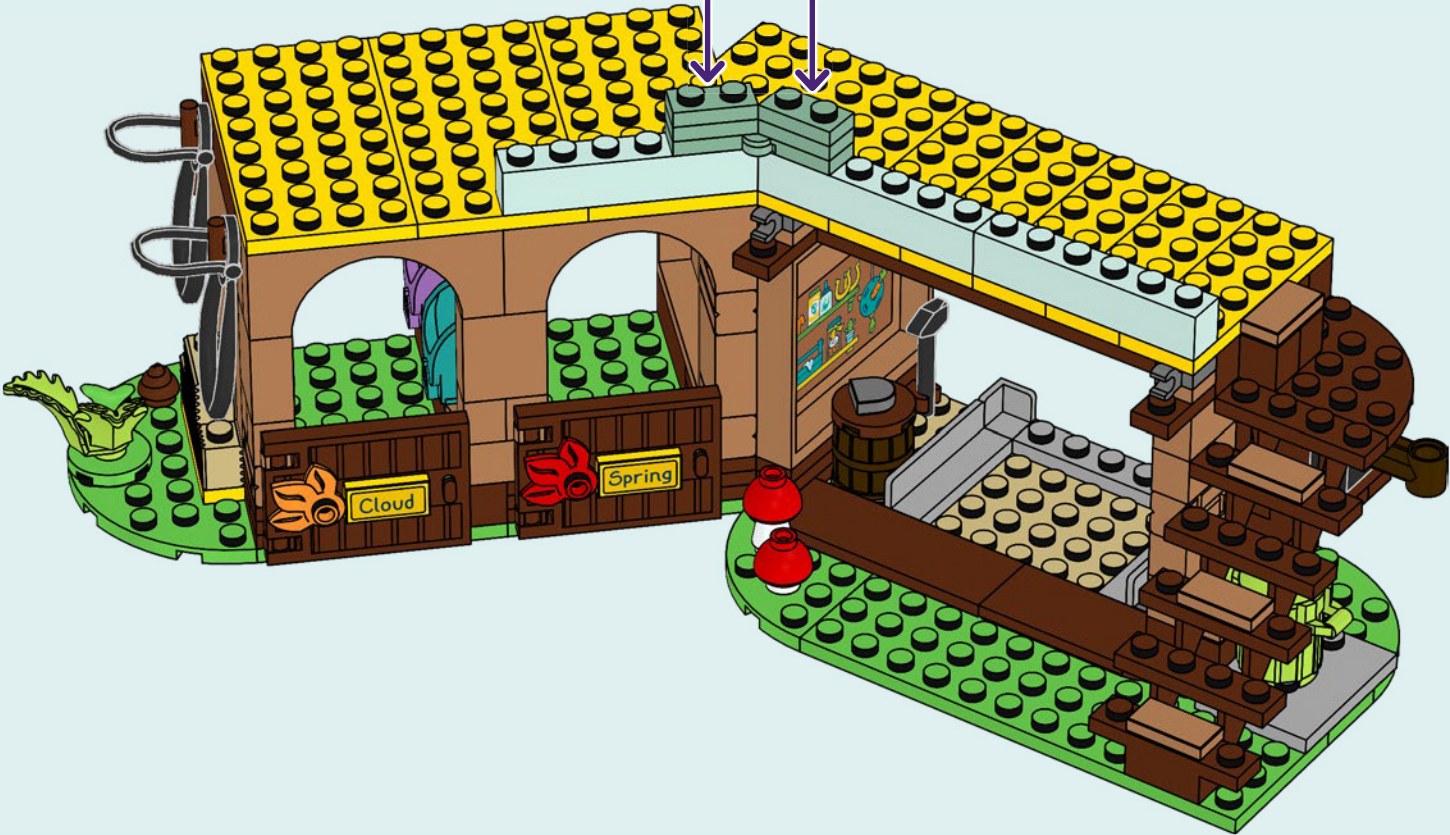
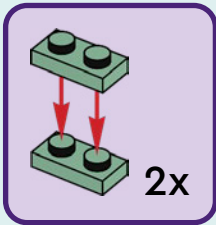



1x



2x

67

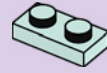

2x

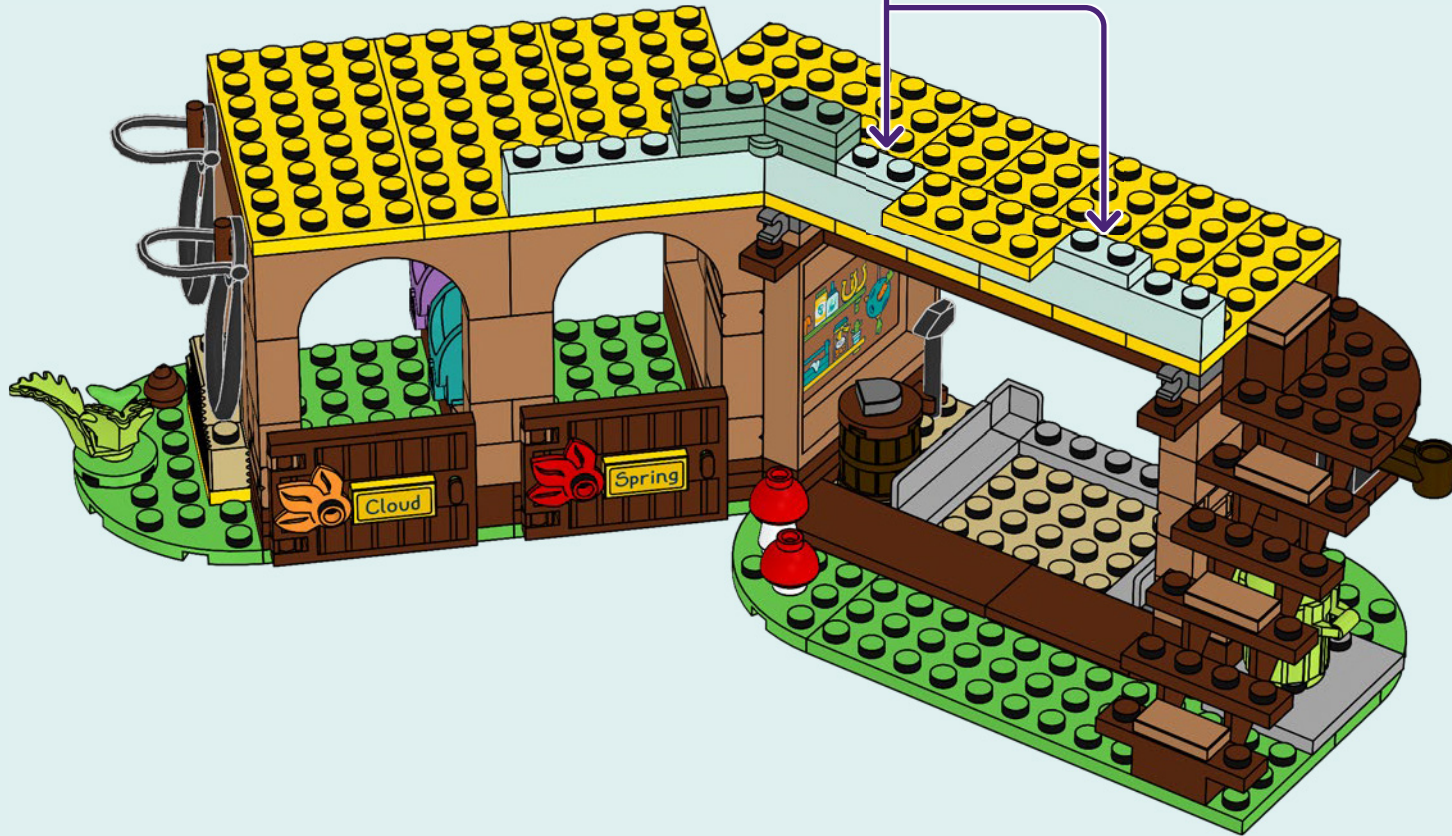



2x

68

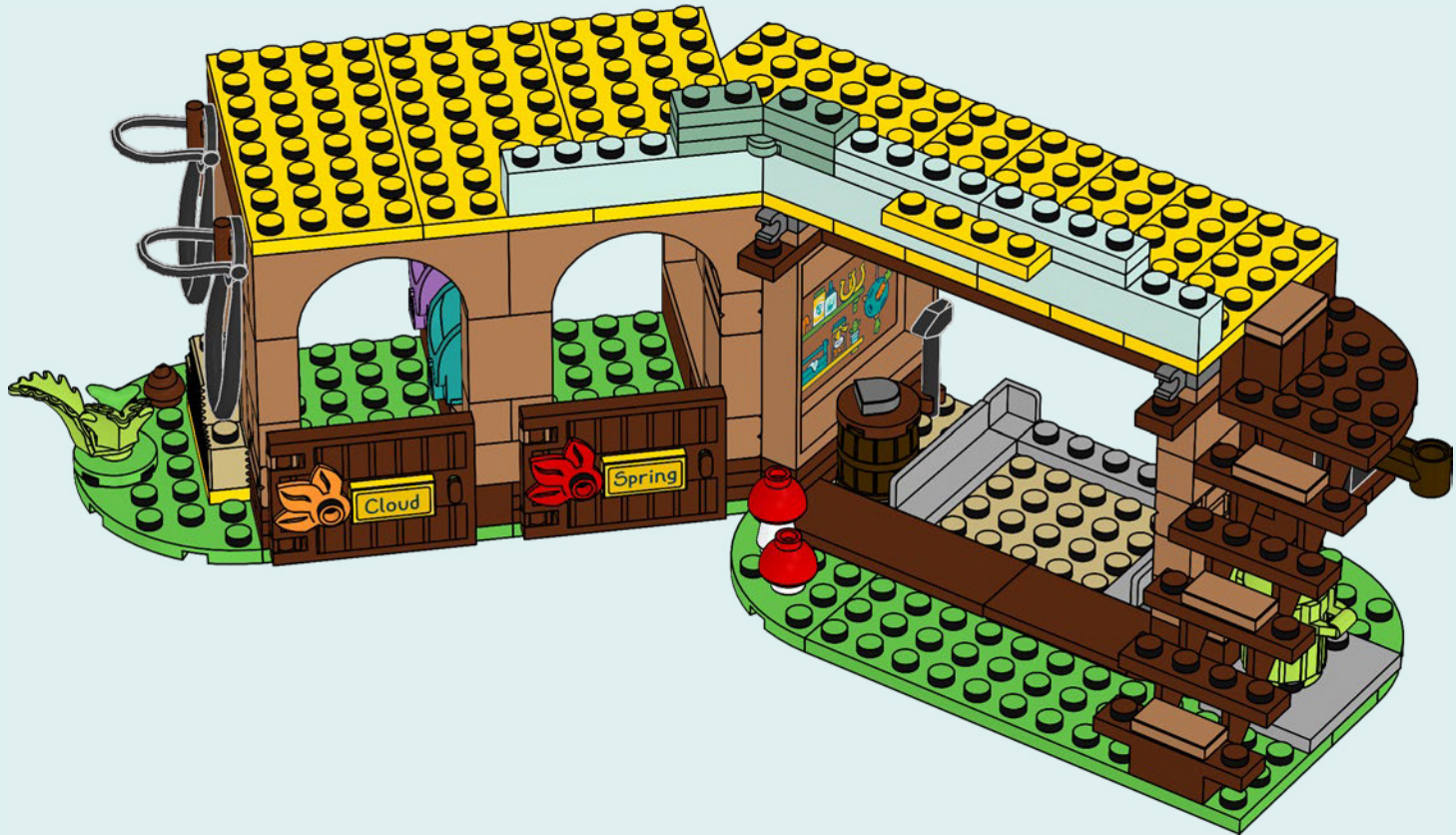

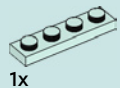

1x



4x

69

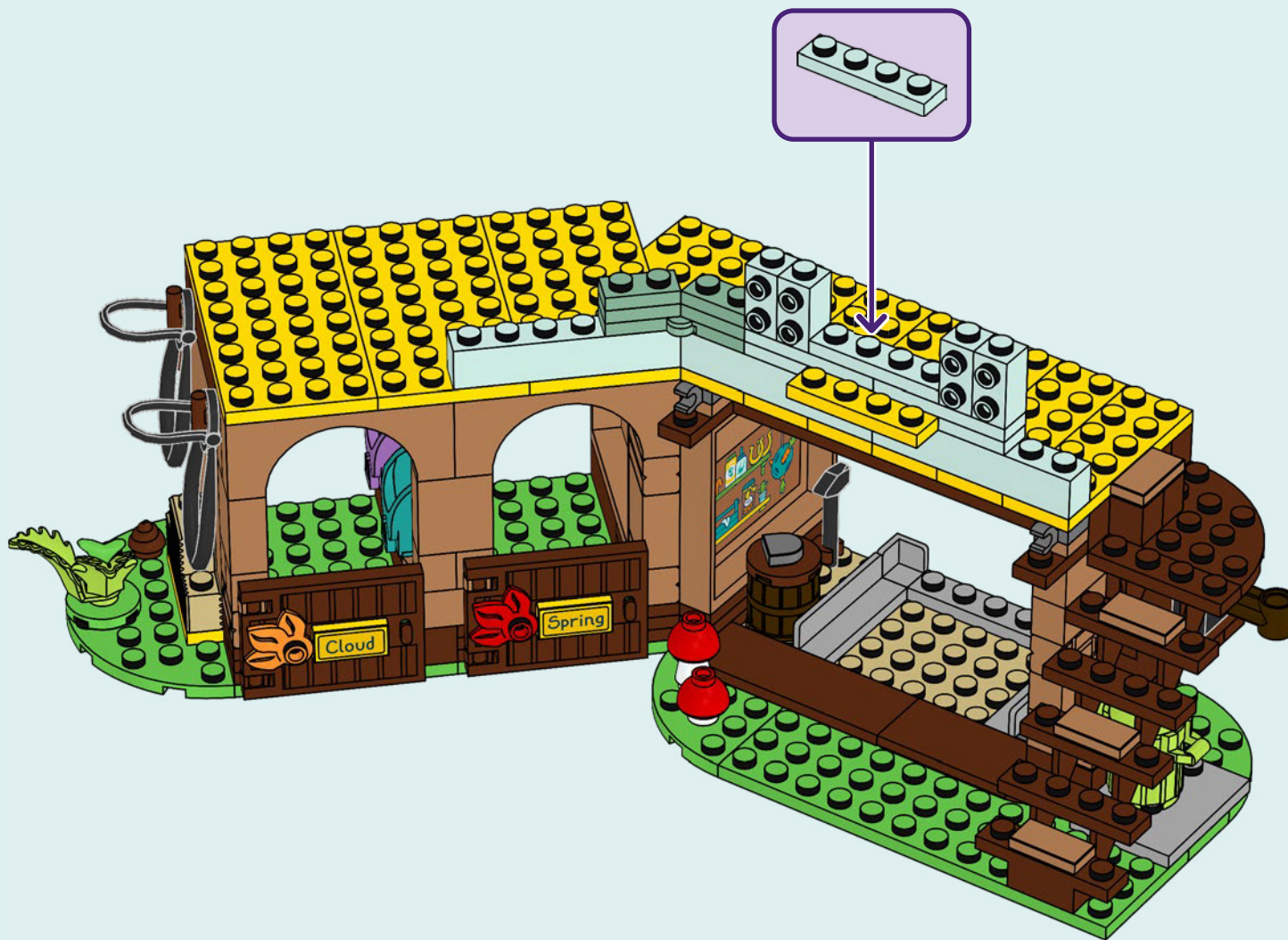

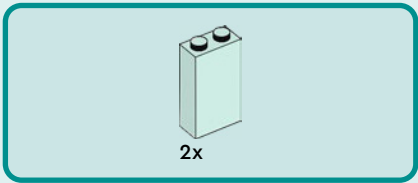

70

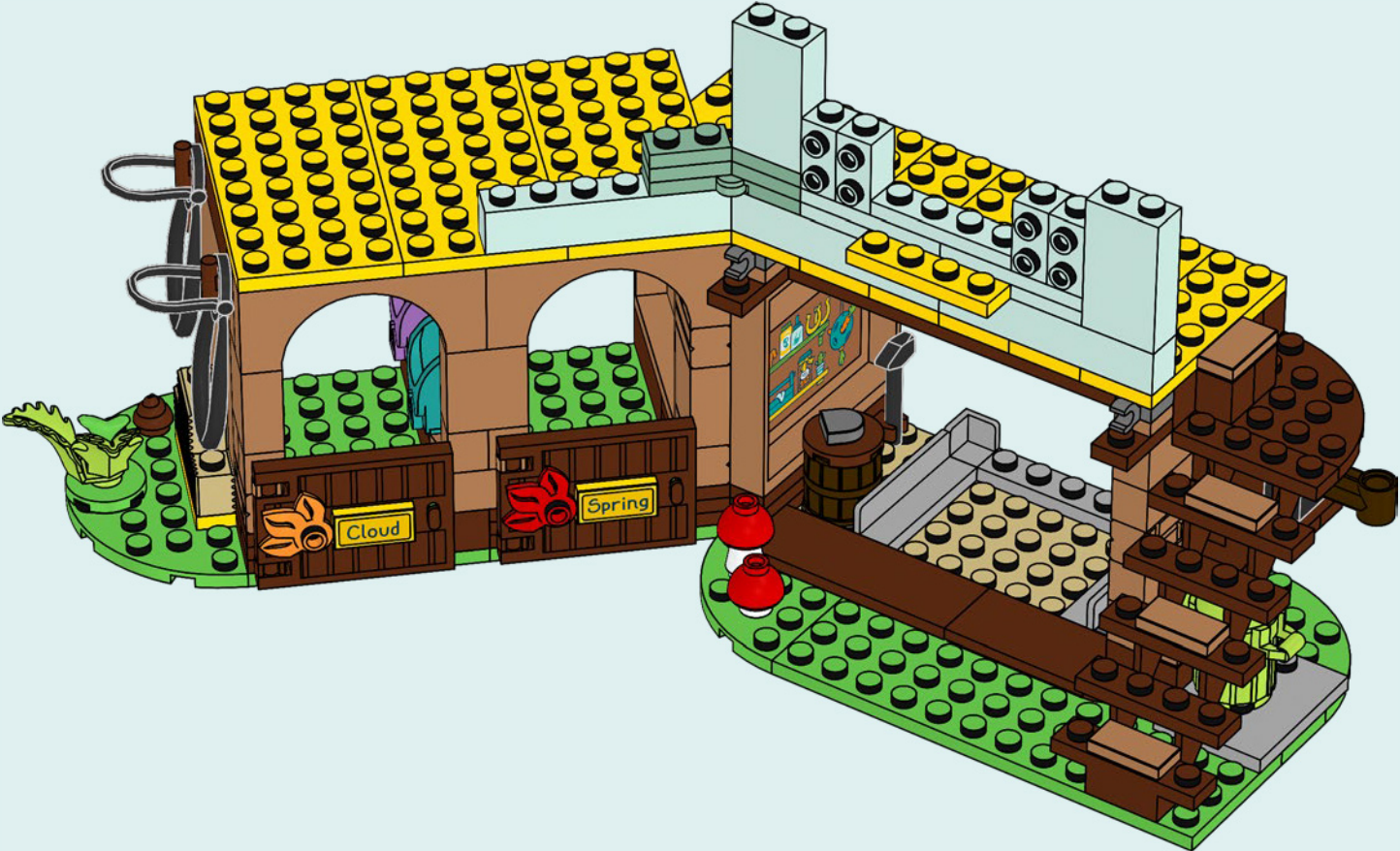

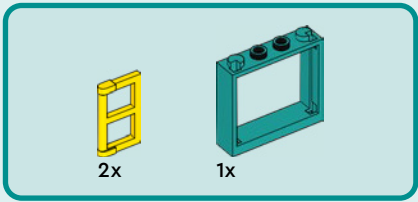

71

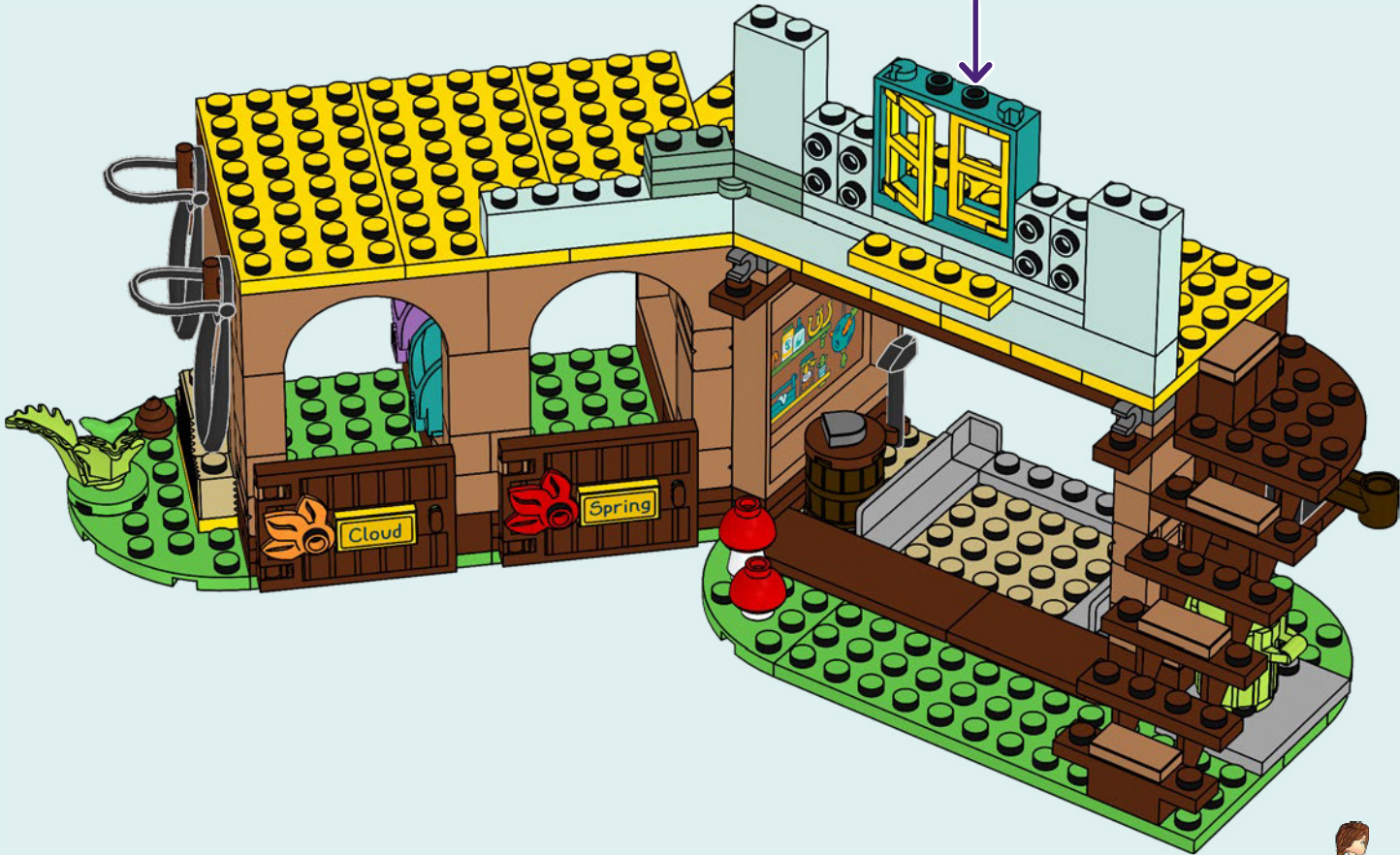
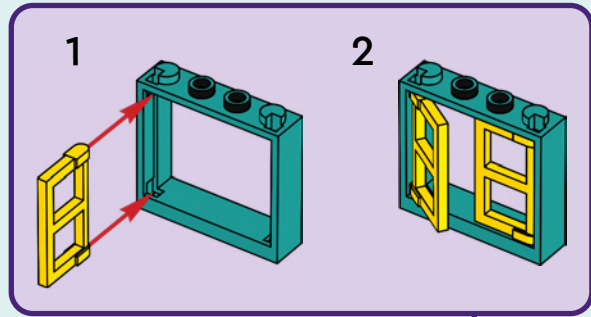

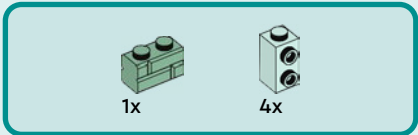

72

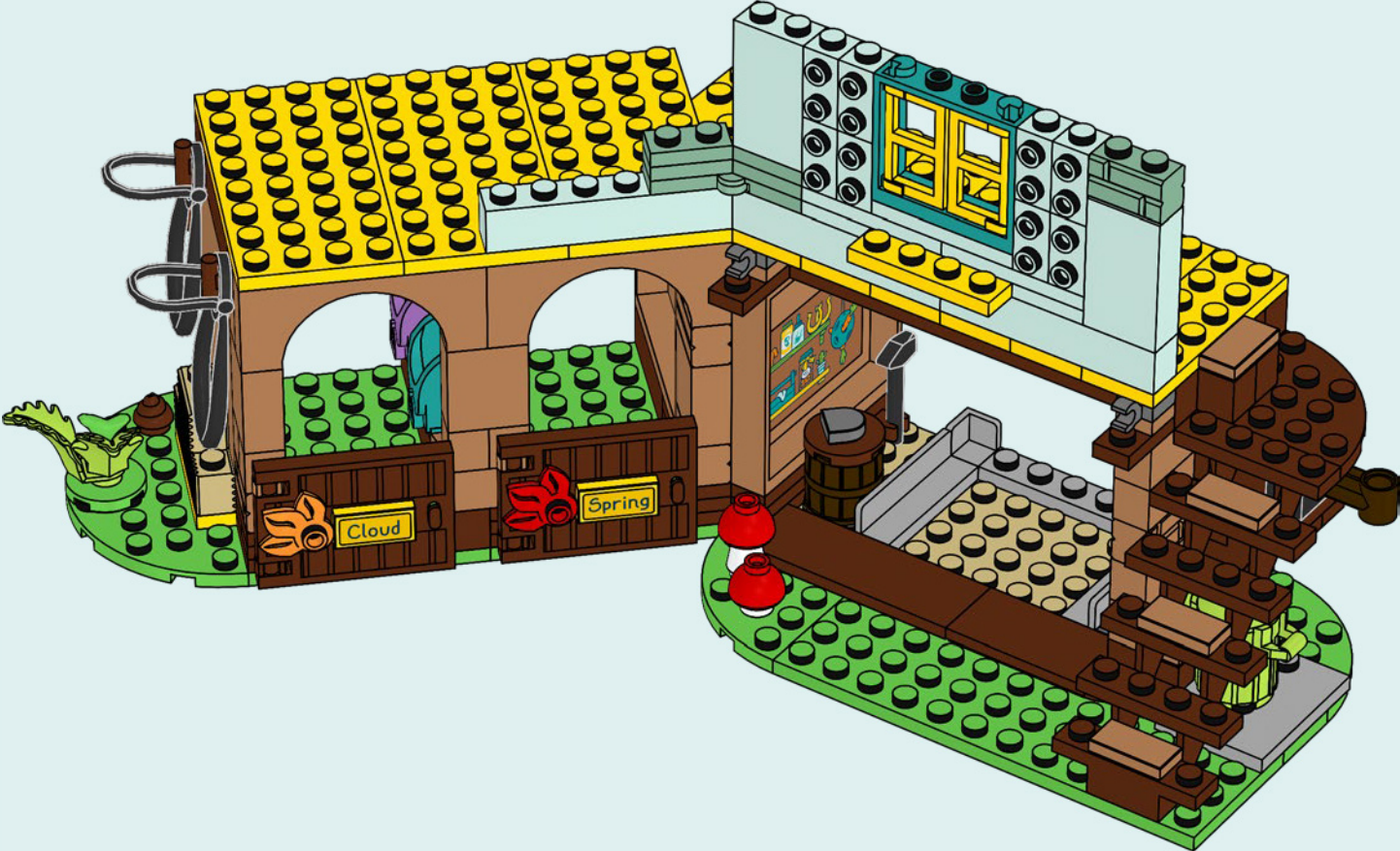

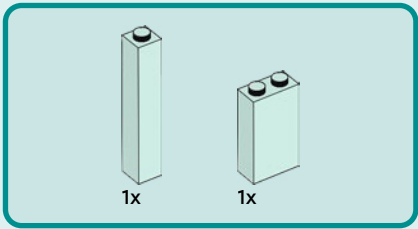

73



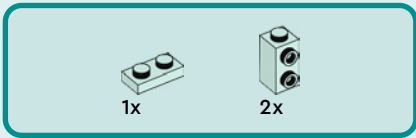

74





1x



1x

75

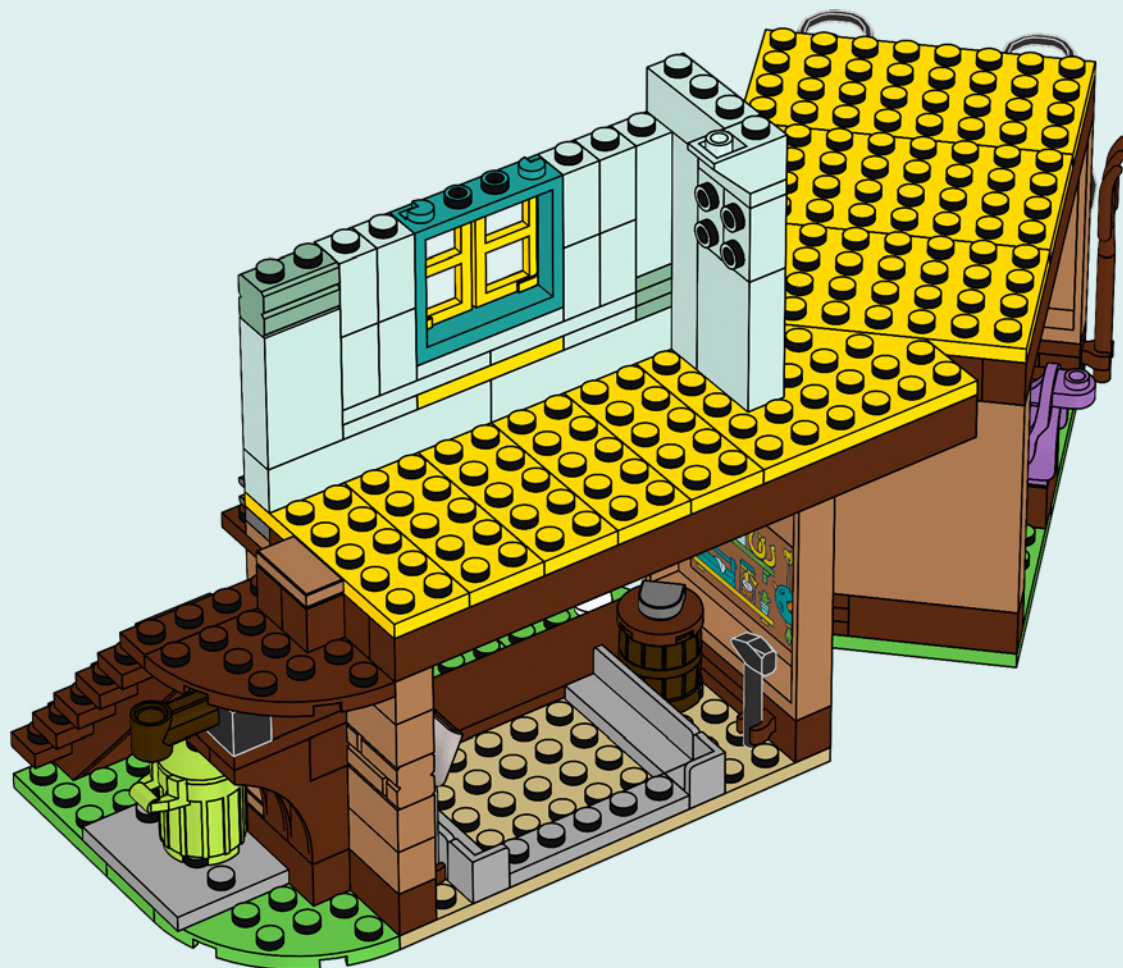

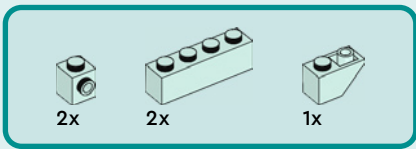

76

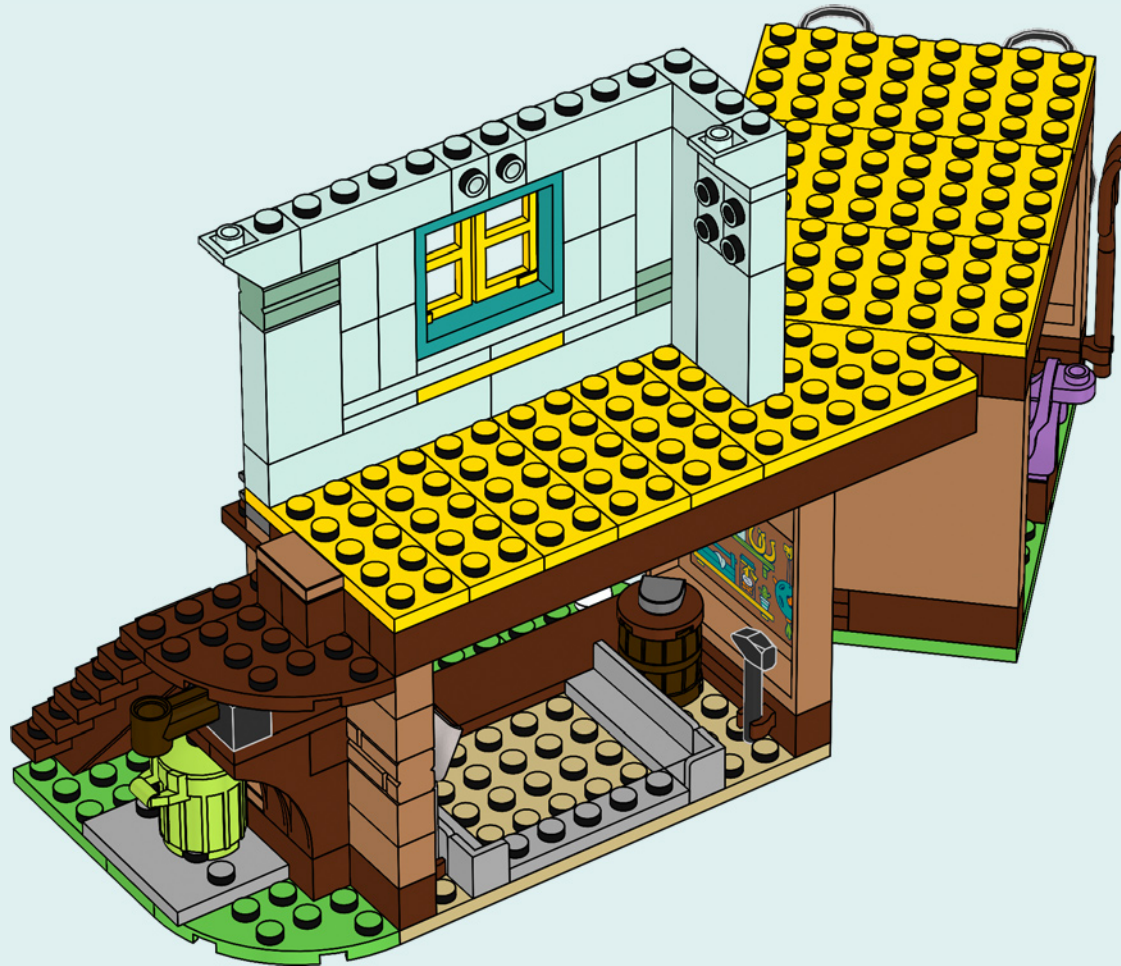



77

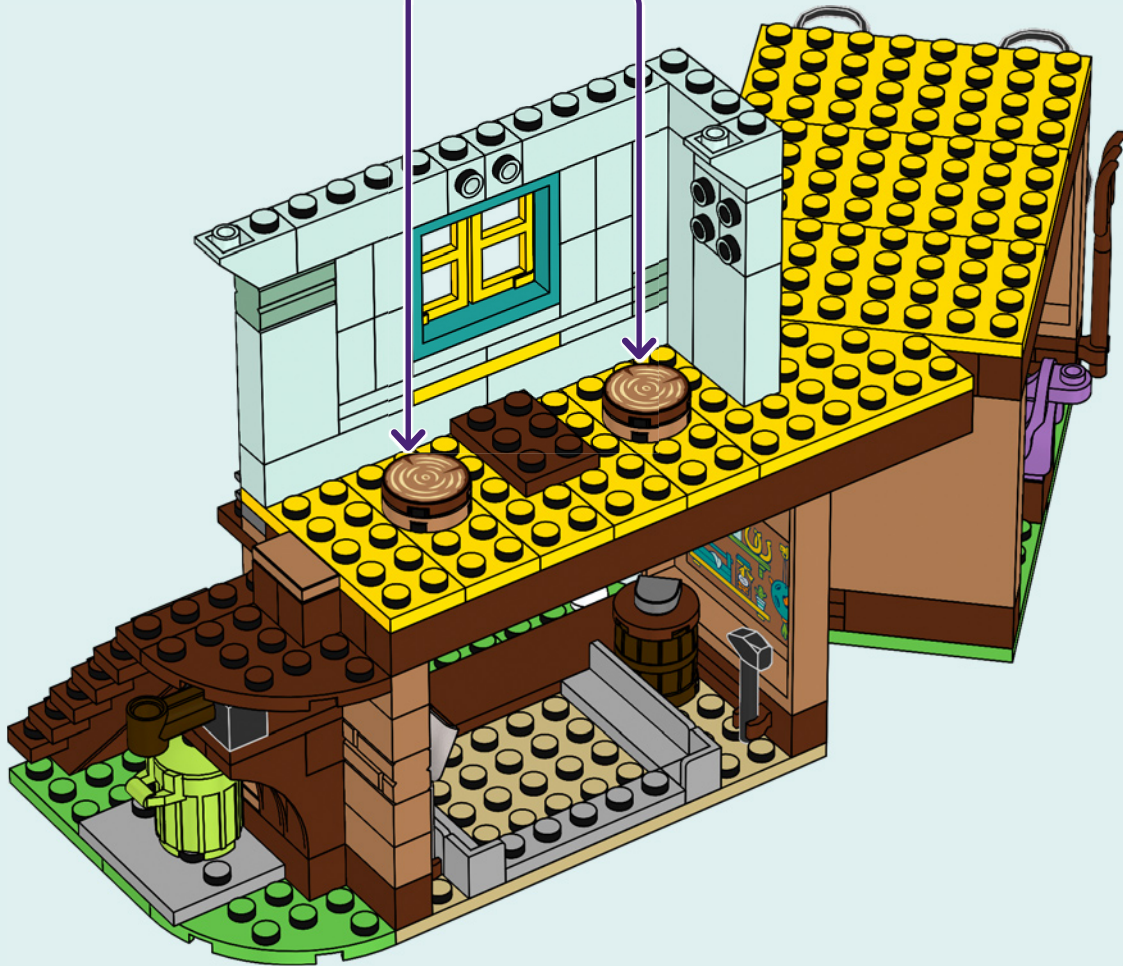
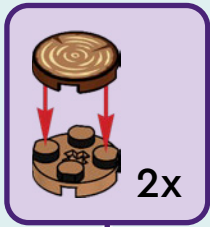

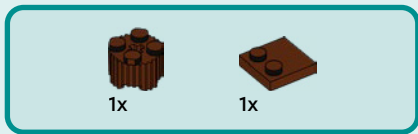

78

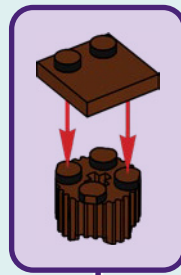

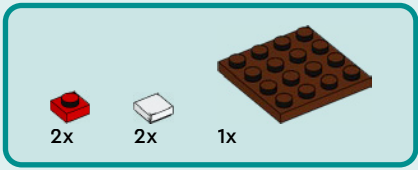

79

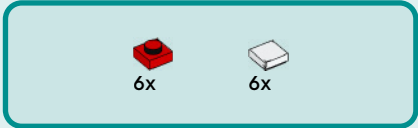
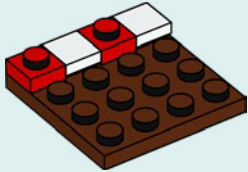

80

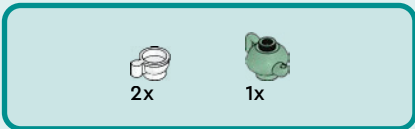
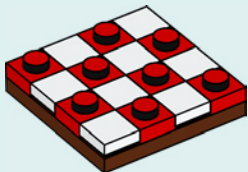

81

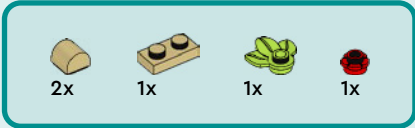

82



83



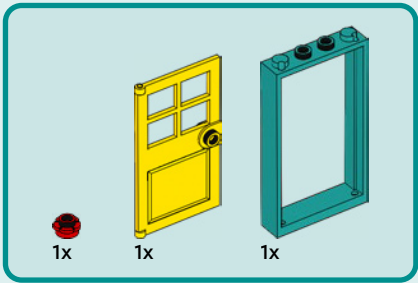

84

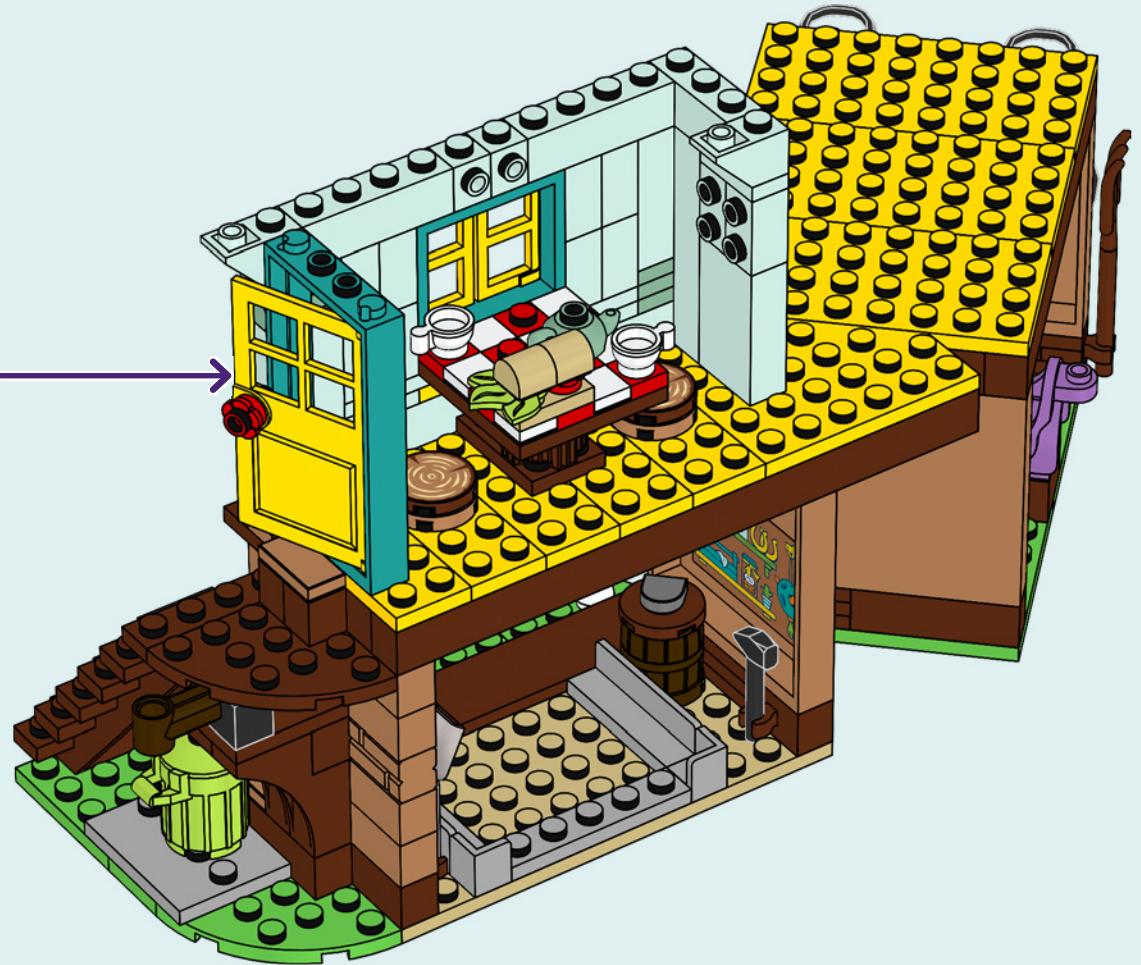
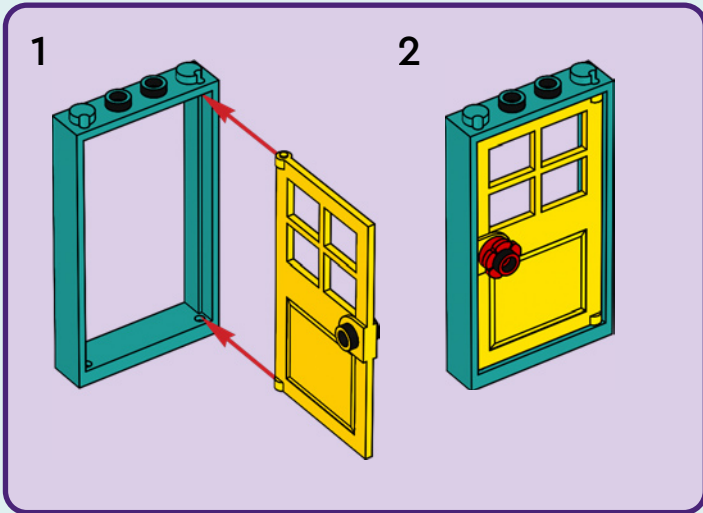

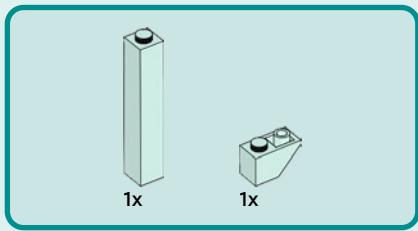

85

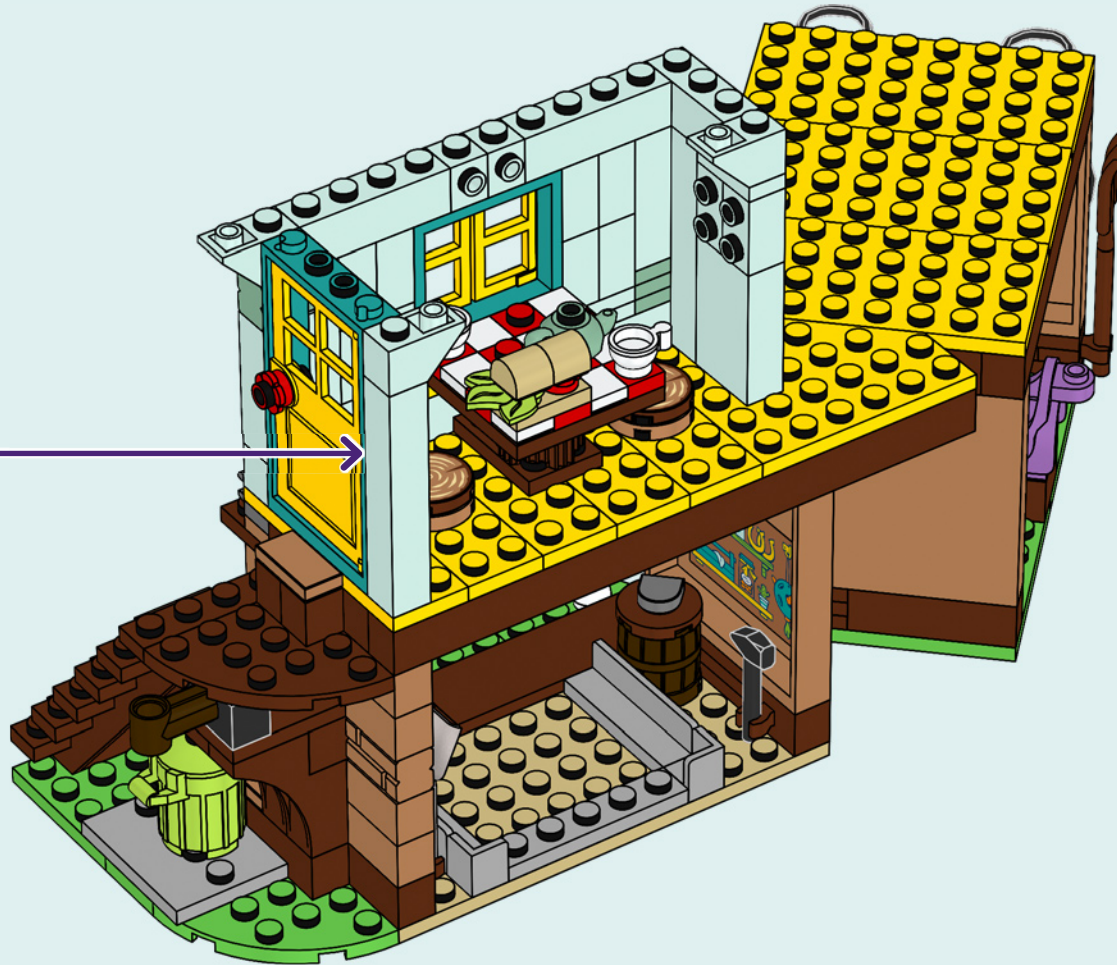
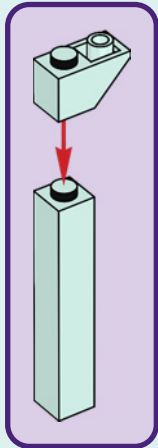

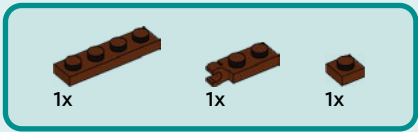

86



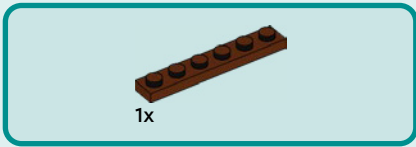

87



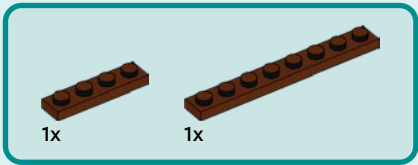

88



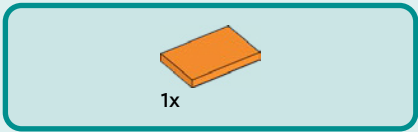

89

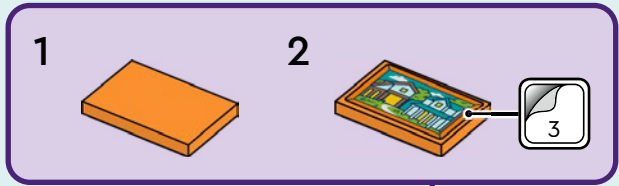

1x

1x

1x

1x

90





1x

91

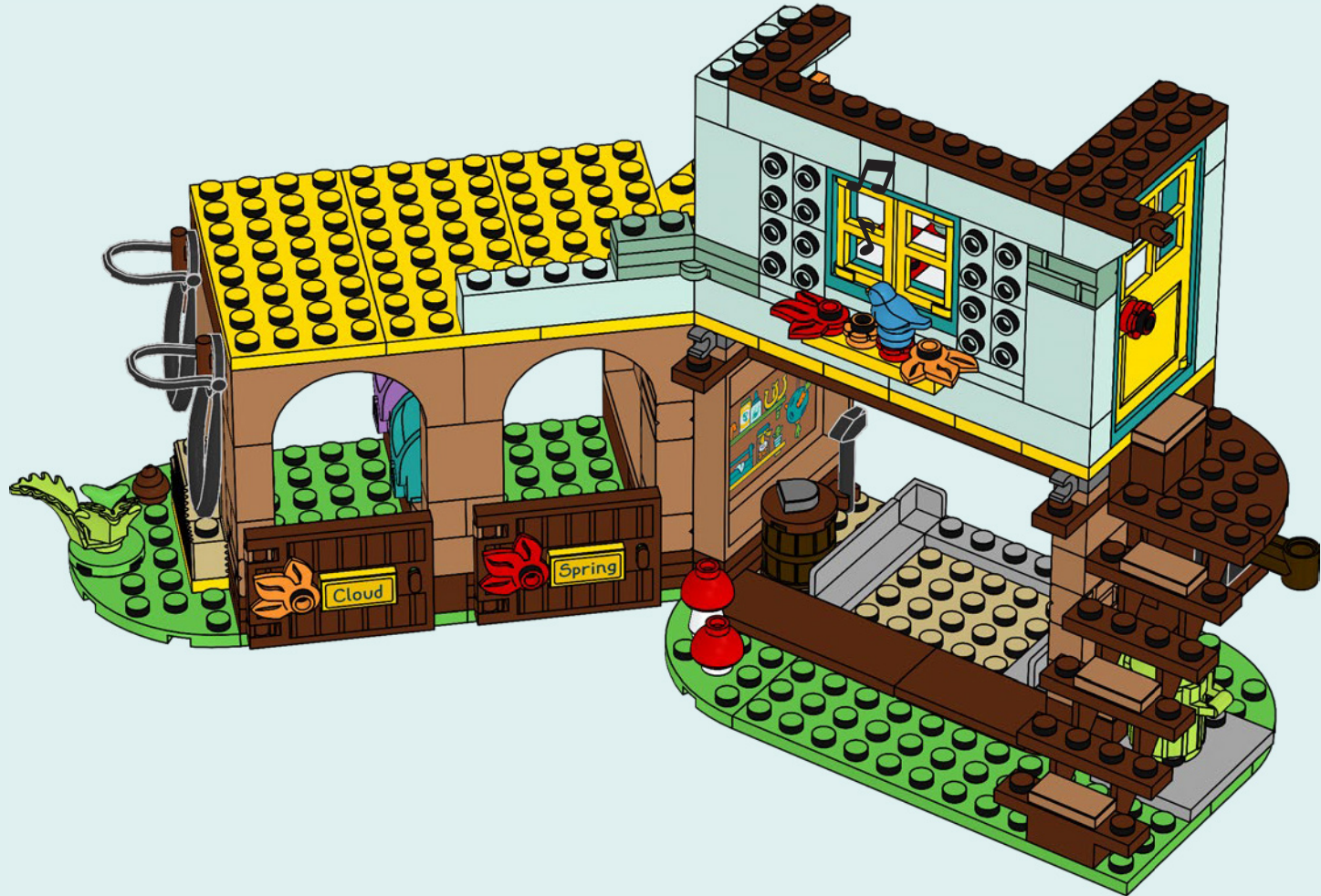



8x

92

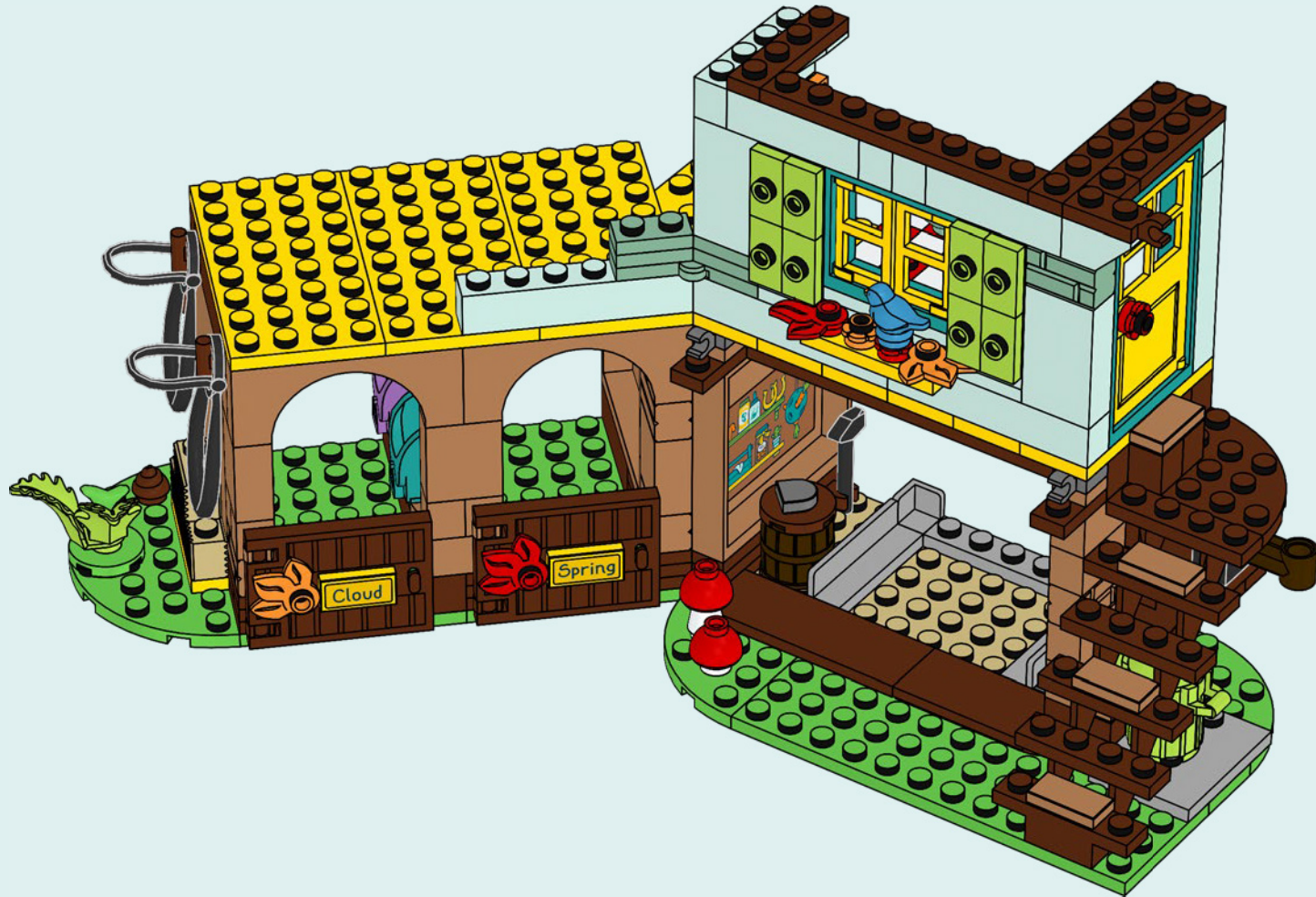



4x

93





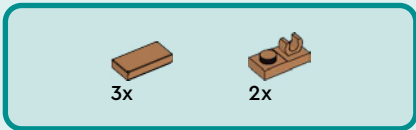

94

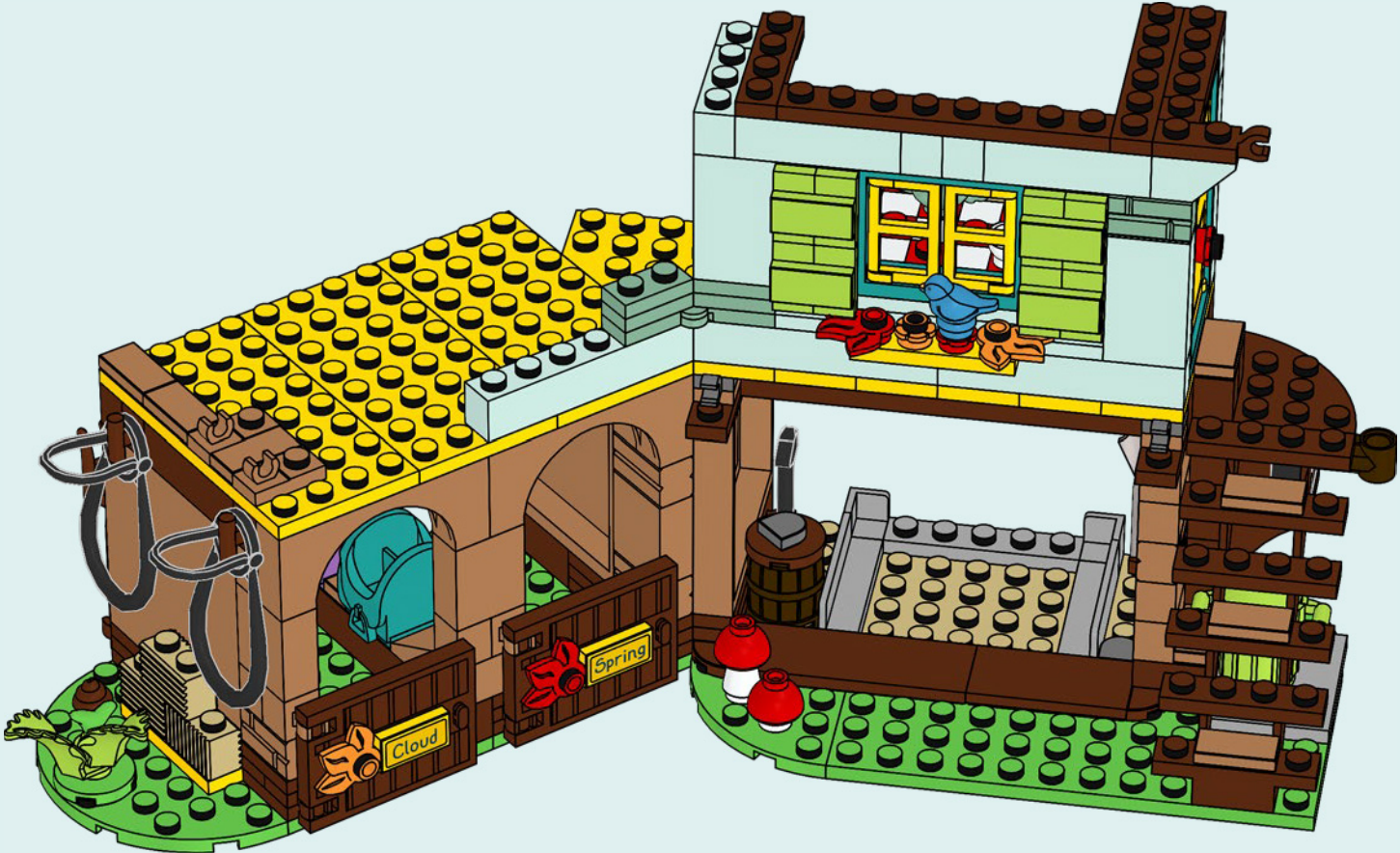



1x

95

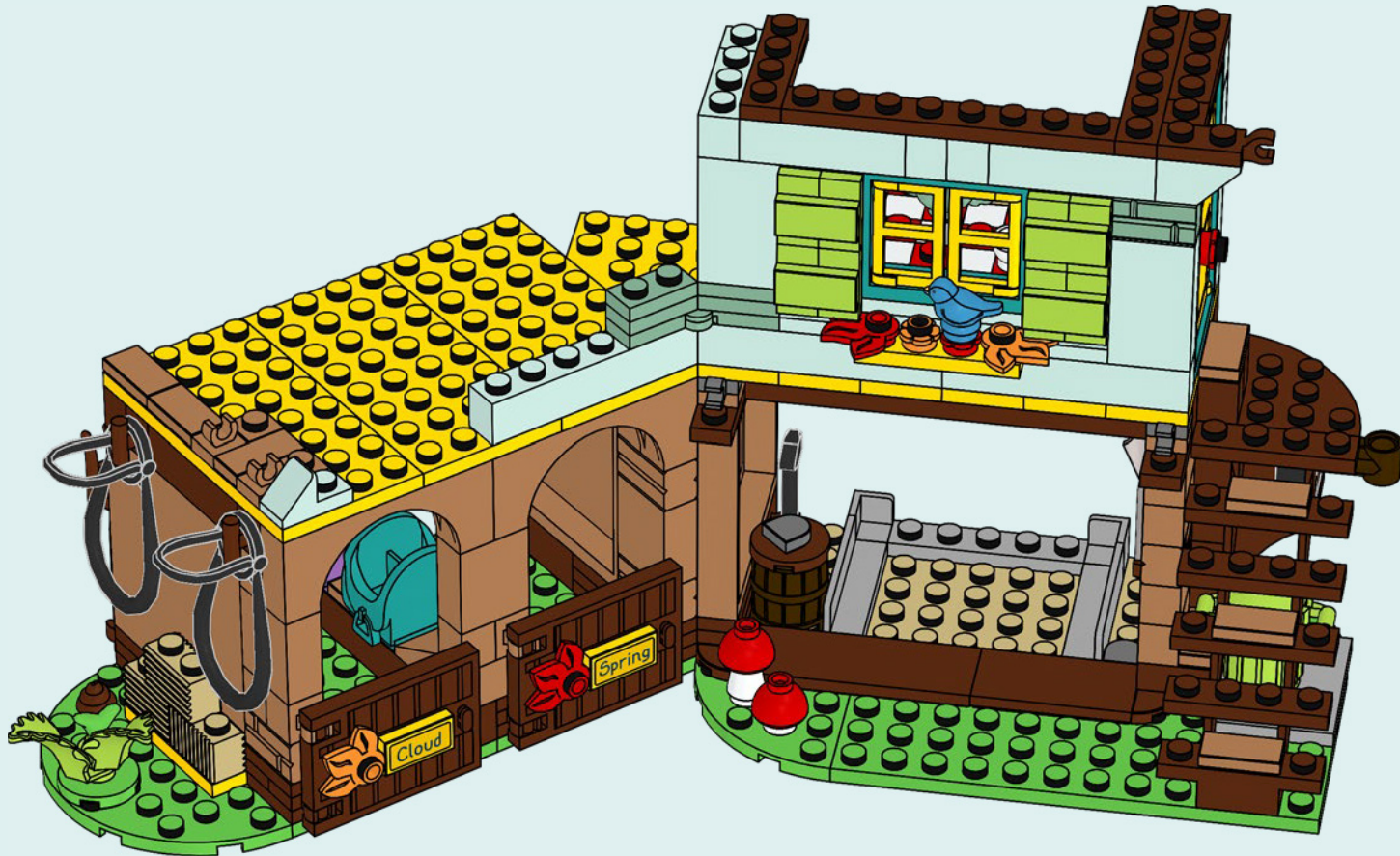

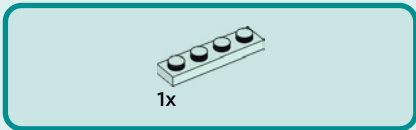

96

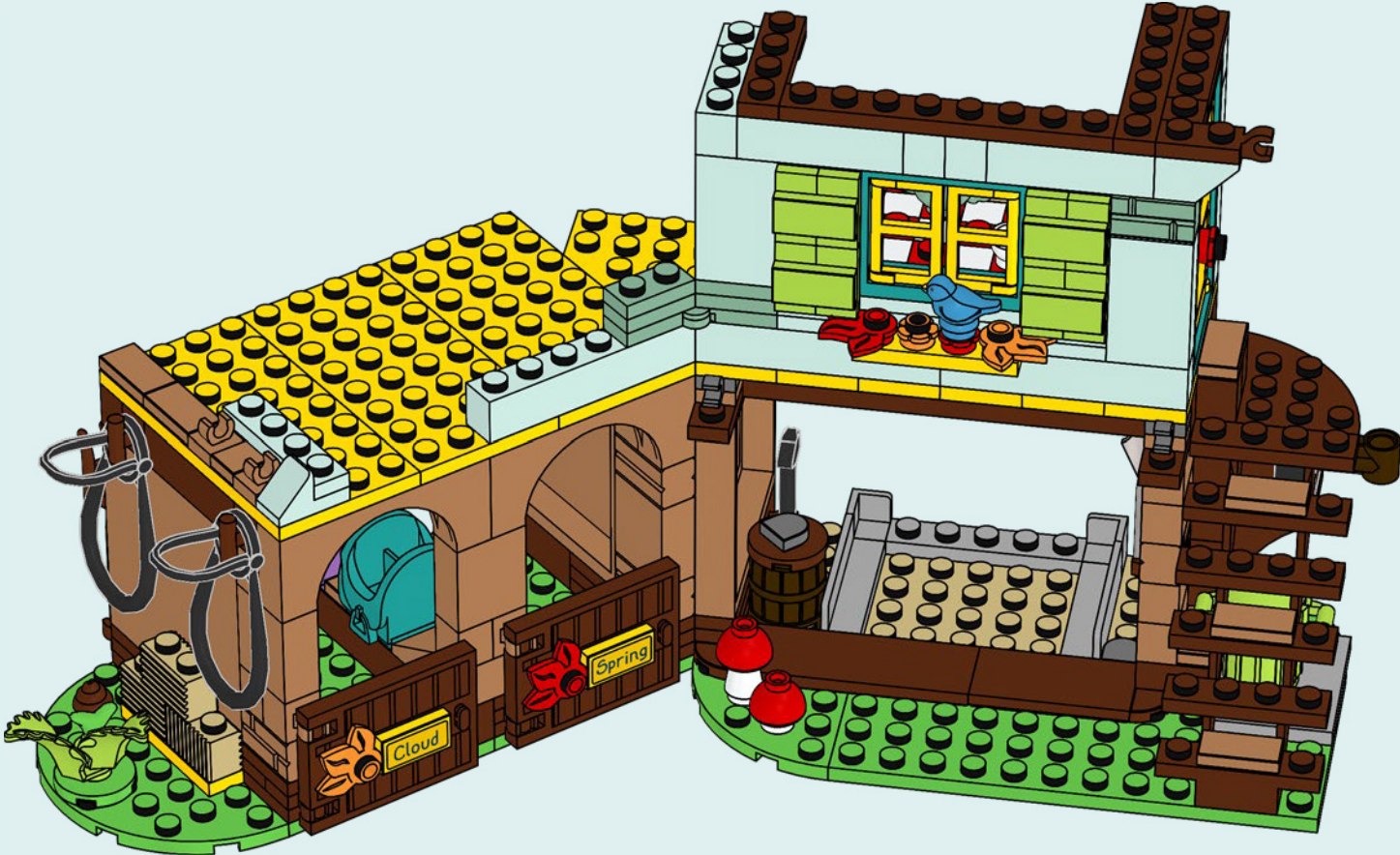

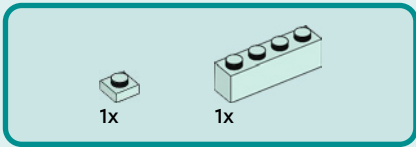

97



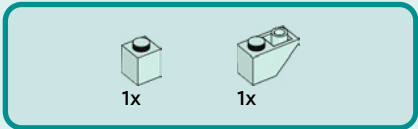

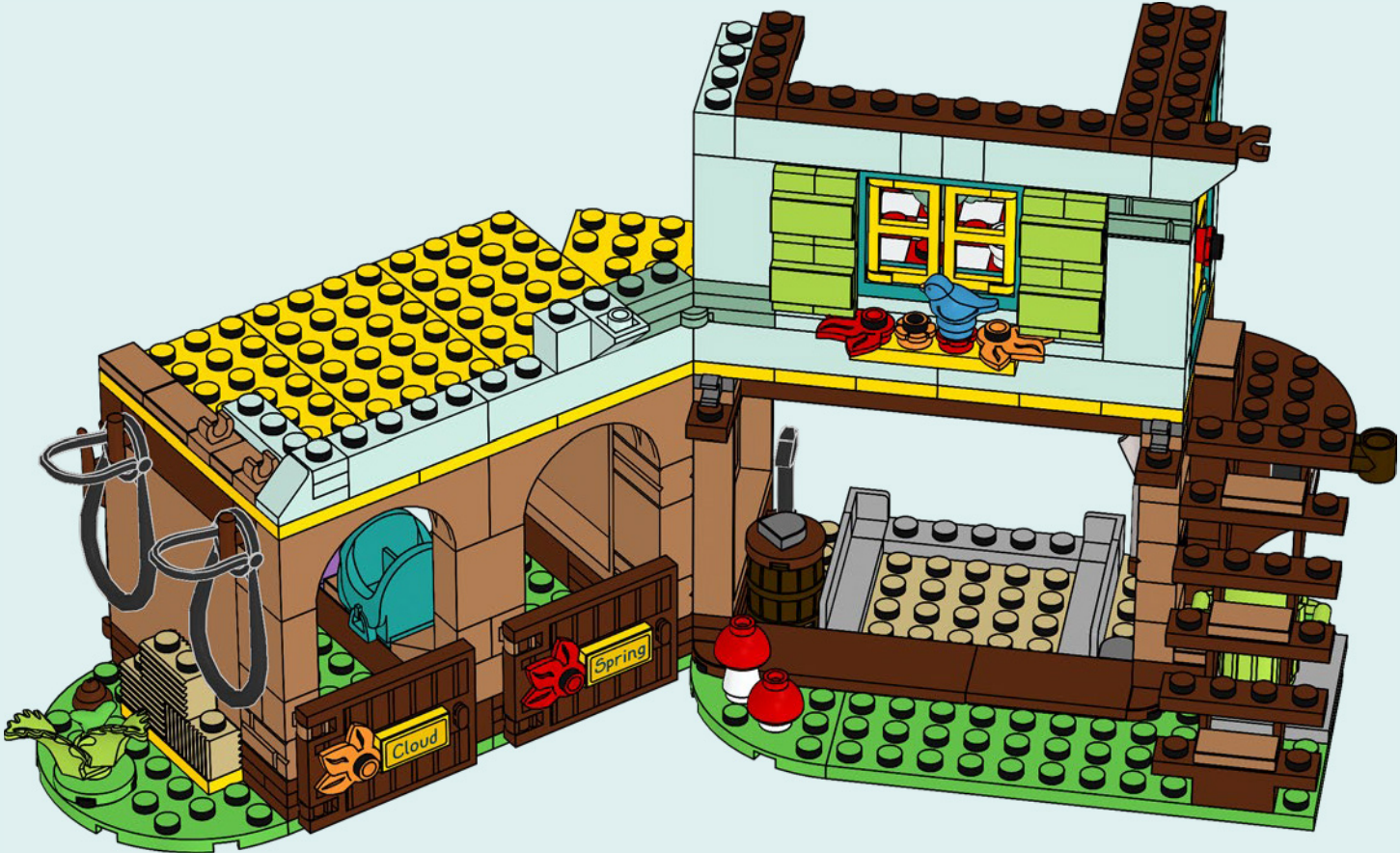

98

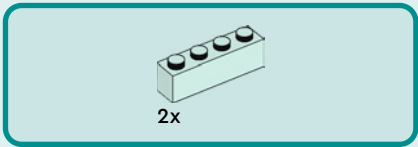

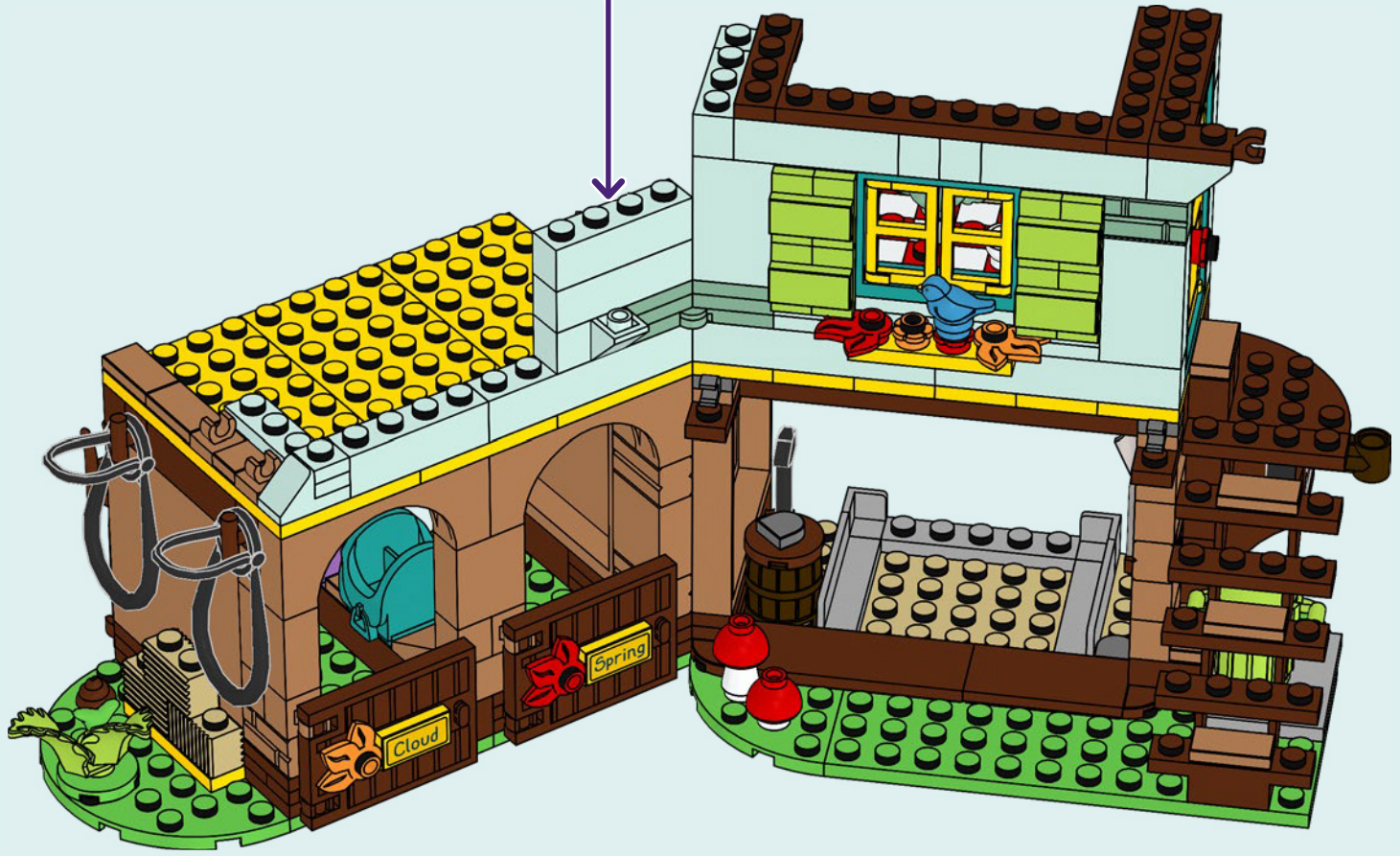
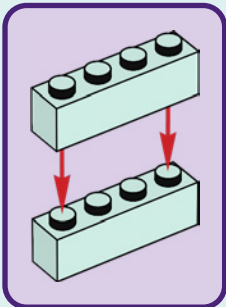

99



1x  1x 

100

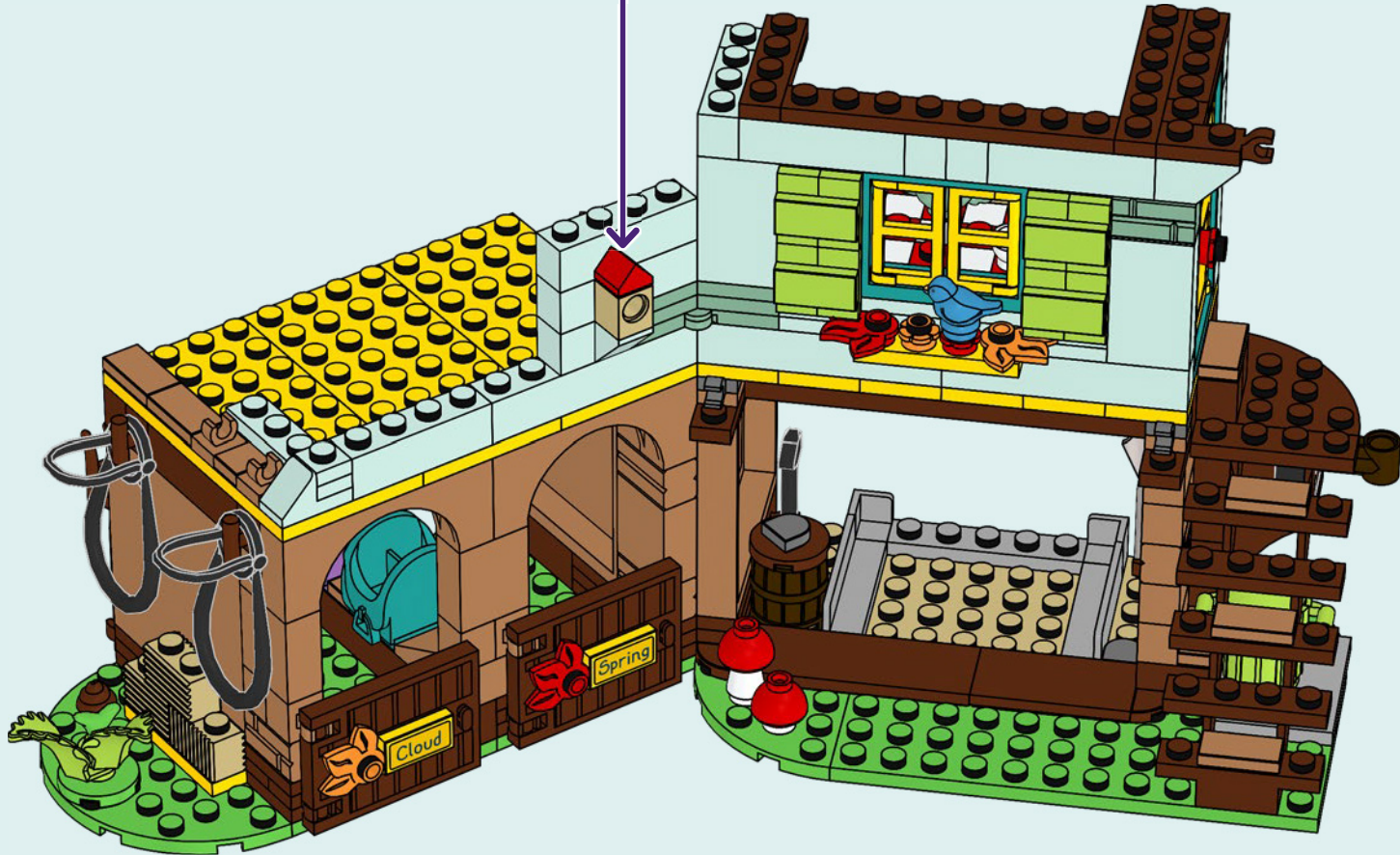
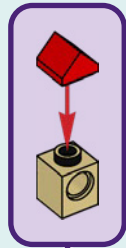

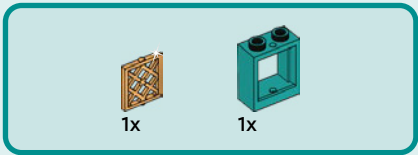

101

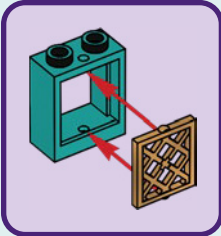

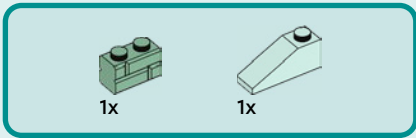

102

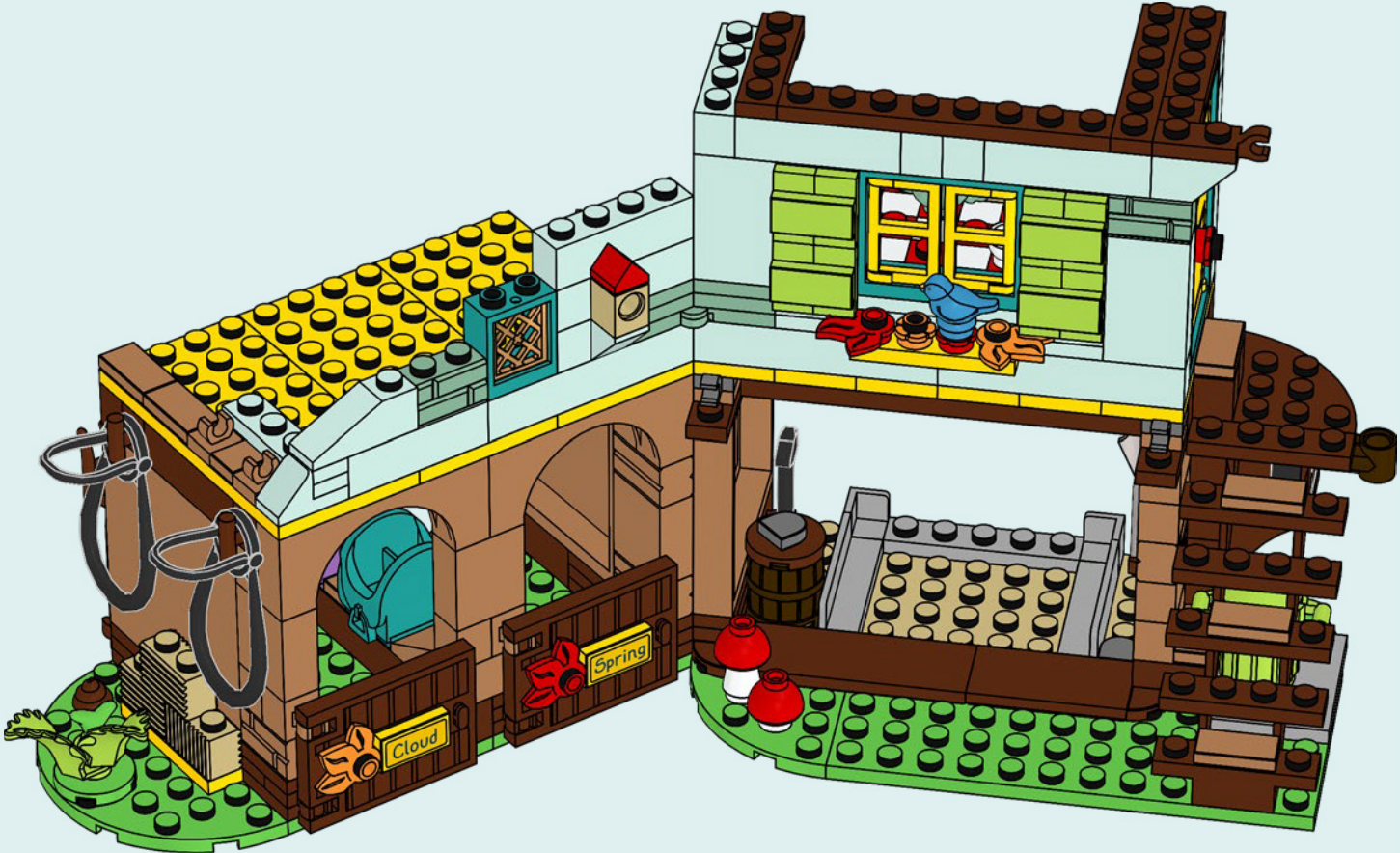

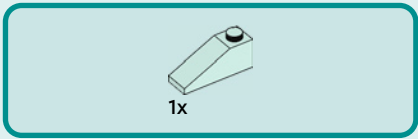

103

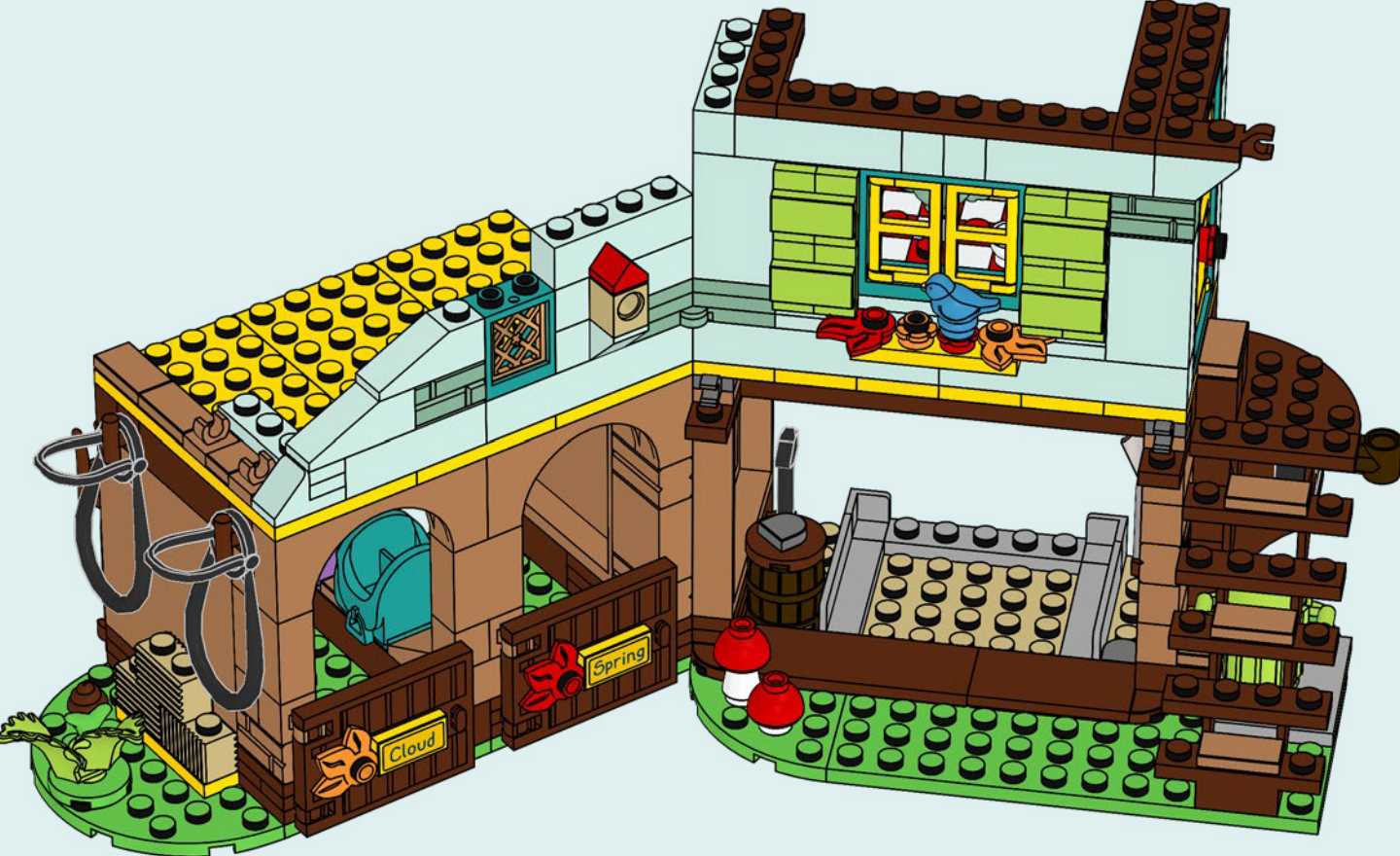

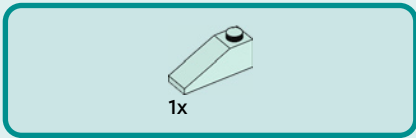

104

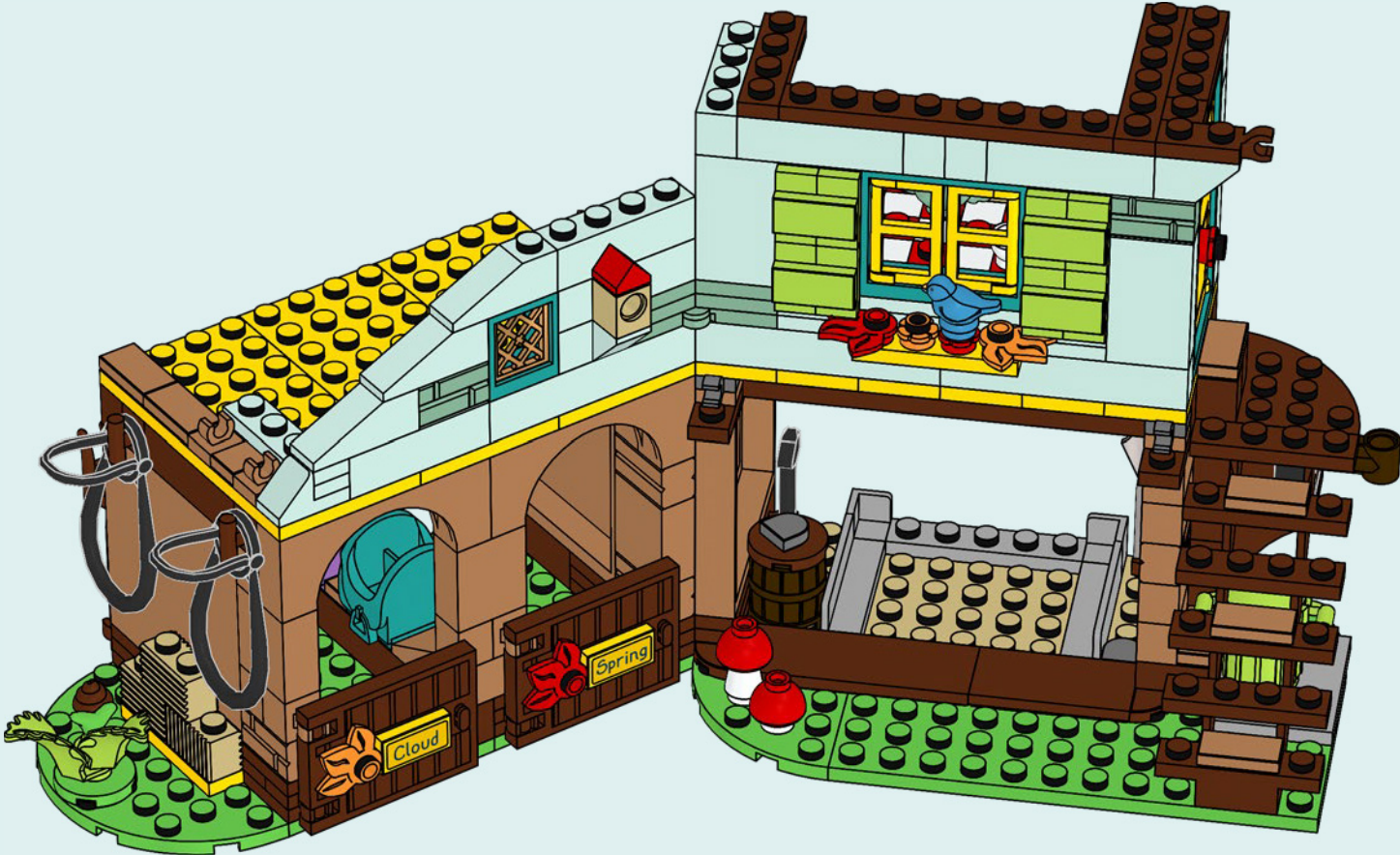

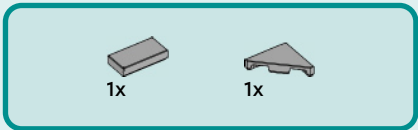

105



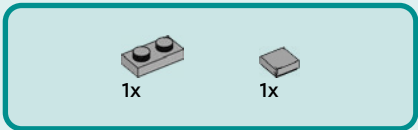

106





1x

107

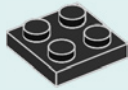

1x

108



1x



1x

109

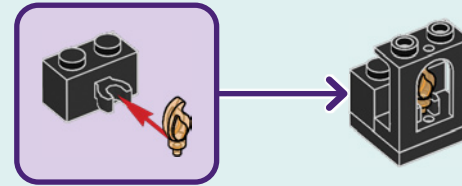

1x



1x

110

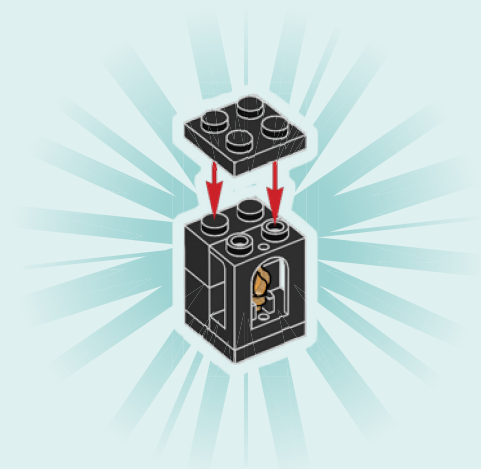

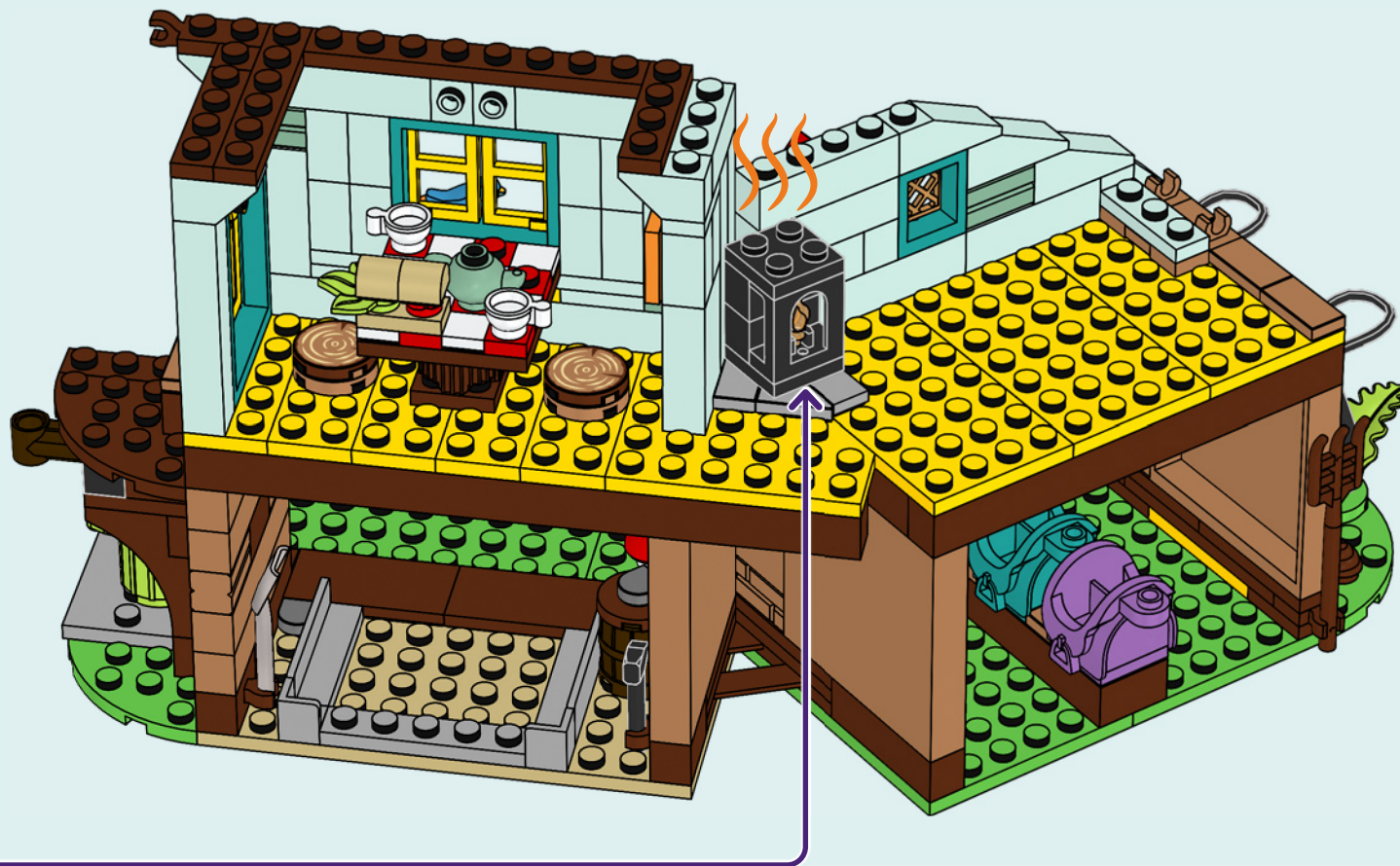



1x

112



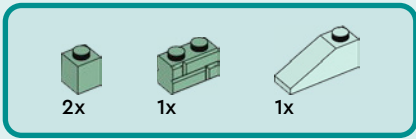

113





1x

114



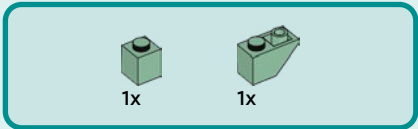

115





1x

116





117







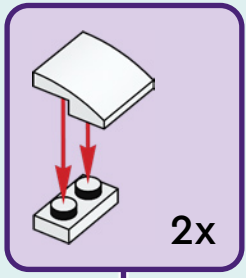

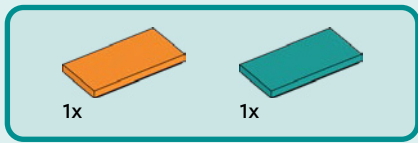
118



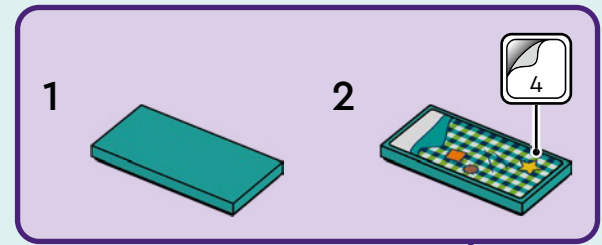
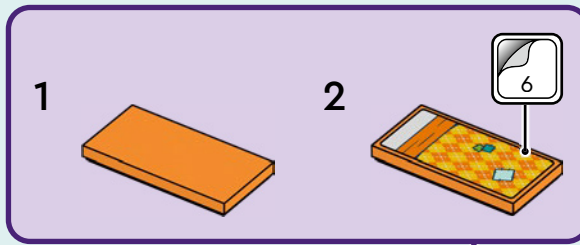

119



		
1x	1x	1x

120



1



2



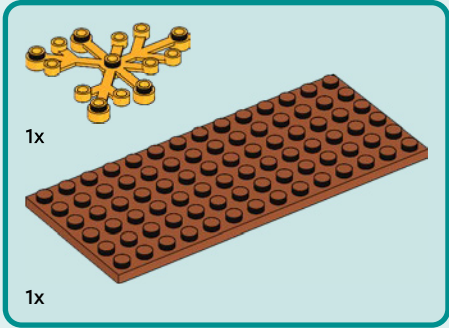

121

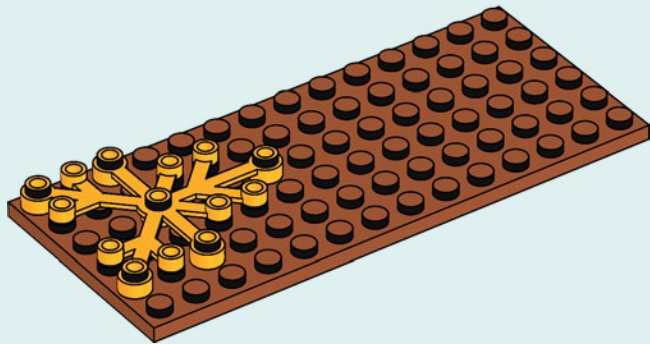

122

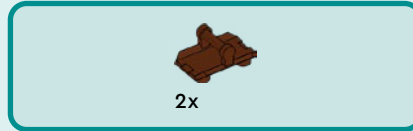
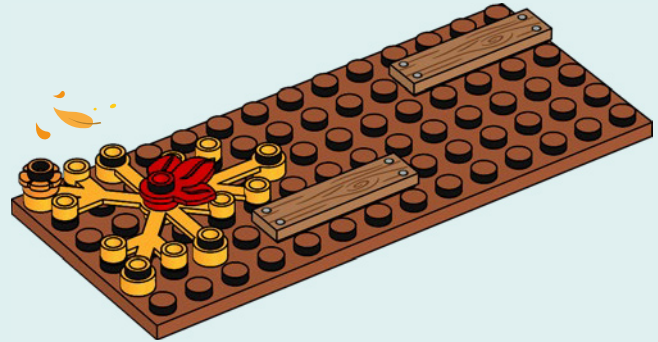

123

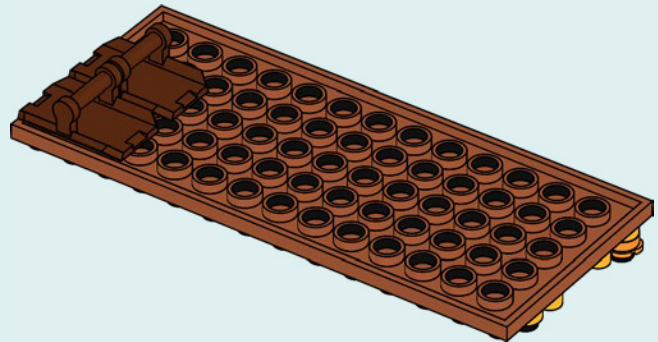
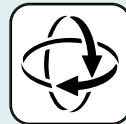

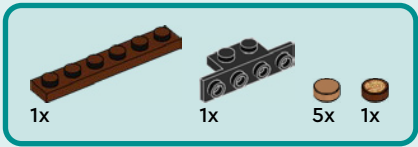

124

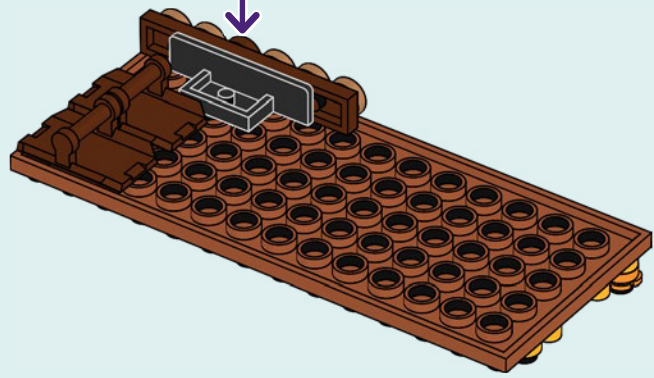
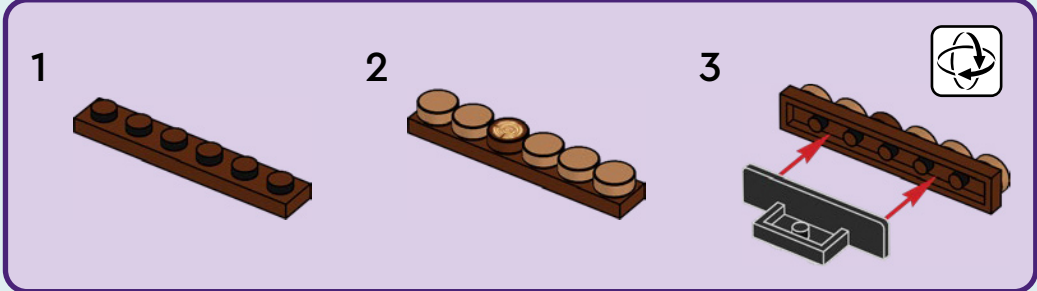

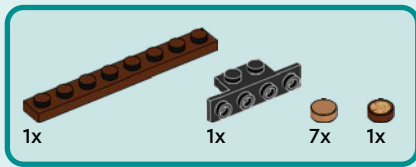

125

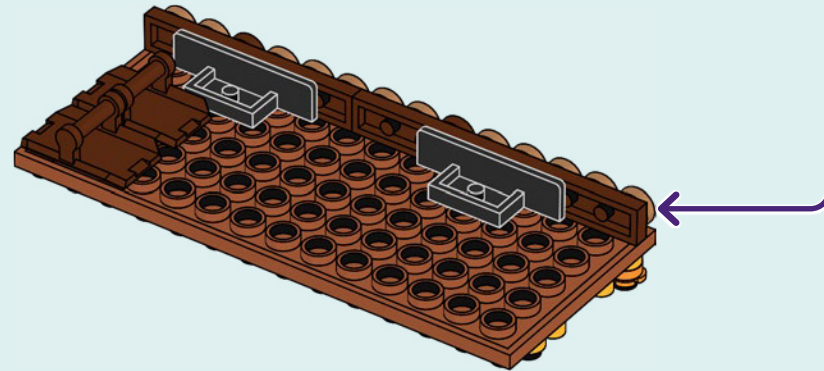
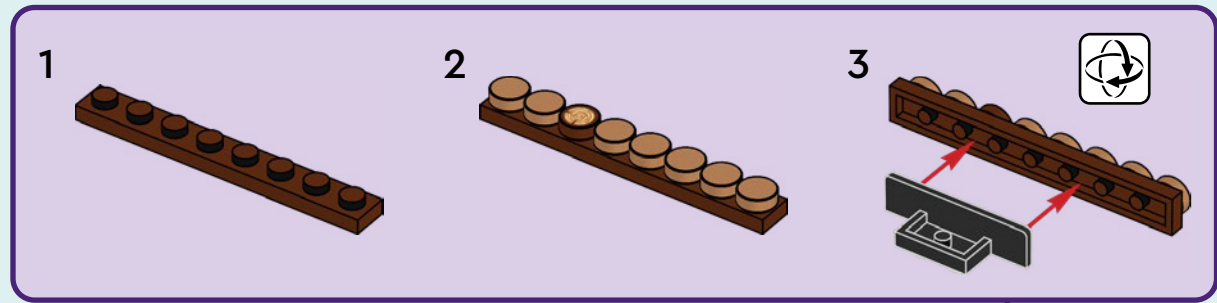

126

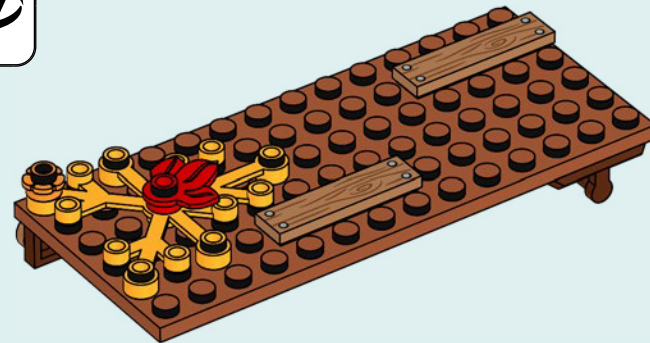
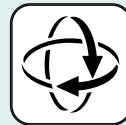

127







2x



4x



2x

128



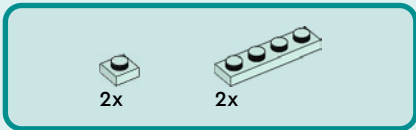

129



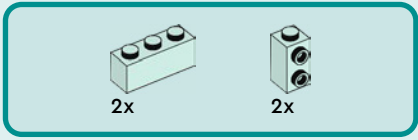

130

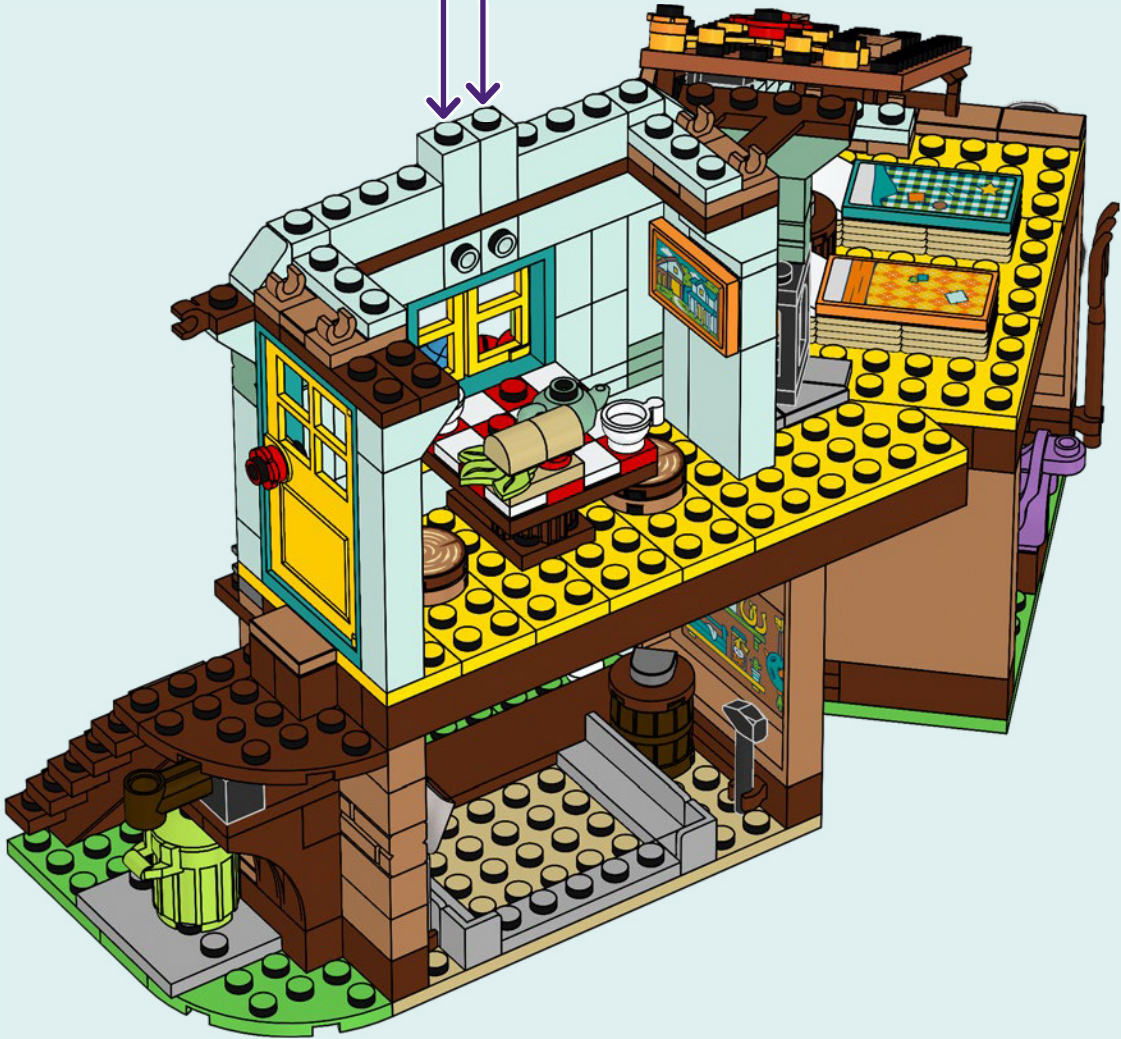
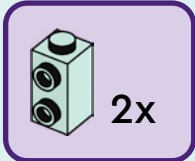



1x

131





1x



2x



2x

132





2x

133





1x



1x

134





1x



1x

135



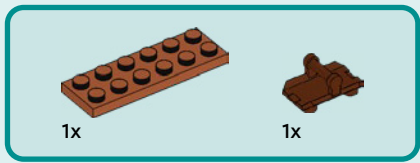

136

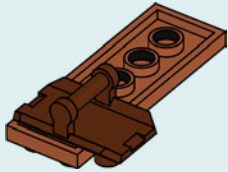

137

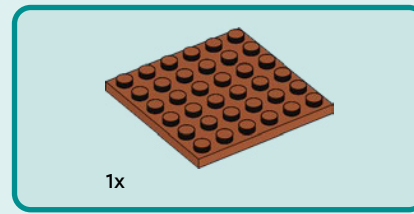
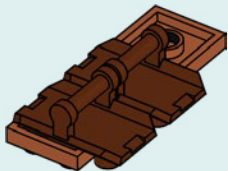

138

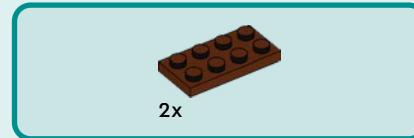
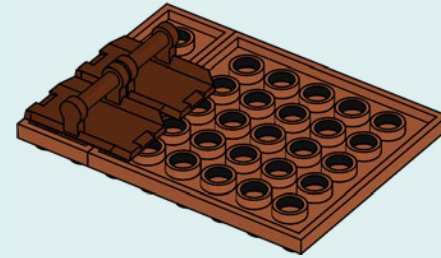

139

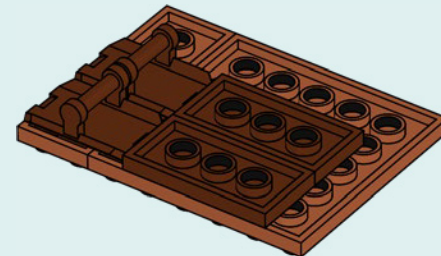



140

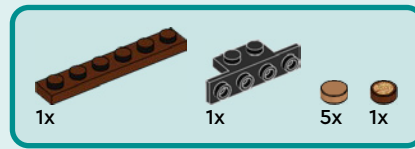
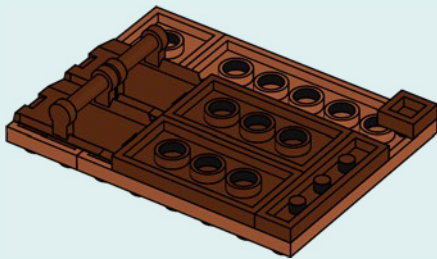

141

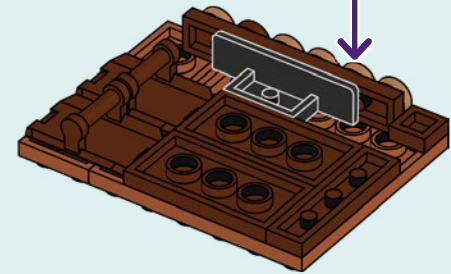
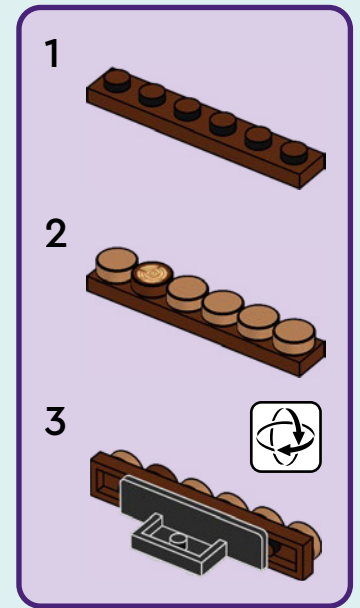



142

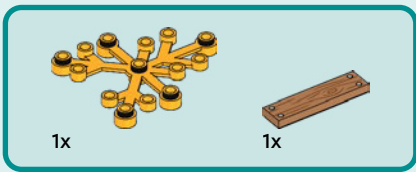



143



1x  1x 

144

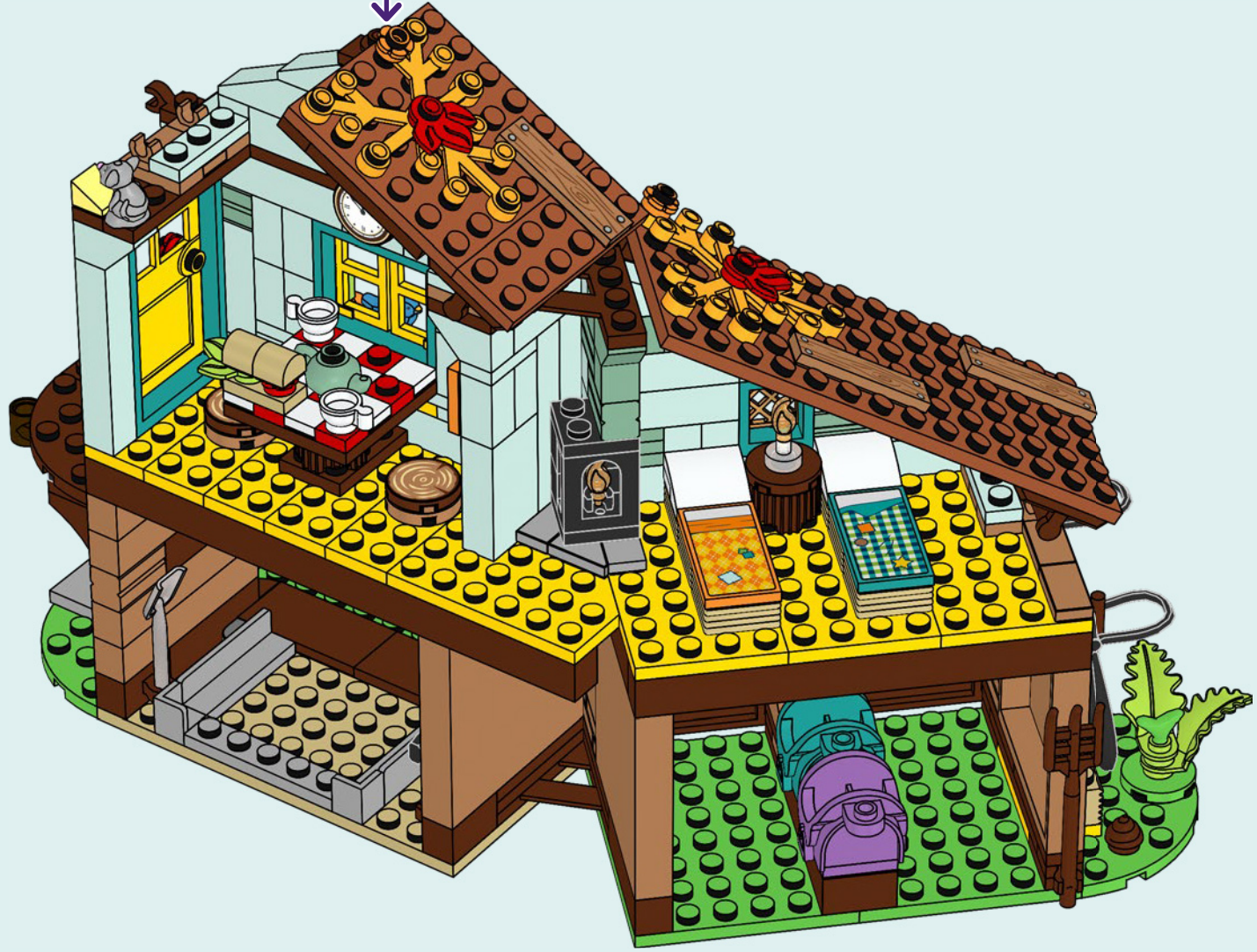

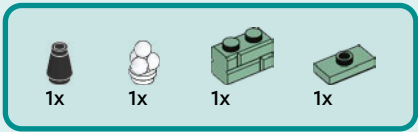

145

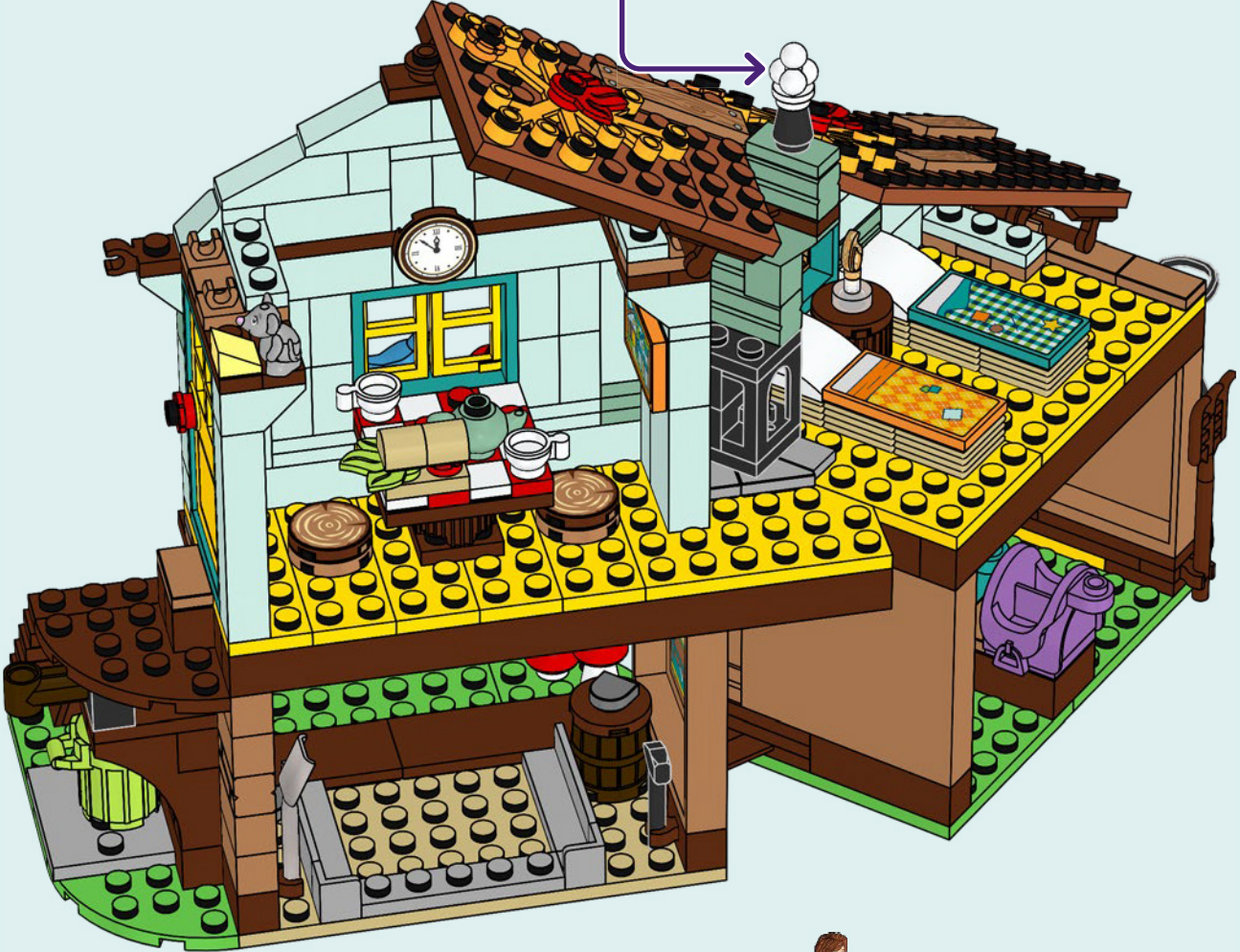
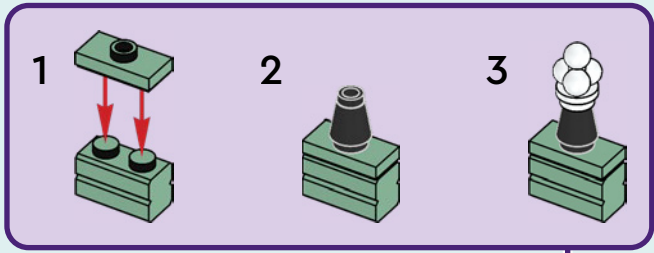

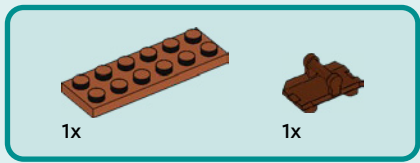

146



147

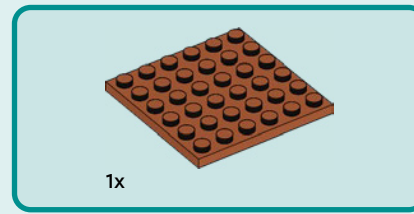
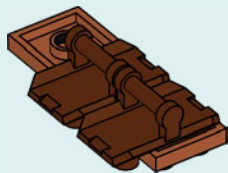

148

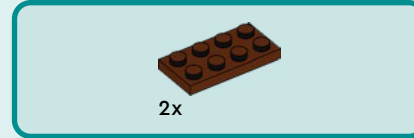
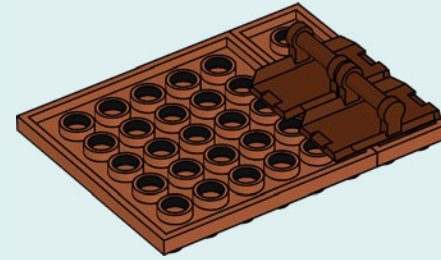

149





150

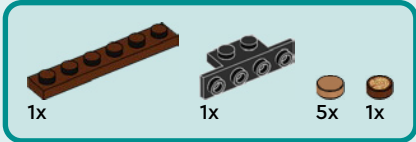
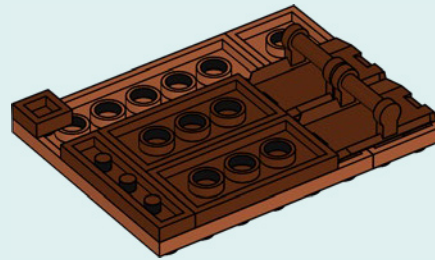

151

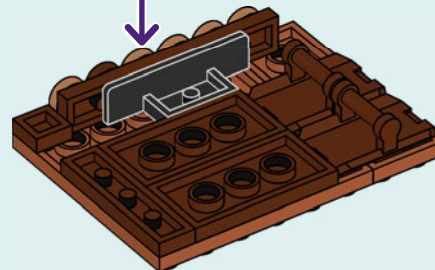
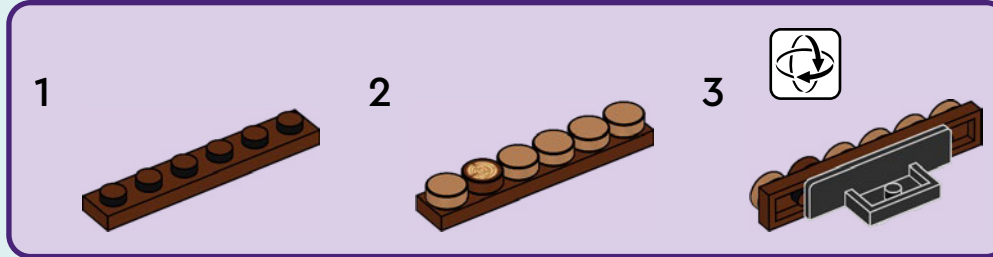

152

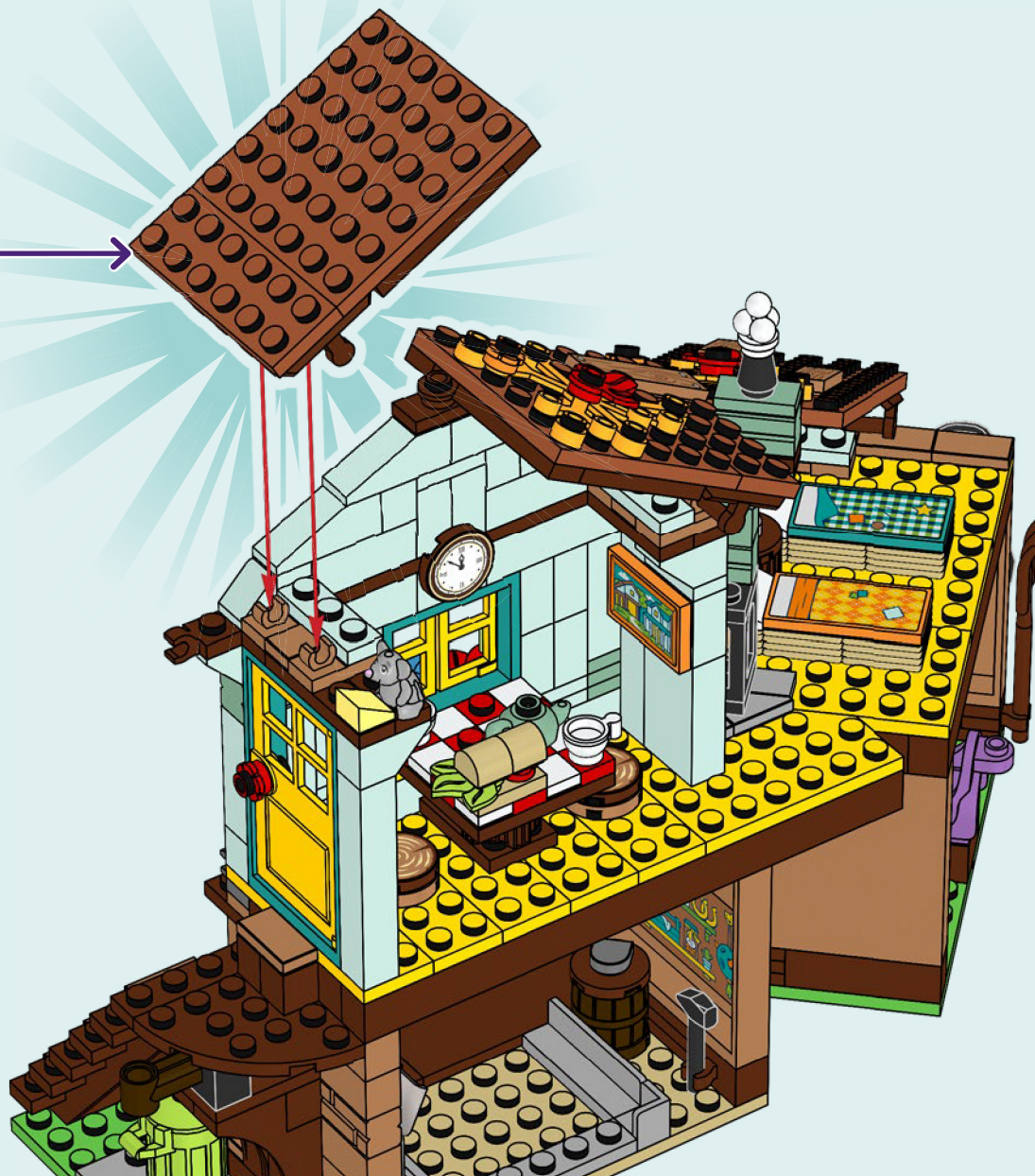

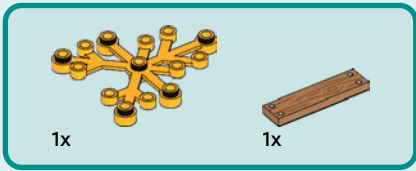

153





1x



1x

154



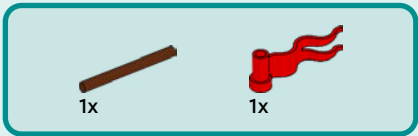

155

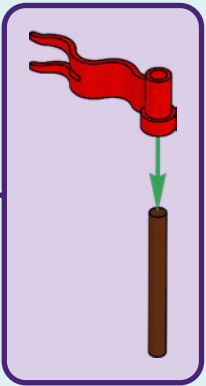



1x



1x

156

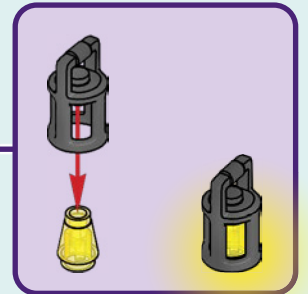

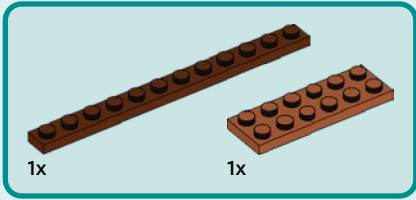
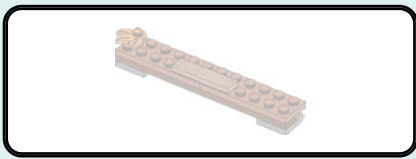

157

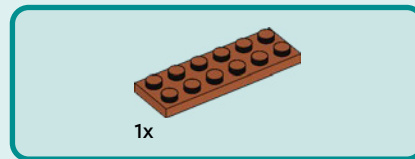
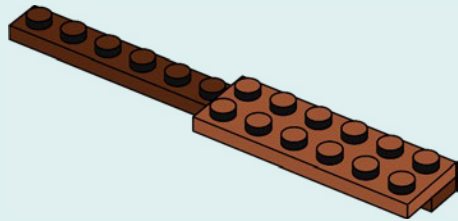

158

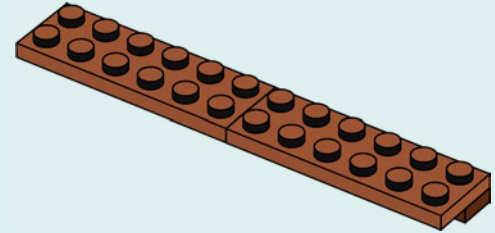

159

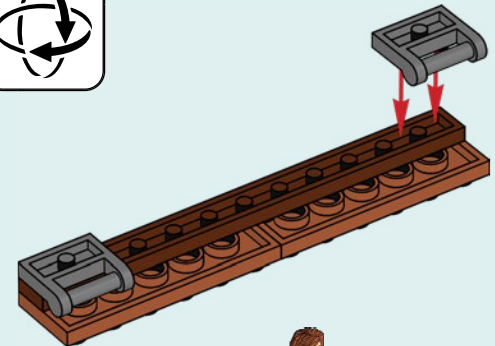
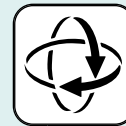

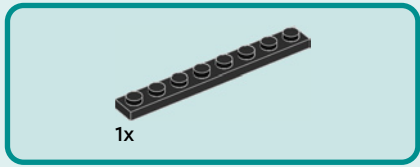

160

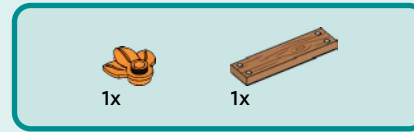
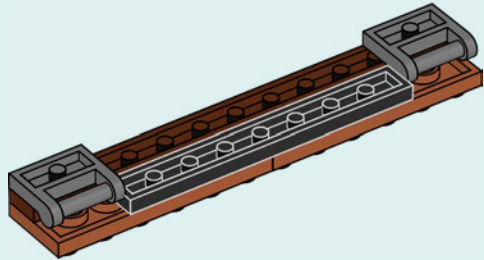

161

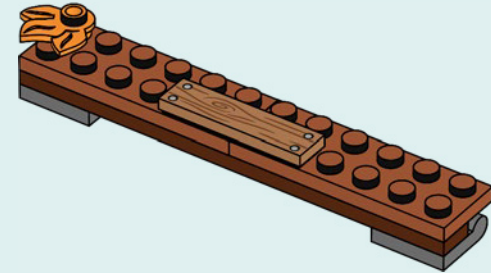
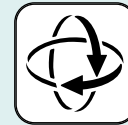

162



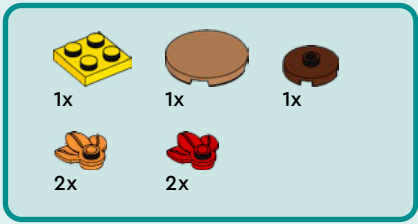

163

1



2

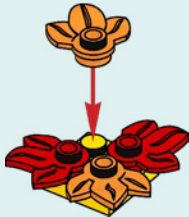

3



4



5





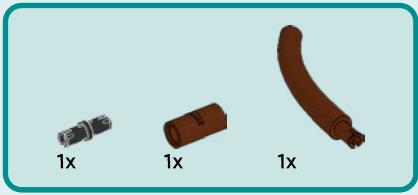

164

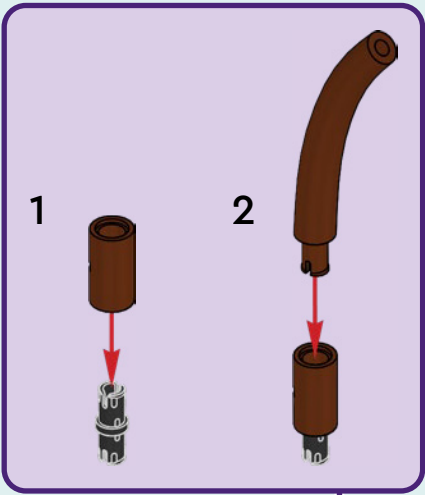

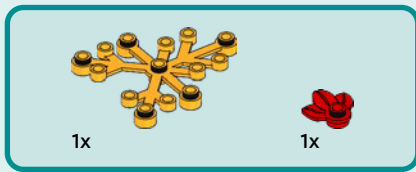

165

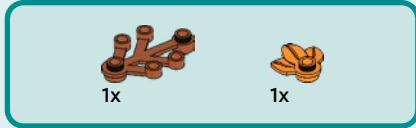
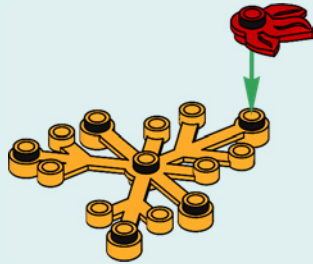

166

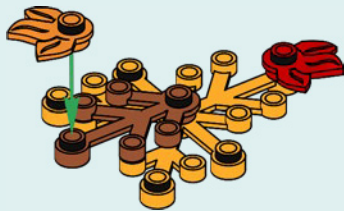

167

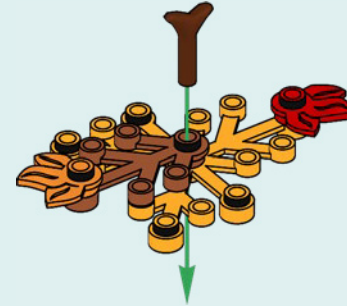

168

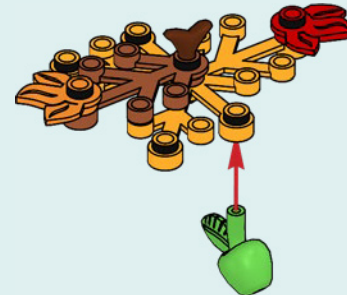



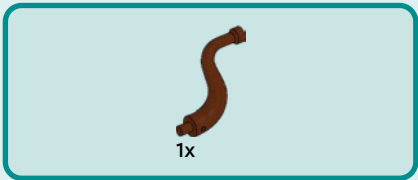

170



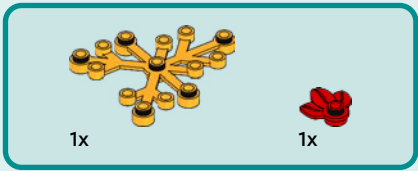

171

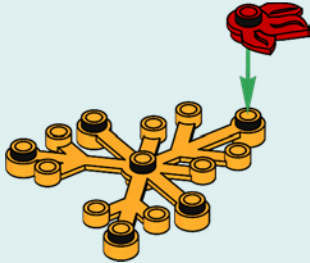

172

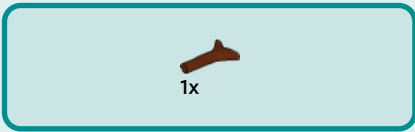
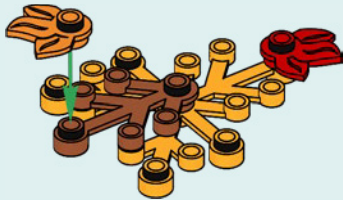

173

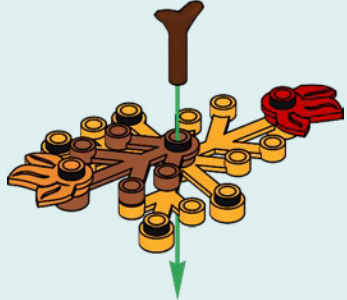

174

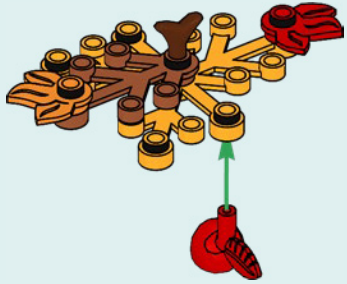

175



1

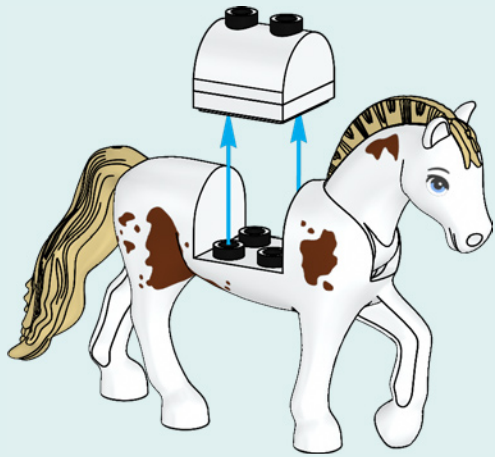

2



3

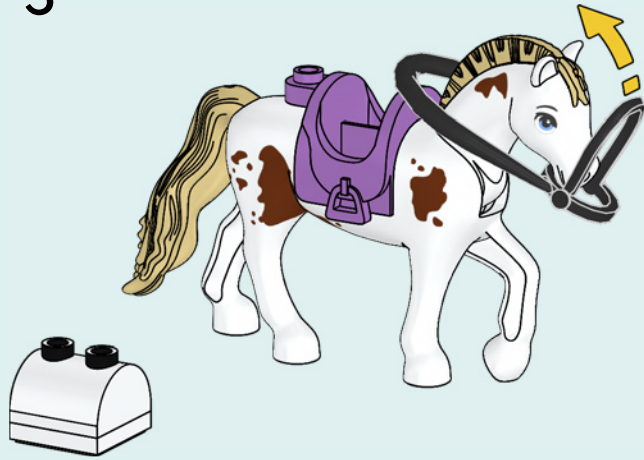

4







Friends

41731



41728



41743



41738



41730



- 1x 4518400
- 1x 614101
- 2x 625401
- 8x 307001
- 2x 6235083
- 1x 306901
- 2x 302301
- 2x 6047220
- 1x 6126046
- 1x 4624989
- 1x 4179771
- 2x 6286329
- 3x 4655900
- 1x 4113917
- 6x 6330903
- 1x 6185313
- 154
- 3x 6206148
- 1x 6003001
- 2x 6337734
- 8x 302421
- 1x 6224794
- 1x 6054438
- 10x 6372723
- 1x 4142865
- 1x 362221
- 1x 6268946
- 2x 6171059
- 2x 306924
- 2x 6337231
- 4x 4141630
- 2x 242024
- 1x 302224
- 1x 4528550
- 2x 302024
- 5x 379524
- 1x 6438448
- 3x 303524
- 1x 4529236
- 1x 6279875
- 1x 6178922
- 1x 300426
- 1x 6330197
- 1x 6398861
- 2x 302226
- 1x 452226
- 2x 362326
- 5x 6168620
- 1x 302026
- 2x 4599734
- 1x 346026
- 1x 6284697
- 1x 6435142
- 1x 6435141
- 1x 6099370
- 1x 6296498
- 1x 4107050
- 1x 6380676
- 3x 4119479
- 1x 6294513
- 1x 6282120
- 2x 6141590
- 2x 6070506
- 1x 6399741
- 2x 6133847
- 2x 6340684
- 1x 6438485
- 1x 6406094
- 1x 6409765
- 2x 6022079
- 2x 6253418
- 5x 6219673
- 2x 6310668
- 1x 6440669
- 1x 6186867
- 1x 6240225
- 4x 6214234
- 9x 6253884
- 1x 6103249
- 1x 6293710
- 2x 4648853
- 1x 6240515
- 1x 6382739
- 2x 6210775
- 2x 6223665
- 1x 6290269
- 1x 6440111
- 1x 6222972
- 1x 6438775
- 1x 6223065
- 1x 6435011
- 1x 6337597
- 1x 6286831
- 4x 6438450
- 1x 6121816
- 8x 6092592
- 4x 4500125
- 1x 6370087
- 1x 6435135
- 3x 4521948
- 1x 6411592
- 6x 6075617
- 2x 6184432
- 4x 4655080
- 1x 4623297
- 1x 6416689
- 2x 6357747
- 1x 6097098
- 5x 6273388
- 5x 6285623
- 1x 6215659

- 1x 6275030
- 4x 4221744
- 1x 6348057
- 2x 6149677
- 2x 6170570
- 3x 6337003
- 2x 6036503
- 2x 6182435
- 1x 6157942
- 3x 6102360
- 2x 6078605
- 4x 6092590
- 1x 6311210
- 2x 6133860
- 2x 6330202
- 8x 4211150
- 2x 4211149
- 1x 6173132
- 1x 6382326
- 1x 6338135
- 1x 4211257
- 3x 4211200
- 2x 4211210
- 2x 4211210
- 1x 6196221
- 7x 6328480
- 2x 6055086
- 1x 6326087
- 1x 6116613
- 2x 4211189
- 2x 4211279
- 10x 4211190
- 2x 4211225
- 2x 6438484
- 1x 4211201
- 1x 4579690
- 4x 4211186
- 2x 6084573
- 5x 4221590
- 1x 4211193
- 1x 4243838
- 1x 4636170
- 1x 6270119
- 1x 6326103
- 1x 4216615
- 1x 4277751
- 4x 4216945
- 2x 4222627
- 1x 6055145
- 1x 6258989
- 1x 6435137
- 1x 4211503
- 1x 4211415
- 2x 4215513
- 1x 4211398
- 1x 4211414
- 1x 6217876
- 2x 6371448
- 2x 6071299
- 1x 6372029
- 1x 6079461
- 3x 6362252
- 1x 6245283
- 2x 6360111
- 2x 6146321
- 1x 4211094
- 1x 6416668
- 1x 6439800
- 1x 6295686
- 1x 6023826
- 1x 6332586
- 1x 6278987
- 1x 6409768
- 27x 6284589
- 6x 6383946
- 4x 6057986
- 3x 6215606
- 3x 6360035
- 2x 6167643
- 16x 6021997
- 8x 4656783
- 7x 6347304
- 3x 6401021
- 2x 6177535
- 1x 6351381
- 1x 6102994
- 1x 6326106
- 1x 6347842
- 7x 6329605
- 4x 6099341
- 2x 6106193
- 3x 6313598
- 1x 6210601
- 1x 6234116
- 1x 6287960
- 1x 6416663
- 1x 6440425
- 4x 6236576
- 12x 6356101
- 2x 4619815
- 3x 6058016
- 1x 4616211
- 6x 6146701
- 3x 6441412
- 4x 6306030
- 6x 6141592
- 10x 6438447
- 2x 6298819
- 3x 6328085
- 3x 6295228
- 5x 6218162
- 3x 6227921
- 1x 6440194
- 1x 6177195
- 1x 6356469



