



SPORTS

3540



3540



3541



3542



3543

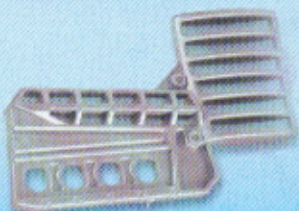

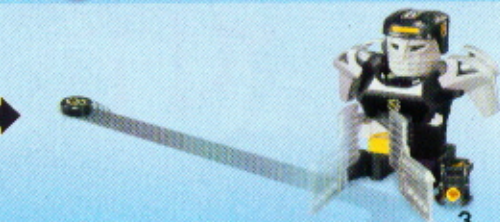
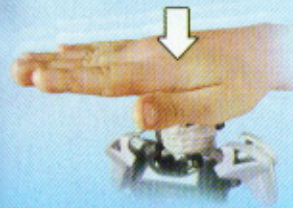
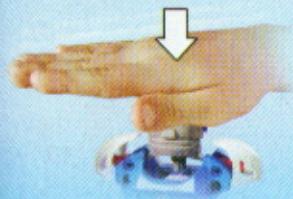
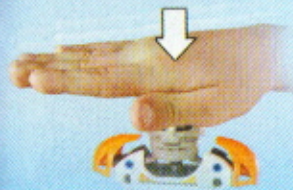
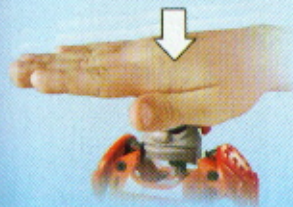

3540 Puck Passer



3541 Slap Shot



3542 Flip Shot



3543 Slammer Goalie



3544 Game Set



3545 Puck Feeder



1

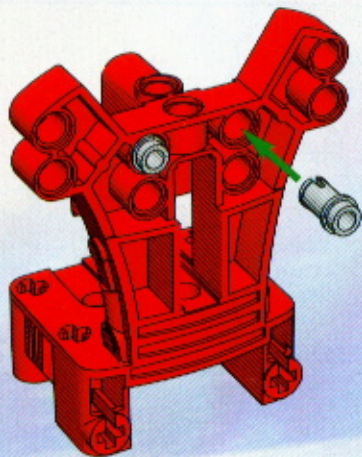

2

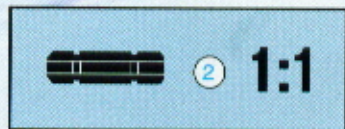
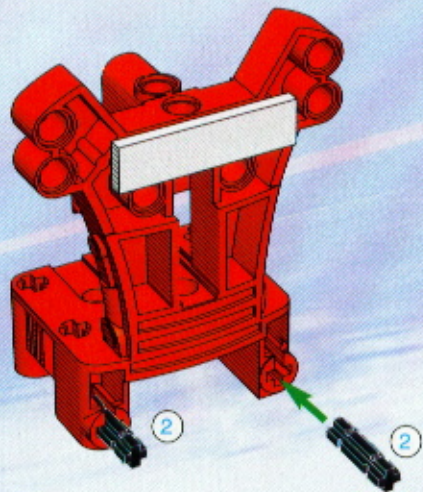

3

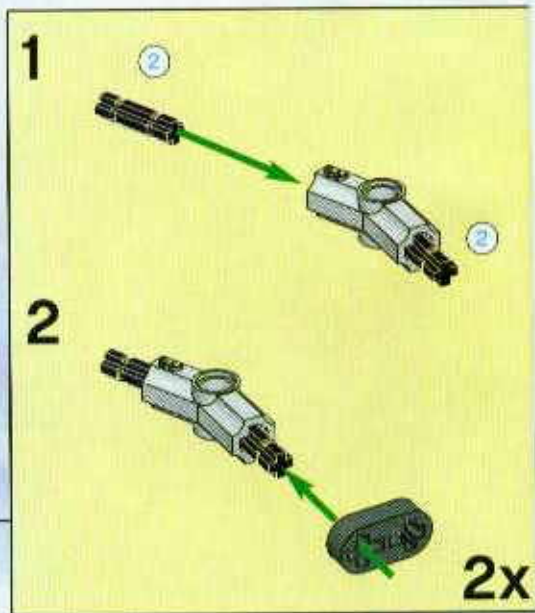
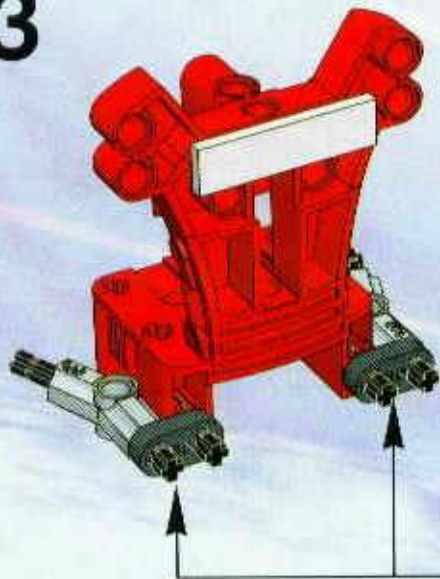

4

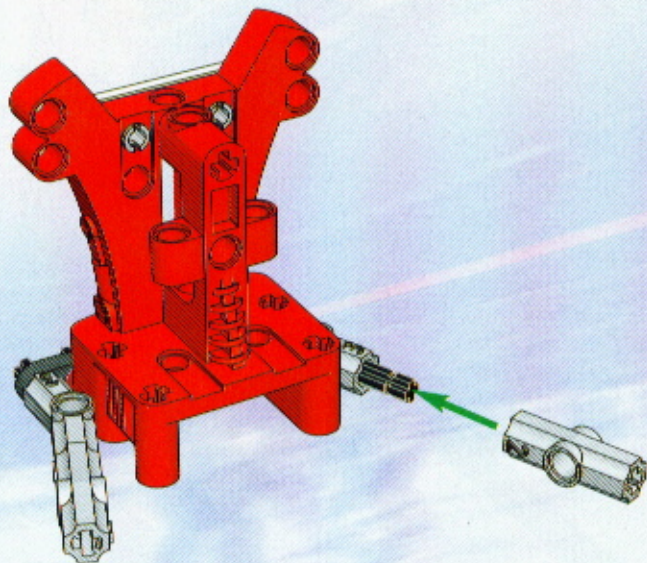

5

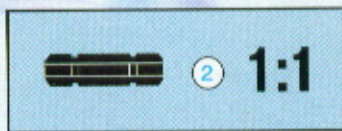
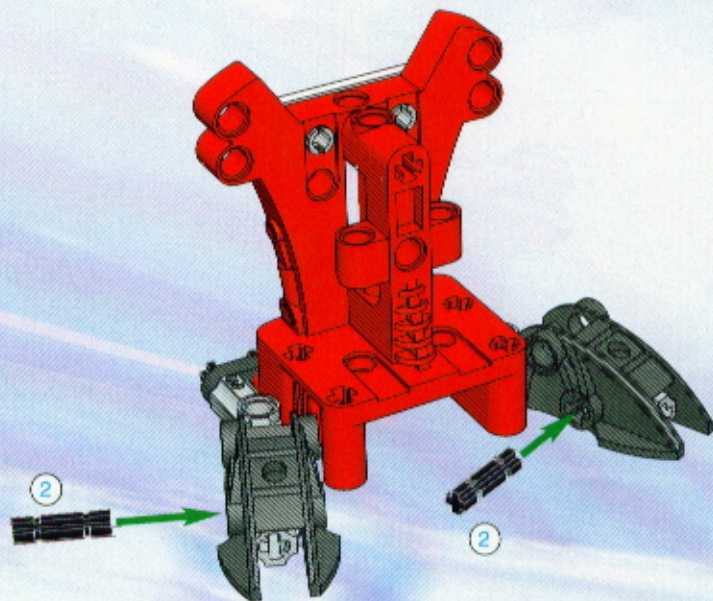

6

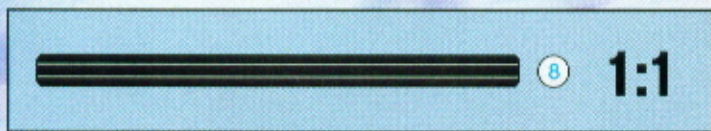
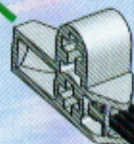
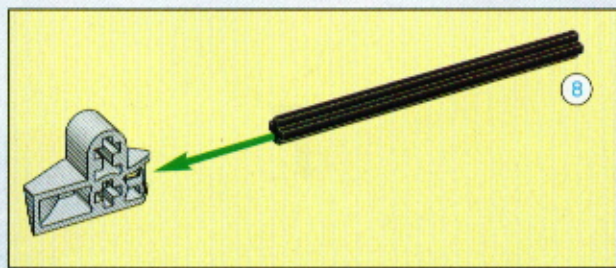
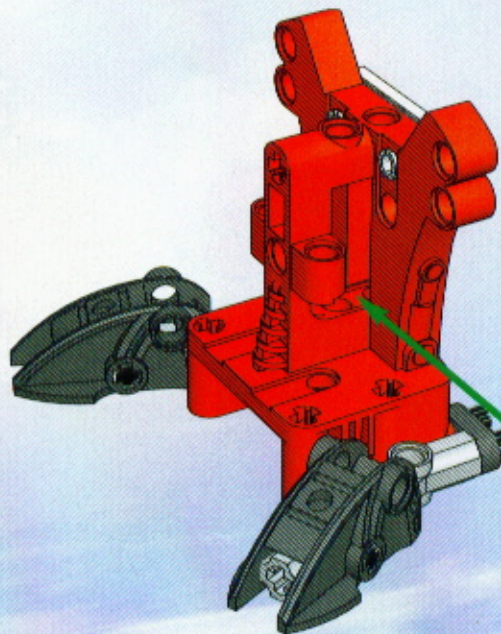

7

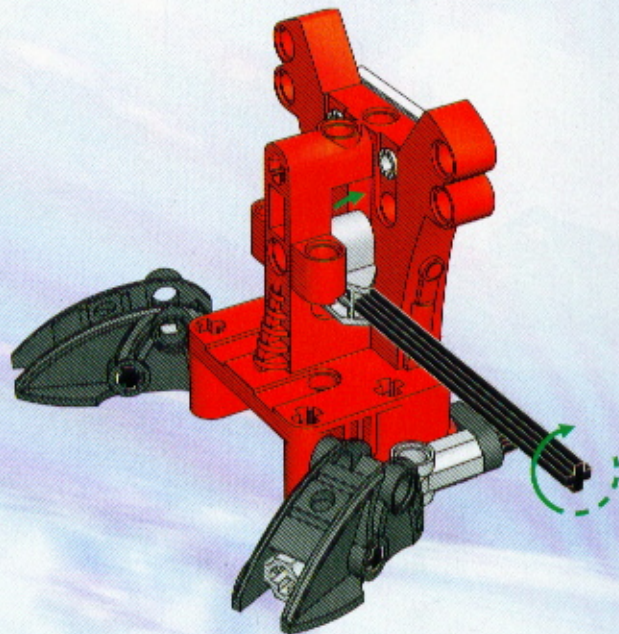

8

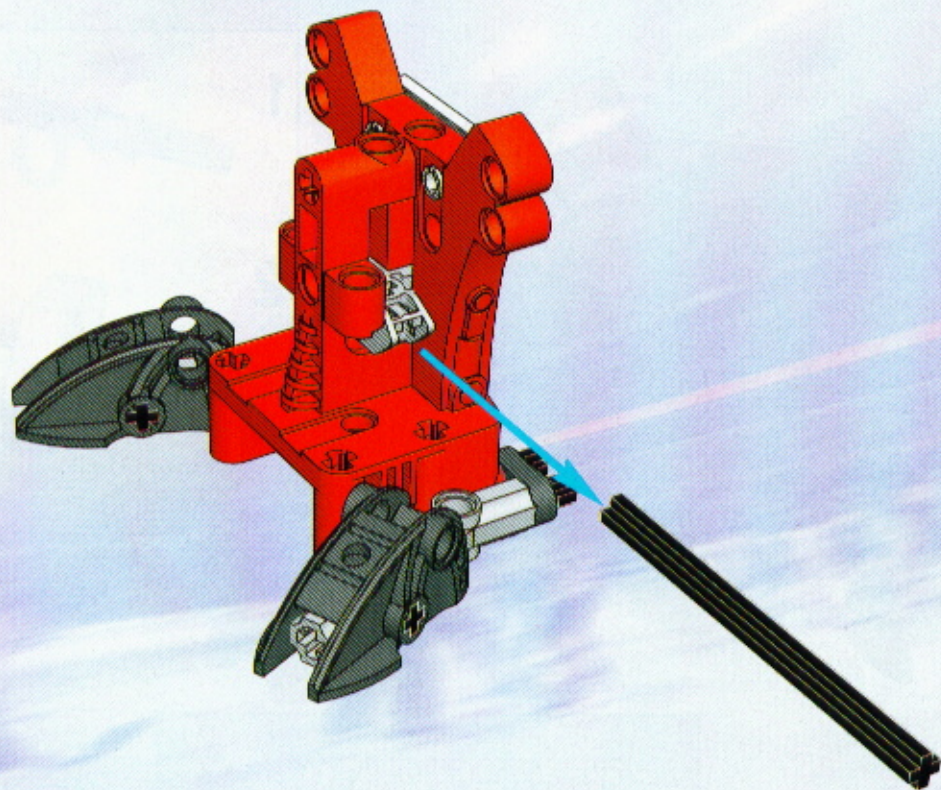

9

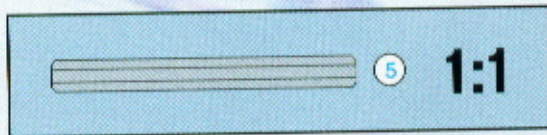
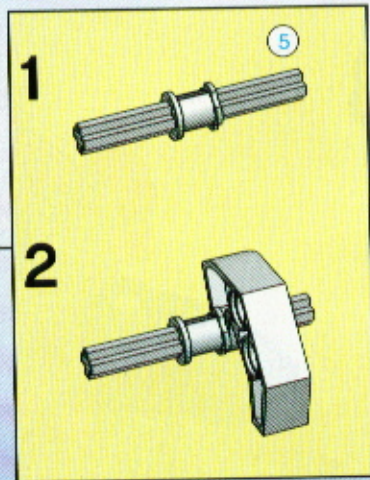
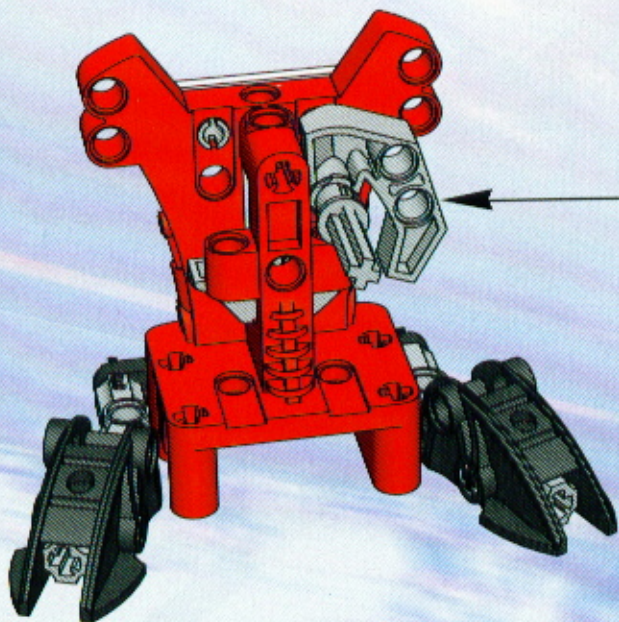

10

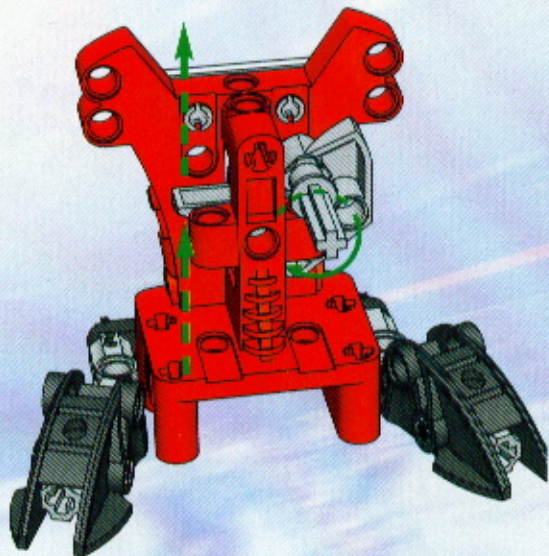

11

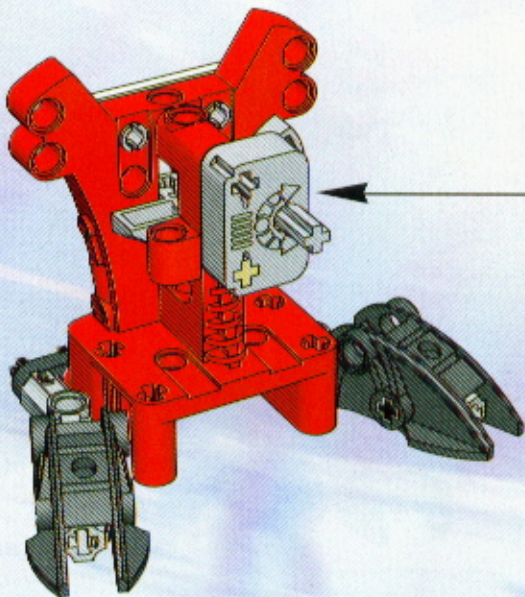

12

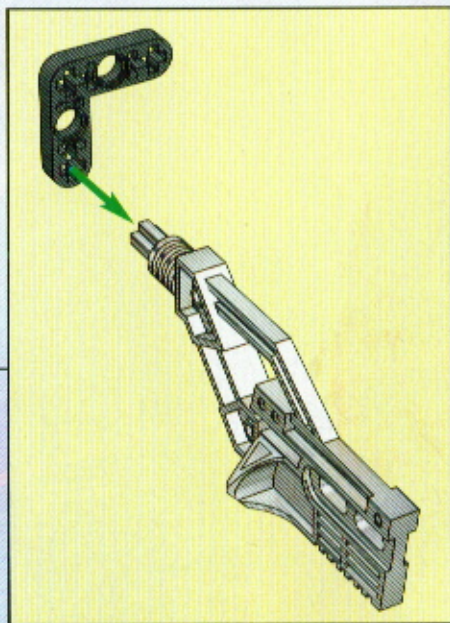
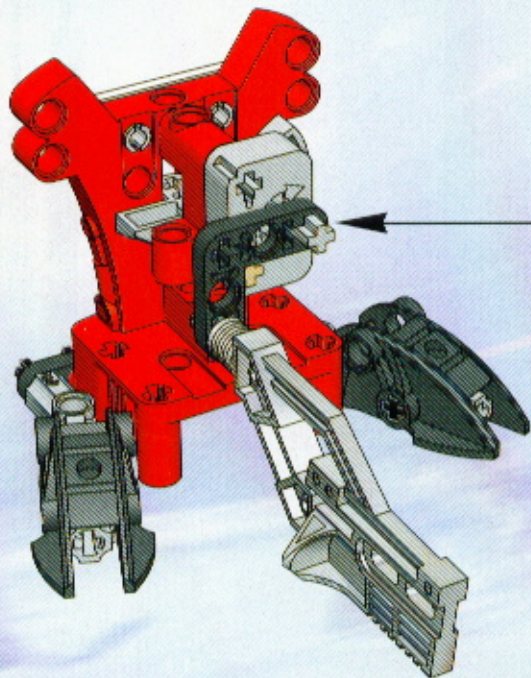

1

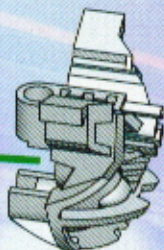
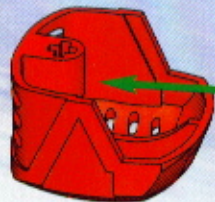

2

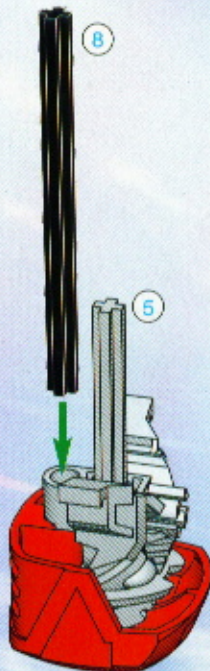

3

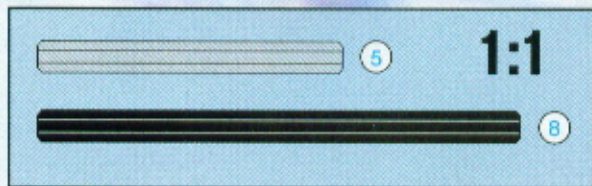
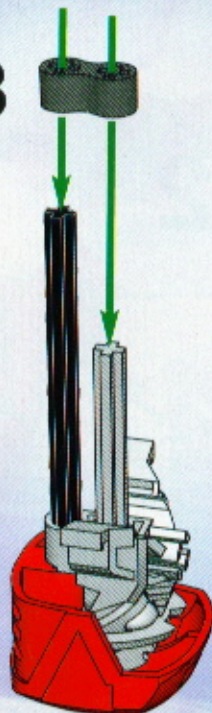

13

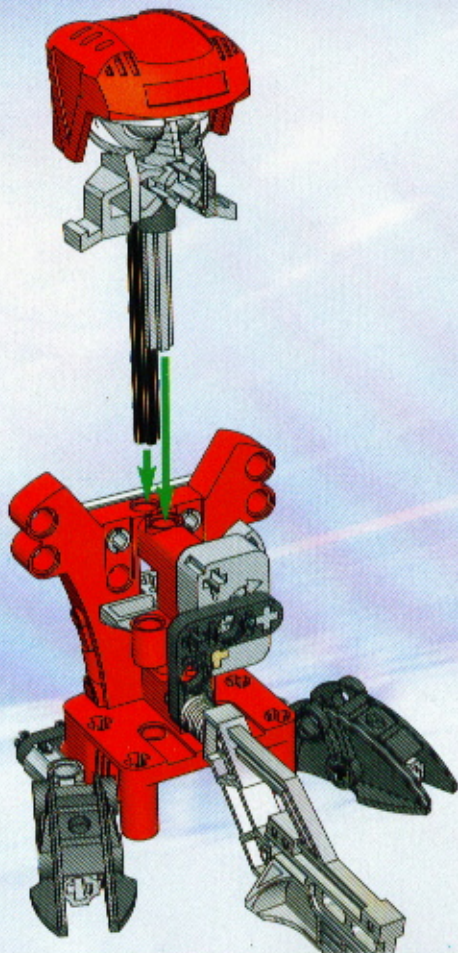

14

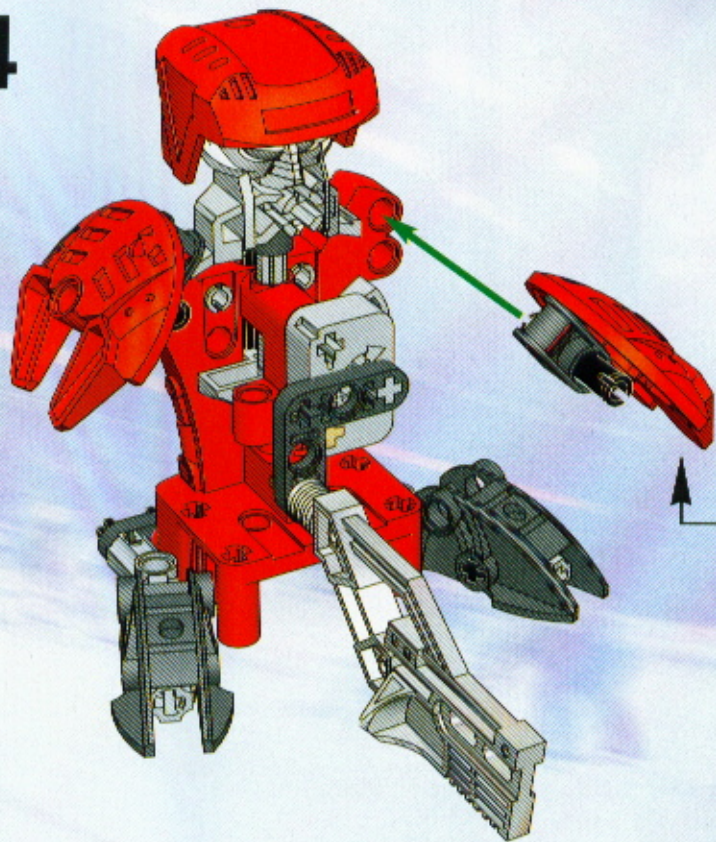

1

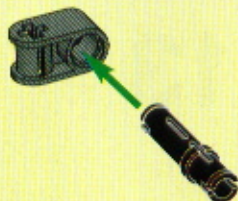

2

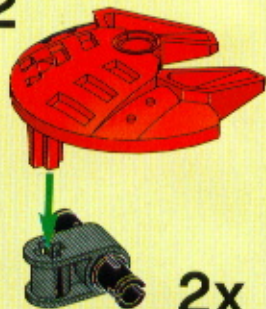

2x

15

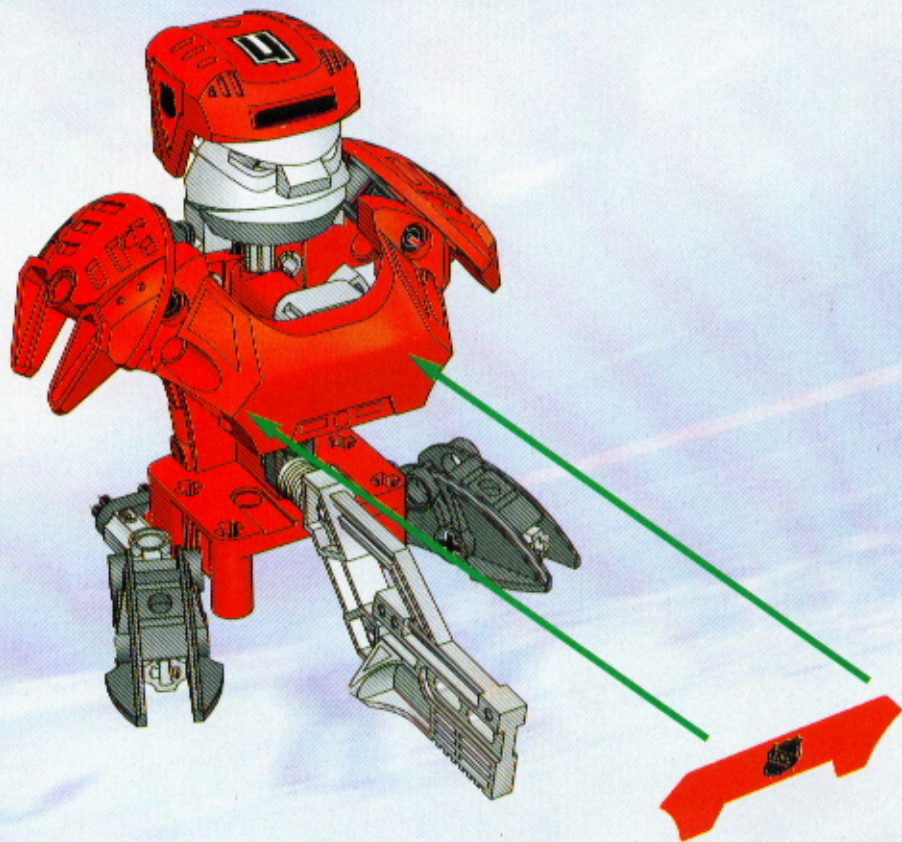

16

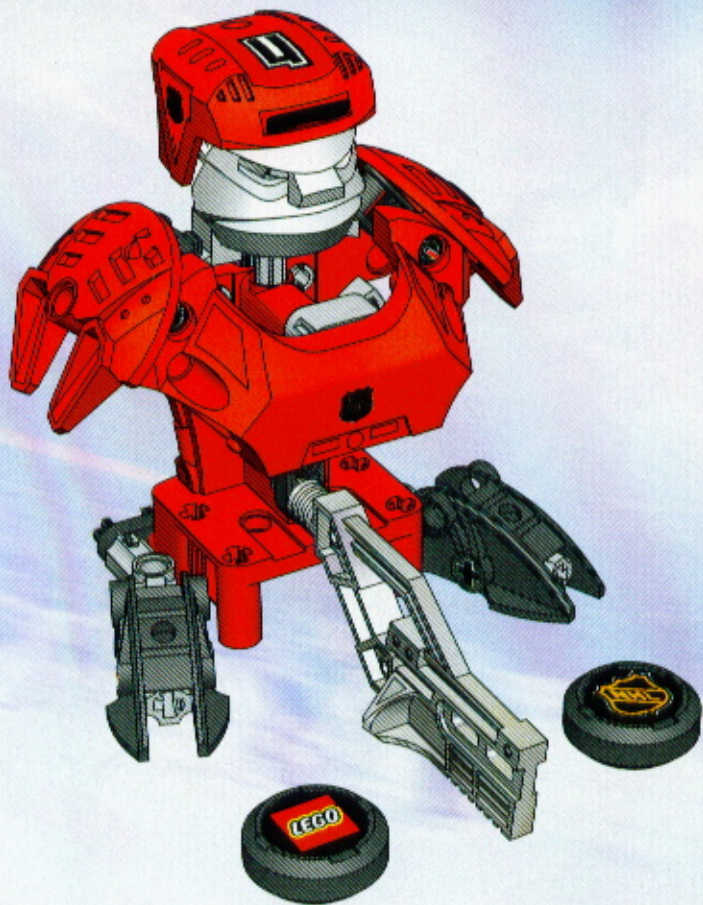



LEGO



www.LEGO.com/sports

nhlpa
.COM



.COM

LEGO, the LEGO logo and the Minifigures are trademarks of the LEGO Group.
©2000 The LEGO Group.

NHL and the NHL Shield are registered trademarks of the National Hockey League. All NHL logos and marks and team logos and marks depicted herein are the property of the NHL and the respective teams and may not be reproduced without the prior written consent of NHL Enterprises, L.P. © NHL 2003. All Rights Reserved.

© NHLPA, NHLPA, National Hockey League Players' Association and the NHLPA logo are trademarks of the NHLPA.





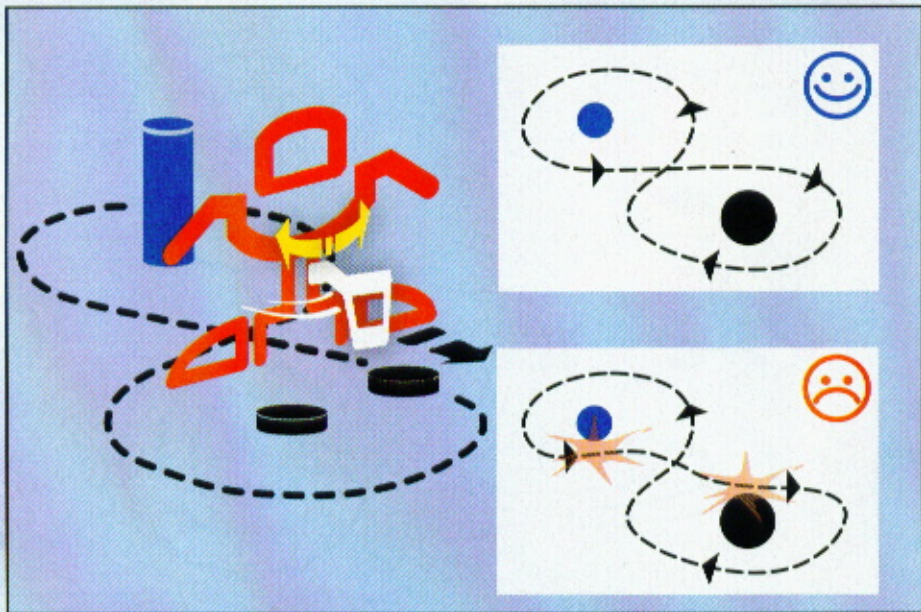

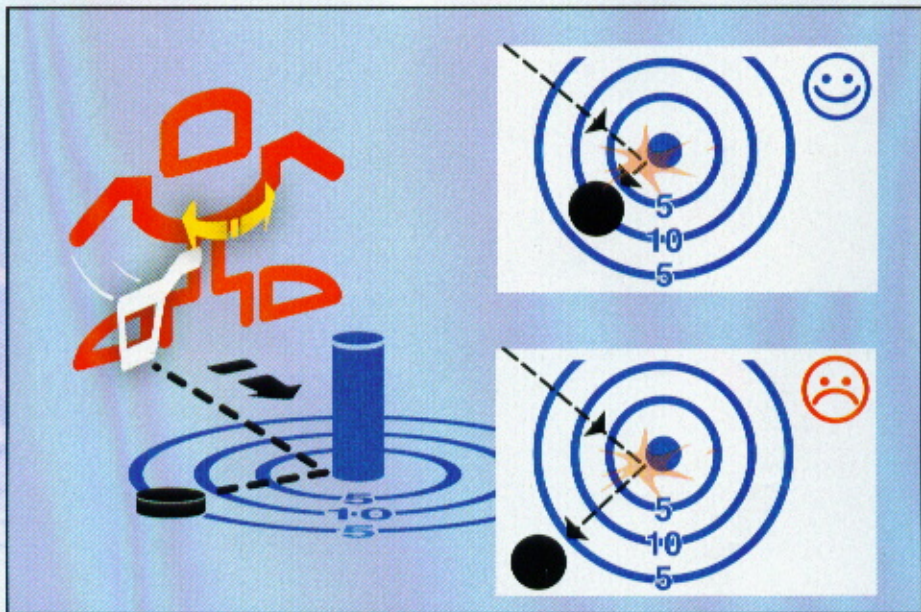

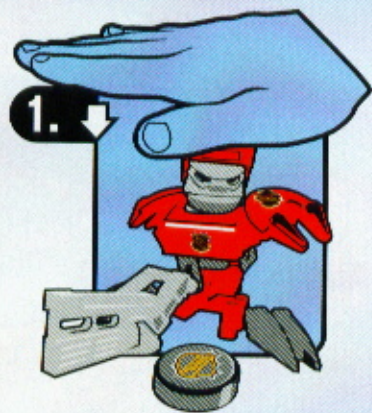

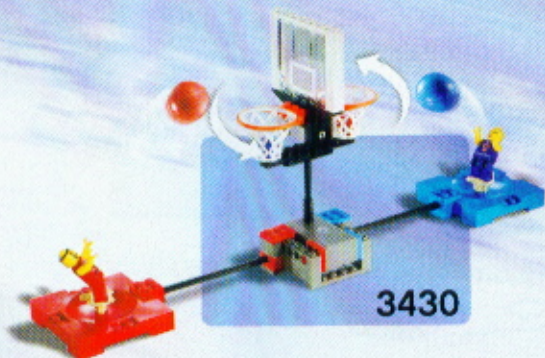
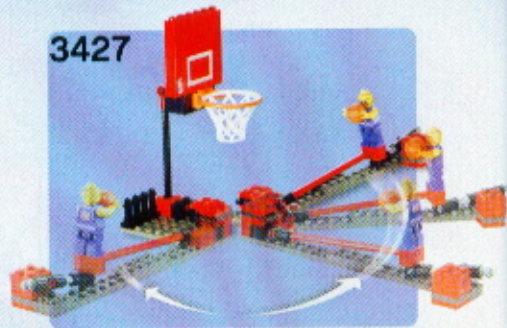



3428



3429



3433

3560



3561



3562



3563



3564



3565



3566



3567





3420

3421



3422



3424



3423

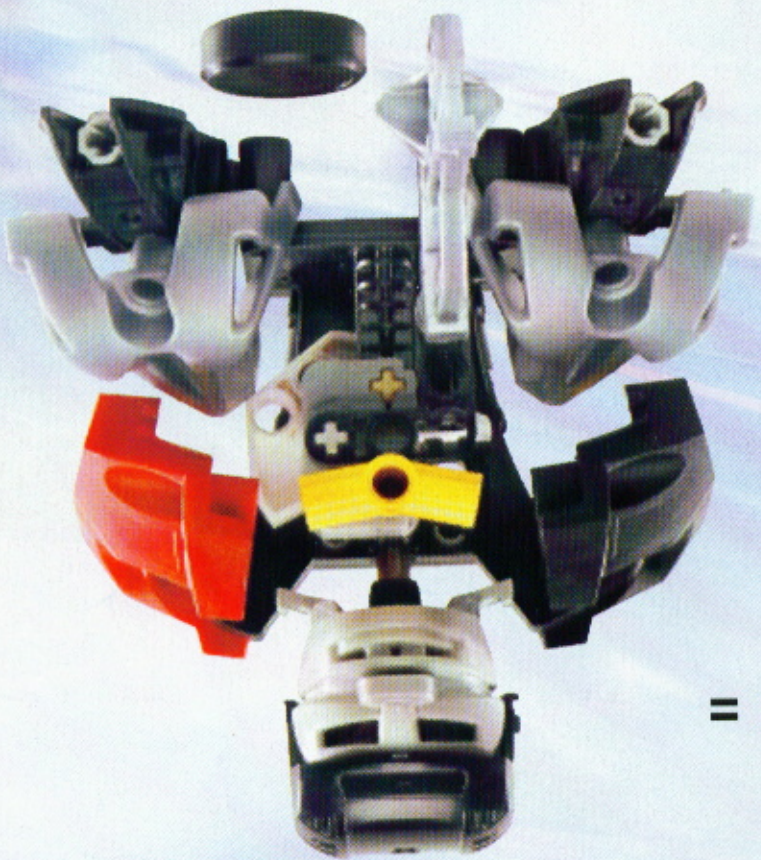

3540 + 3543 =

EN: Clean before use

DE: Bitte vor Gebrauch reinigen

FR: Nettoyer avant usage

RU: Перед использованием очистите

PL: Wyczyścić przed użyciem

ET: enne tarvitamist puhastada

TR: Kullanmadan önce temizleyin

ES: Limpiar antes de usar

SK: Pred použitím umyte vodou.

DA: Rengøres før brug

HU: Használat előtt tisztítsd meg!

FI: Puhdistaa ennen käyttöä

LV: Pirms lietošanas jānotīra

PT: Limpar antes da utilização

SF: Rengör innan användning

EL: Καθαρίστε πριν τη χρήση

RO: Se curăția înainte de utilizare

JP: 汚れを落とすしてから使用してください。 A se curăția înainte de utilizare

BG: Преди употреба измийте

LT: Prieš naudojimą nuvalyti

KO: 사용 전 세척하십시오

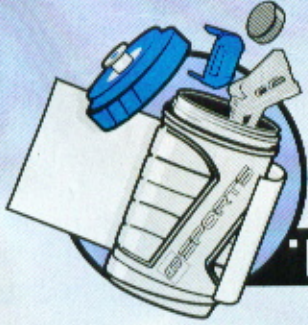

1



2

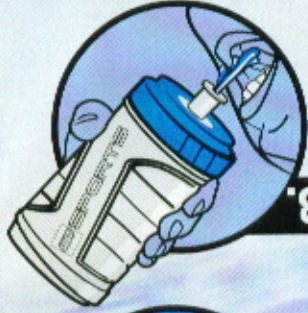

3

SPORTS



NHL and the NHL
Shield are registered
trademarks of the
National Hockey
League. All NHL logos
and marks and team
logos and marks
depicted herein
are the property
of the NHL and the
respective teams
and may not be
reproduced without
the prior written
consent of NHL
Enterprises, L.P. ©
NHL 2003. All rights
Reserved.

adidas, the adidas logo and the three stripe trademark are
registered trademarks of the adidas-Salomon group, used with
permission. Fevernova and the Trigon logo are trademarks of the
adidas-Salomon group, used with permission.

LEGO, the LEGO logo and the Minifigure are trademarks
of the LEGO Group. ©2003 The LEGO Group.

www.LEGO.com/sports



NBA identifications
depicted are the
exclusive property of
NBA Properties, Inc.
and/or the NBA Member
Teams, and are used
with permission.
SPALDING is a
trademark of Spalding
Sports Worldwide, Inc. a
Spalding affiliate.
Spalding Sports
Worldwide, Inc. 2003.