



STAR WARS



7663



1

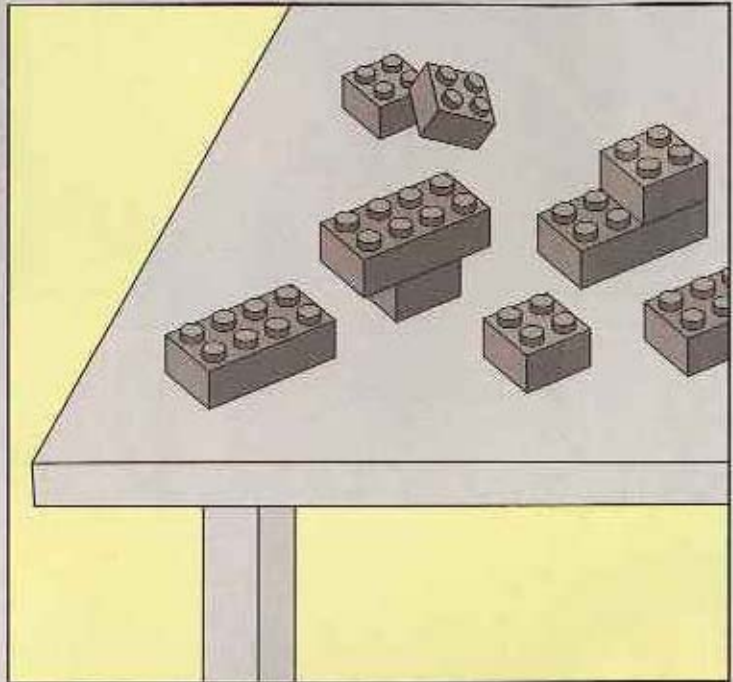
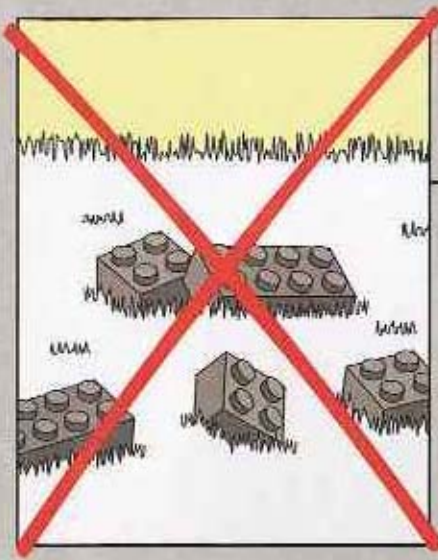

2

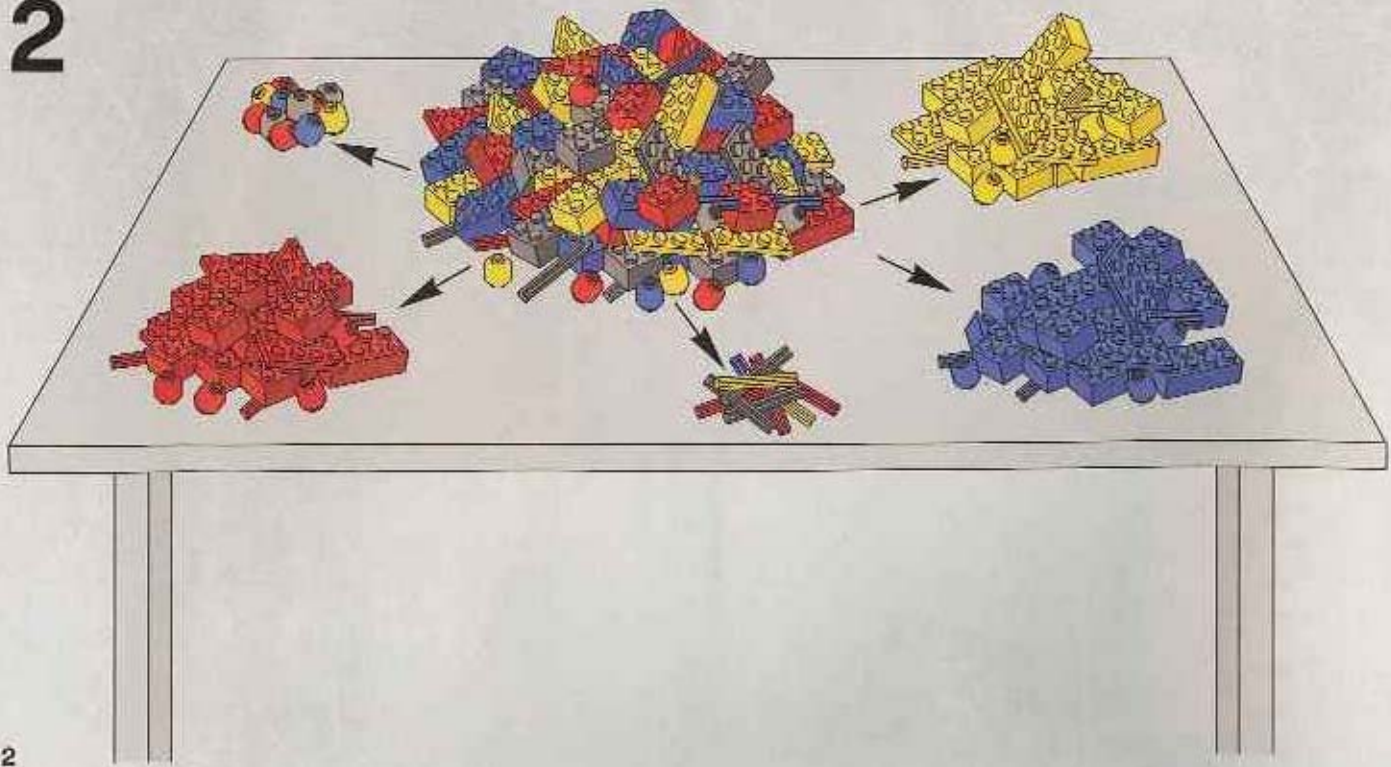

3

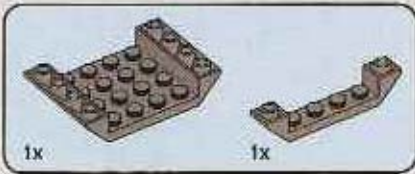
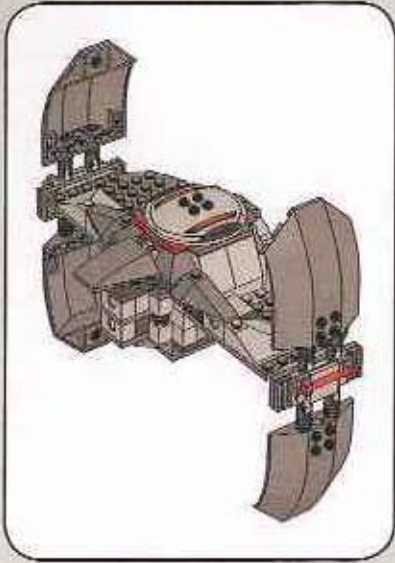
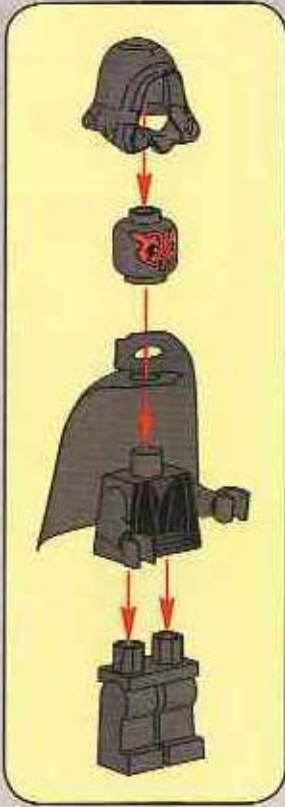

1

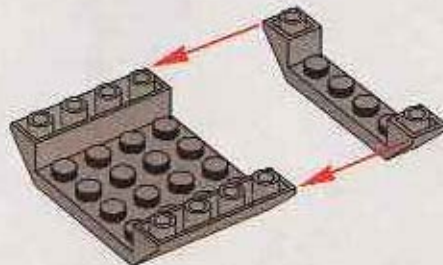

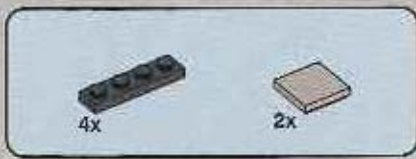

2

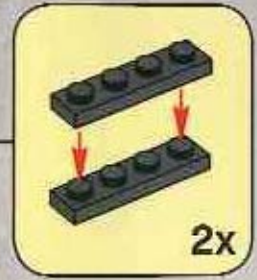
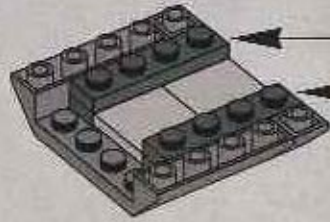

3

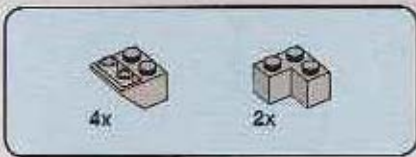
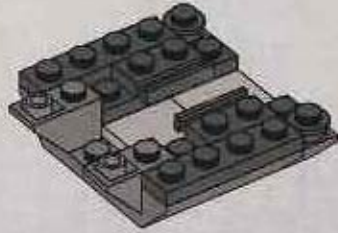

4

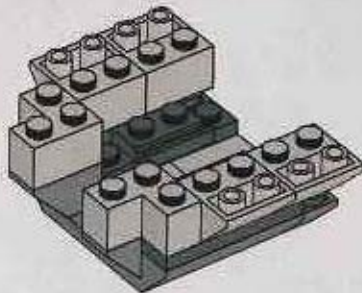

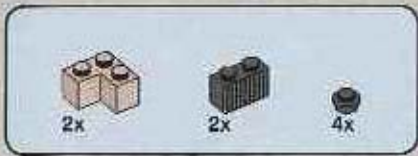

5

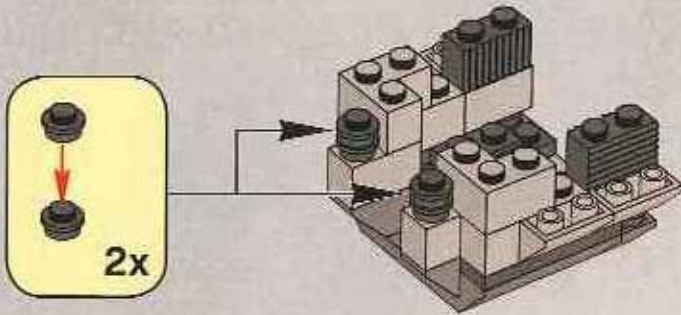

6

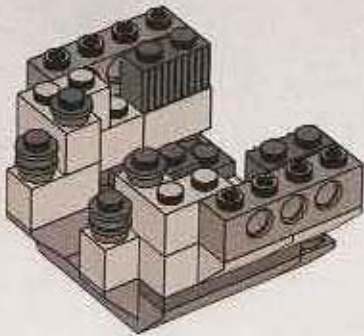

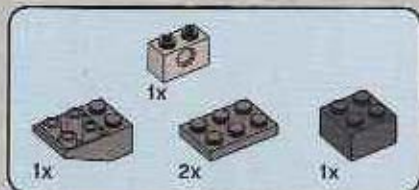

7

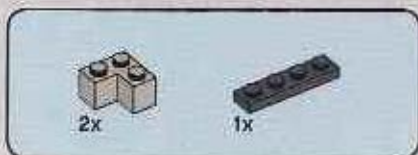
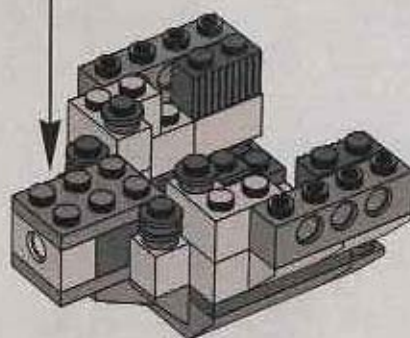
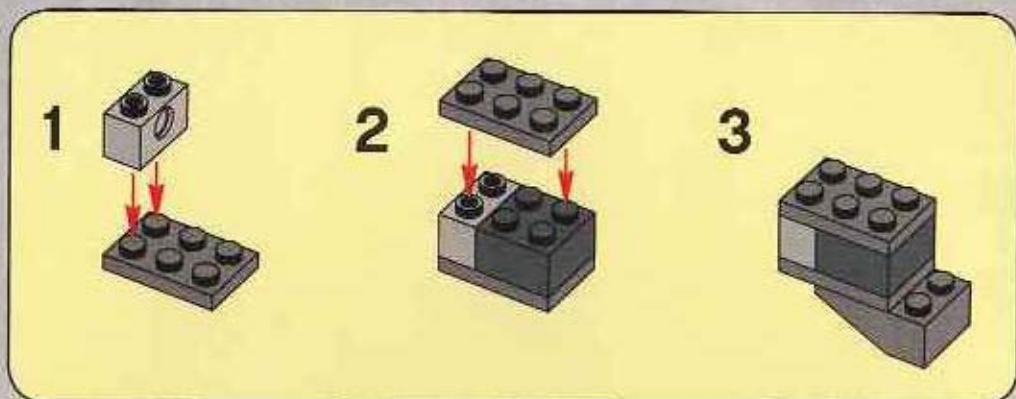

8

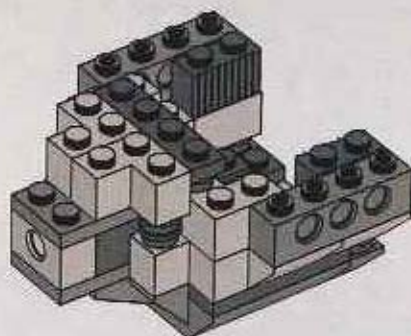



1x



2x

9

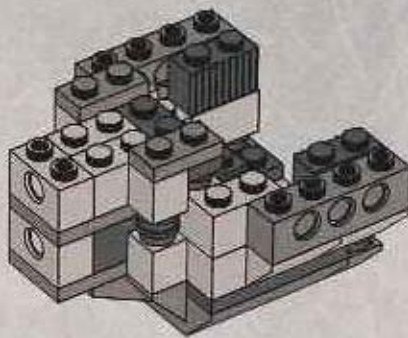

2x



2x

10

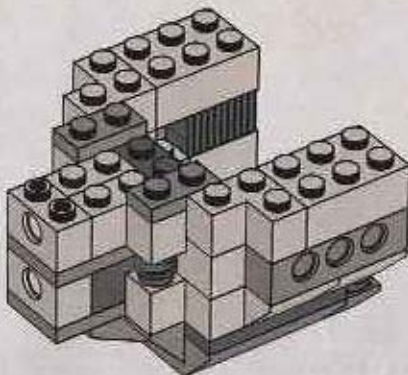

4x



1x

11

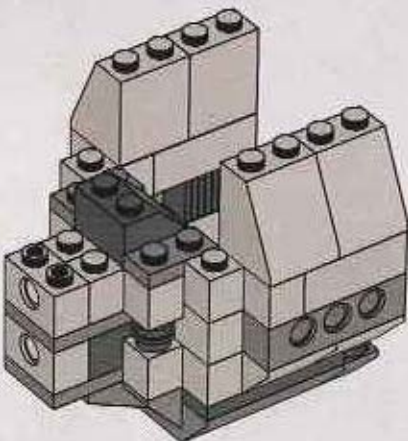



1x



4x

12

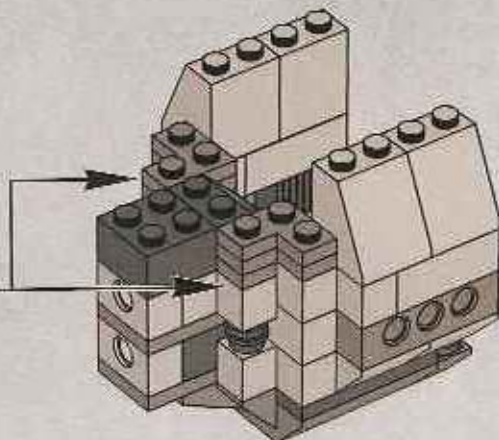
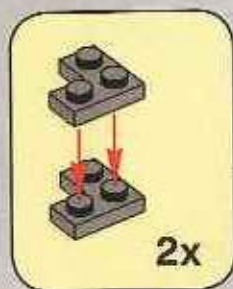

1x



2x

13

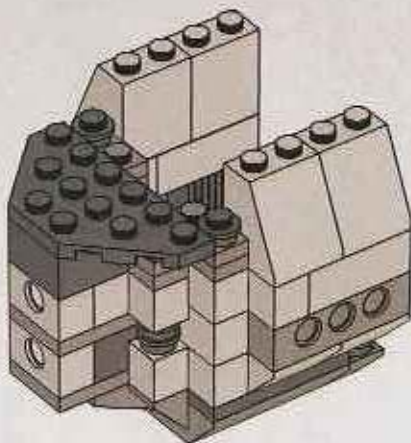

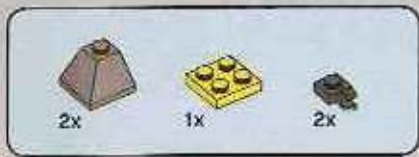

14

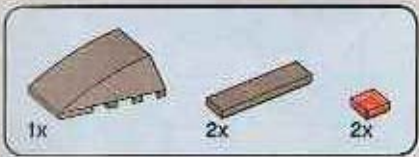
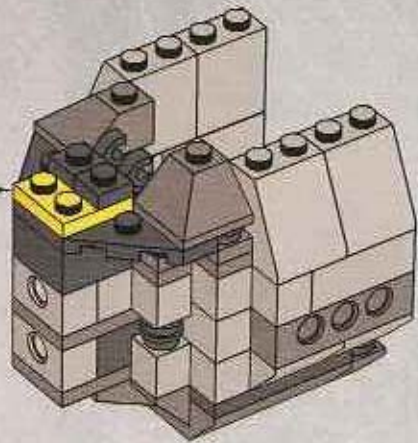
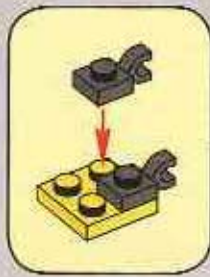

15

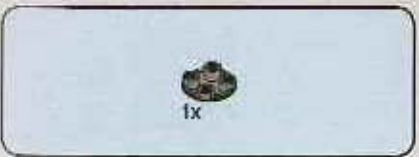
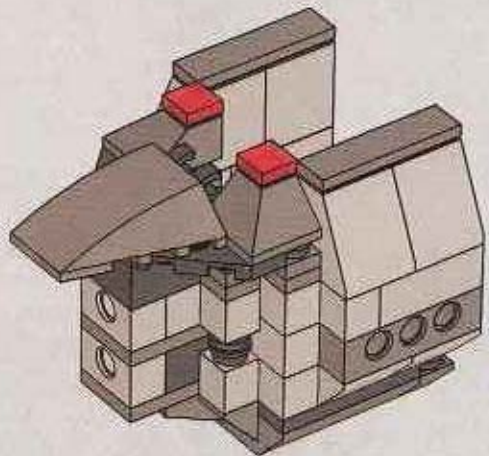

16

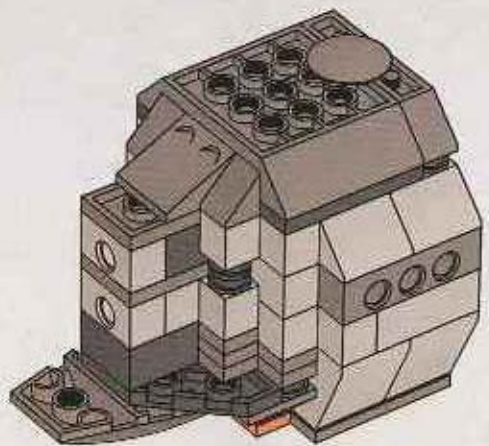

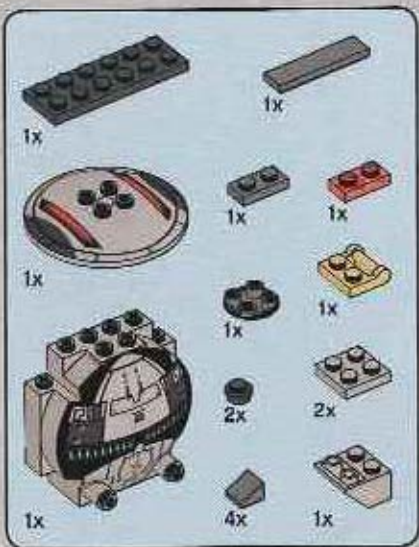

17

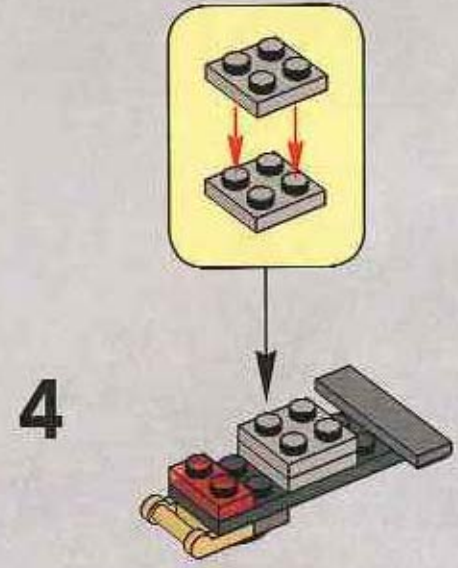
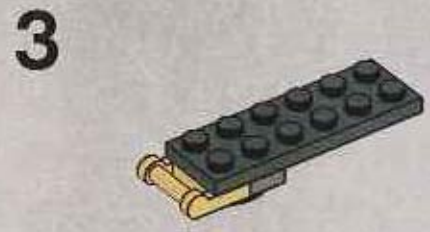
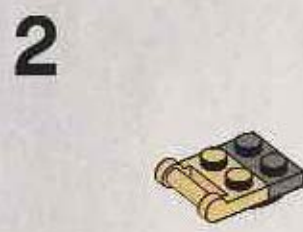
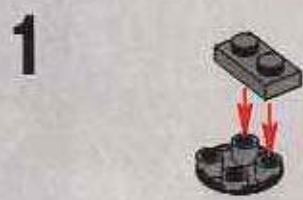

1

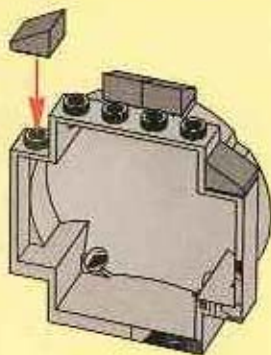

2

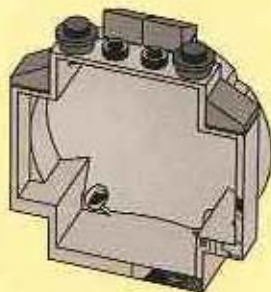

3

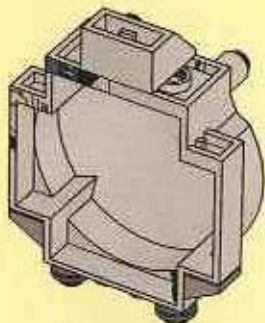

6

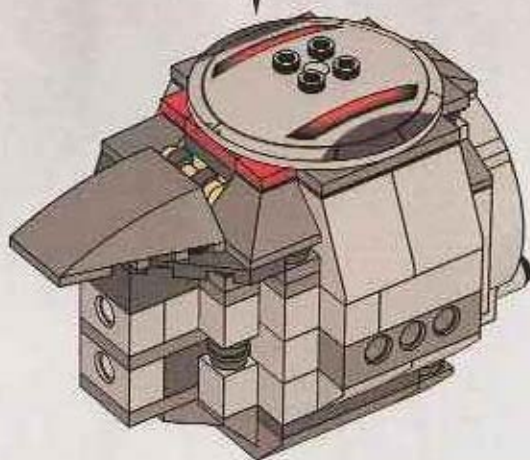
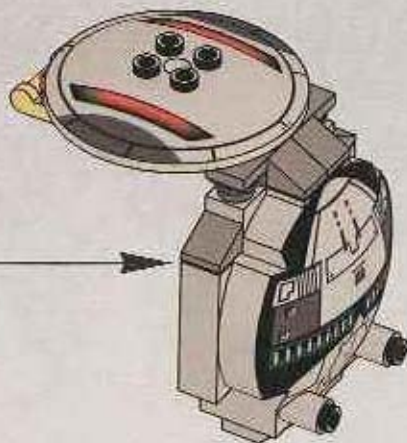

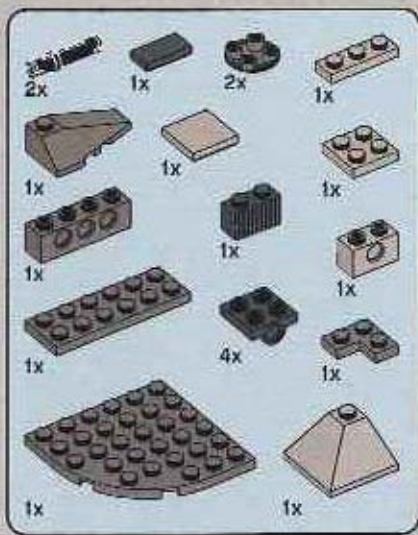

18

1

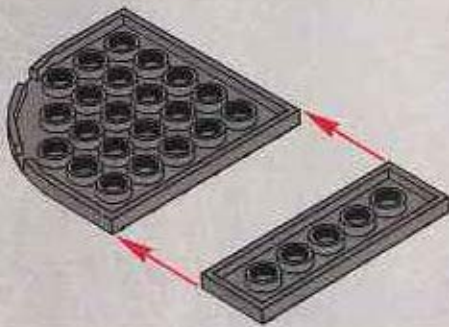

2

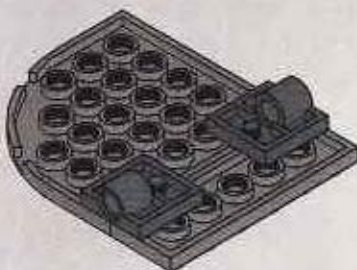

3

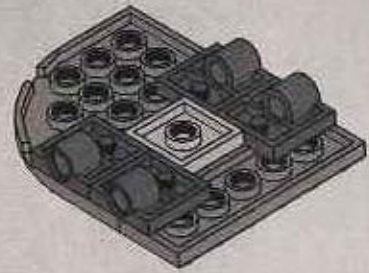

4

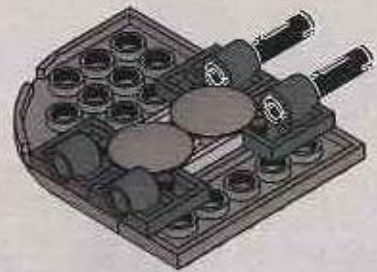

5

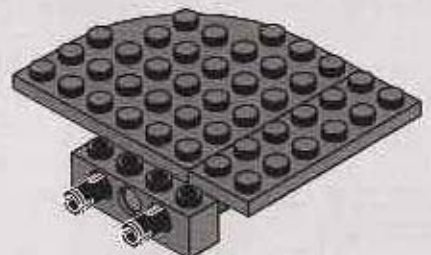

6

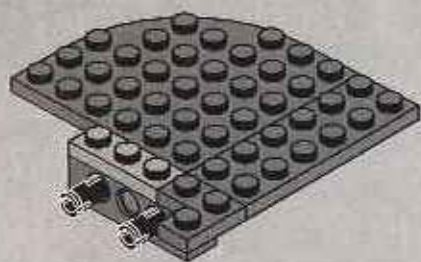

8

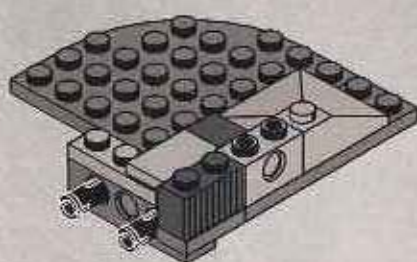

7

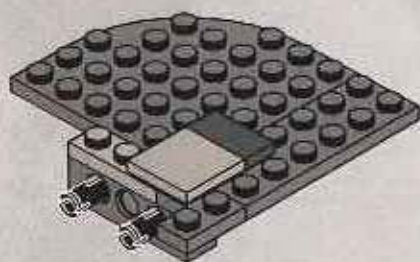

9

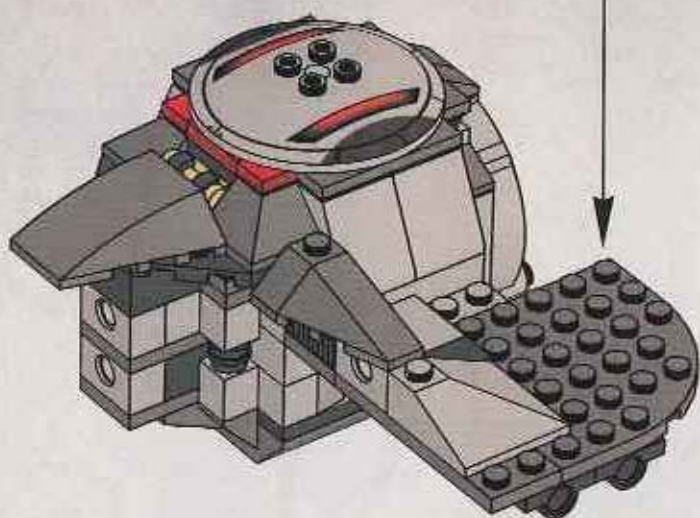
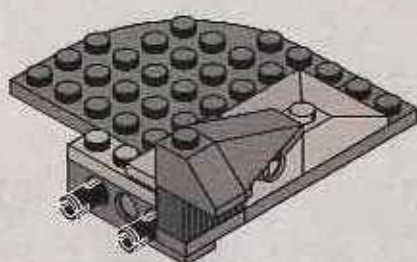

6

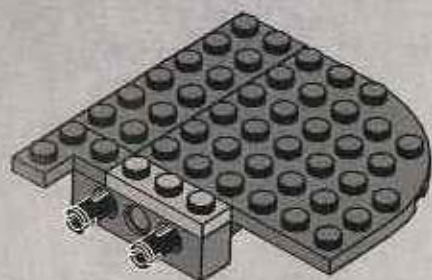

8

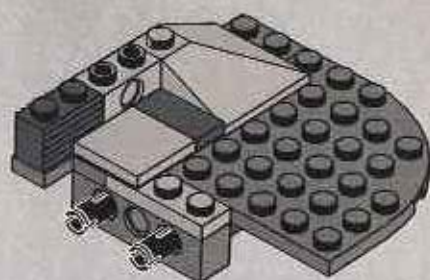

7

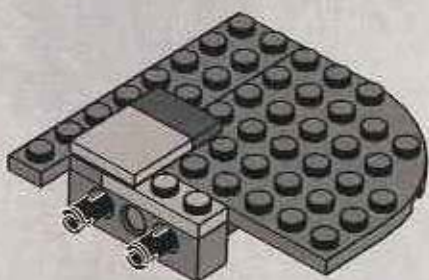

9

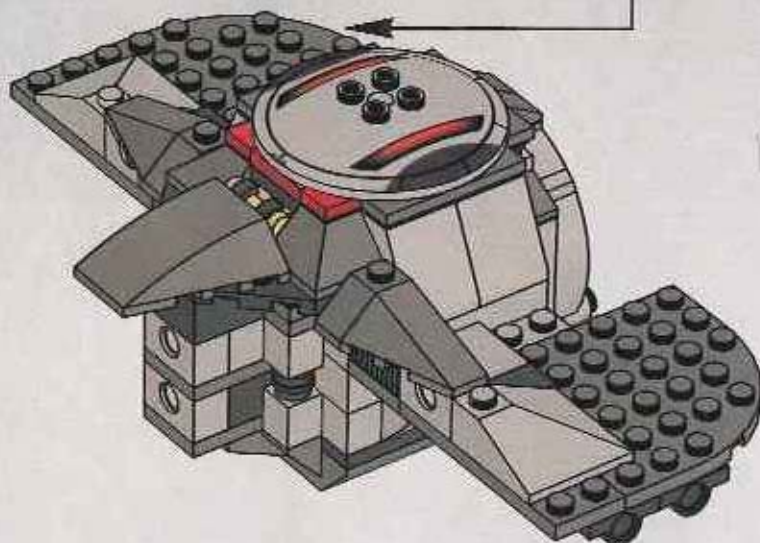
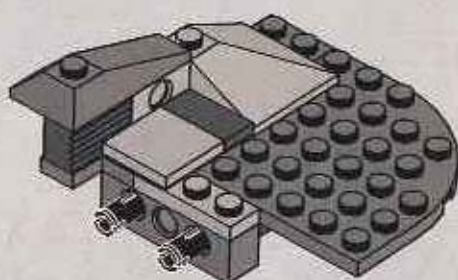

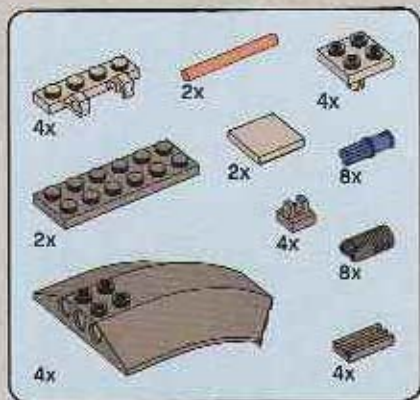

20

1

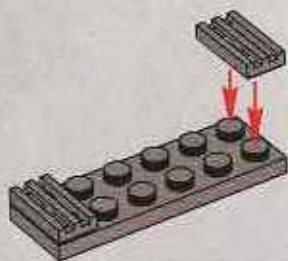

2

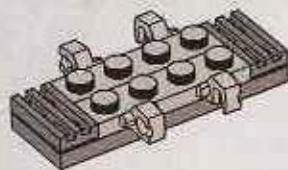

3

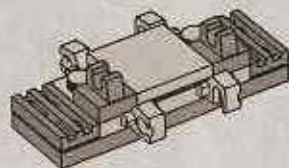

4

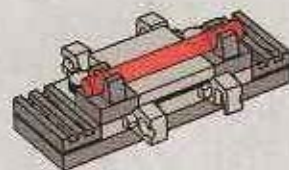

5

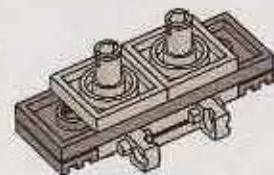

1

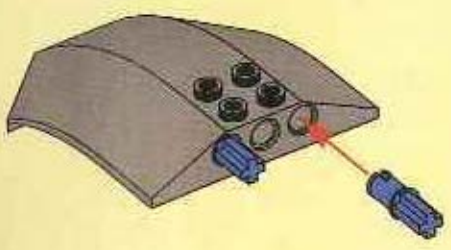

2

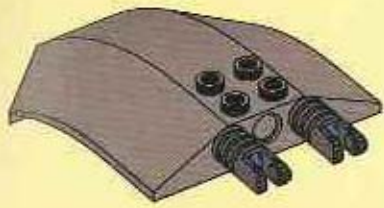

2x

6

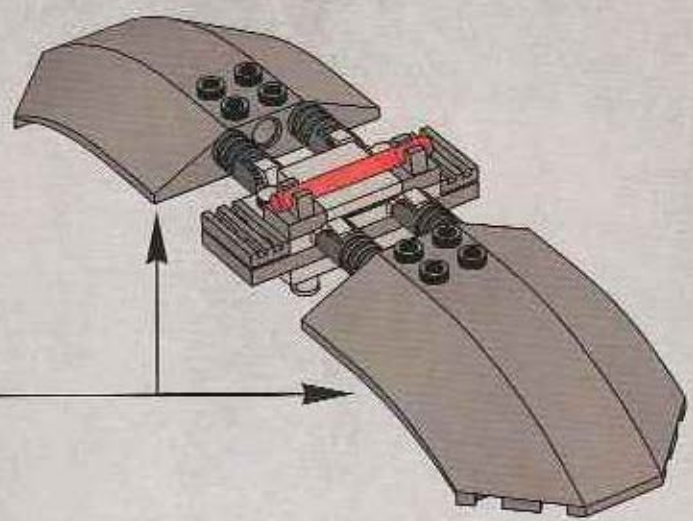

2x

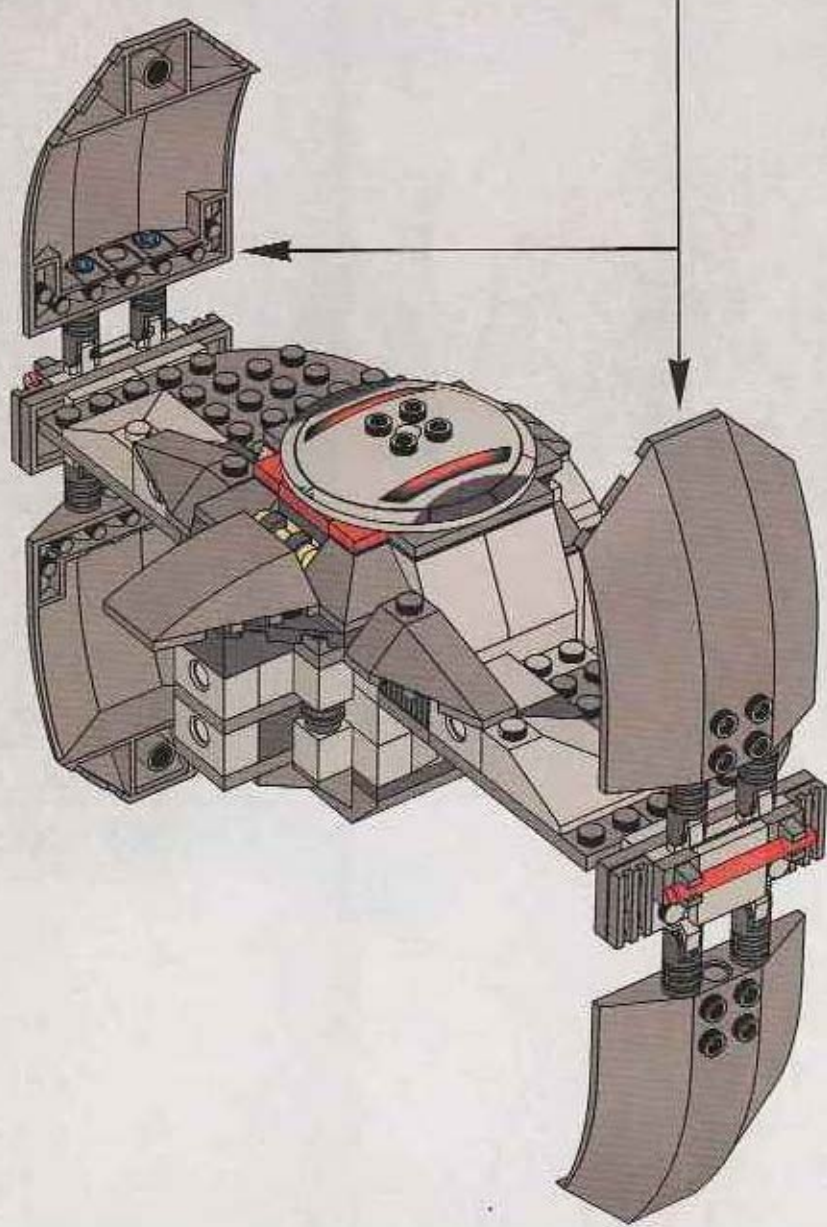

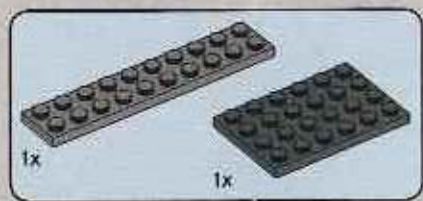
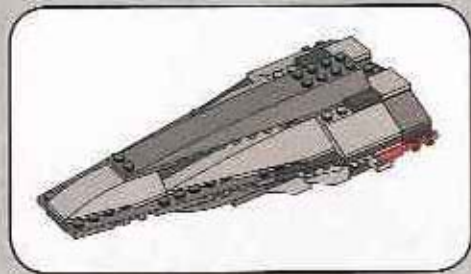

1

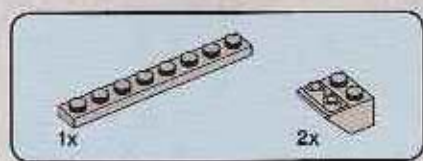
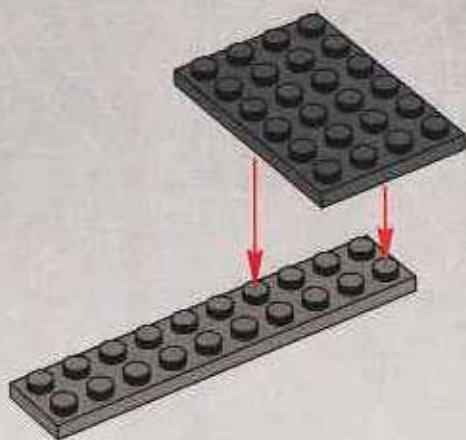

2

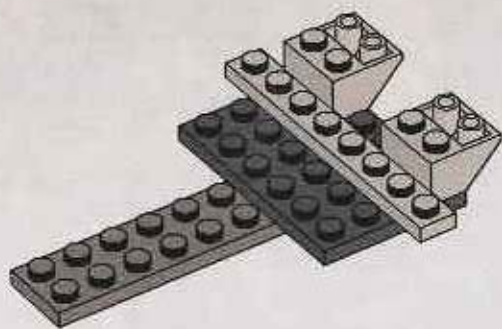



3

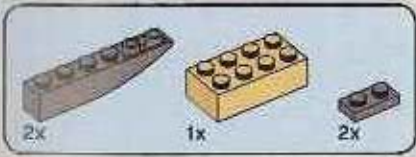
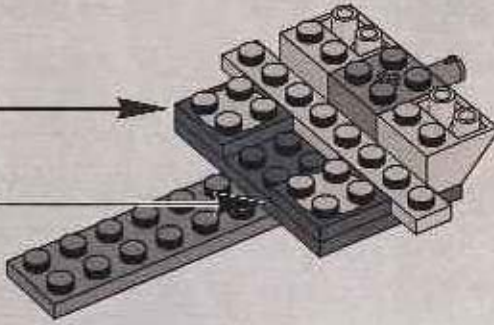

4

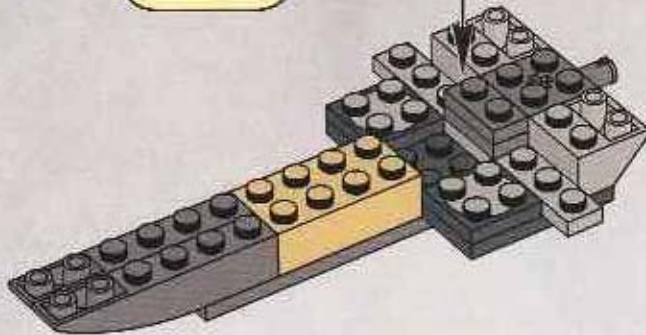
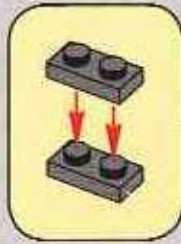

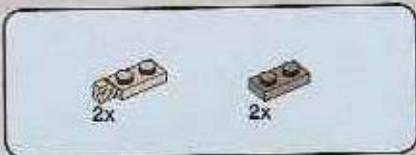

5

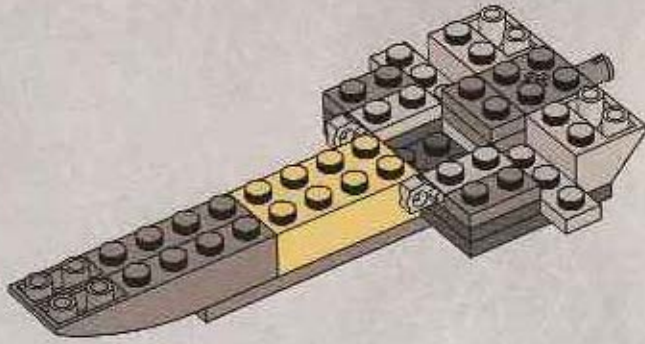

6

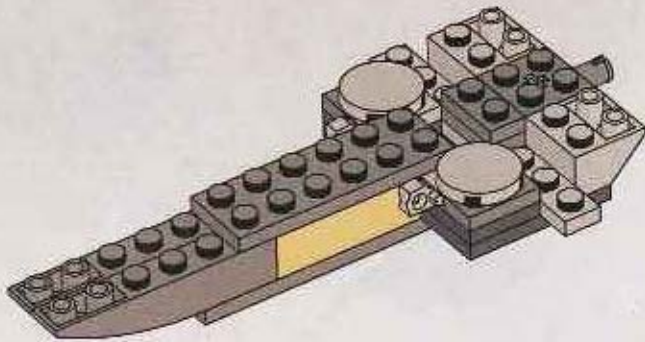

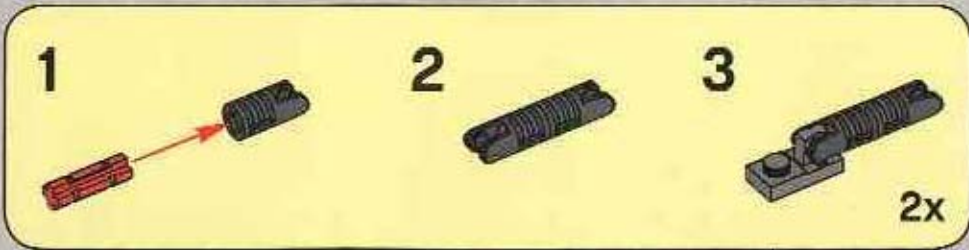
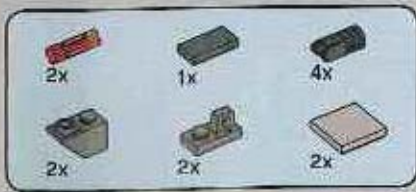

7

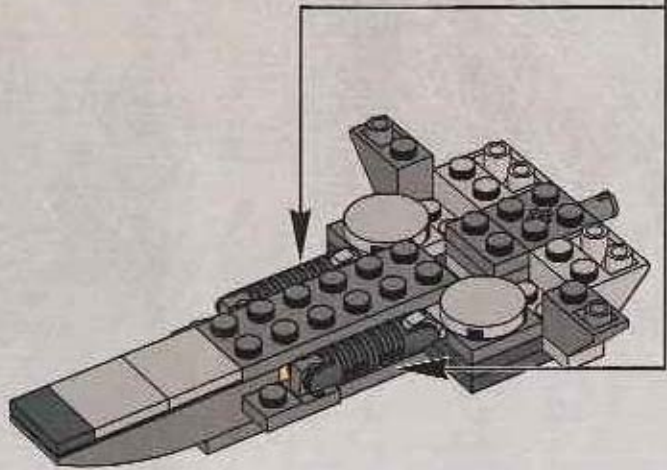

8

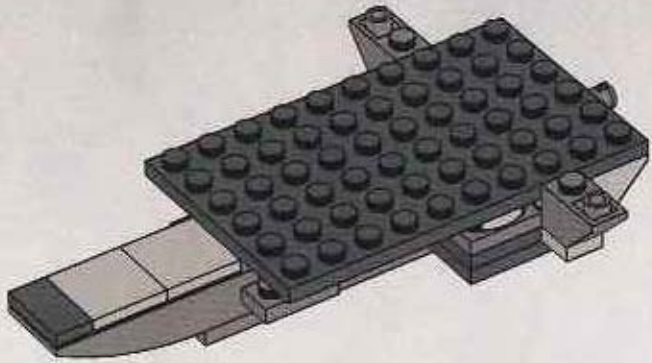

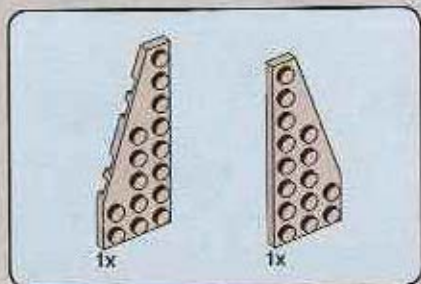

9

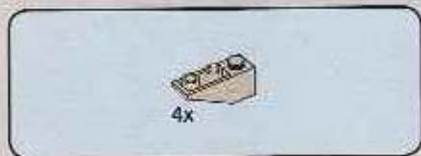
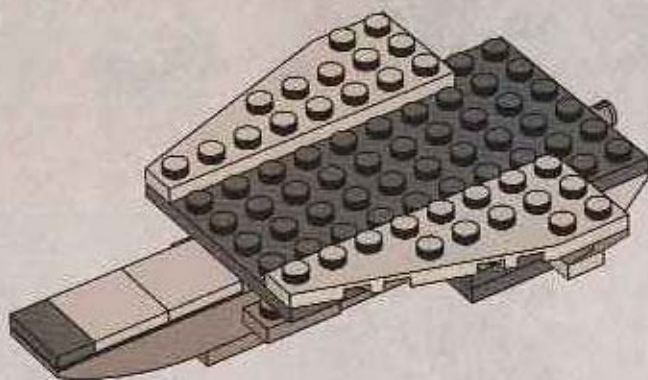

10

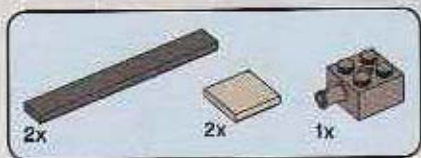
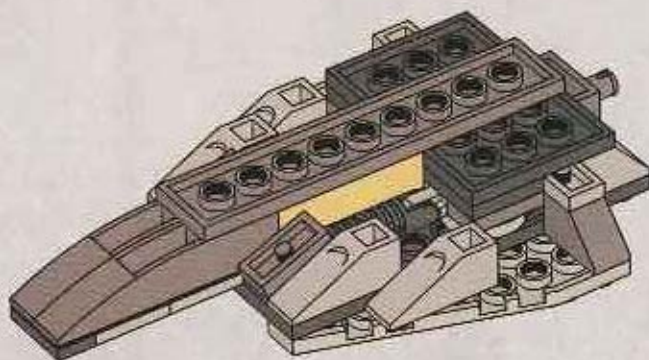

11

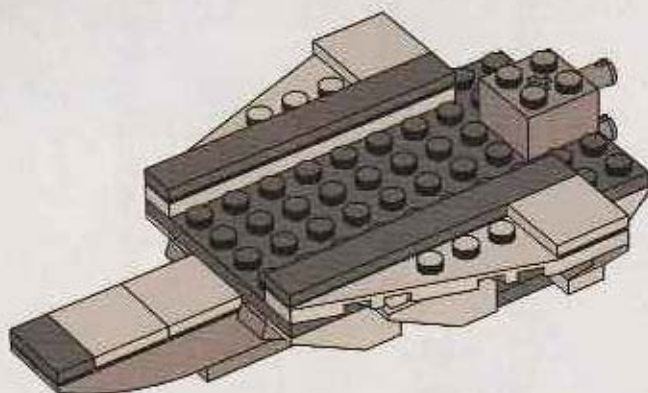

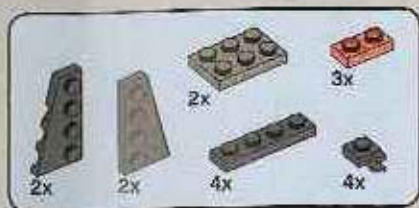

12

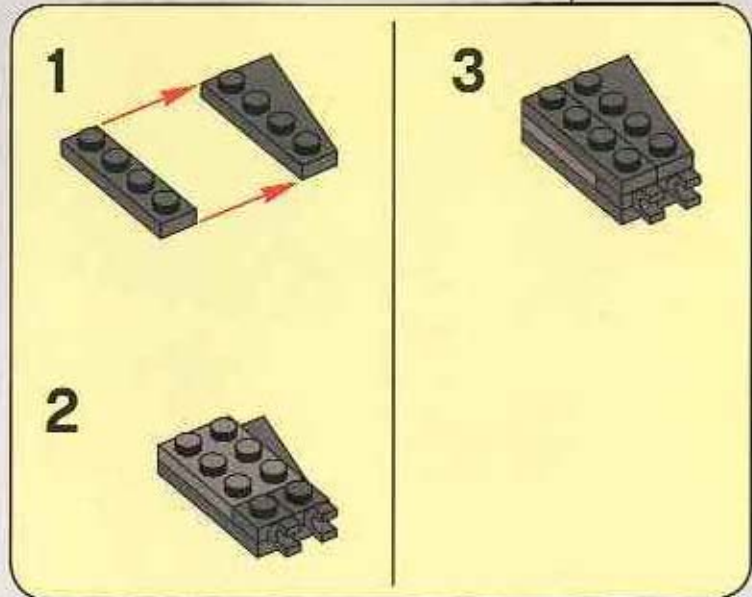
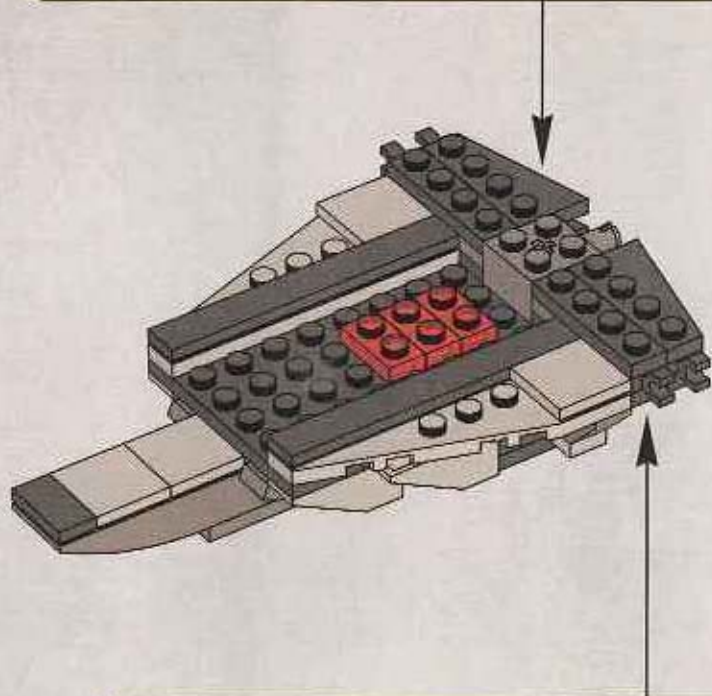
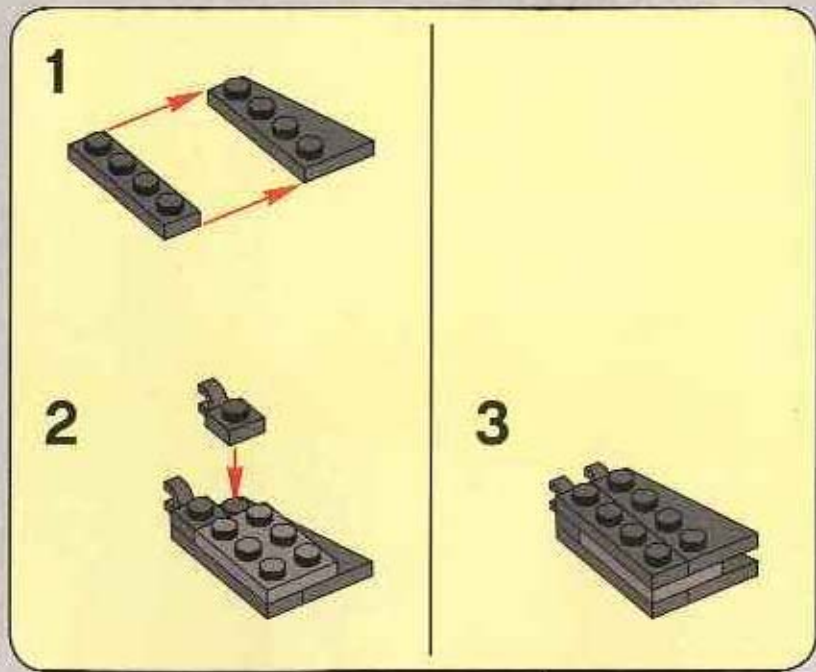



1x



2x

13

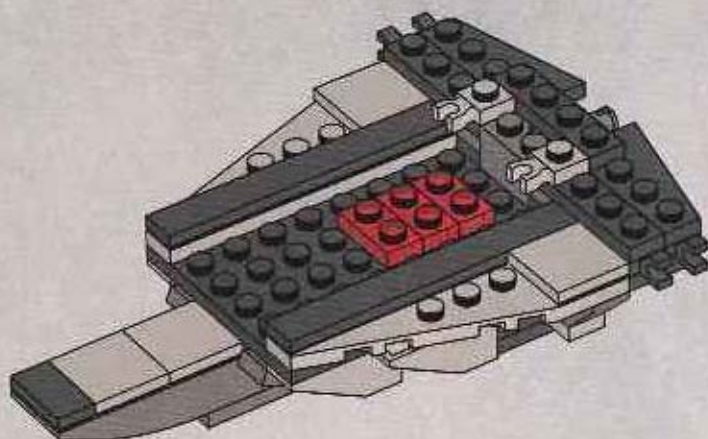

2x



2x



2x

14

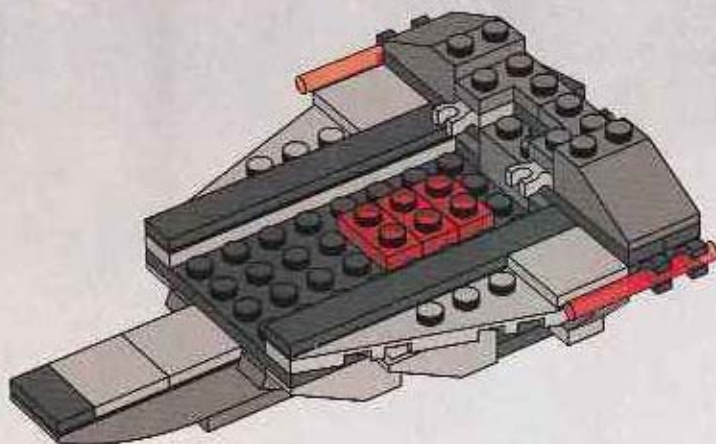



15

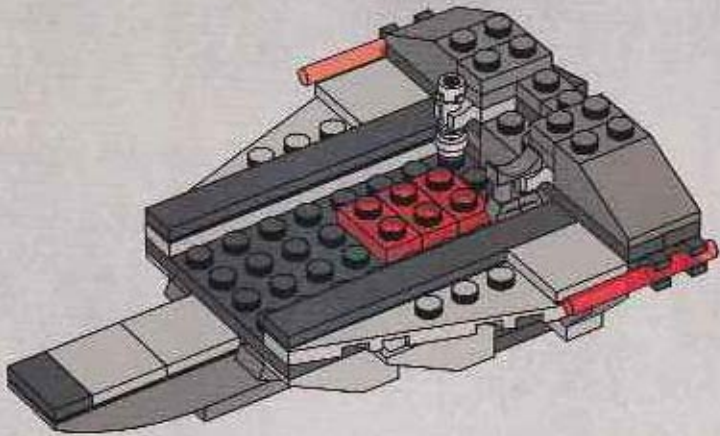

16

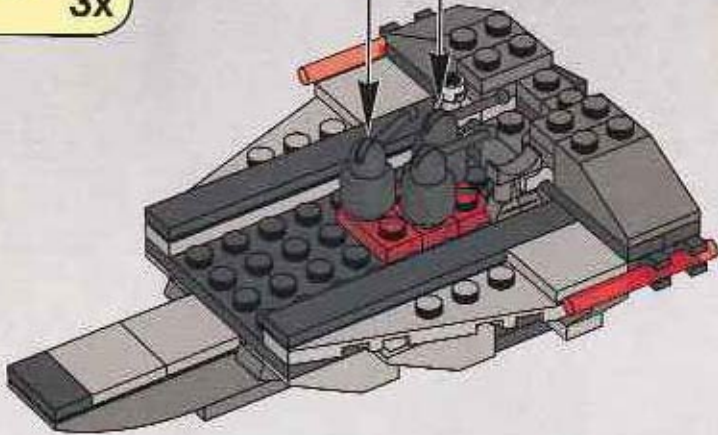
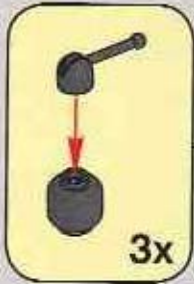

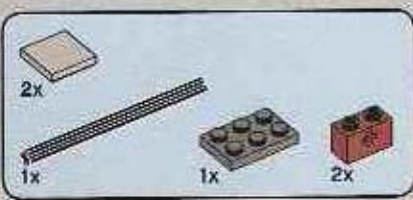

17

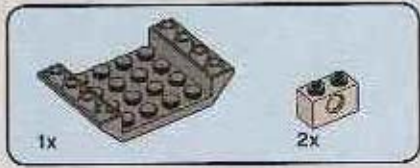
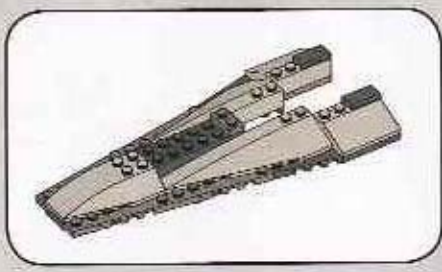
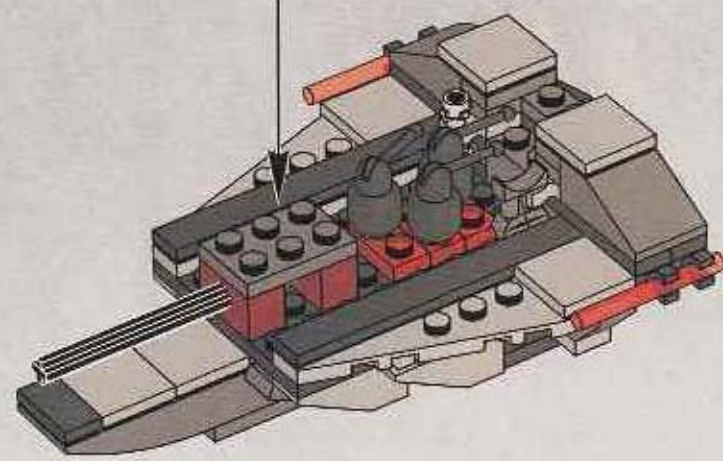
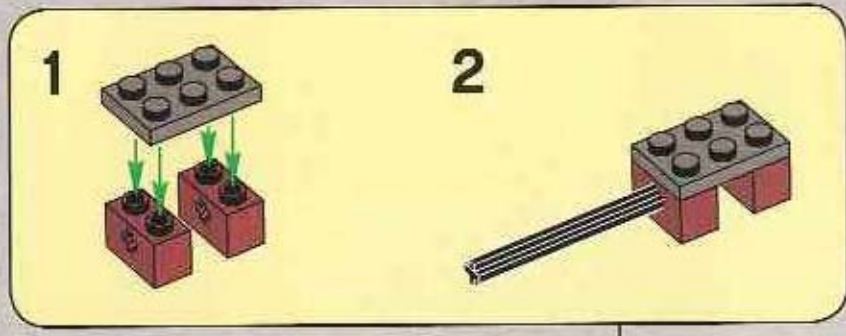

1

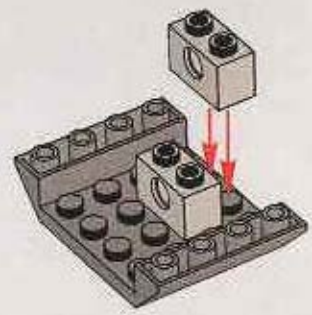

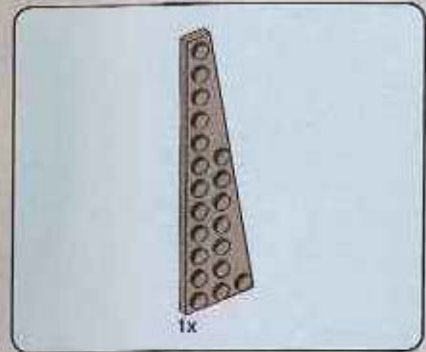

2

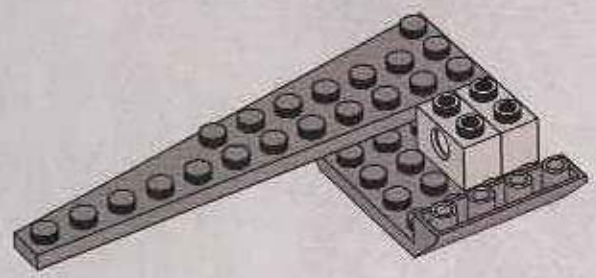

3

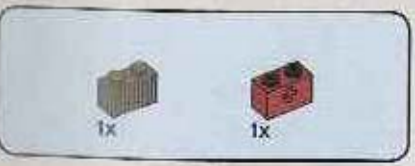
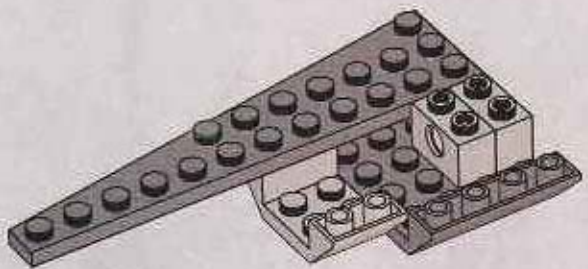

4

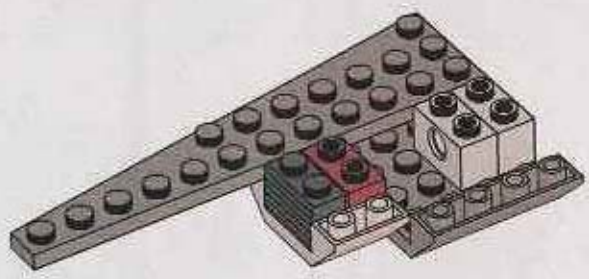

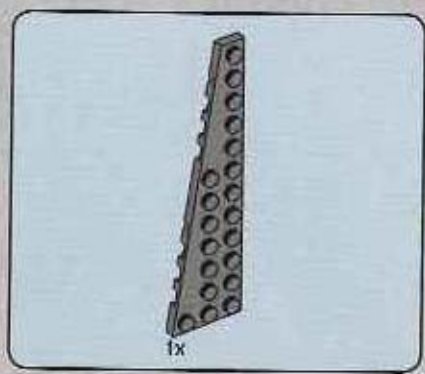

5

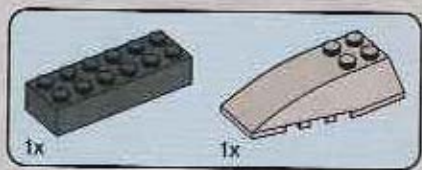
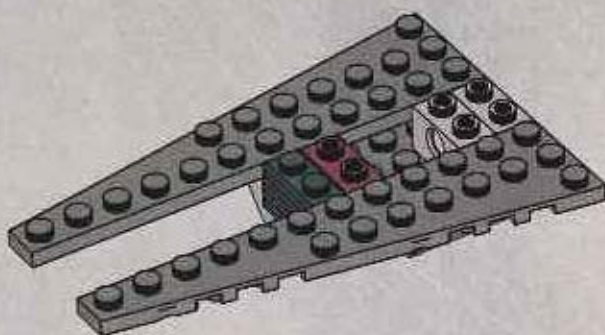

6

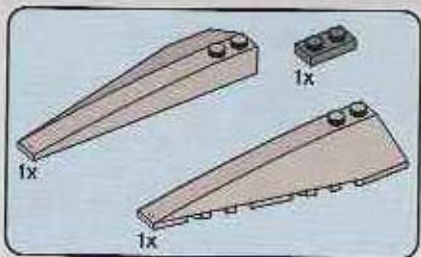
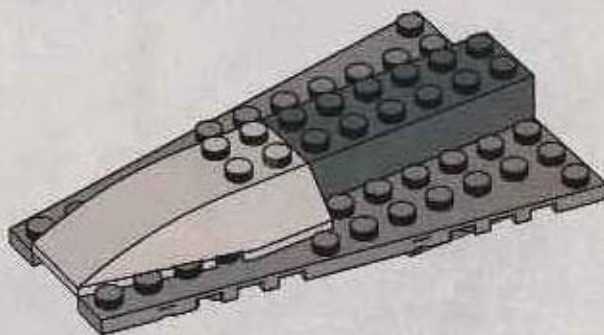

7

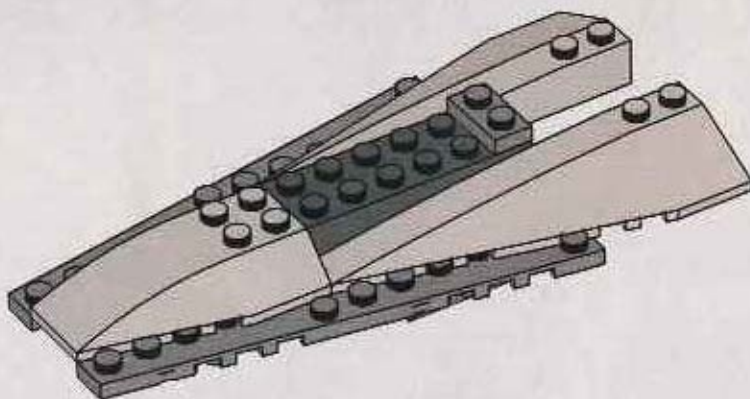



8

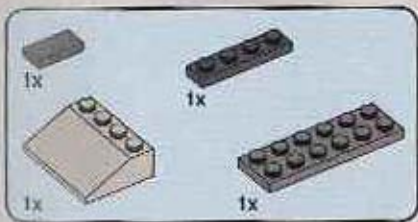
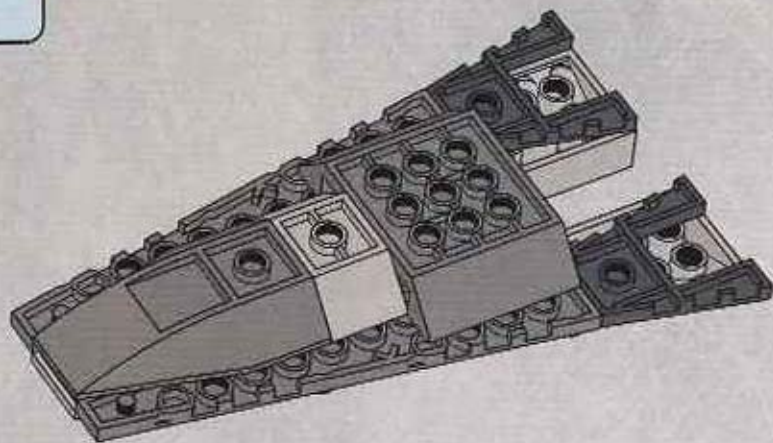

9

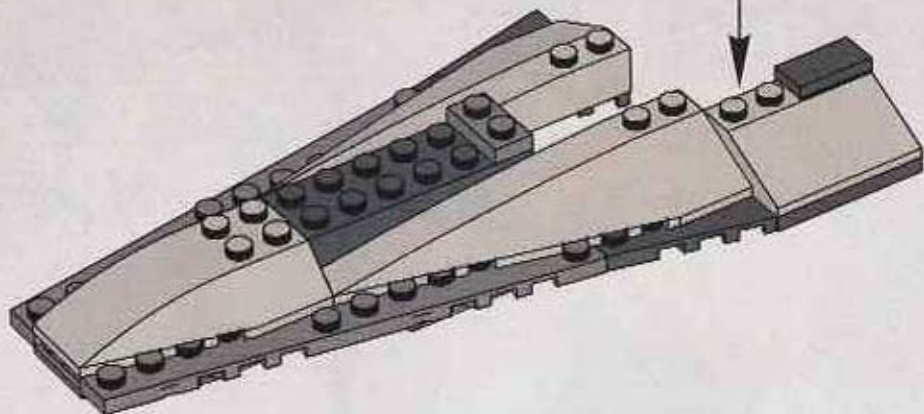
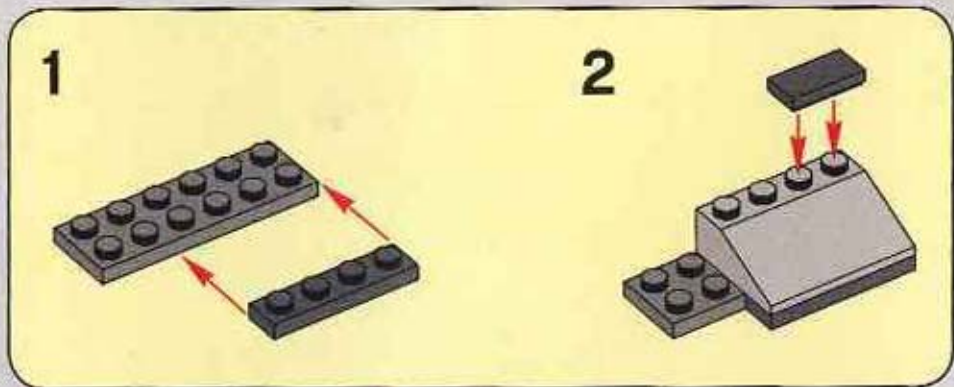

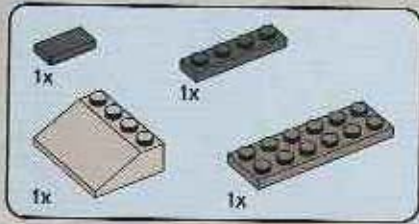

10

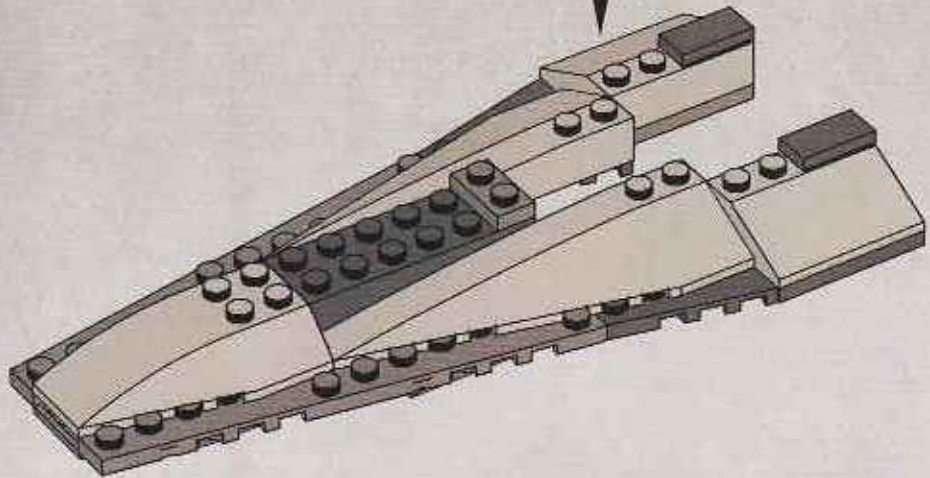
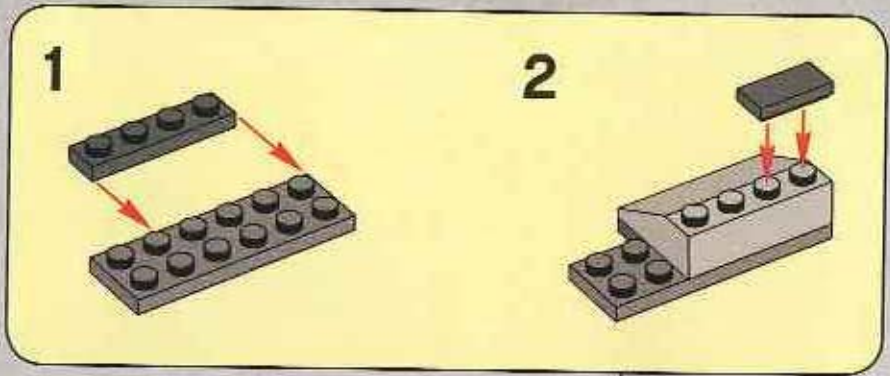

18

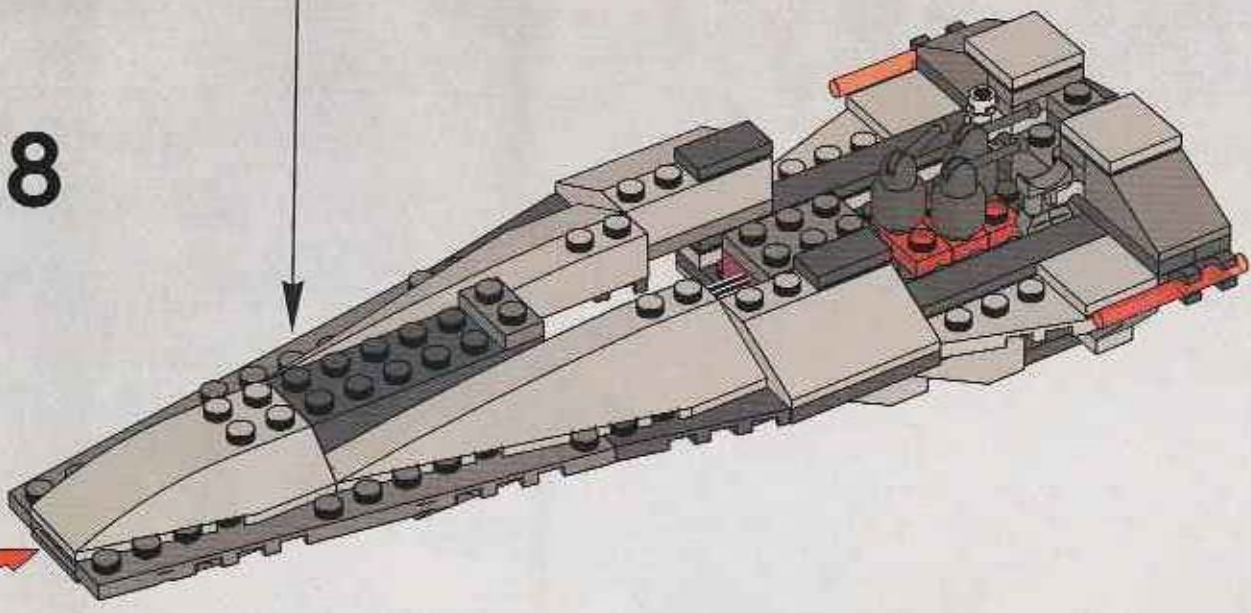

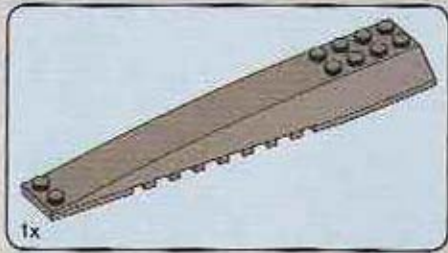

19

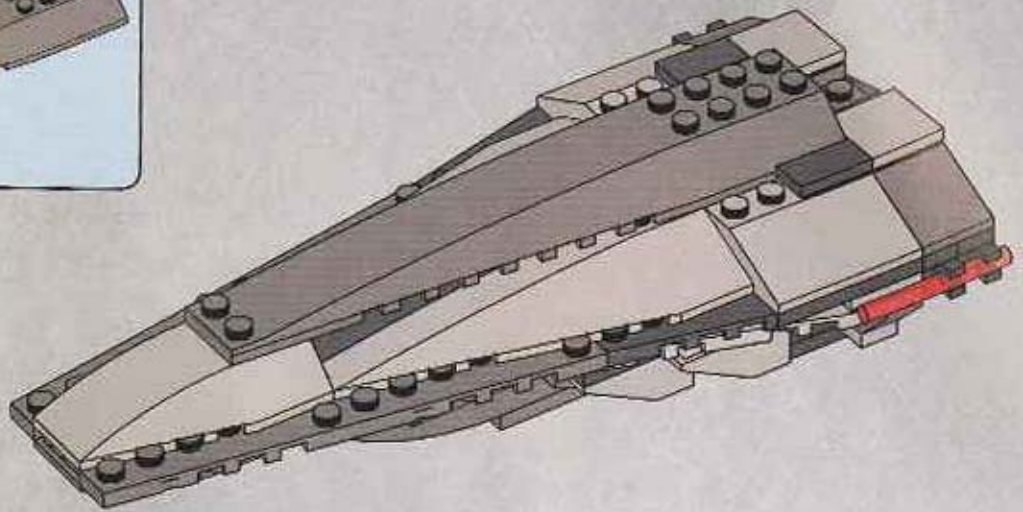

20

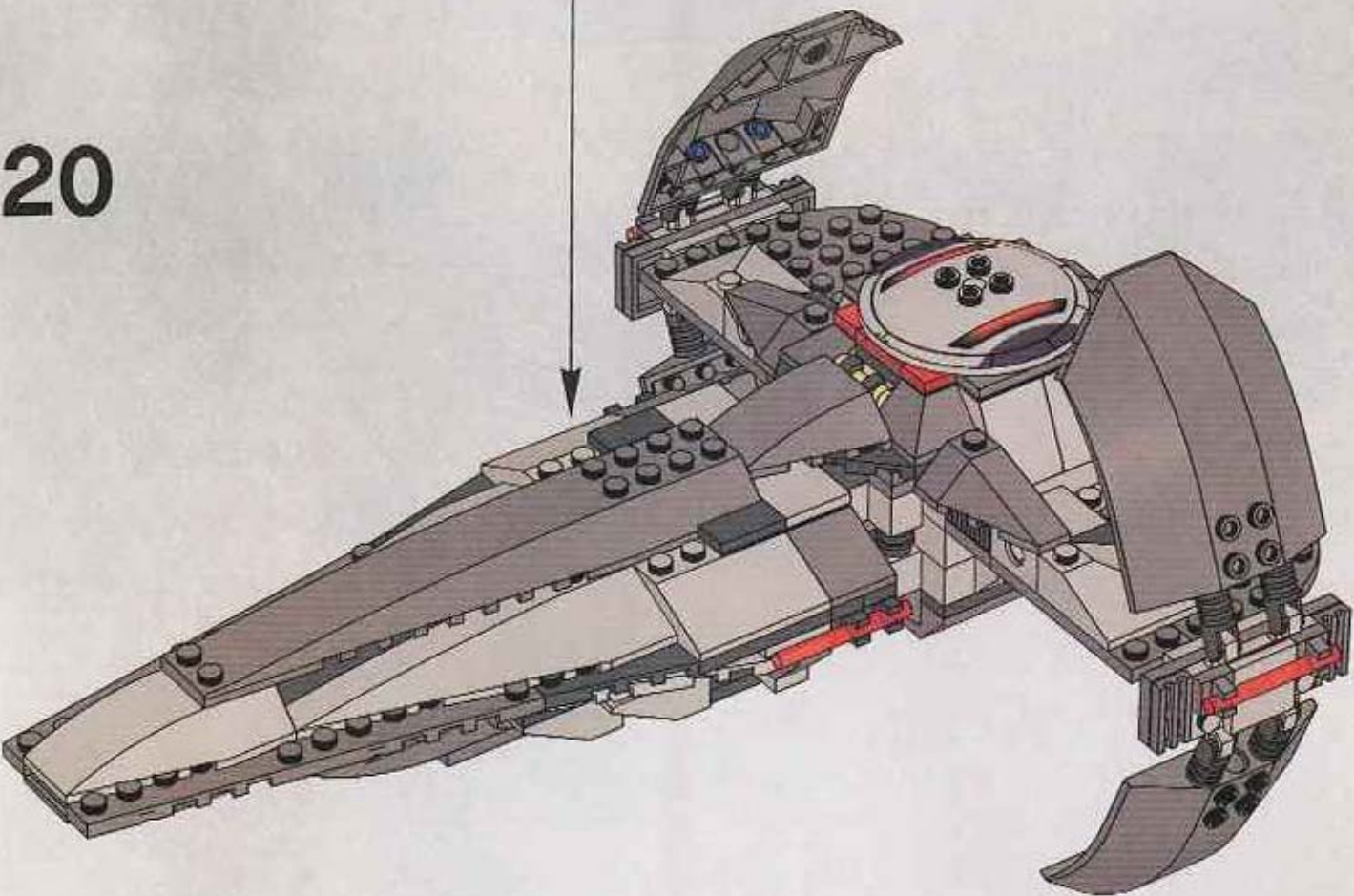

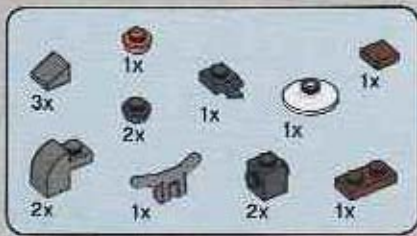

21

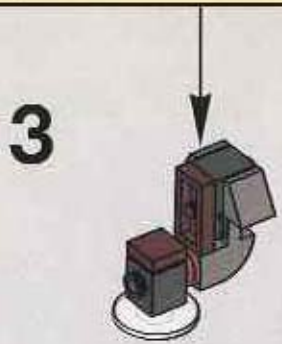
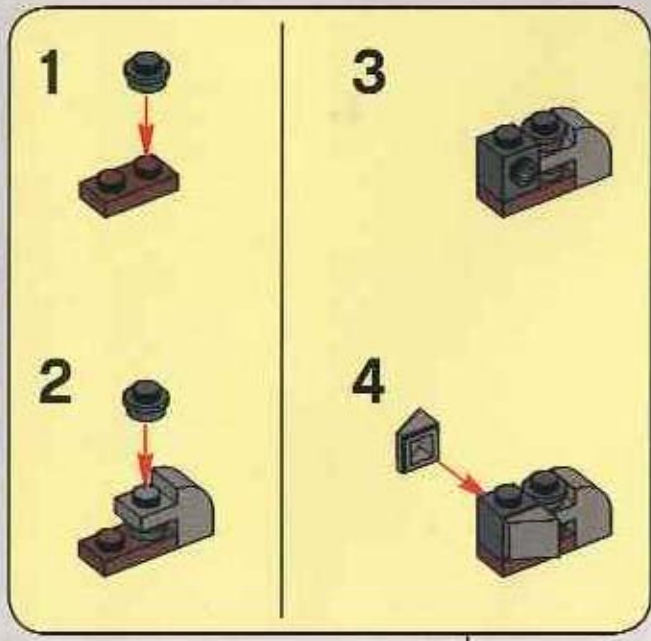
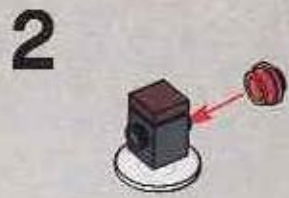
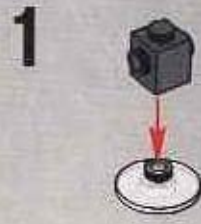

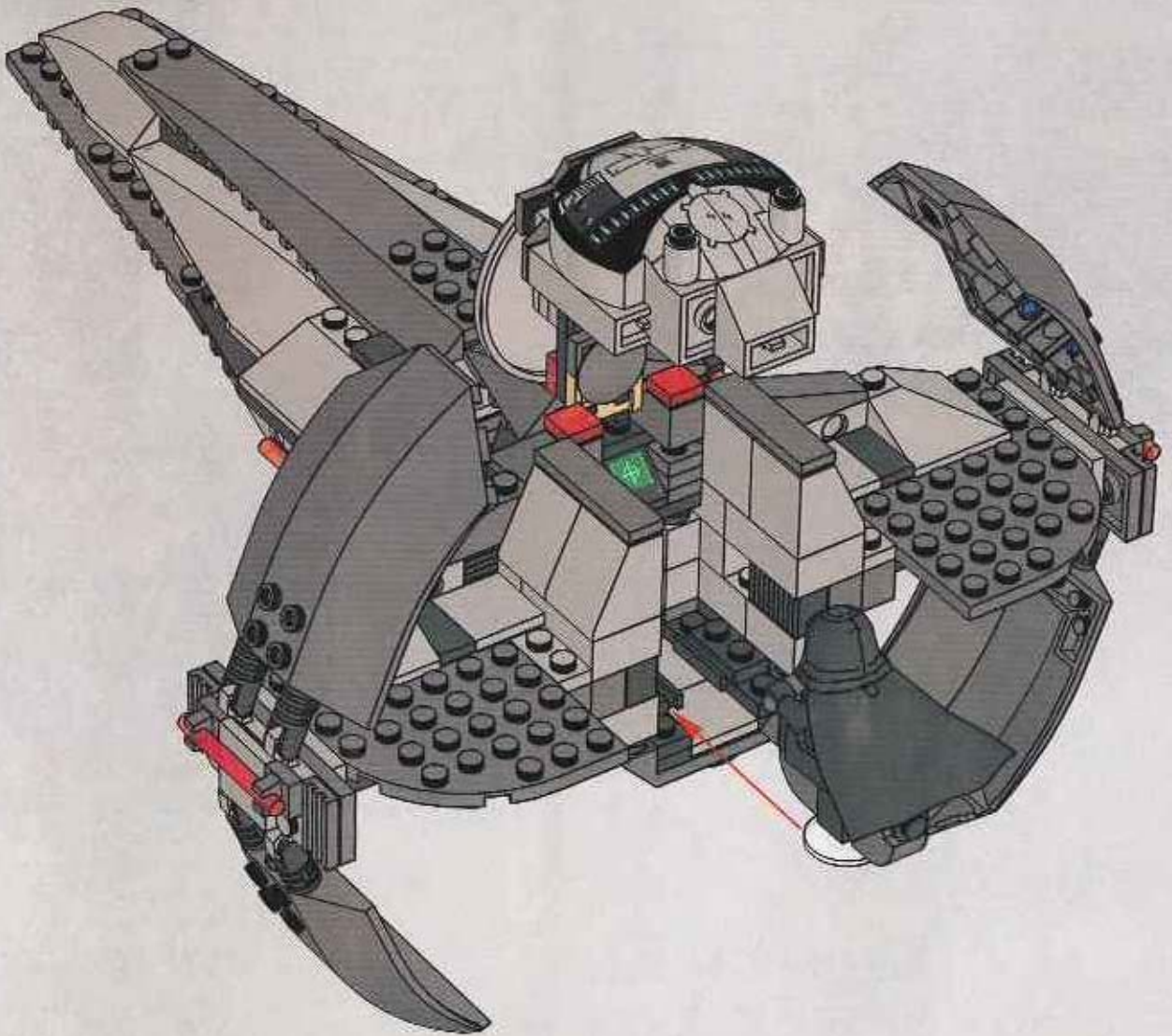
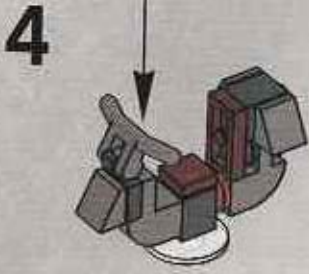
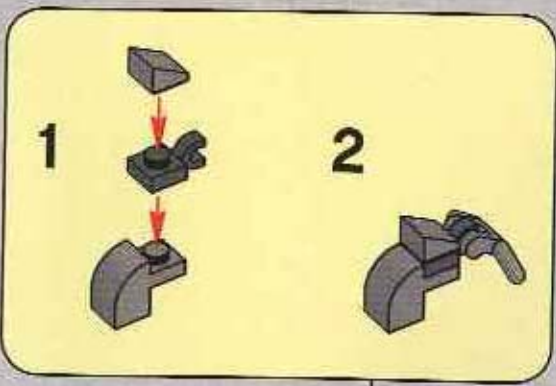



2x



2x



22

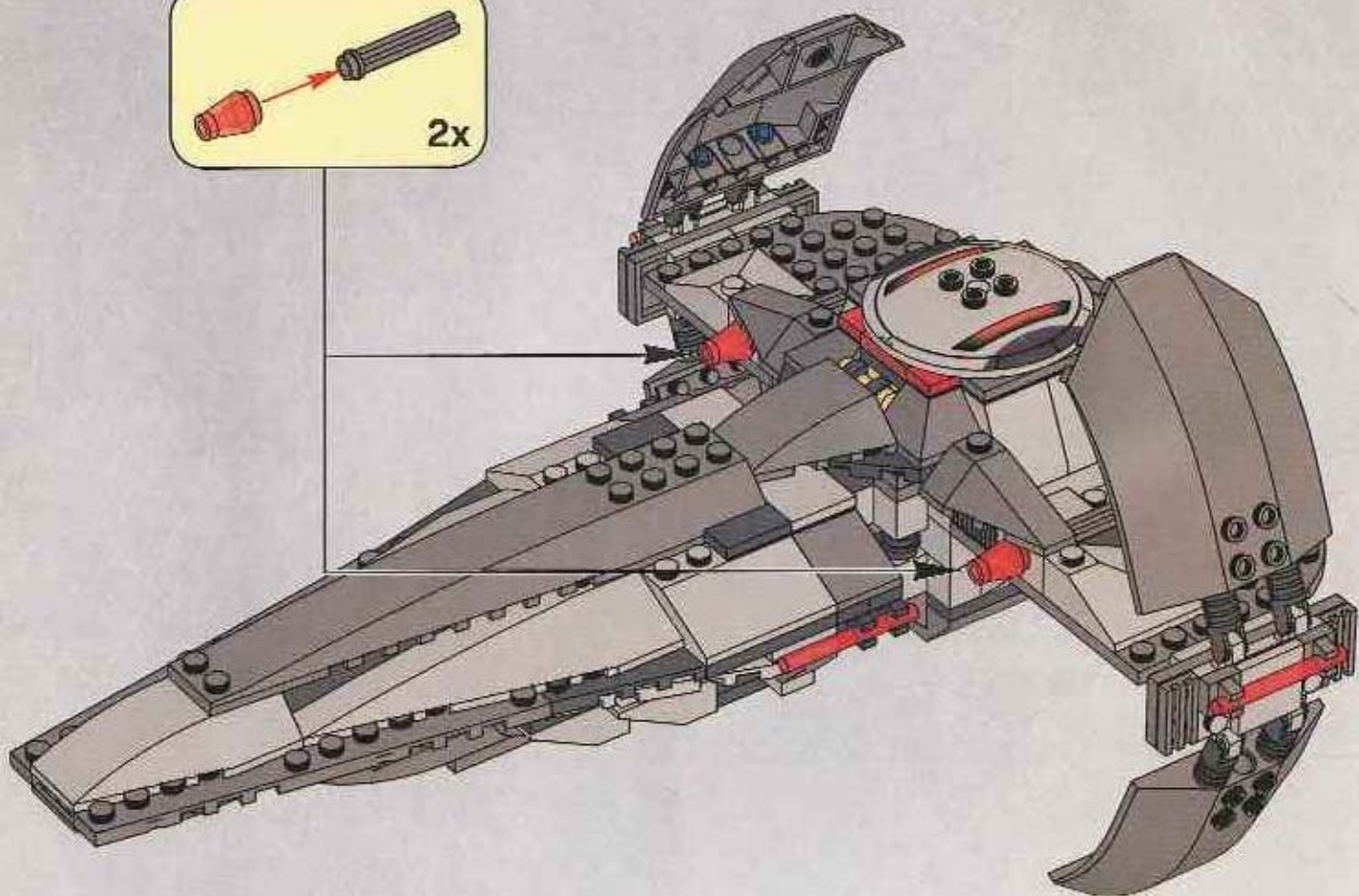
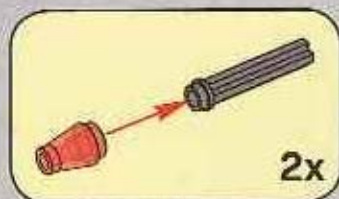





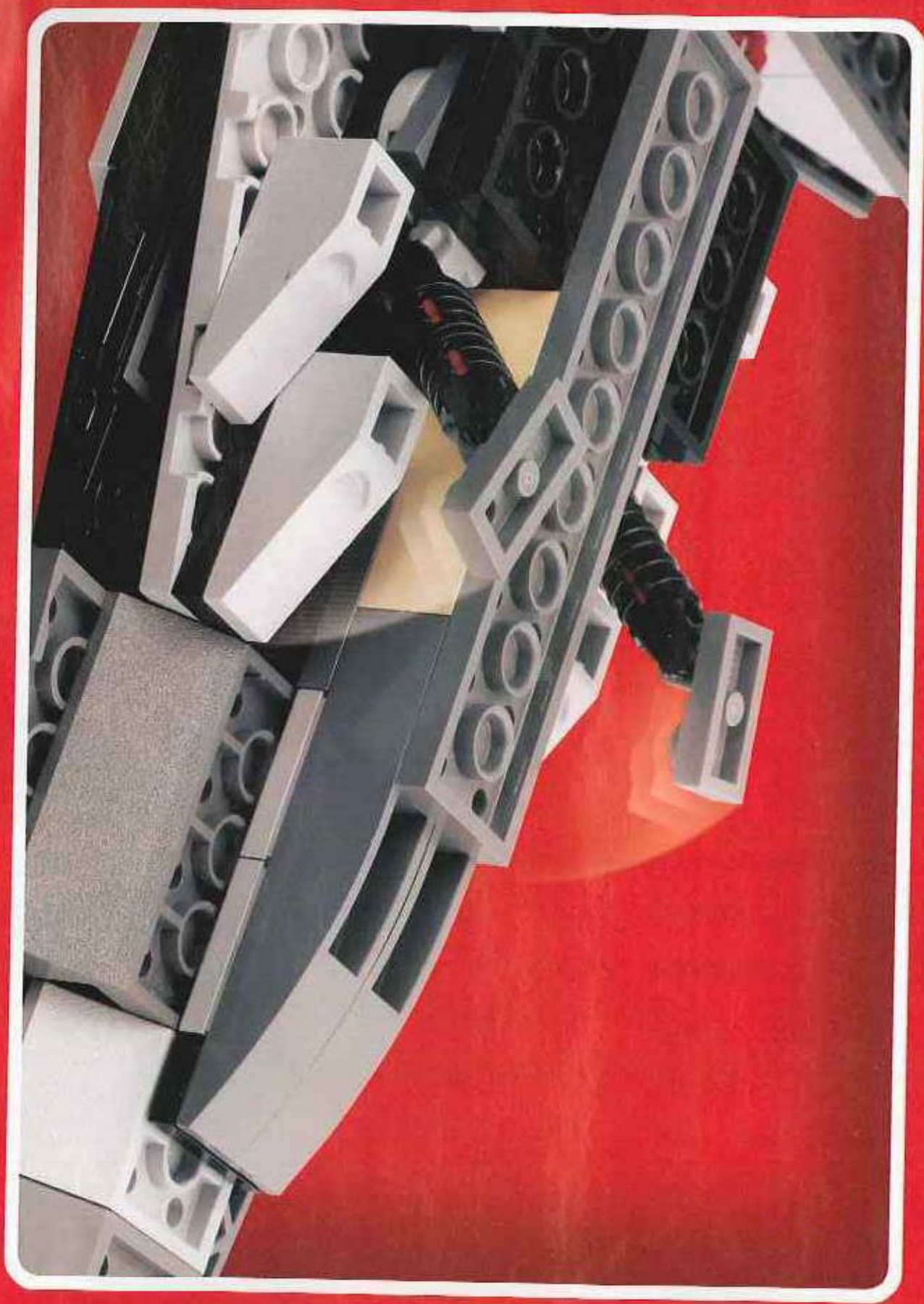

Win! Gagne! 当たります Gewinne!

Win LEGO products

We would like to know what you think about your new LEGO product. Log on to the web address below for further instructions.

Gagne des produits LEGO

Nous aimerions savoir ce que tu penses de ton nouveau produit LEGO. Tu obtiendras davantage d'informations en visitant le site Internet indique ci-dessous.

Gewinne LEGO produkte

Wir sind sehr an deiner Meinung über dein neues LEGO Produkt interessiert. Gehe einfach zu der unten angegebenen Webadresse - dort findest du weitere Informationen.

Estimado usuario LEGO

Al contestar algunas preguntas en inglés, francés, alemán o japonés, en el sitio www.acnielsen.aim.dk/lego, podrás participar en el sorteo de algunos valiosos premios LEGO.

Caro Consumidor da LEGO

Ao responder a algumas perguntas em Inglês, Francês, Alemão ou Japonês no endereço www.acnielsen.aim.dk/lego irá participar num concurso para ganhar valiosos prémios da LEGO.

Kedves Ifjú LEGO Vásárló

Ha ellátogatsz a www.acnielsen.aim.dk/lego honlapra és ott angol, francia, német vagy japán nyelven megválaszolsz néhány kérdést, akkor részt veszel egy versenyben, amelyben értékes LEGO díjakat nyerhetsz.

抽選でLEGO製品が当たります

私たちは、皆さんが思い求めるLEGO製品についてどんな感想をお持ちか、知りたいと思っています。質問に答えて、楽しいLEGO製品の抽選に応募しましょう。アンケートの回答には、ほんの3分ほどしかかかりません！詳しくは、以下のウェブアドレスまでアクセスしてください。

www.acnielsen.aim.dk/LEGO



Any questions regarding your new LEGO product, please contact:

Customer Service | Kundenservice

Service Consommateurs

Servicio Al Consumidor at

www.lego.com/service or dial



00800 5346 5555



1-800-422-5346

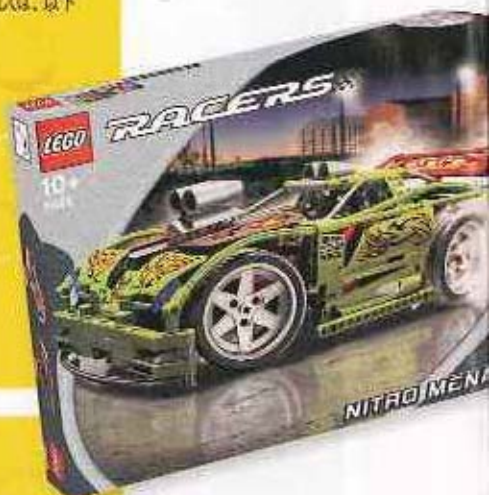

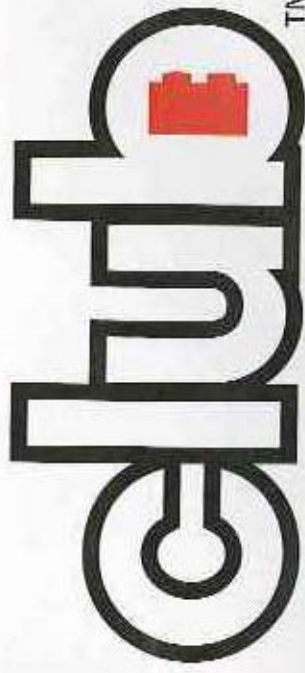

TM

FREE LEGO Magazine • GRATUIT • GRATIS LEGO Magazin



Join Today!
Abonne-toi
dès aujourd'hui !
Meld je nu aan!
Jetzt anmelden!



US & Canada only

1-866-534-6258 / 1-877-518-5346
(en Français)

00800 5346 5555



www.LEGOclub.com

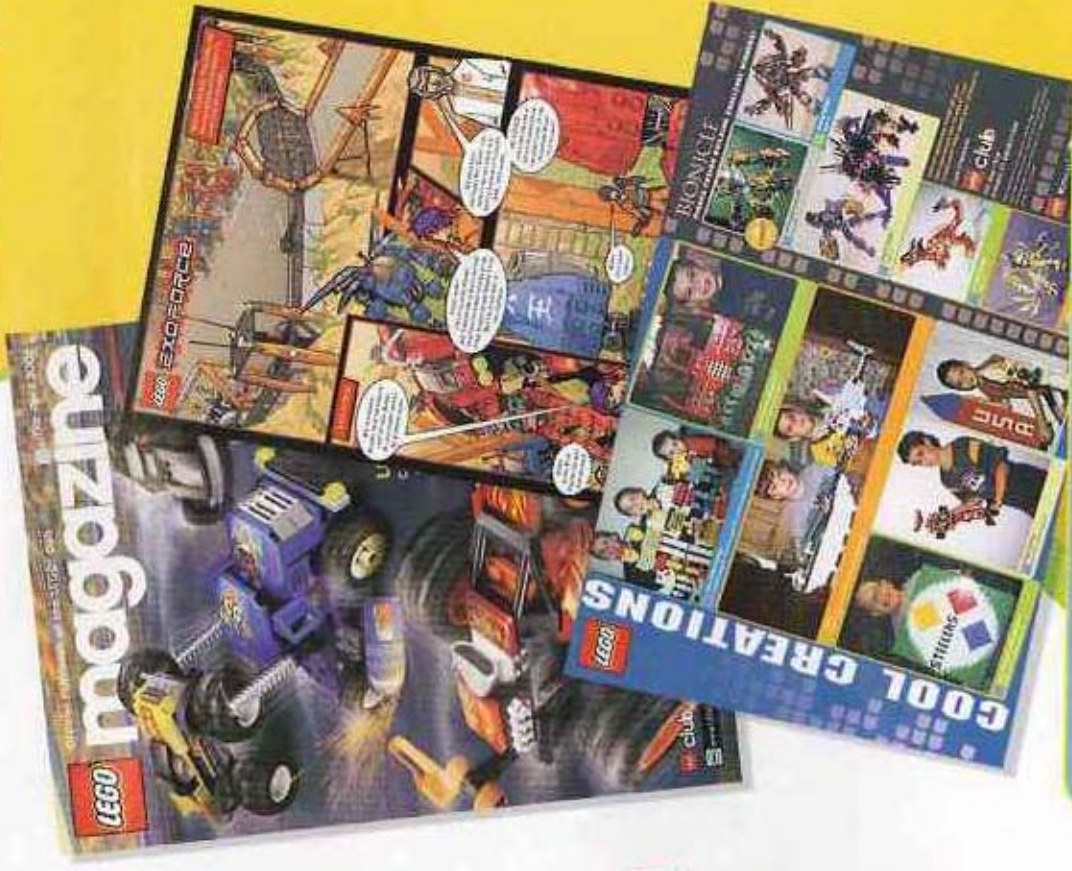

VISIT THE
WORLD'S BIGGEST
LEGO® SHOP!
www.LEGOshop.com

