

744

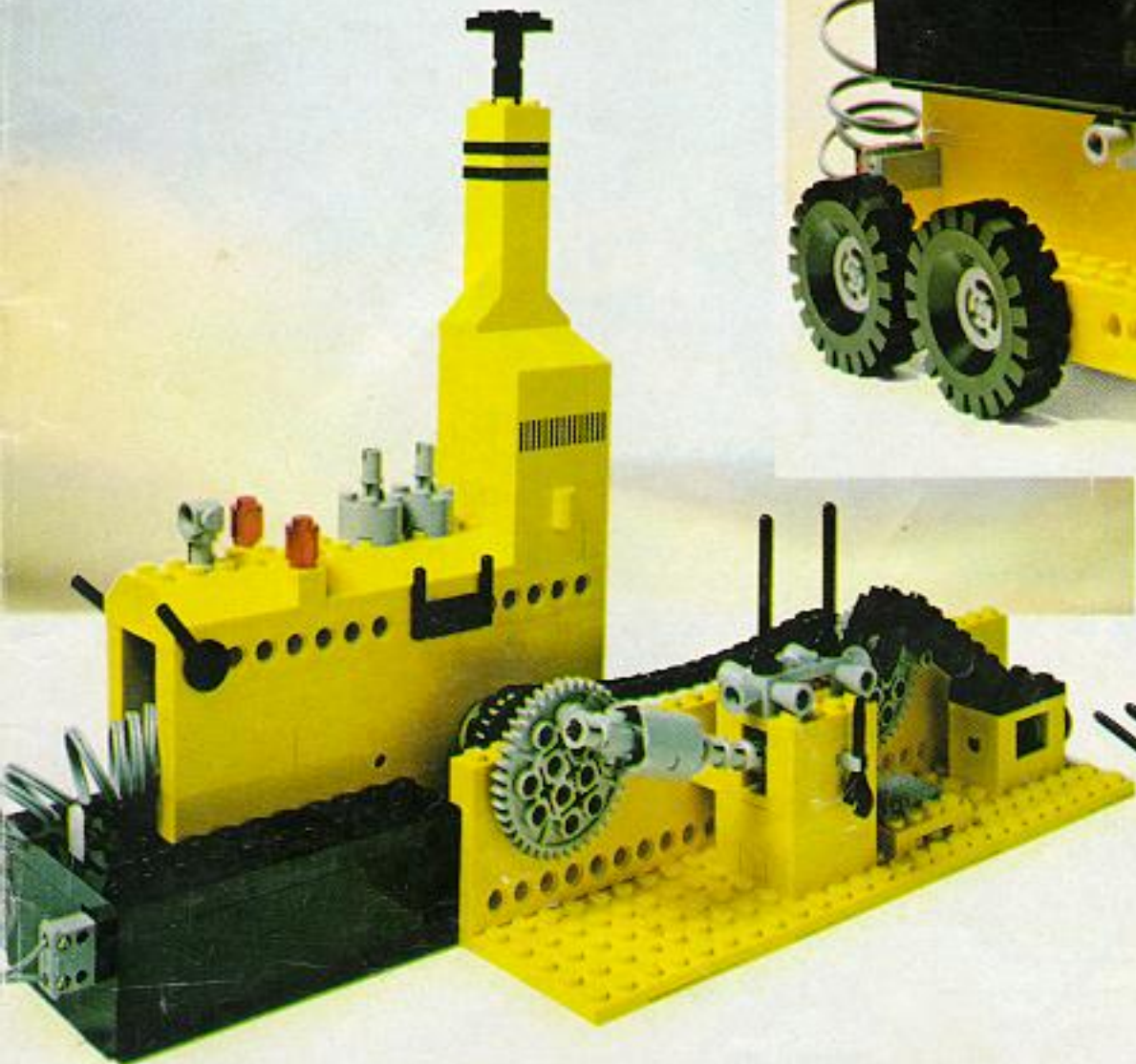

# Here's how your LEGO® Motor works.

## Comment fonctionne le moteur

## Zo komt je batterijmotor in aktie.



○ The battery box is opened by loosening the screw in the bottom. When the lid has been removed, the arrows in the bottom of the box show you how to place the three 1,5 volt batteries.

○ Now select the type of wheels or gears you wish to use and attach them to the motor. You can use the long axle rods which take both gears and special wheels, or if you have wheels with metal axles you can use them as well.

○ Pour ouvrir le boîtier à piles, tourner la vis qui est au fond. Une fois le couvercle retiré, les flèches indiquent comment placer les 3 piles 1,5 V.

○ Choisir maintenant les roues ou engrenages et les assembler au moteur. On peut utiliser des axes longs qui relient les engrenages et les roues ou bien des roues munies d'axes métalliques.

○ Verwijder de deksel aan de bovenzijde van de batterijhouder, na eerst de schroef aan de onderkant te hebben losgedraaid.

Plaats de 3 korte 1½ Volt staaf-batterijen in de houder volgens de pijl-aanwijzing op de bodem.

○ Kies nu de wielen of asjes die je wilt gebruiken en monteer ze in het motorhuis. Zowel wielen met metalen assen als (lange) losse assen met bijpassende wielen of tandwielen passen.

## Motor Maintenance Tips:

## Conseils d'entretien

## Motortips

○ If your motor doesn't work, check that all connections are tight and that your batteries are correctly placed in the box. If it still does not work, replace the batteries. When batteries go dead, always remove them, or they may leak acid and destroy the battery box.

○ Never push your motor or allow it to come into contact with water. Both can damage it.

○ Never unplug the wire by pulling the wire. Always pull out the plugs themselves.

○ There is no need to oil the motor and gear-box, as this has already been taken care of.

○ The motor is suppressed, so that radio and television reception is not disturbed.

○ Si le moteur ne fonctionne pas, vérifiez les raccords et la position des piles. S'il ne marche toujours pas, changez les piles. Quand celles-ci sont usées, retirez-les toujours. Sinon de l'acide peut s'en échapper et abîmer le boîtier.

○ Ne jamais pousser le moteur ou le mettre en contact avec l'eau. Cela l'endommagerait.

○ Ne jamais tirer sur le cordon électrique pour débrancher. Tirez toujours les fiches elles-mêmes.

○ Il n'est pas nécessaire de graisser le moteur ni le boîtier à piles. Cela a déjà été fait.

○ Le moteur est antiparasité.

○ Wil de motor niet direkt starten, controleer dan of alle verbindingen in orde zijn en of de batterijen op de juiste wijze in de batterijhouder zijn gelegd. Als de motor nog niet start, vervang dan de batterijen. Wanneer je de batterijen voor langere tijd niet gebruikt haal ze dan uit de batterijhouder. Want batterij-zuur kan de metalen delen van de batterijhouder onherstelbaar aantasten.

○ De motor gaat kapot als je hem met water in aanraking of met de hand in beweging brengt.

○ Trek nooit aan het snoer, maar gebruik de stekker, wanneer je het snoer uit de motor of batterijhouder wilt halen.

○ De motor en het drijfwerk zijn zelf-smerend, dus geen olie gebruiken!

○ De motor is storingvrij, zodat radio- en televisie programma's niet worden gestoord.

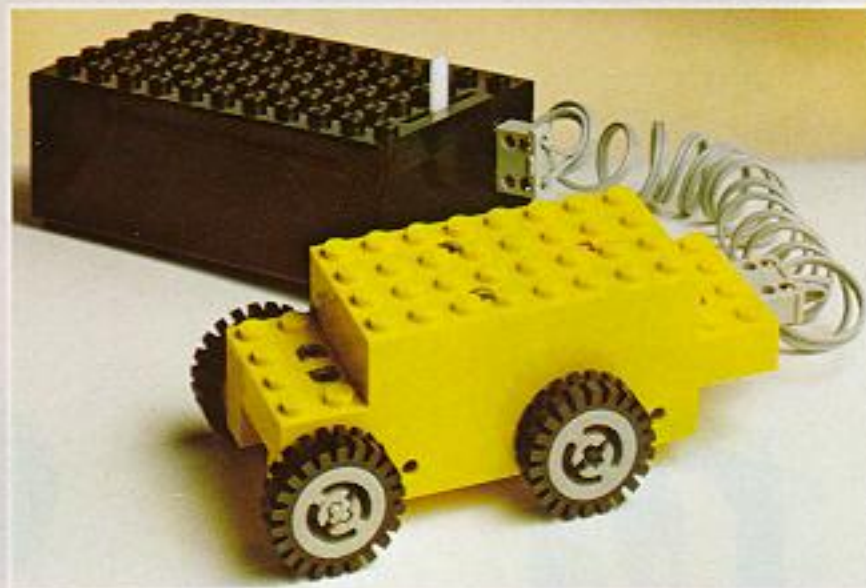

○ The motor and the battery box are connected with the wire. There is a socket at one end of the battery box, and a choice of three alternative sockets on the motor.

○ When the switch on the battery box is in the centre position the current is cut off. Push it to one side and the model goes forward. Push it the other way to go backwards.

○ Le moteur et le boîtier sont reliés par un fil électrique. Sur un côté du boîtier, se trouve une prise et sur le moteur 3 possibilités de branchement.

○ Quand le commutateur du boîtier est sur la position centrale, le courant est coupé. Poussez-le d'un côté pour faire avancer le modèle, de l'autre pour le faire reculer.

○ Verbind het stopcontact aan de voorkant van de batterijhouder nu via het snoertje met 1 van de 3 paar contacten van het motorhuis (naar keuze).

○ Als de schakelaar, op de weer gesloten deksel van de batterijhouder, in het midden staat draait de motor niet. Links of rechts zullen 4 wielen vóór- of achteruit draaiend worden aangedreven.

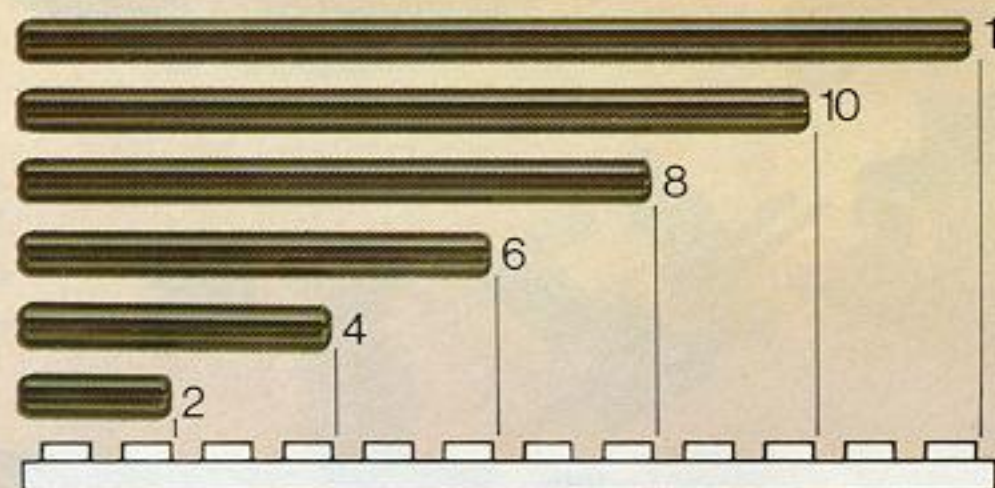

○ Numbers in the building instructions near axles show the length of axle to be used.

○ Dans les notices de montage, les chiffres qui figurent près des axes indiquent la longueur de l'axe à utiliser.

○ Getallen naast de asjes, afgebeeld in het bouwvoorbeeld, geven de lengte aan van de toe te passen asjes.



1

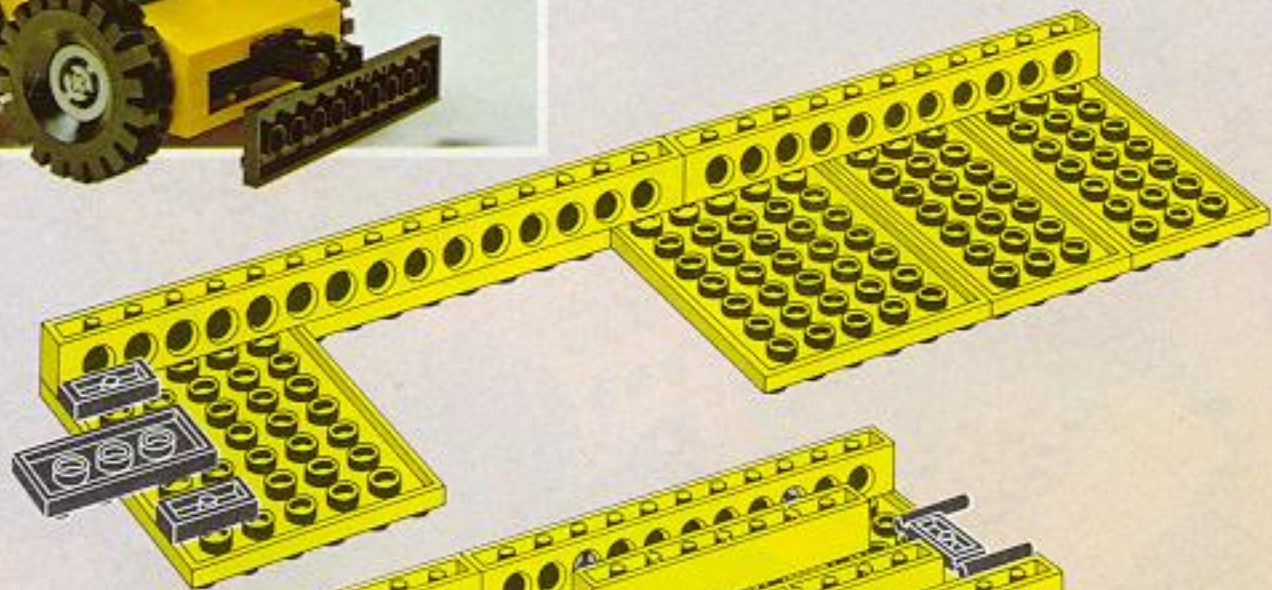

2

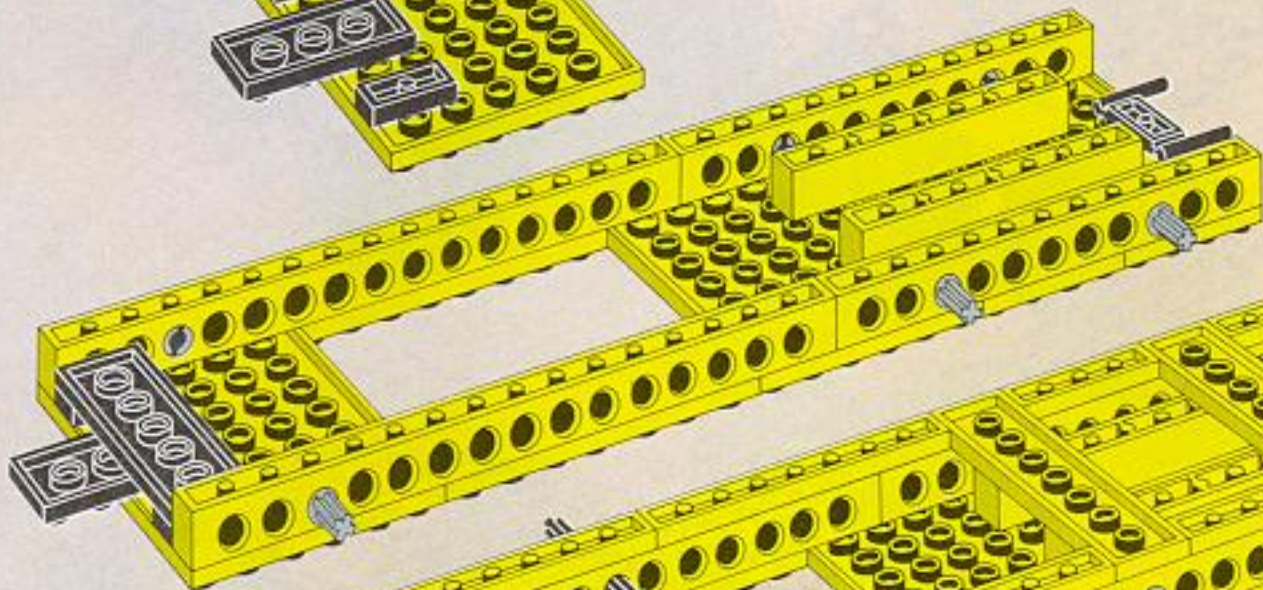

3

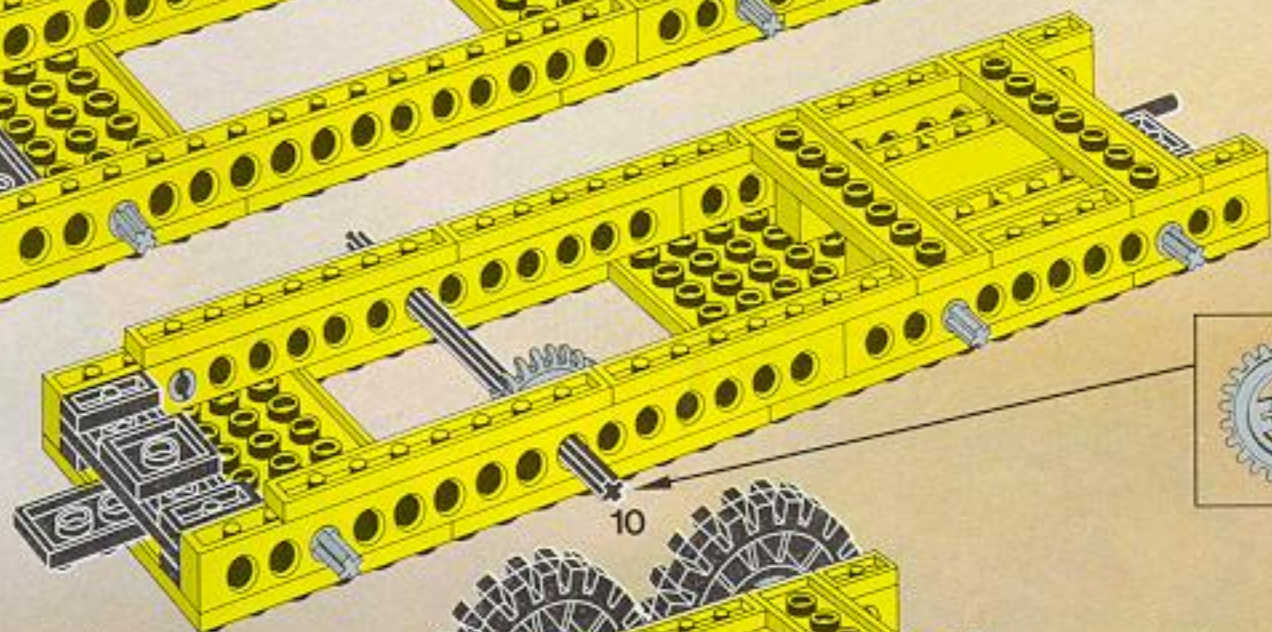

4

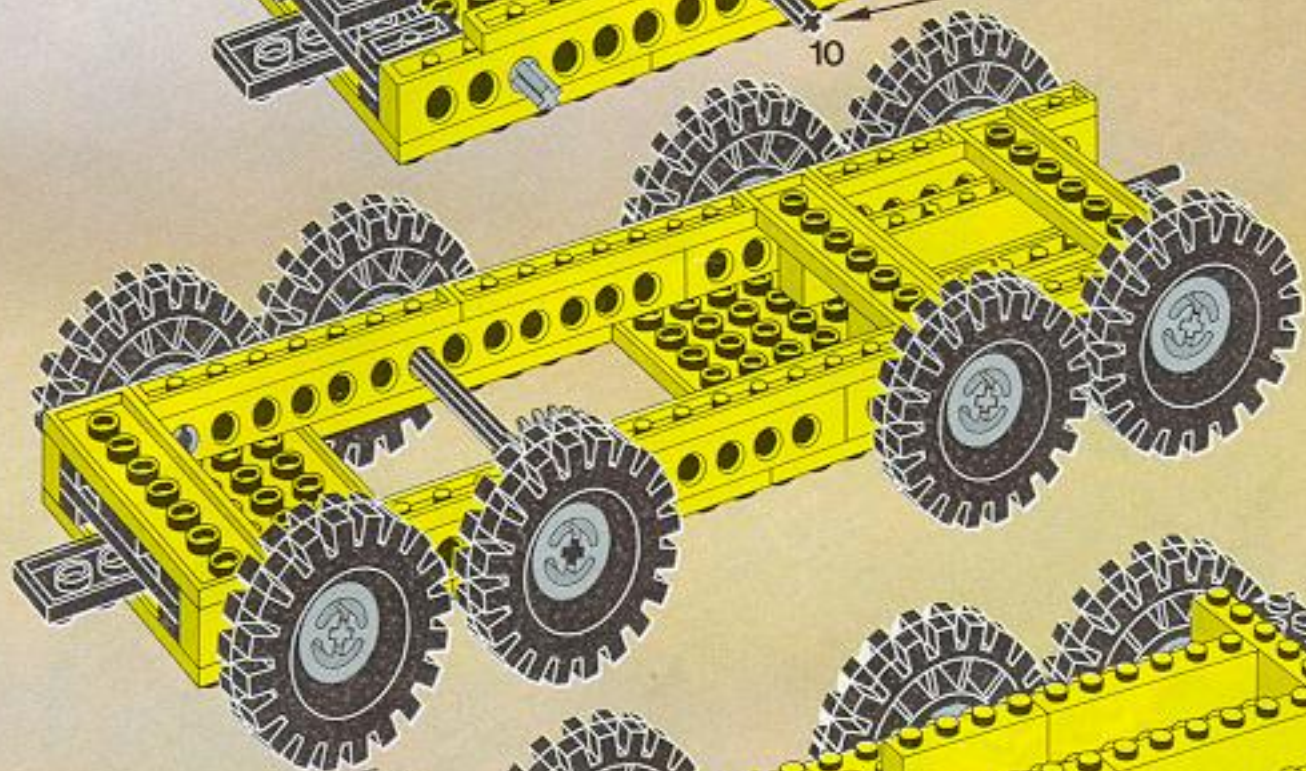

5

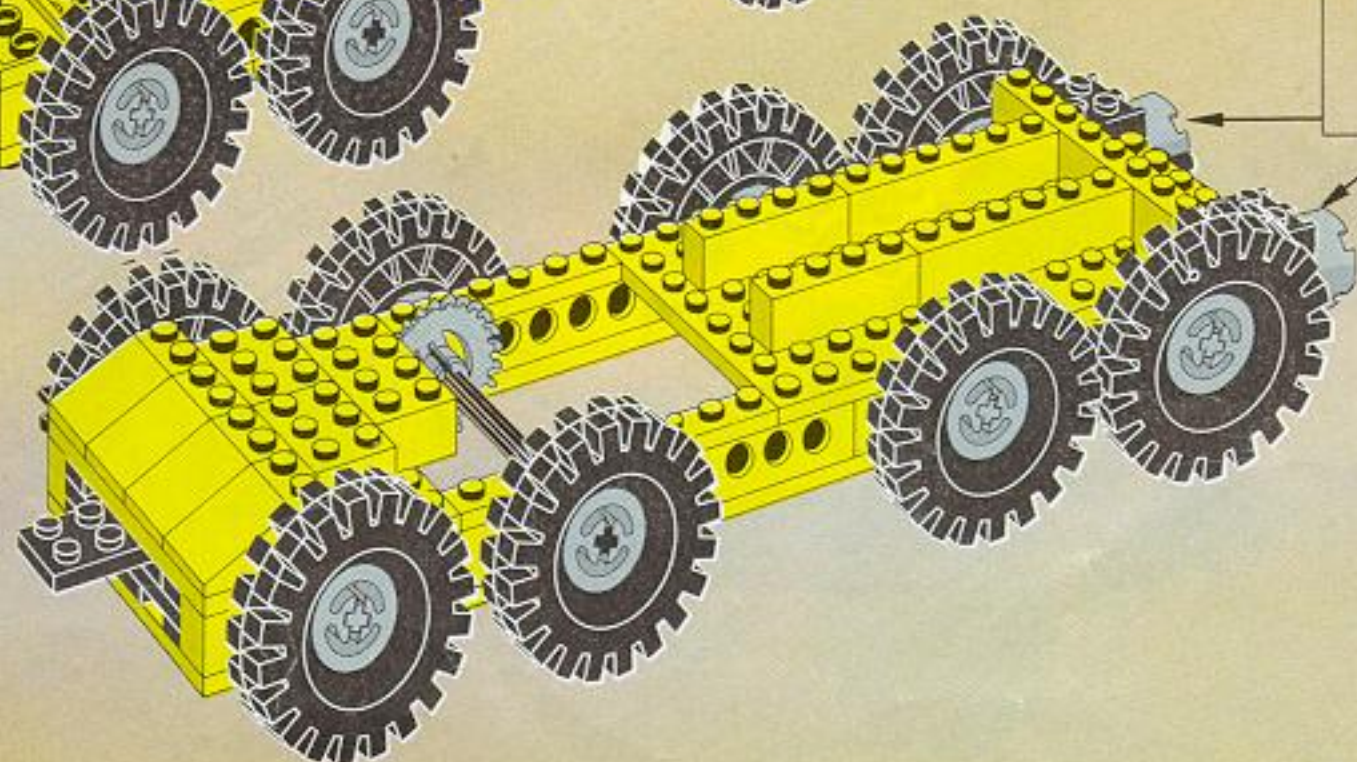

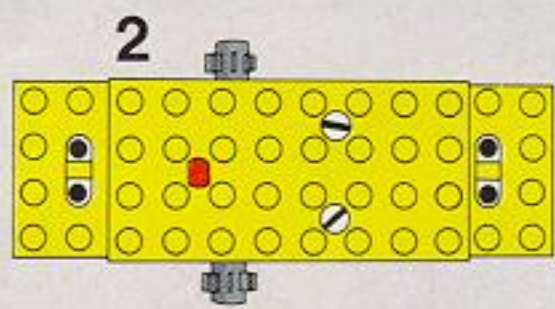
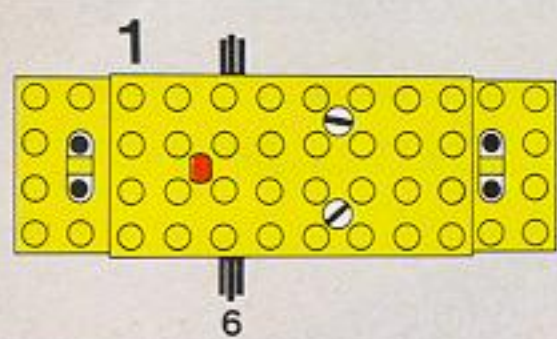

6

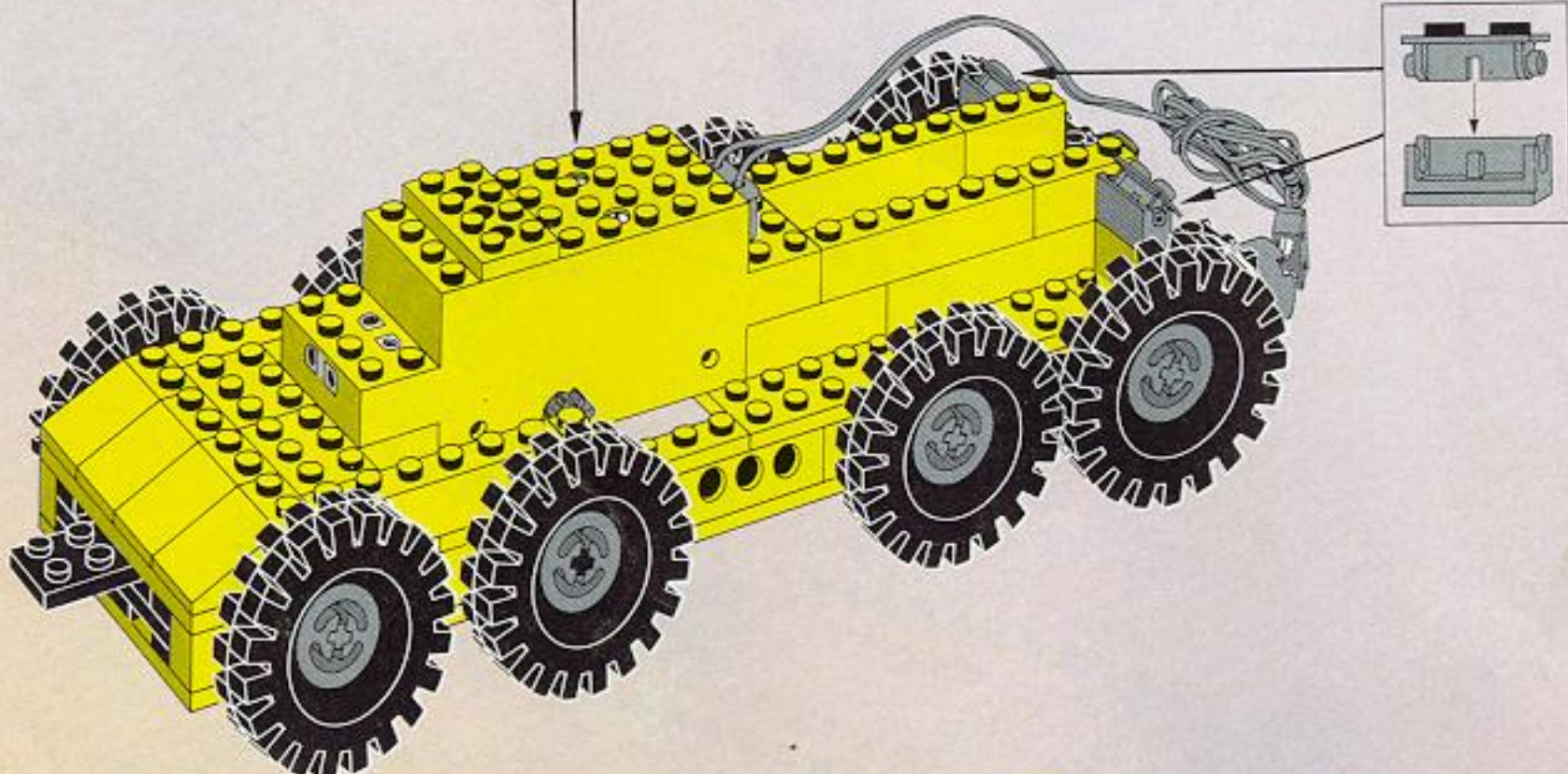

7

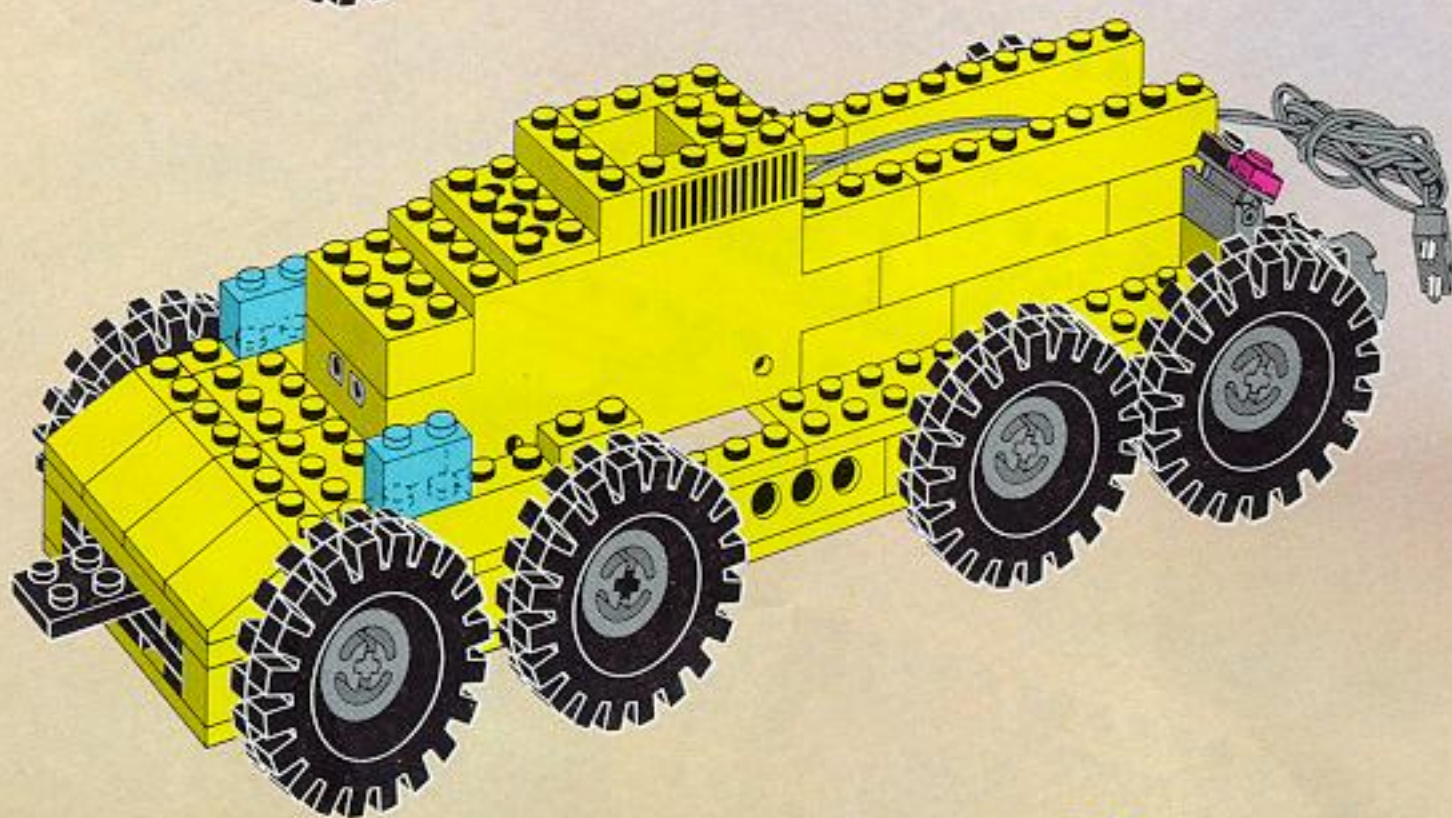

8

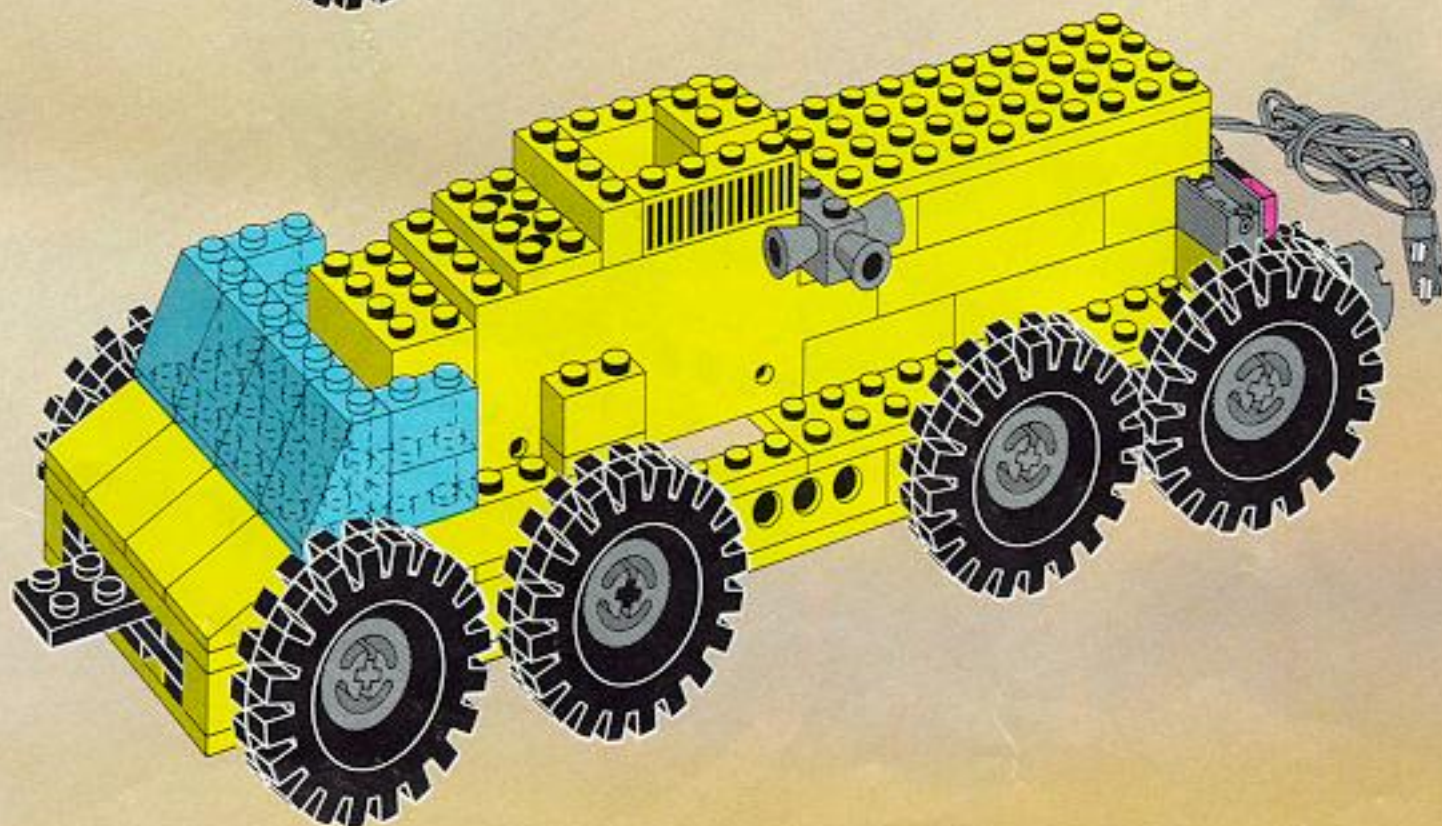

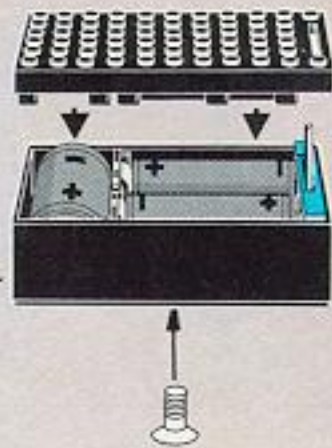
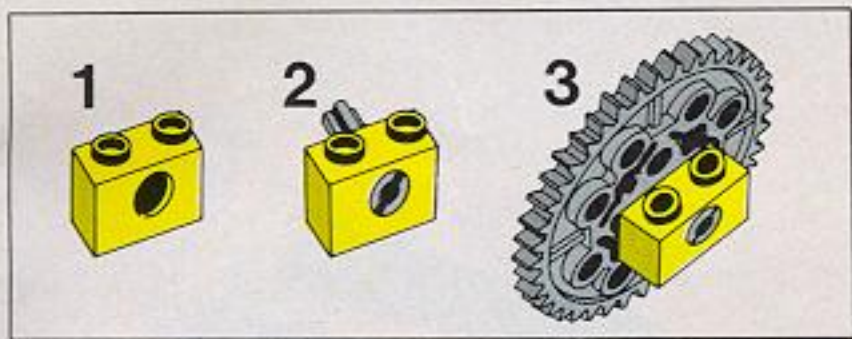

9

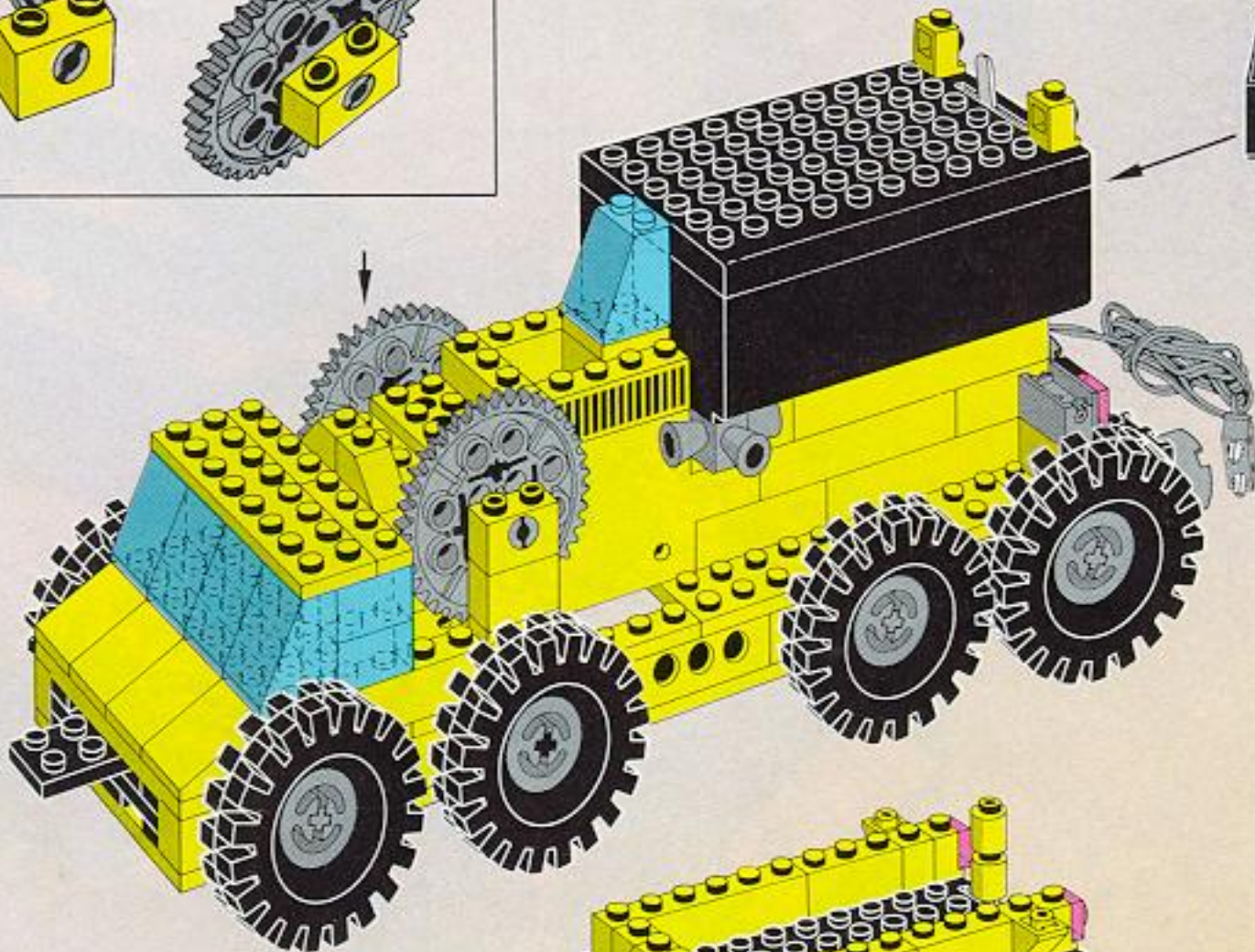

10

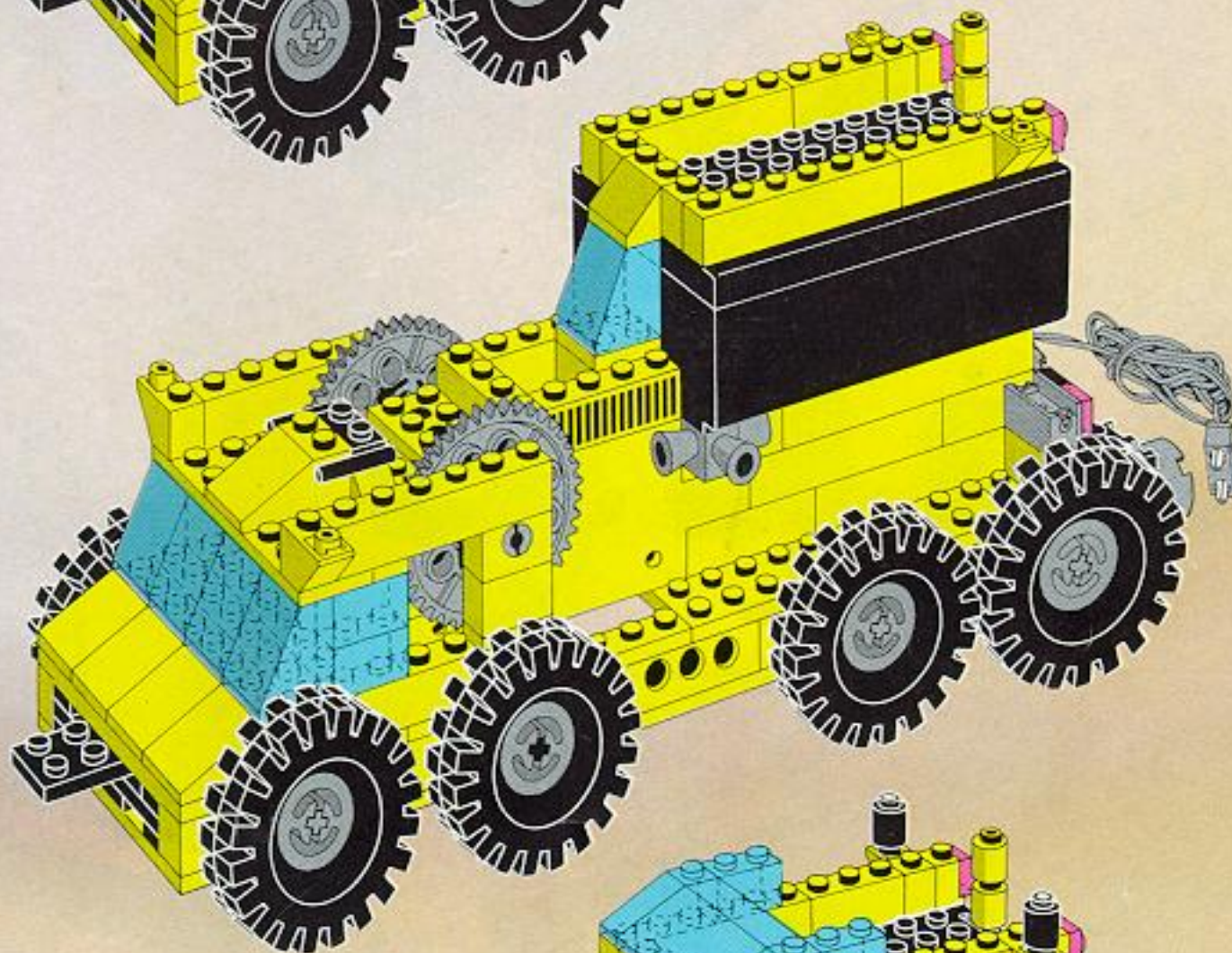

11

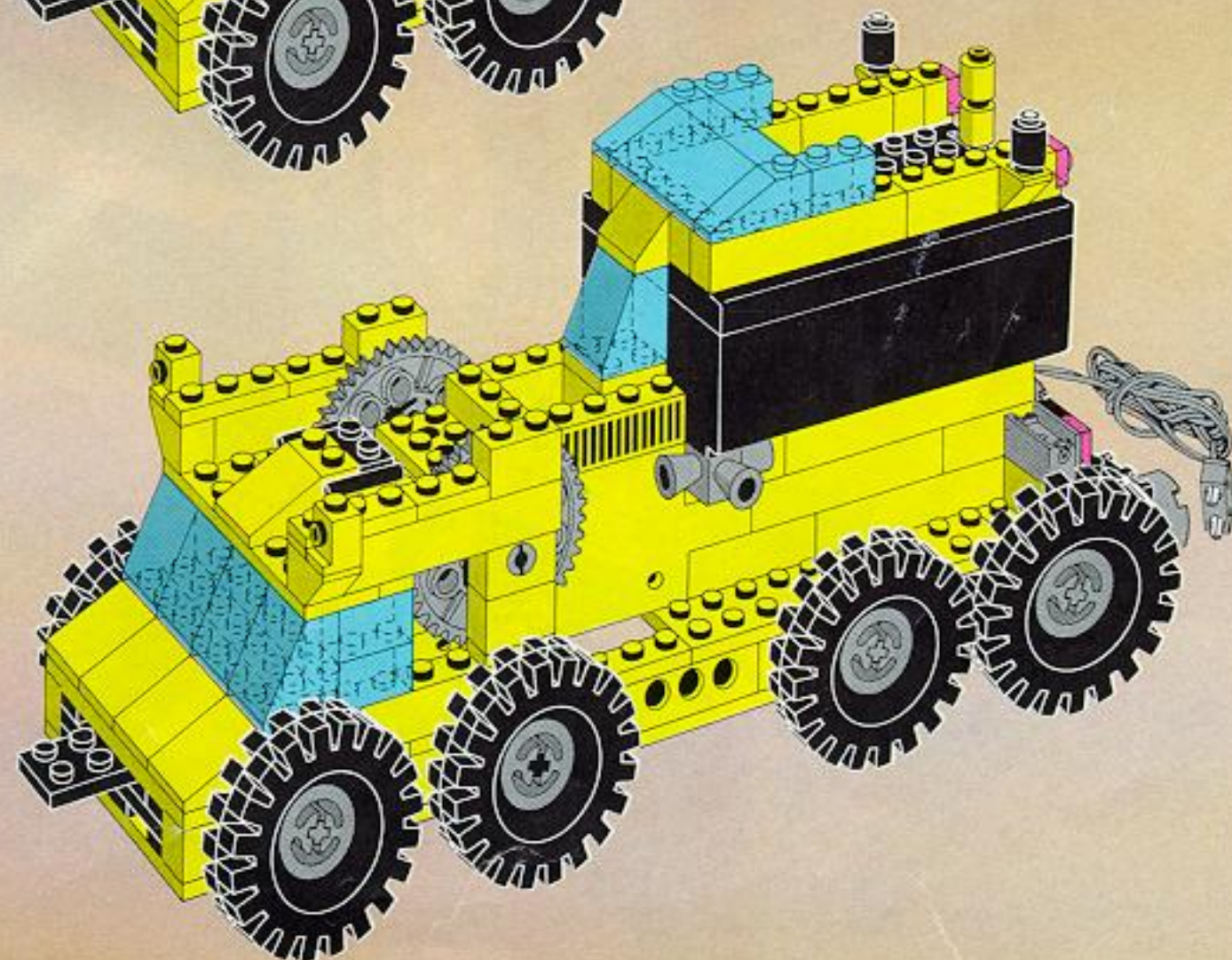

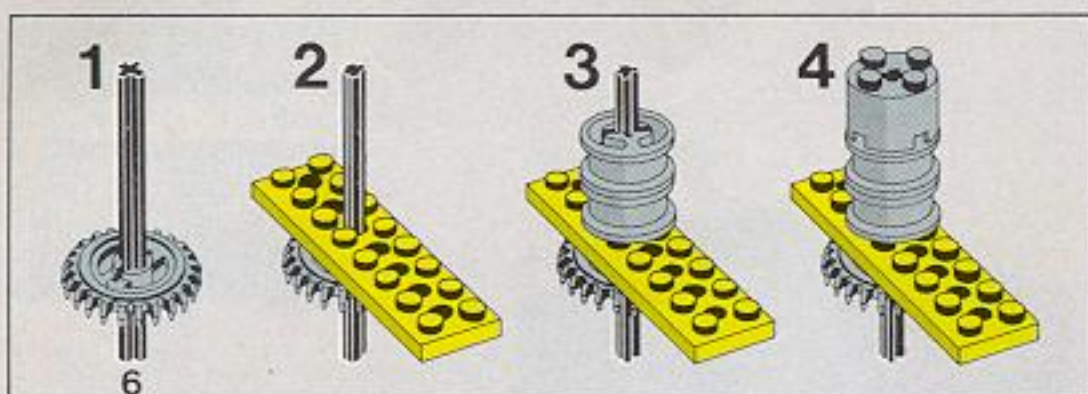

12

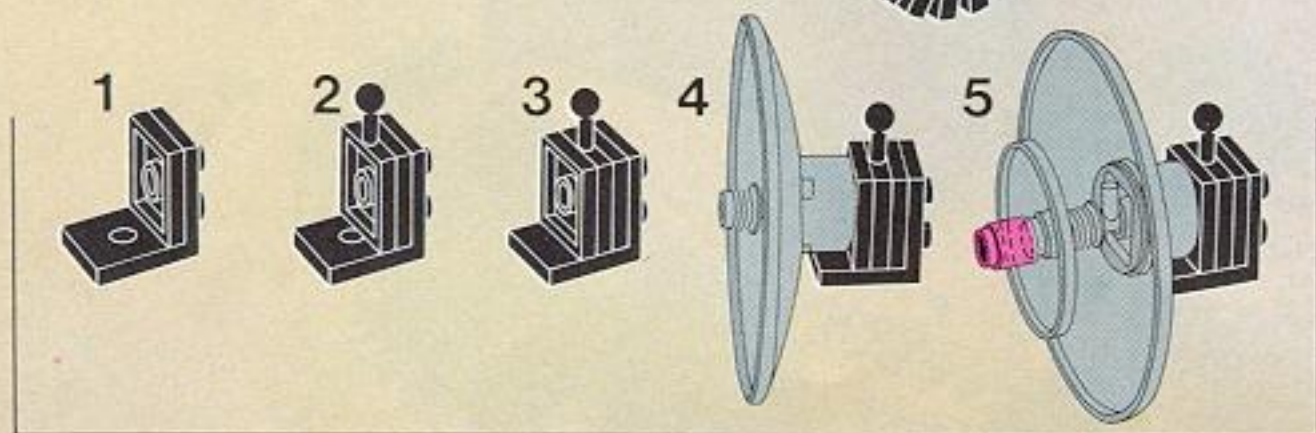
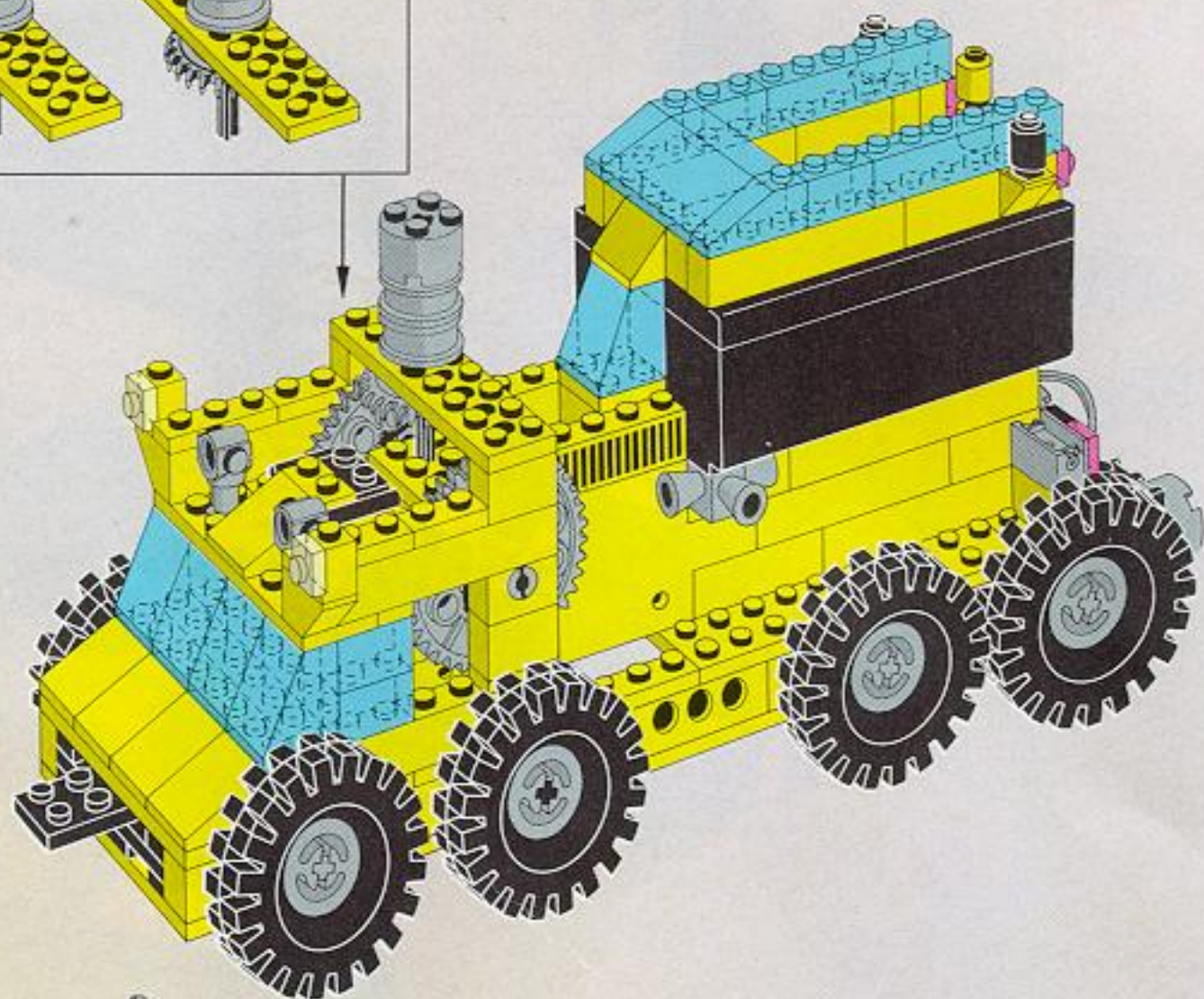

13

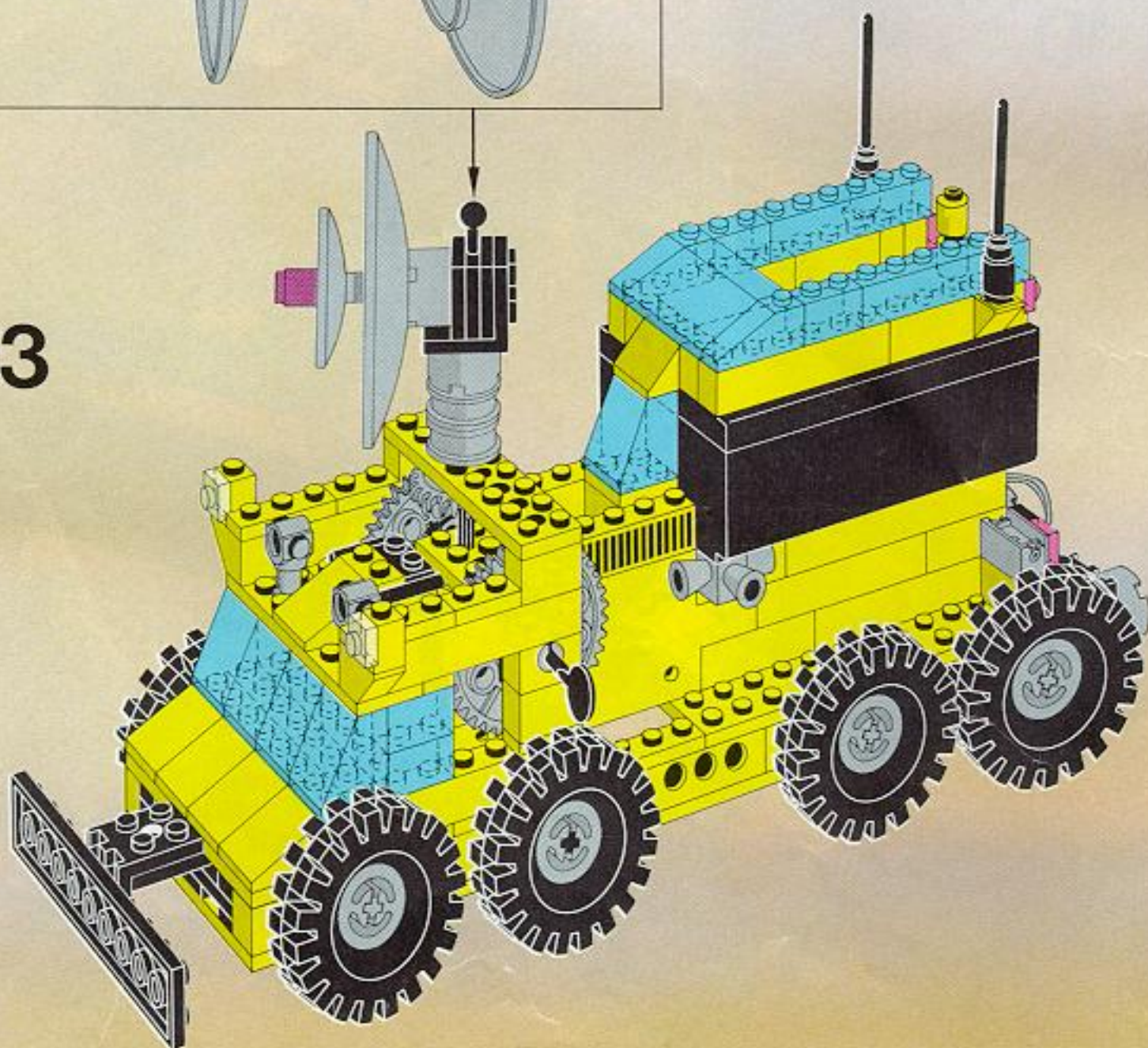

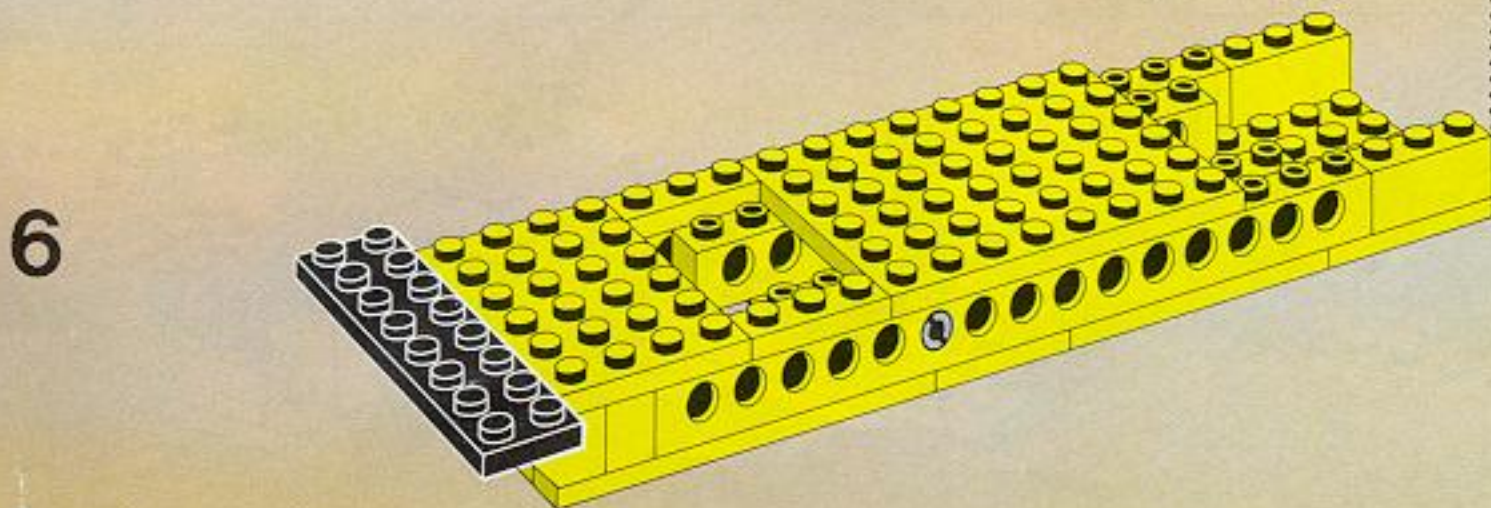
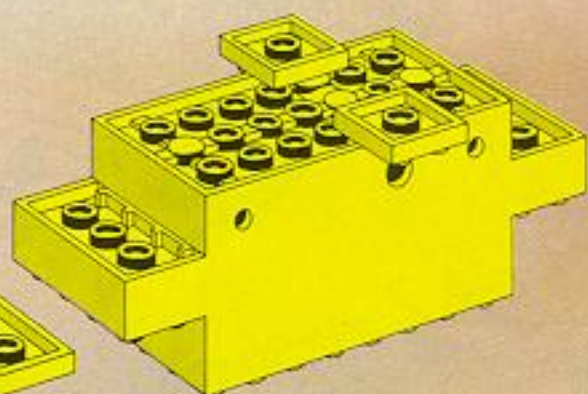
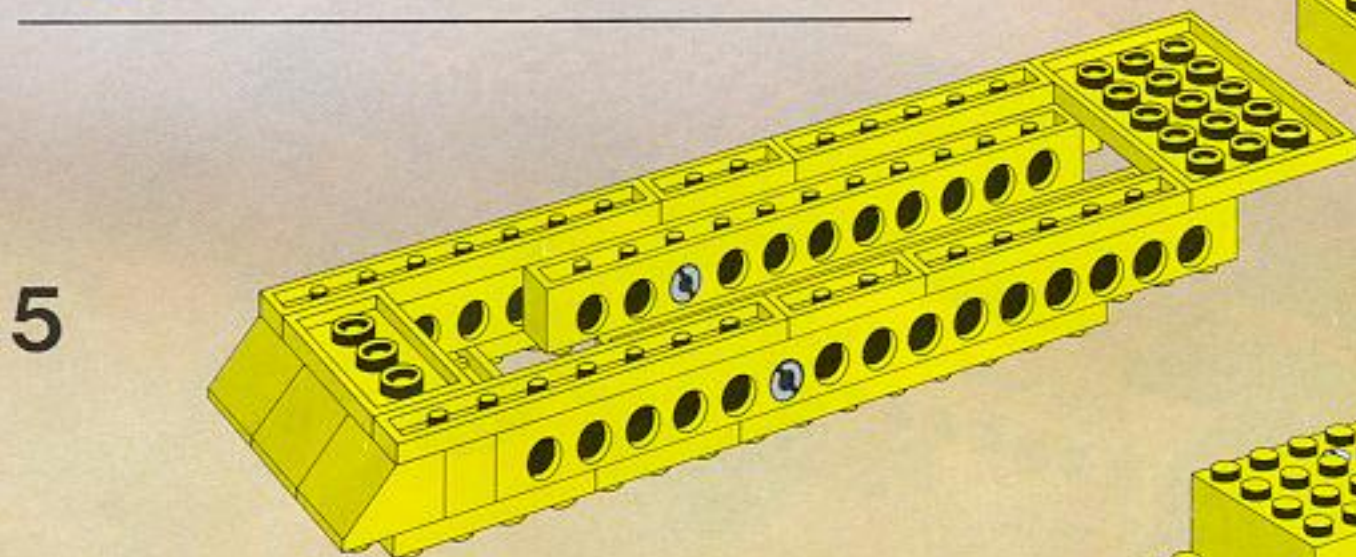
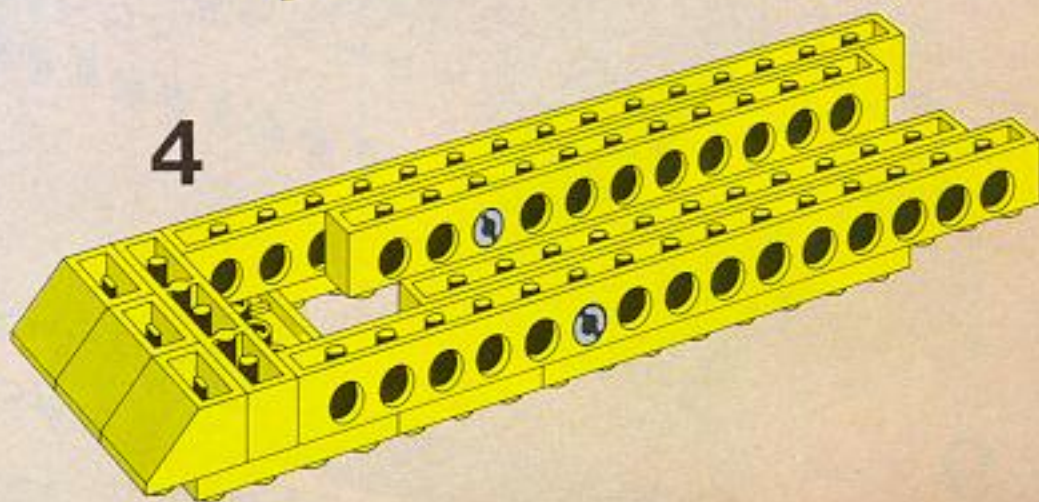
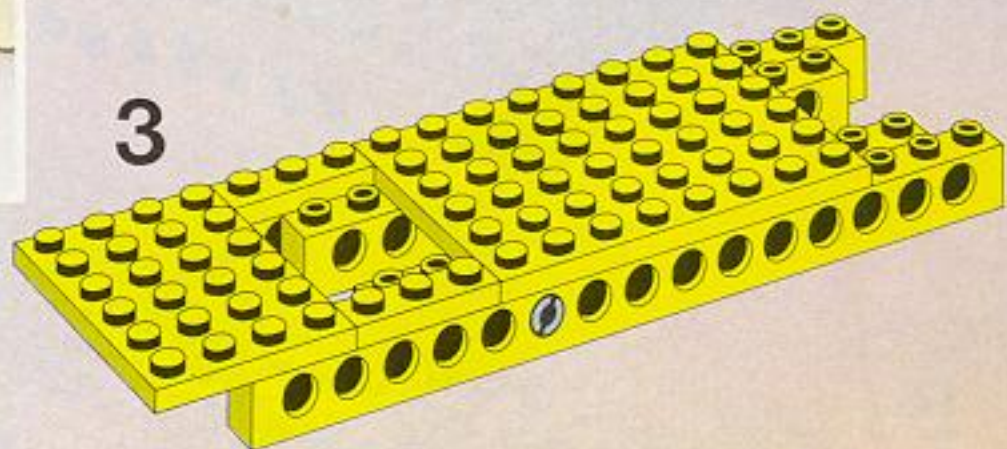
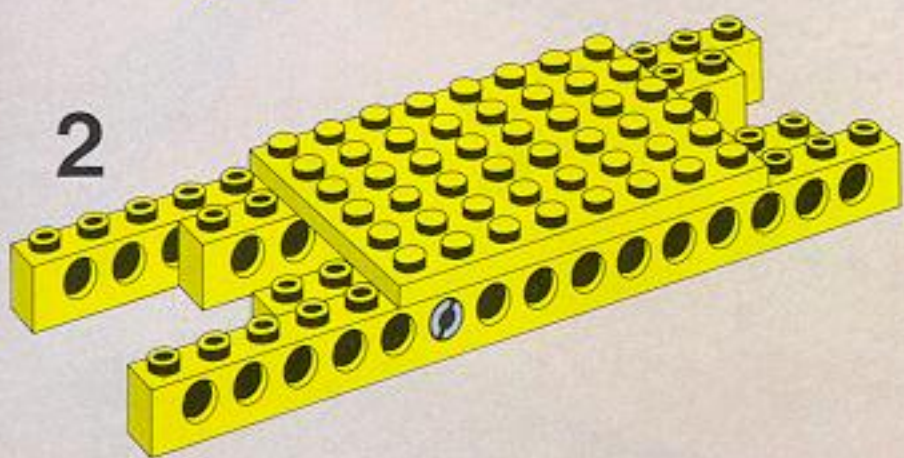
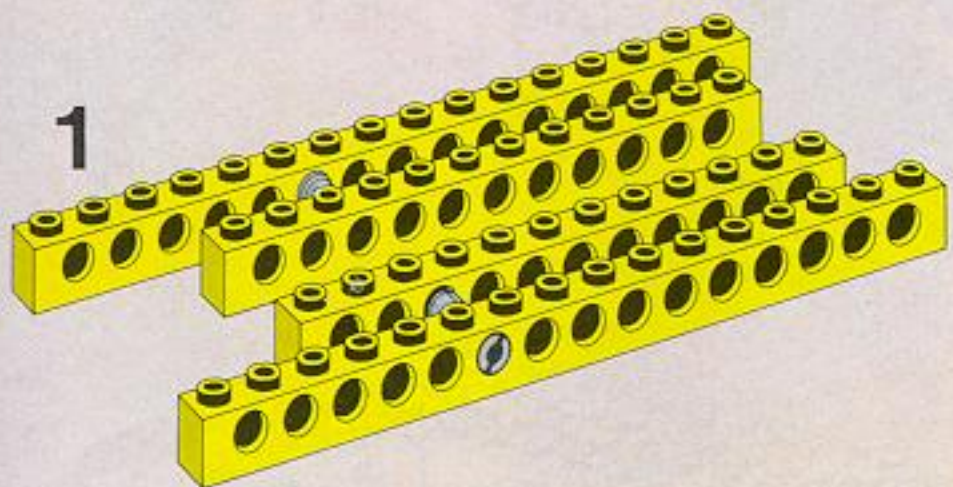

7

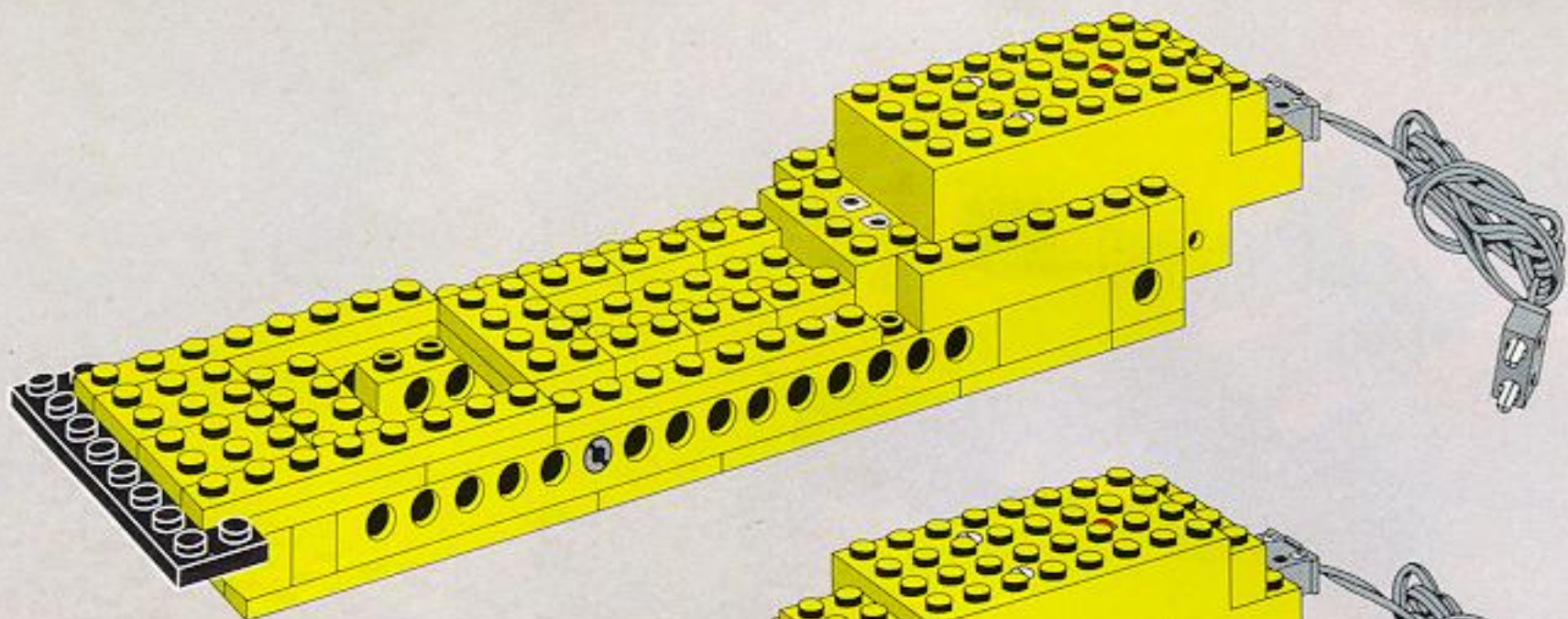

8

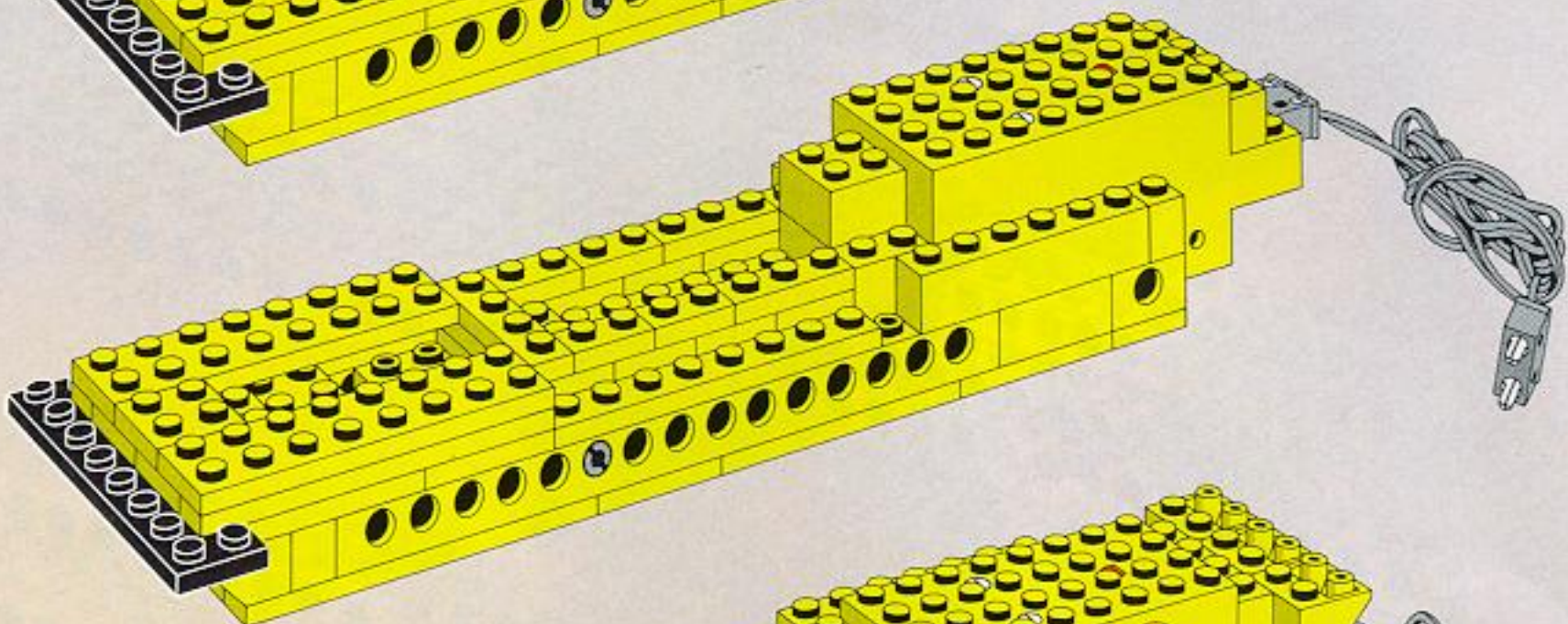

9

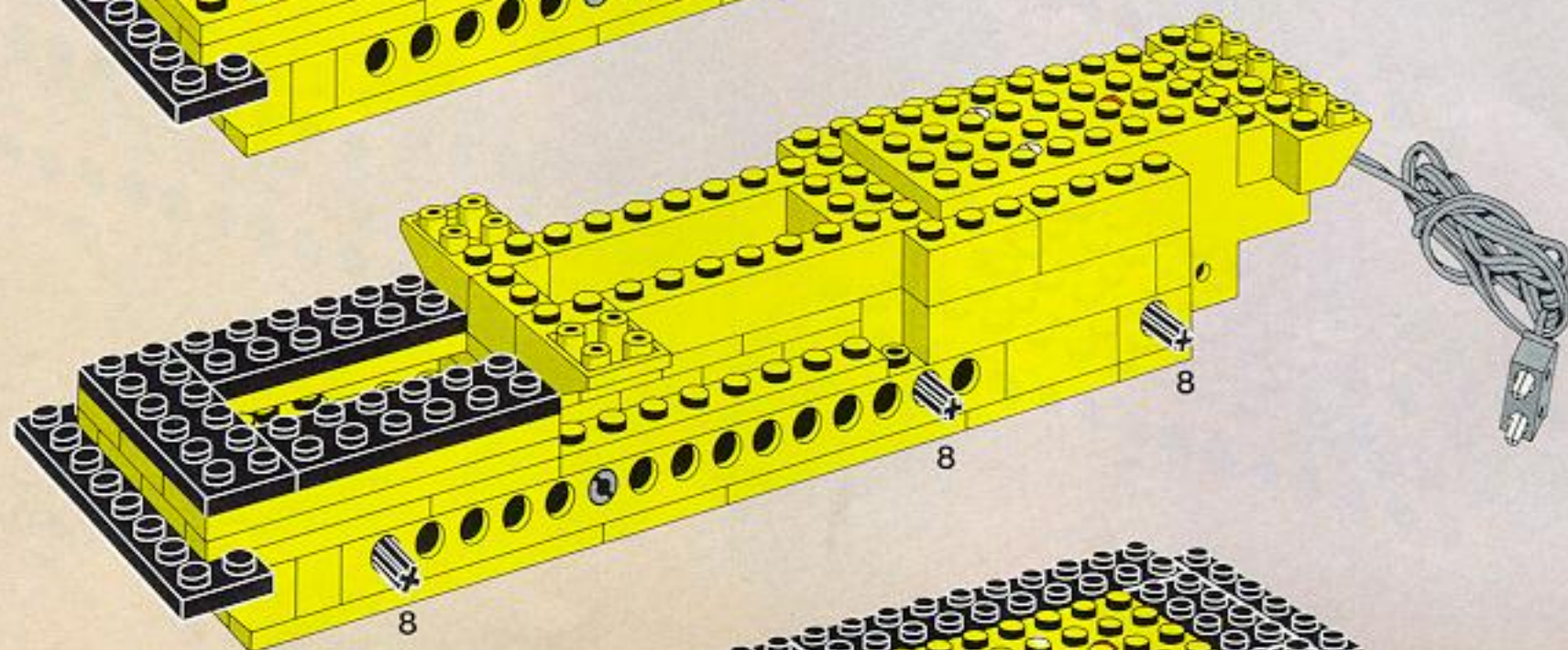

10

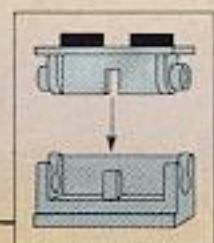
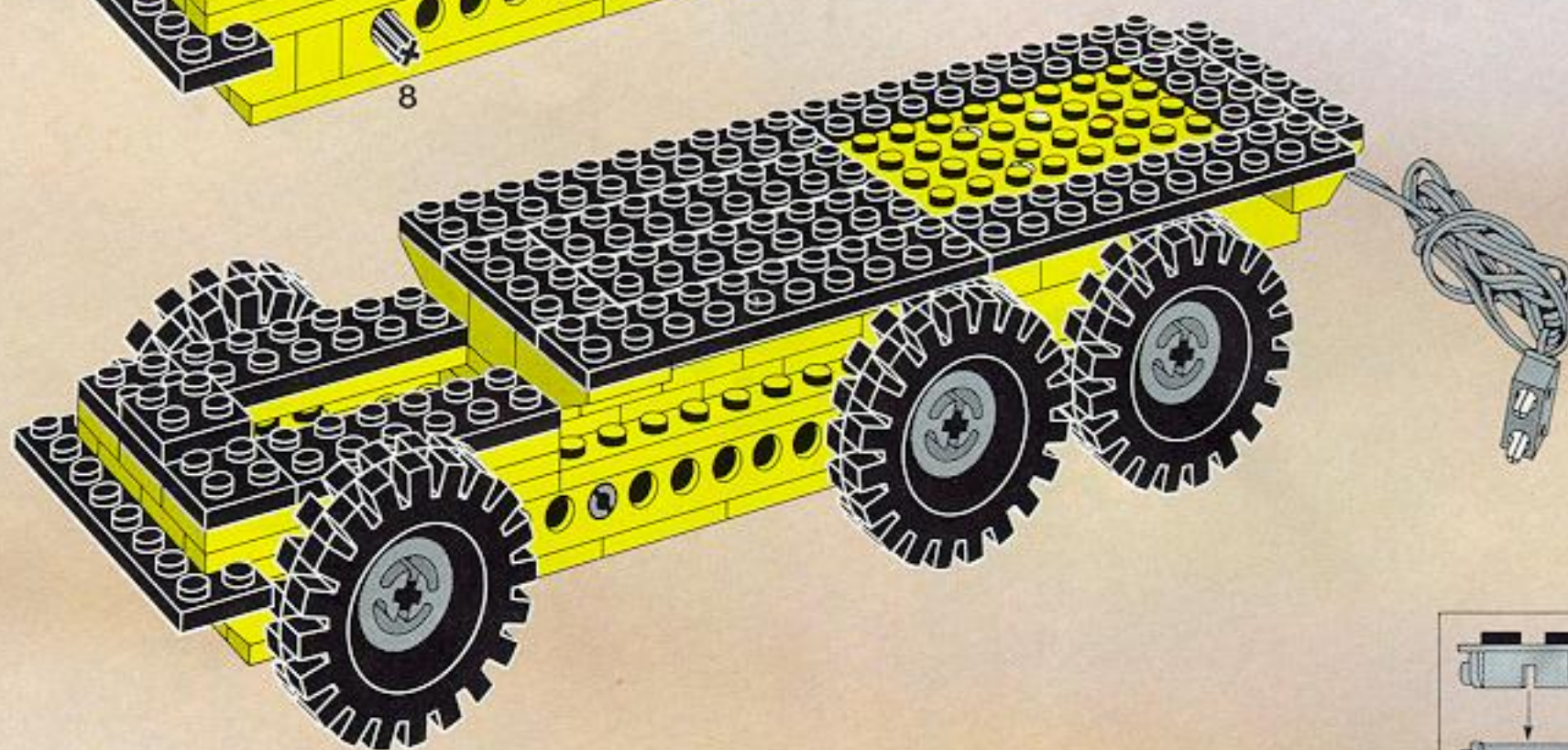

11



12

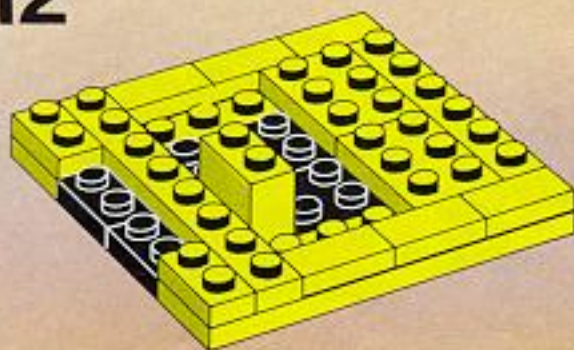

13

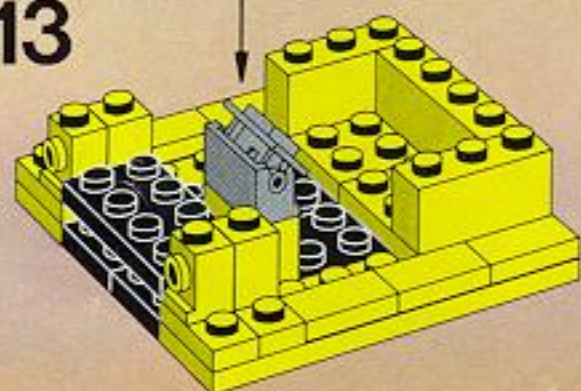



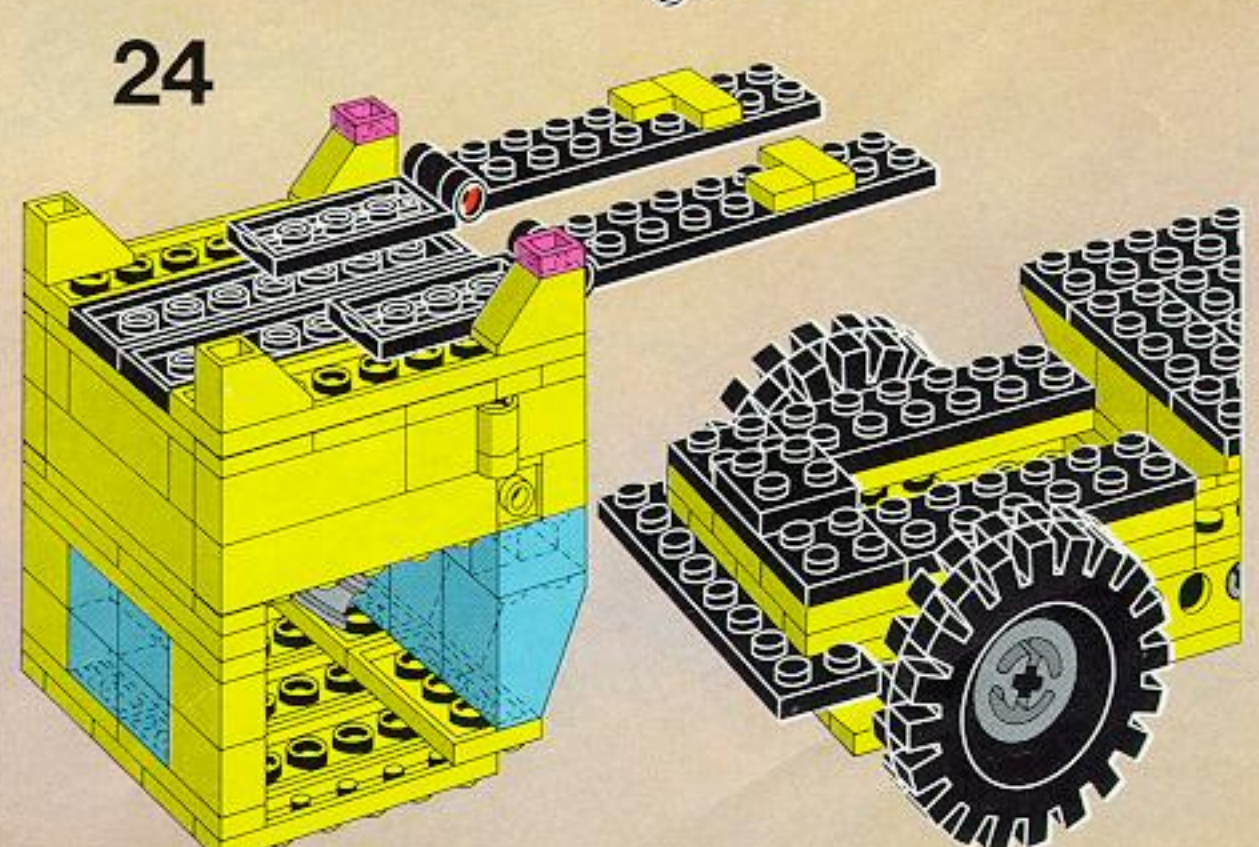
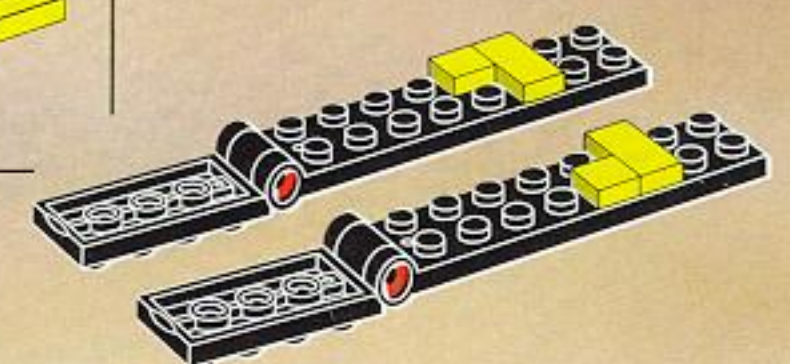
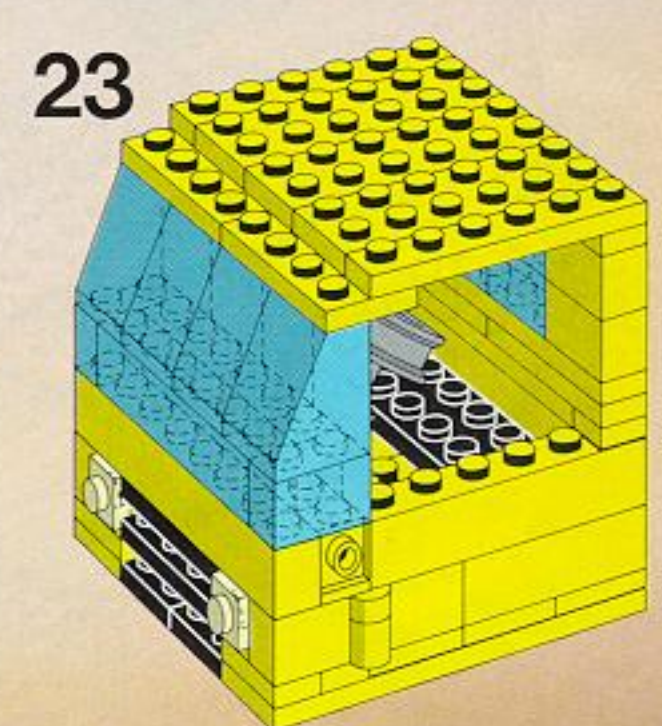
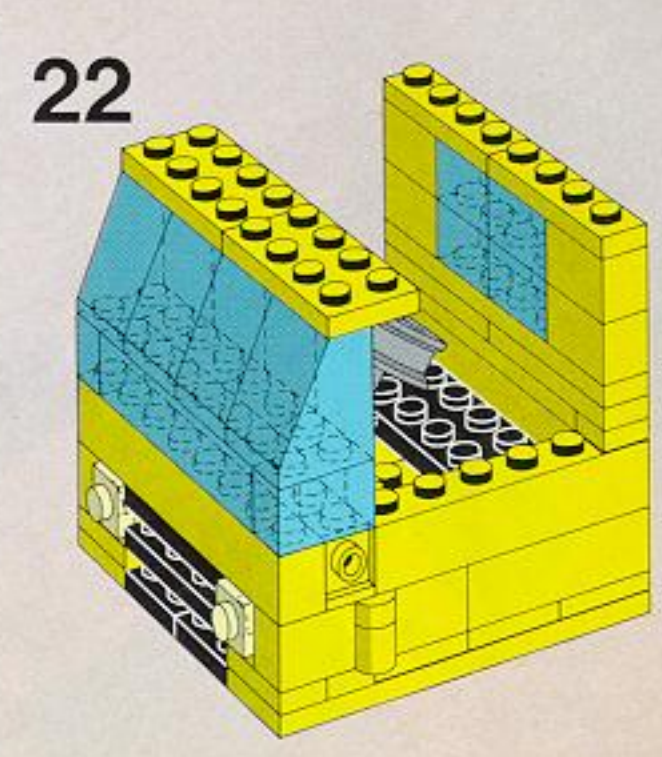
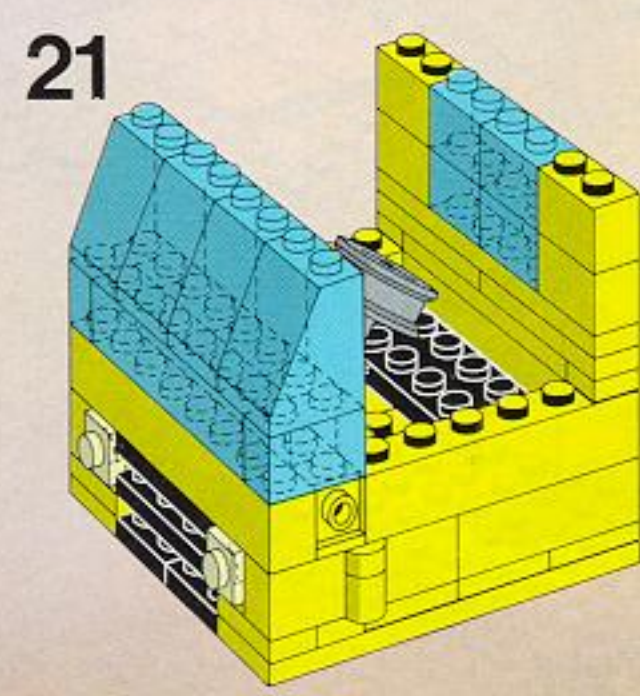
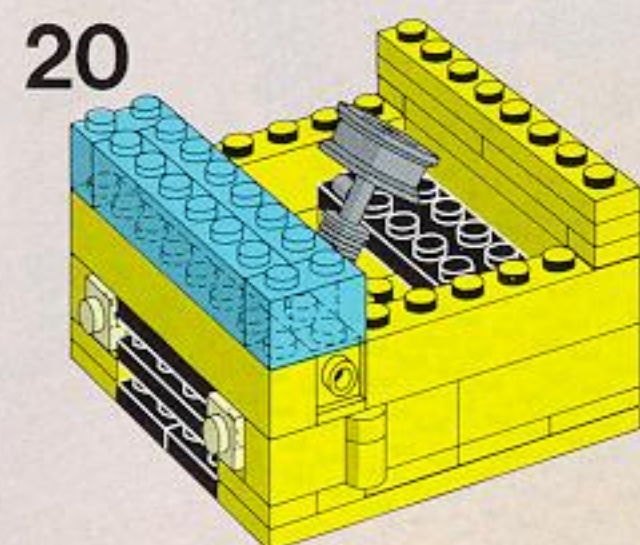
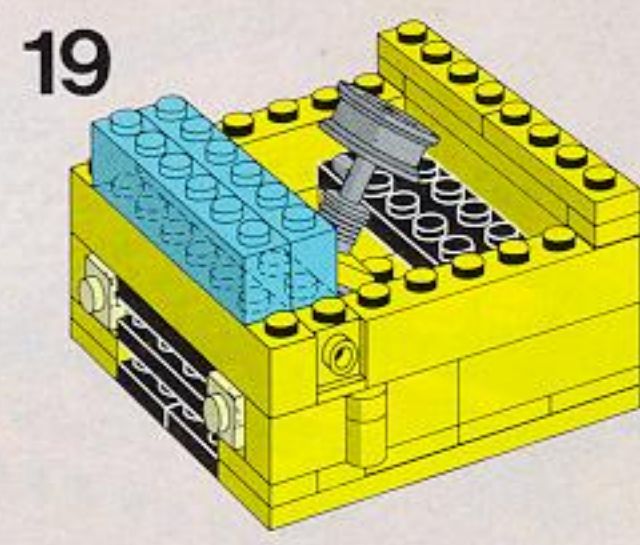
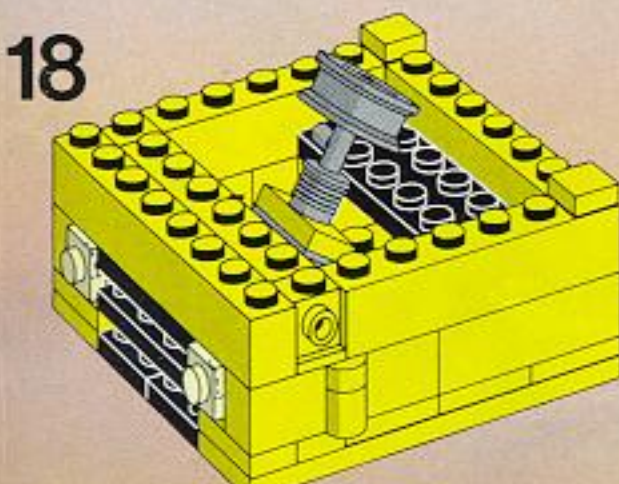
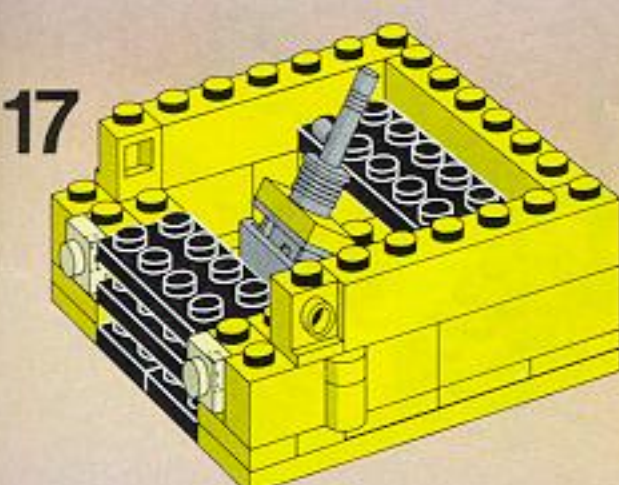
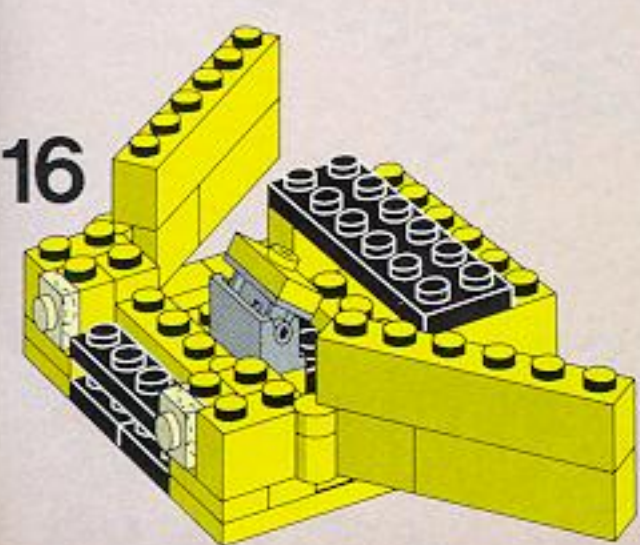
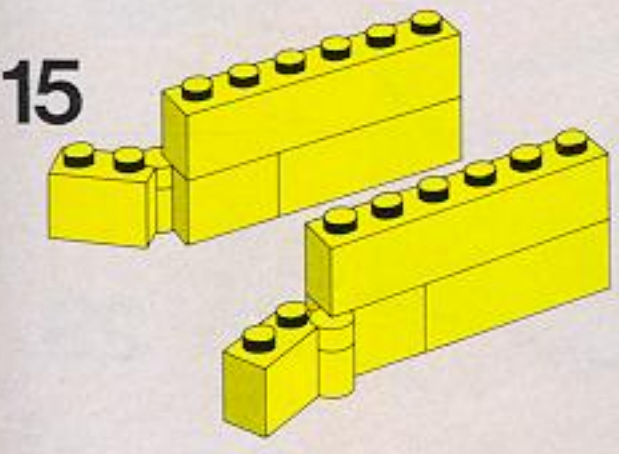
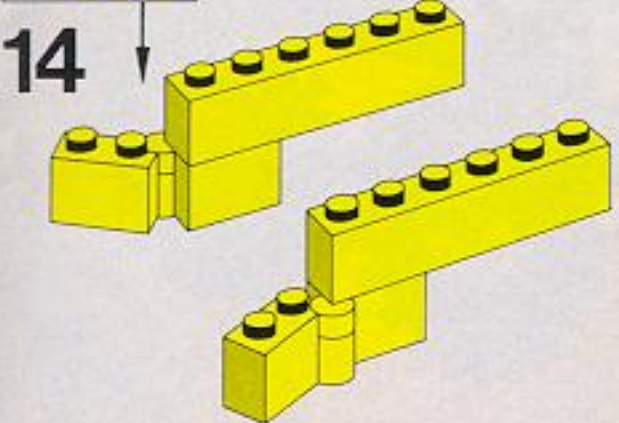

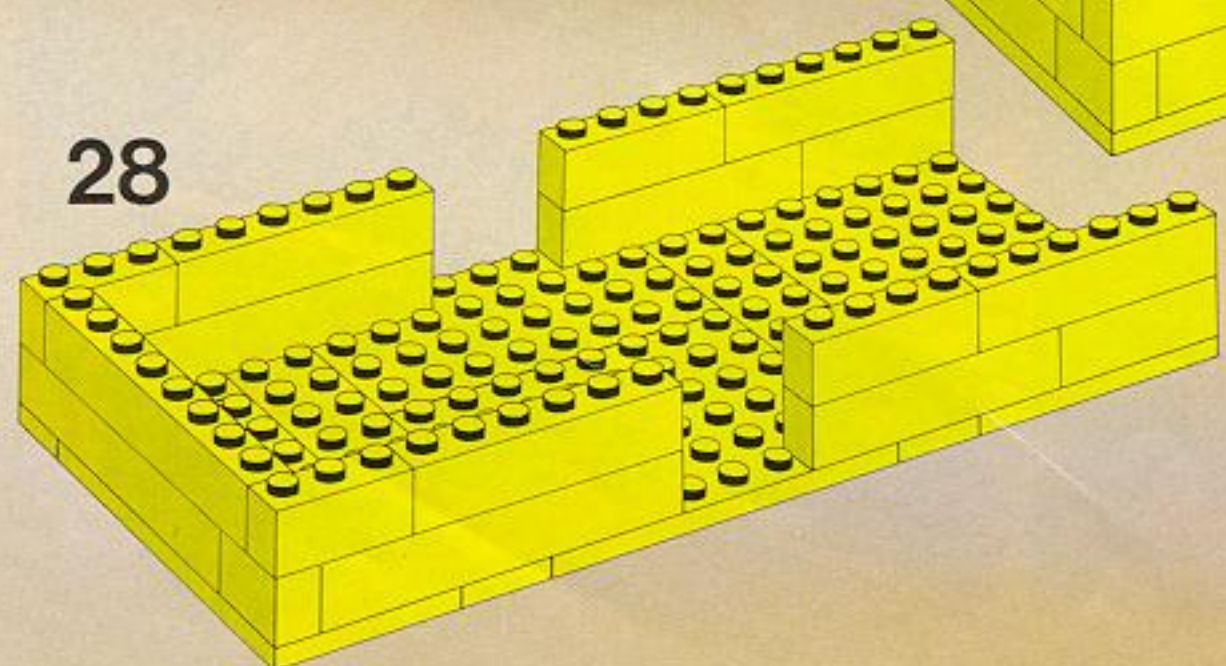
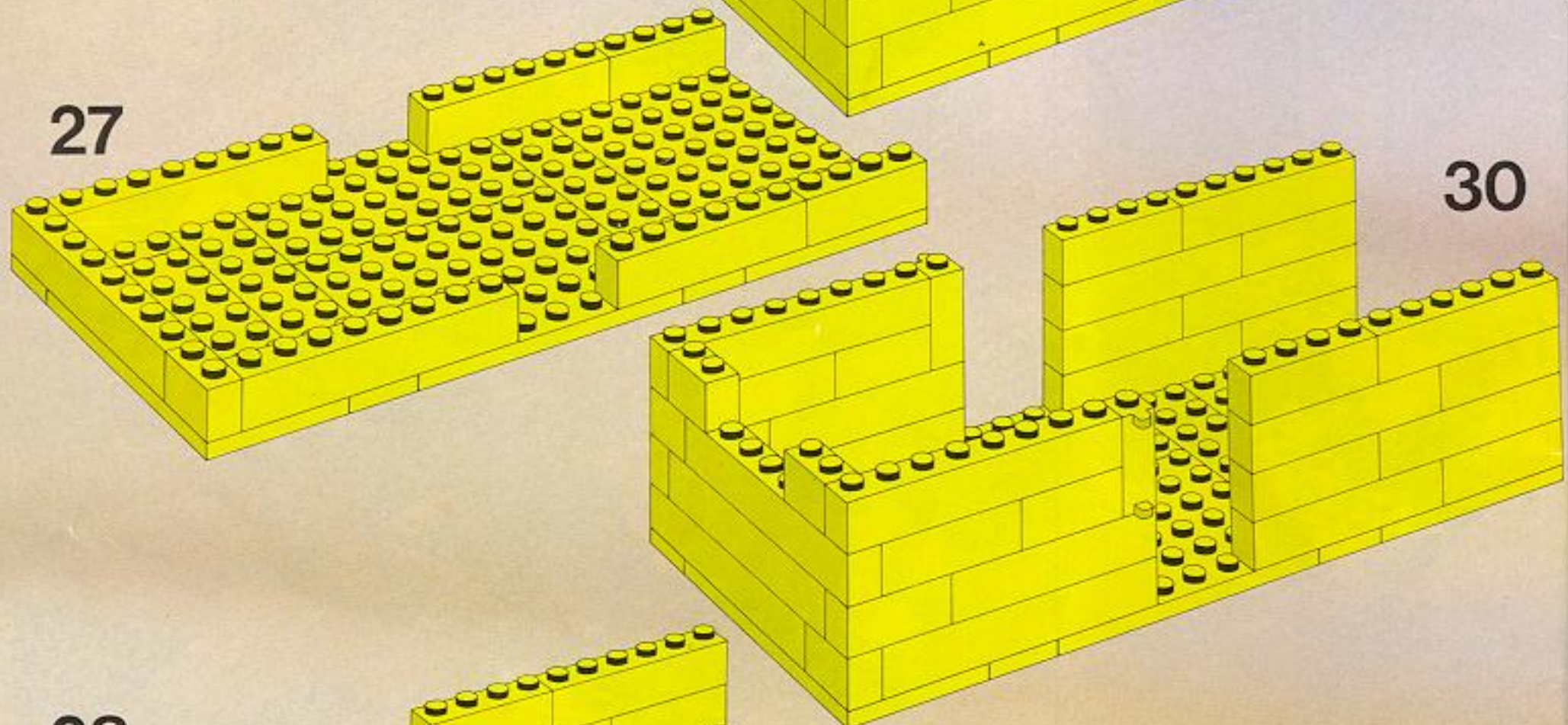
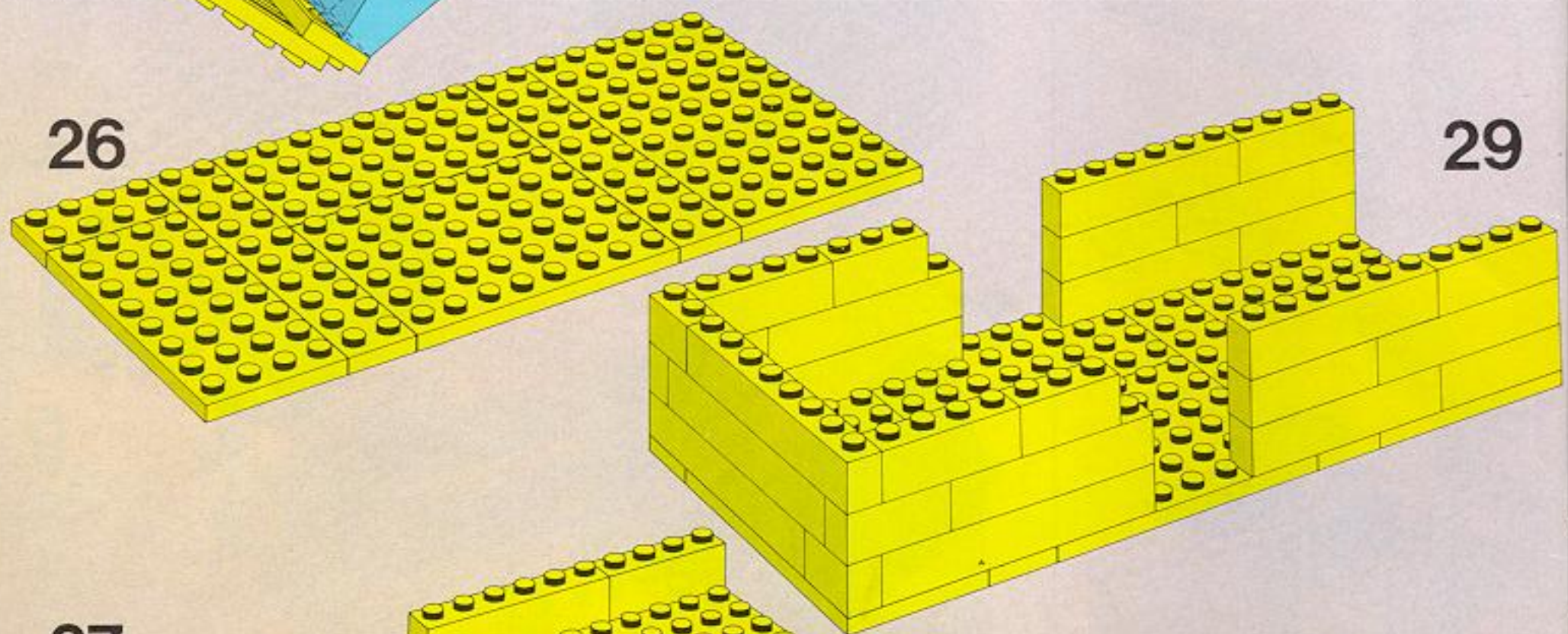
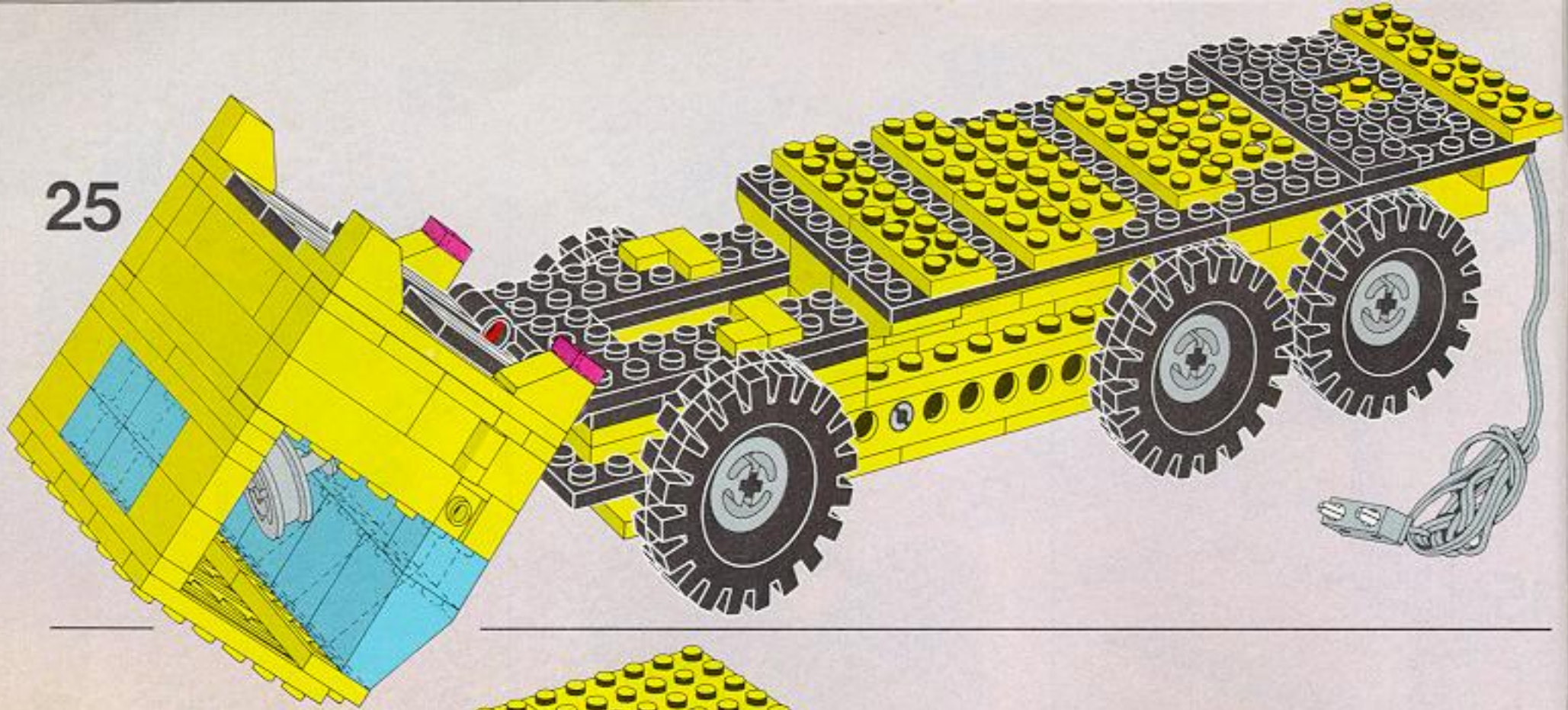

31

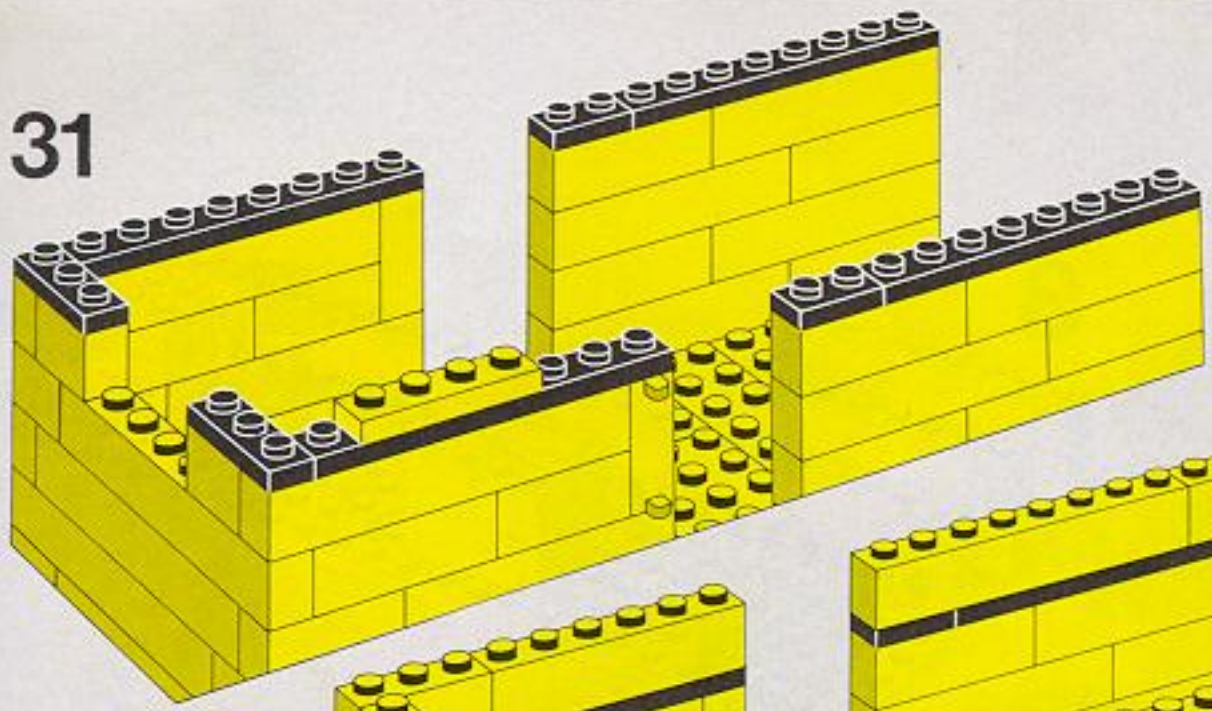

32

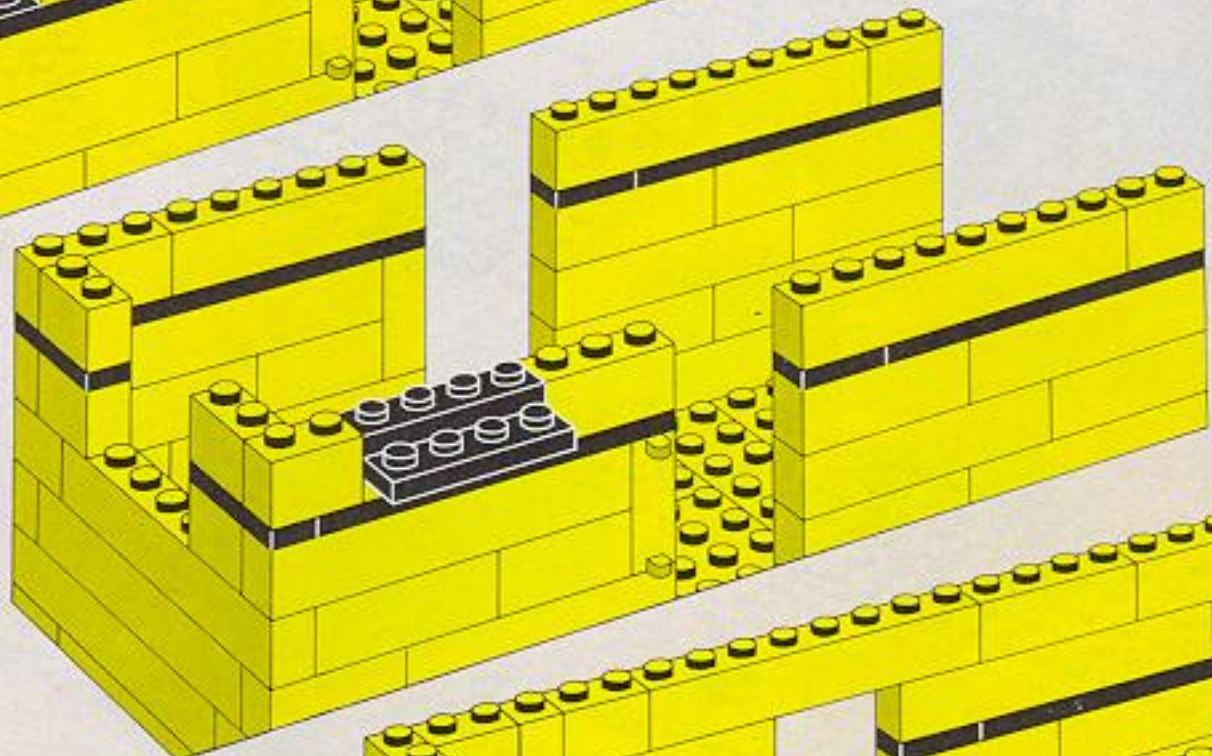

33

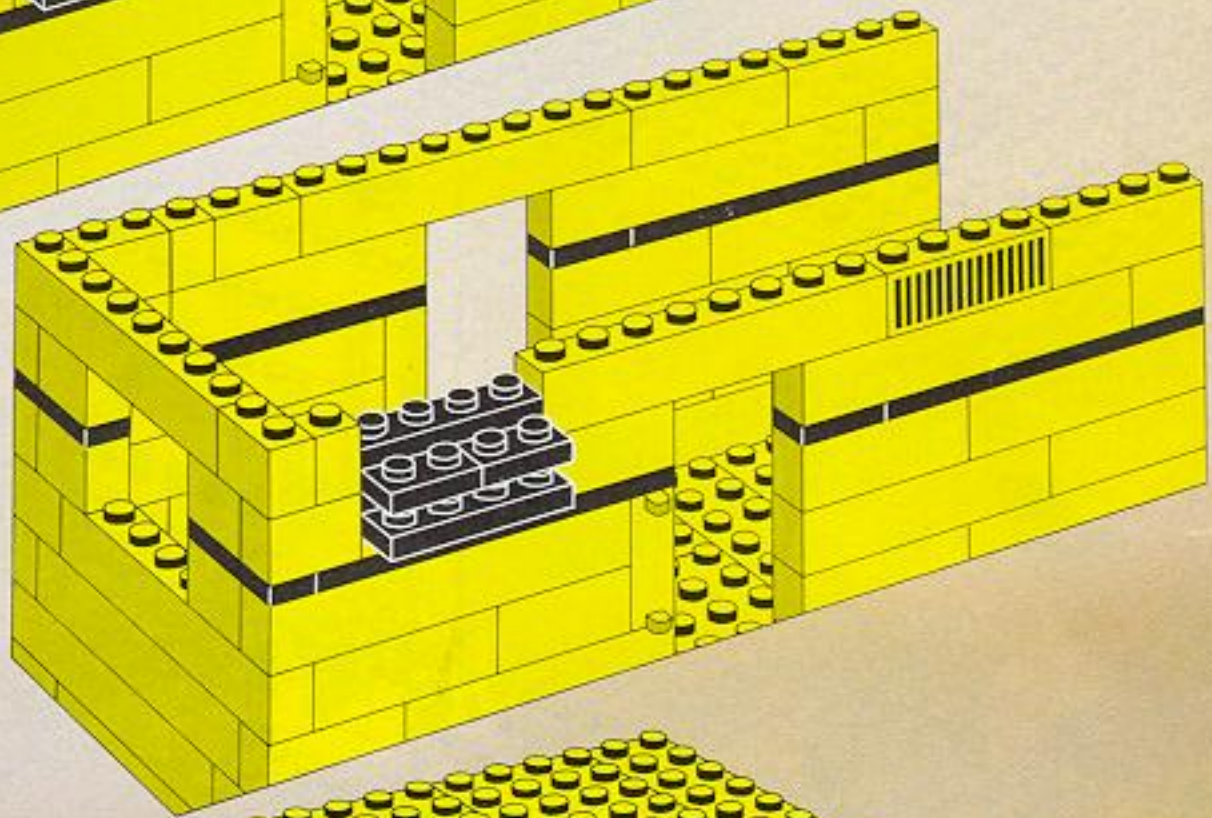

34

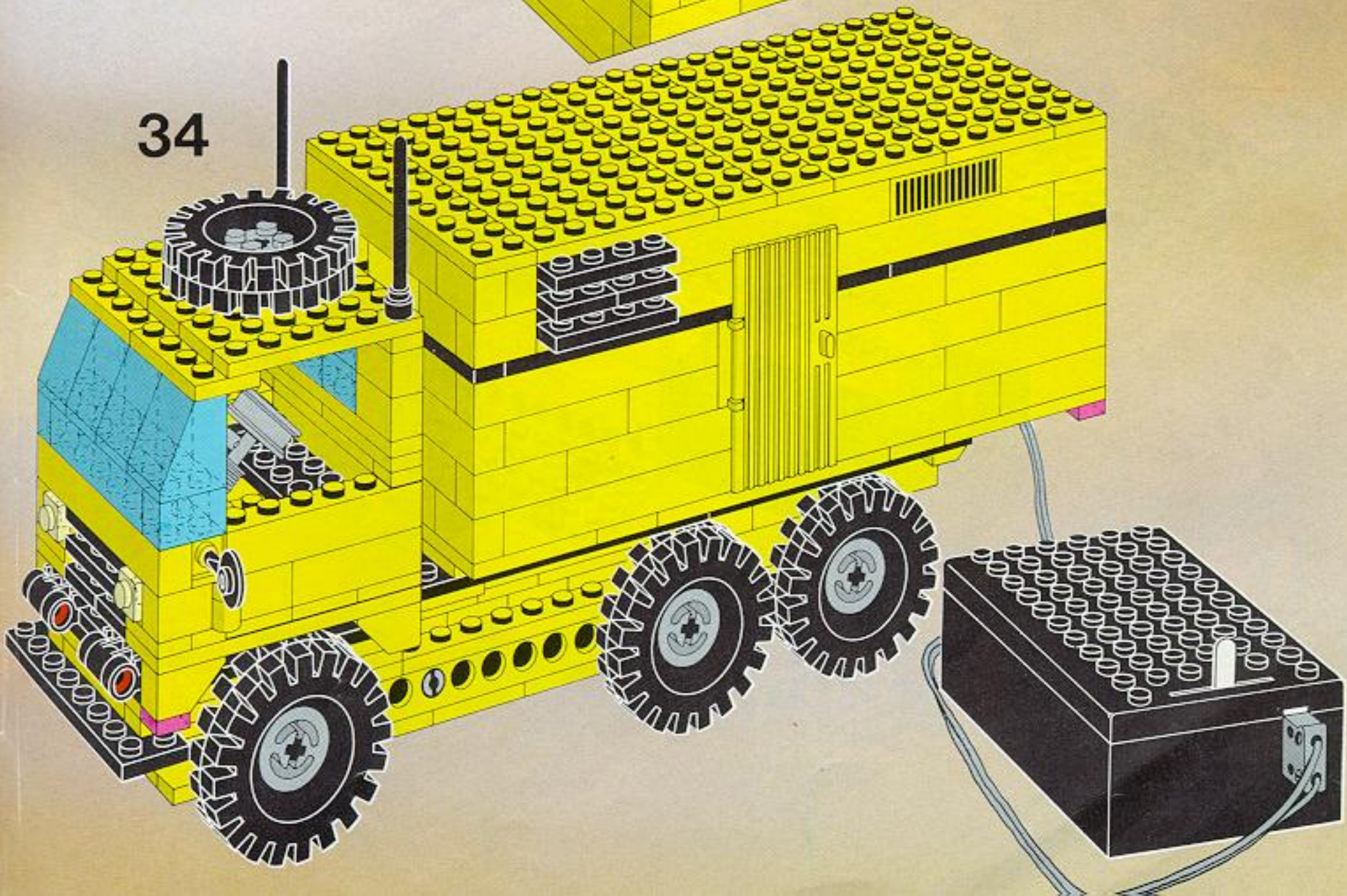

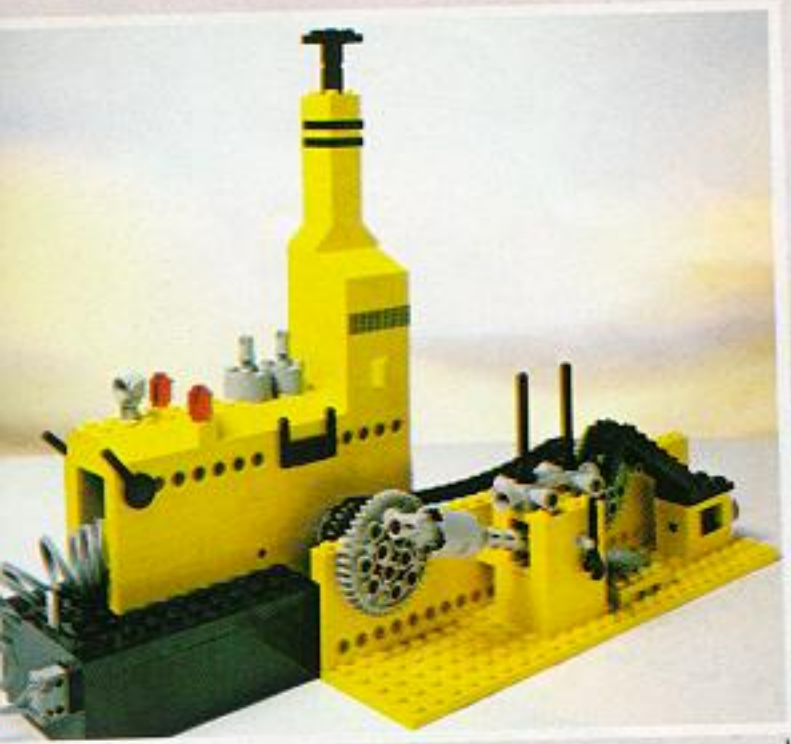

3

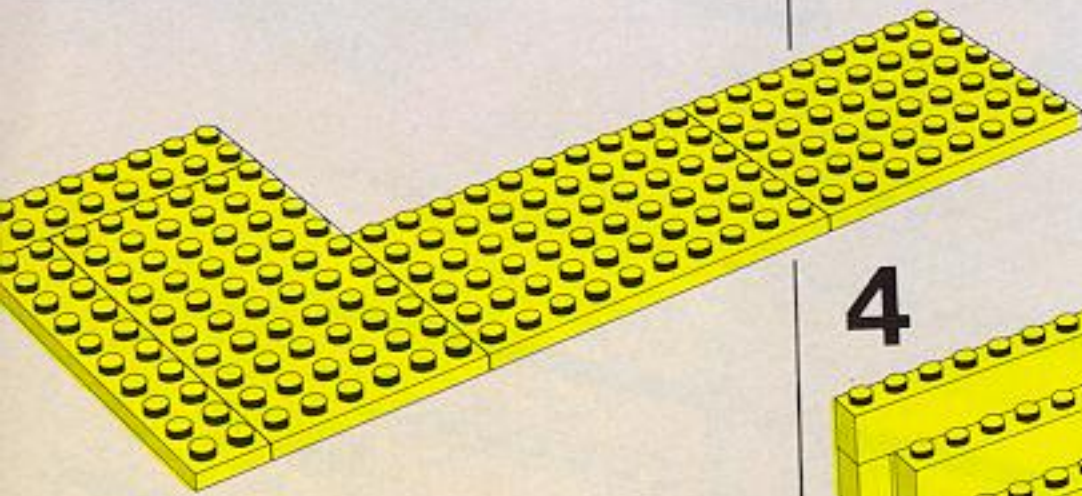
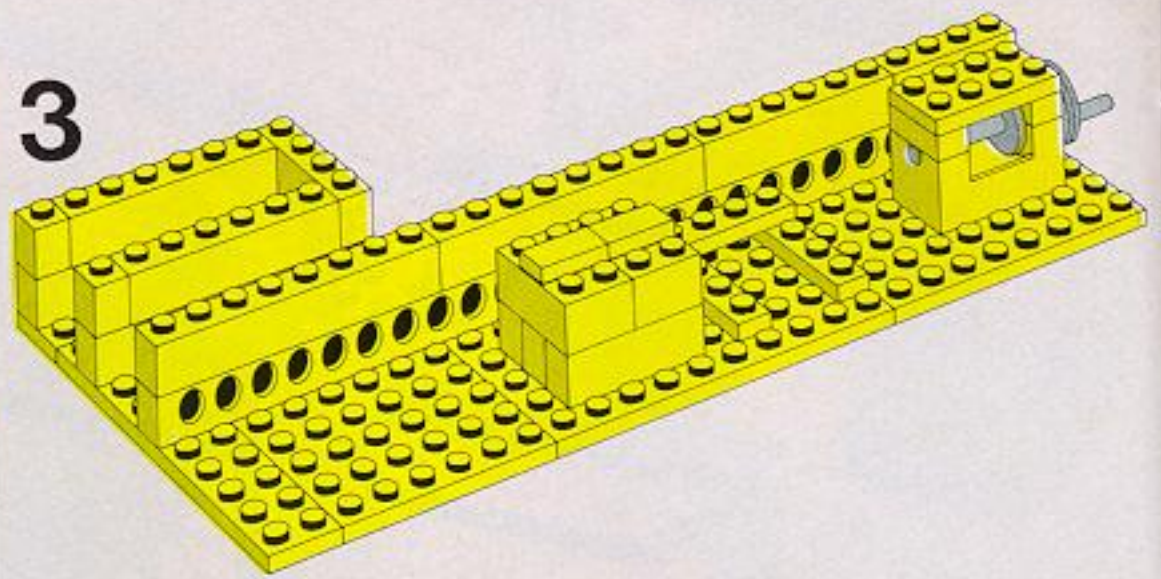

4

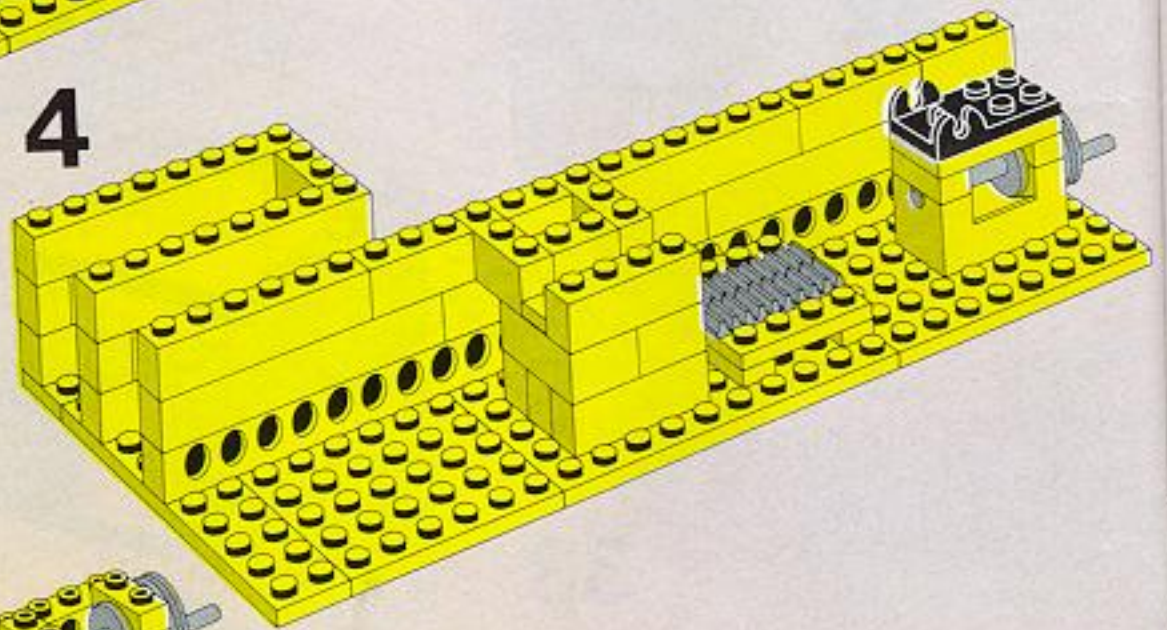

2

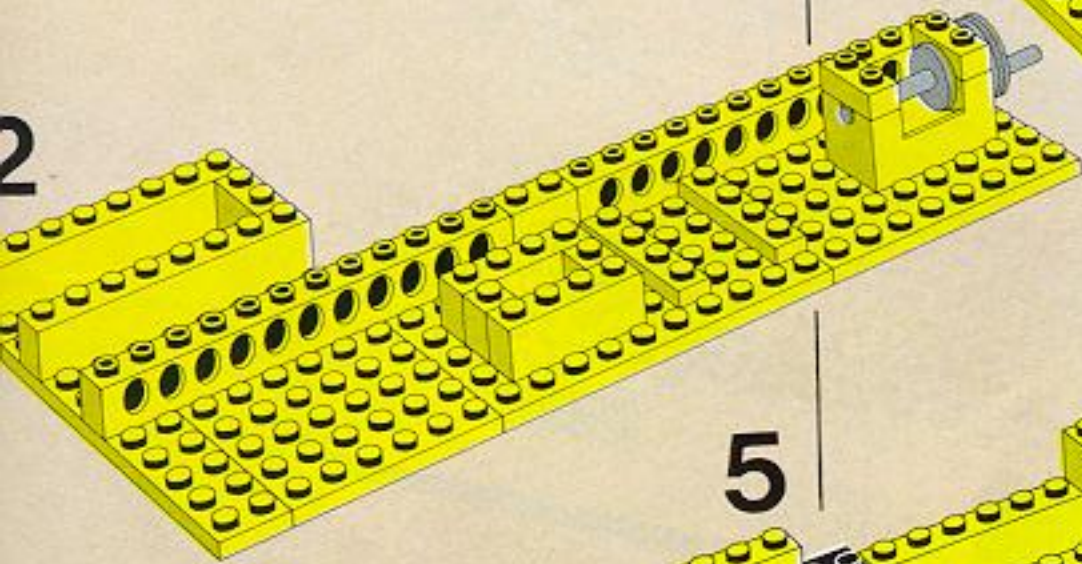

5

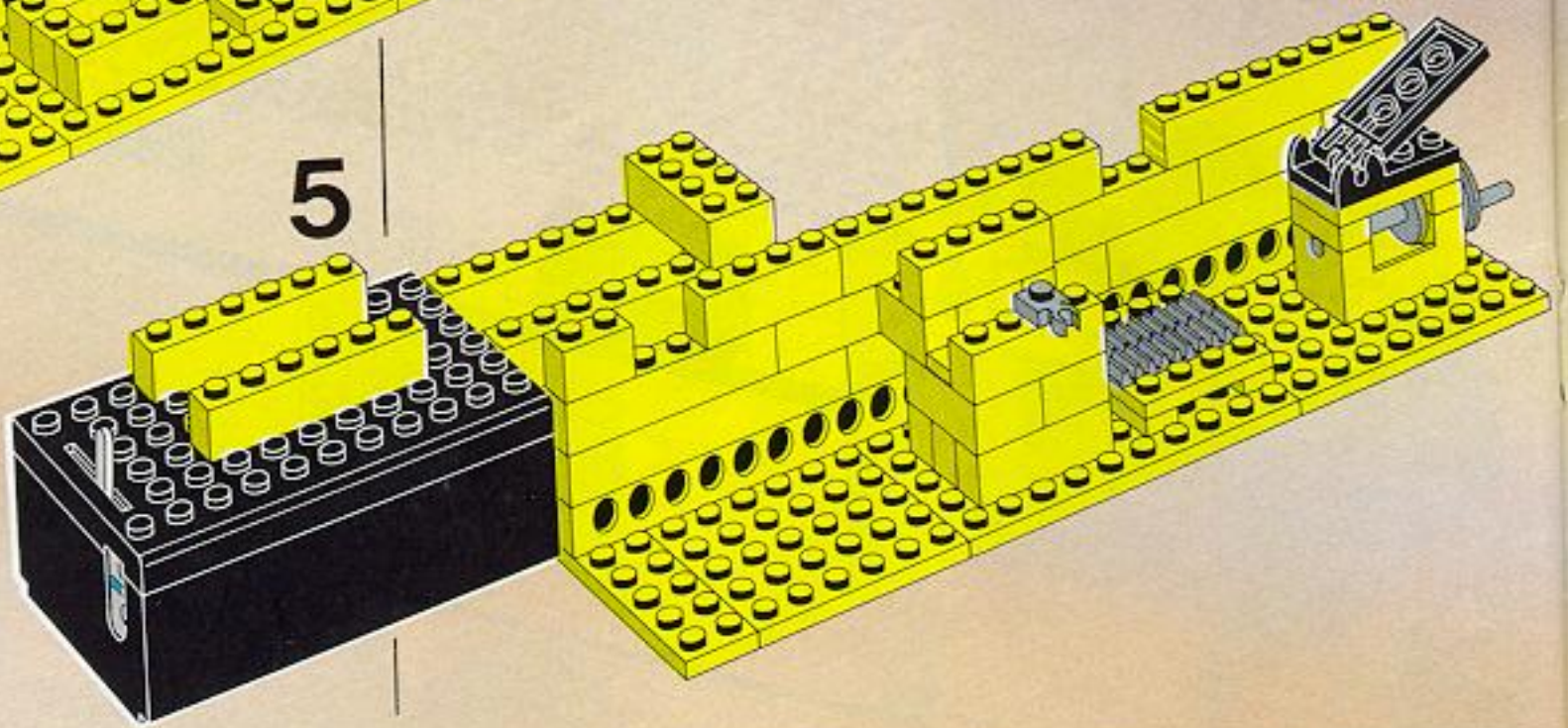

1

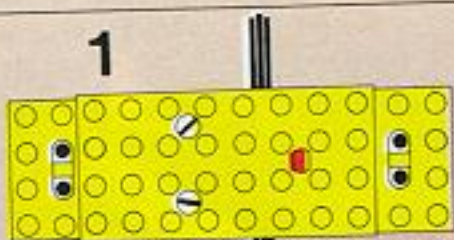

2

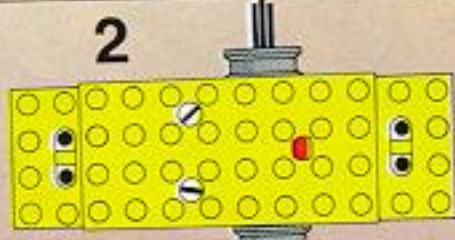

3

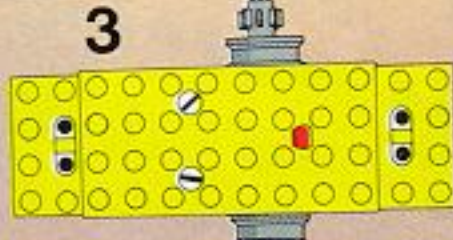

4

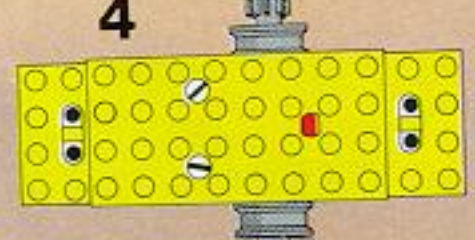

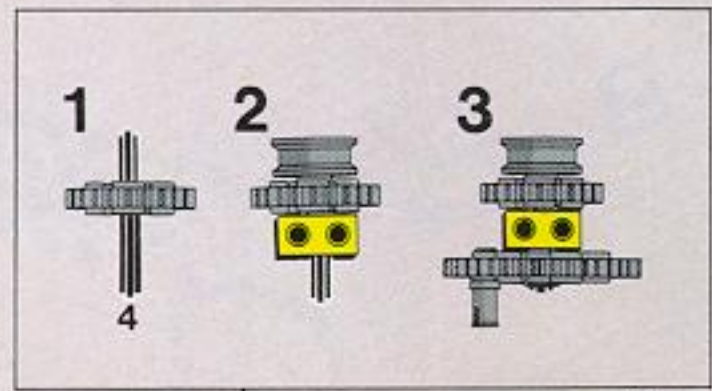
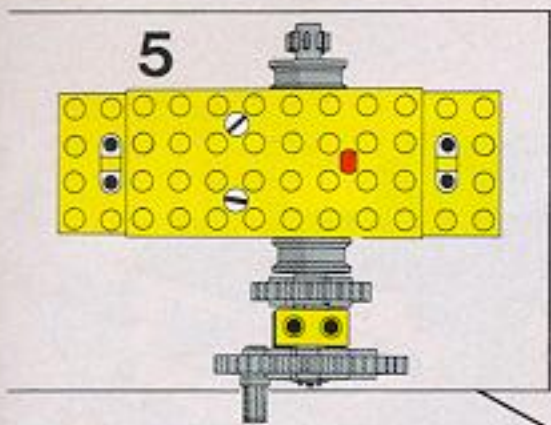

6

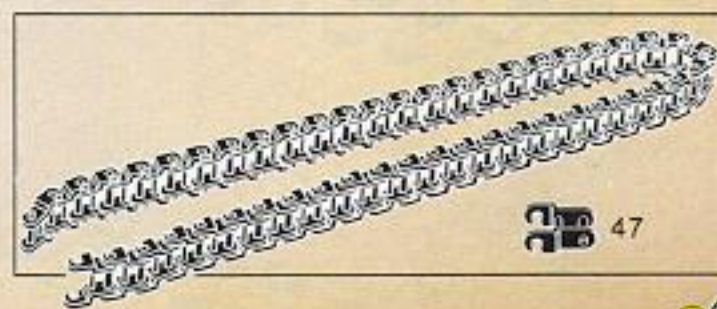
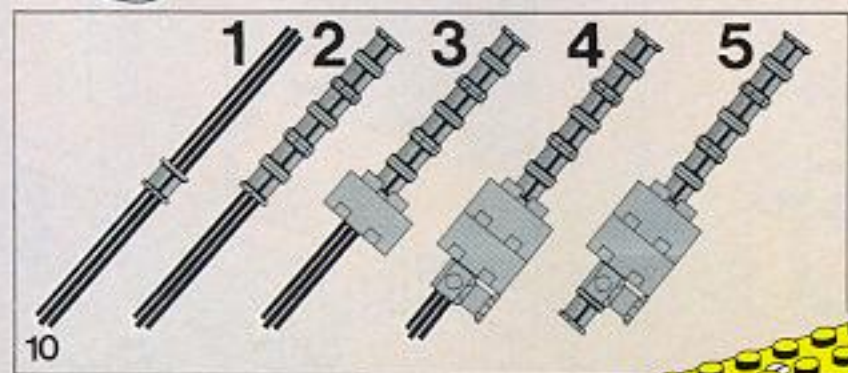
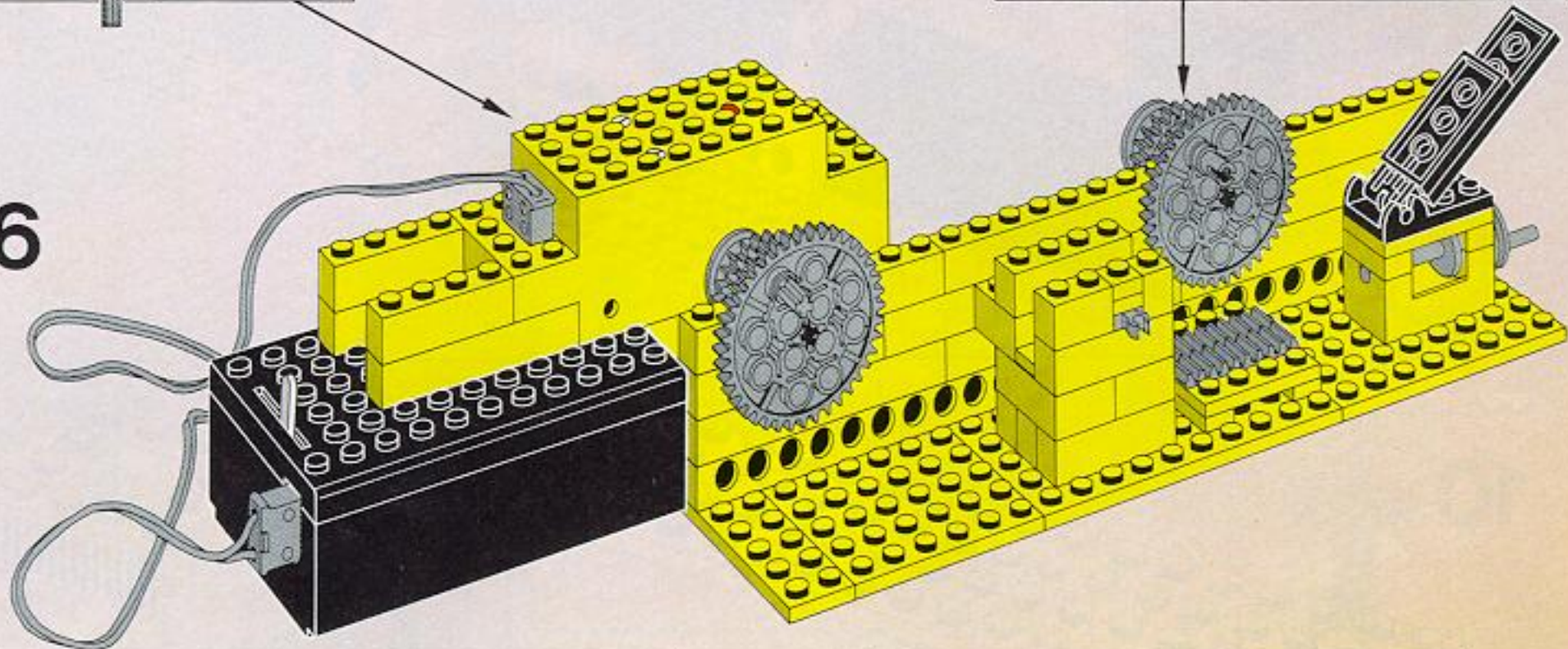

7

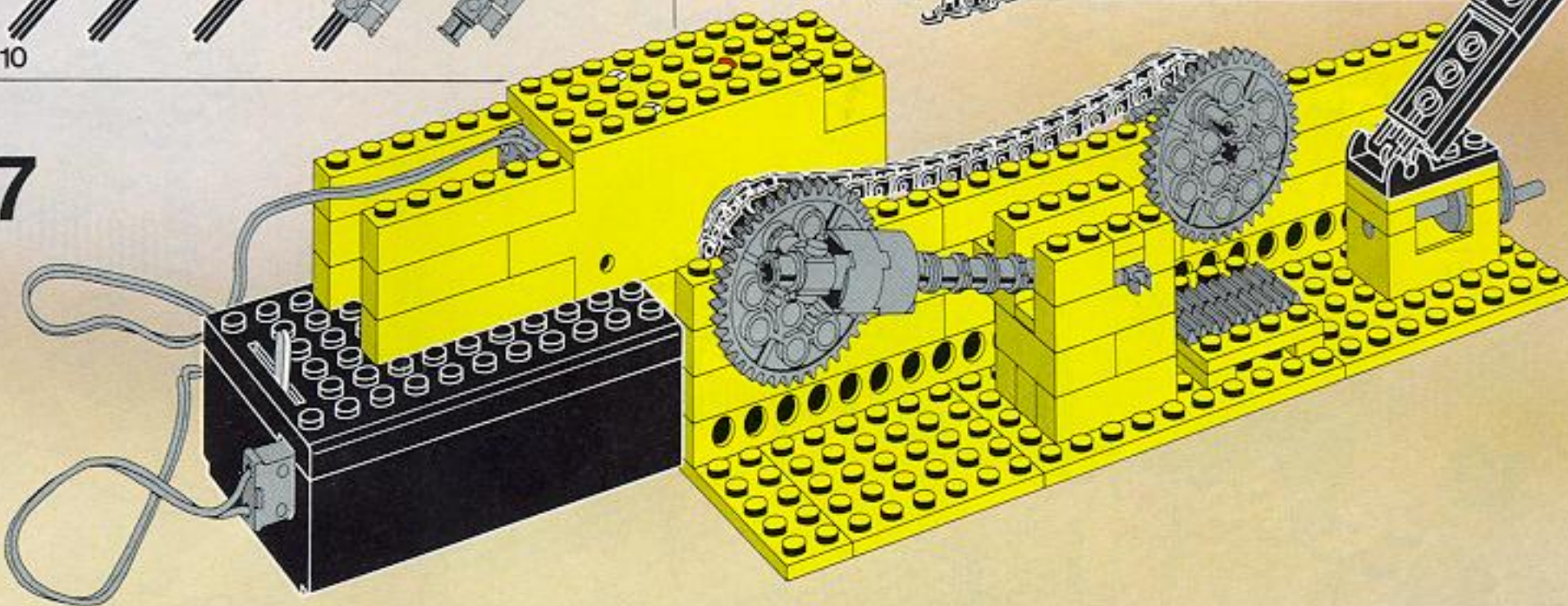

8

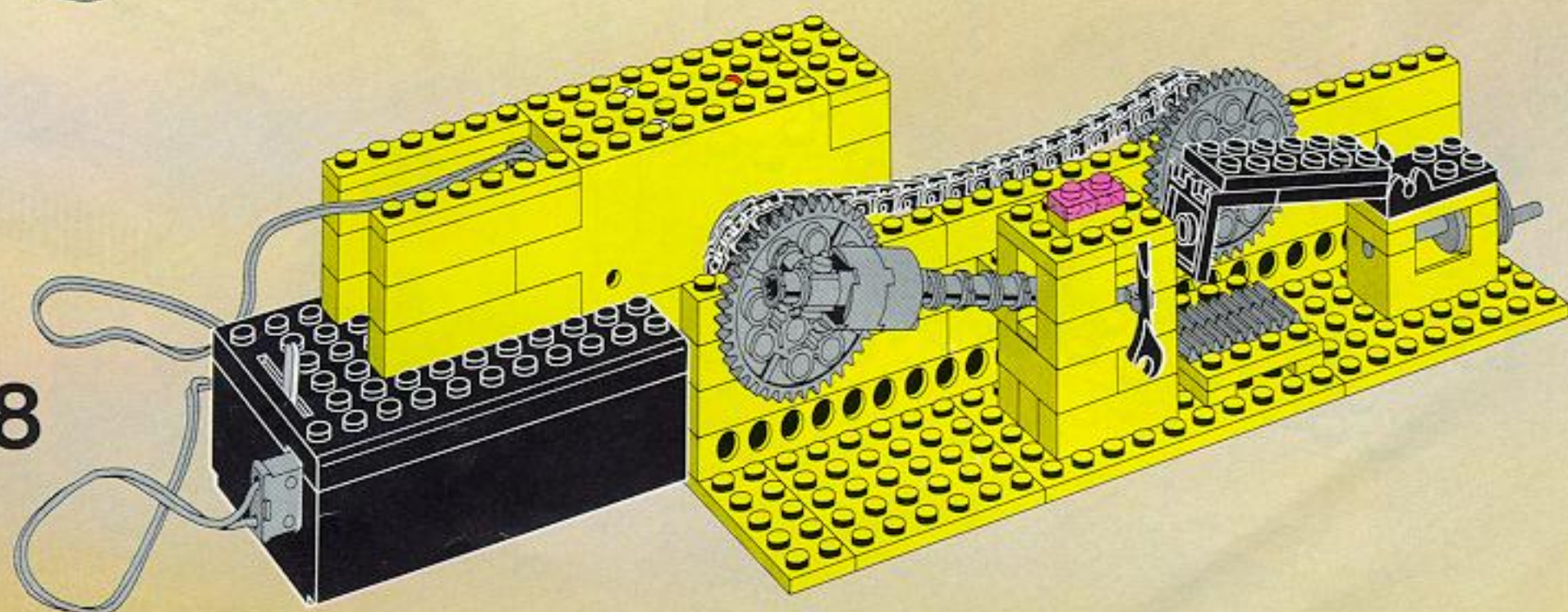

9

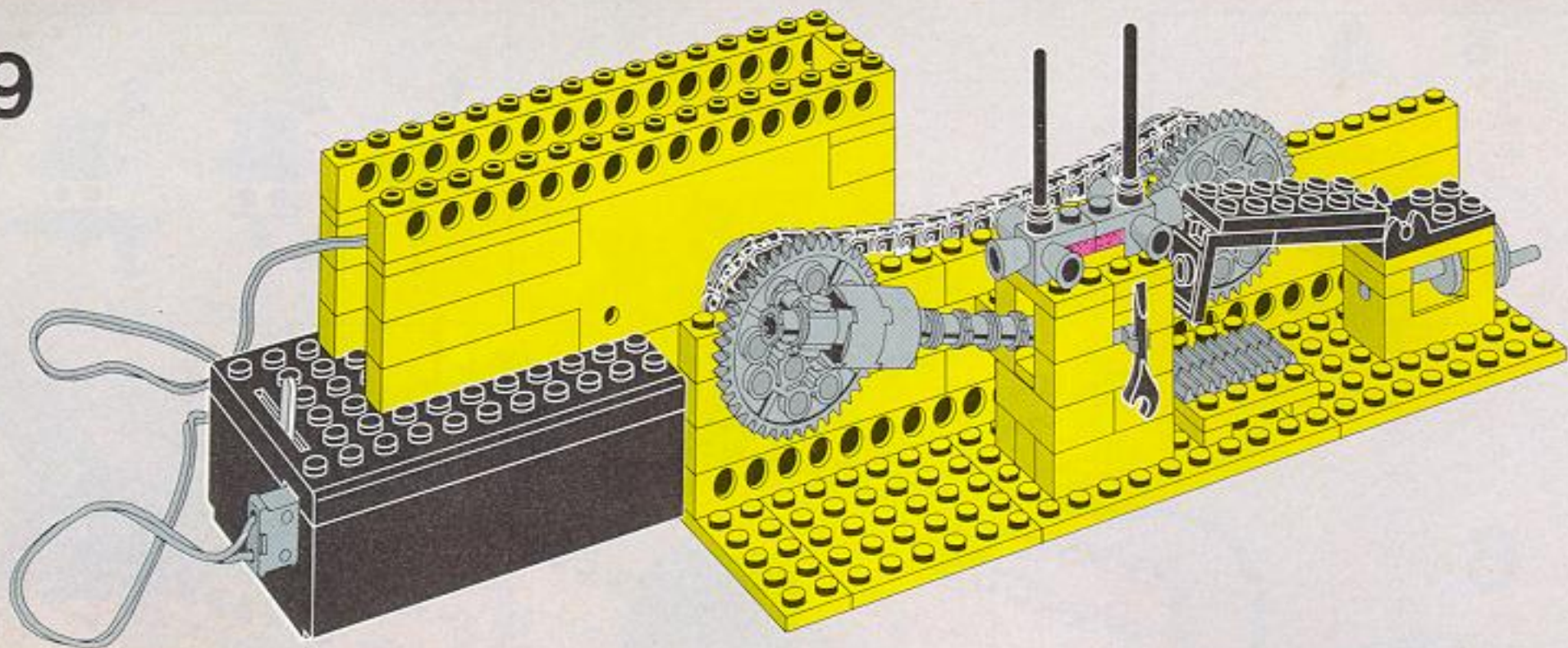

10

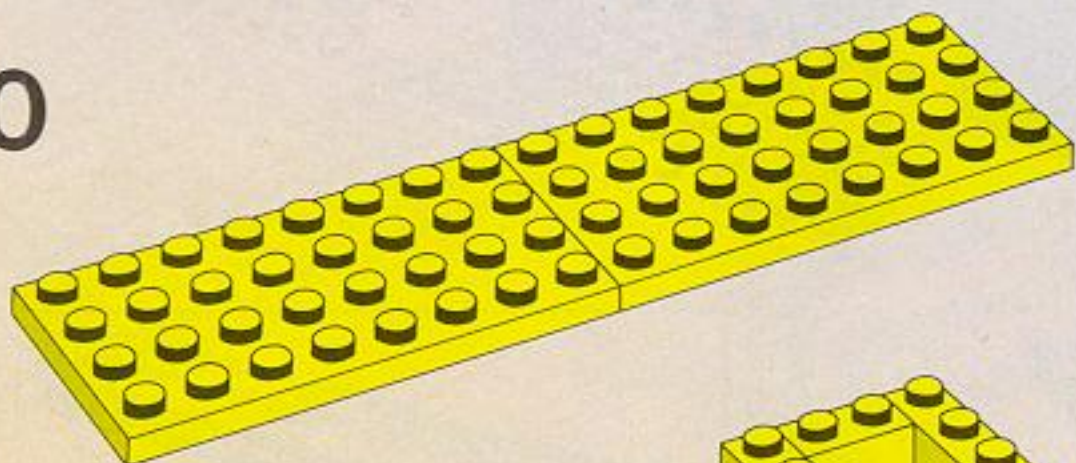

11

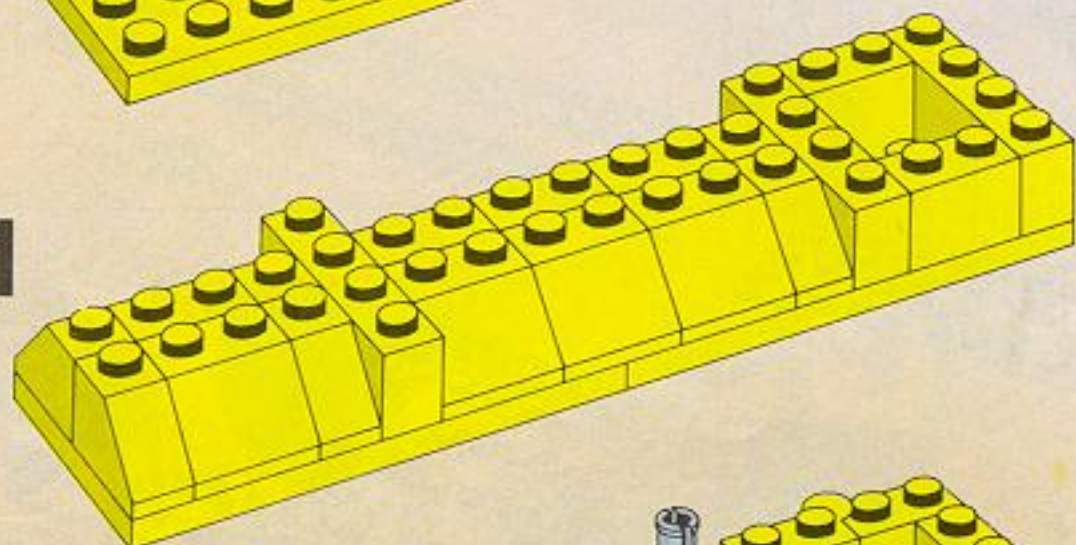

12

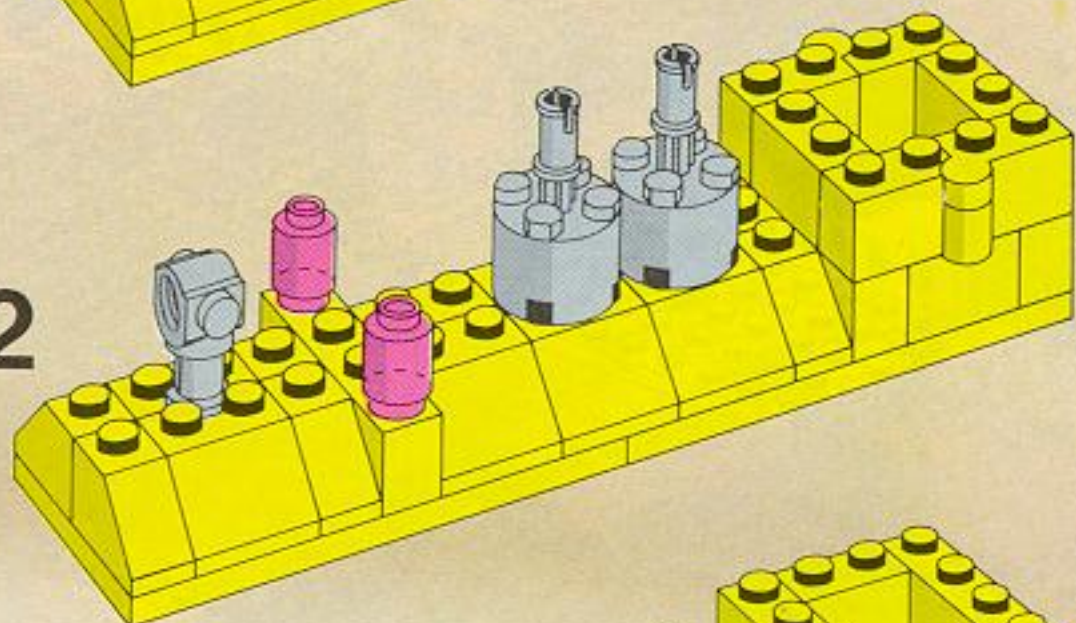

13

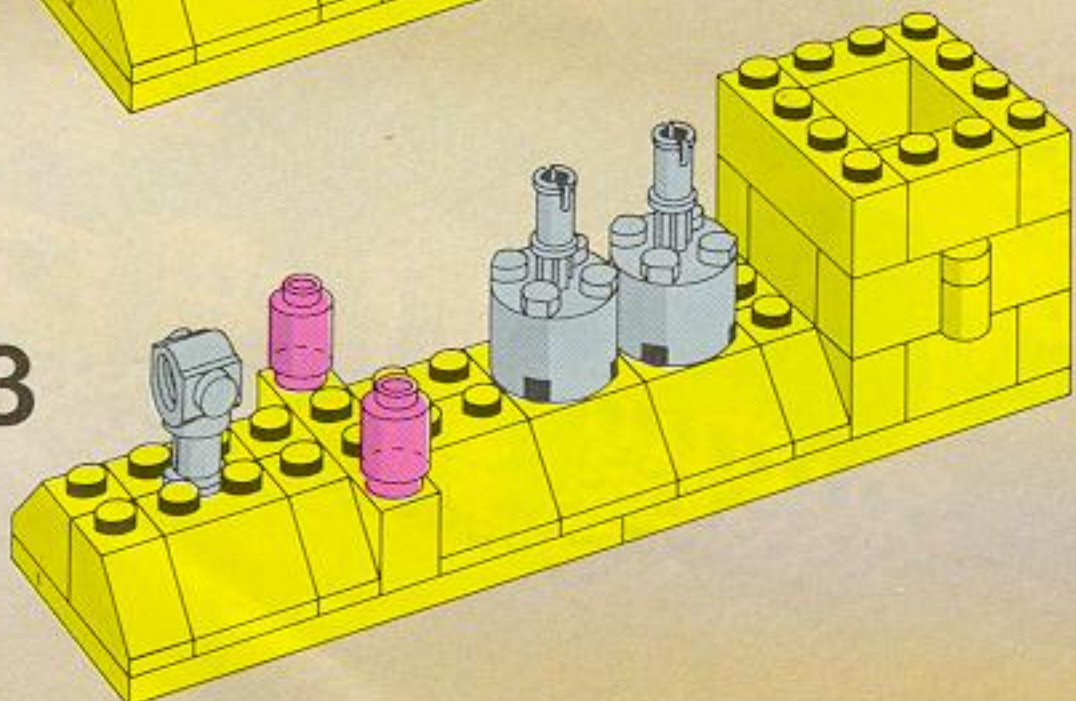

14

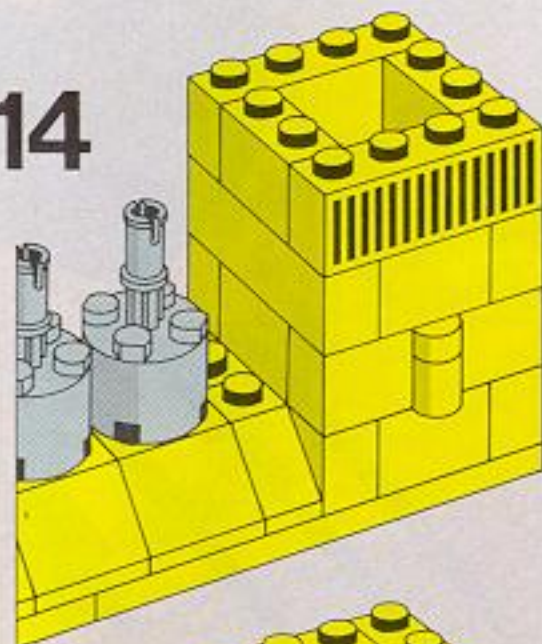

15

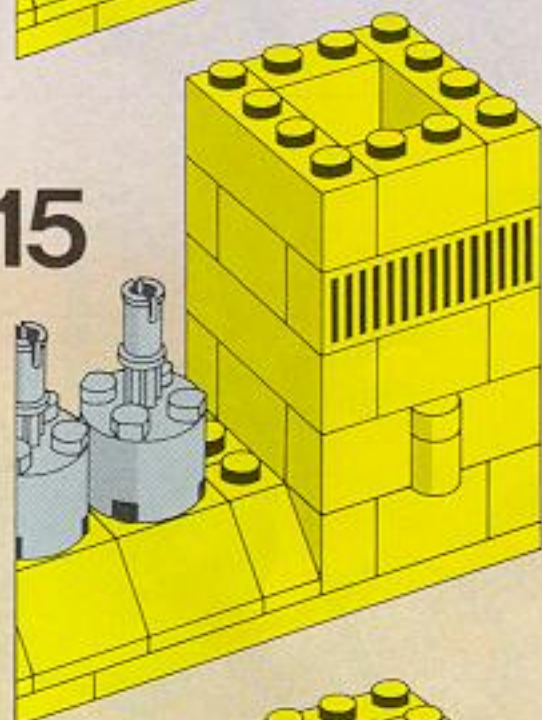

16



17



19



20

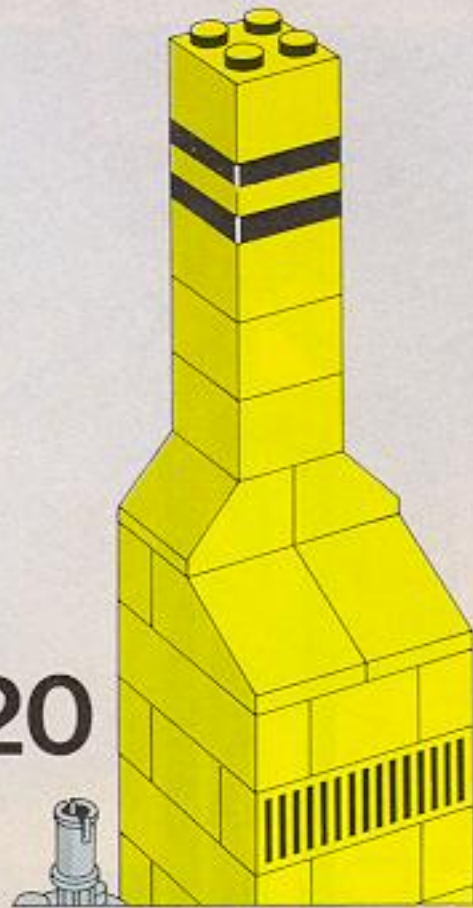

18

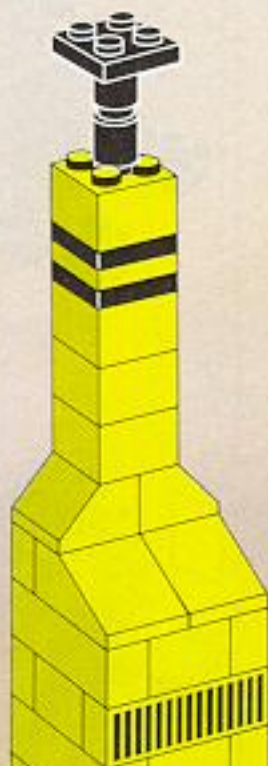

21

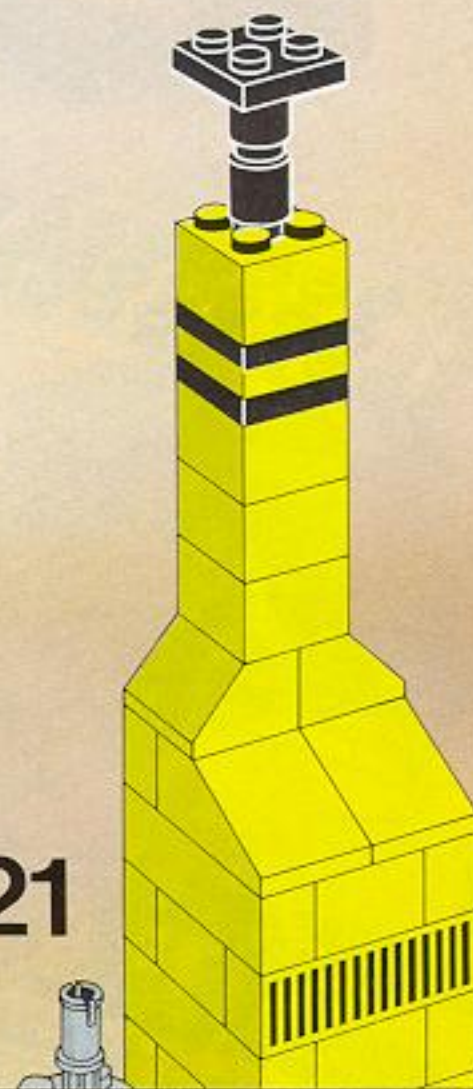

22

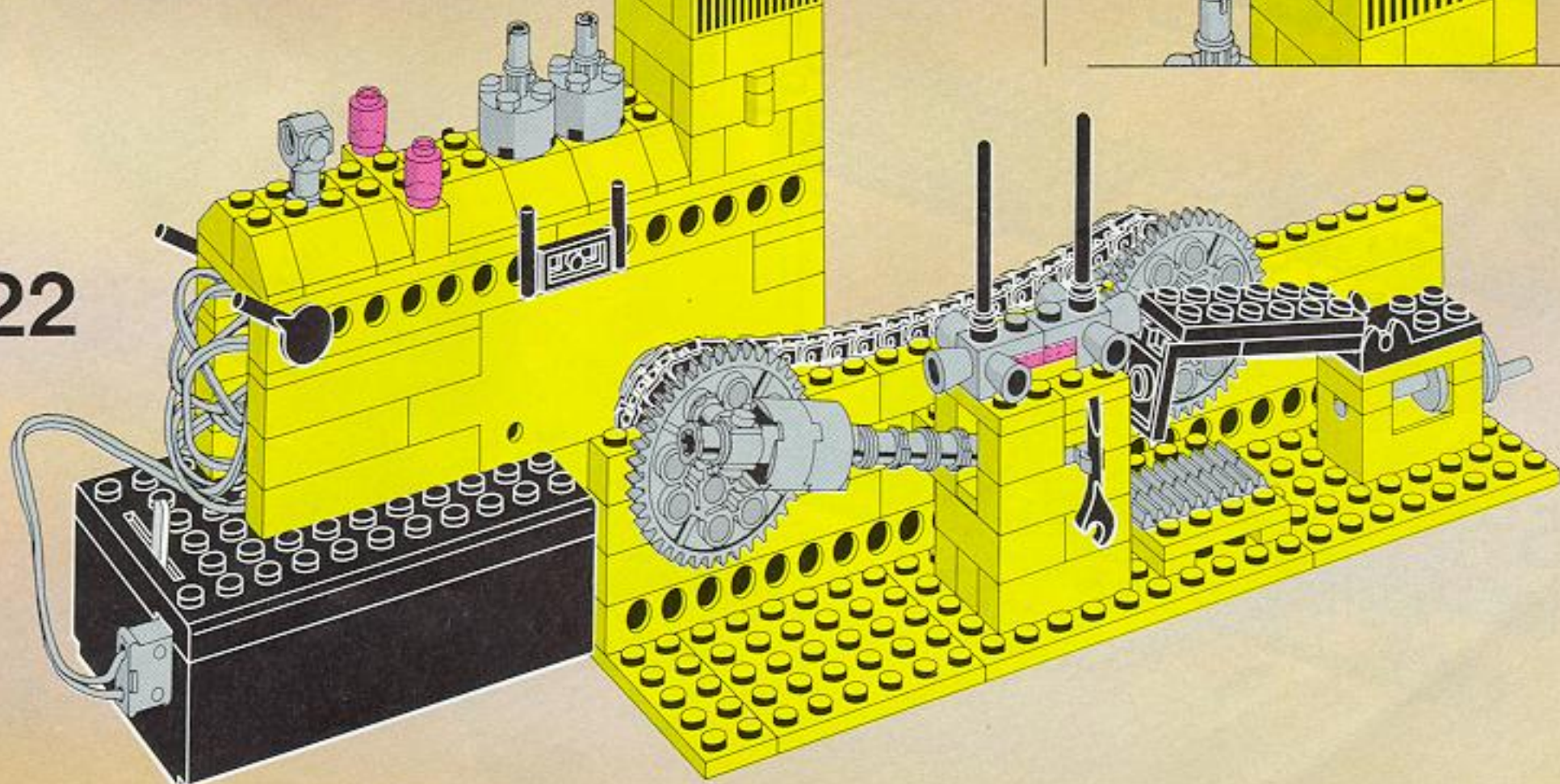

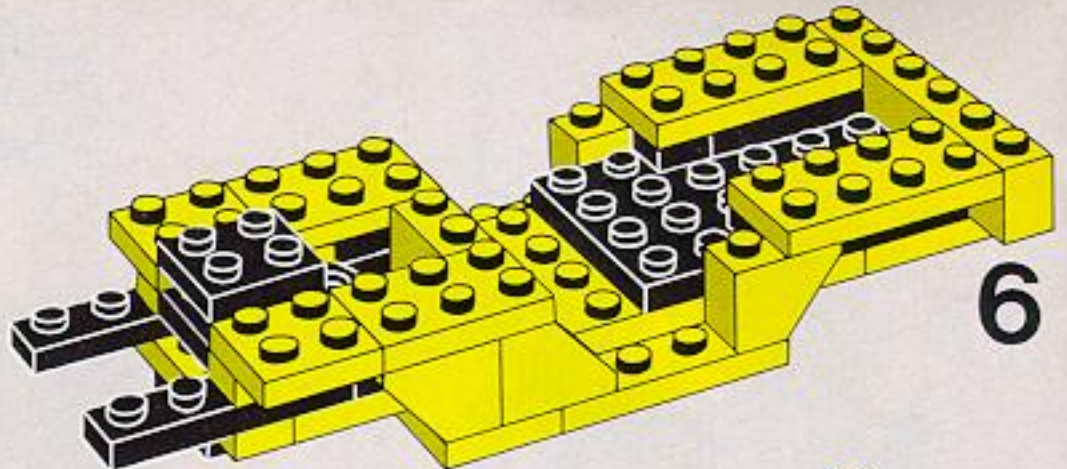

6

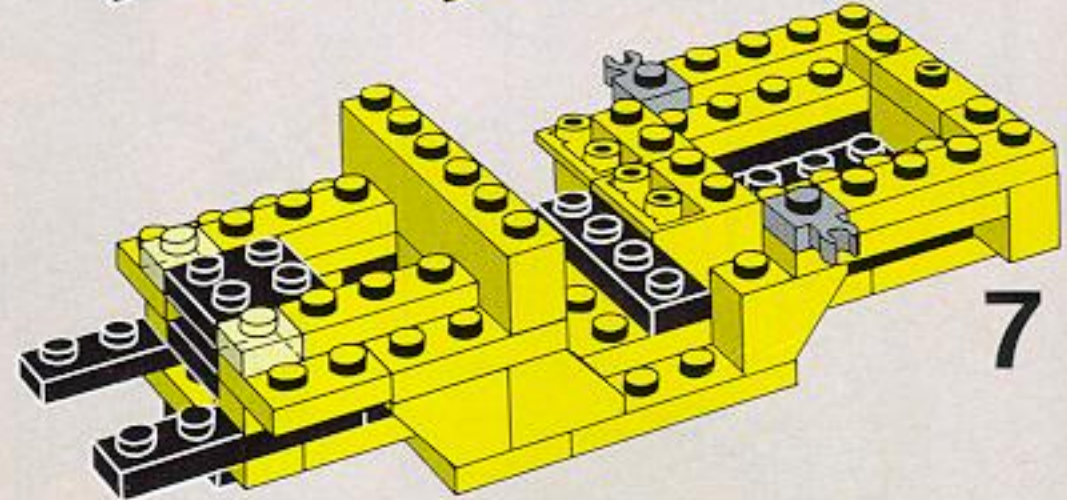

7

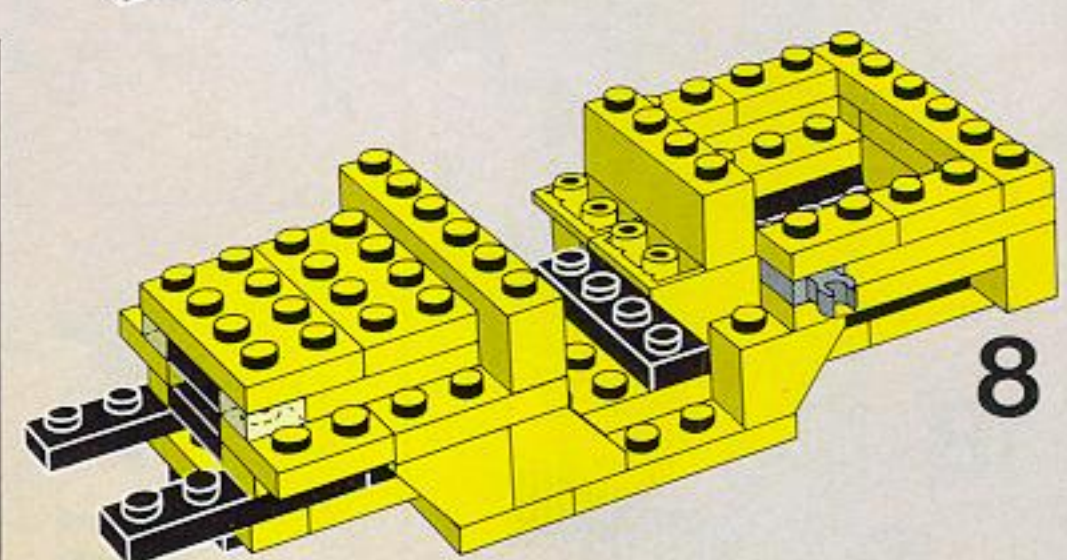

8

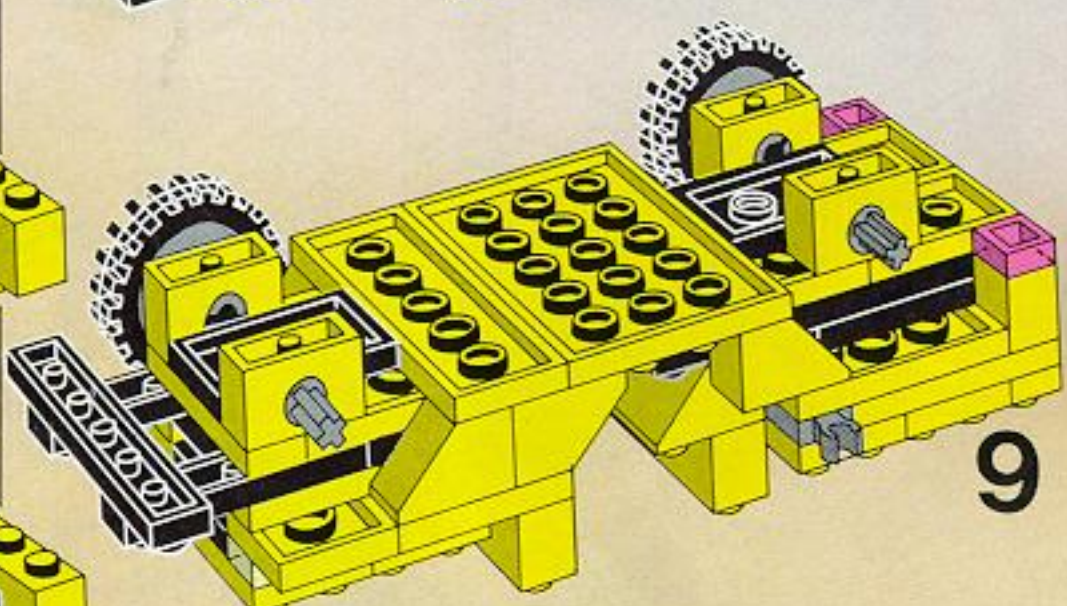

9

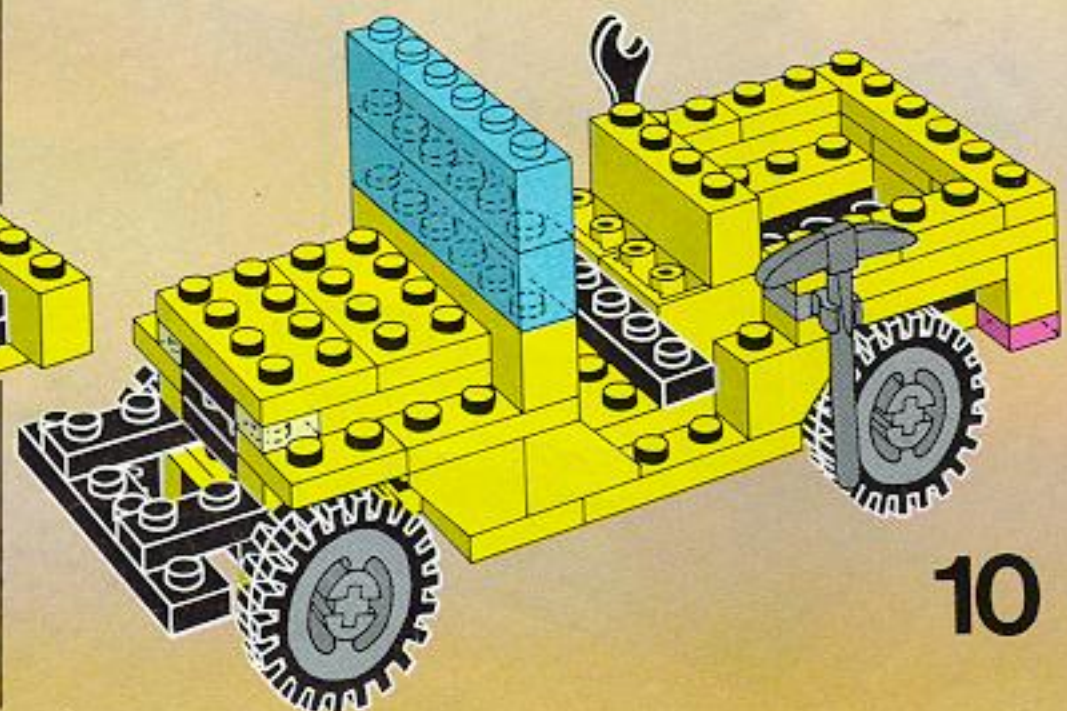
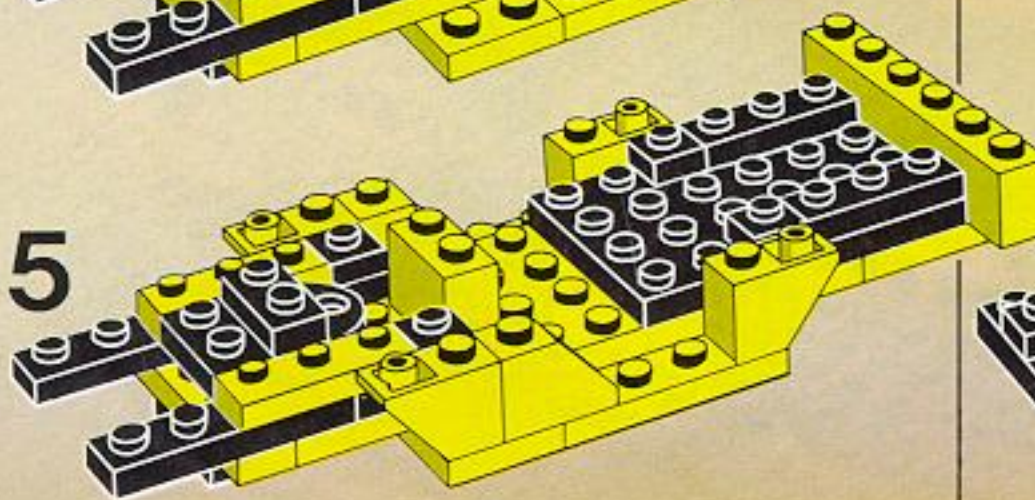
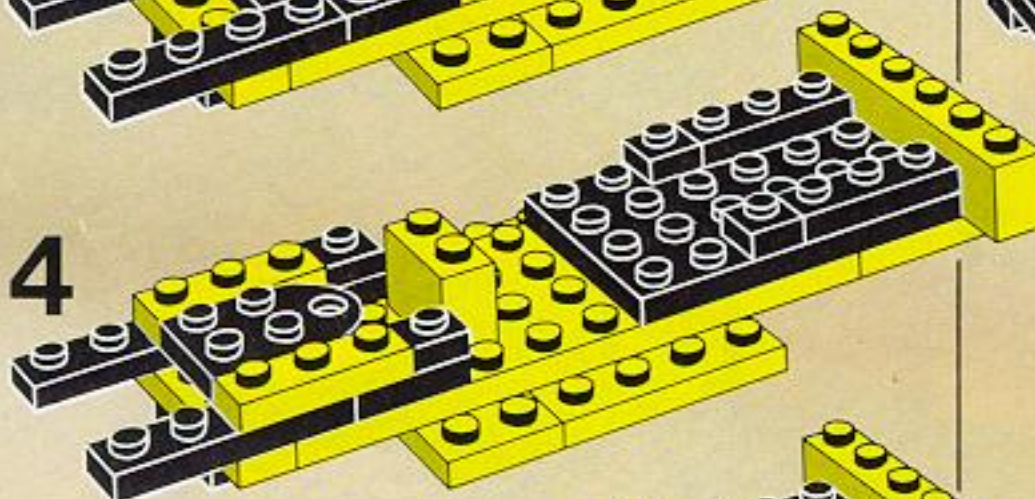
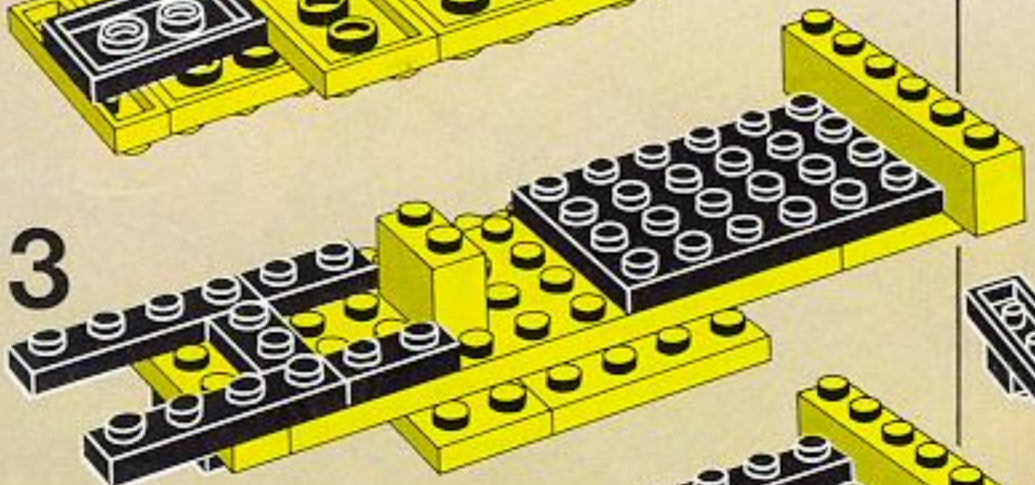
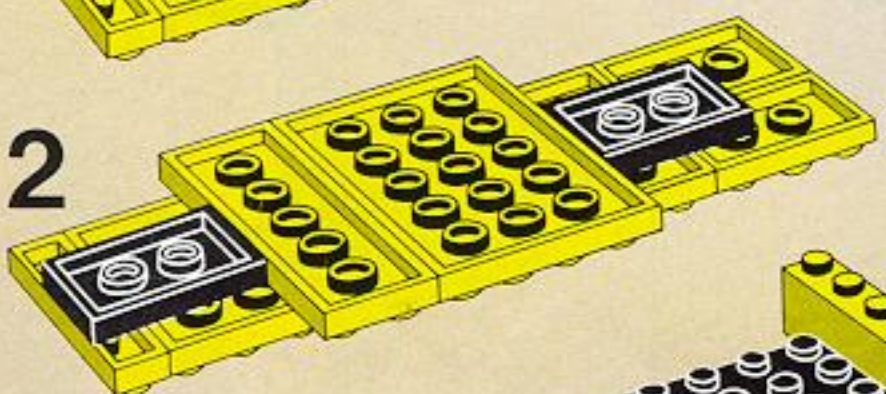
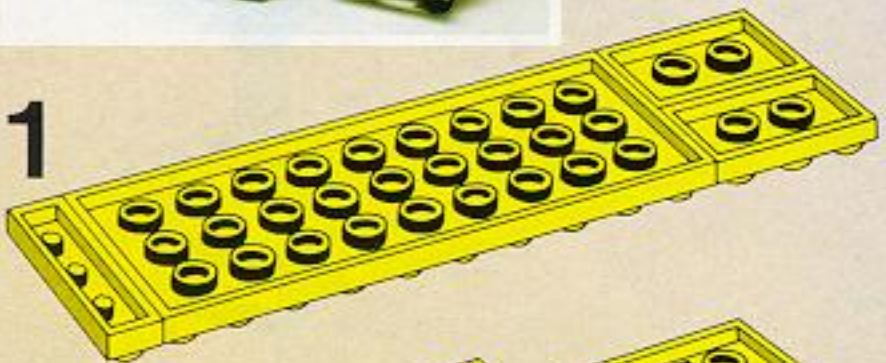

10



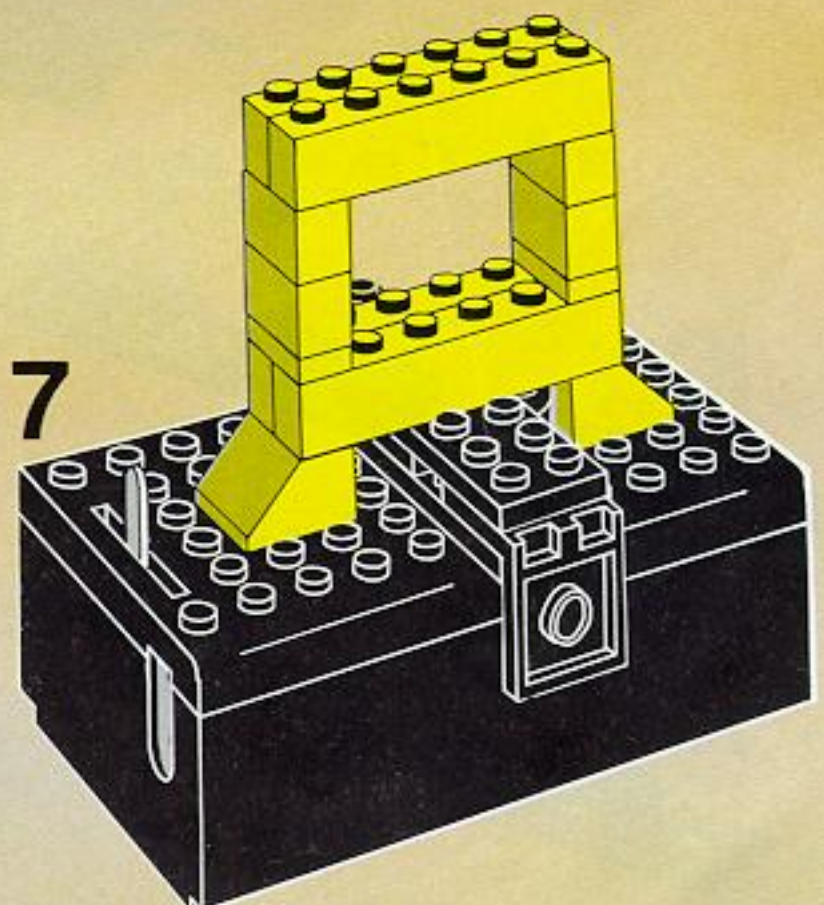
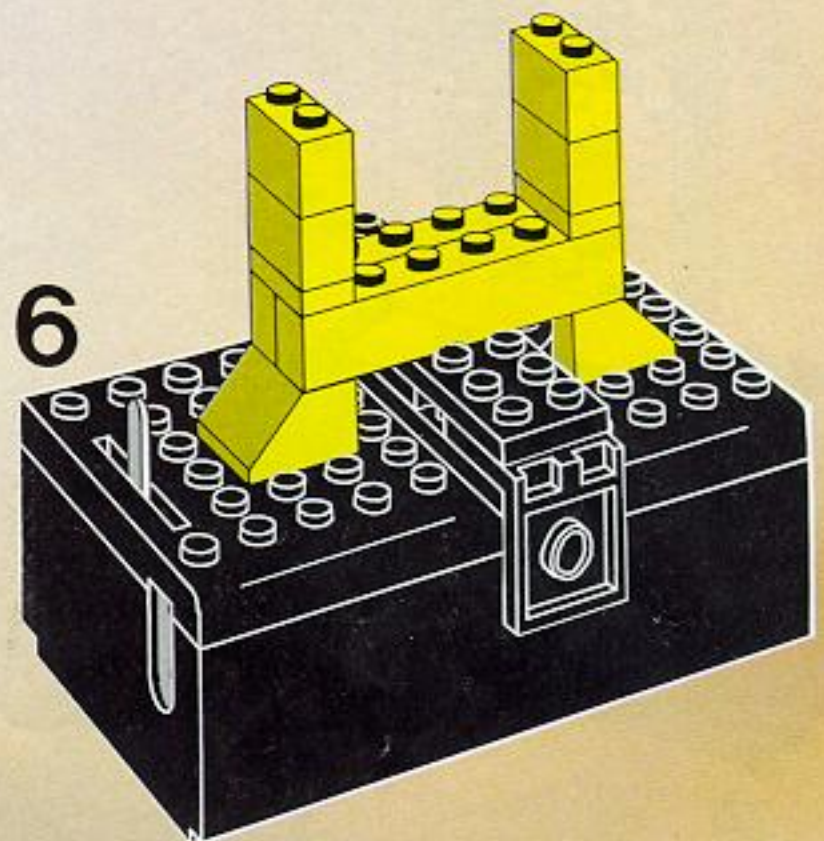
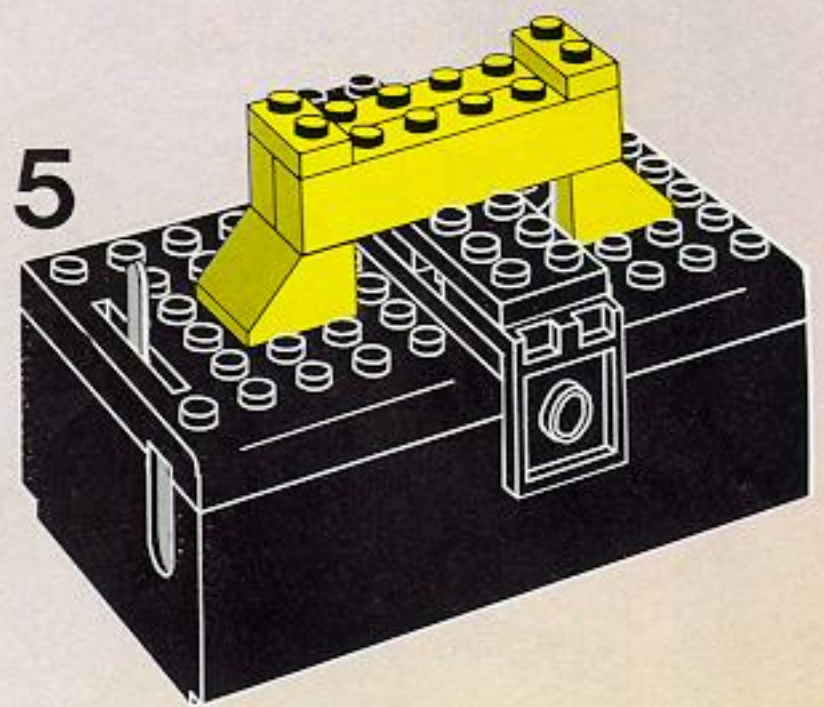
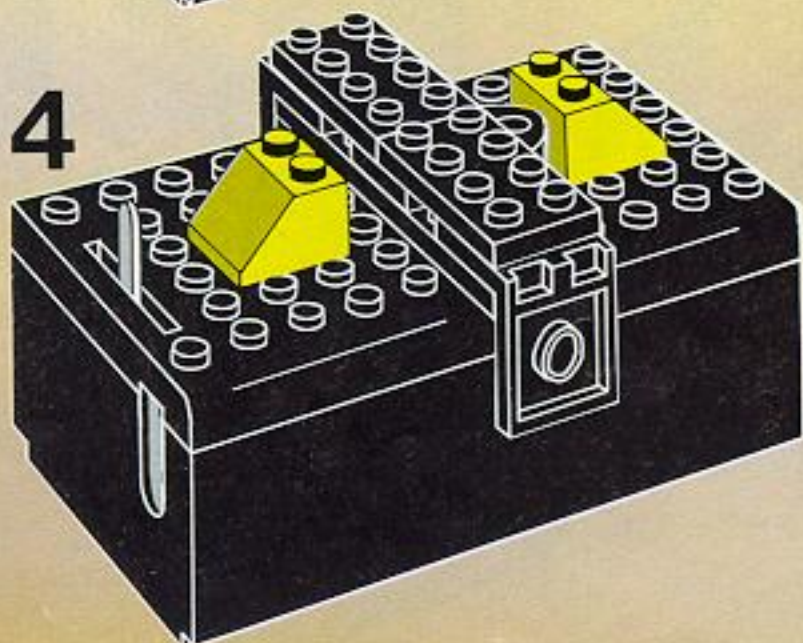
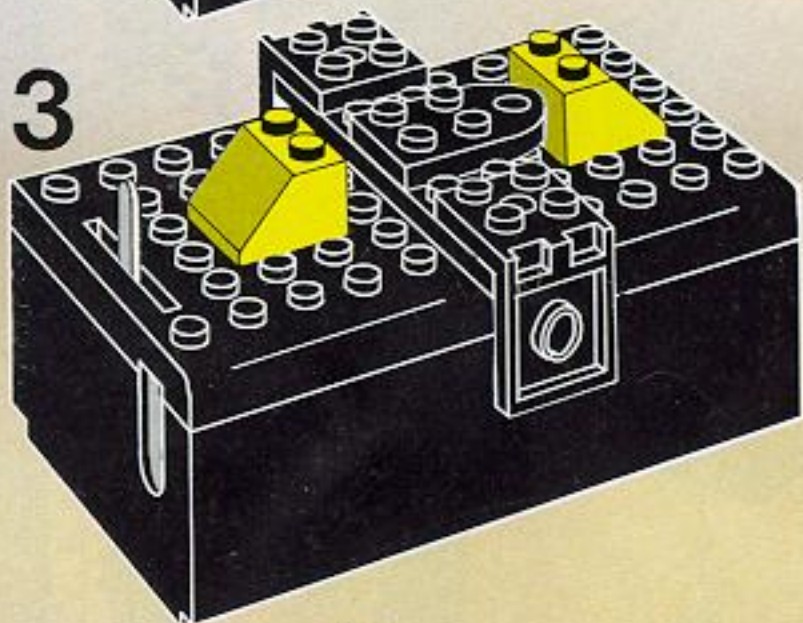
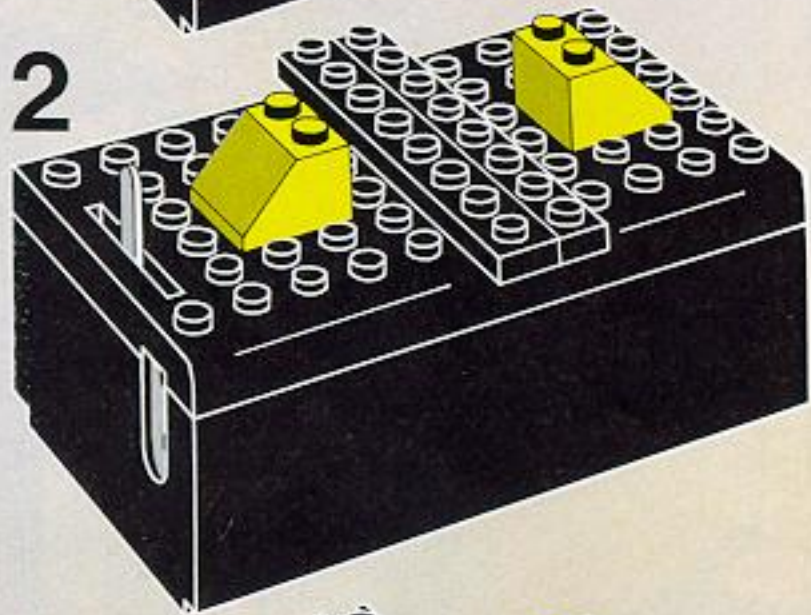
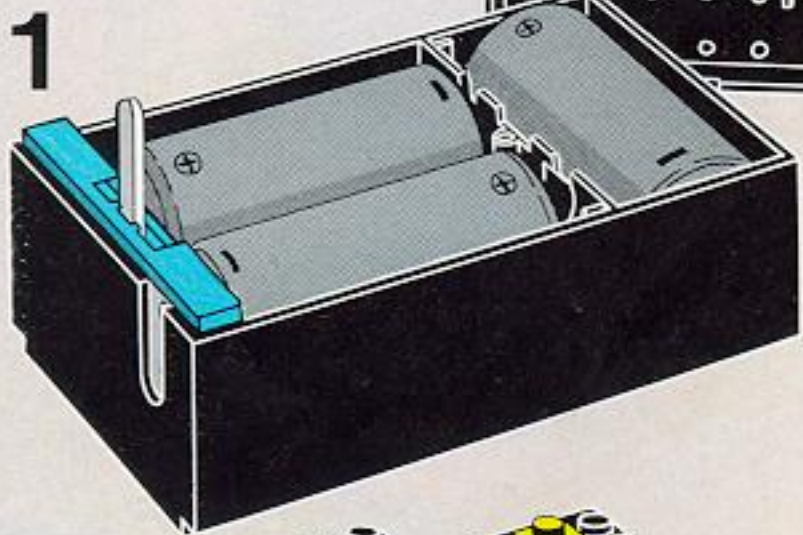

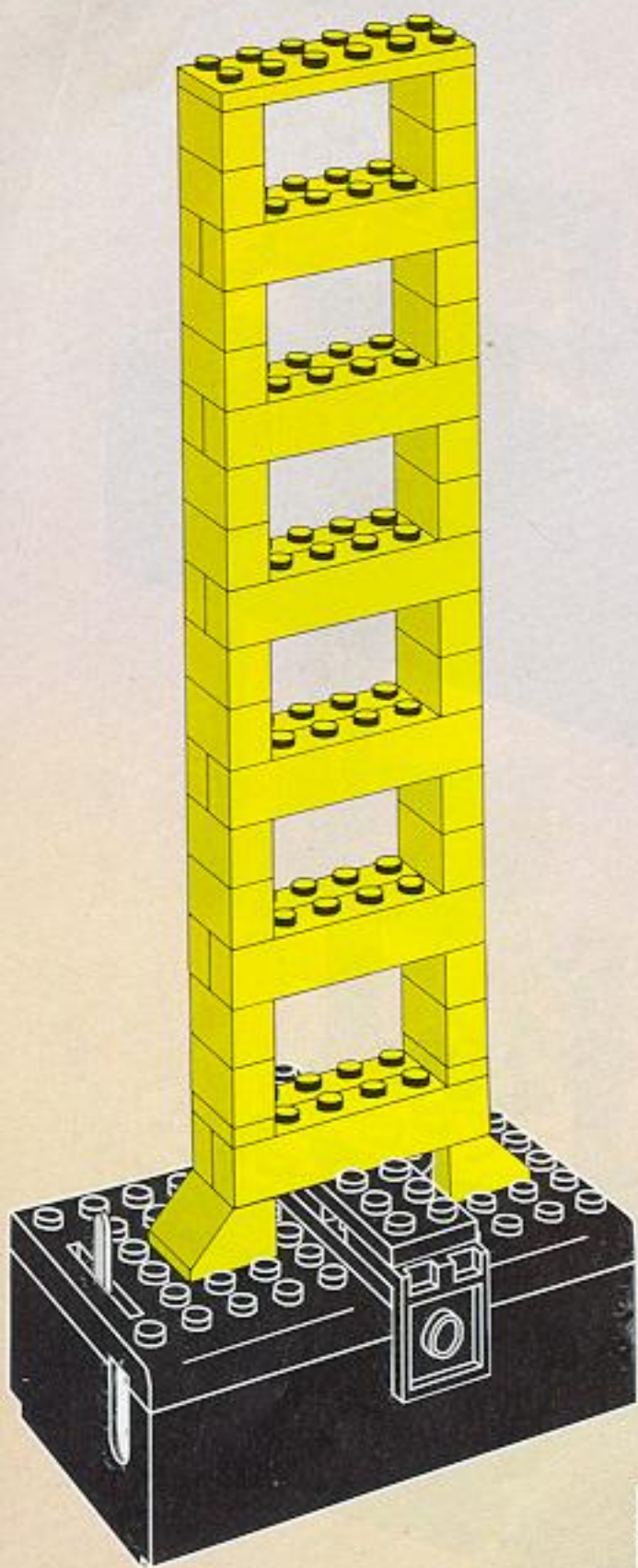

8

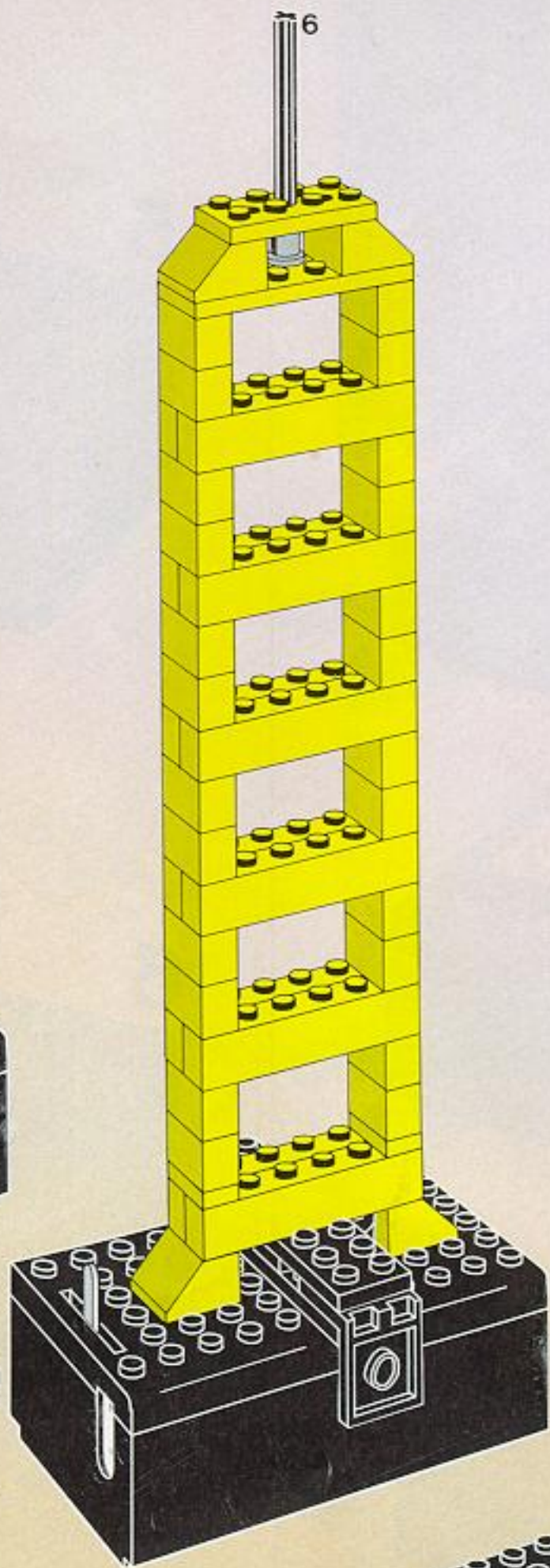

9

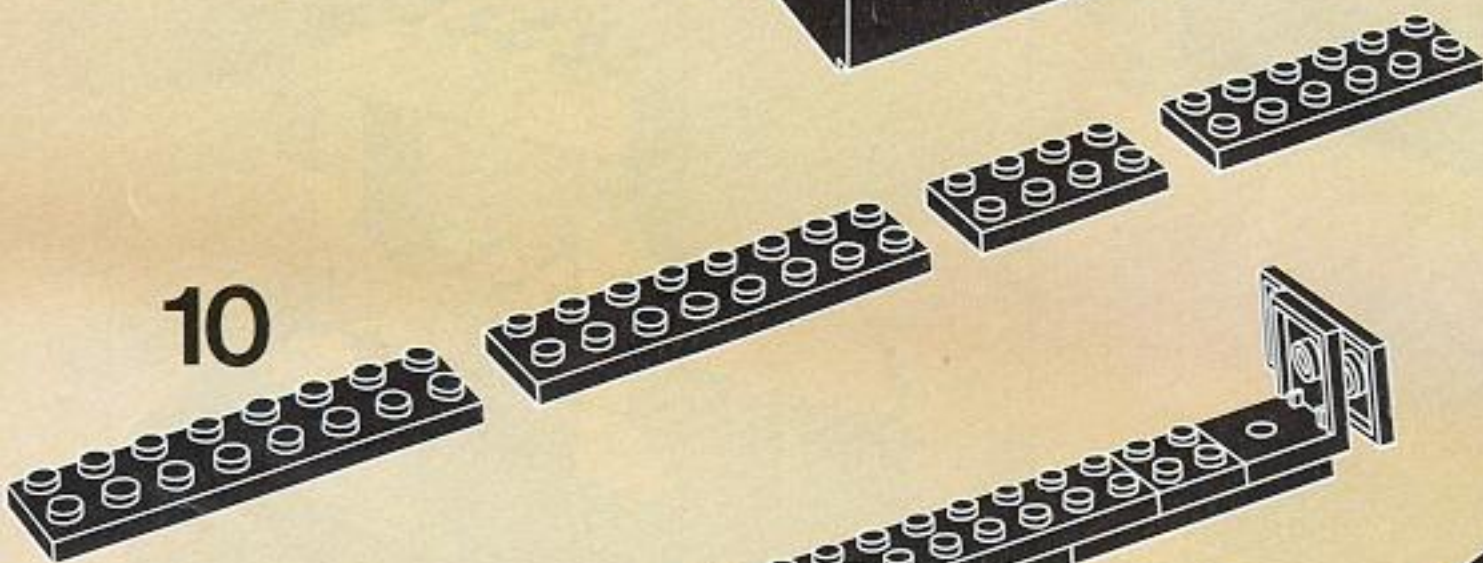

10

2

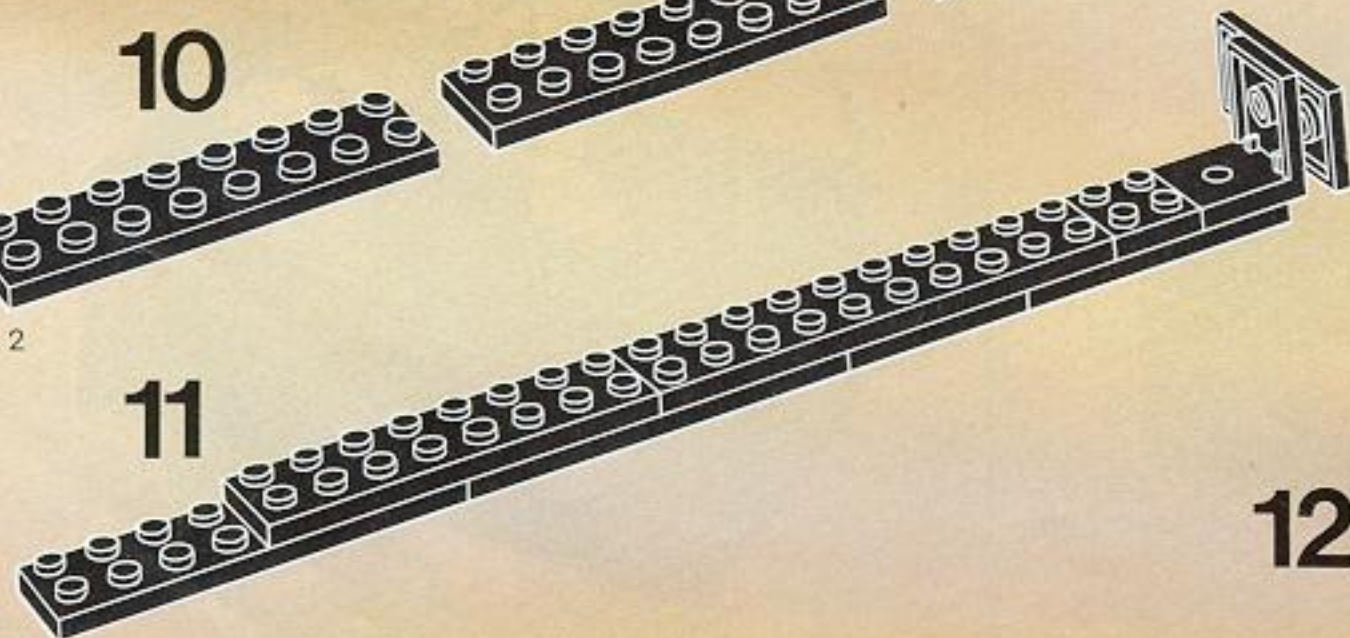

11

2

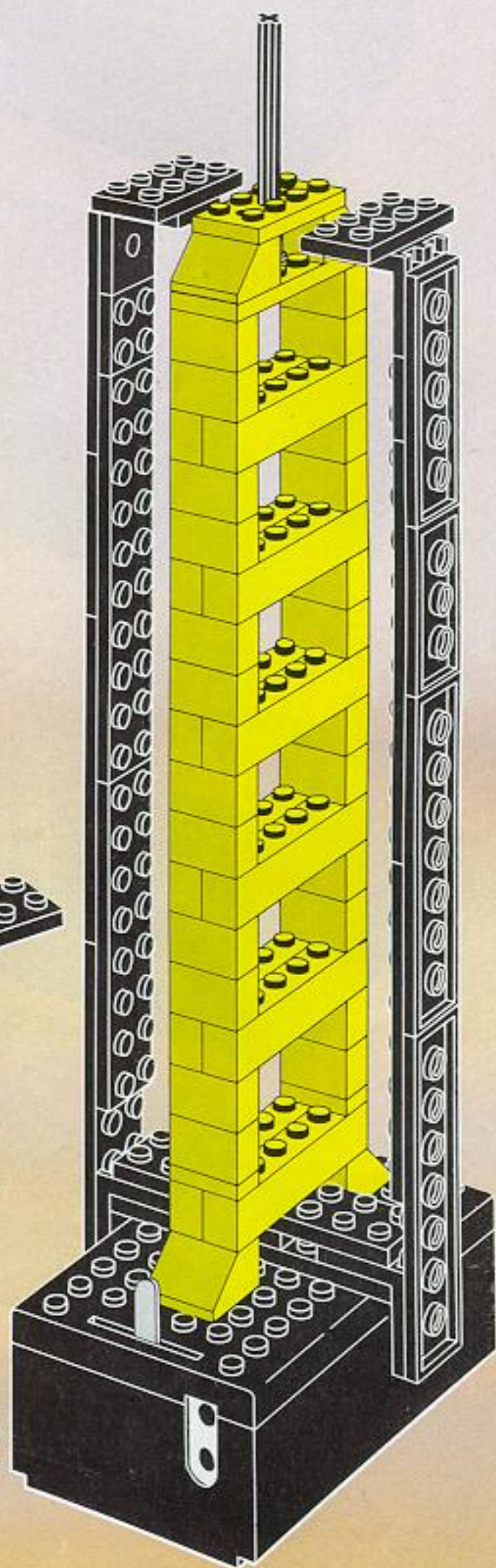

12

13



14

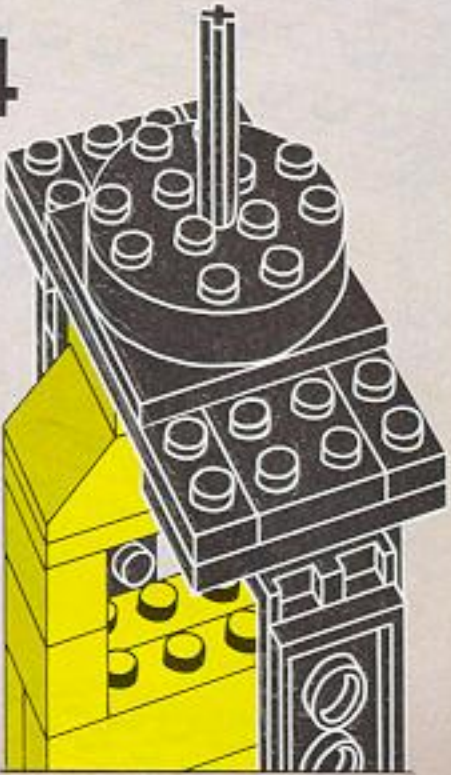

15

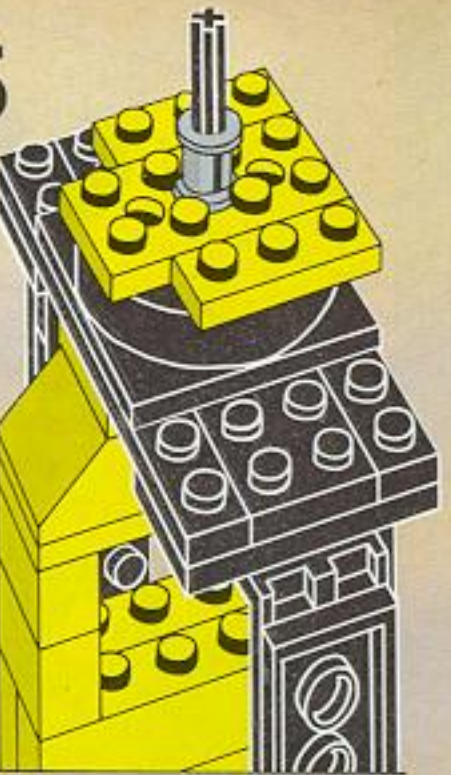

16

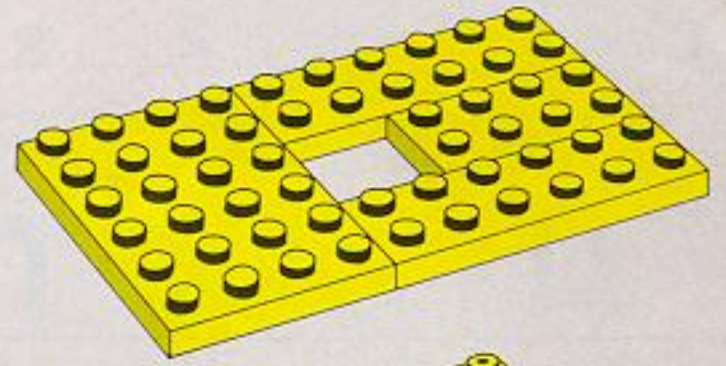

17

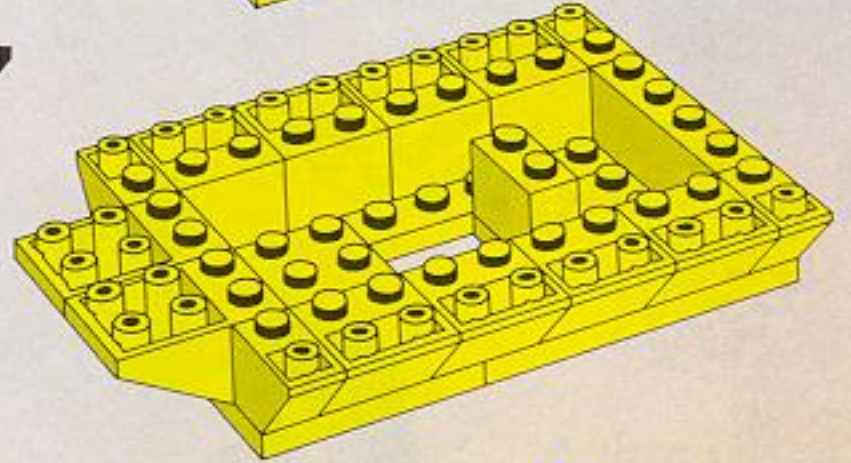

18

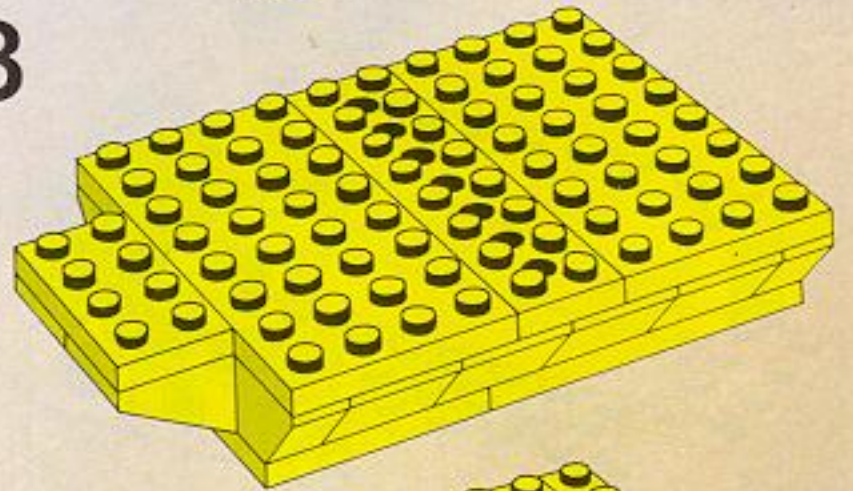

19

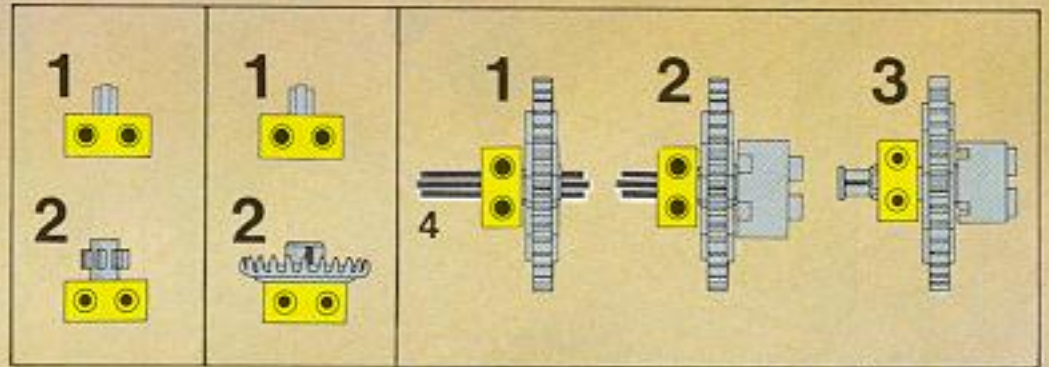
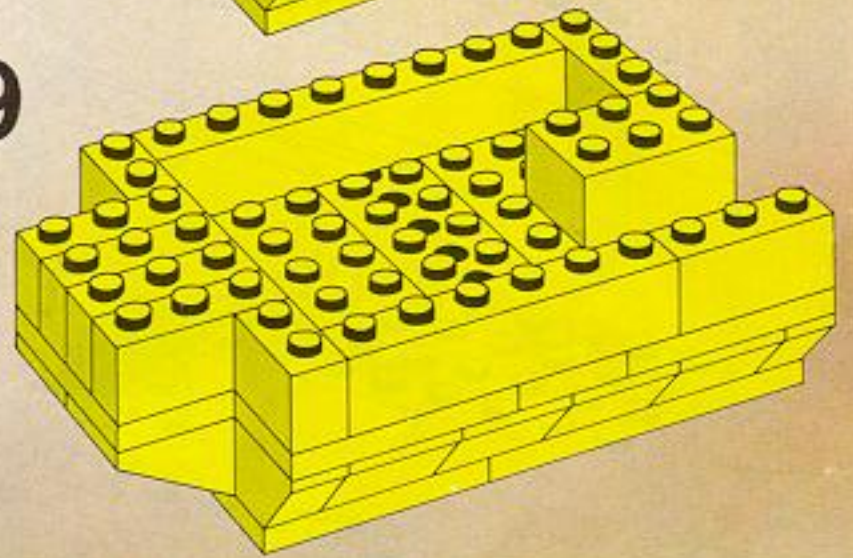

20

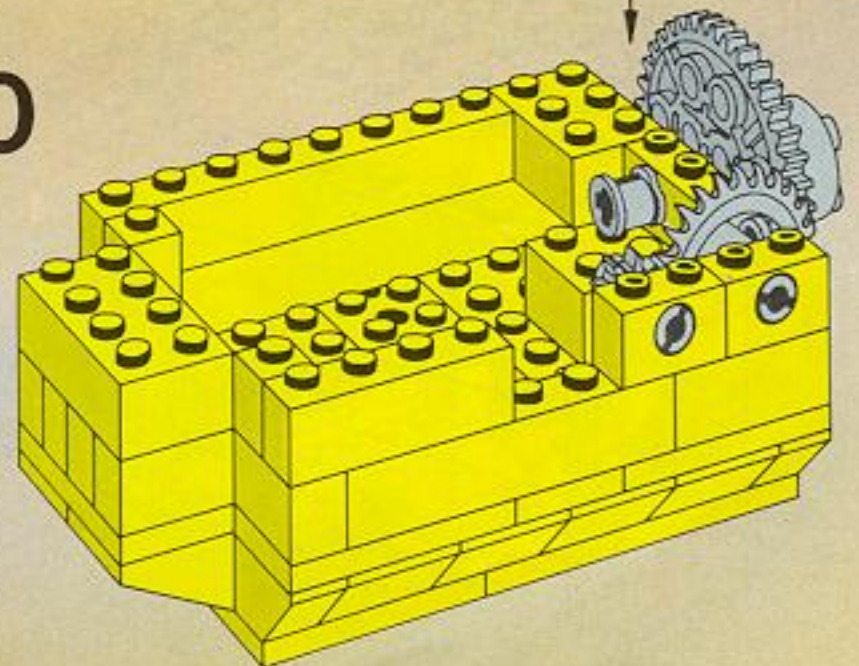

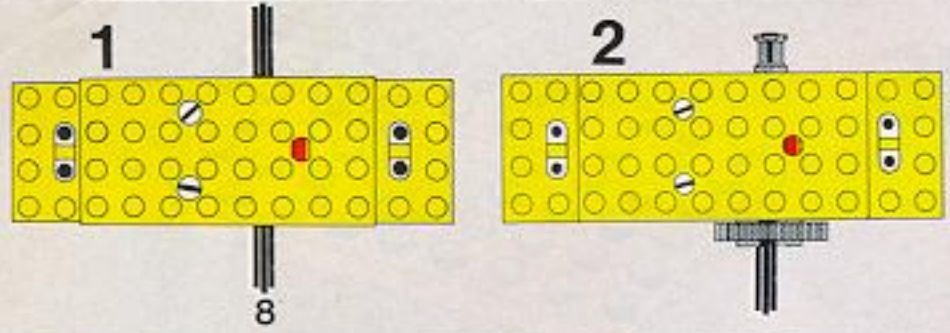

21

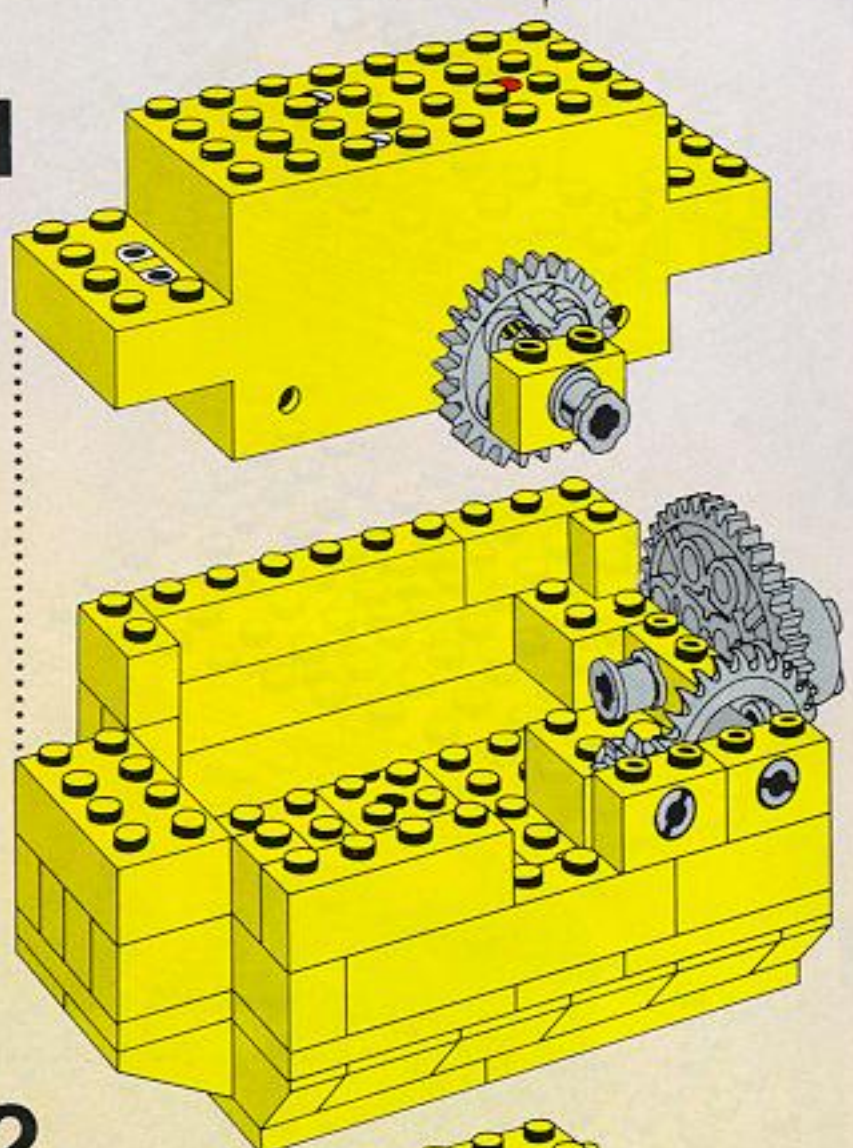

22

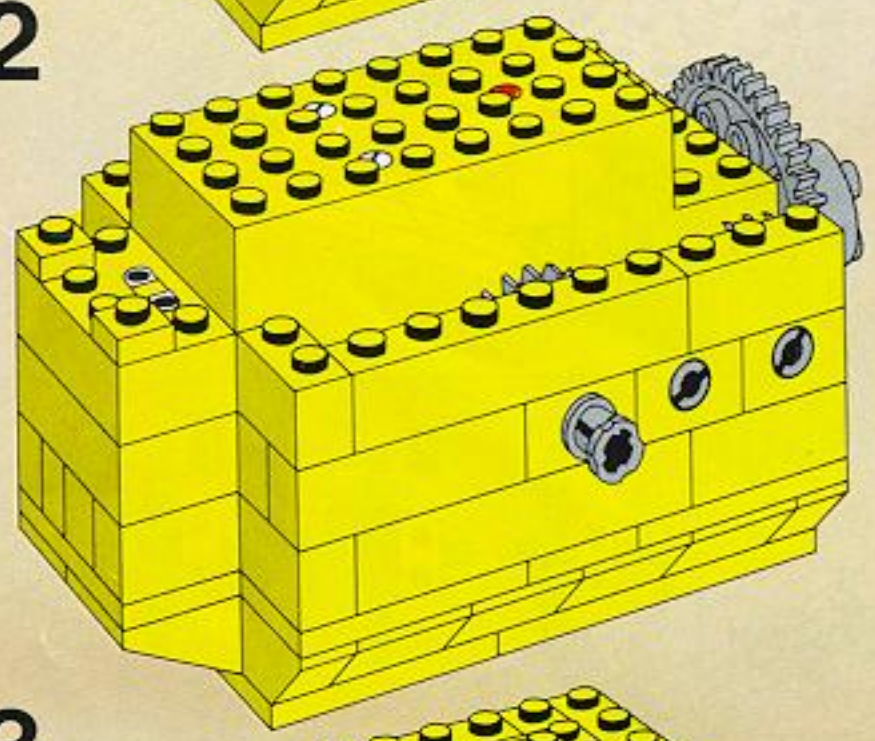

23

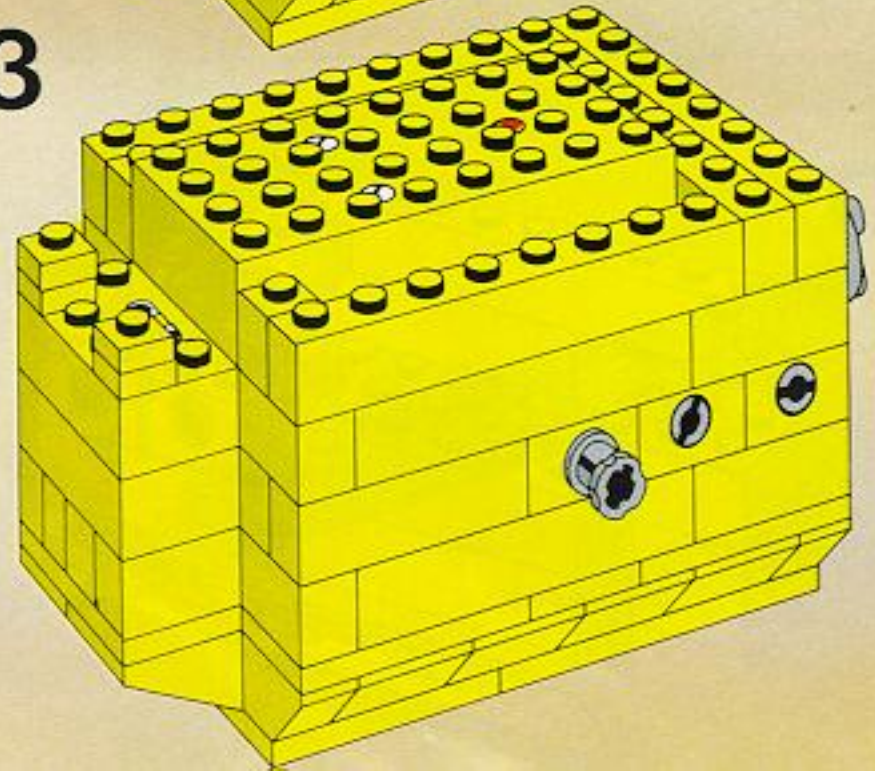

24

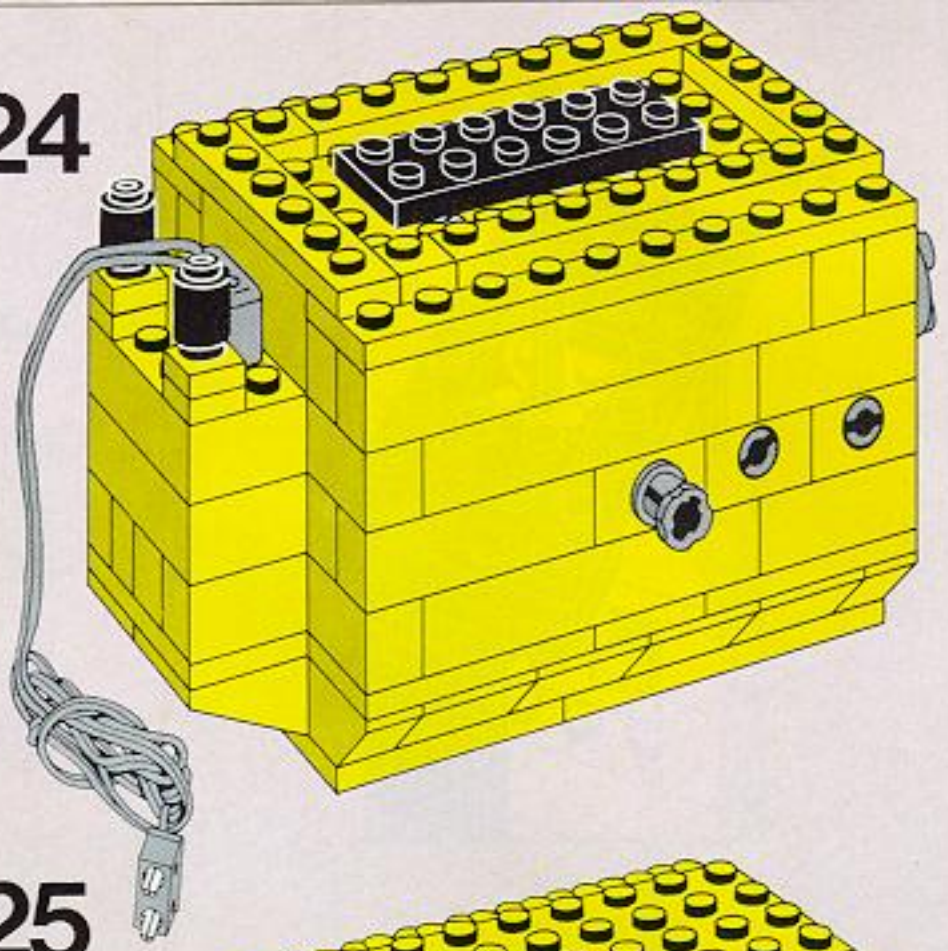

25

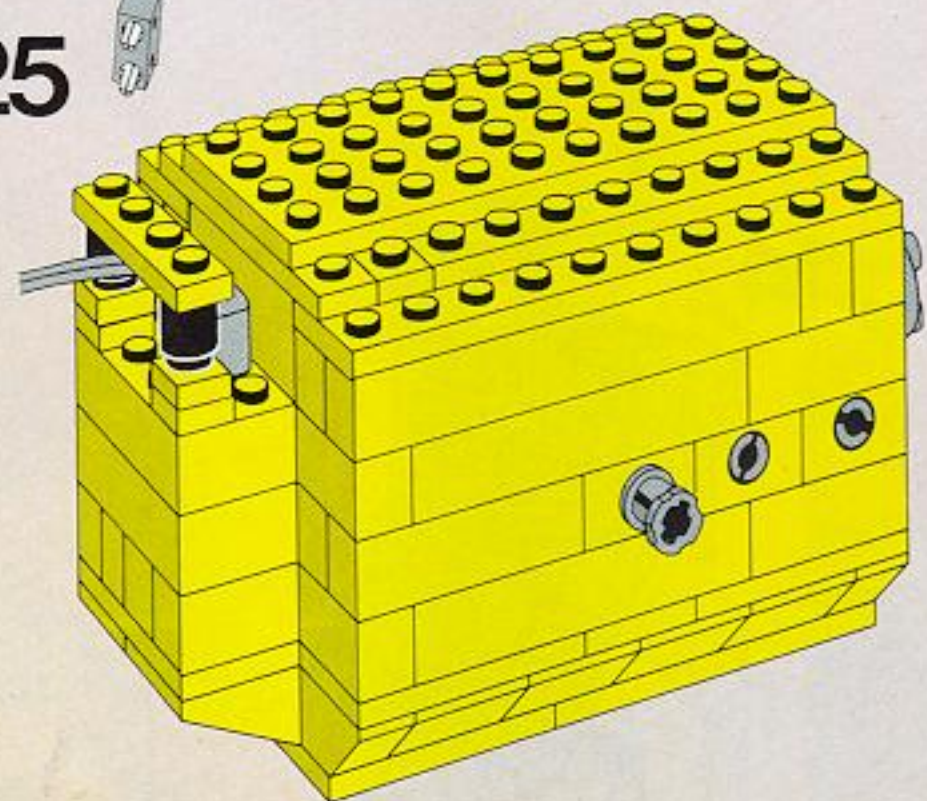

26

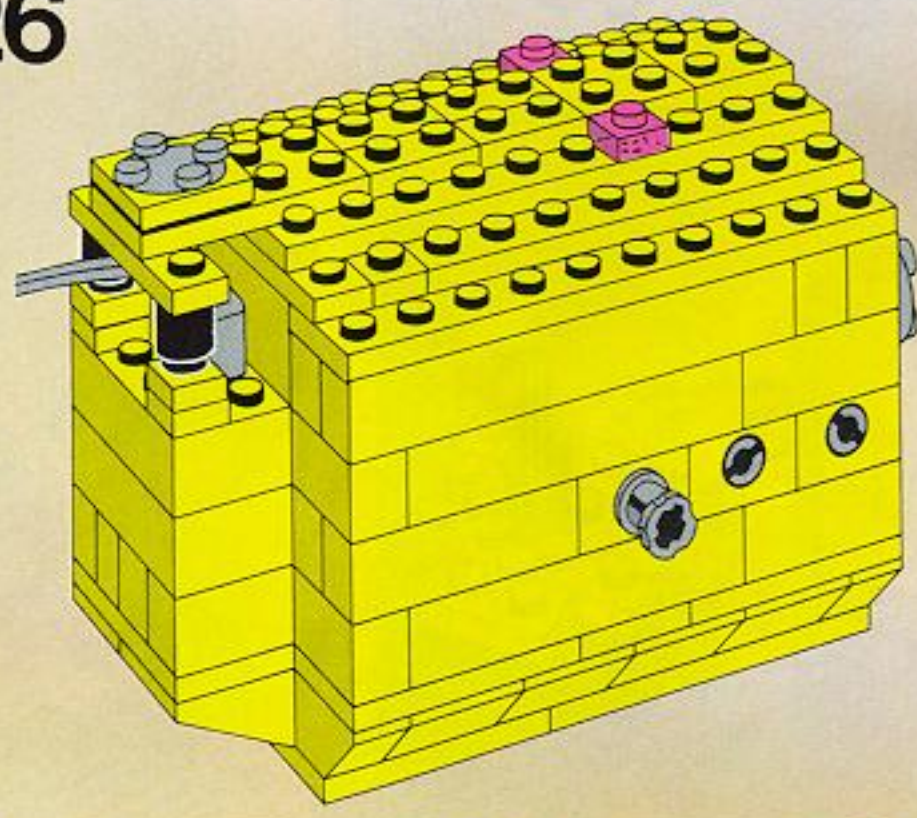

27



28

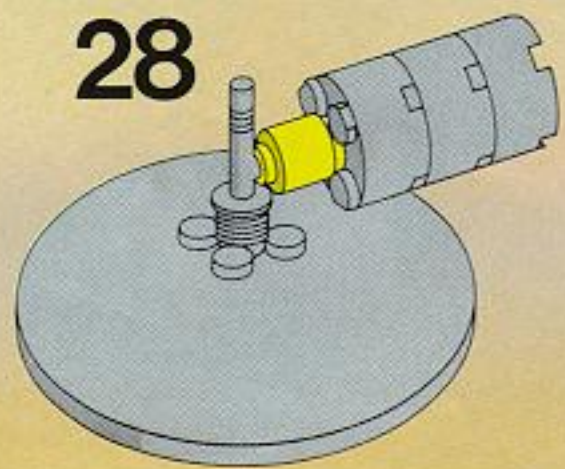

29

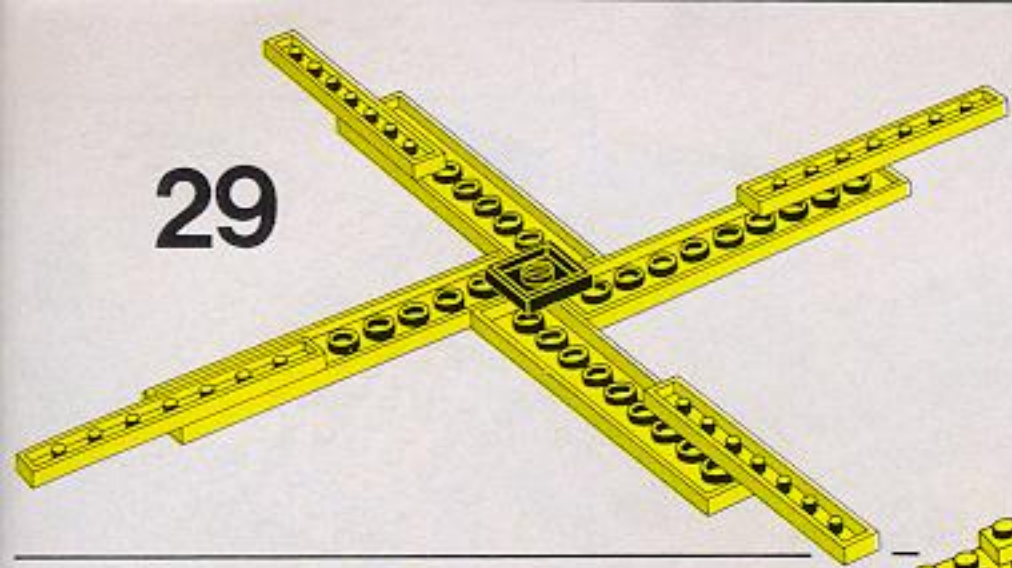

30

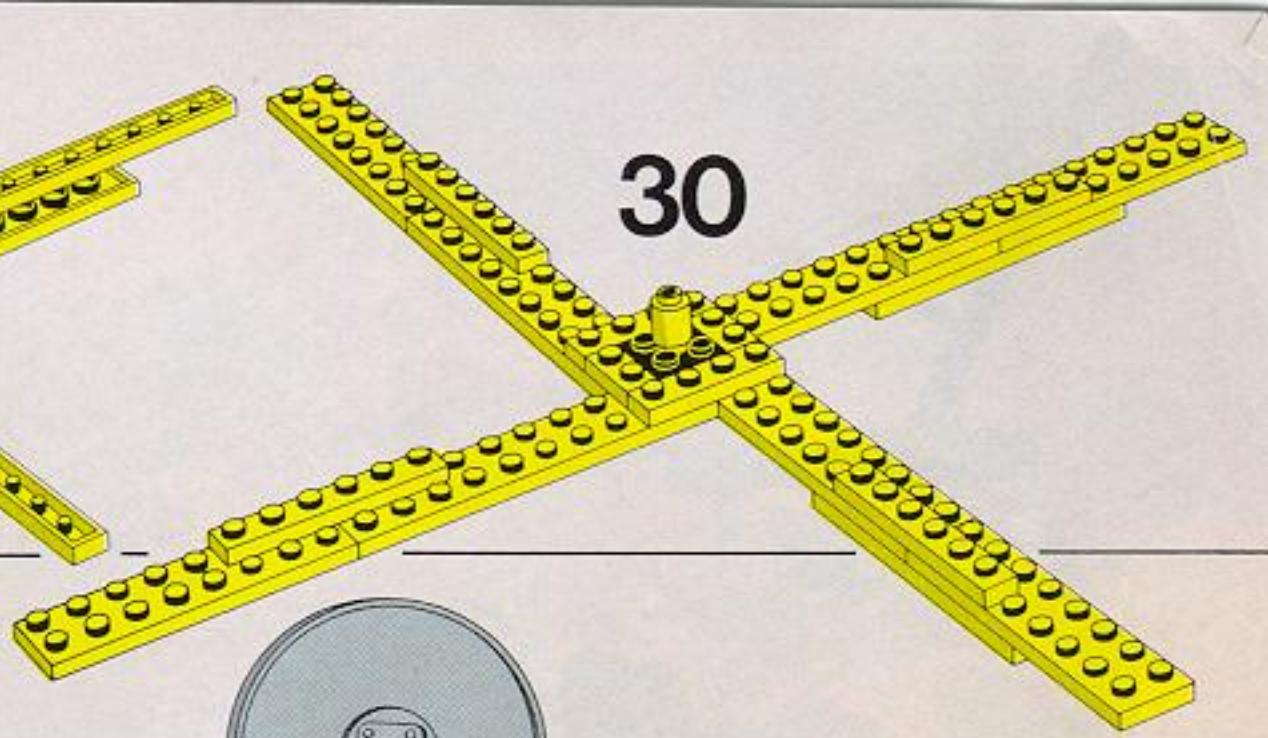

31

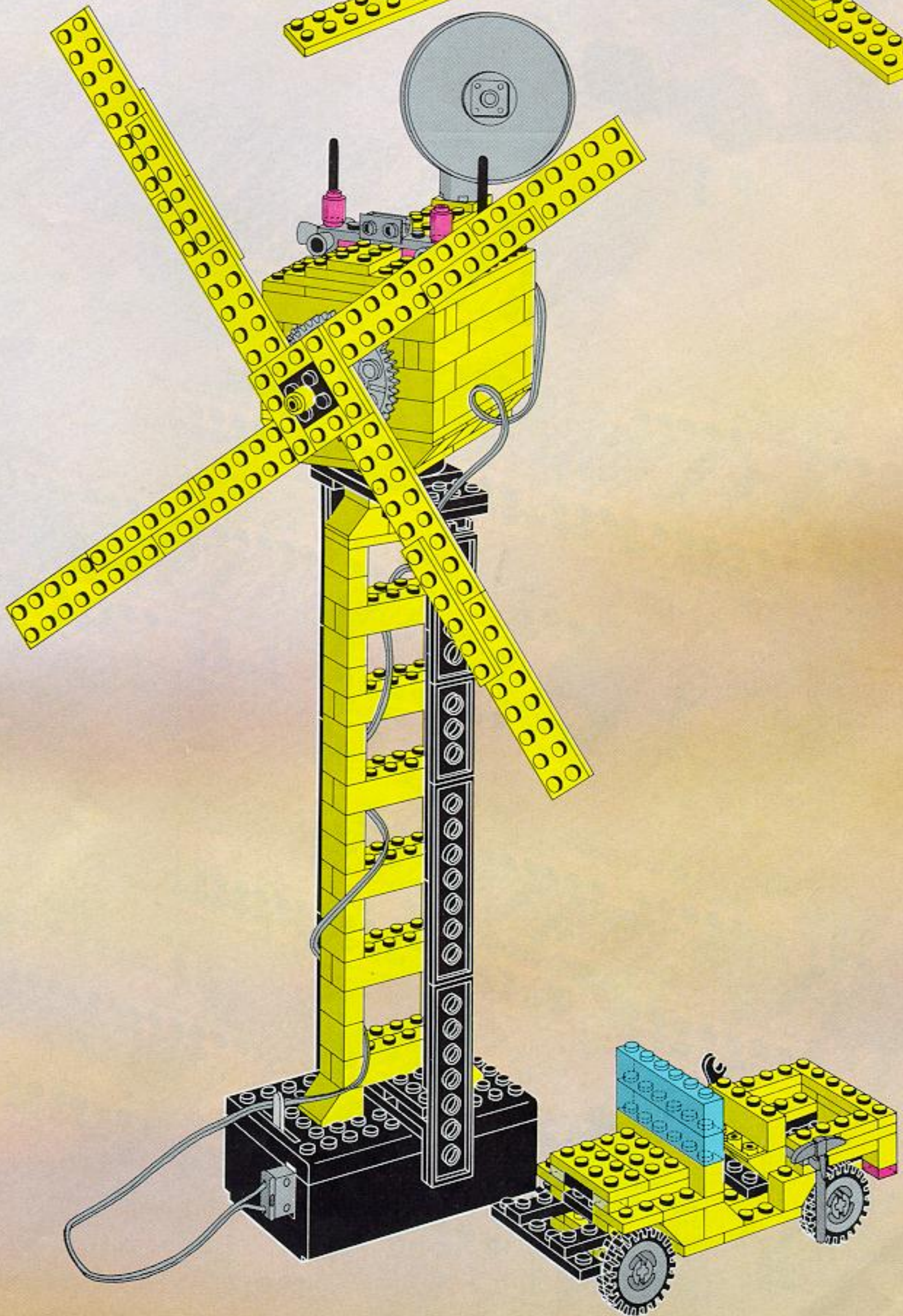

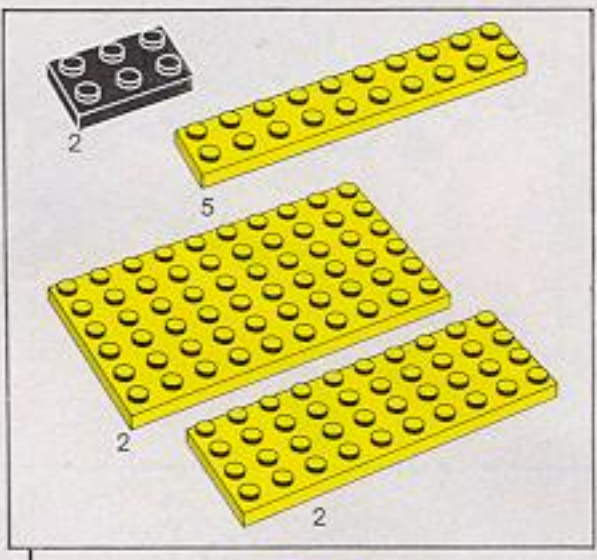

1

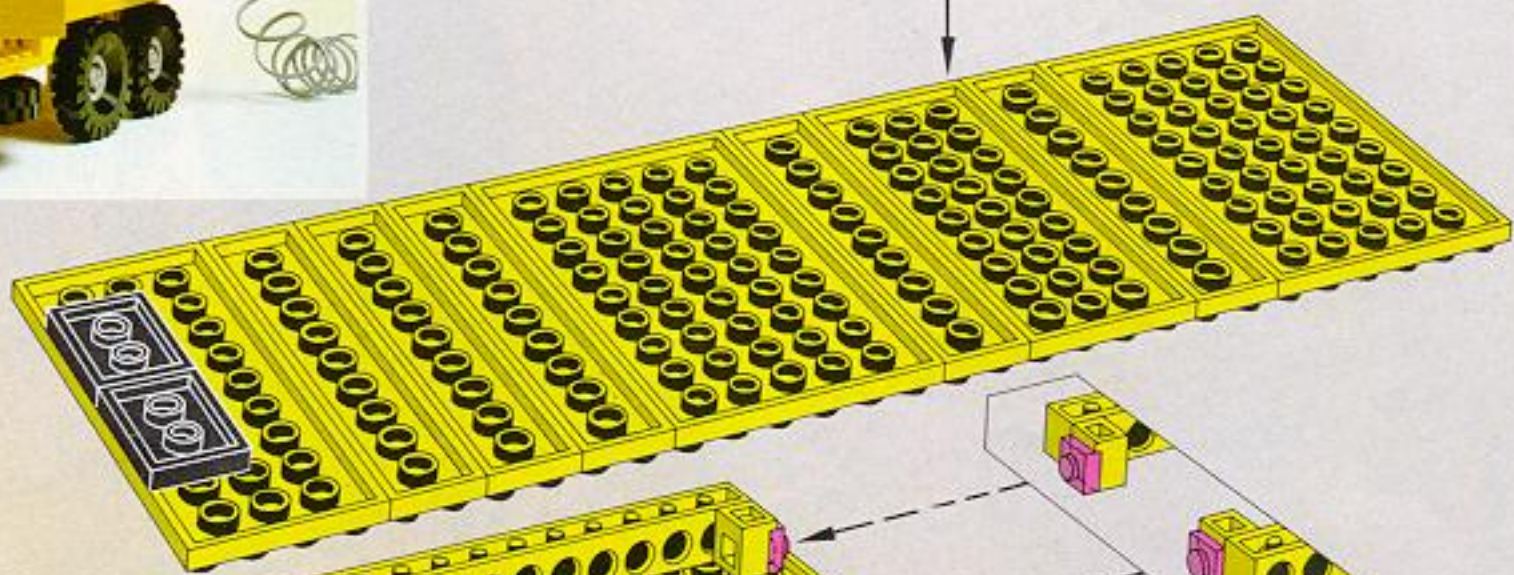

2

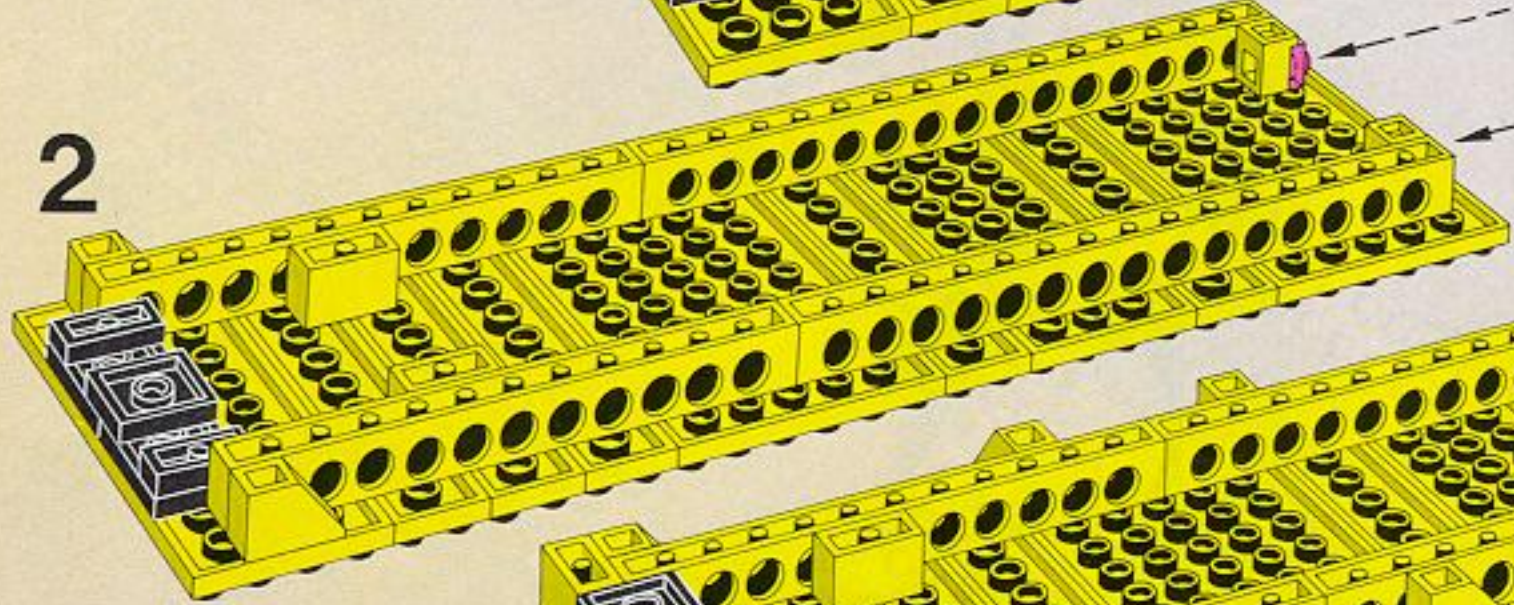

3

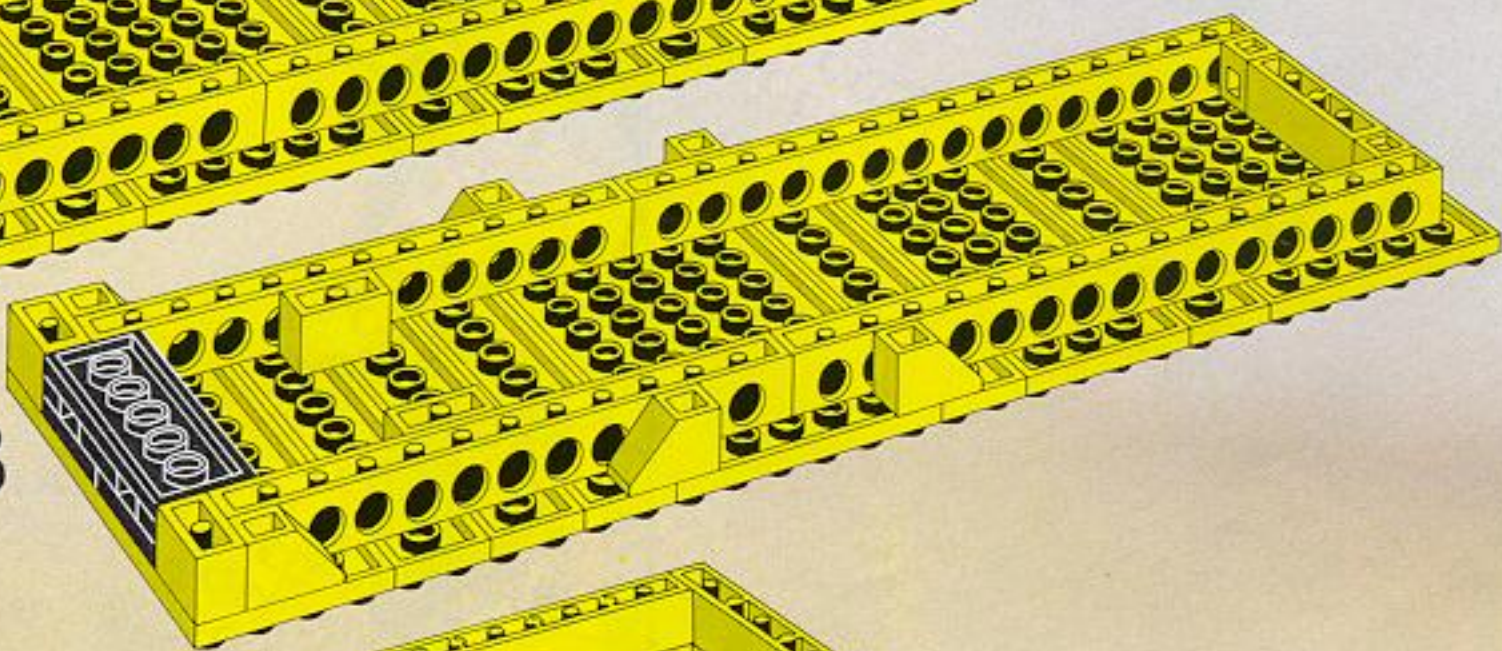

4

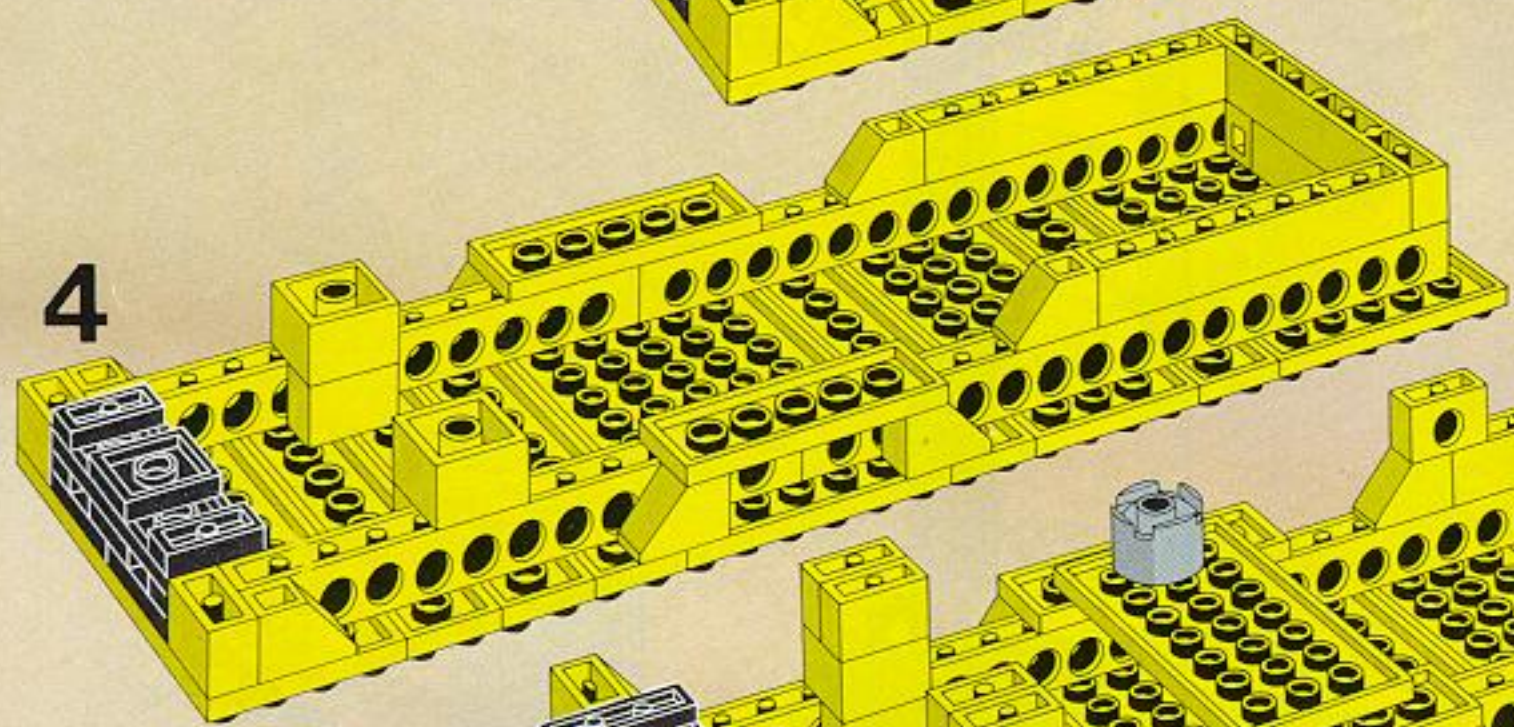

5

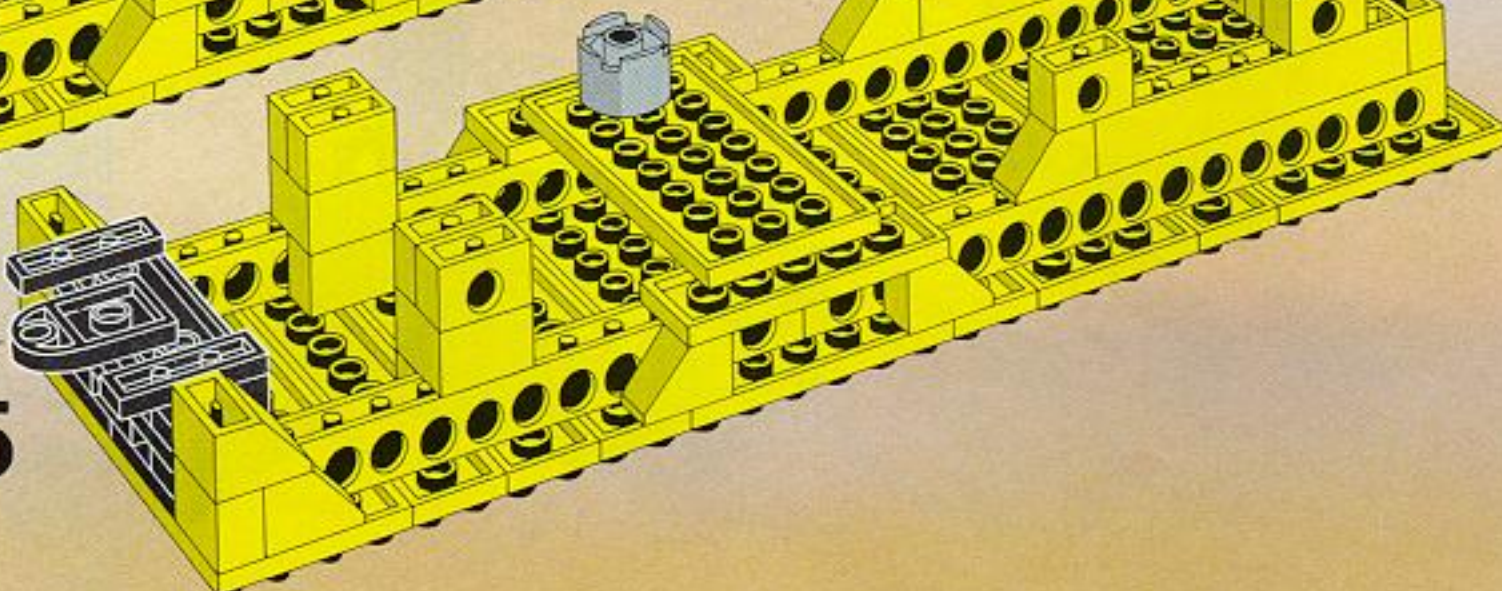
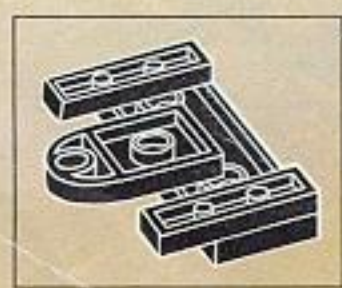

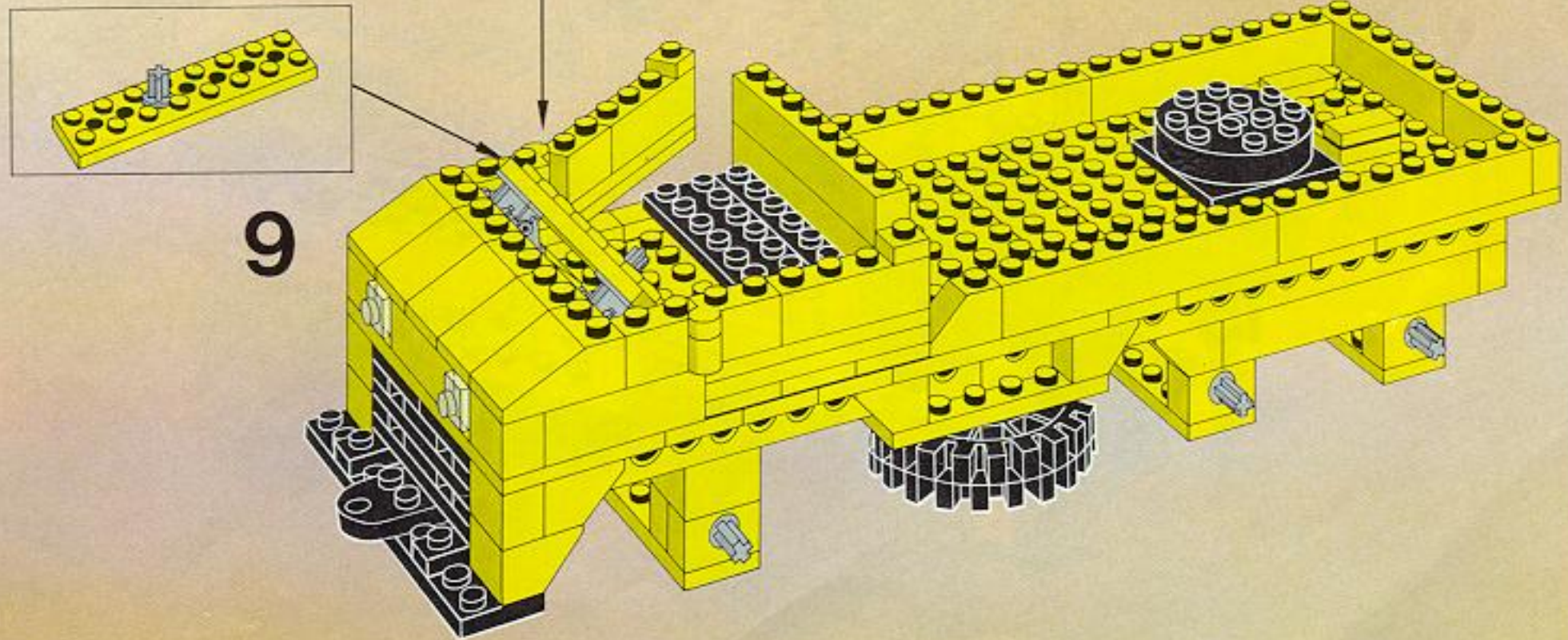
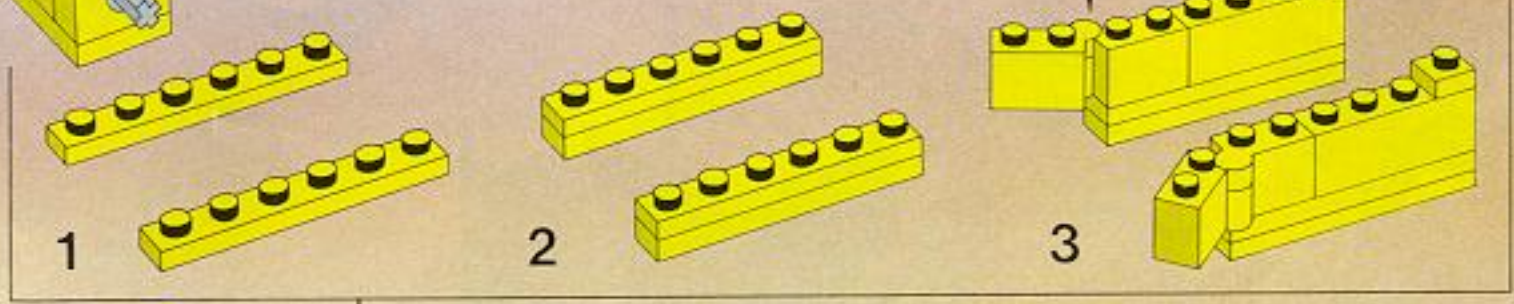
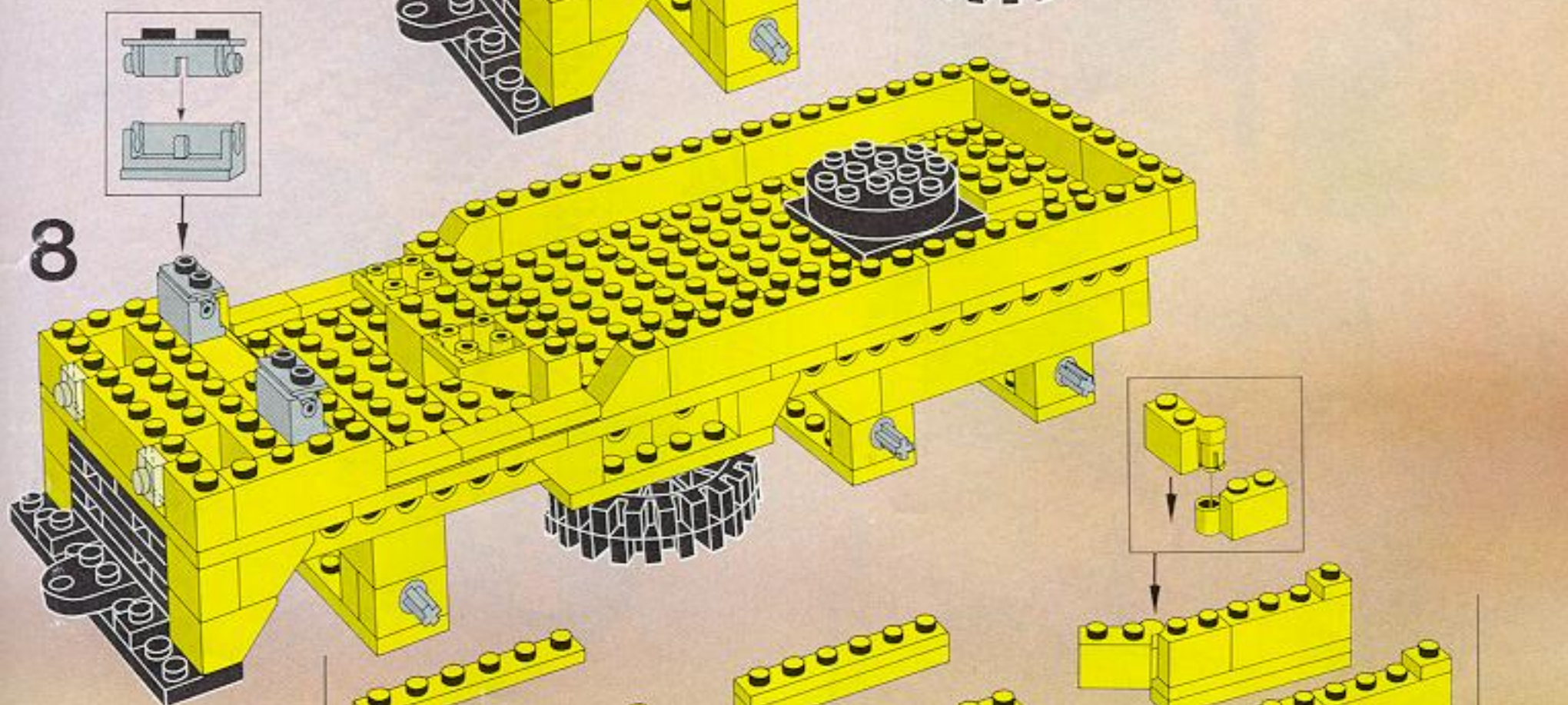
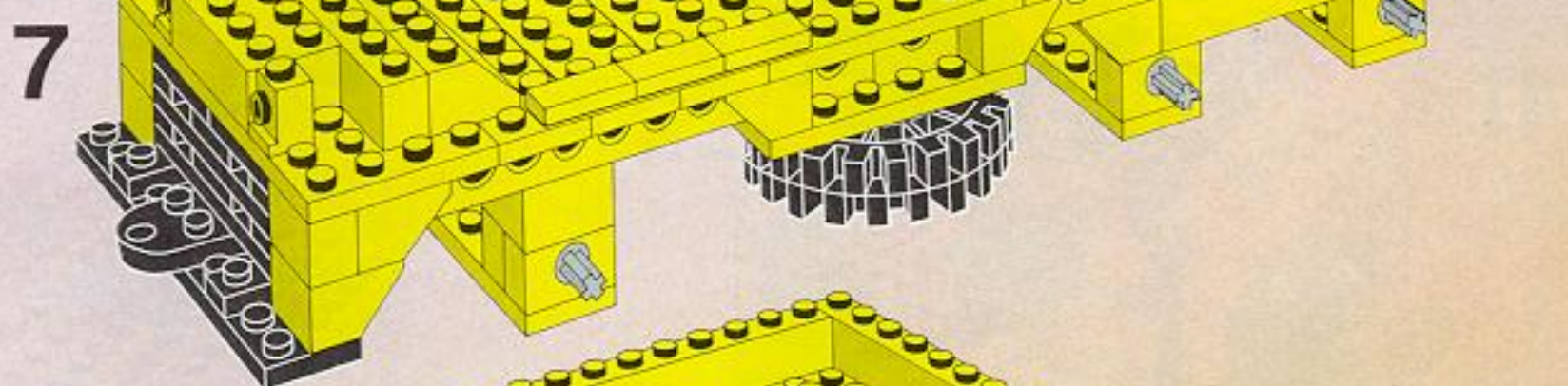
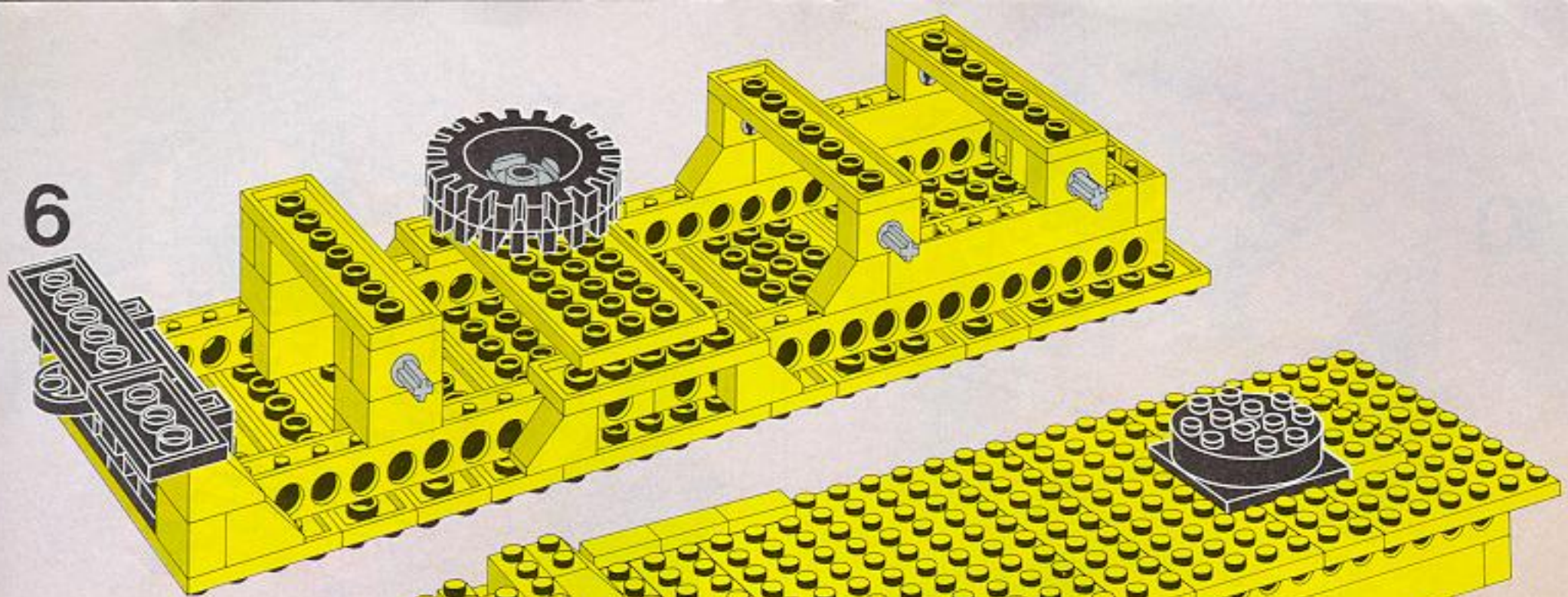

10

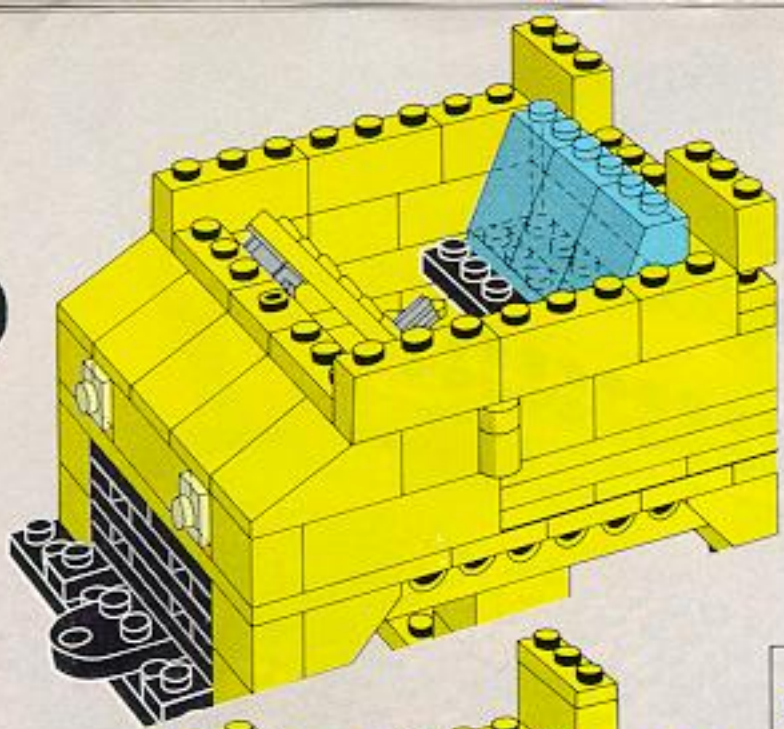

13

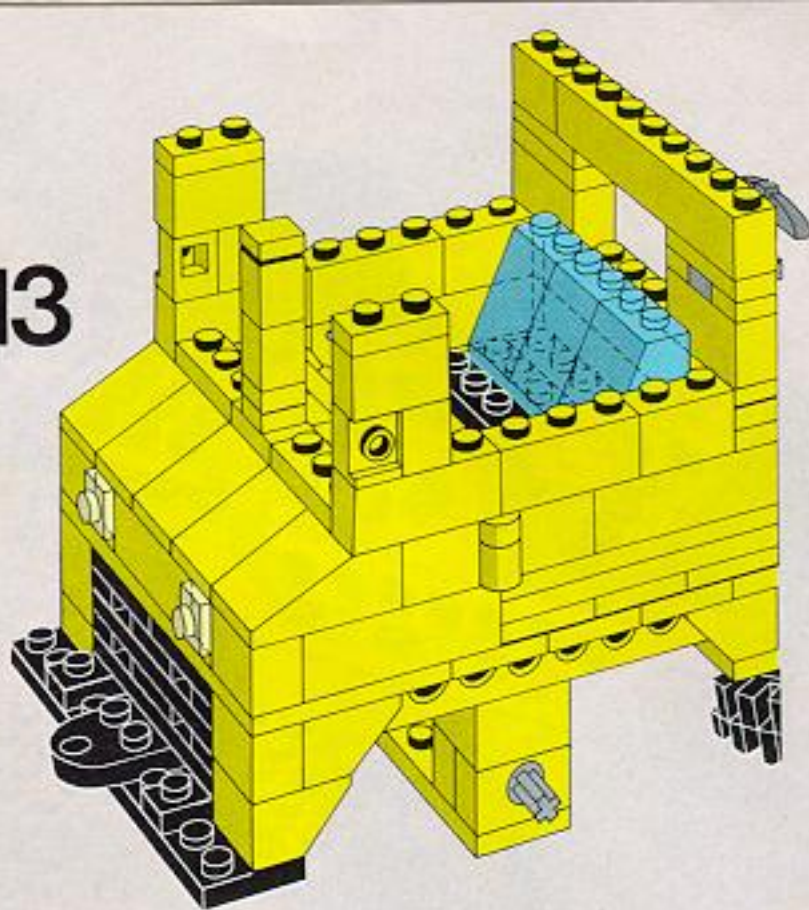

11

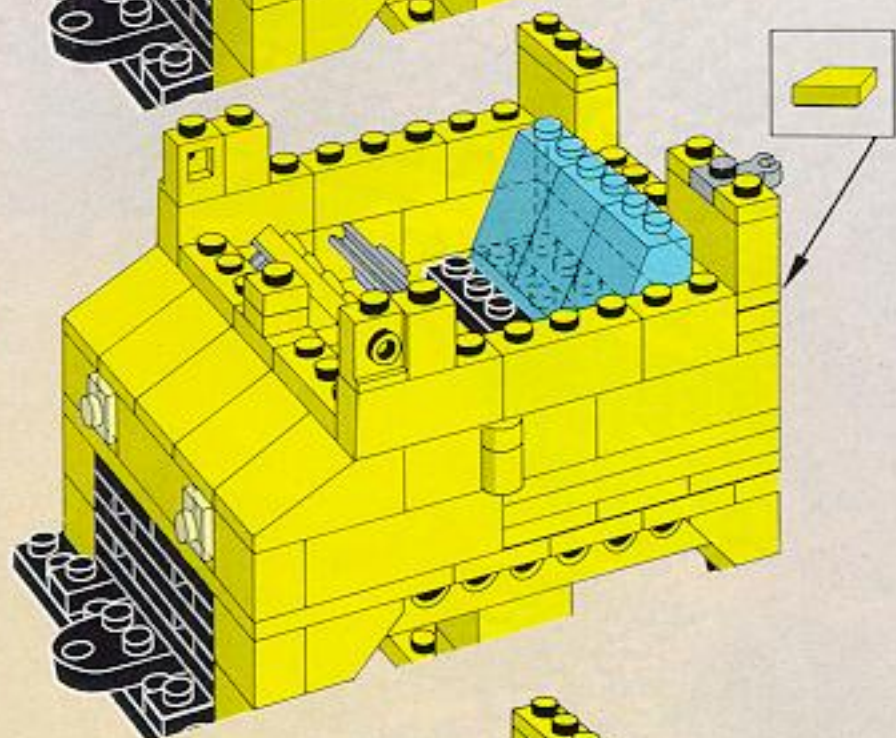

14

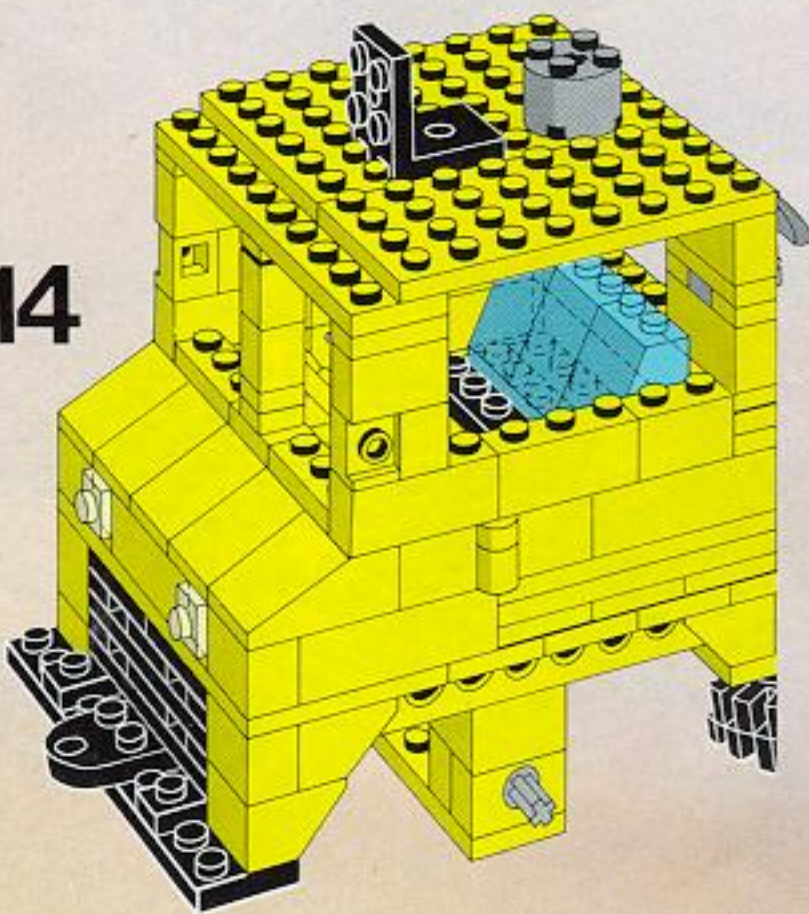

12

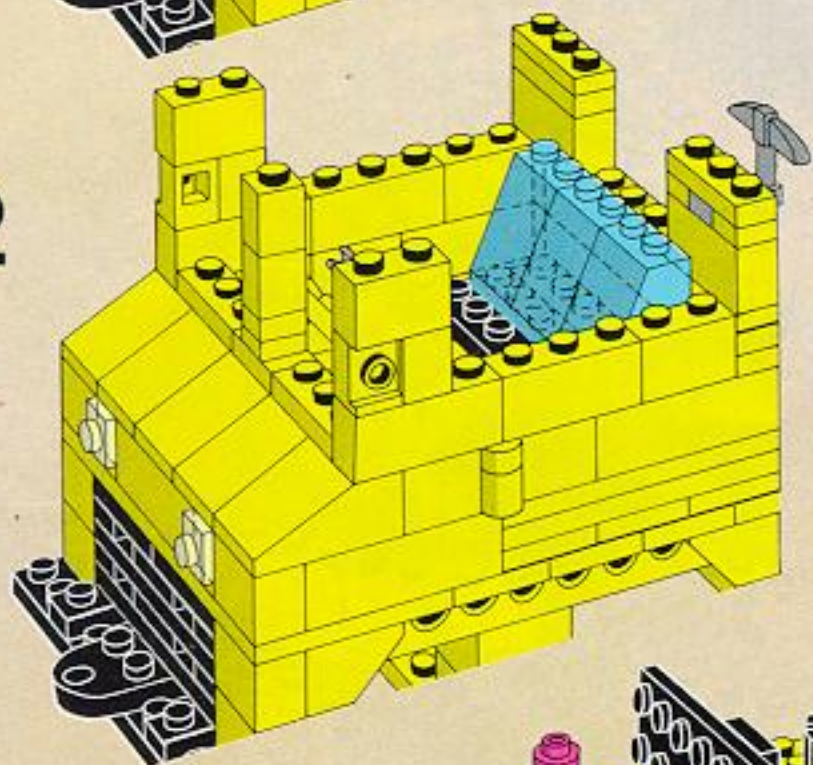

15

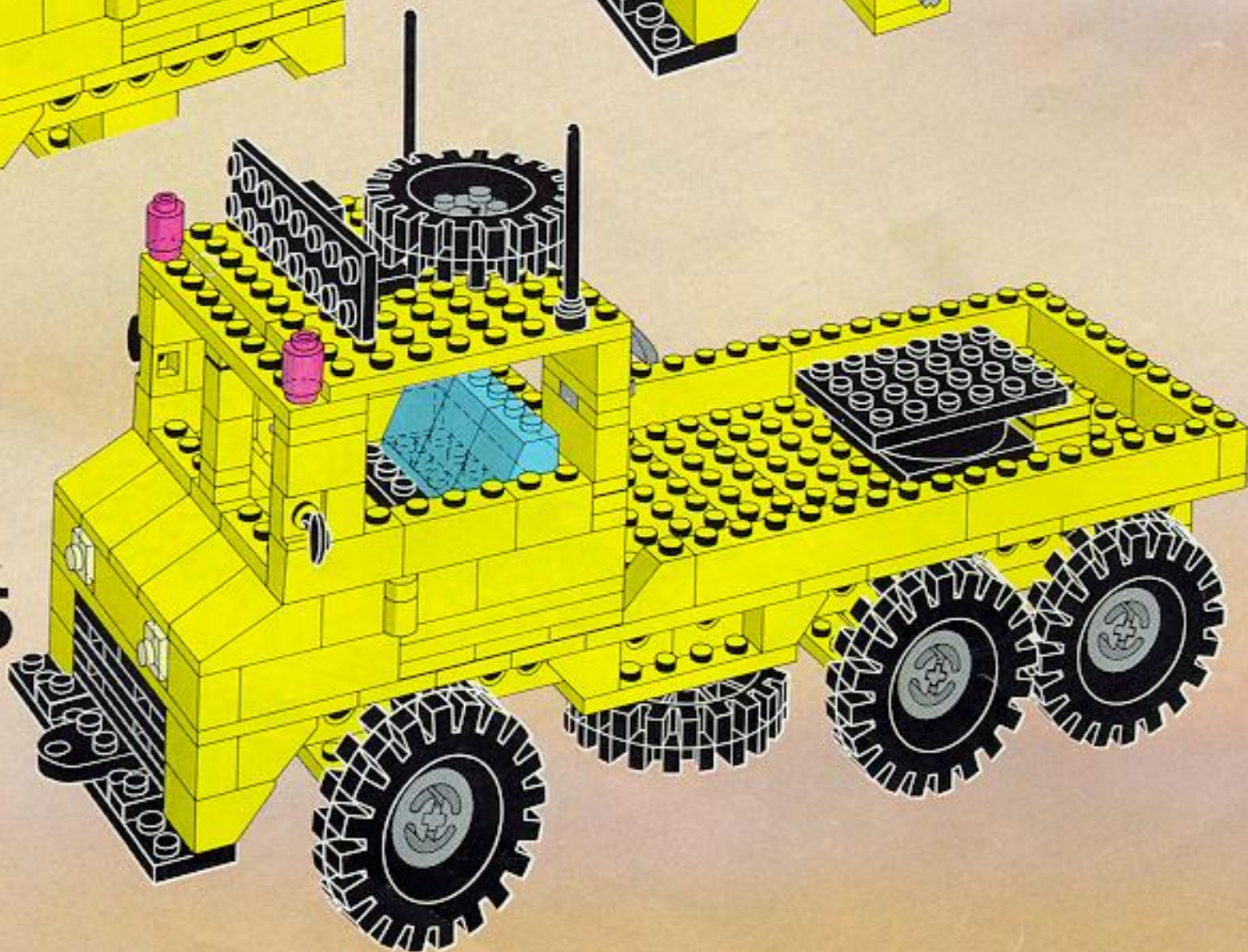



16

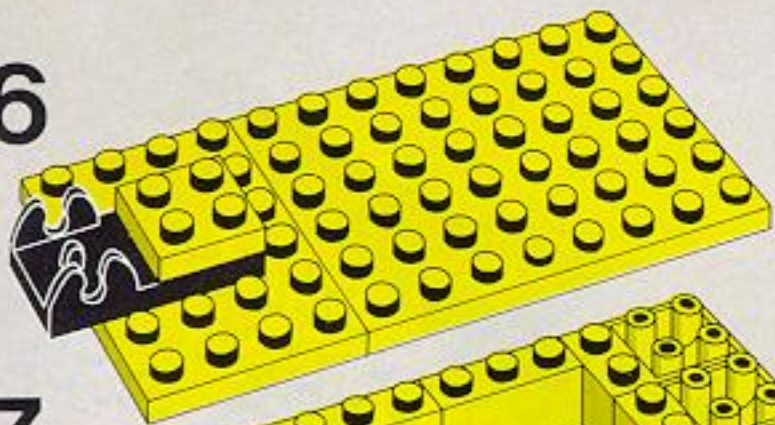

17

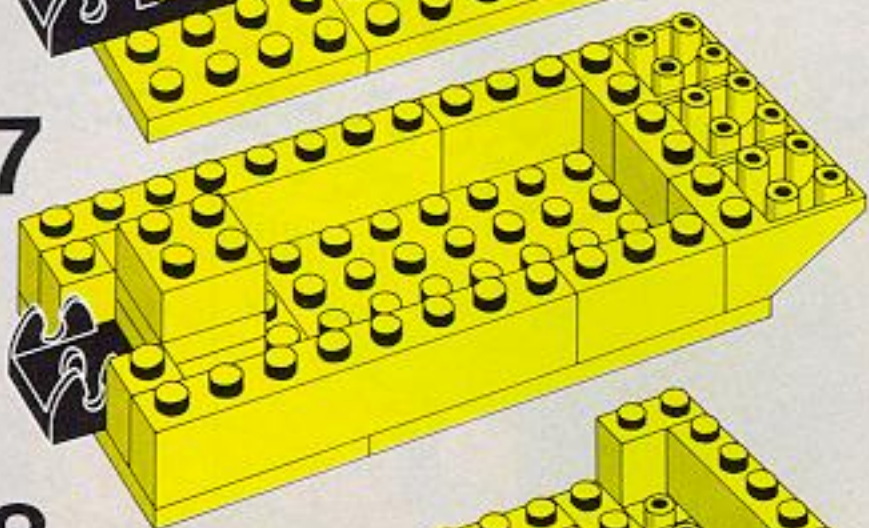

18

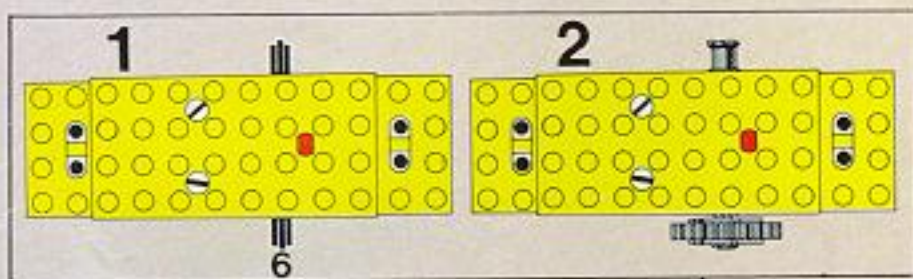
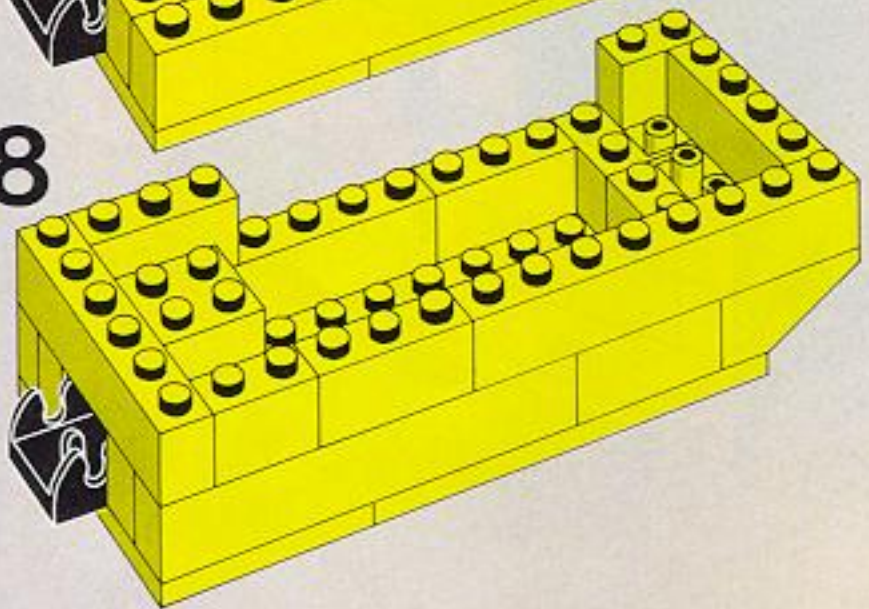

19

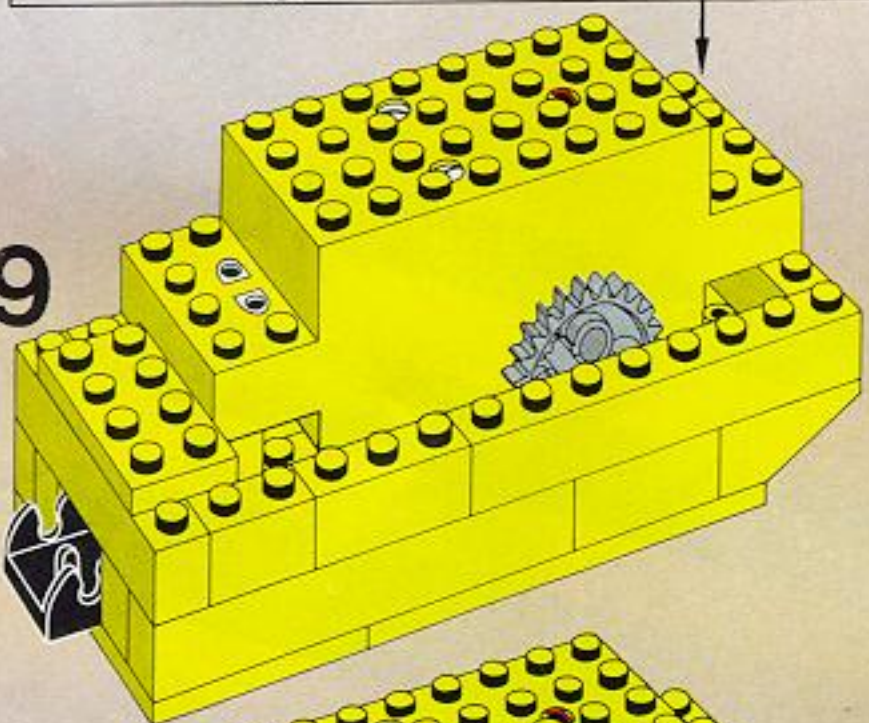

20

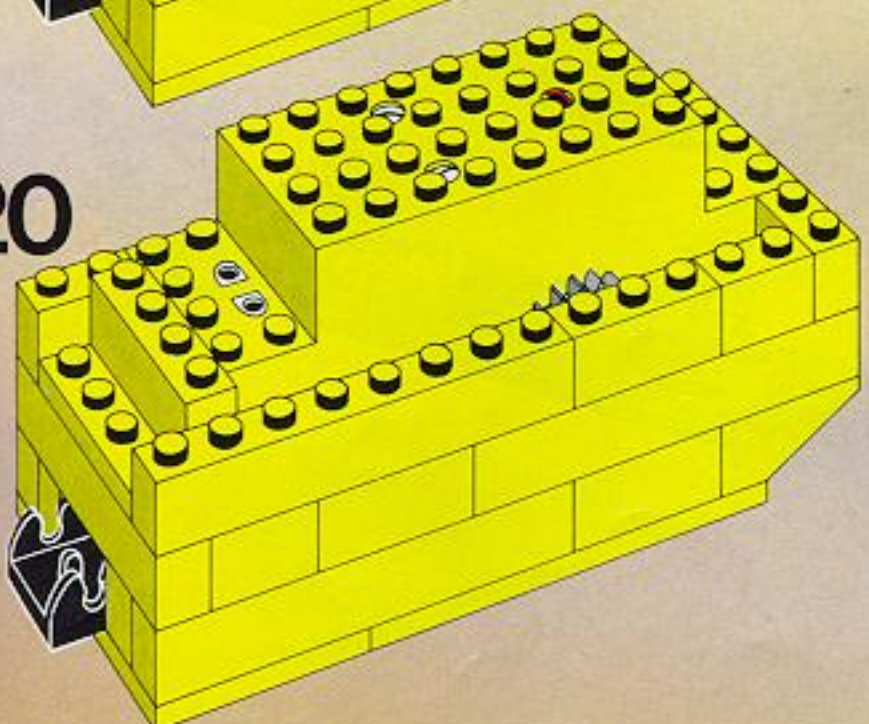

21

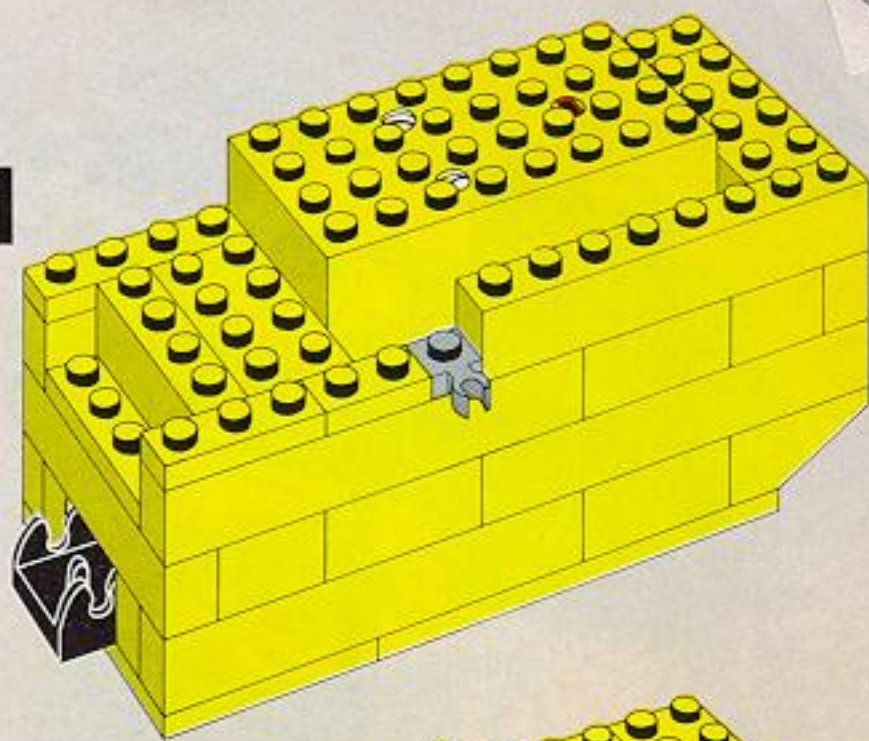

22

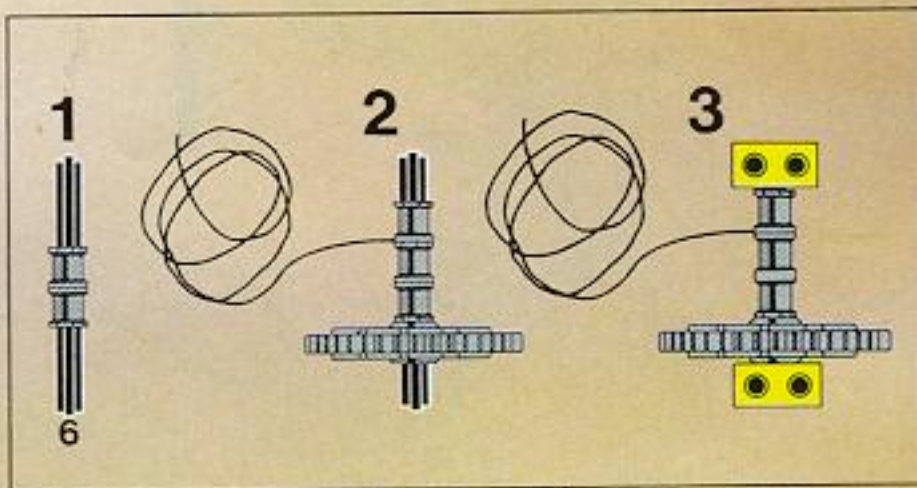
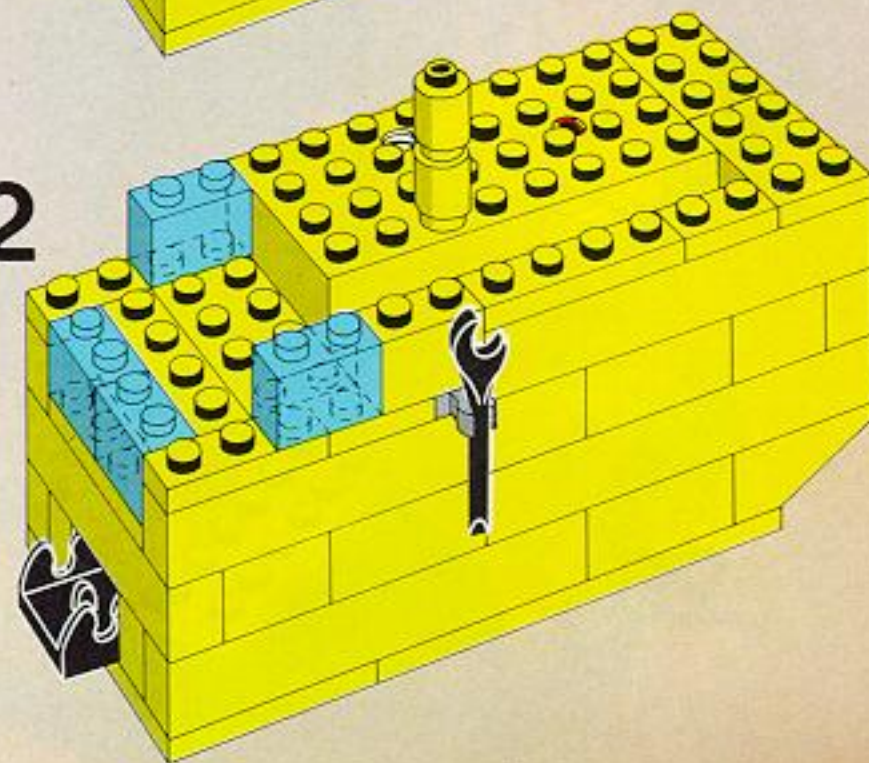

23

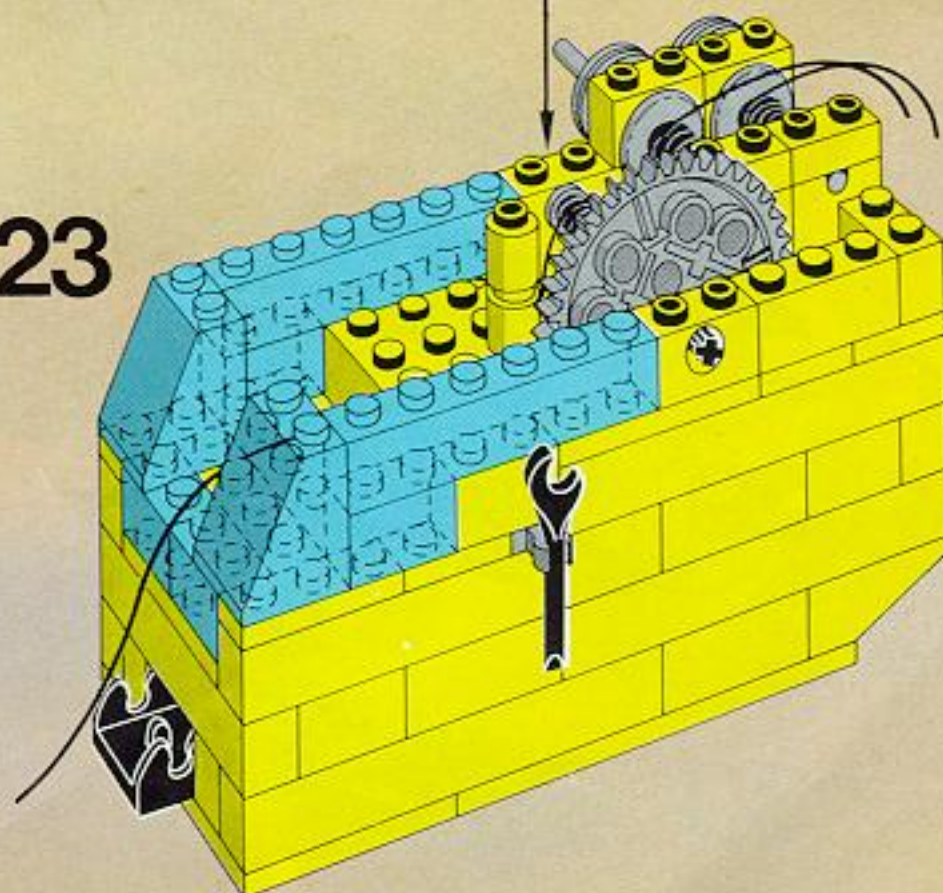

24

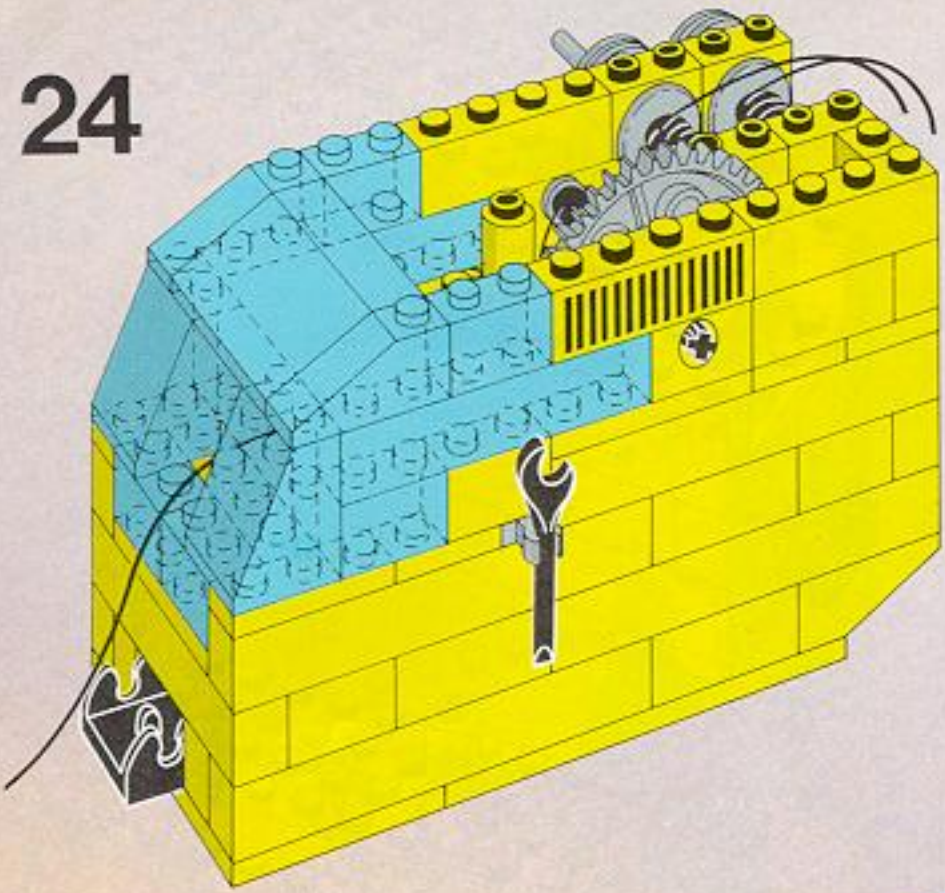

25

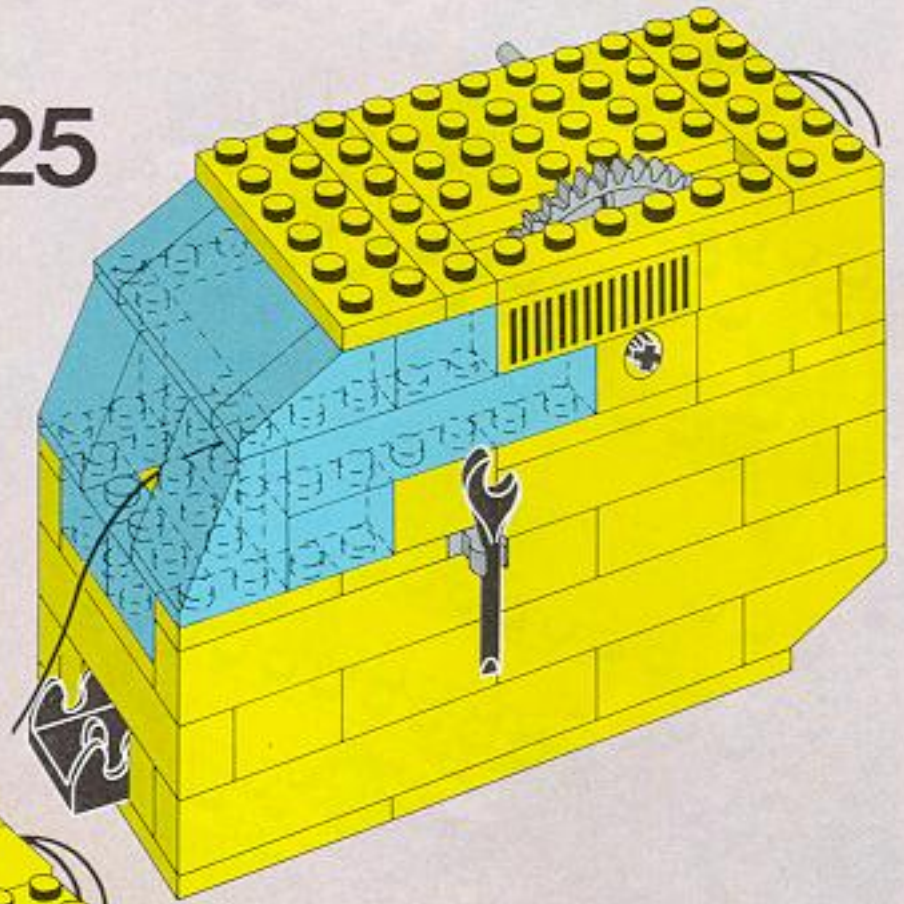

26

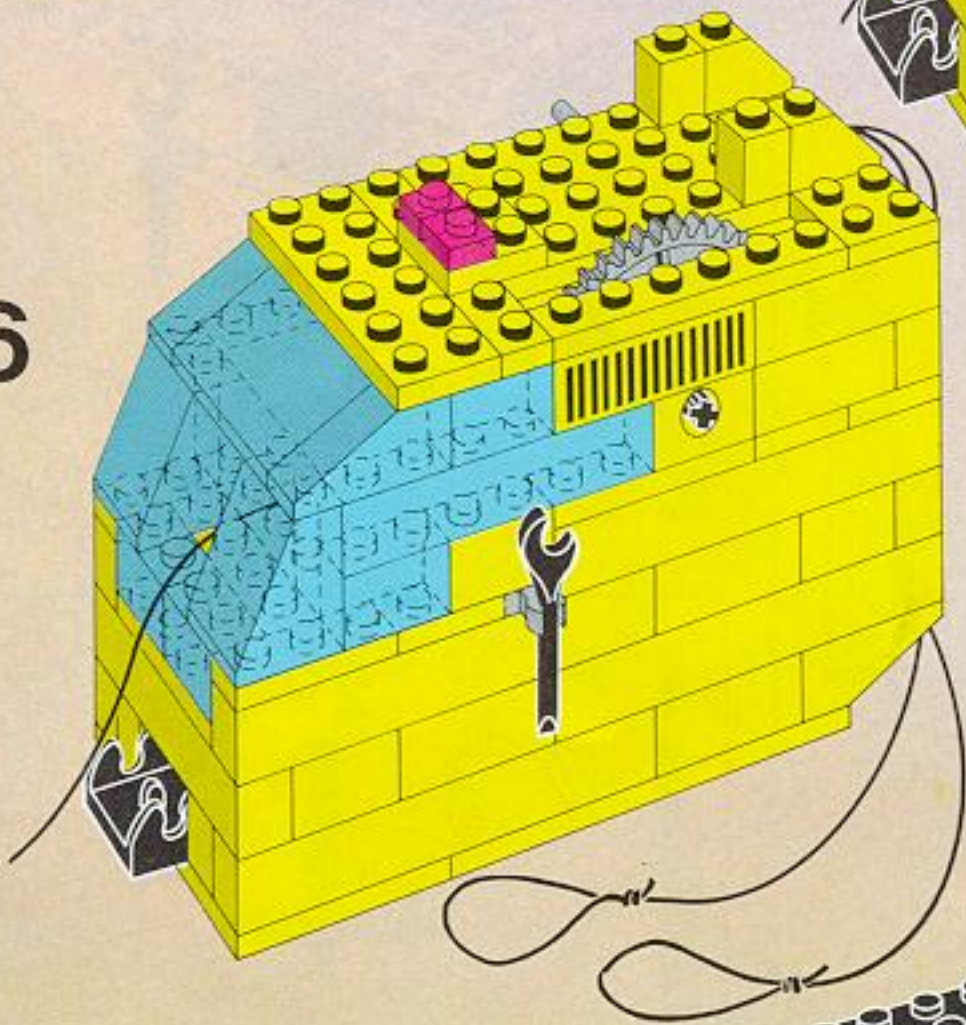

27

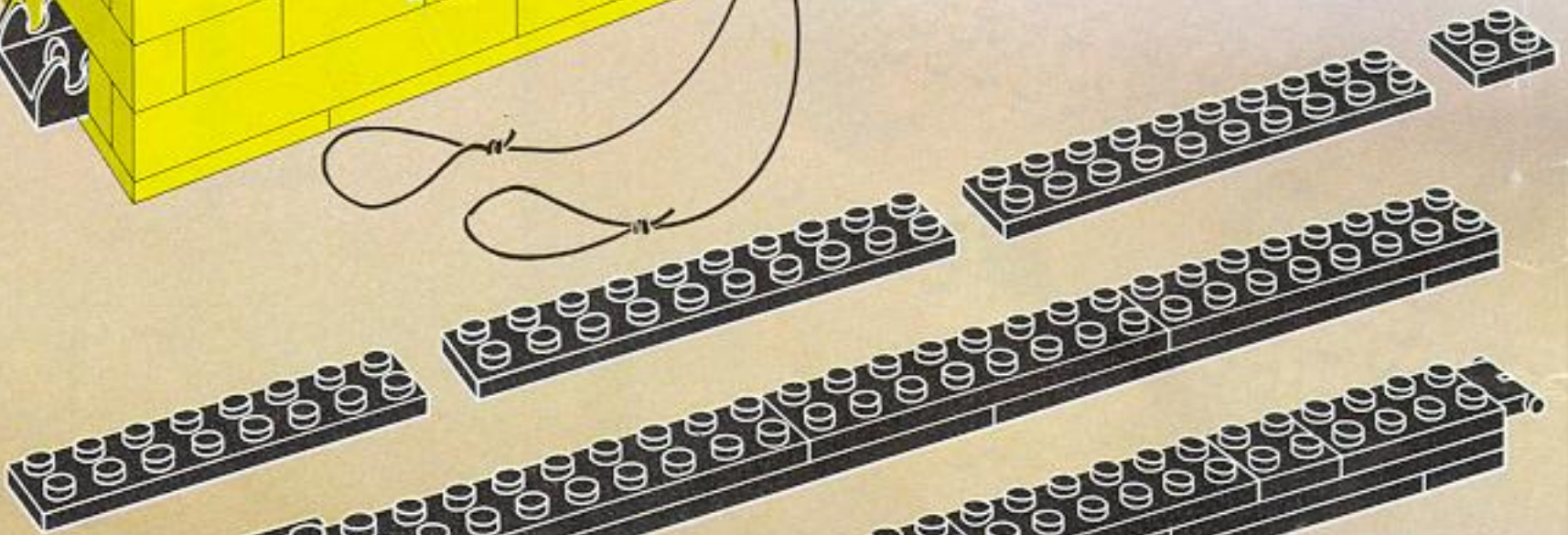

28

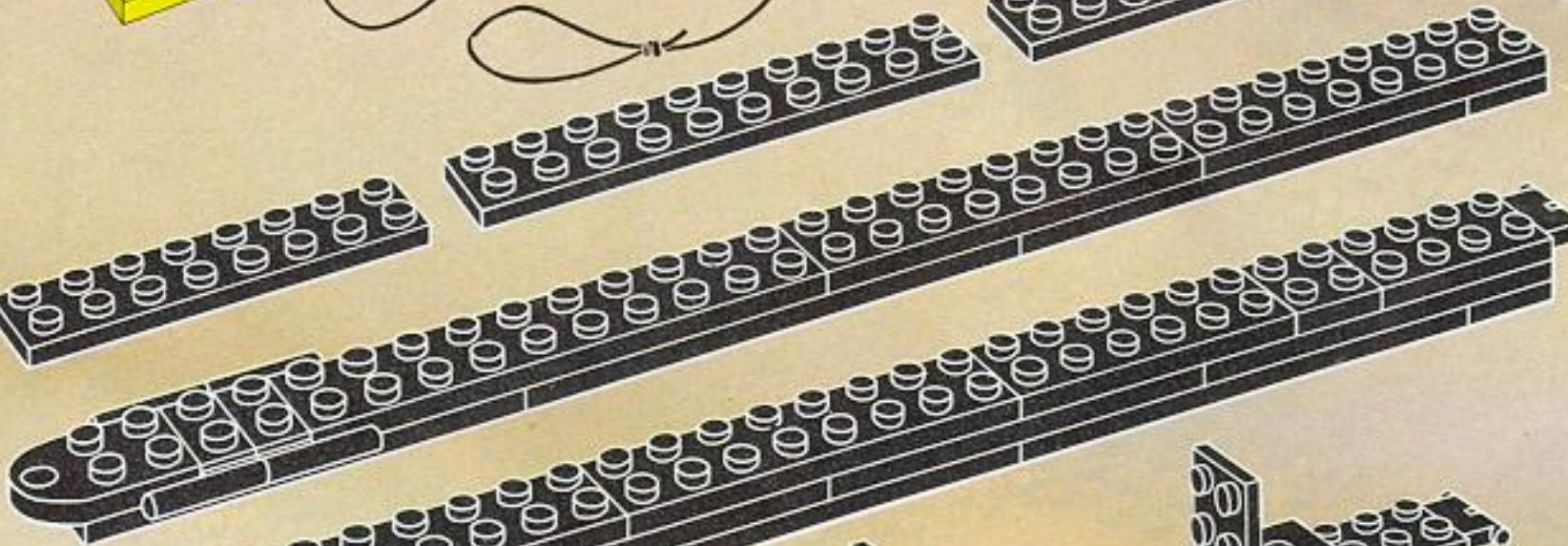

29

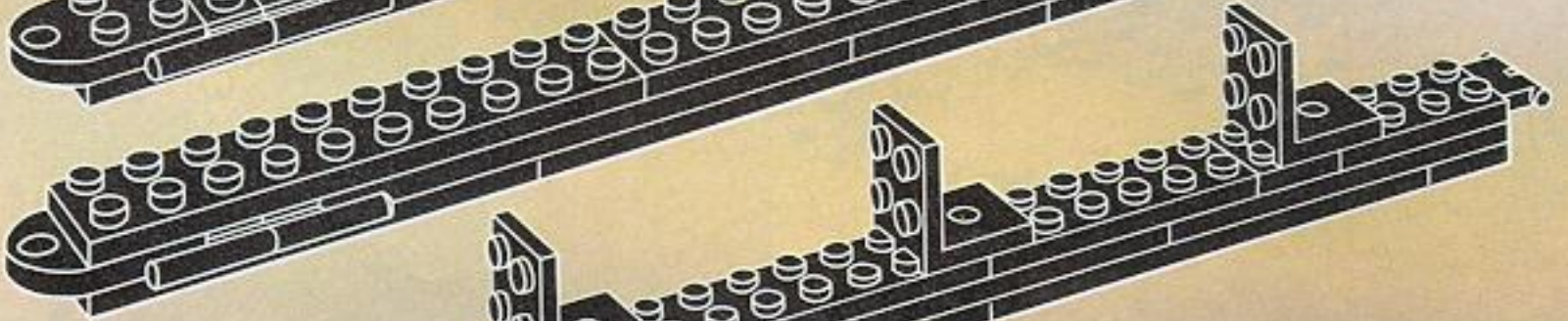

30



31

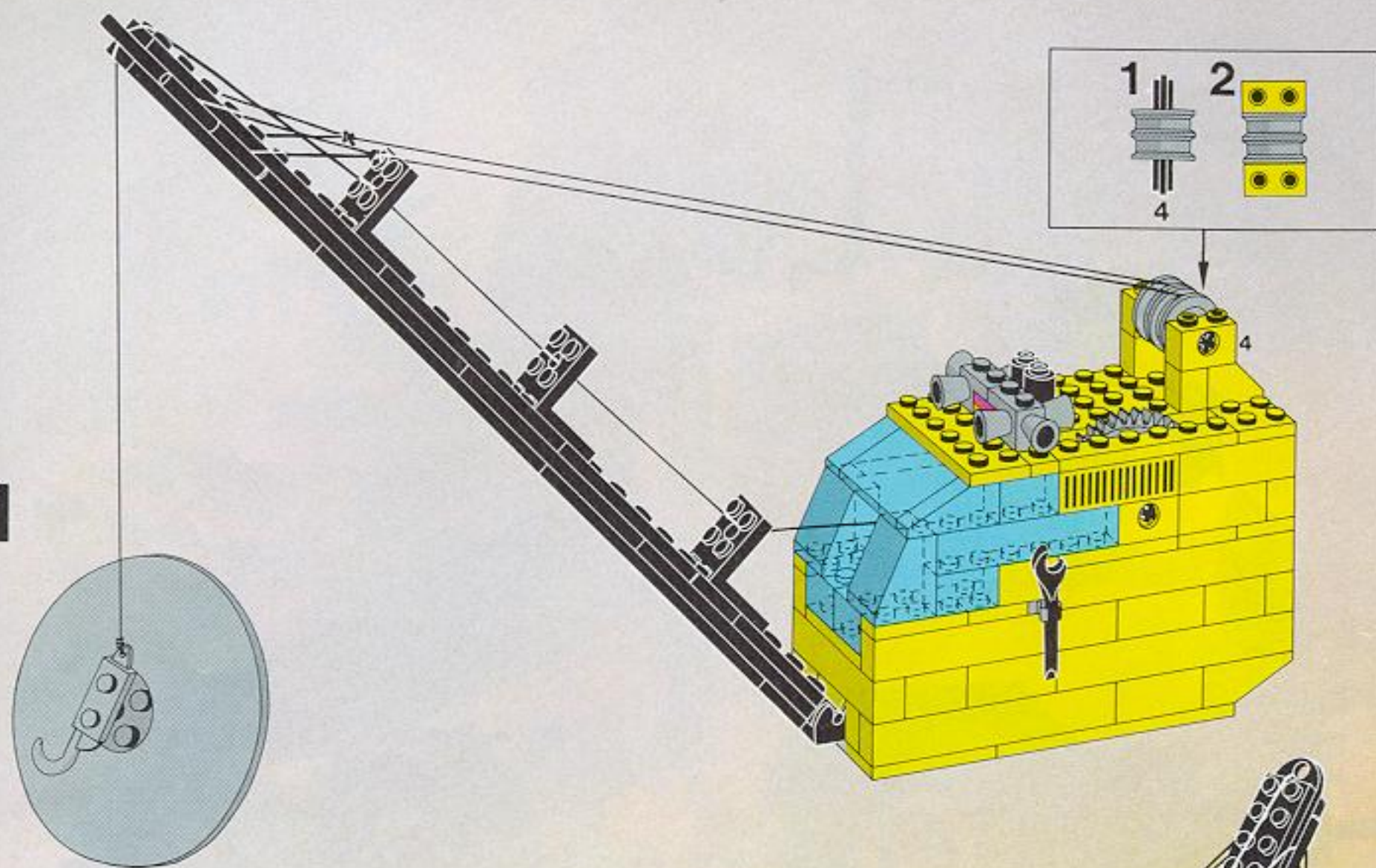

32

