

10027

LEGO

World City ↑

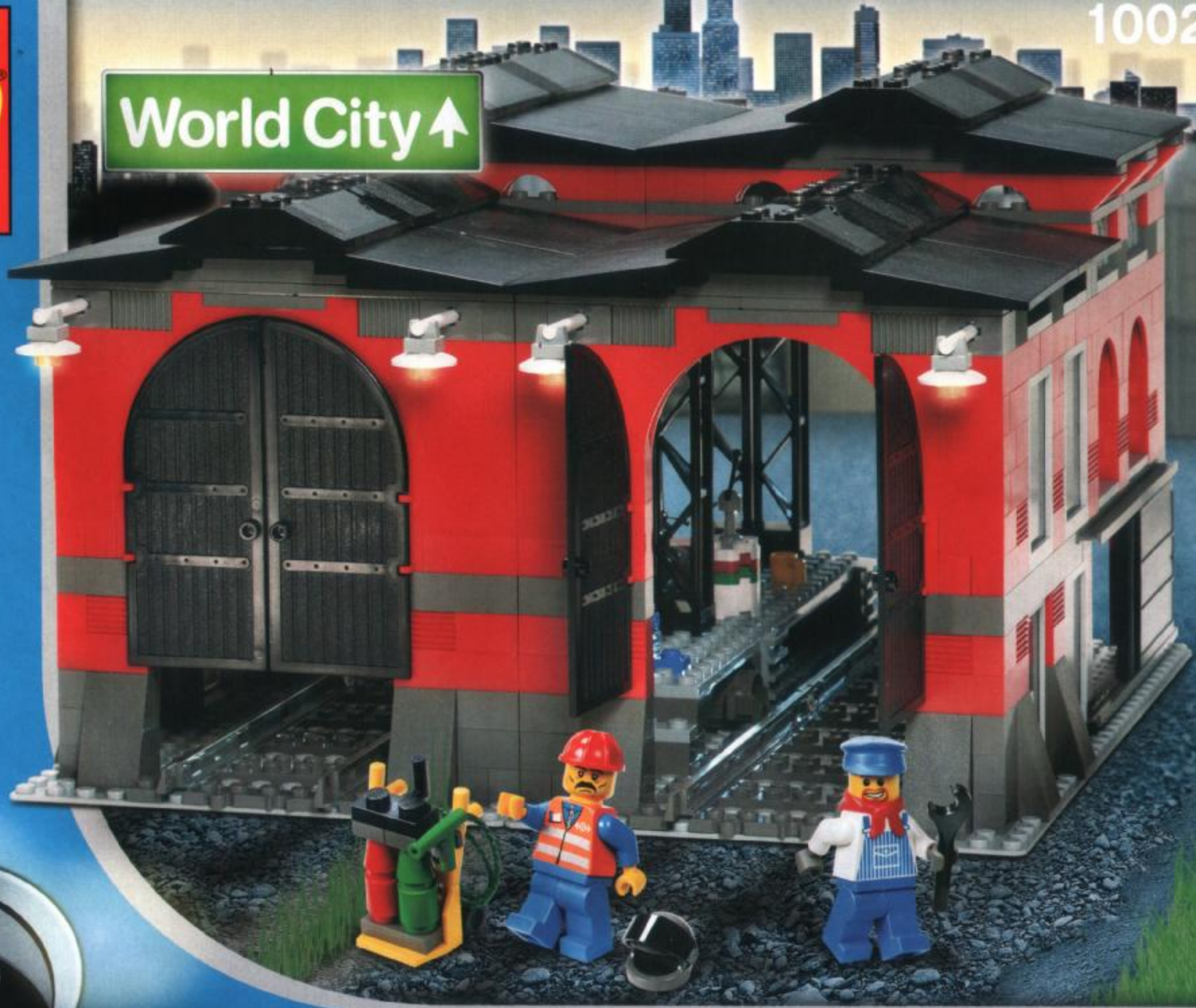

4219300

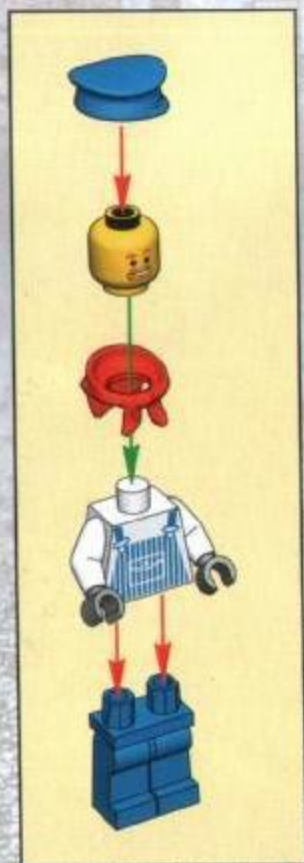

1

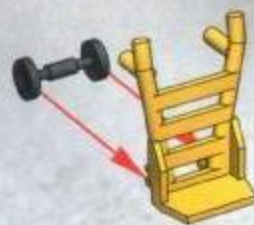

2



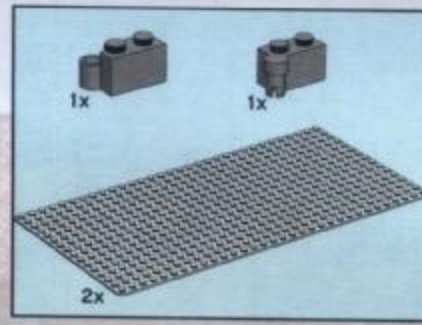

1

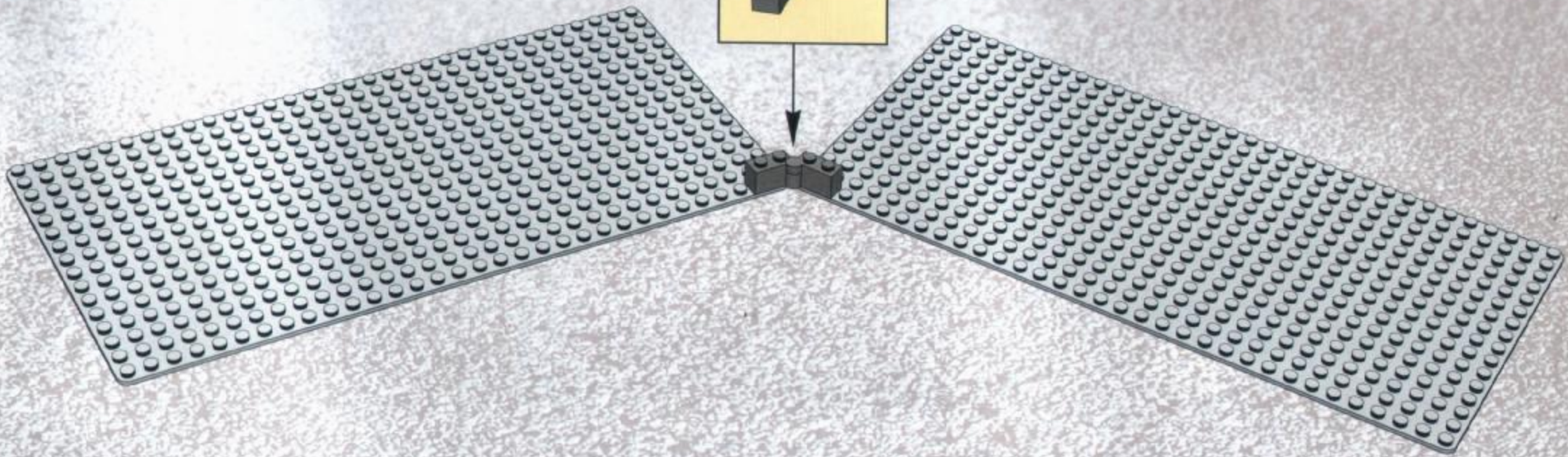
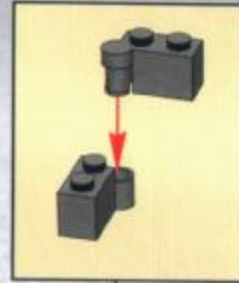



2

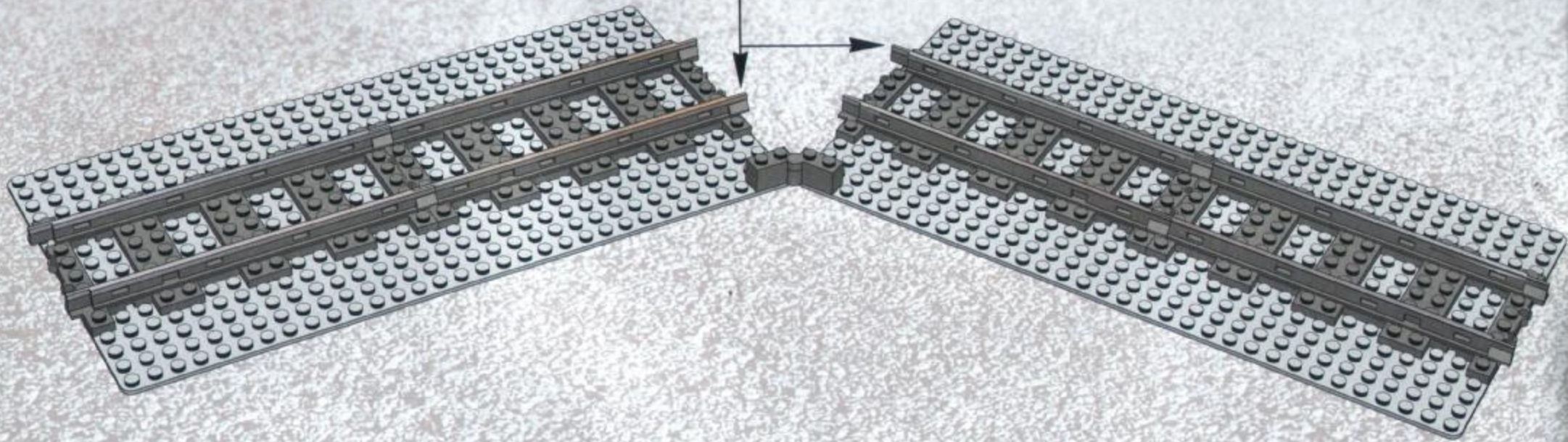
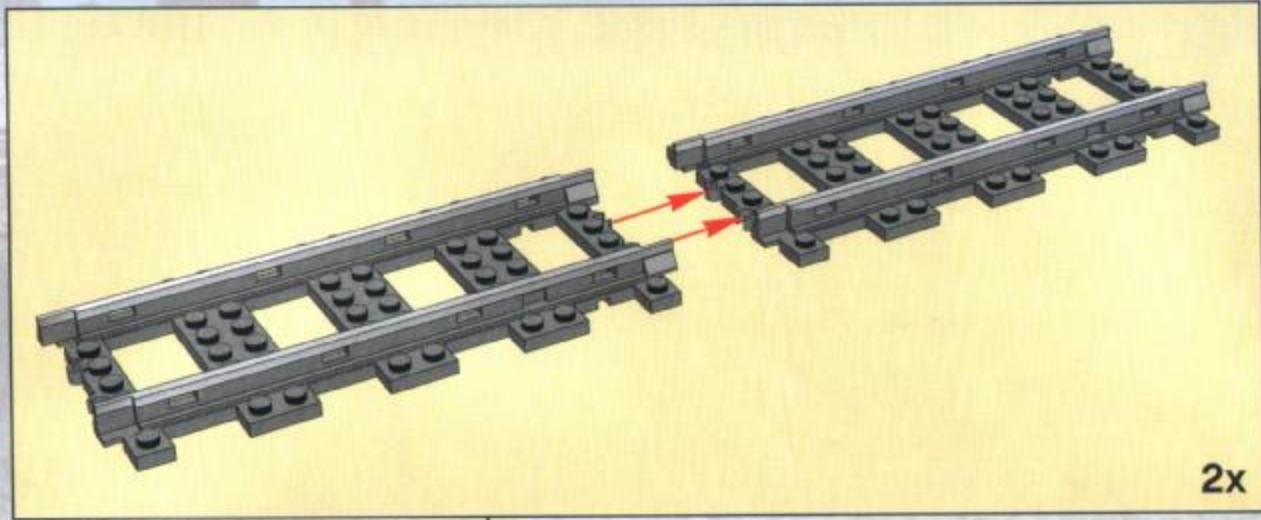

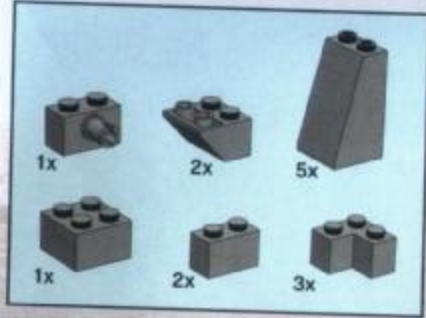

3

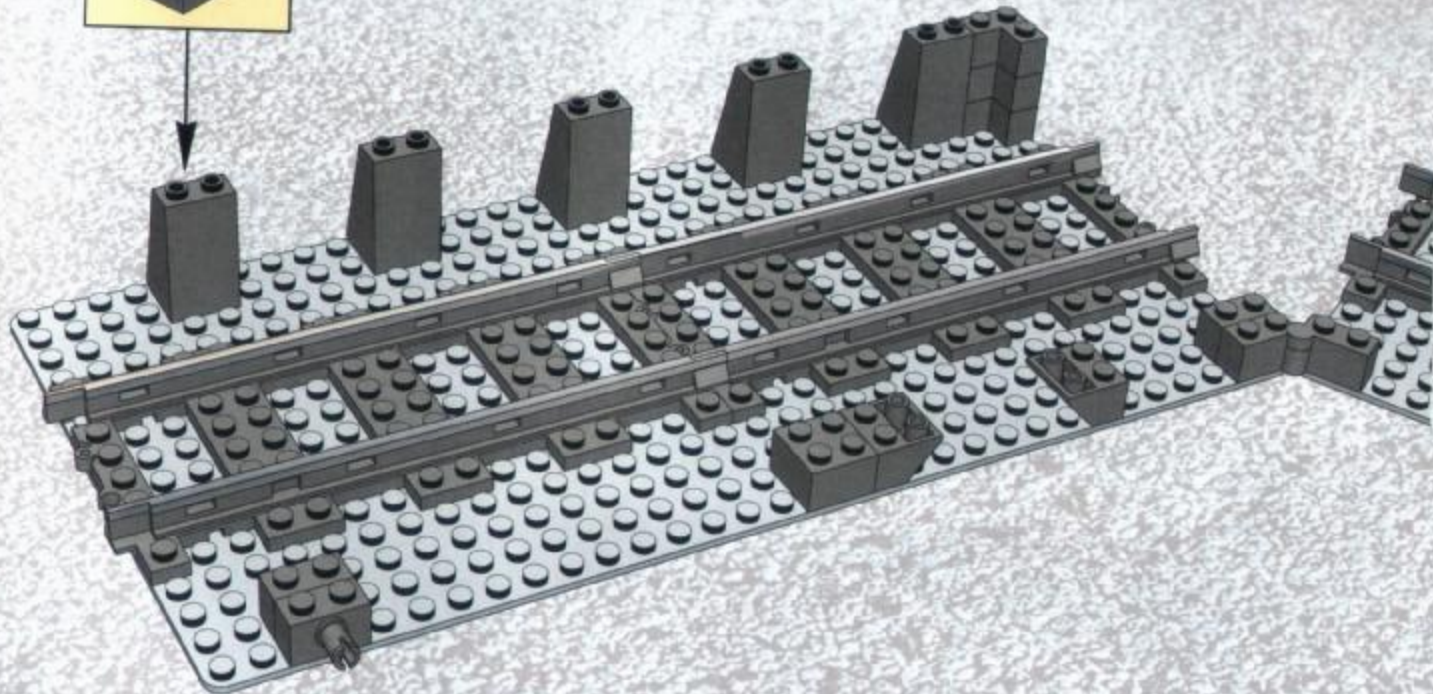
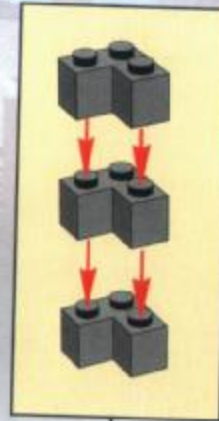

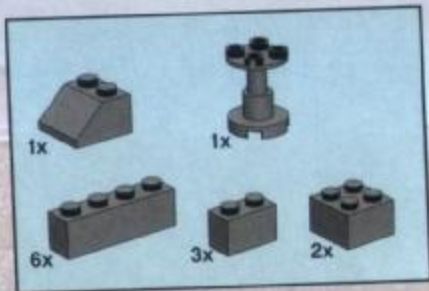

4

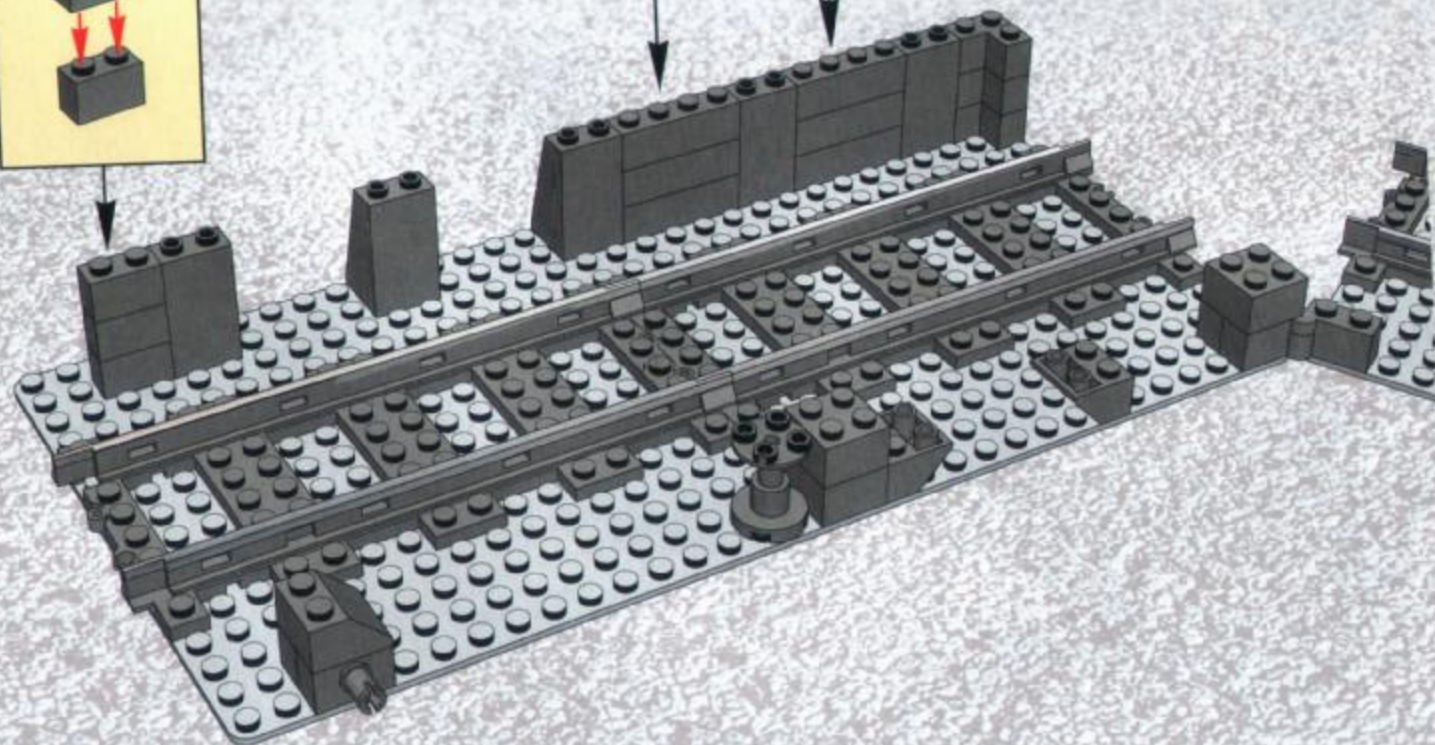
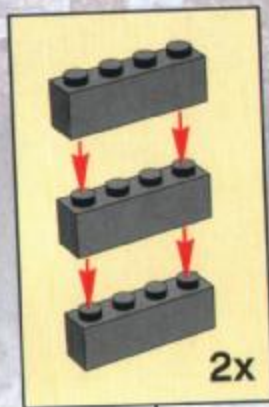
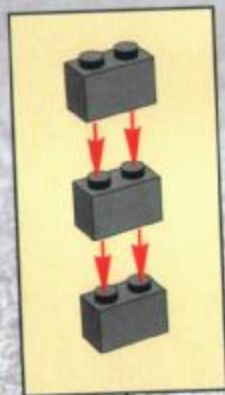

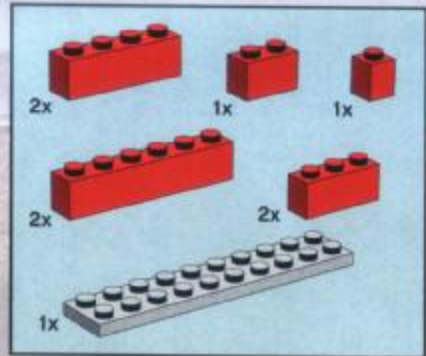

6

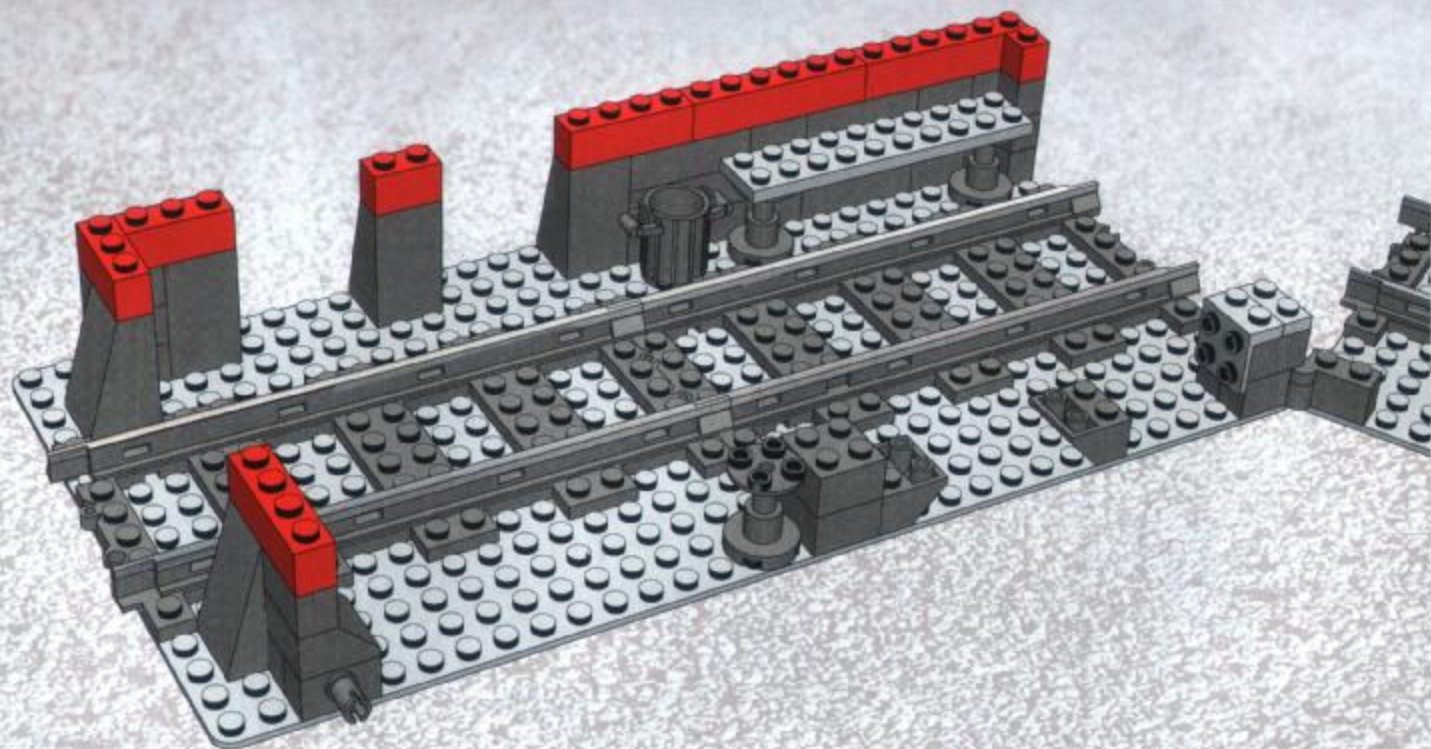

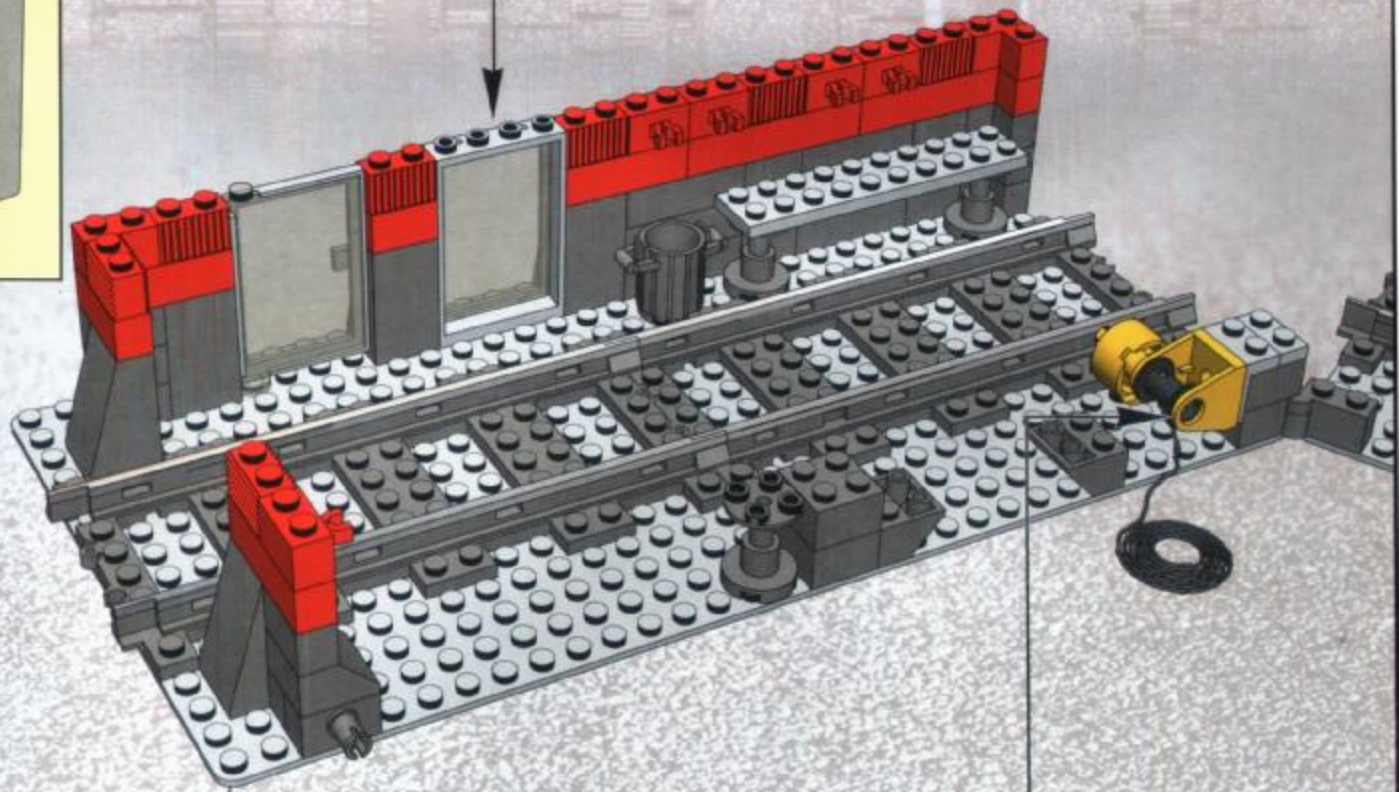
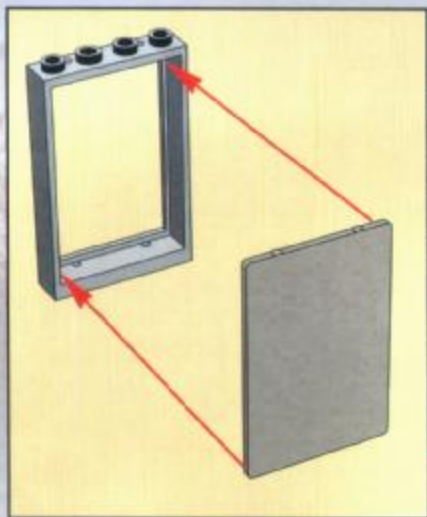
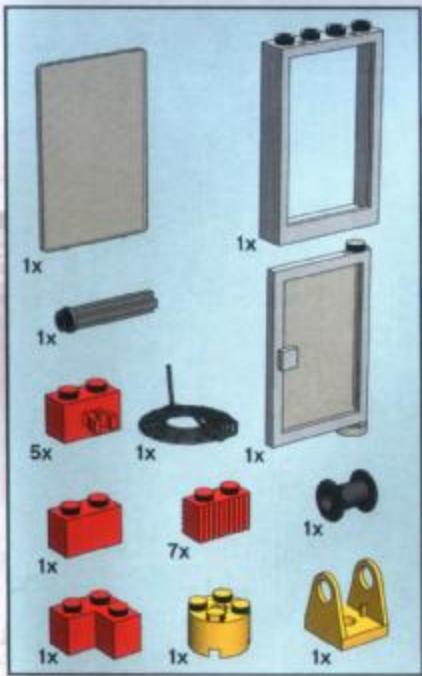

7

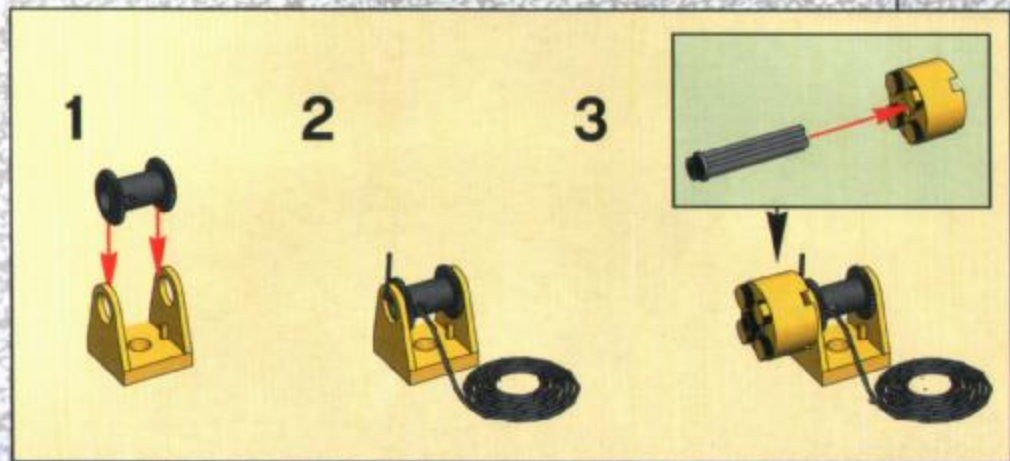

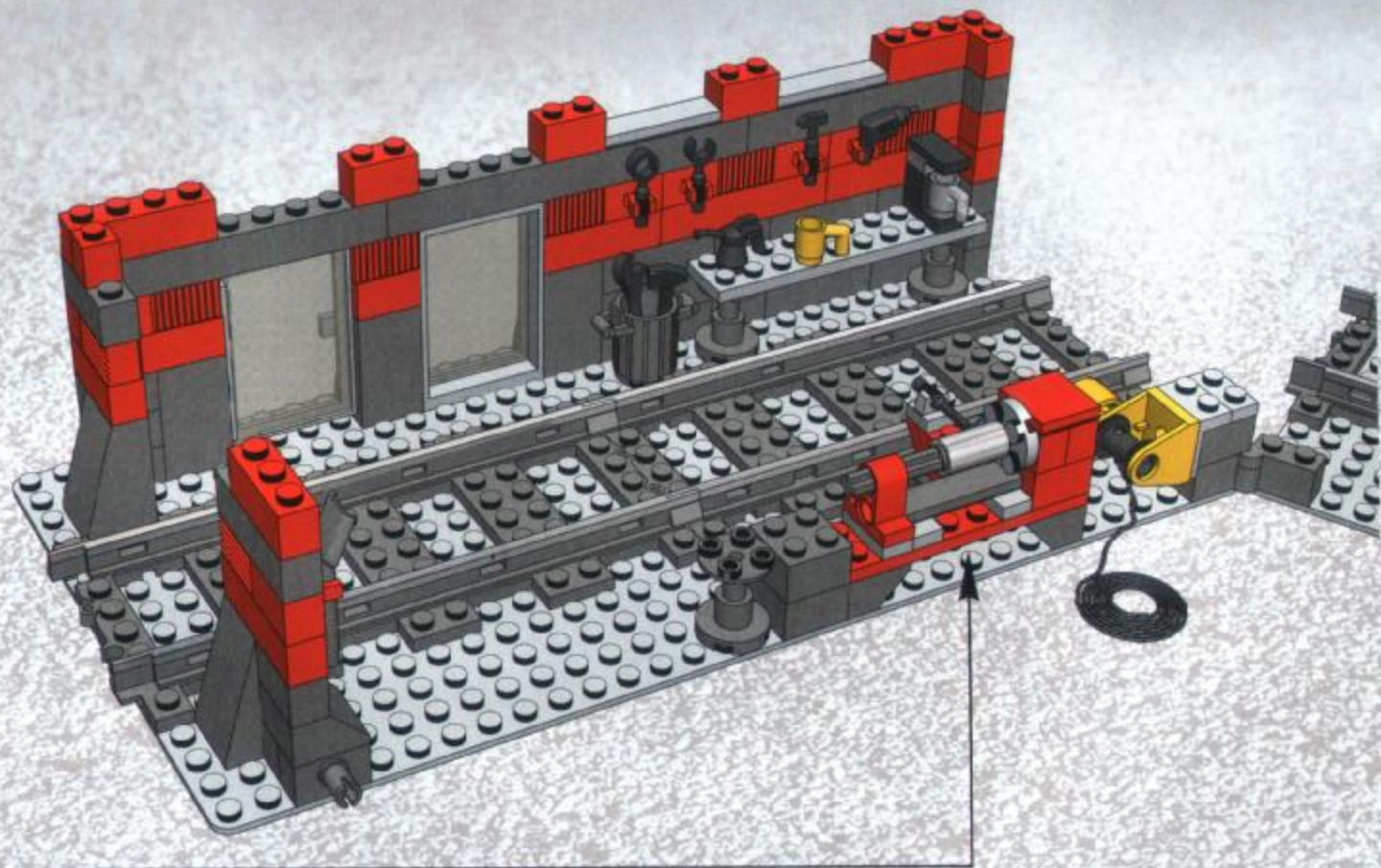

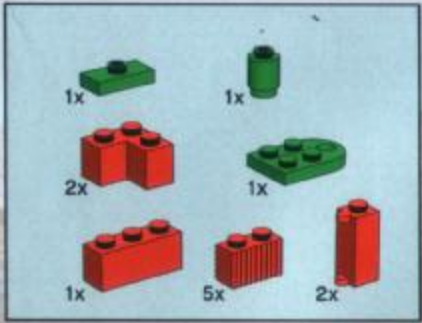

10

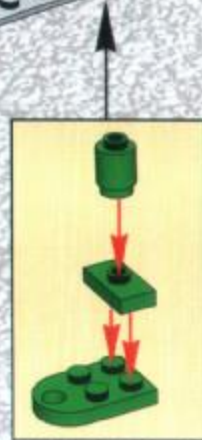
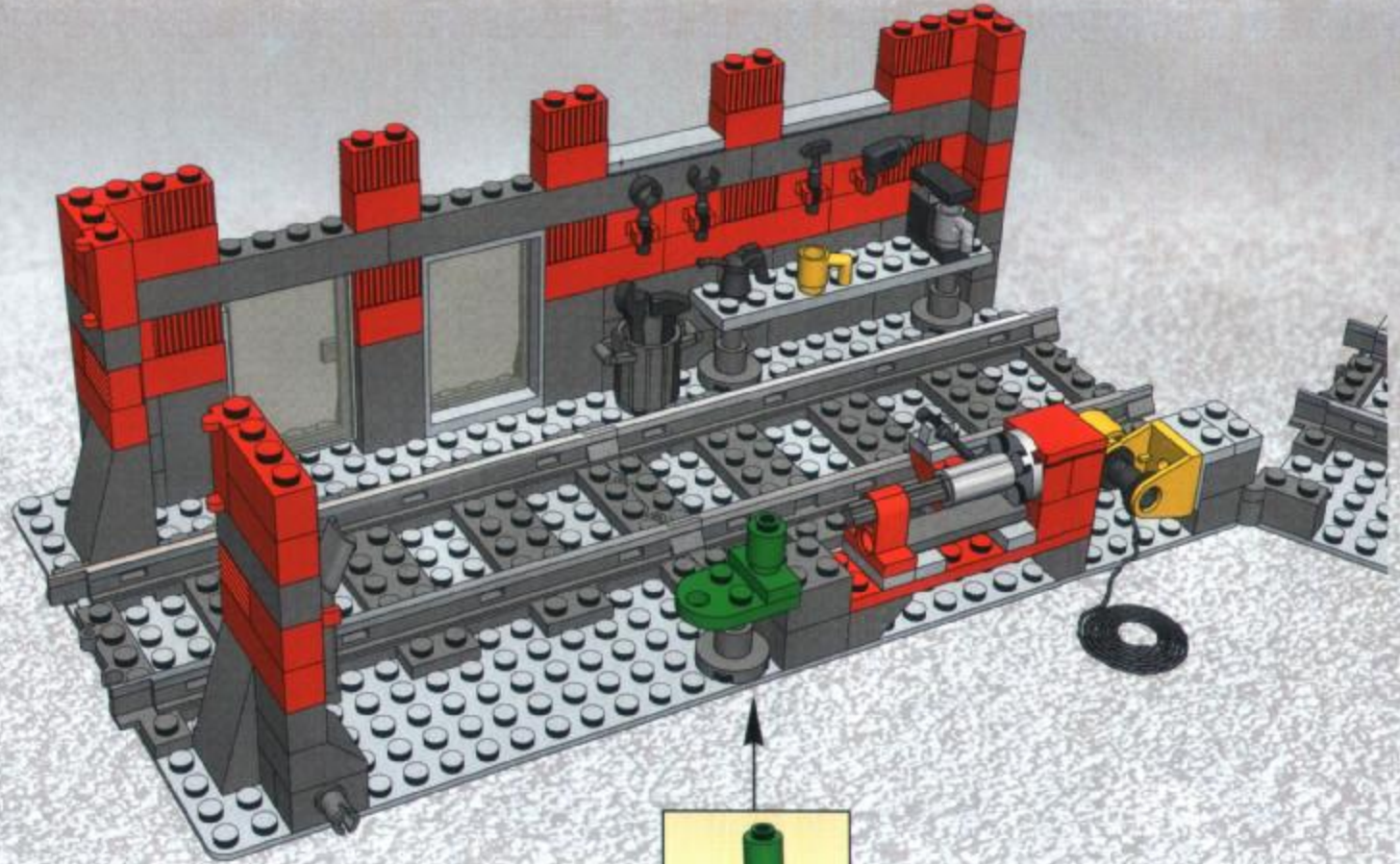

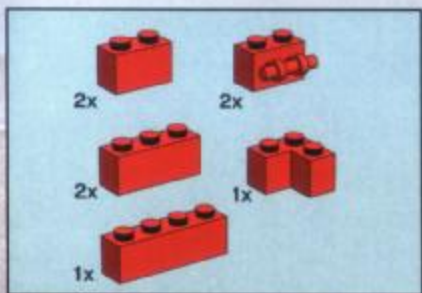

11

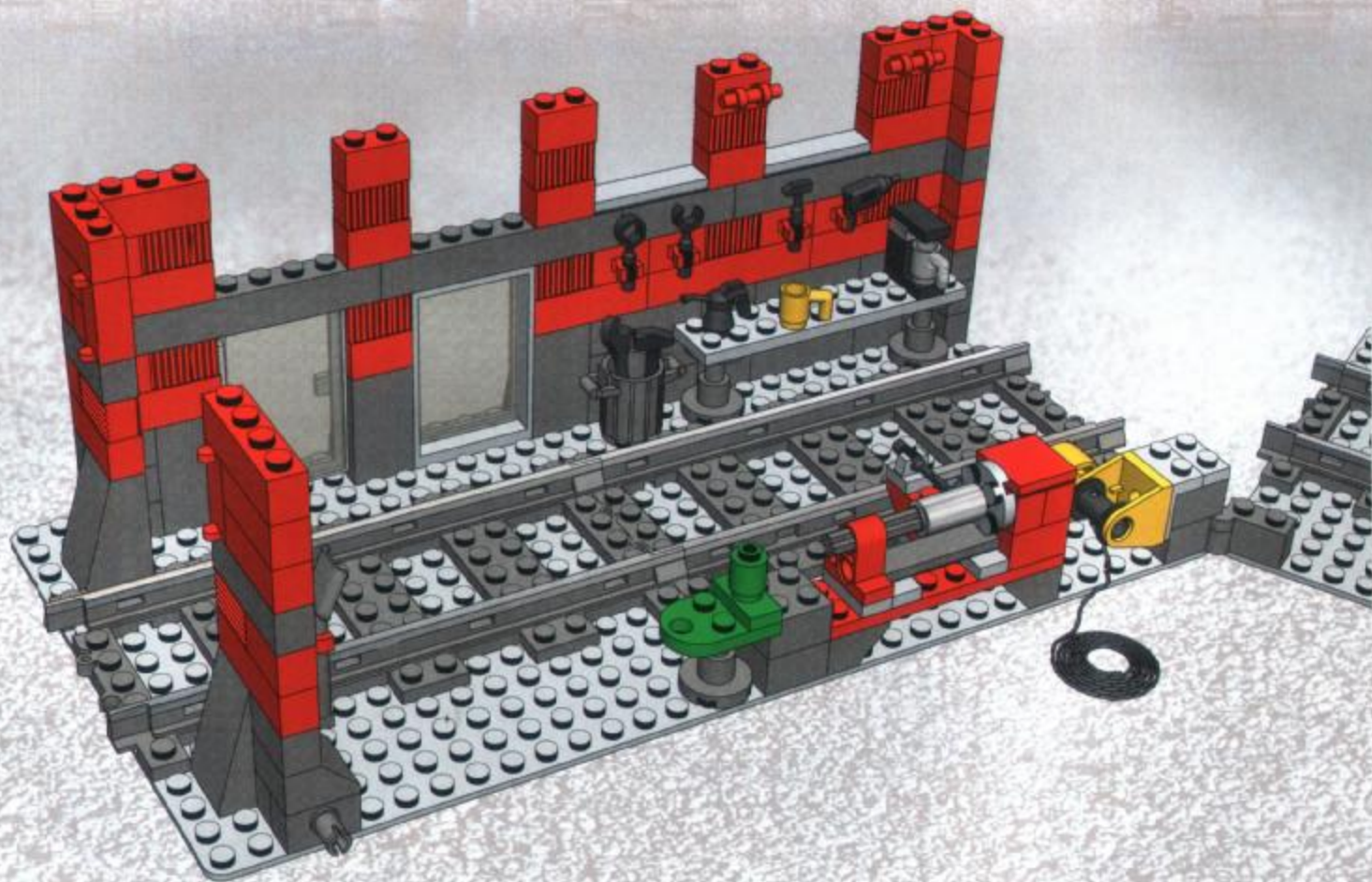

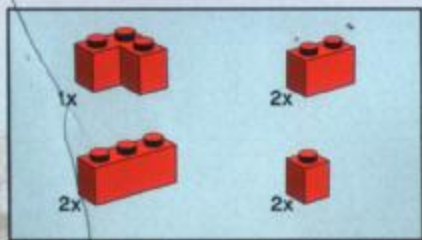

12

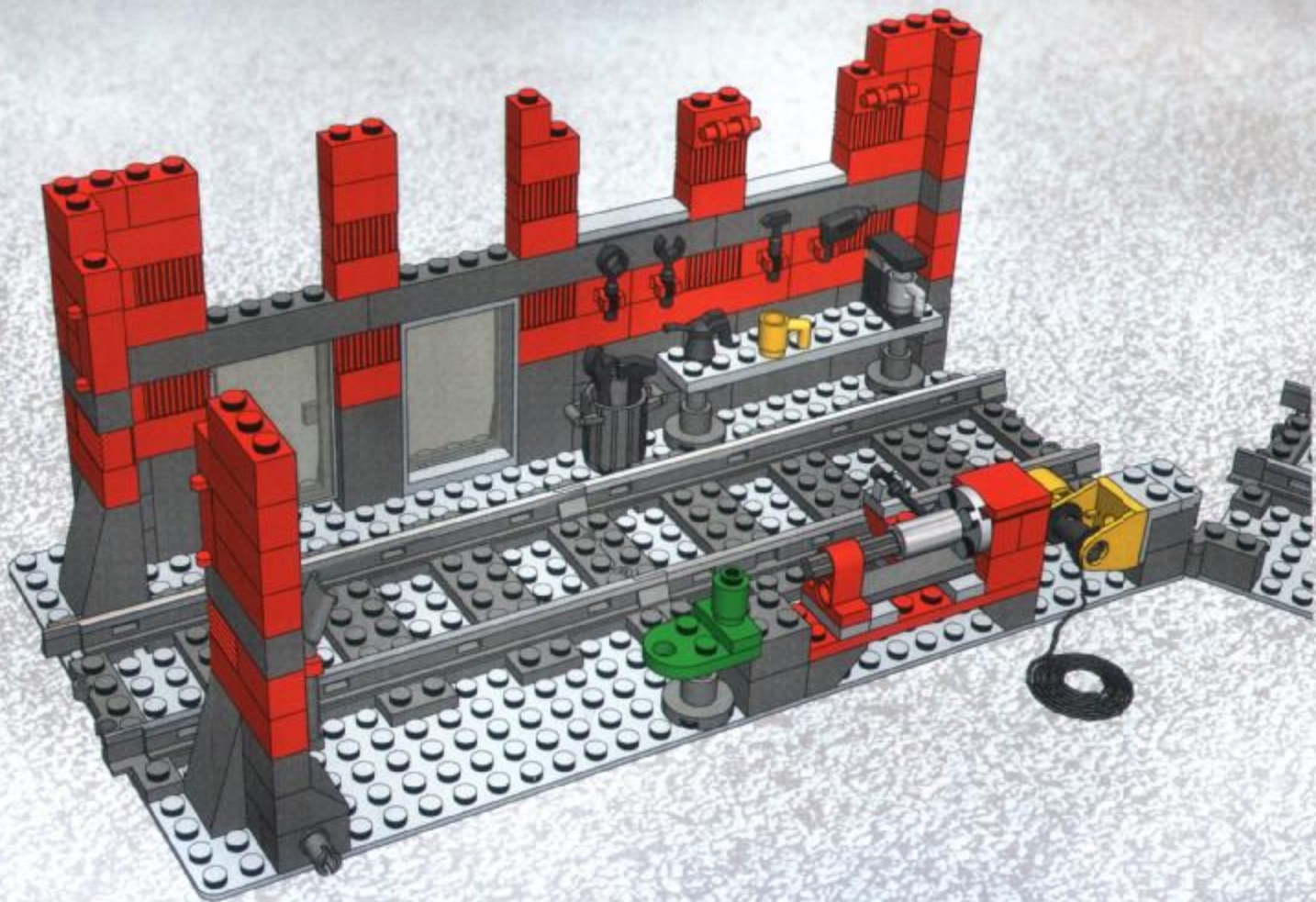

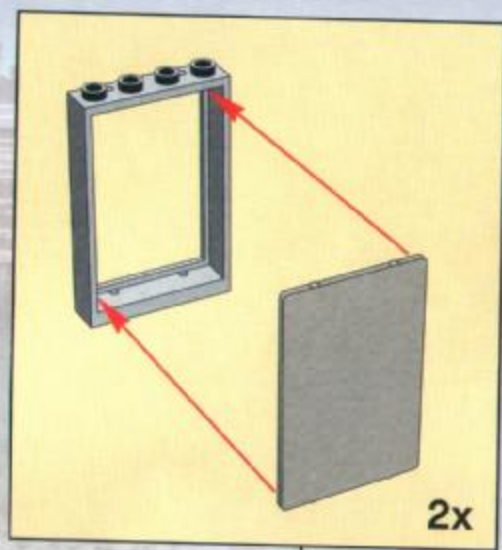
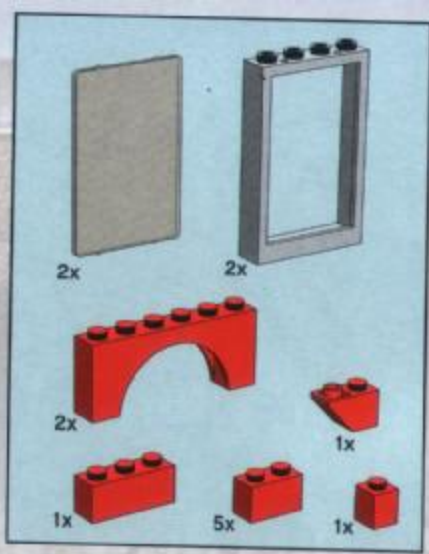

13

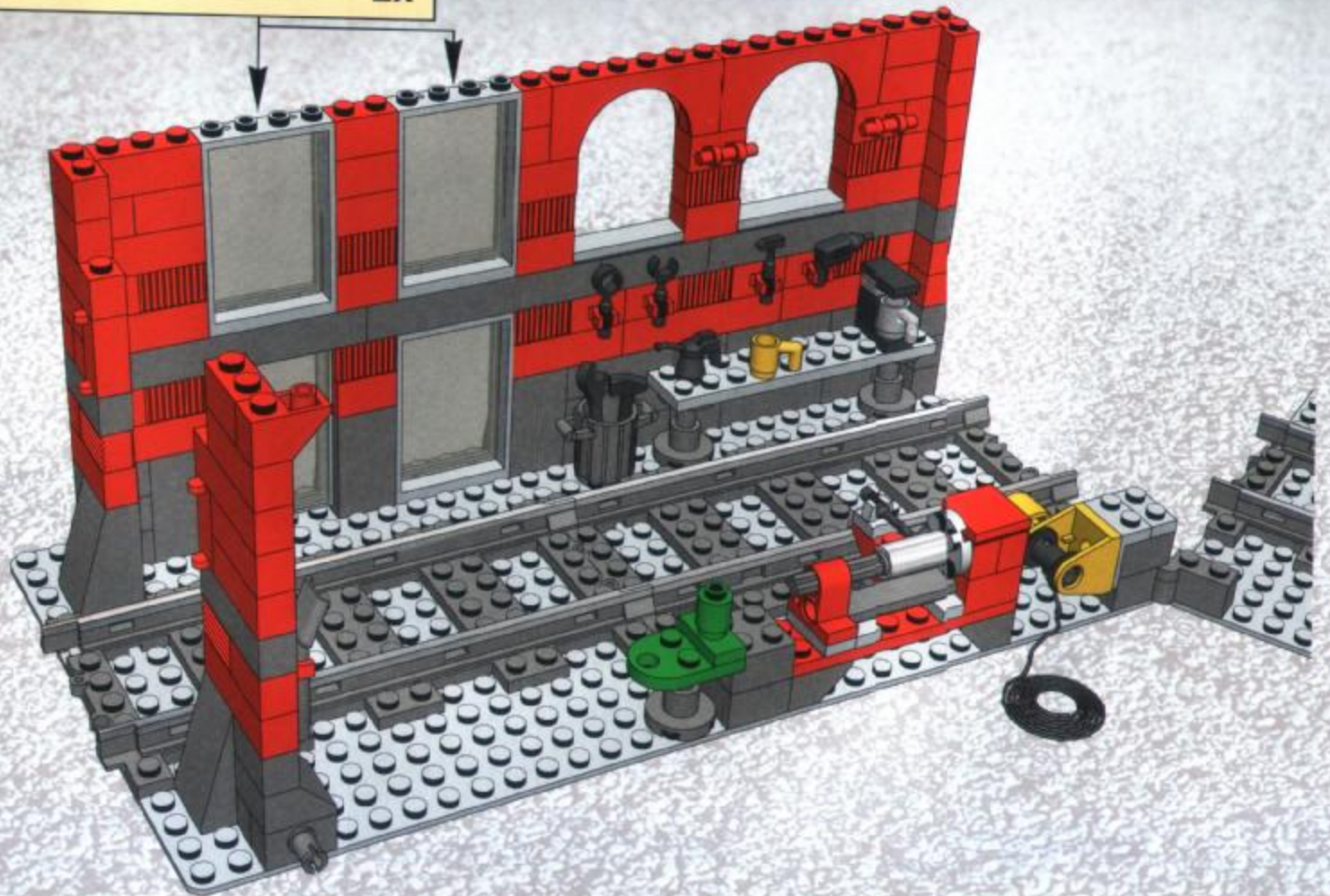

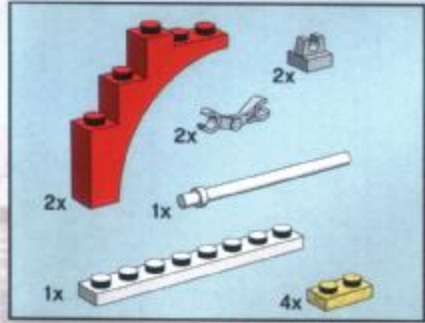

14

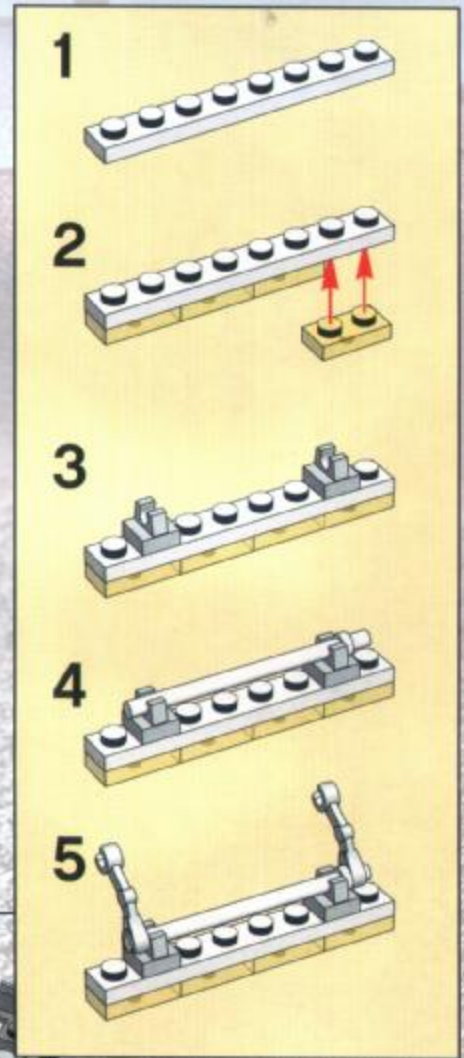
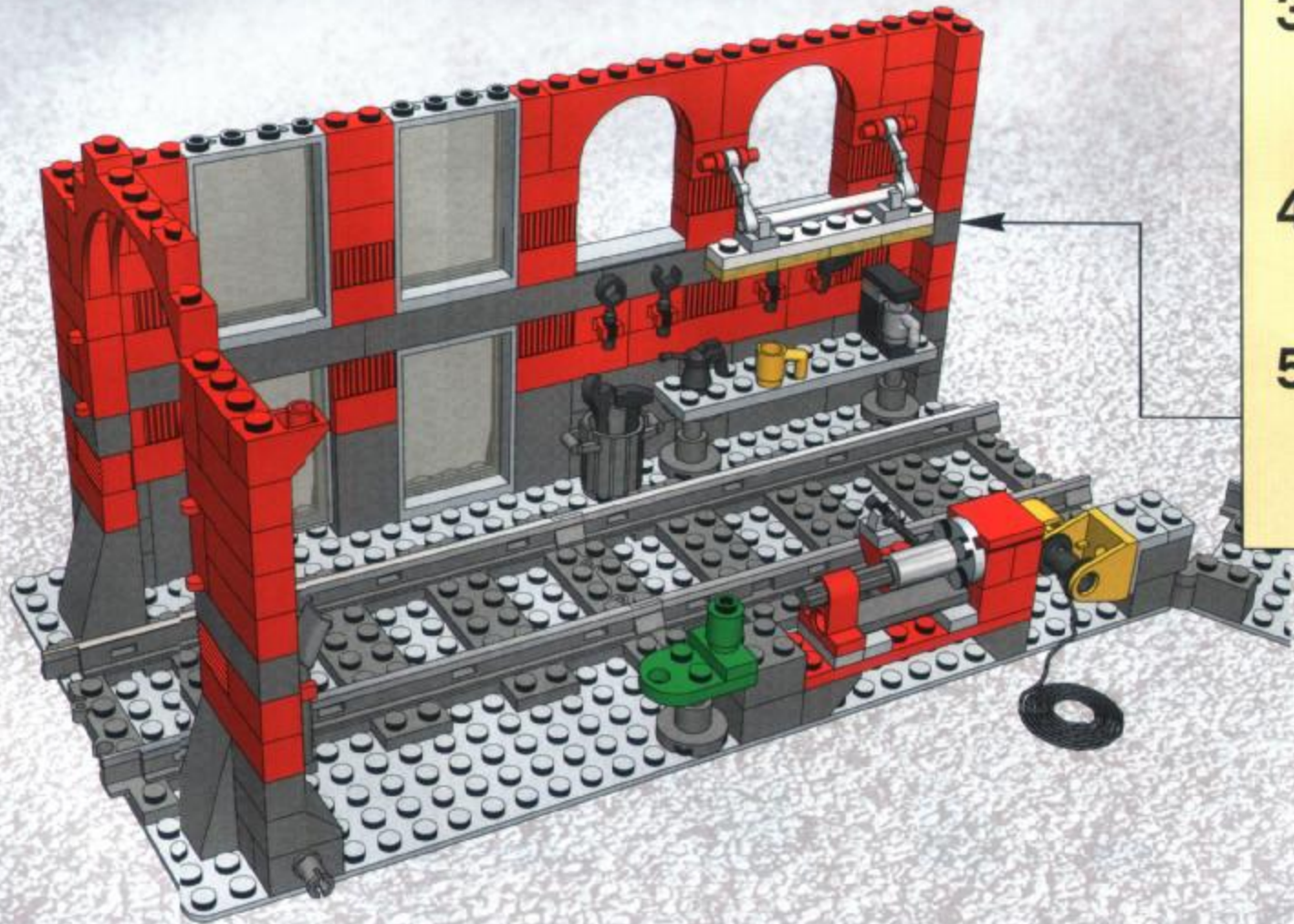

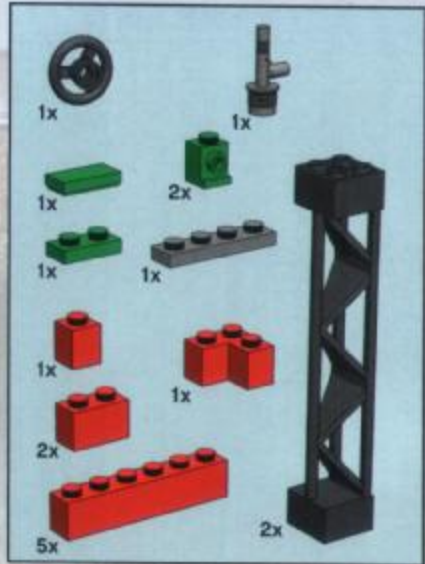

15

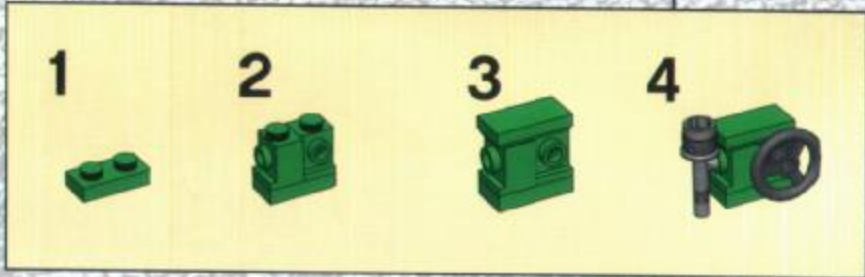
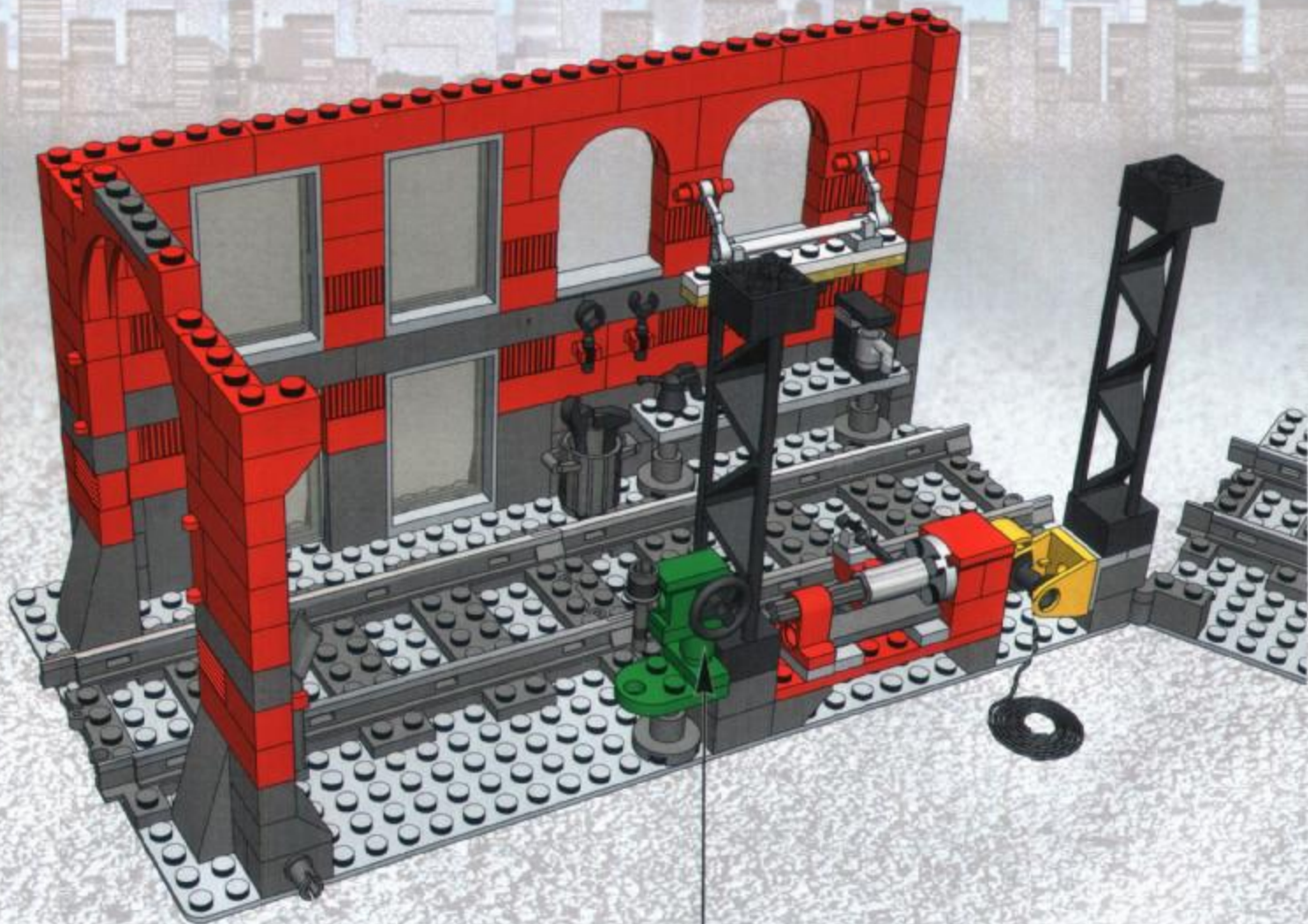

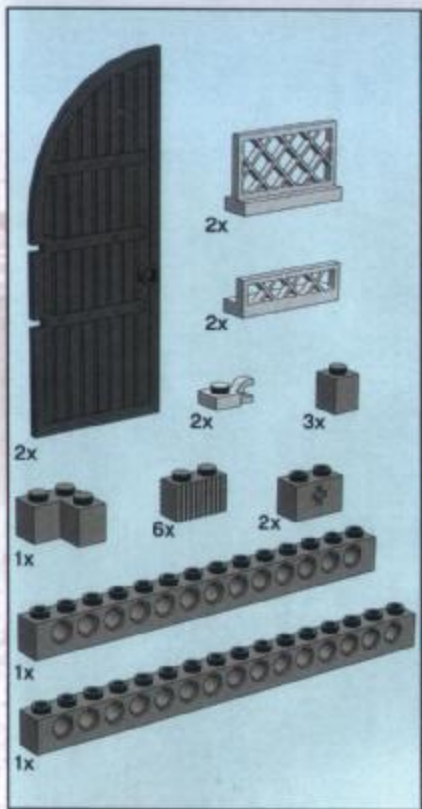

16

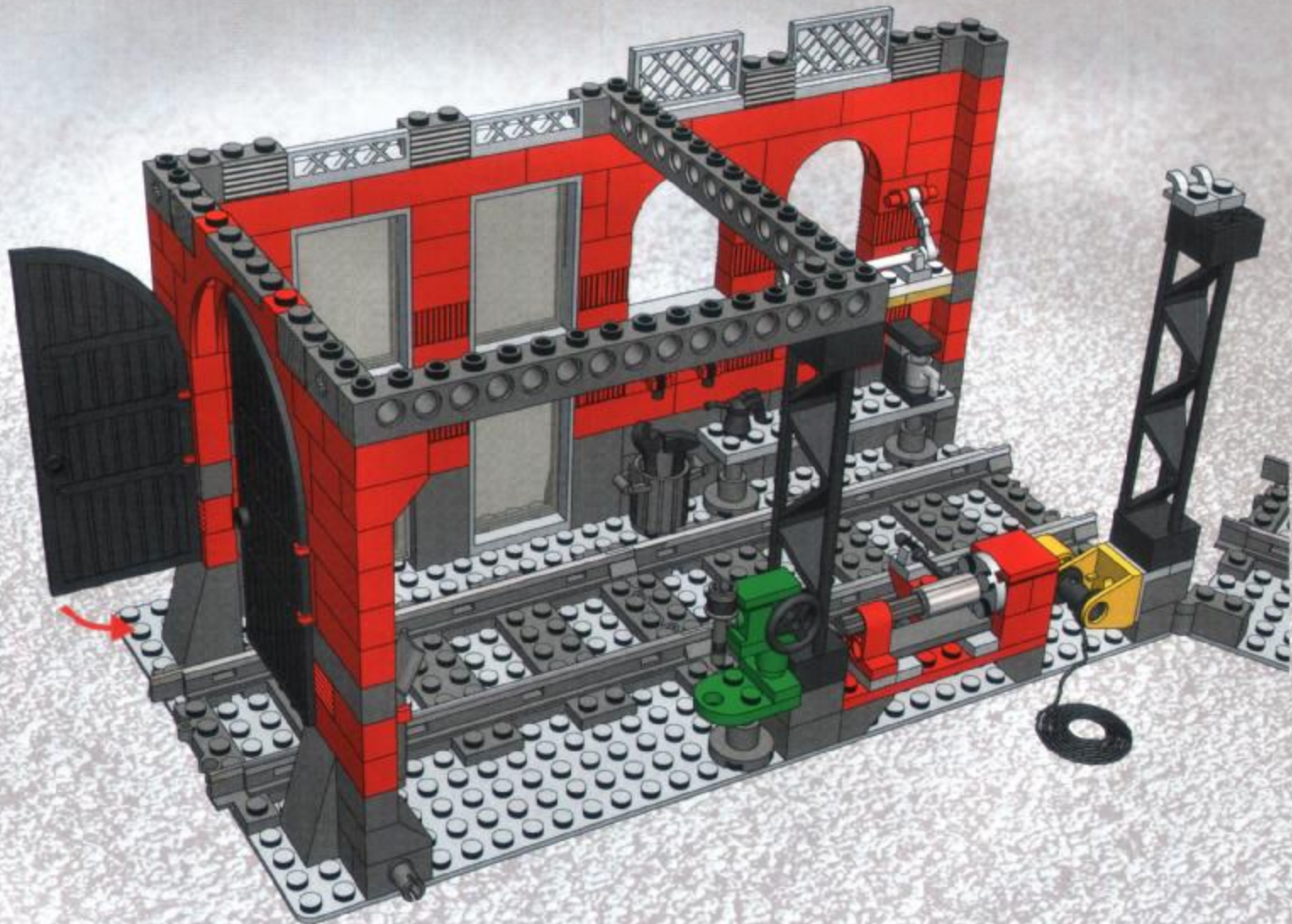

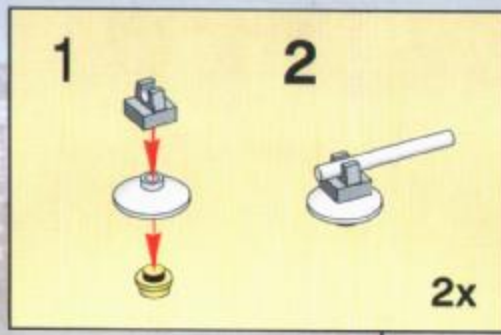
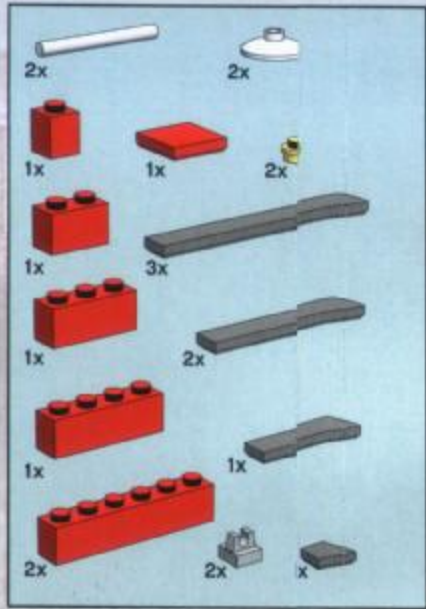

17

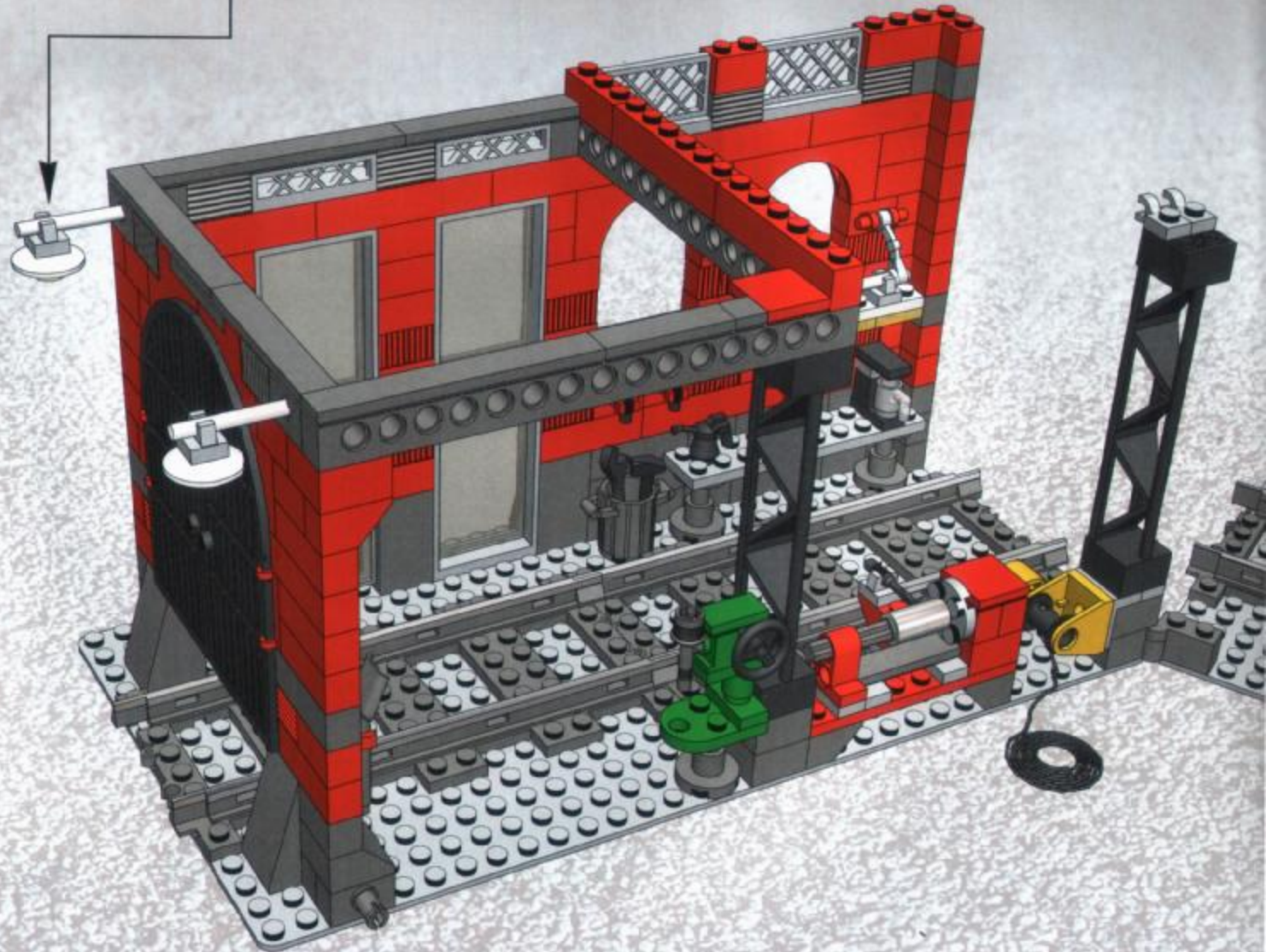

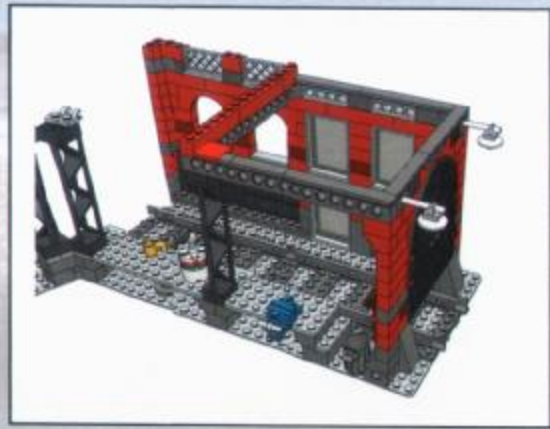
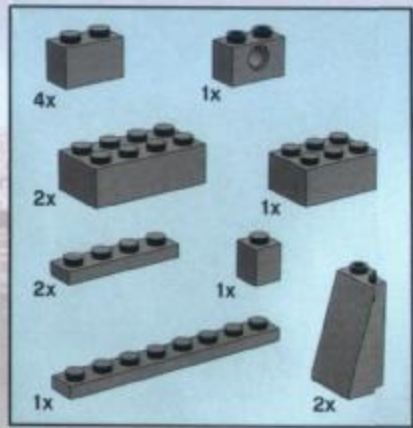

18

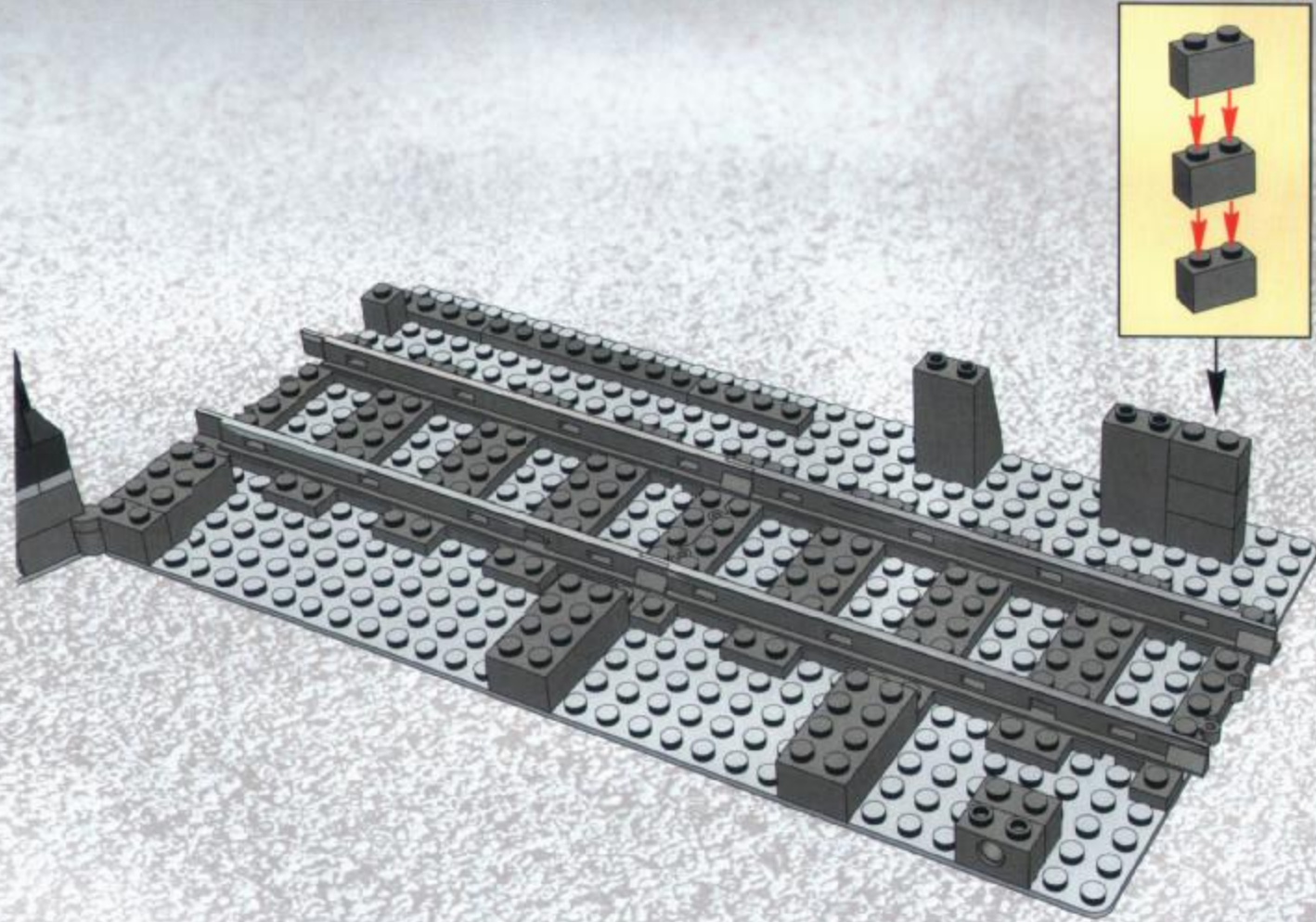

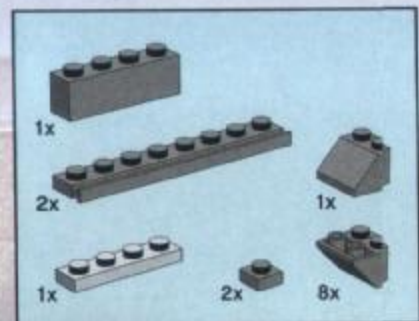

19

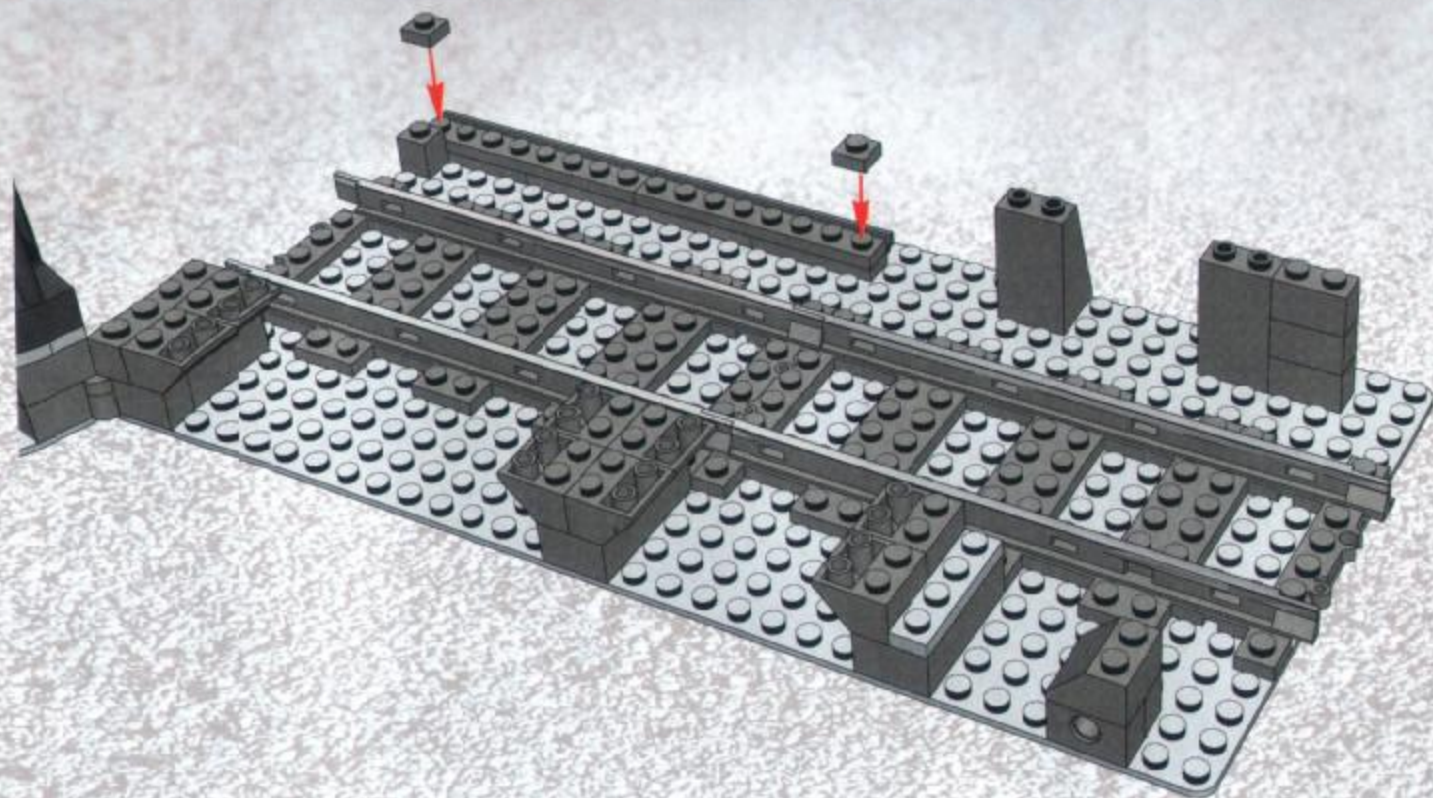

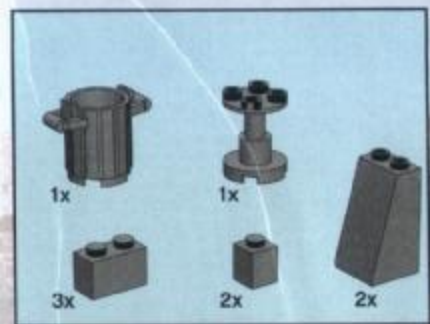

20

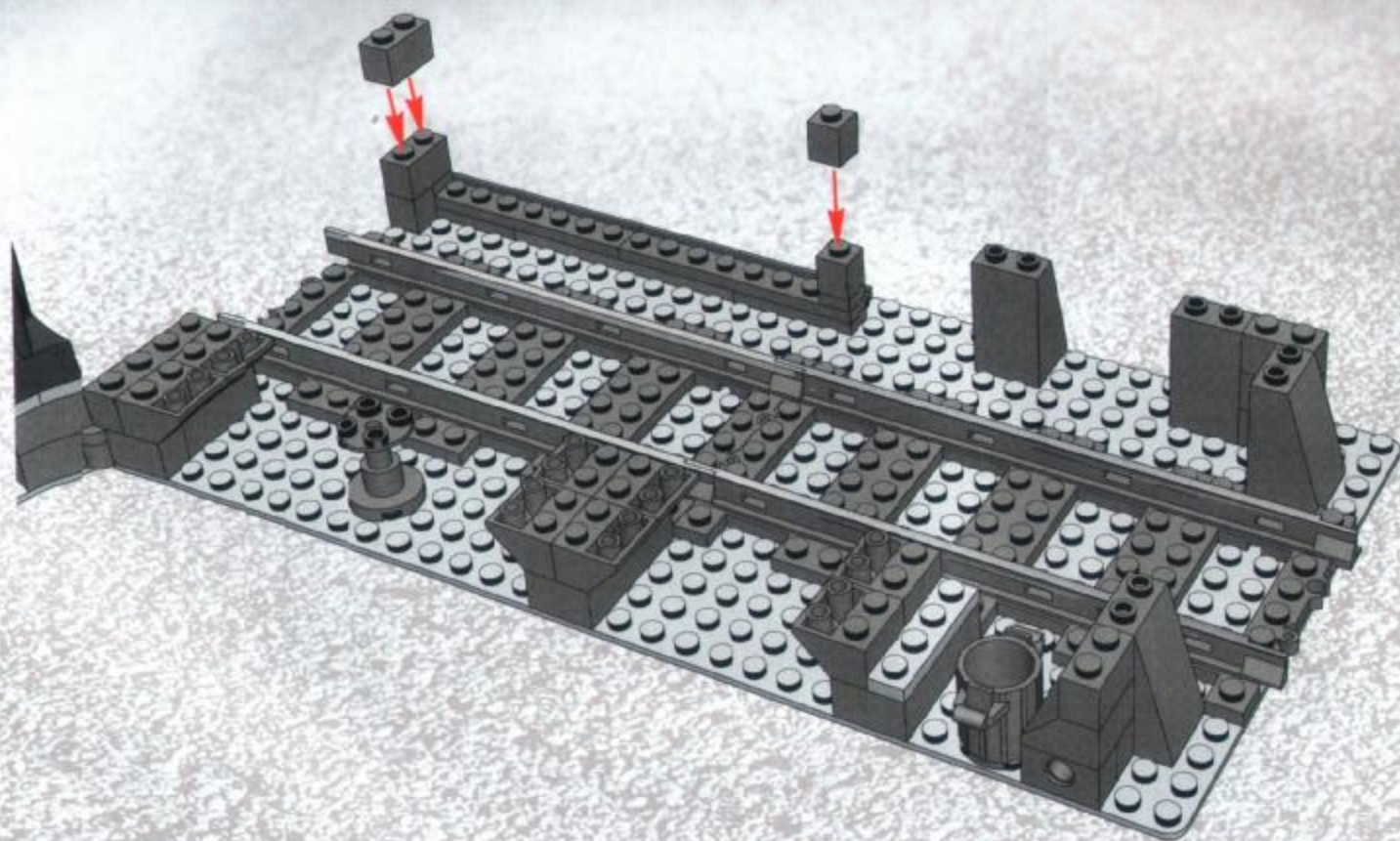

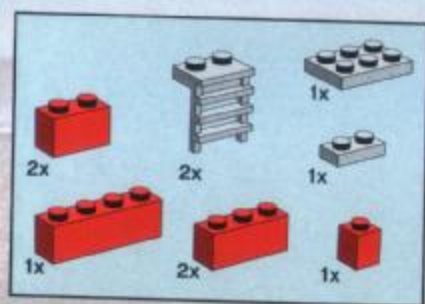

21

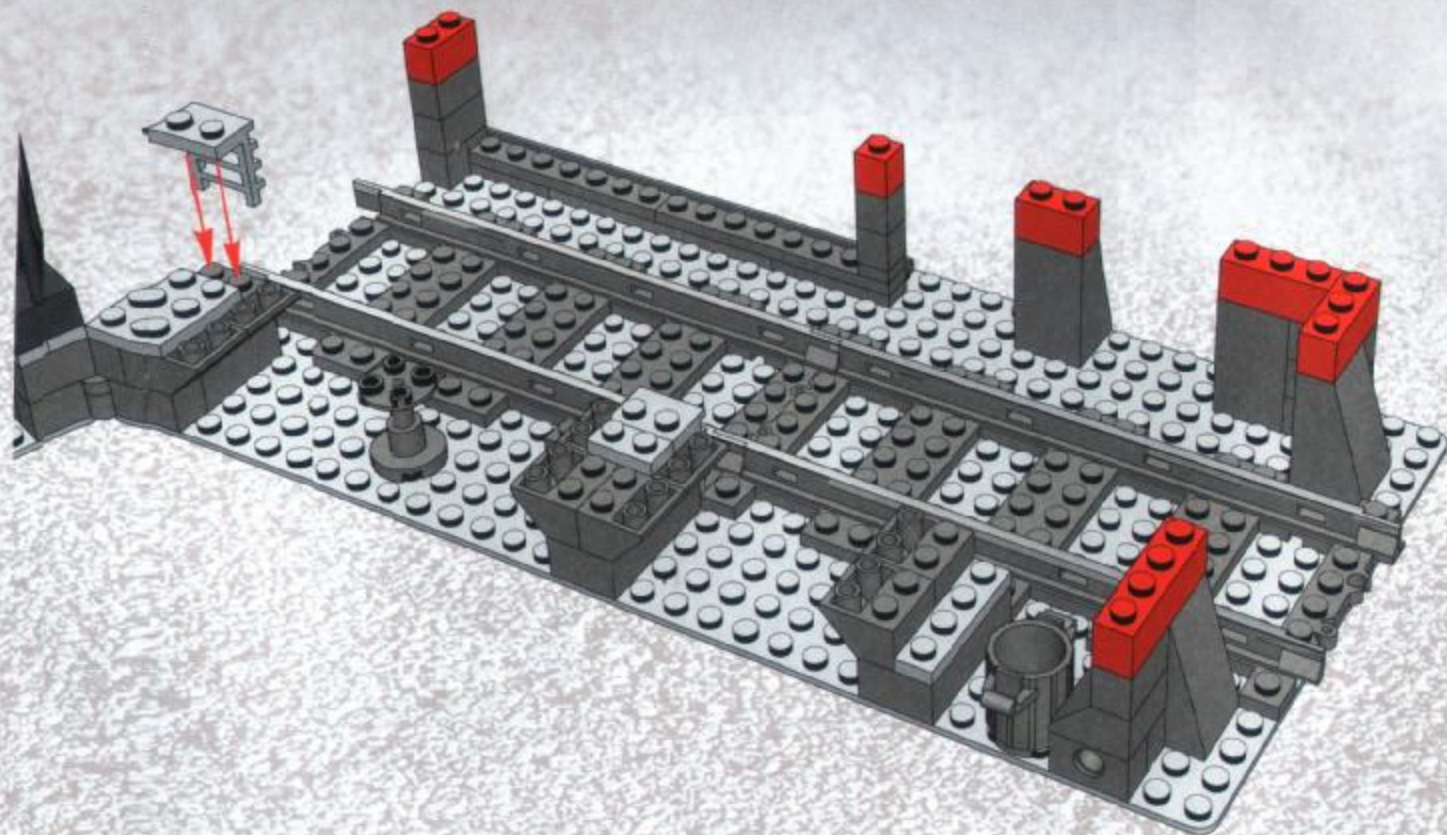

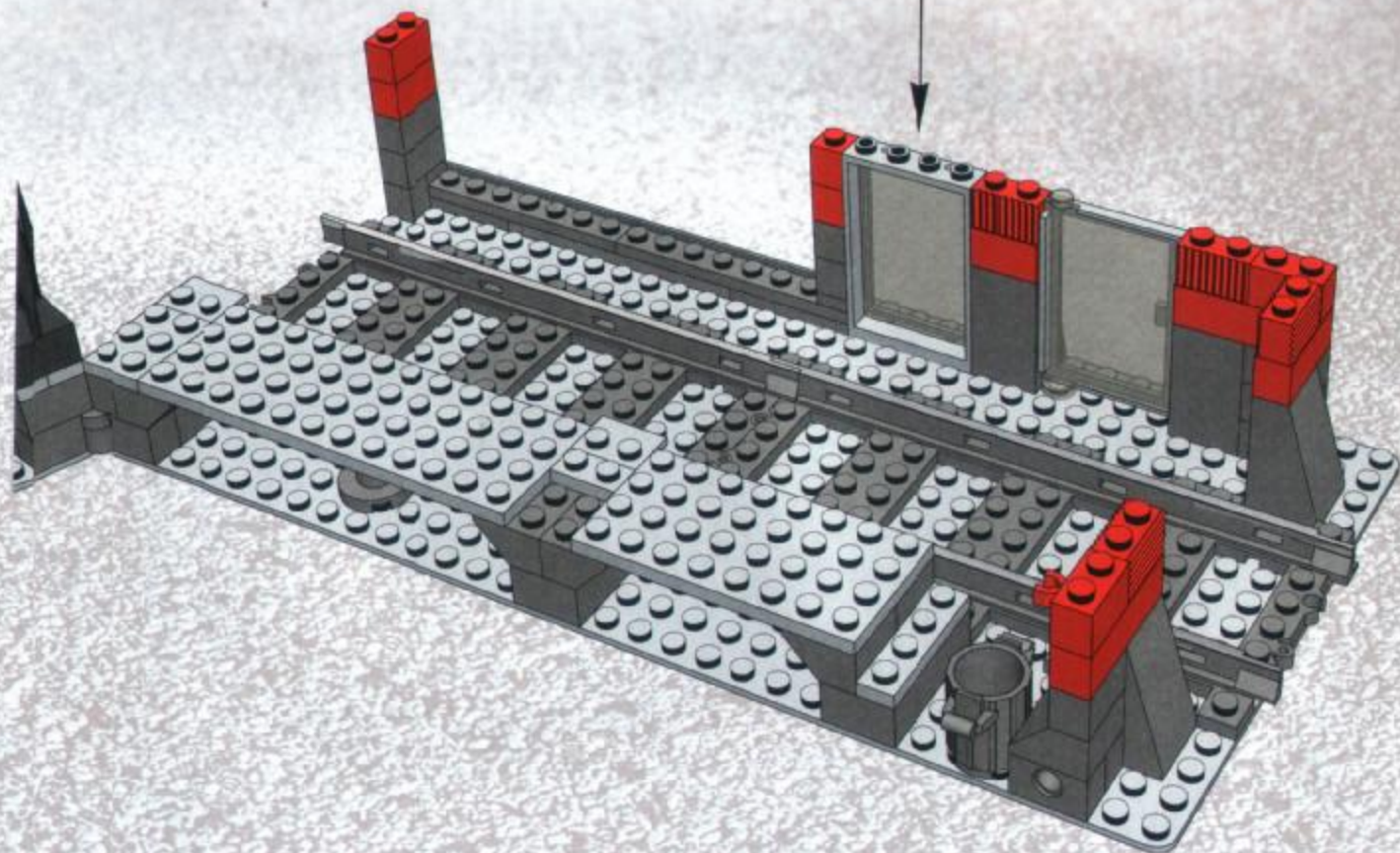
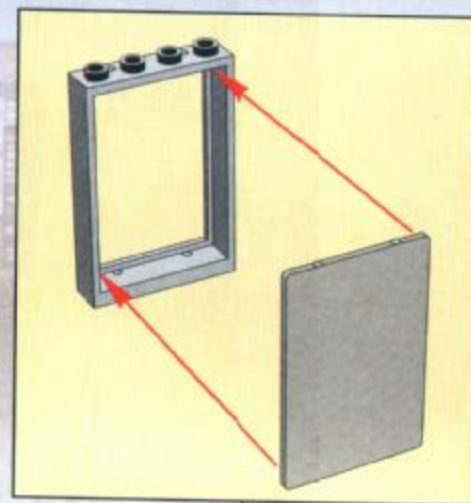
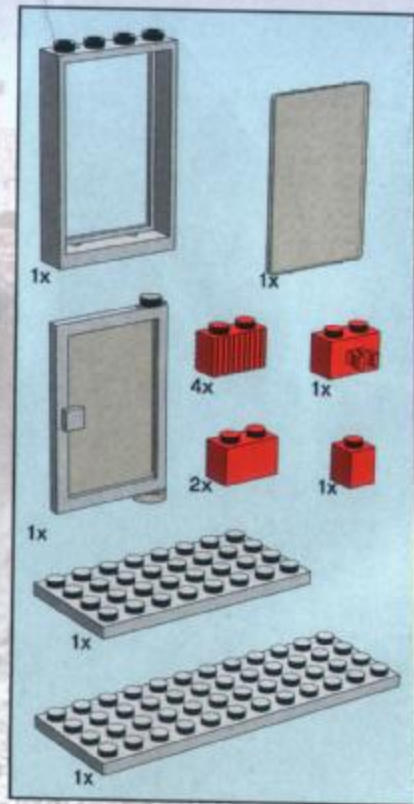

22

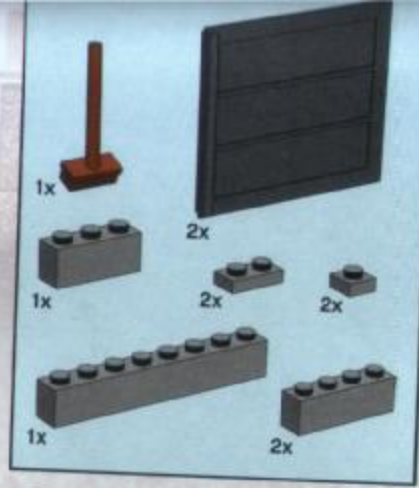

23

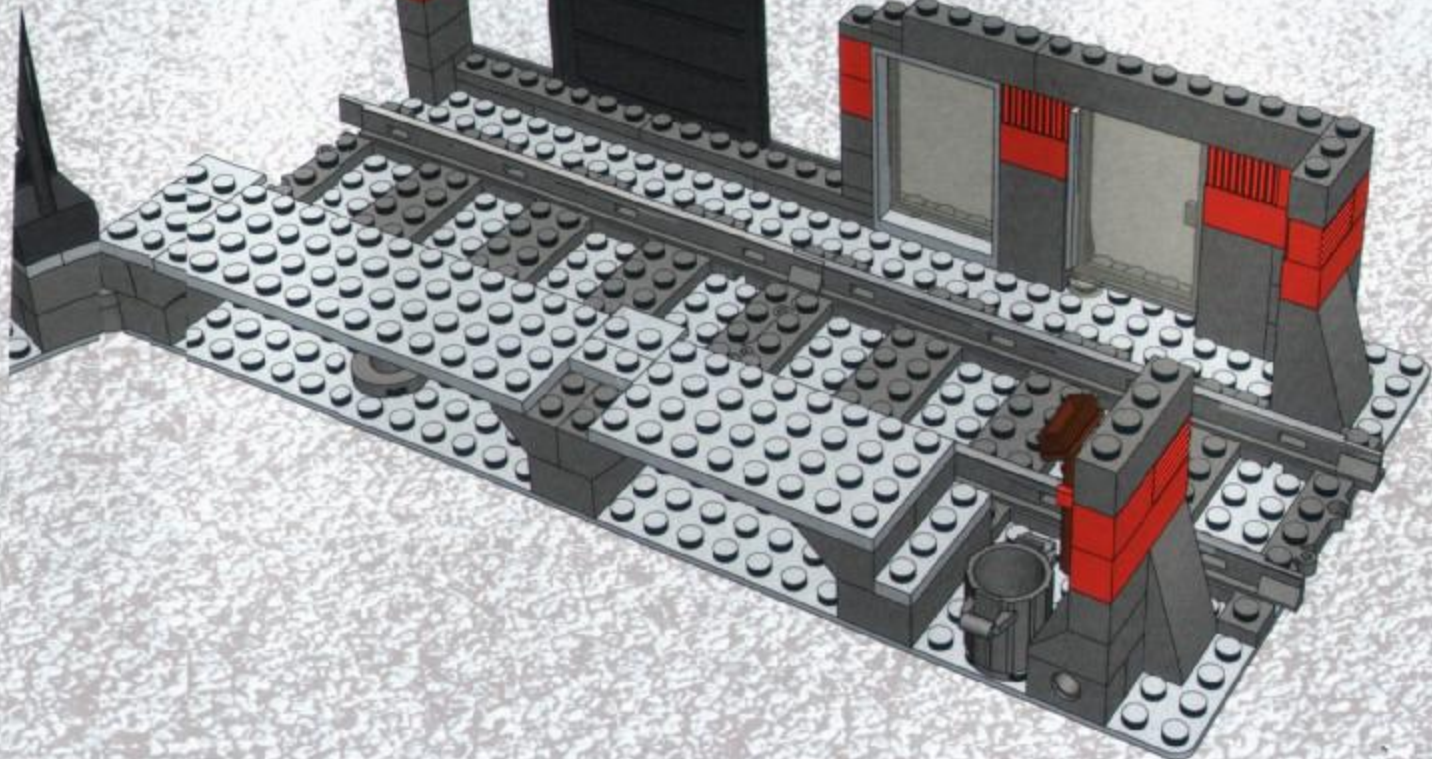
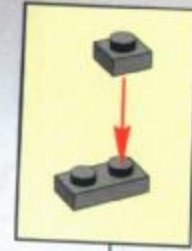
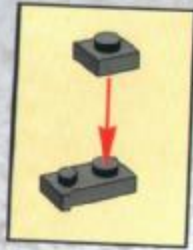
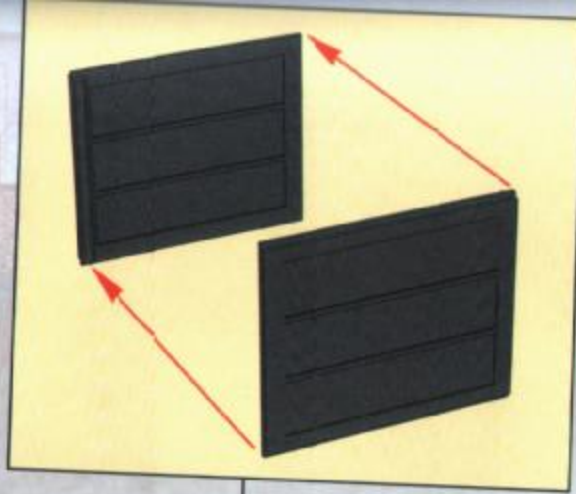

24

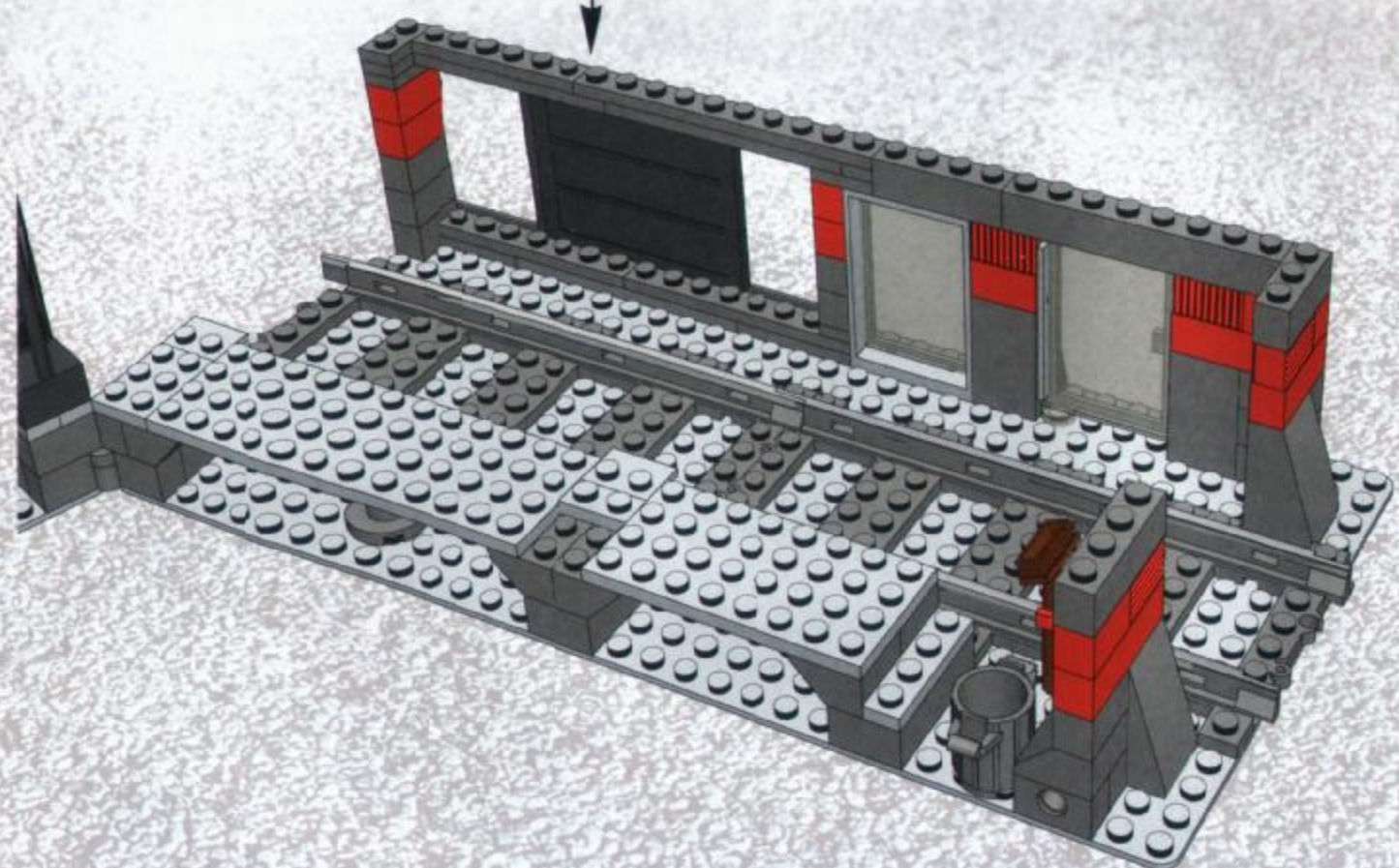
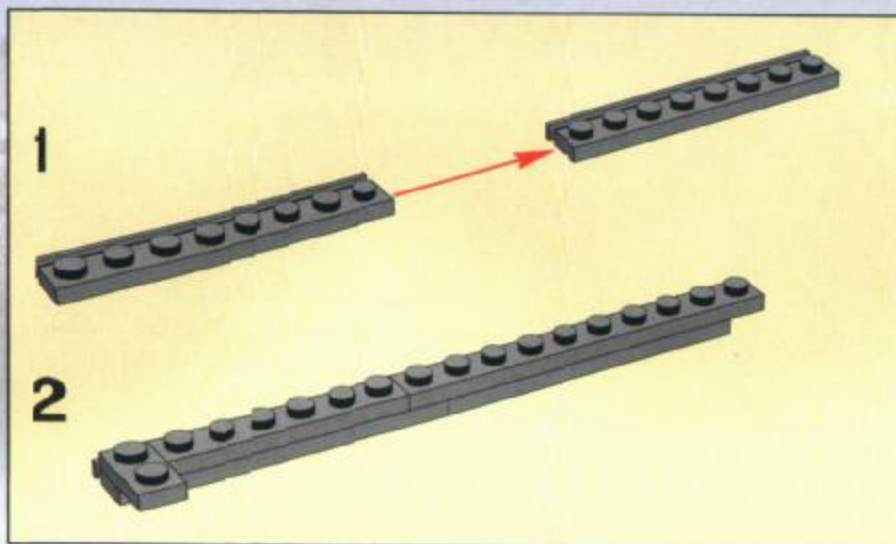
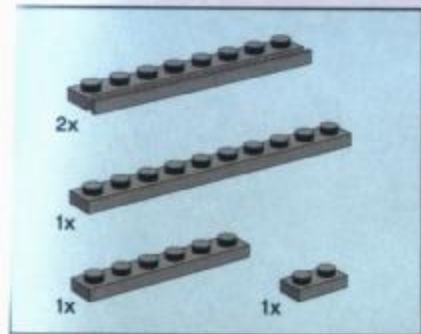

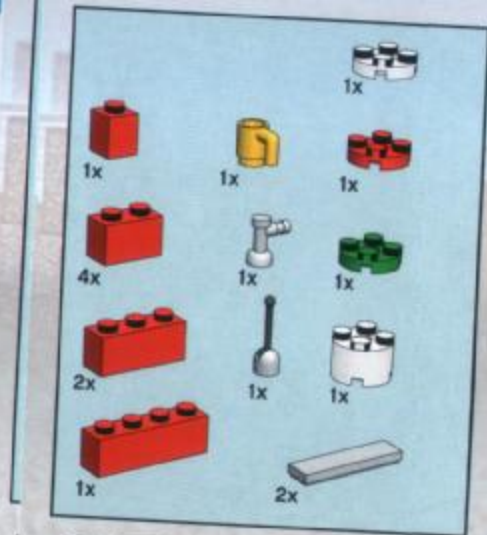

25

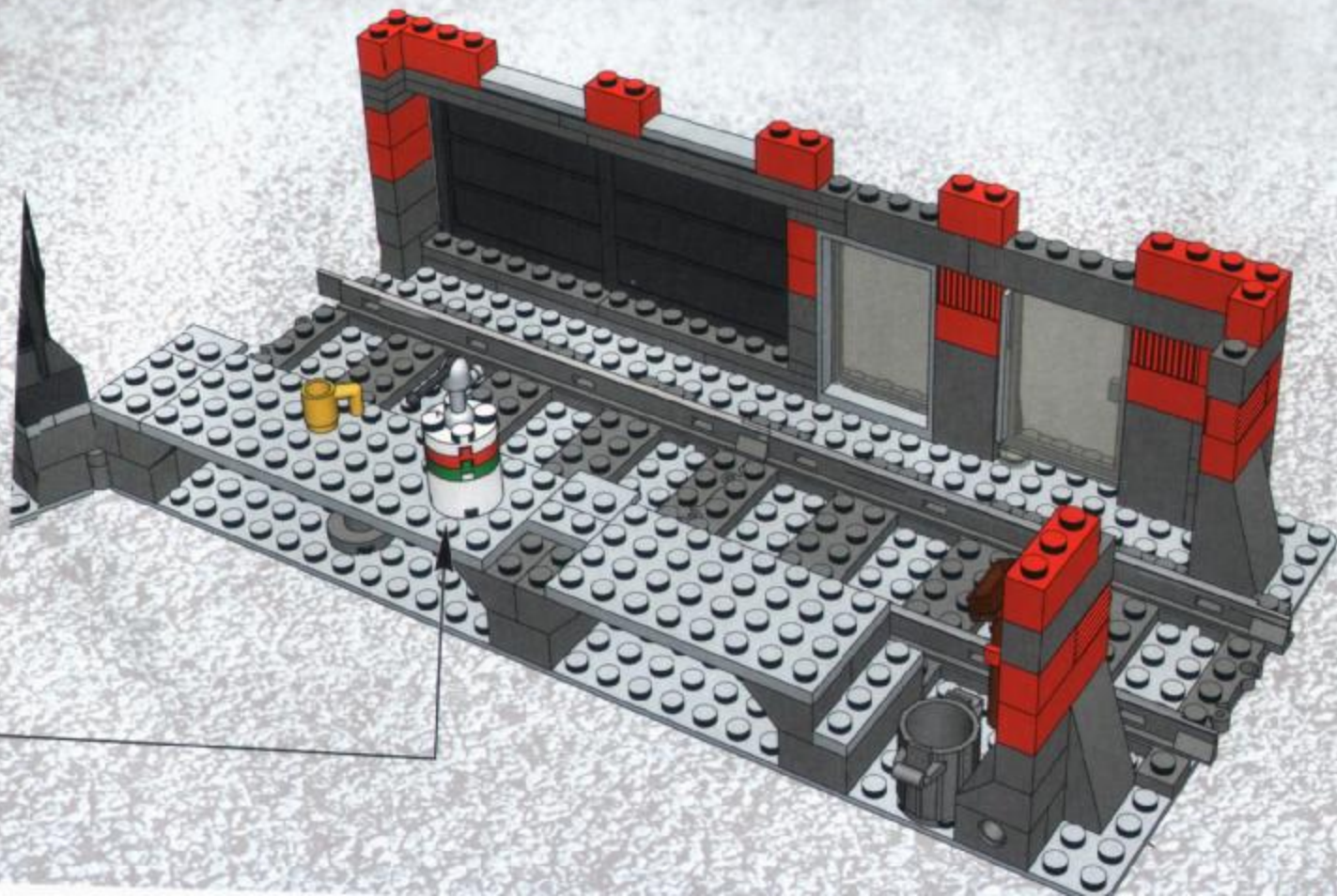
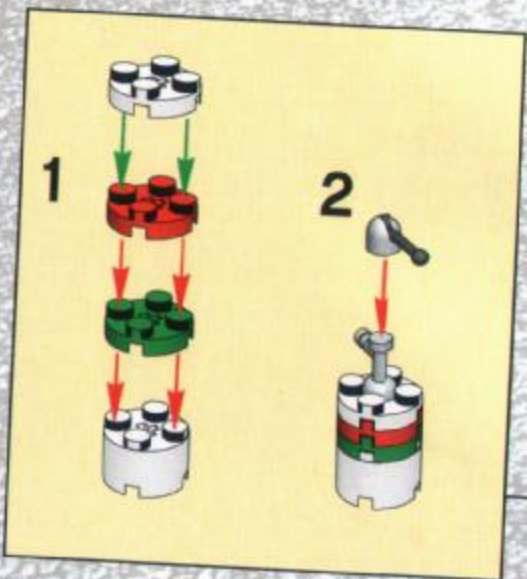

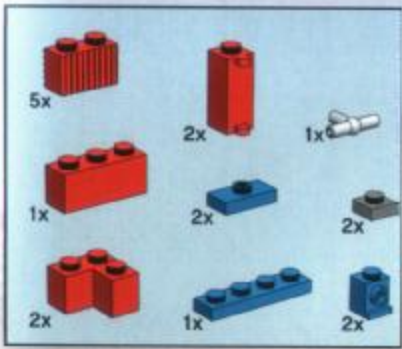

26

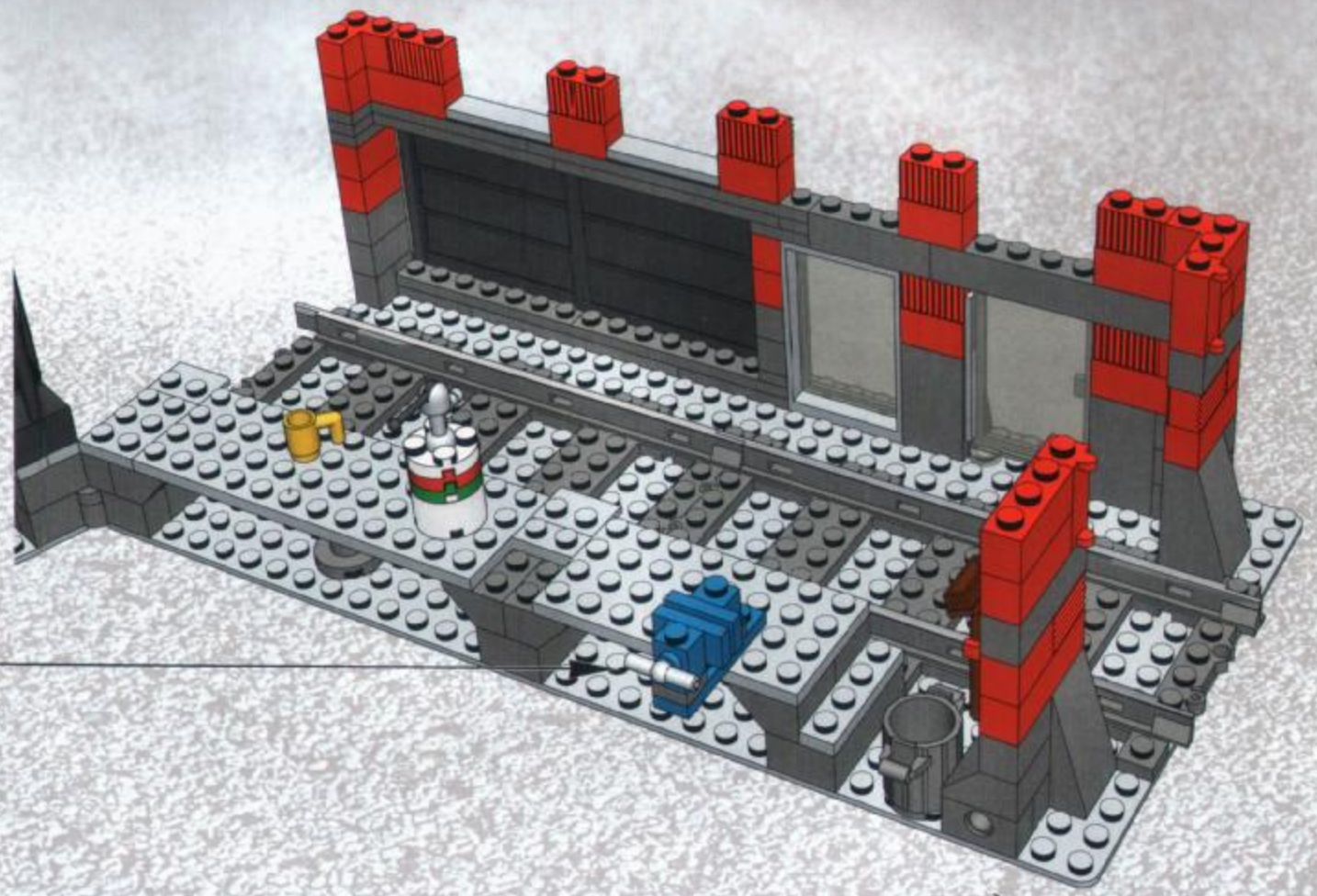
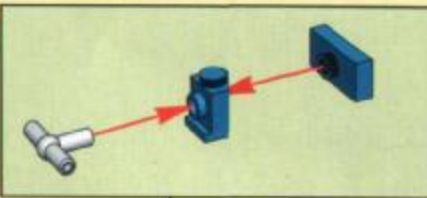
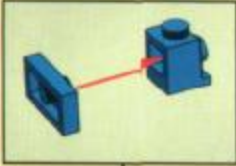

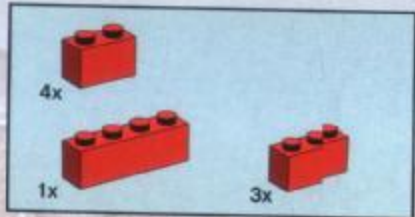

27

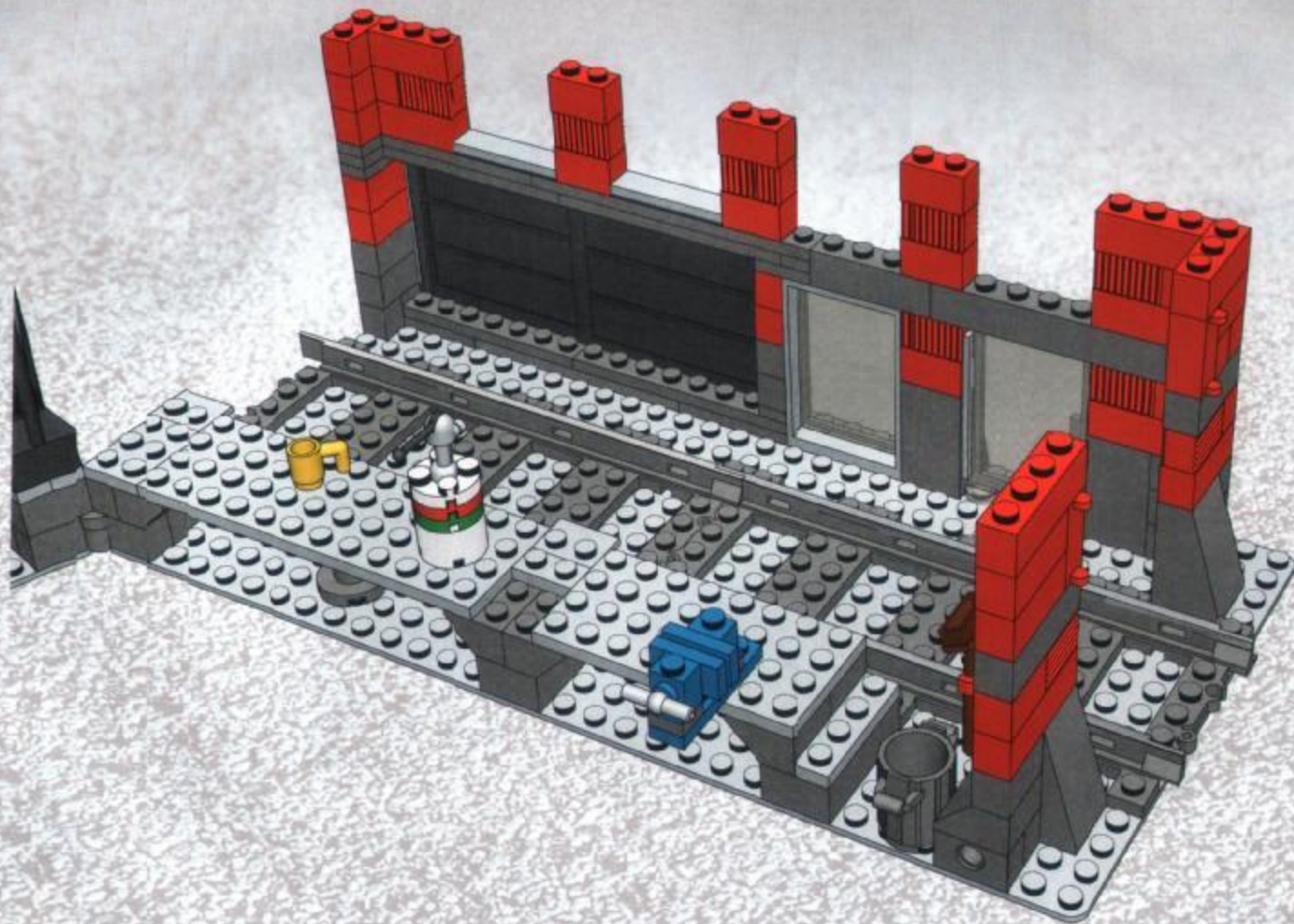

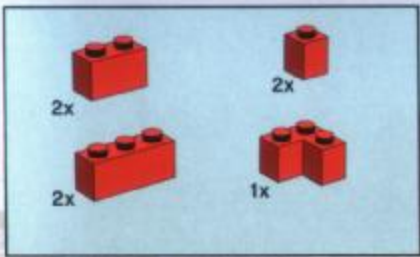

28

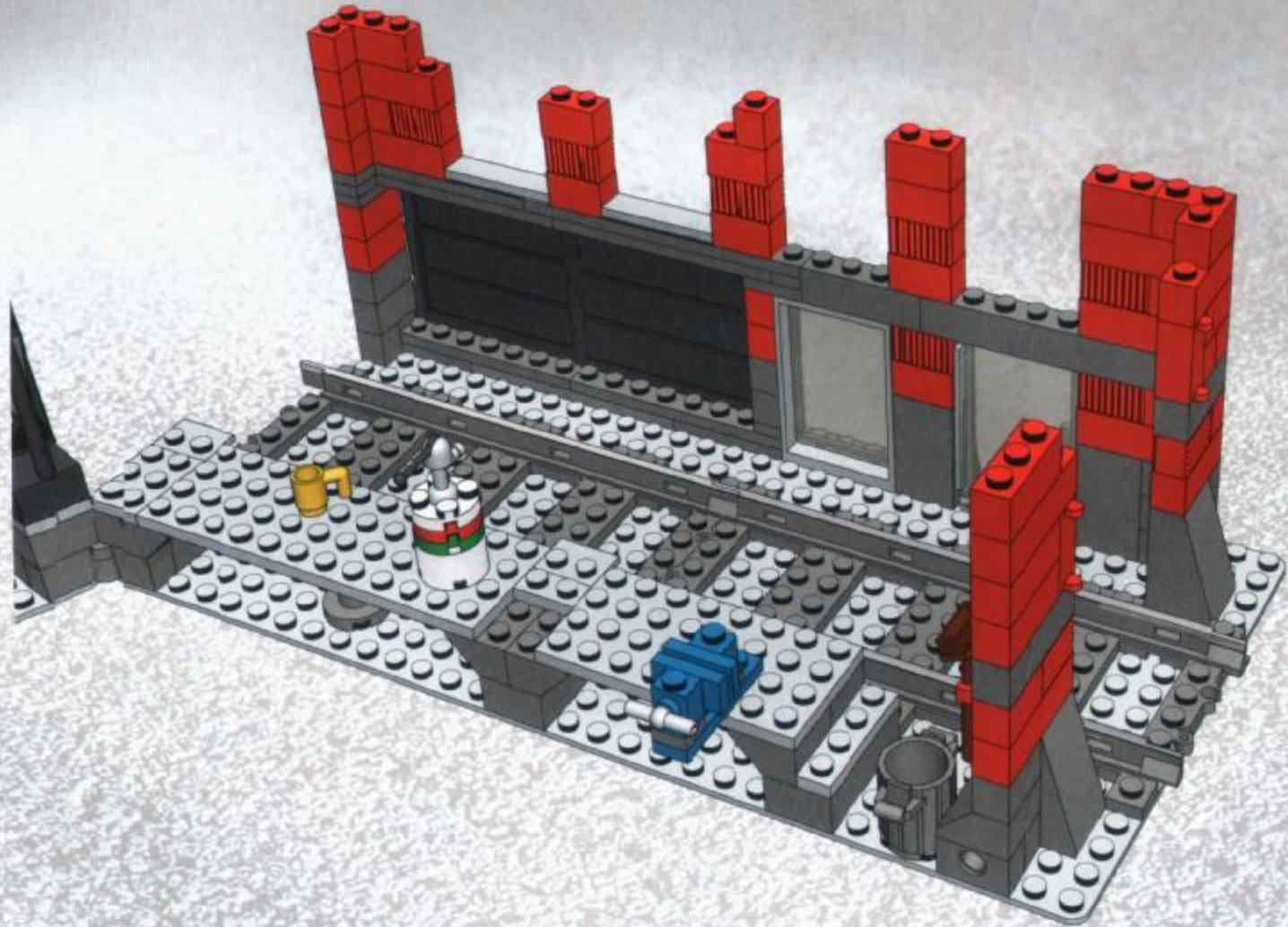

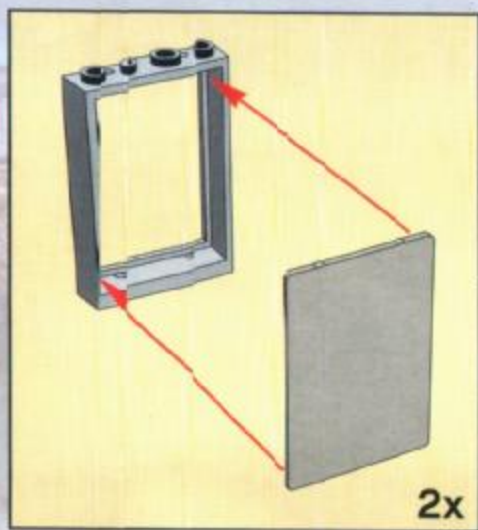
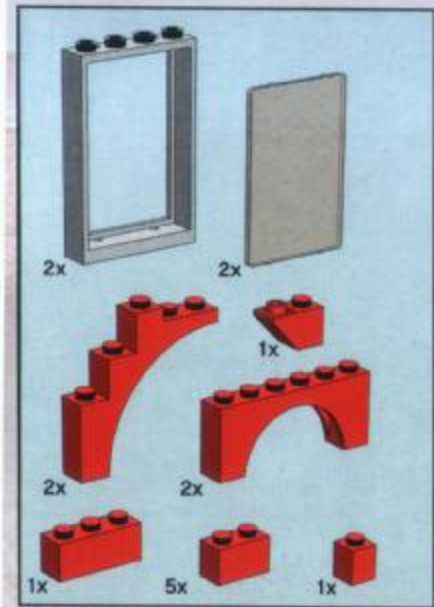

29

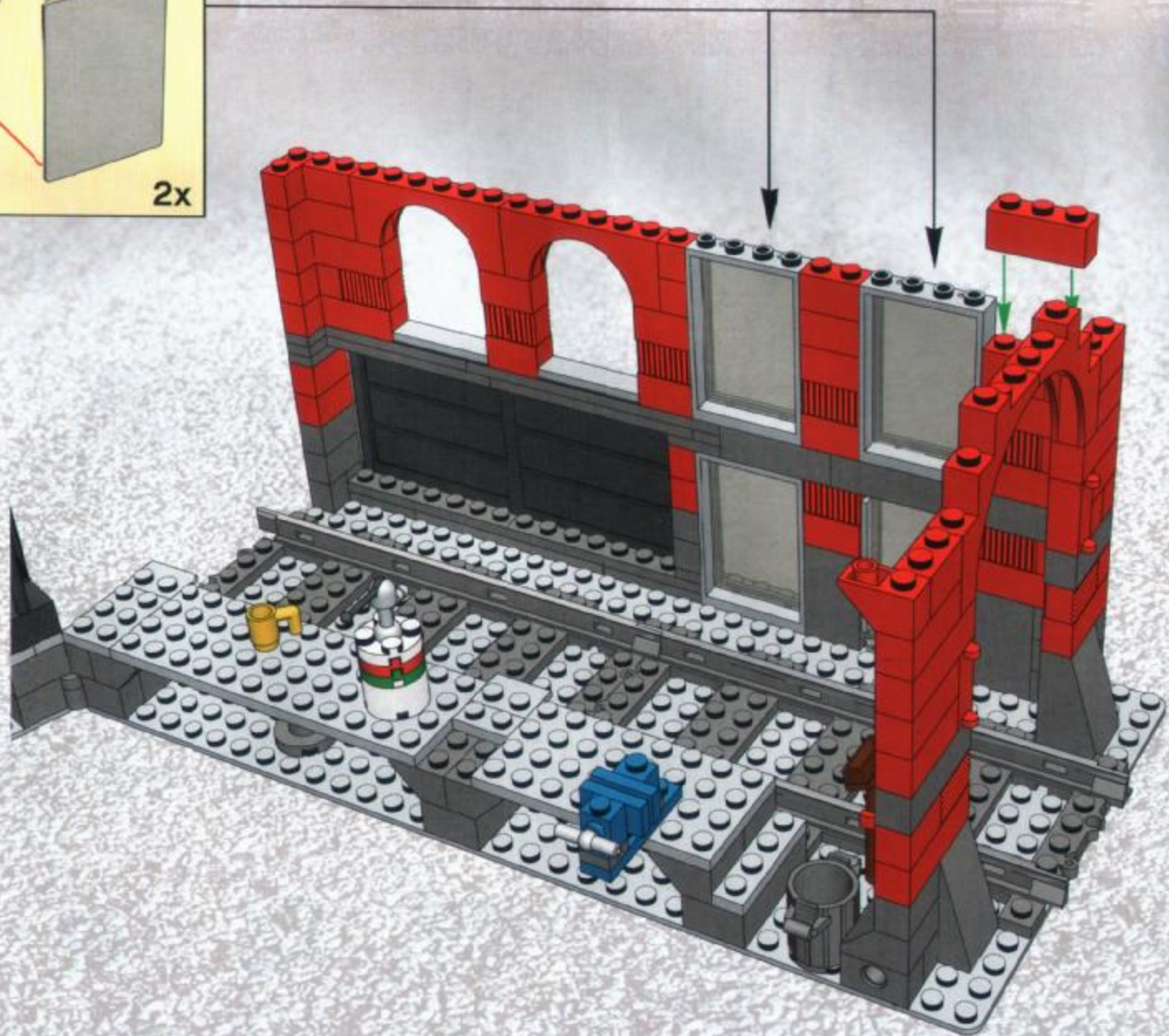

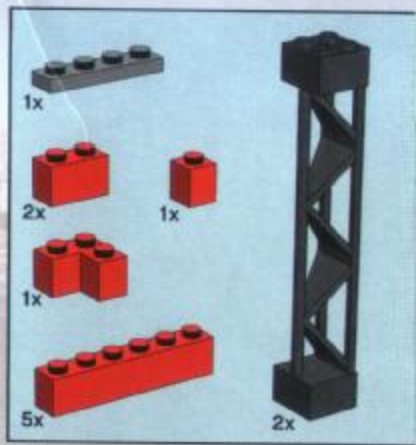

30

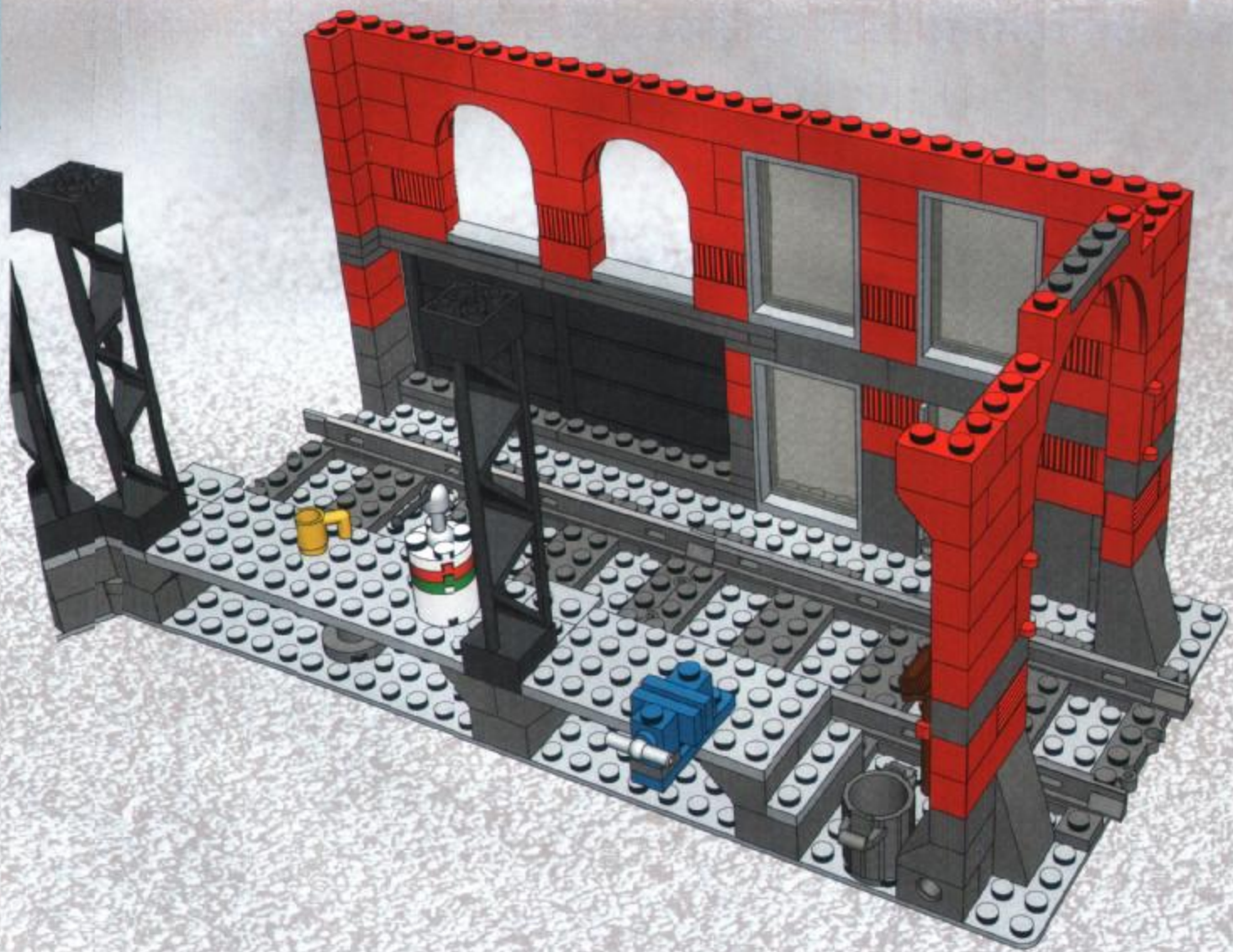

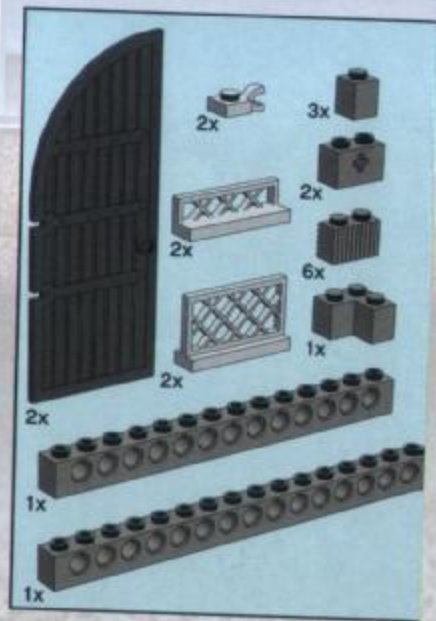

31





33

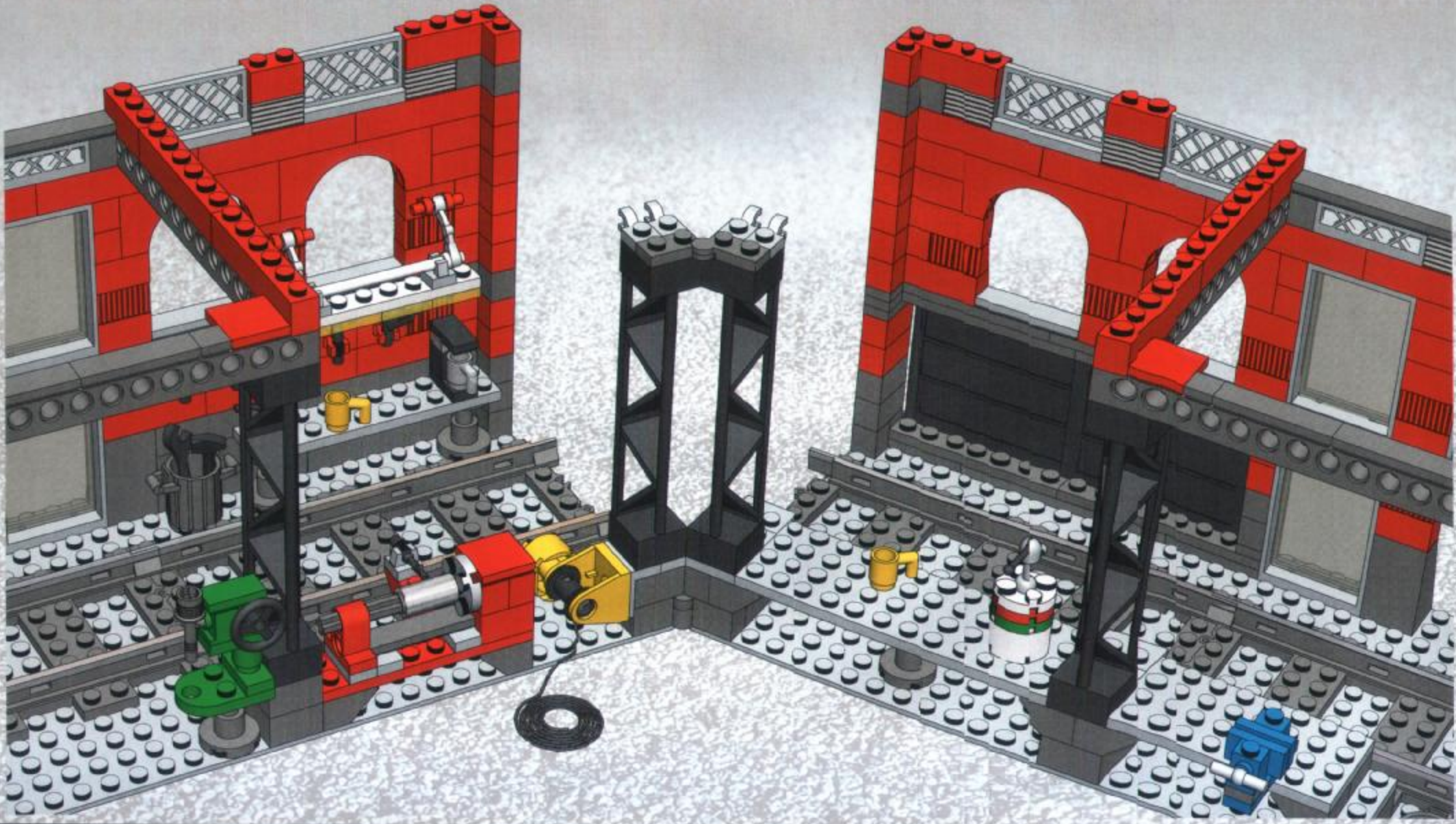

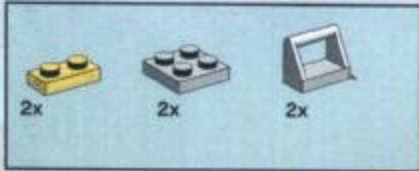

34

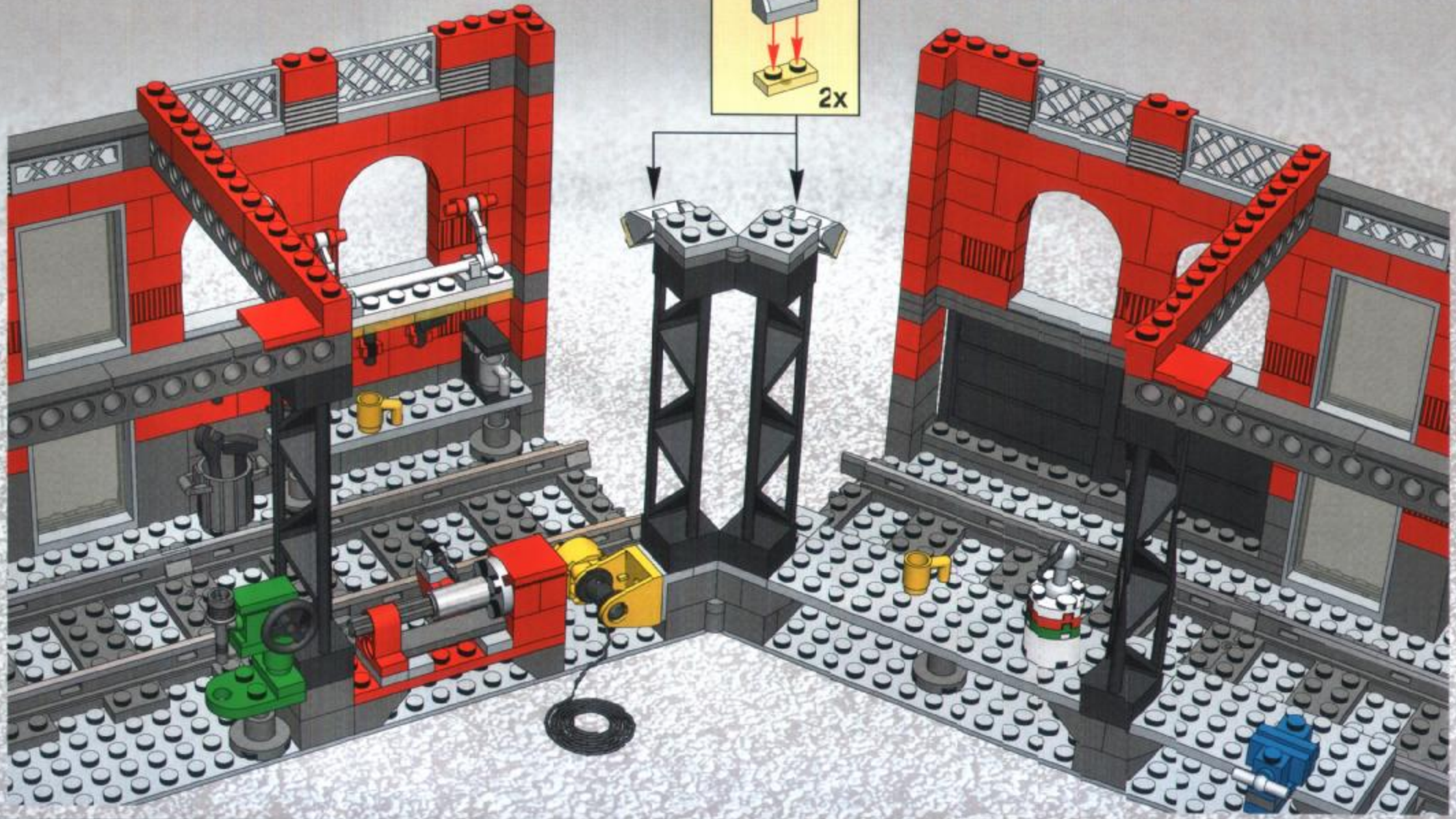
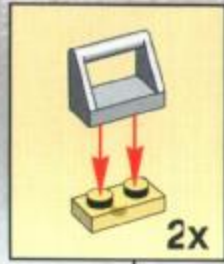

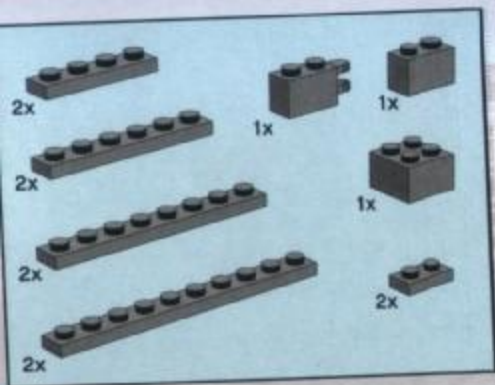

35



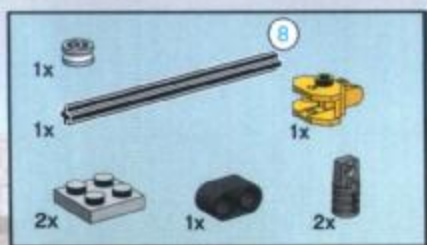

36

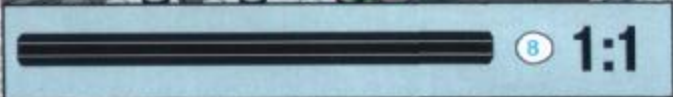

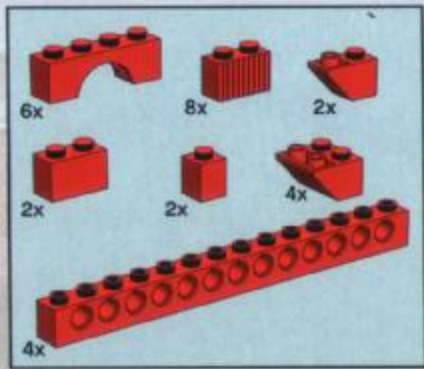

37

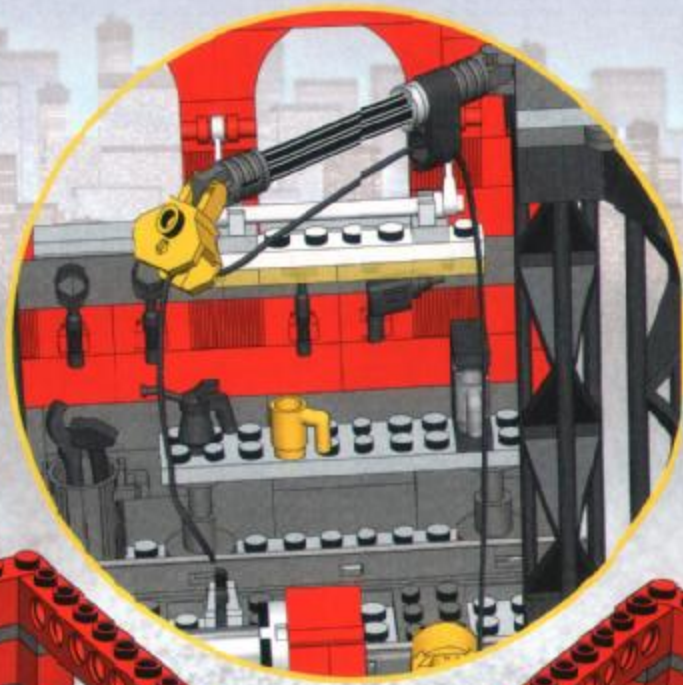

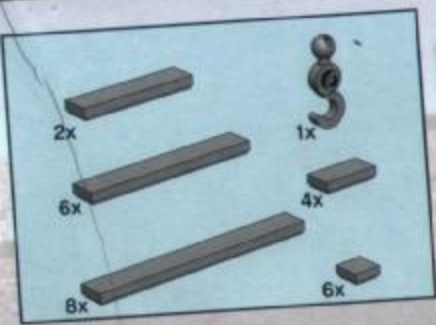

38



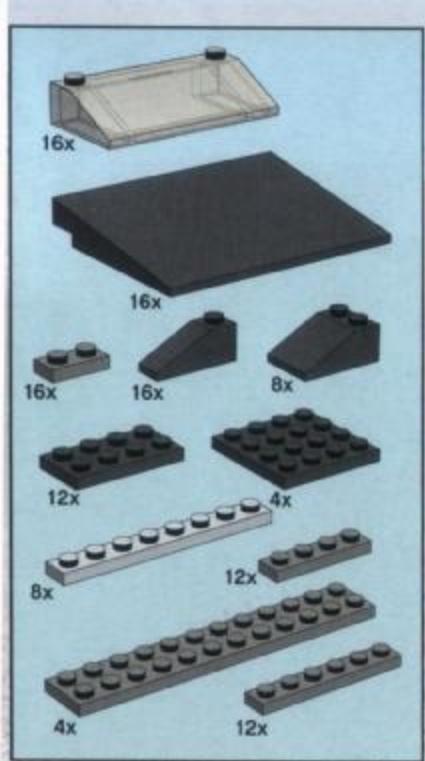

39

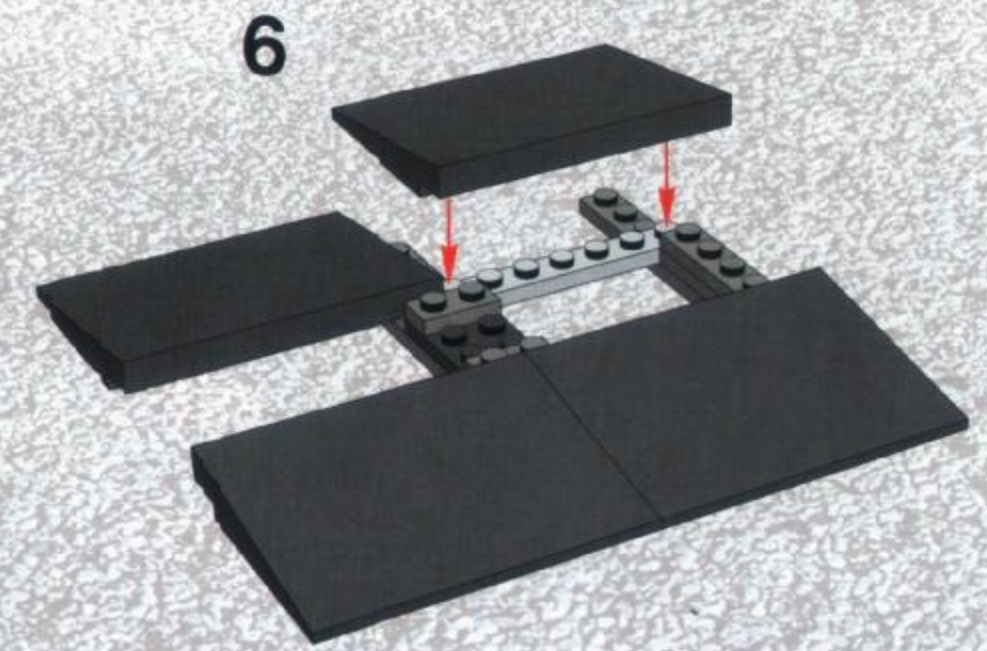
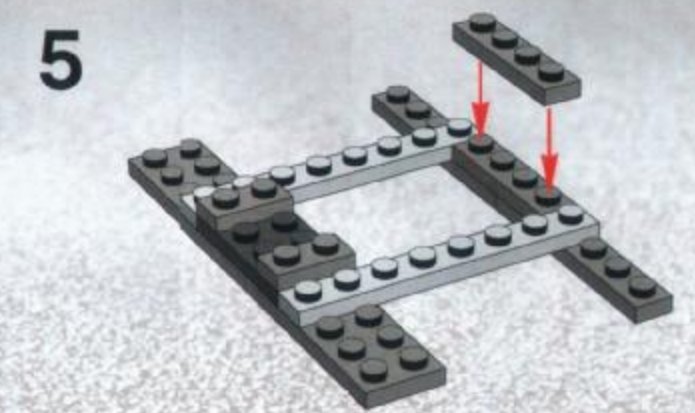
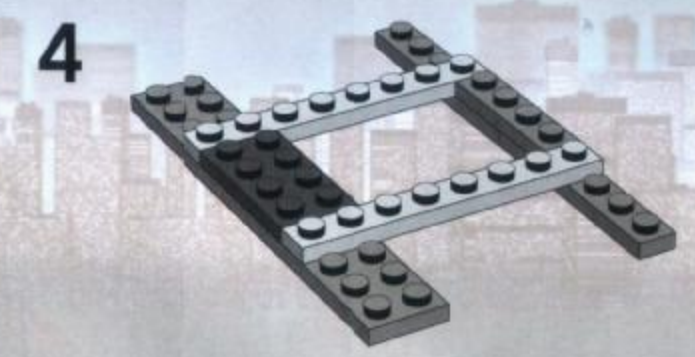
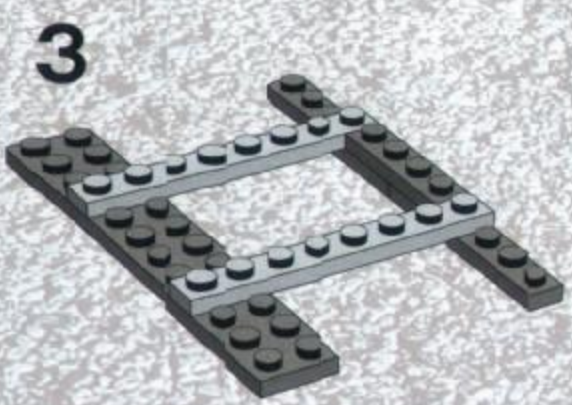
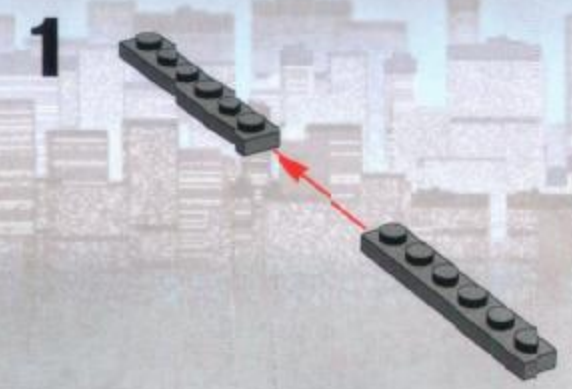

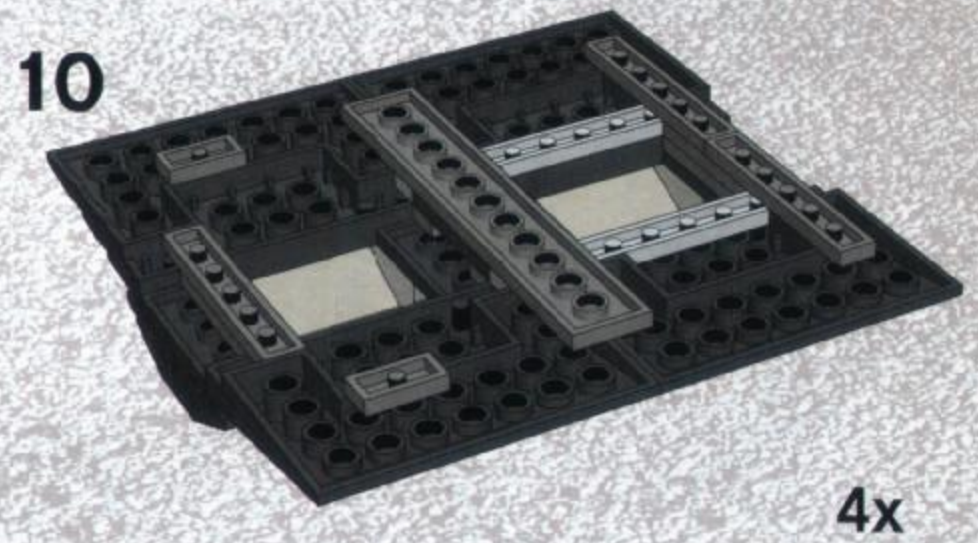
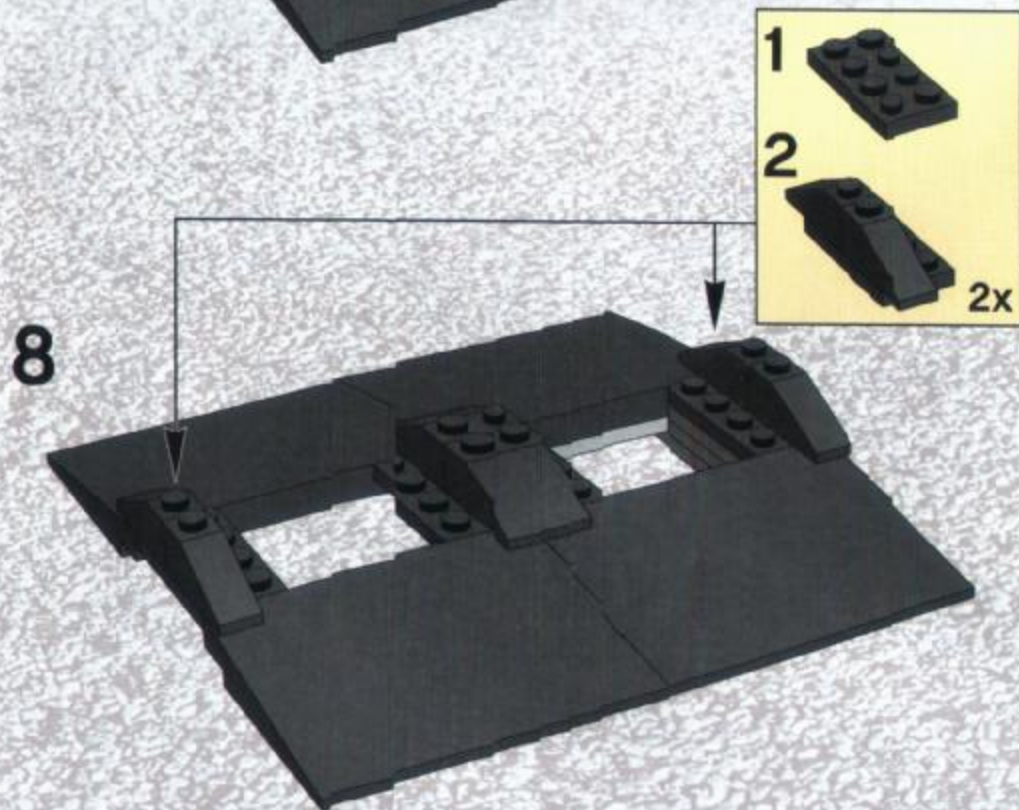
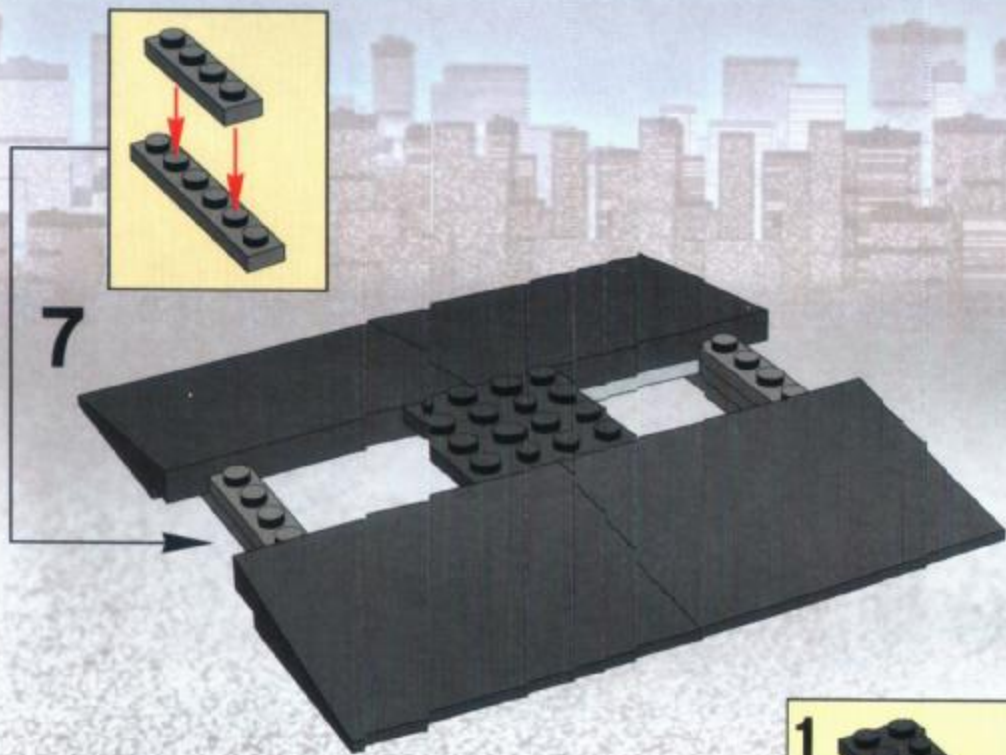



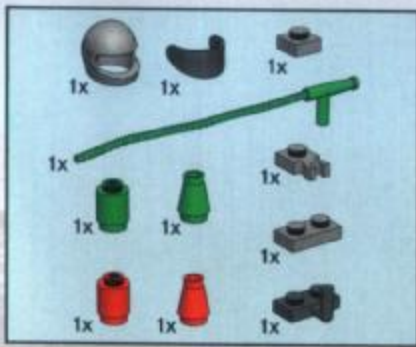

40

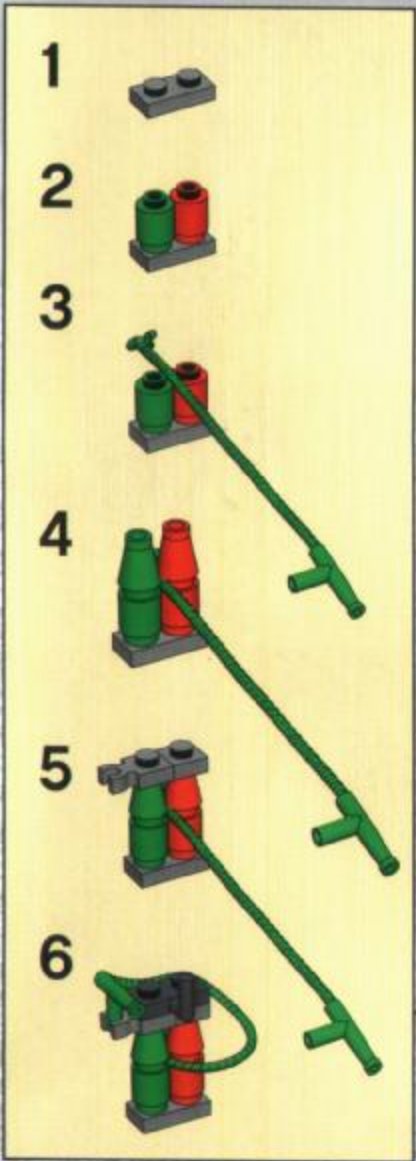

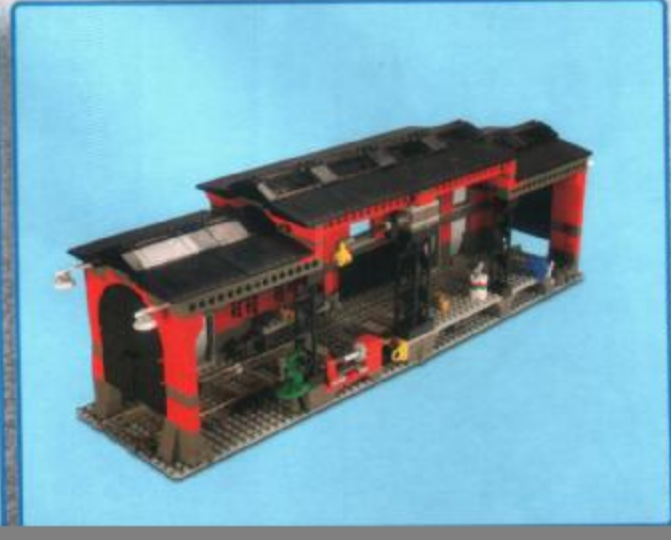

Win! Gagne! Gewinne! 当たります



Win LEGO® products

We would really like to know what you think about your new LEGO® product.

If you could help us by answering a few questions at www.acnielsen.aim.dk/lego then you are in with a chance of winning an exciting LEGO prize.

It will only take you about 3 minutes!



Estimado usuario LEGO®

Al contestar algunas preguntas en Inglés, francés, alemán o japonés, en el sitio www.acnielsen.aim.dk/lego, podrás participar en el sorteo de algunos valiosos premios LEGO®.



Gagne des produits LEGO®

Nous aimerions beaucoup savoir ce que tu penses de ton nouveau produit LEGO®.

Si tu veux bien nous aider en répondant à quelques questions sur www.acnielsen.aim.dk/lego, tu recevras peut-être bientôt l'un des nombreux prix offerts par LEGO aux participants.

Et cela ne prendra que 3 minutes environ !



Kövels fű LEGO® Vásárló

Hellátgatsz a www.acnielsen.aim.dk/lego honlapra és ott (ingli, francia, német vagy japán nyelven) megválaszolsz néhány kérdést, akkor részt vehetsz egy versenyben, amelyben értékes LEGO® díjakat nyrhatsz.



Gewinne LEGO® Produkte

Wir sind sehr an deiner Meinung über dein neues LEGO® Produkt interessiert.

Wenn du uns den Gefallen tust und urtest www.acnielsen.aim.dk/lego Fragen beantwortest, kannst du einen tollen LEGO Preis gewinnen.

Das Ganze dauert nur etwa 3 Minuten!



Caro Consumidor da LEGO®

Ao responder a algumas perguntas em Inglês, Francês, Alemão ou Japonês no endereço www.acnielsen.aim.dk/lego irá participar num concurso para ganhar valiosos prémios da LEGO®.



抽選でレゴ製品が当たります

私たちは、皆さんがレゴ製品についてどんな感想をお持ちか、是非知りたいと思っています。

www.acnielsen.aim.dk/legoにアクセスいただき、質問にご回答いただきますと、抽選で楽しいレゴ製品が当たります。

アンケートのご回答には、ほんの3分ほどしかかかりません!

4511



4512

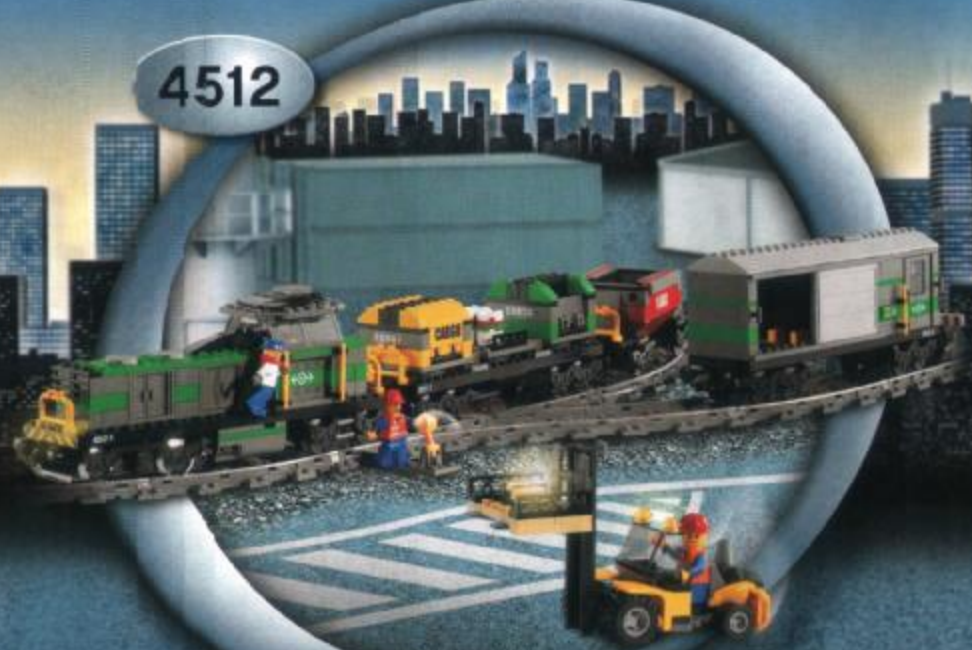

4513



4514

