

LEGO

STAR WARS

10143

UCS Death Star II™

STAR WARS
ORIGINAL TRILOGY EDITION

4230400

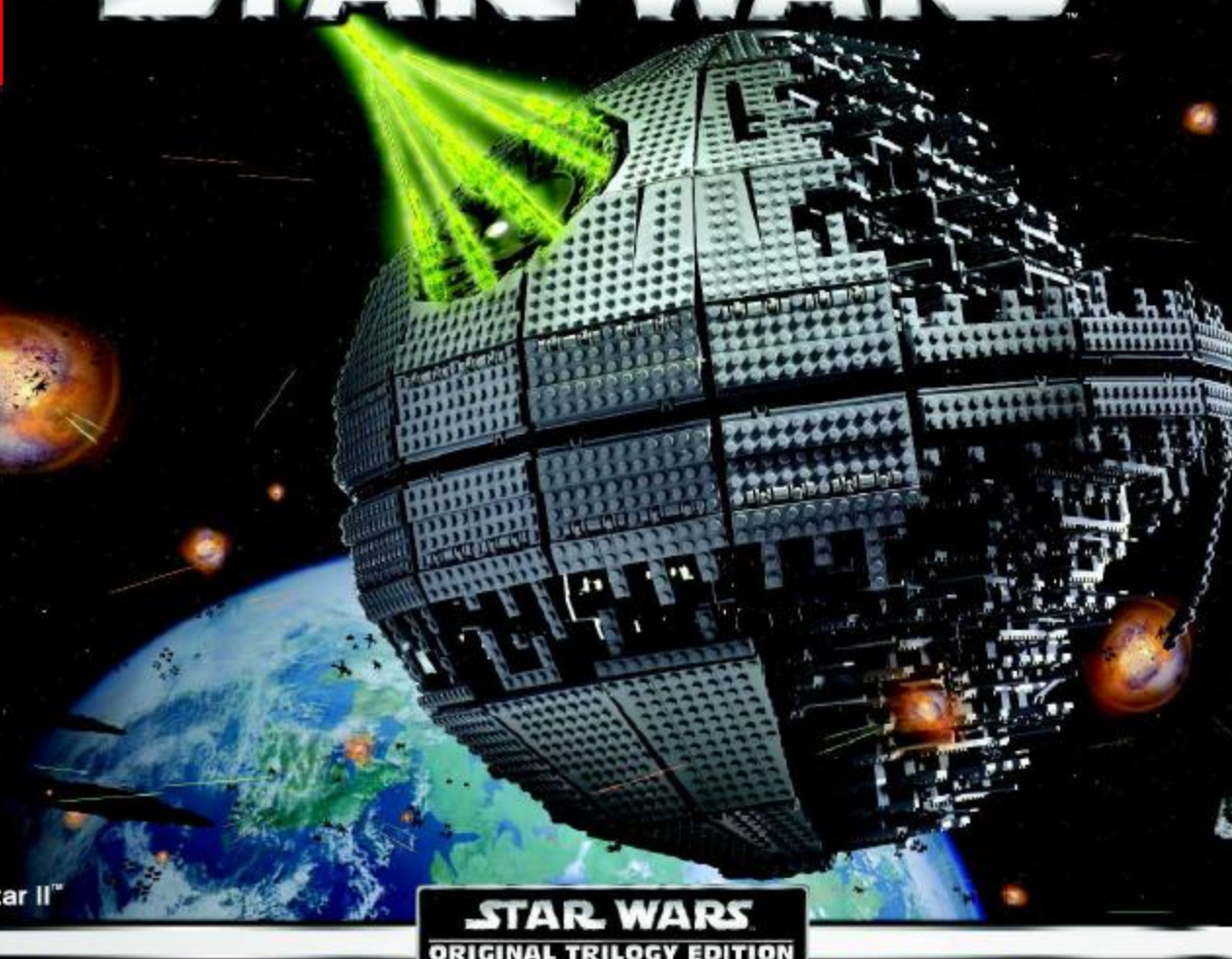

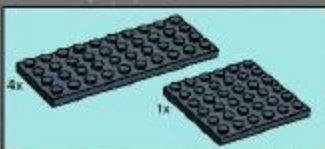

1

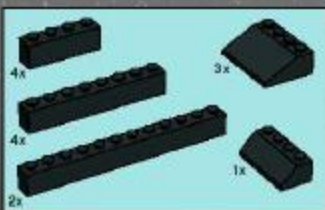

2

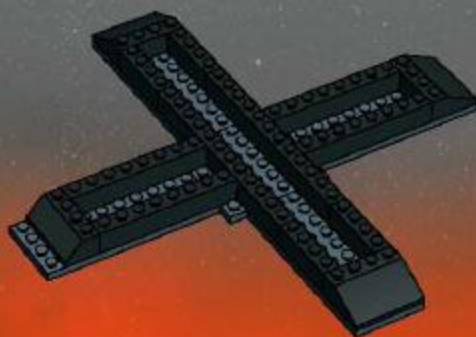

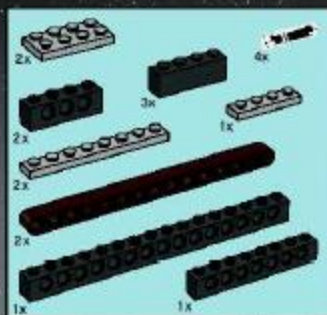

3

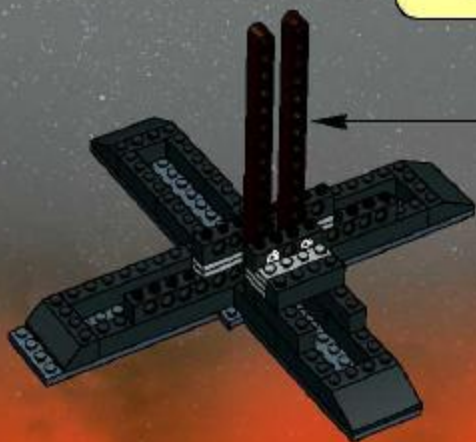
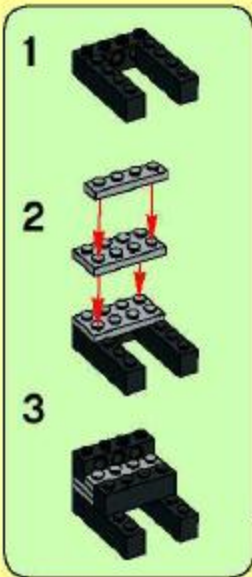
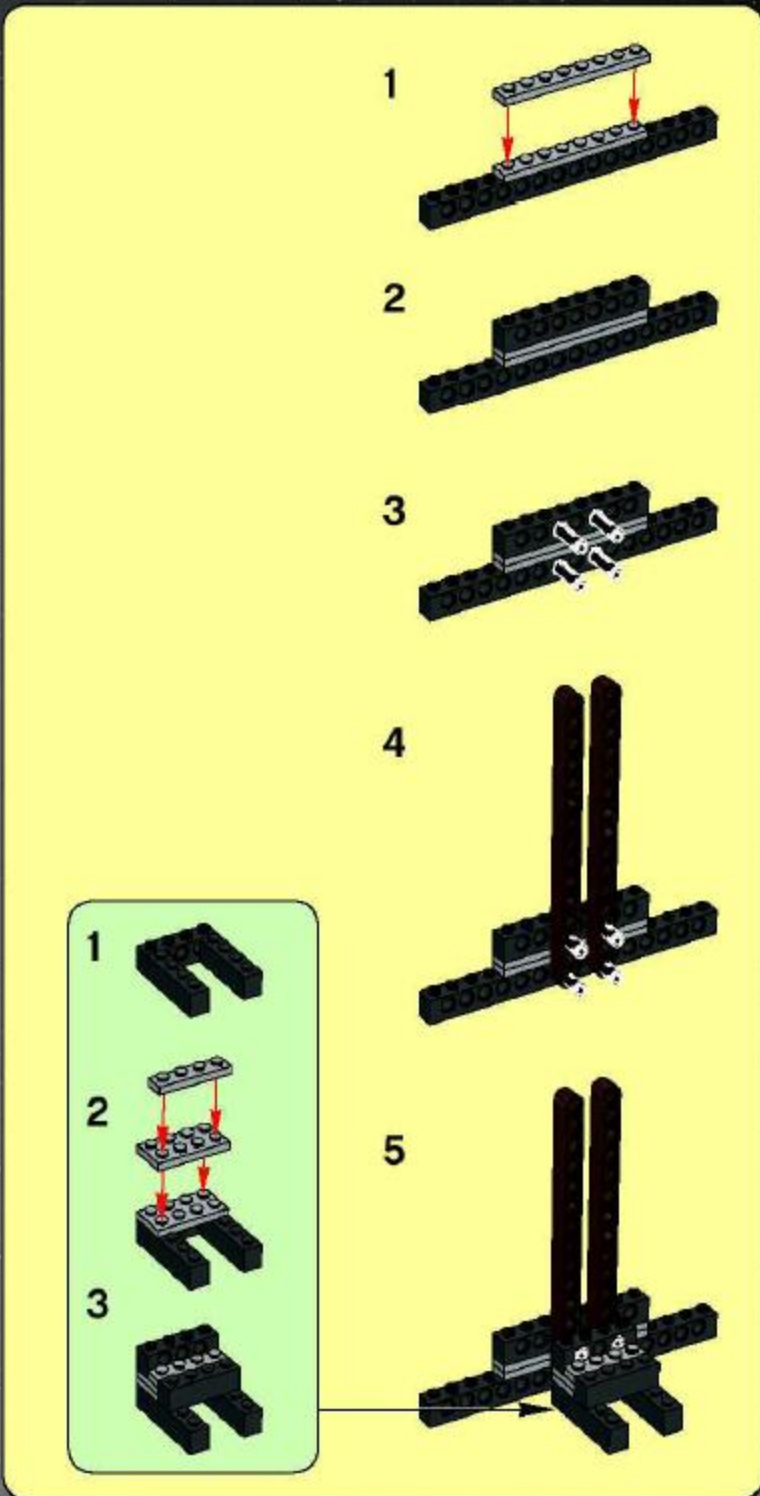

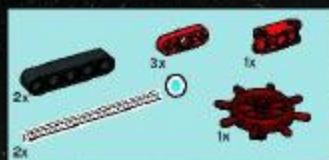

4

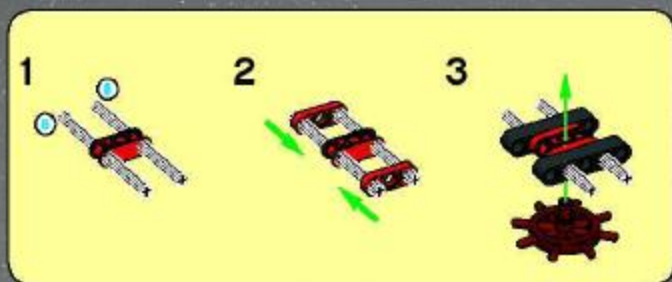

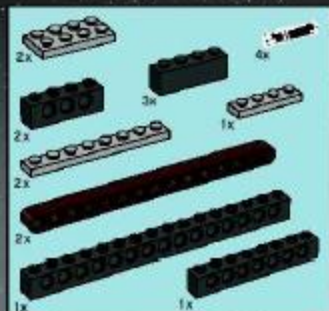

5

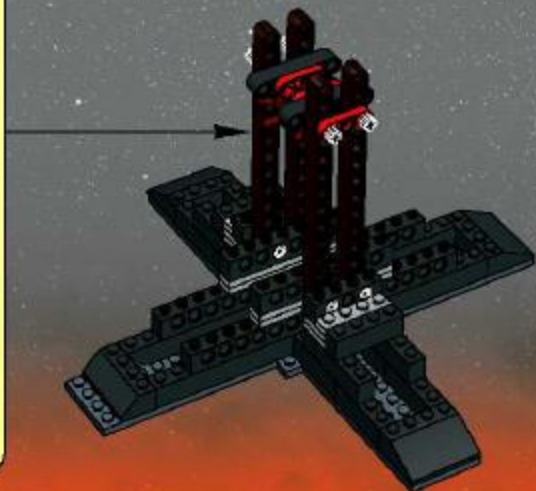
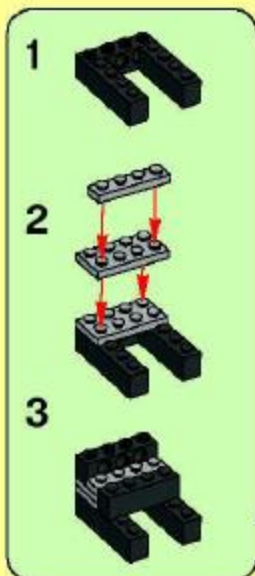
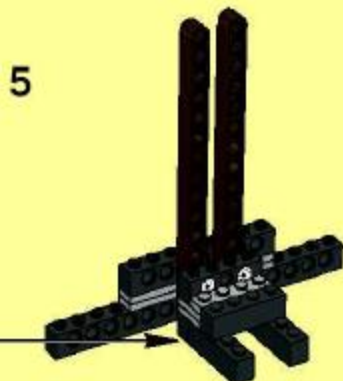
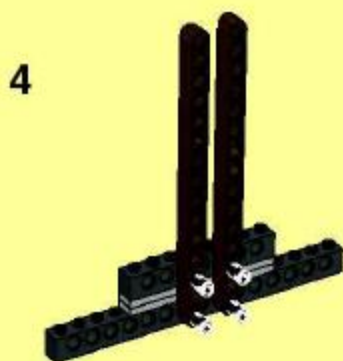
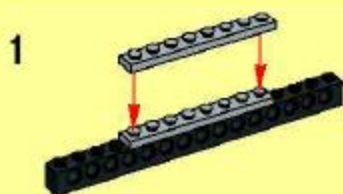



6

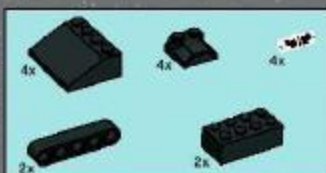

7





8

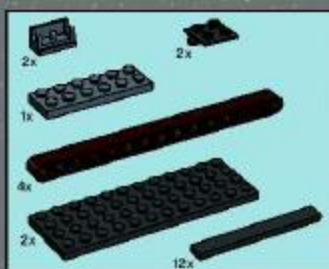
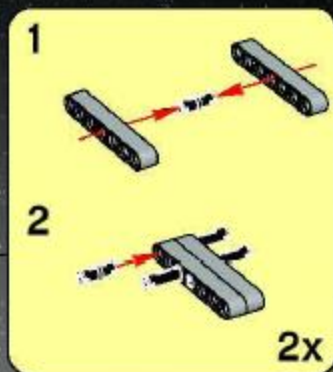
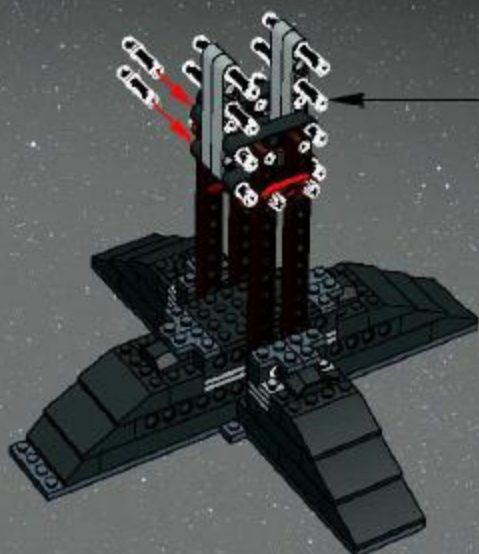

9

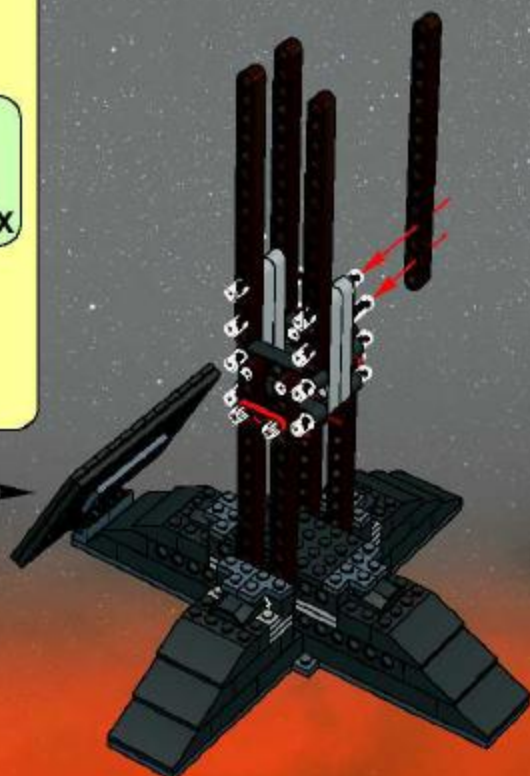
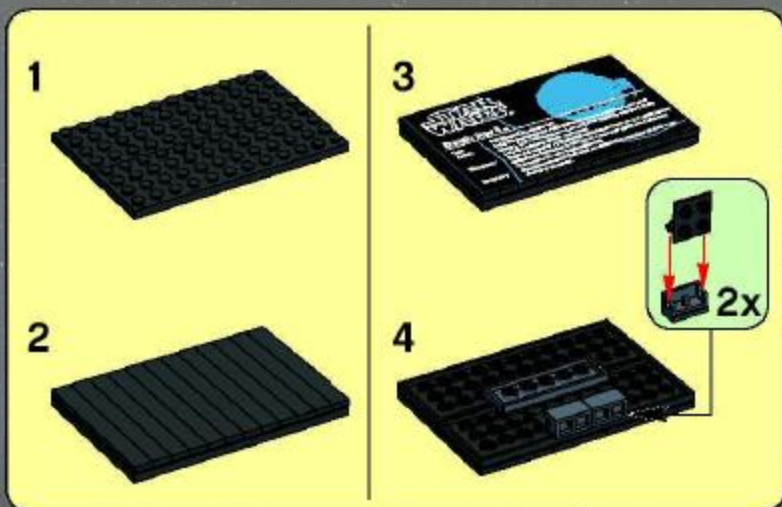

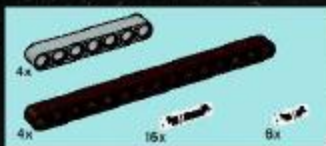

10

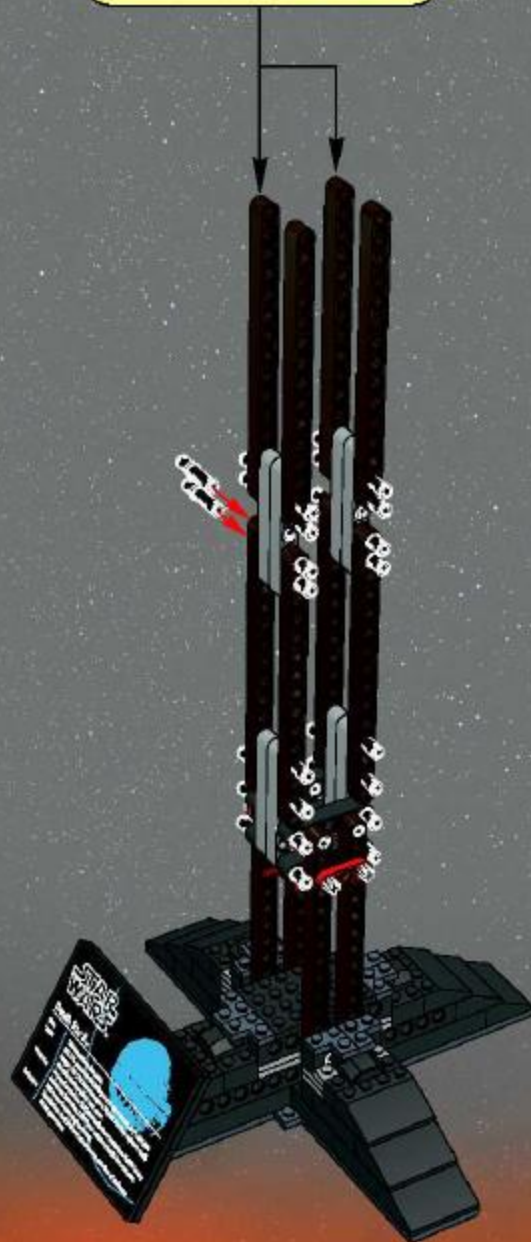
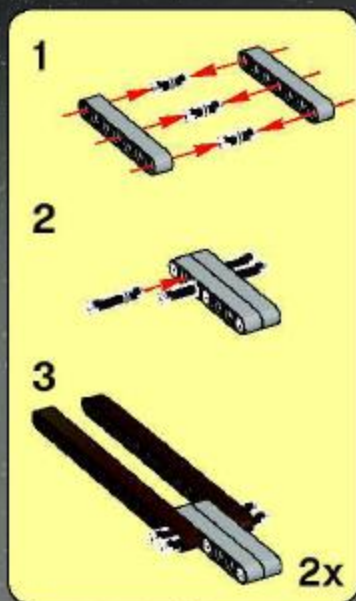



11



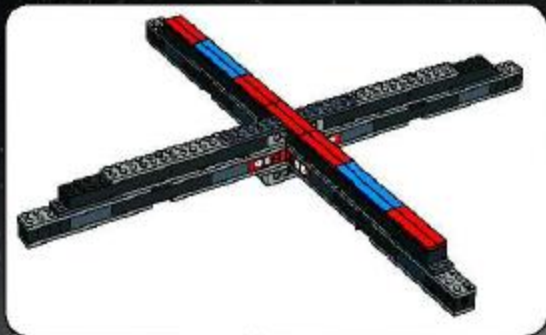

1



2



3



4

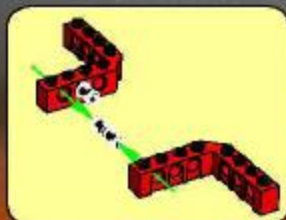

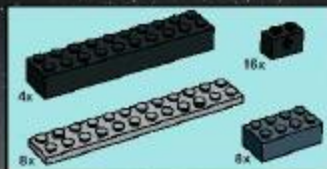

5

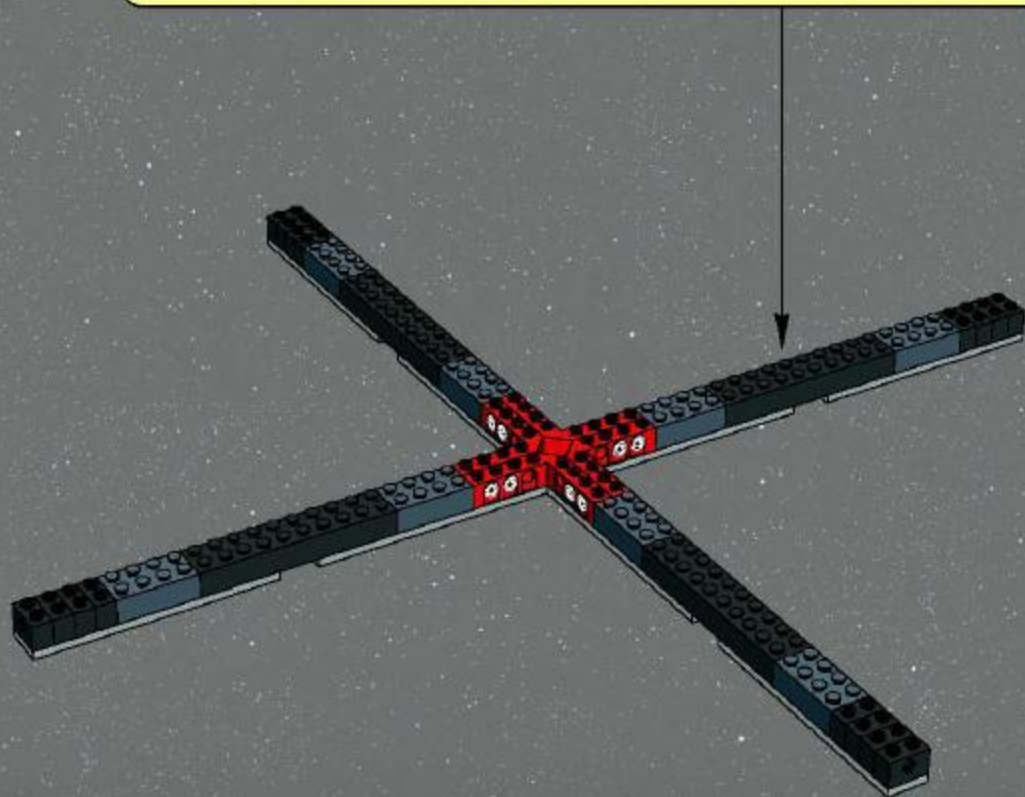
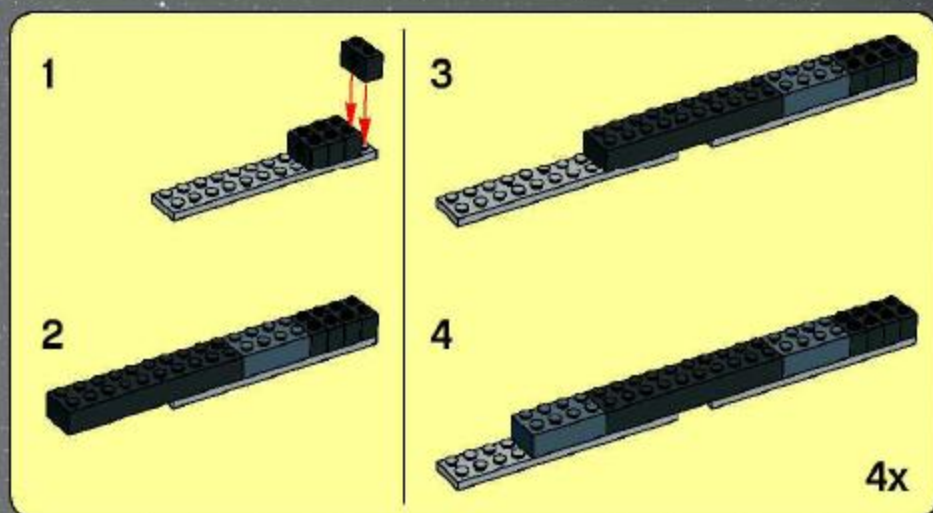



6

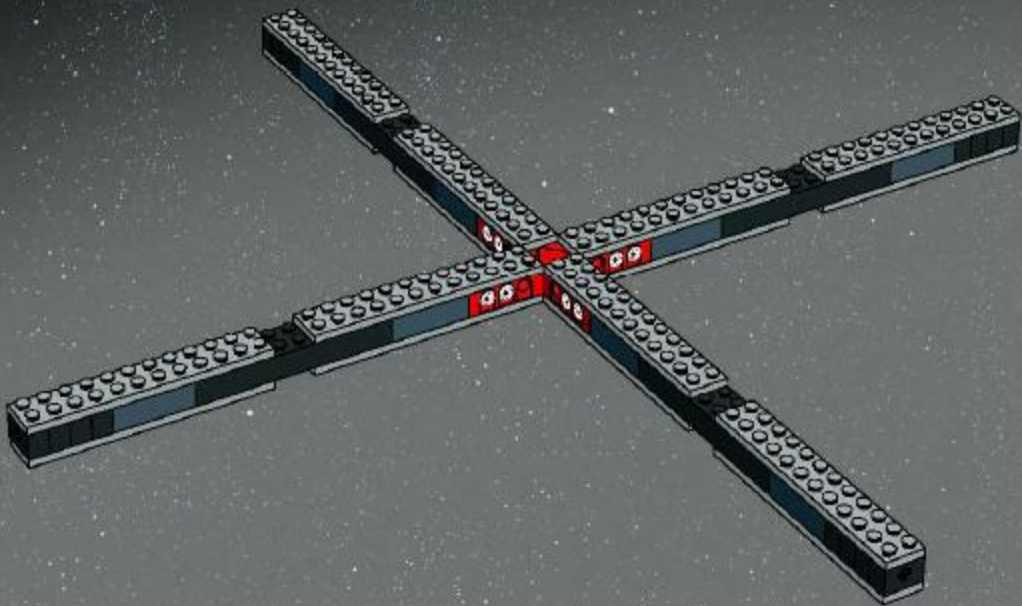

7

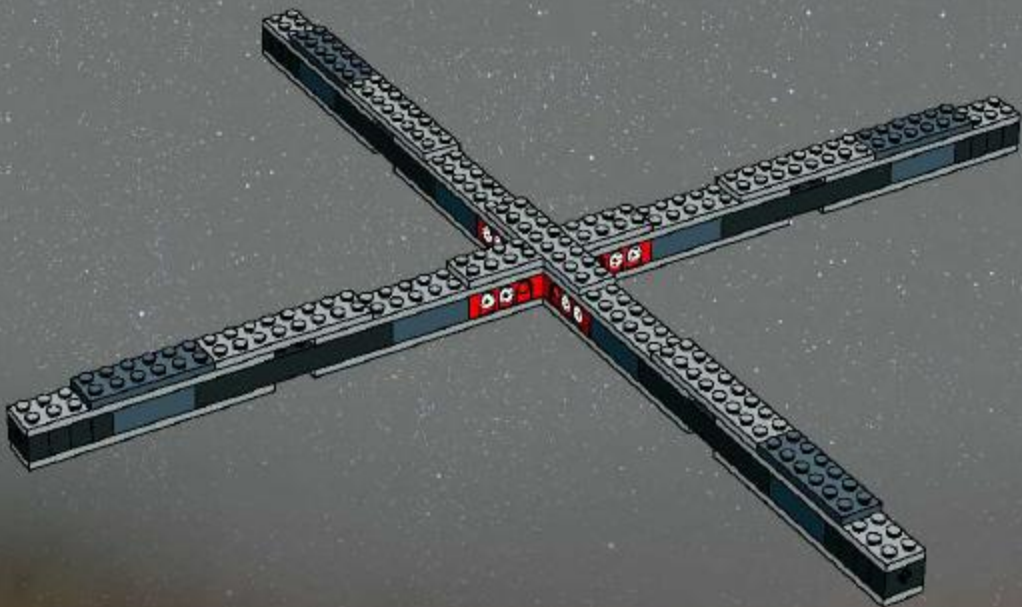



8

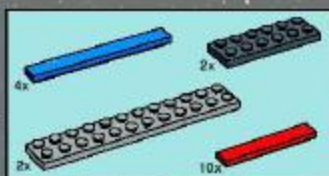
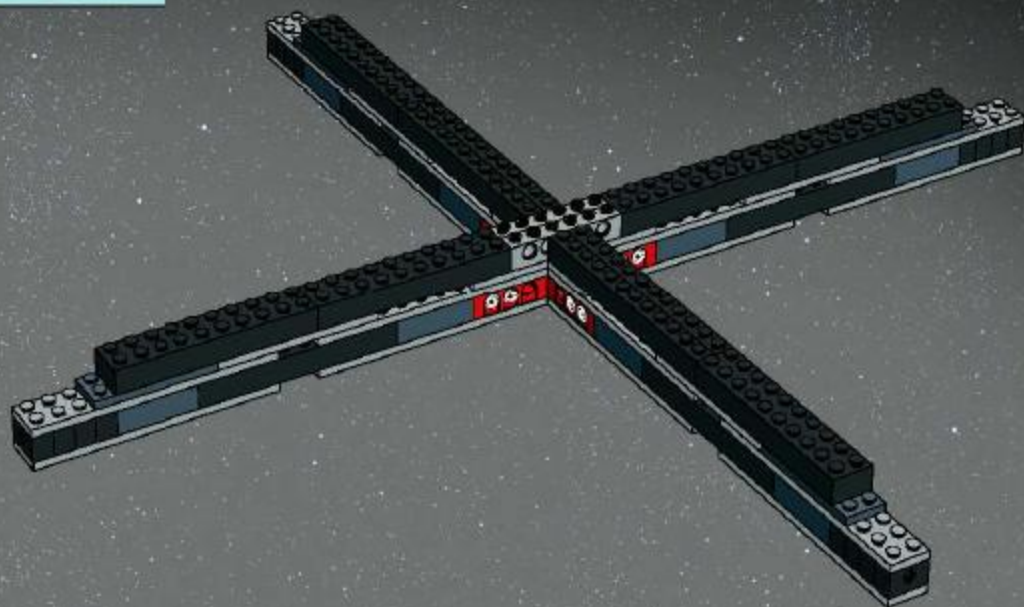

9

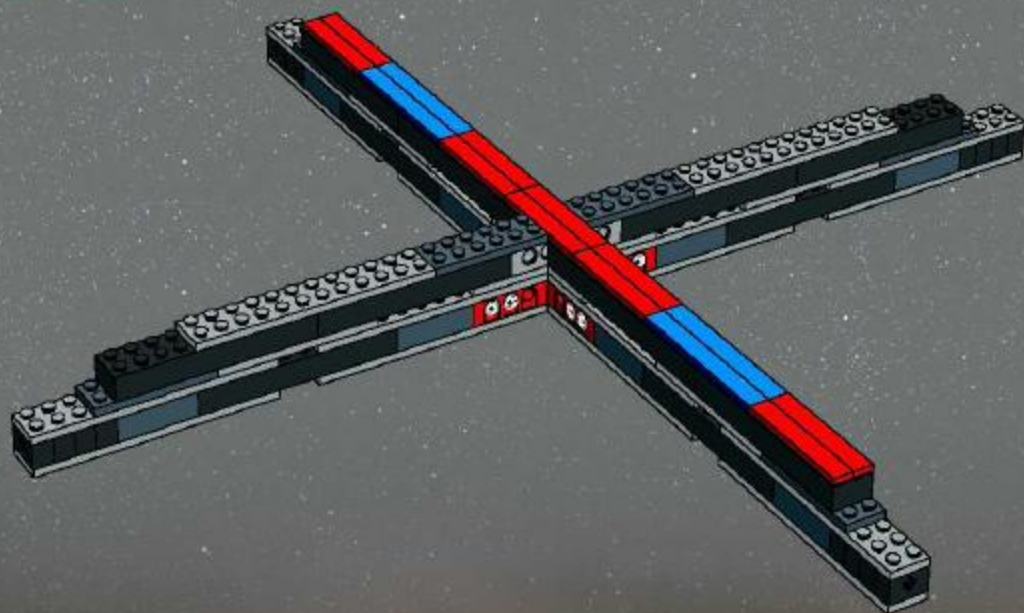



10

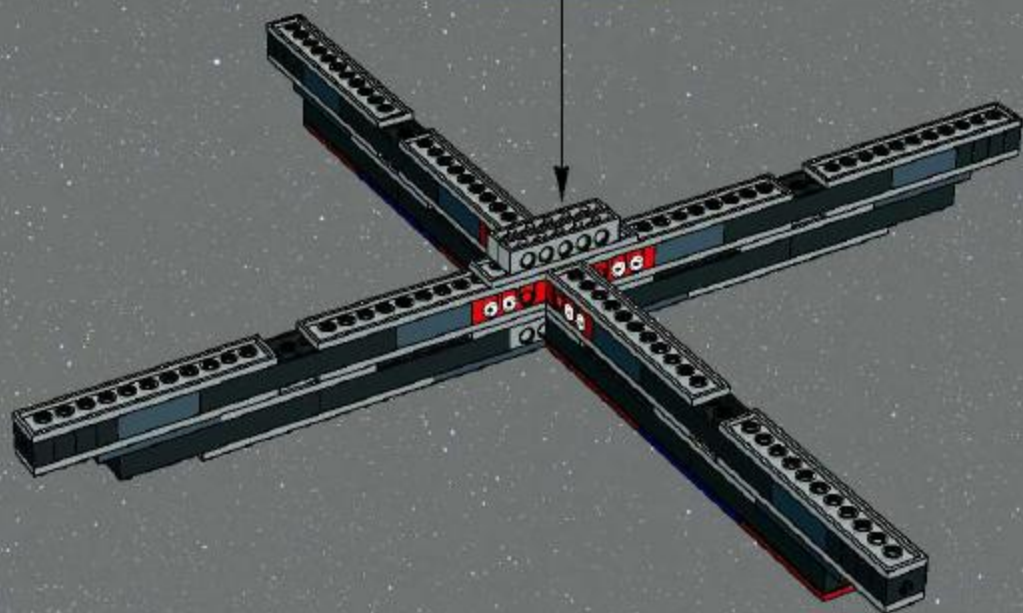
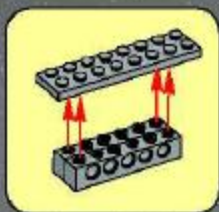

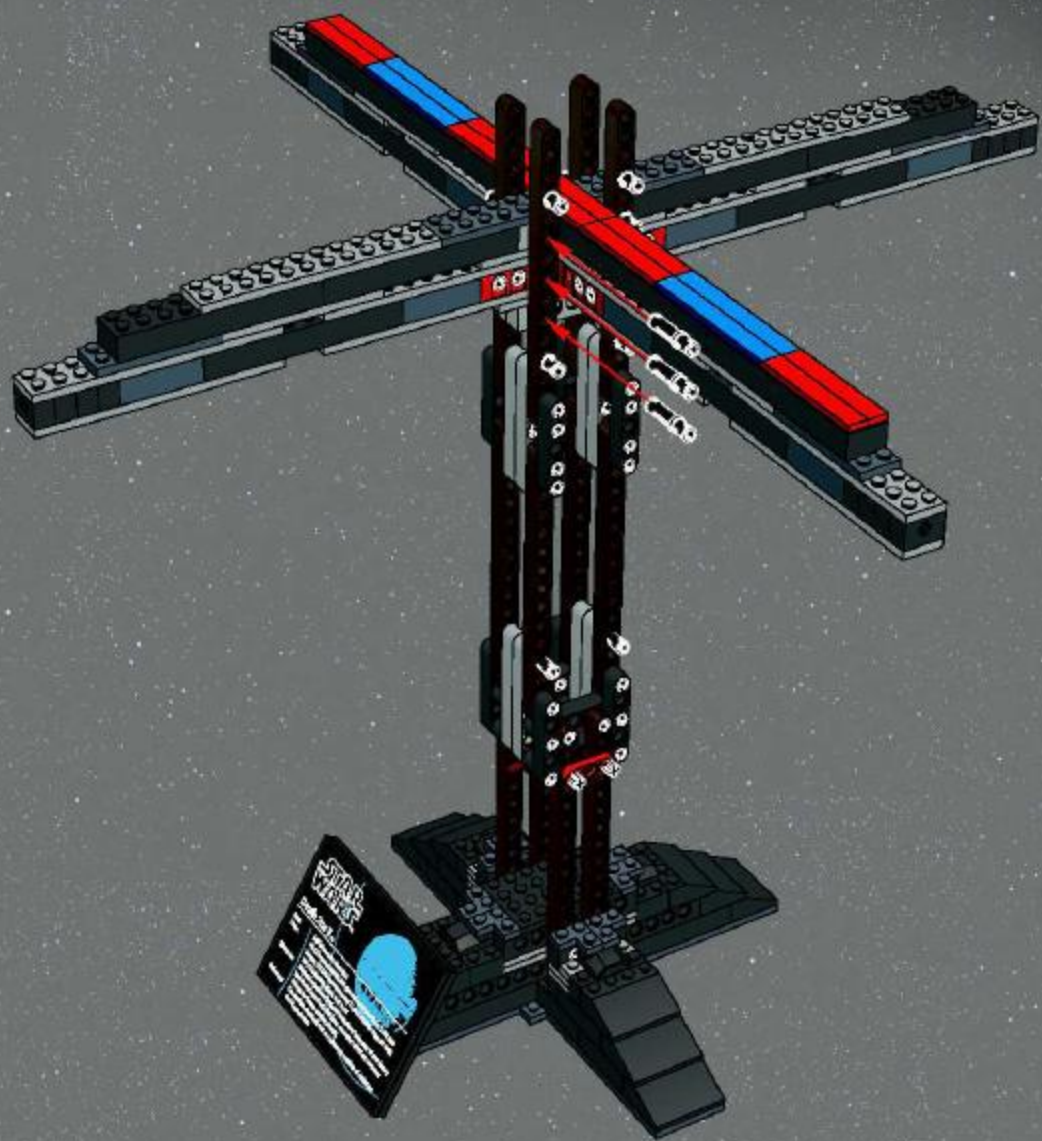



13

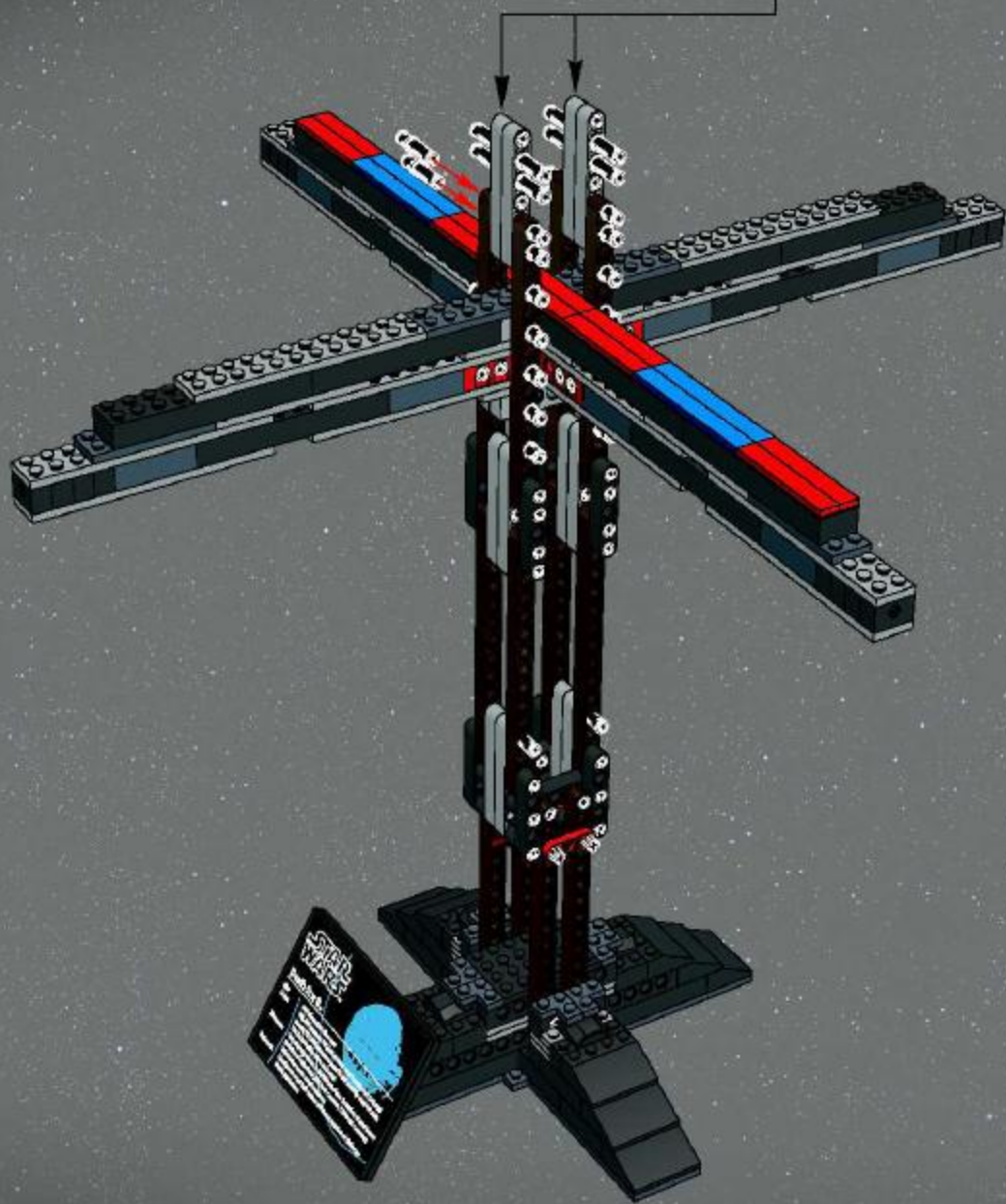
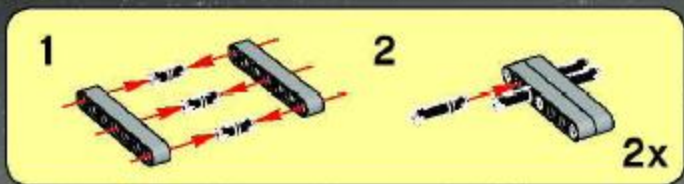



14

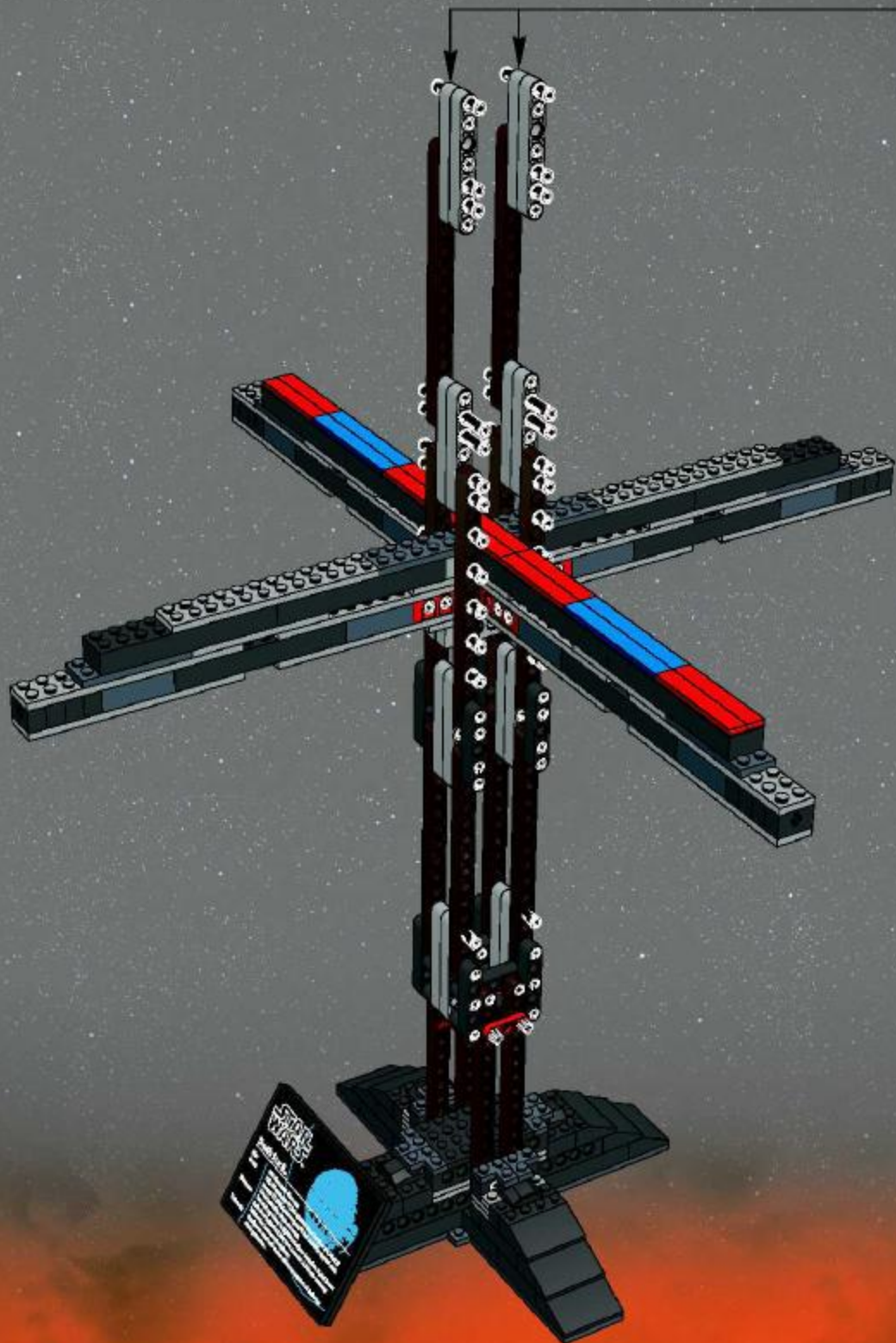
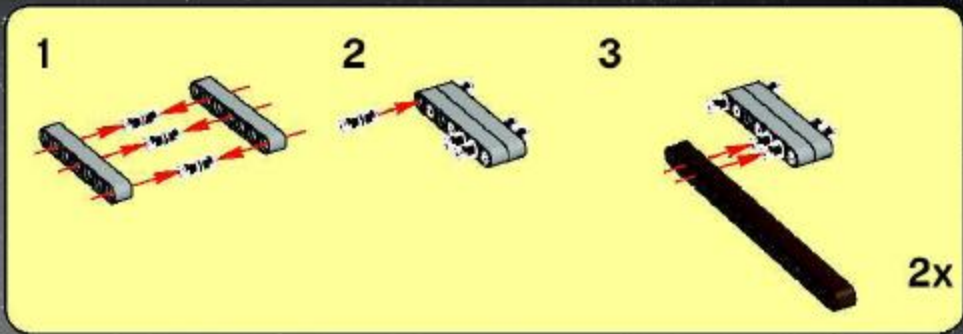

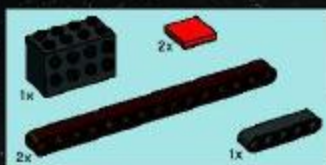

15

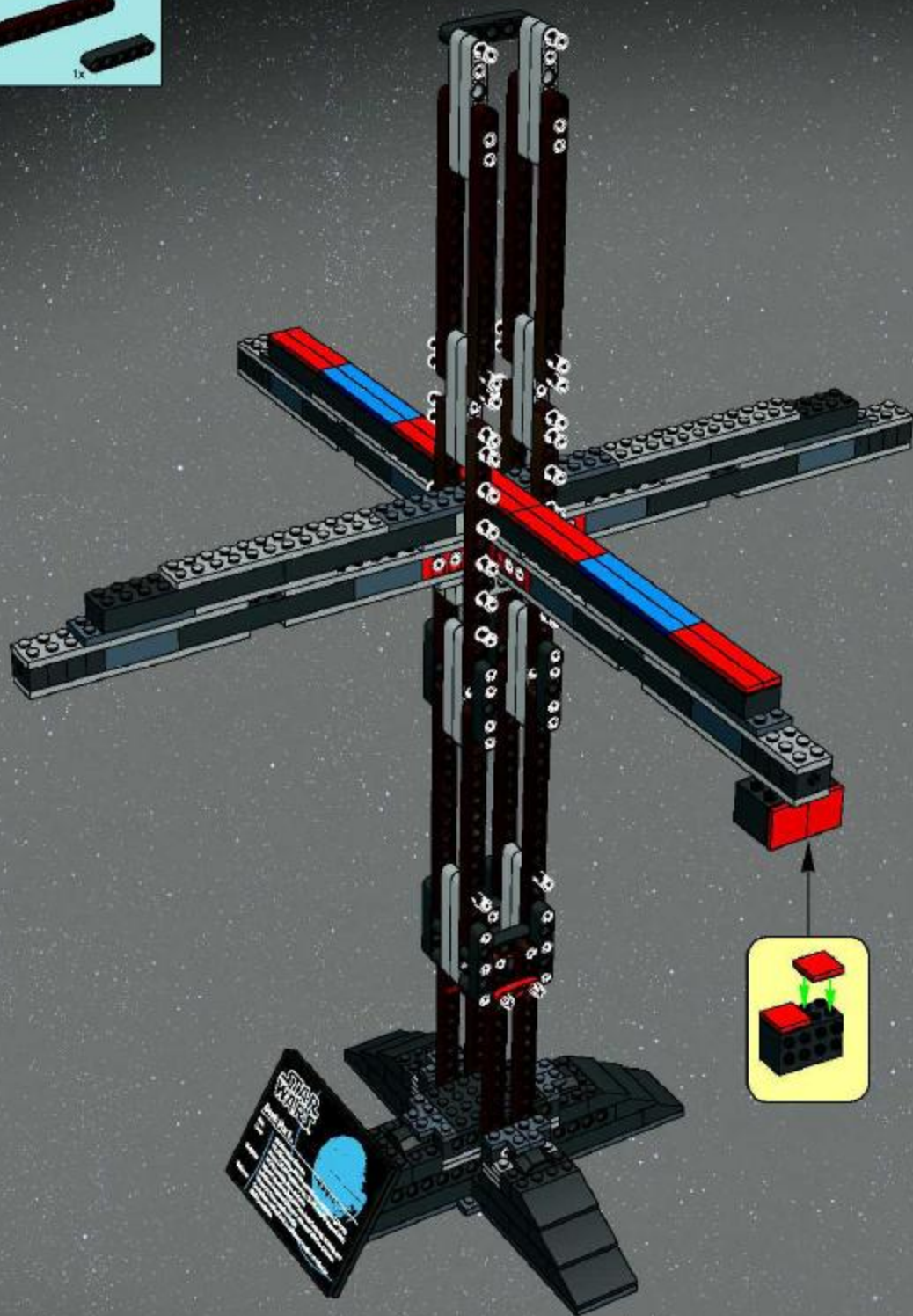



1:1

16

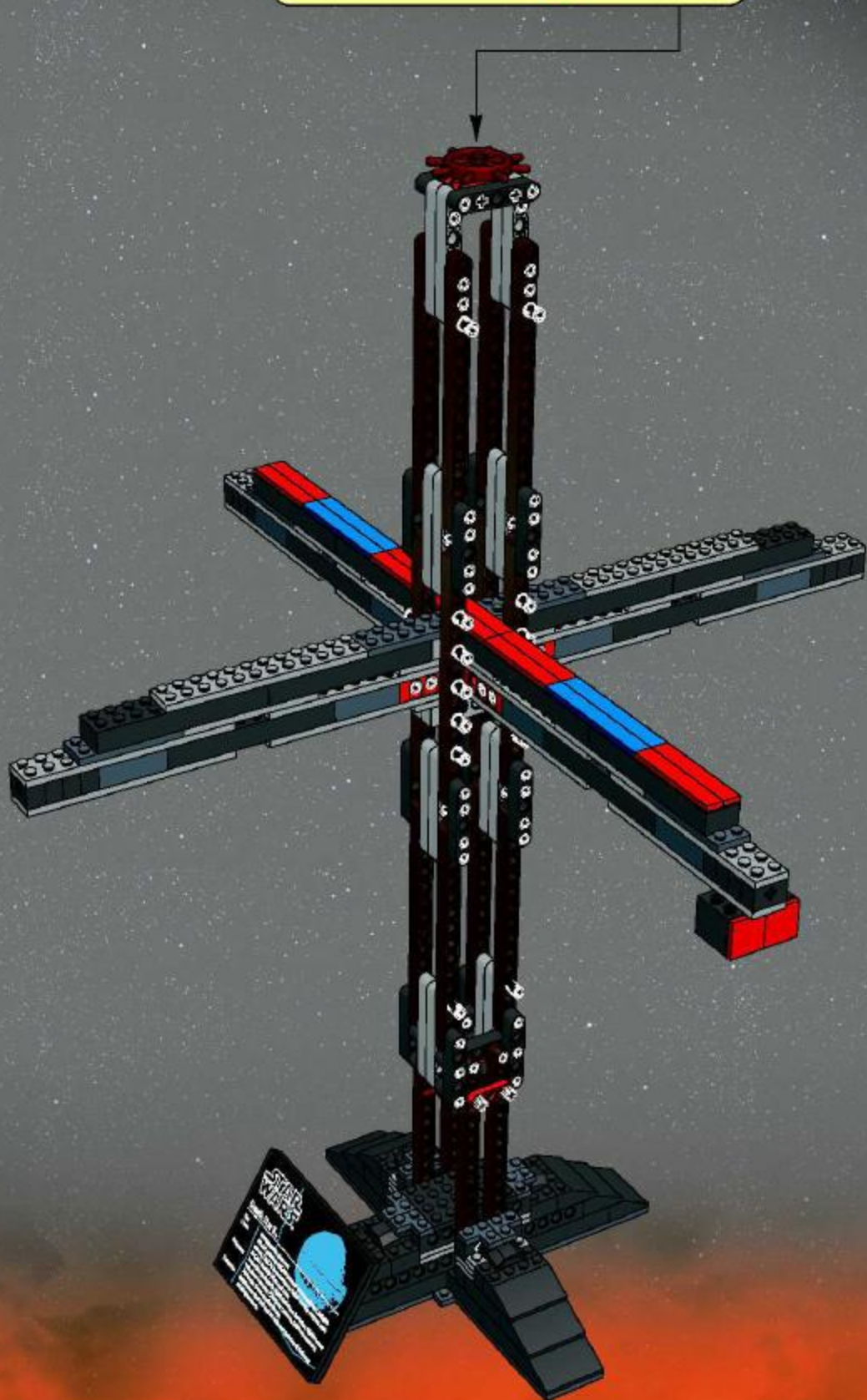
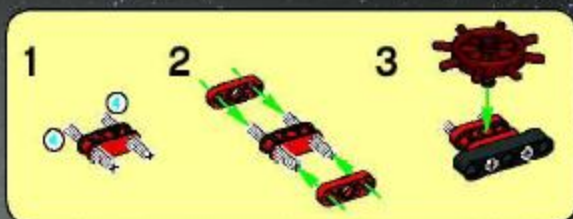

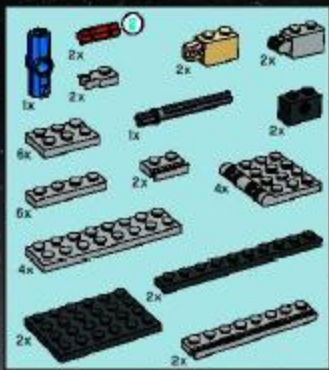

1:1

17

1

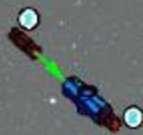

2



3



4



5

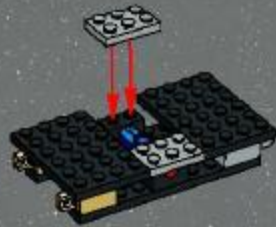

6



7



8



3x





18

1



2



3

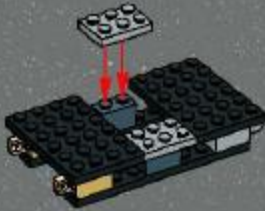

4



5



6



6x

7

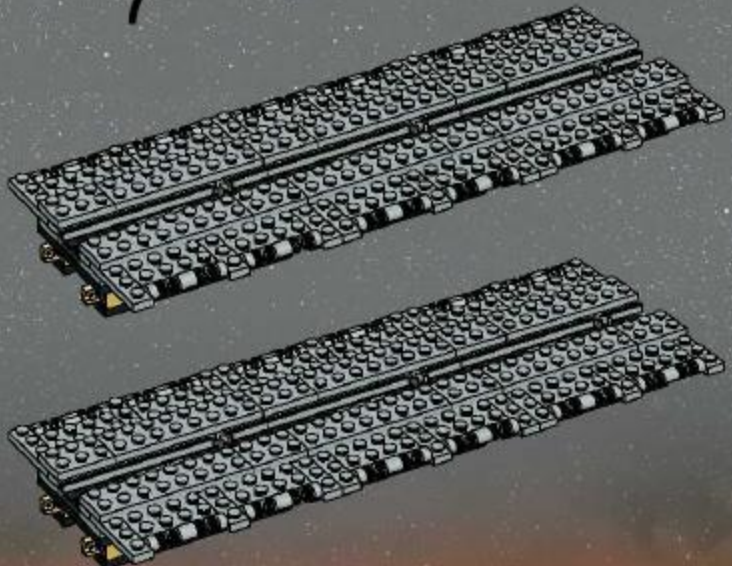

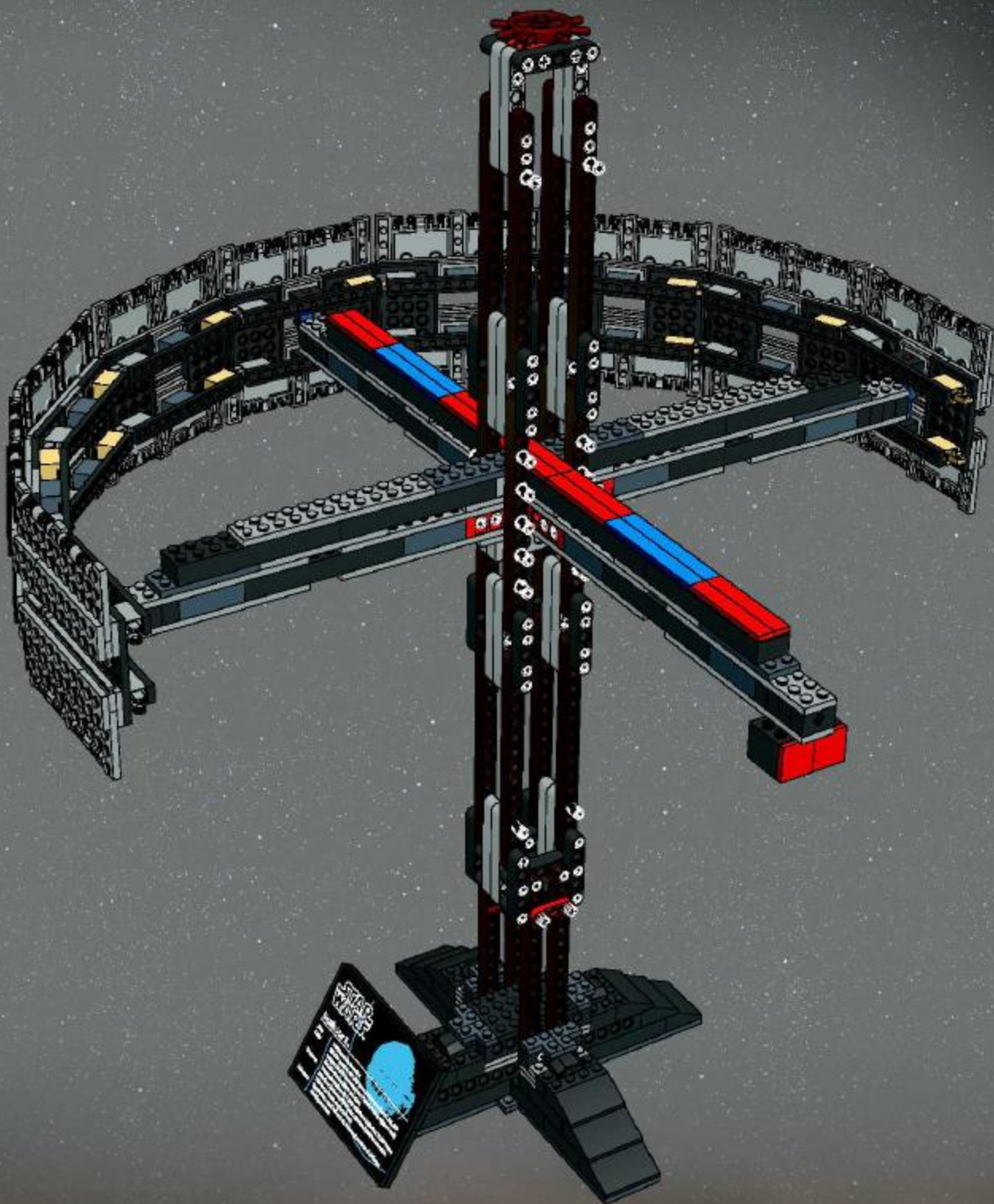



1



2



3



4

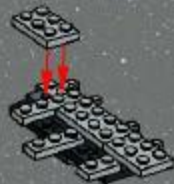

5

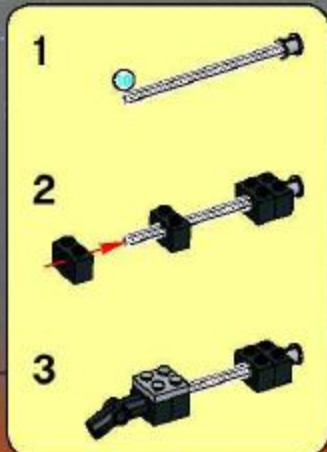

1

2

3



6

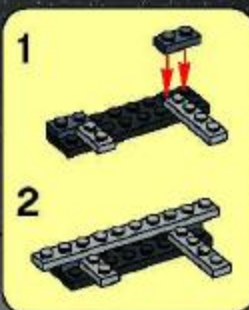
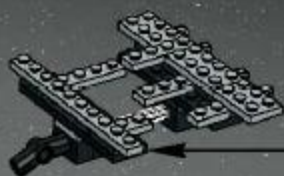

7

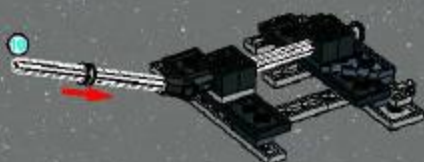

8



9



19

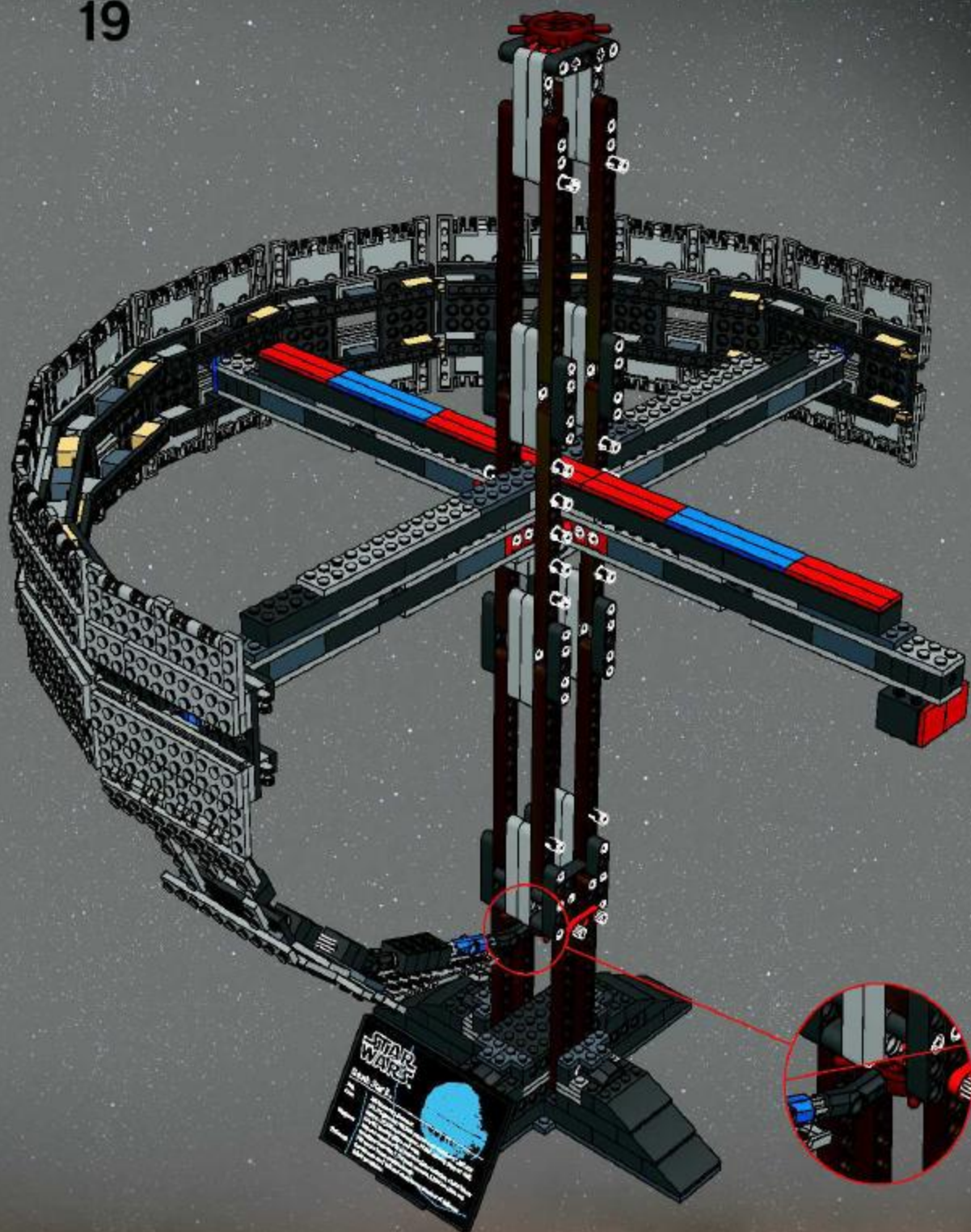



1



2



3



4

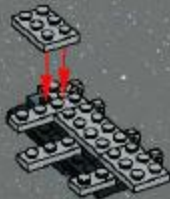

5

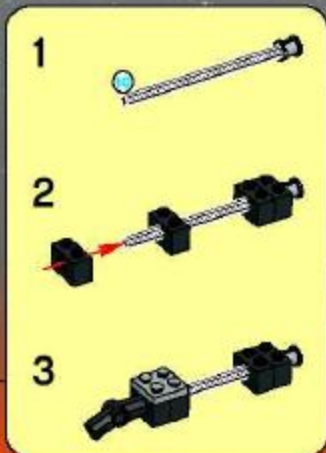



6

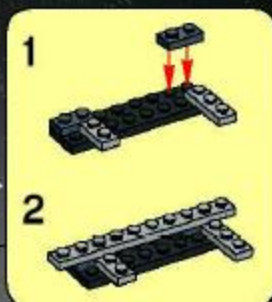

7

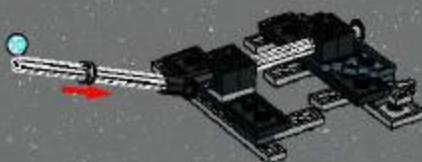

8



9

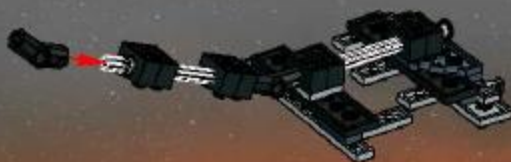

20

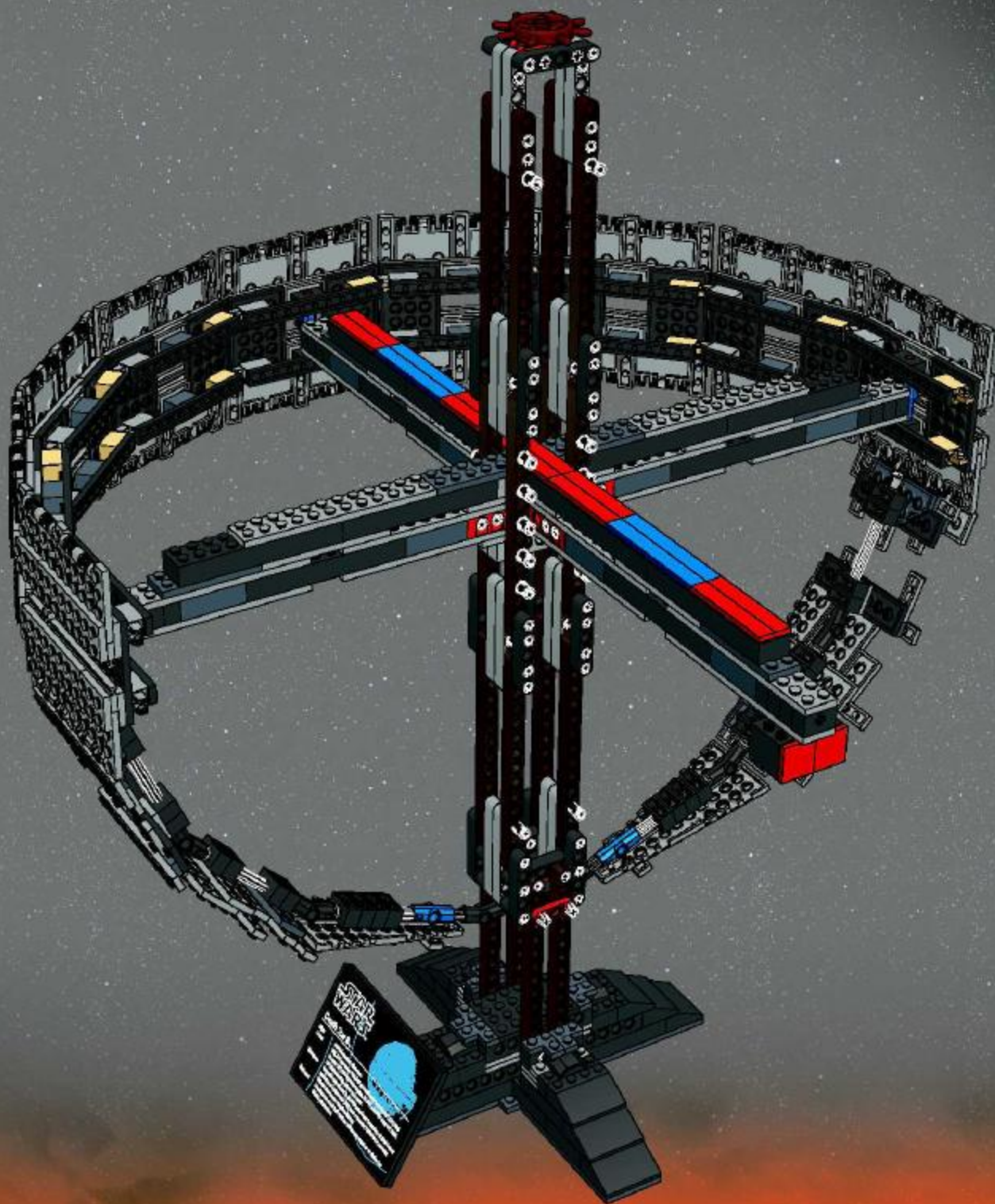



4x



1



2



3



4



5



1



2



3



6



7



8



9



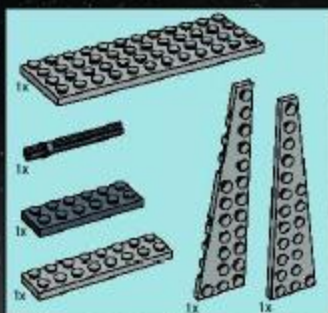

10

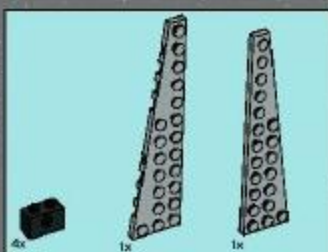
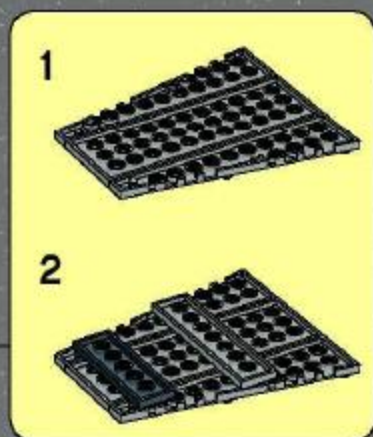
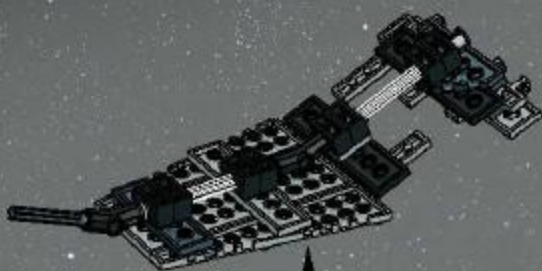

11

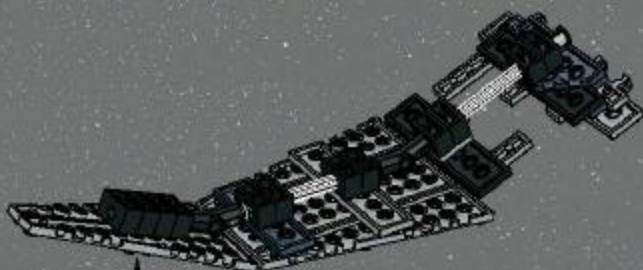

4x

21

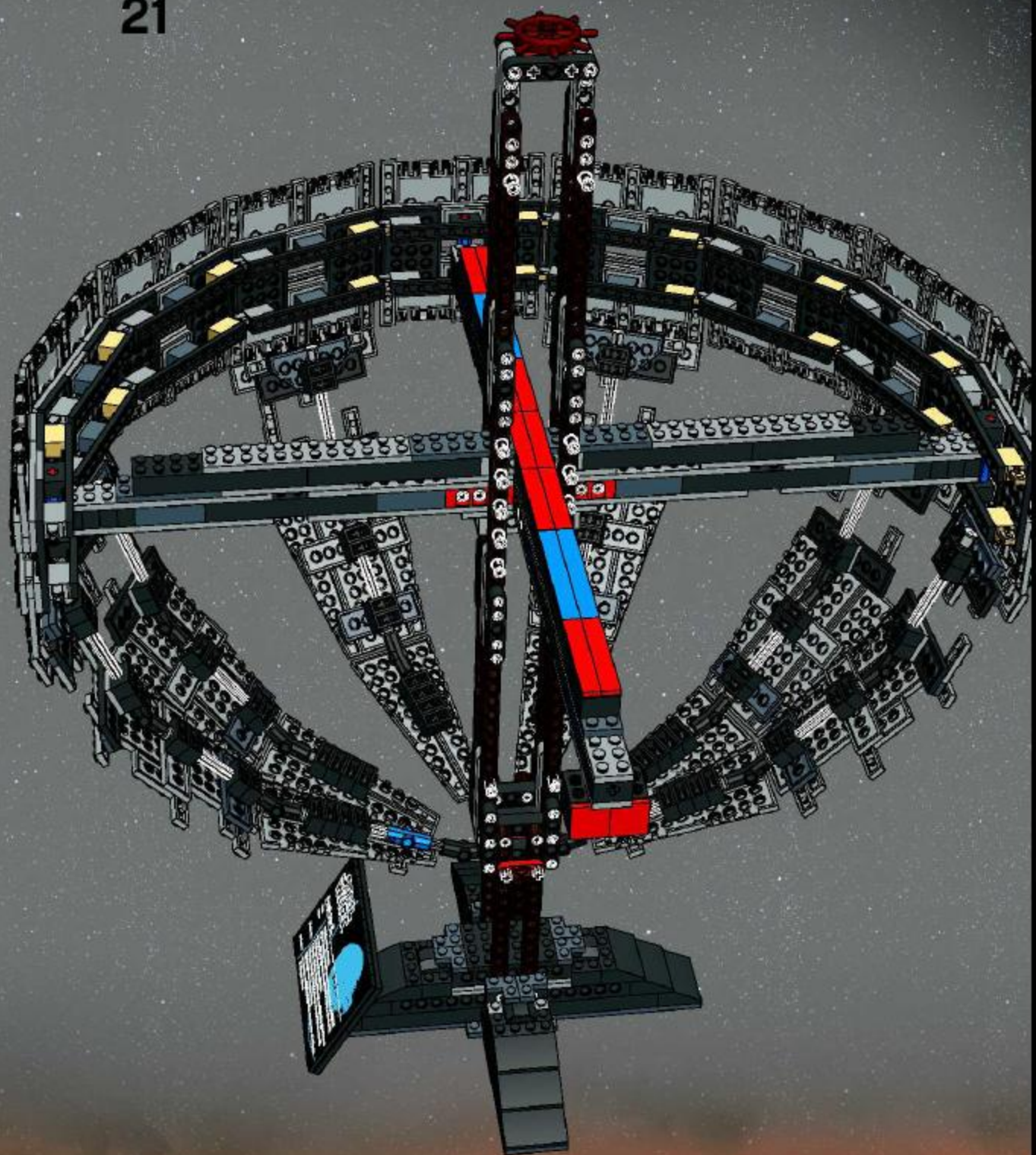

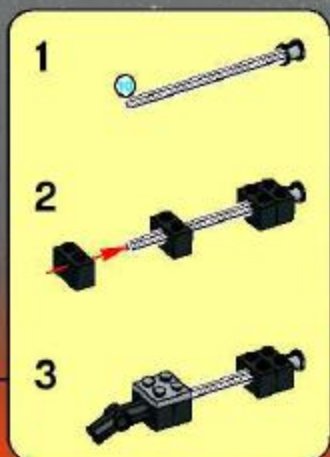



6

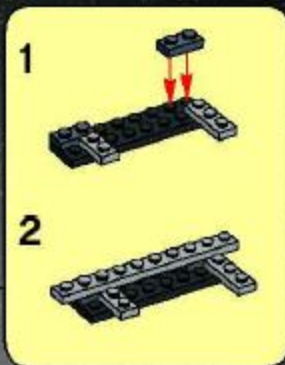

7



8



9



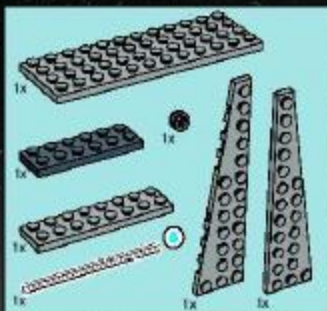

○ 1:1

10

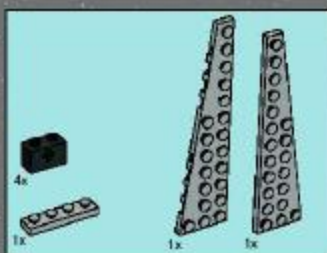
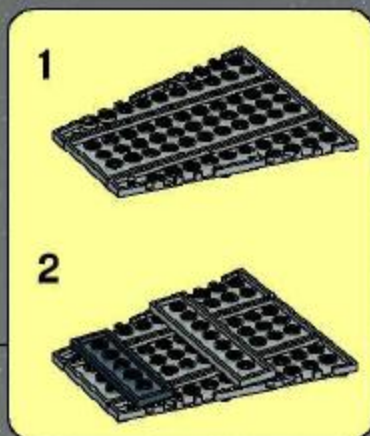

11



12

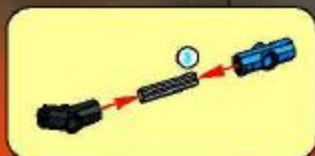

3x

22

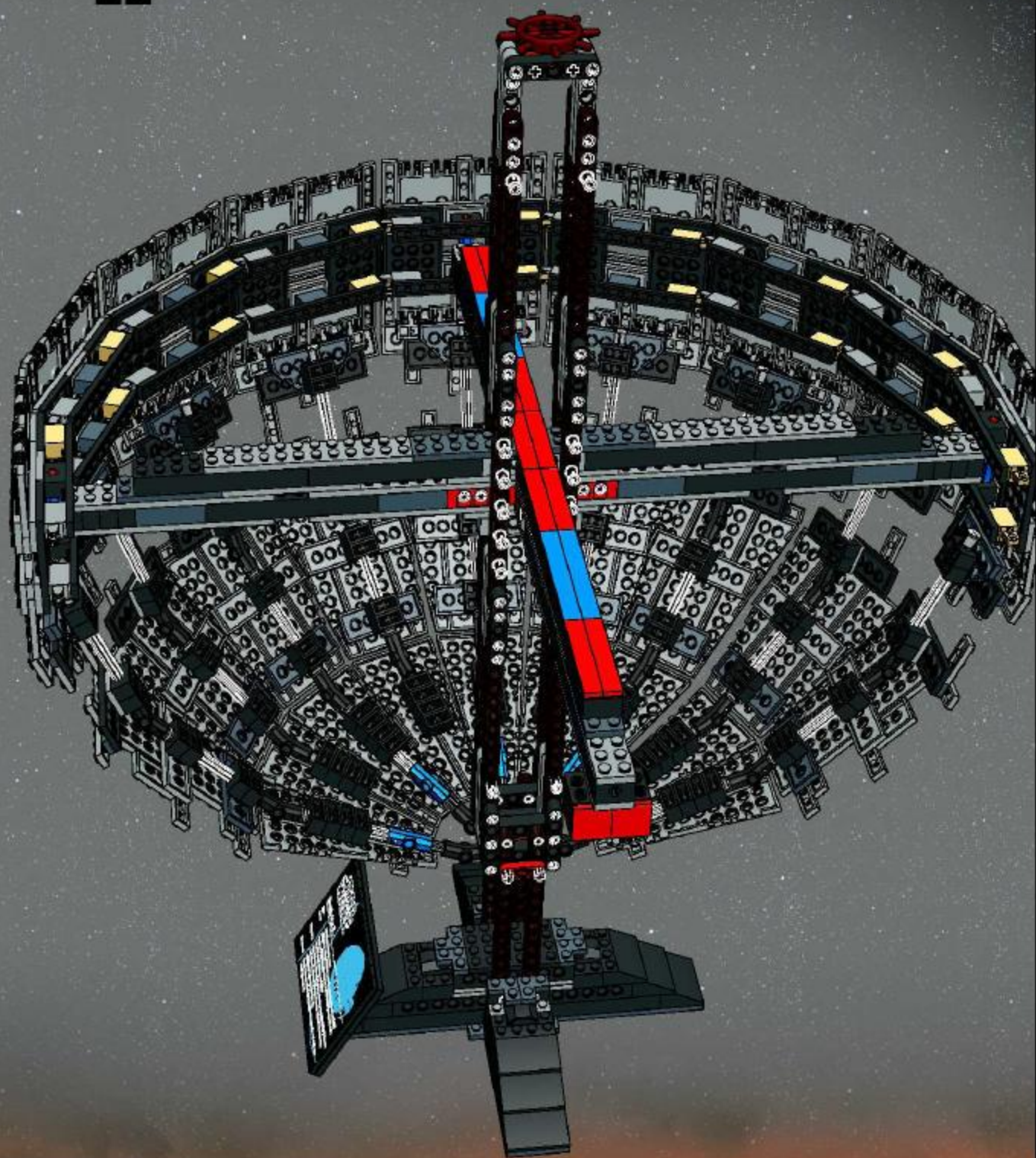

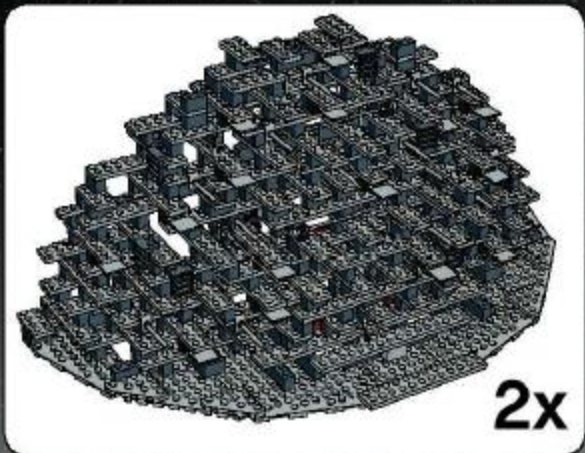

2x

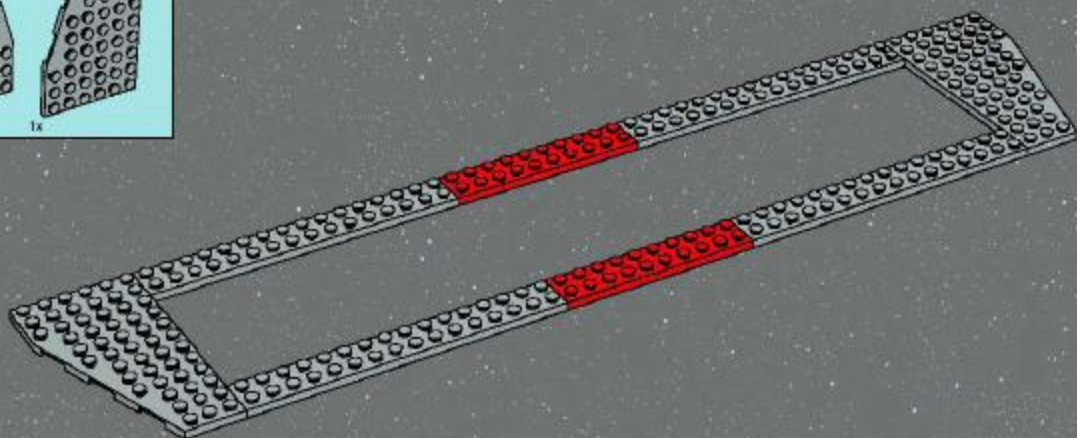
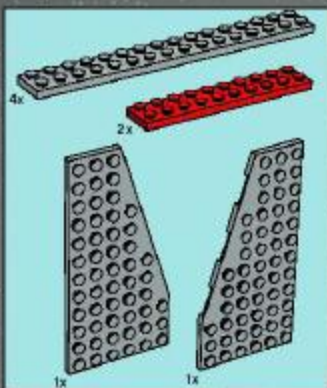

1

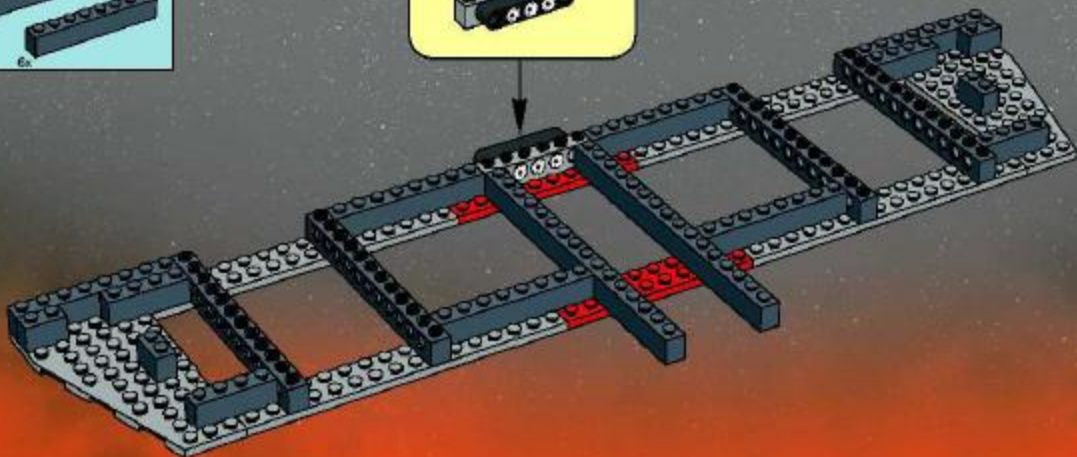
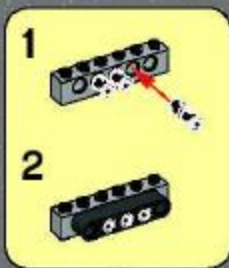
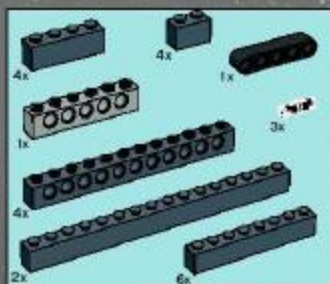

2

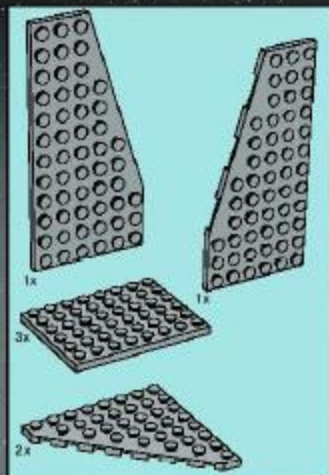

3

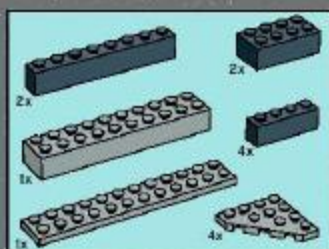
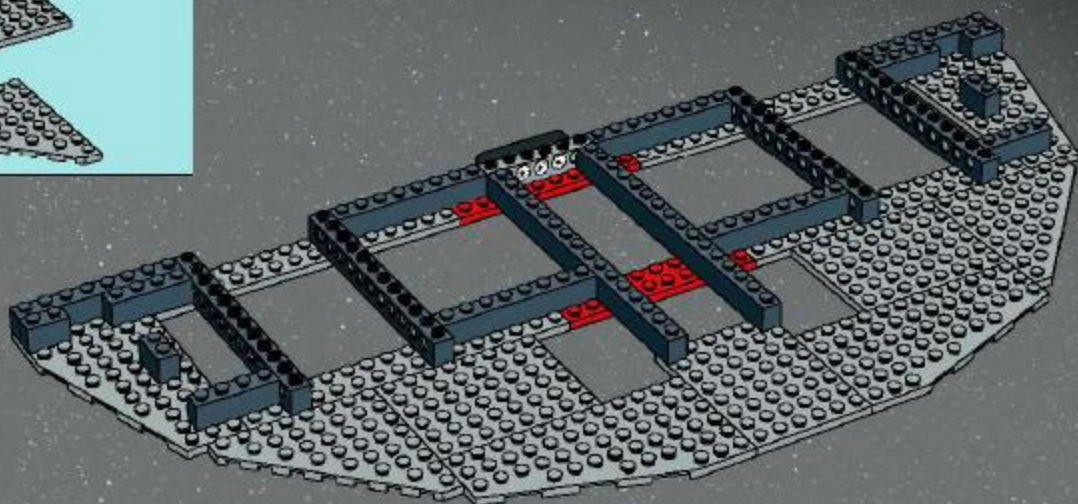

4

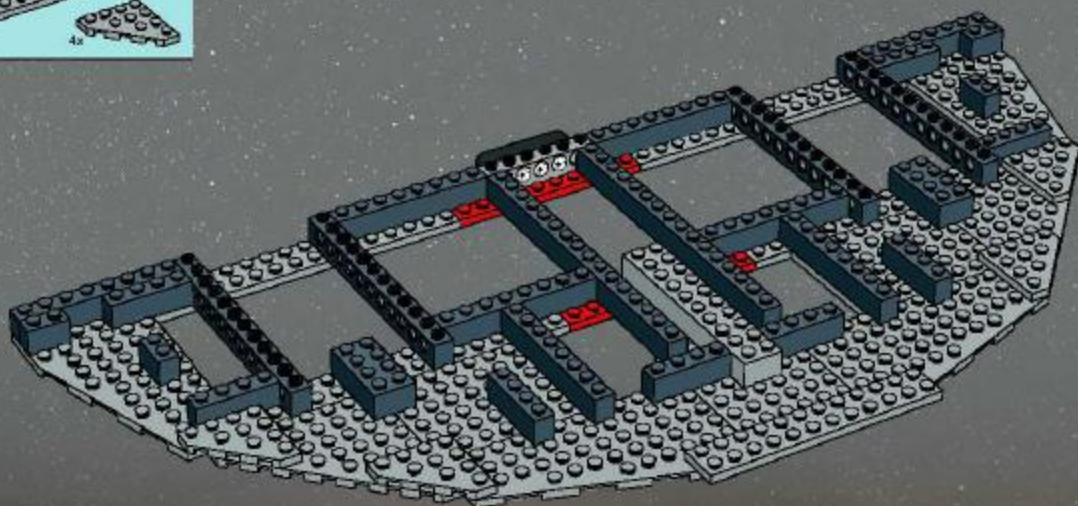

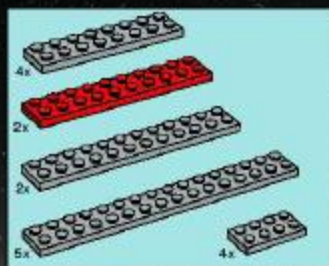

5

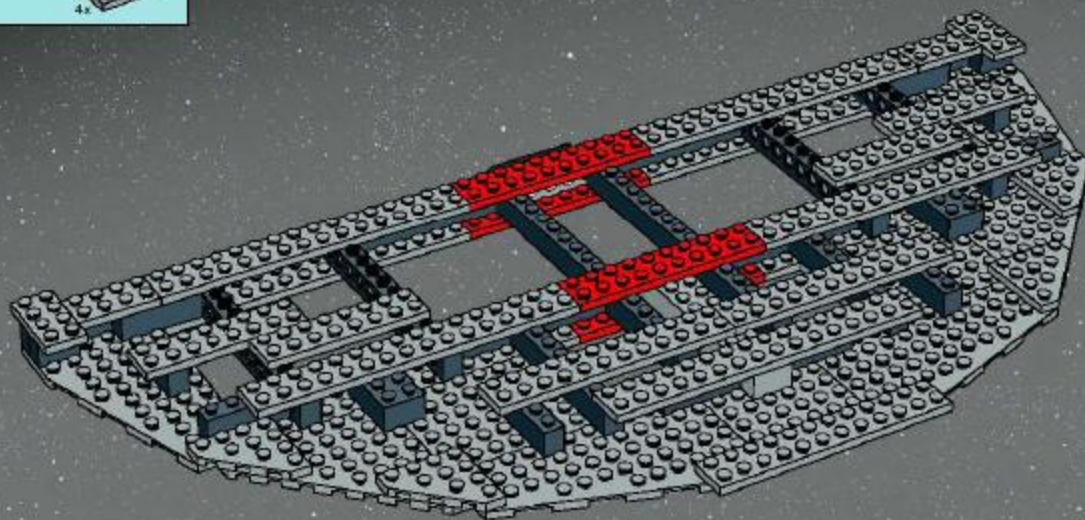

6

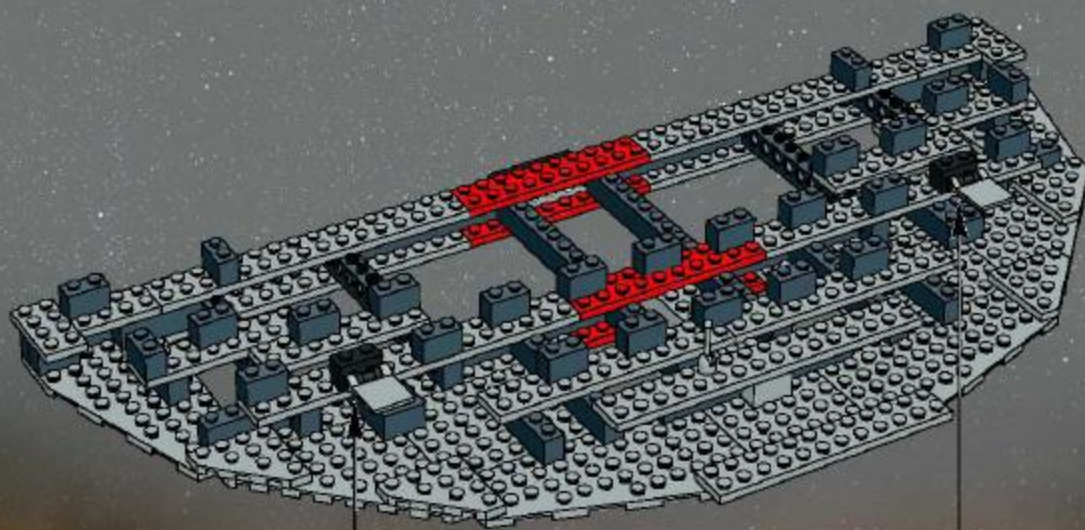



7

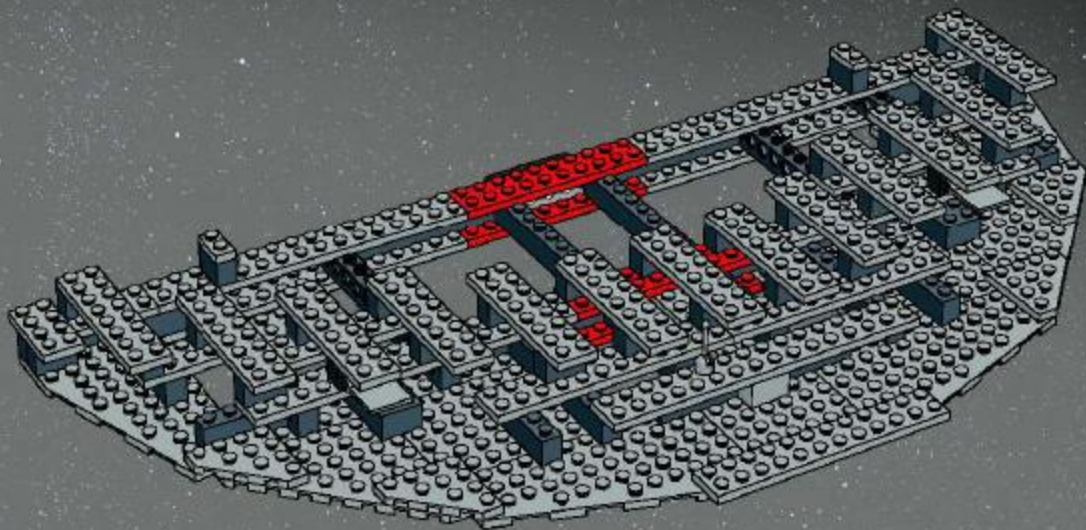

8

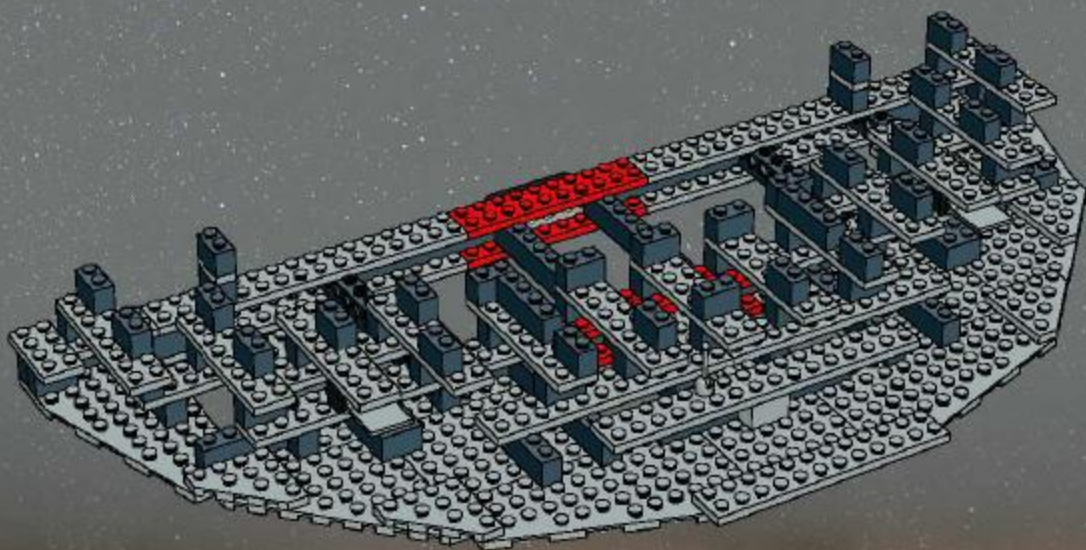

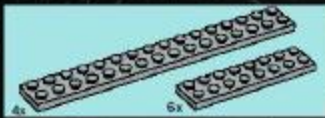

9

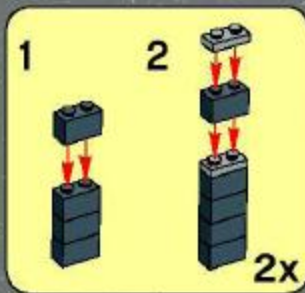
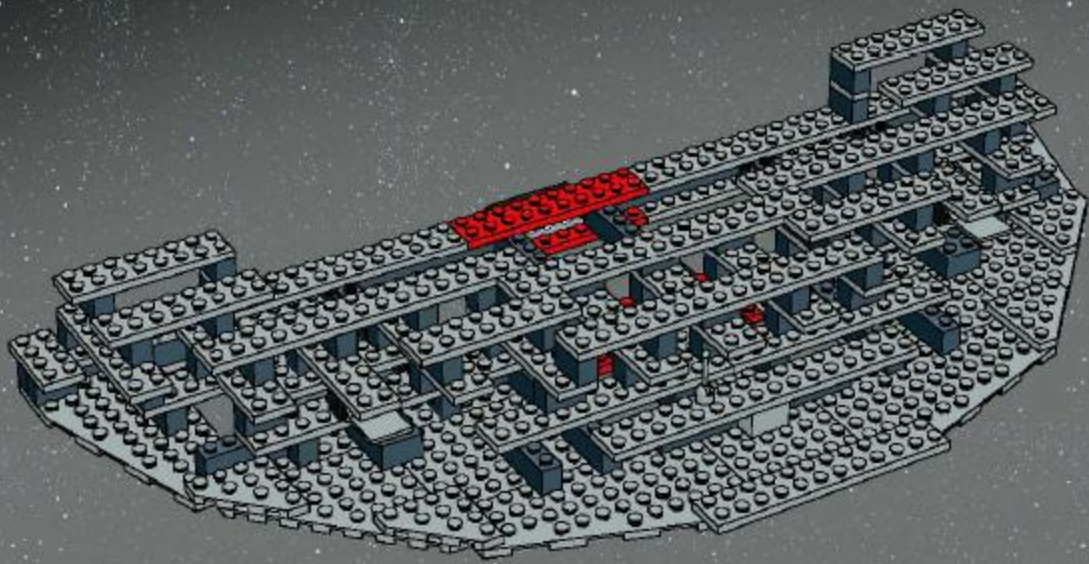

10

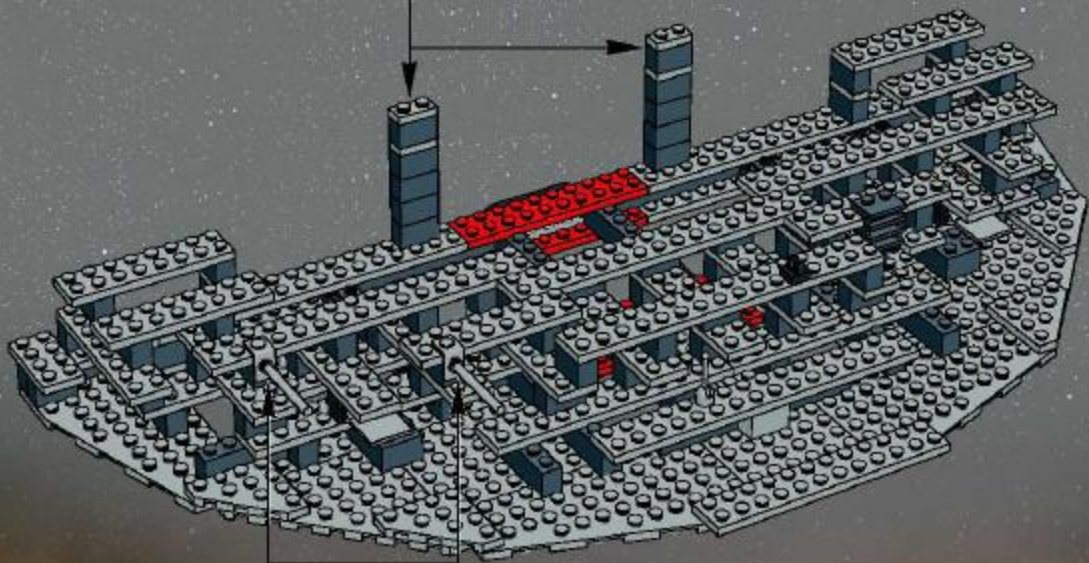

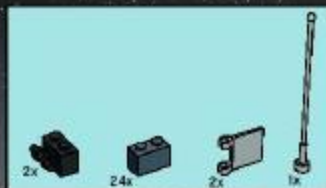

11

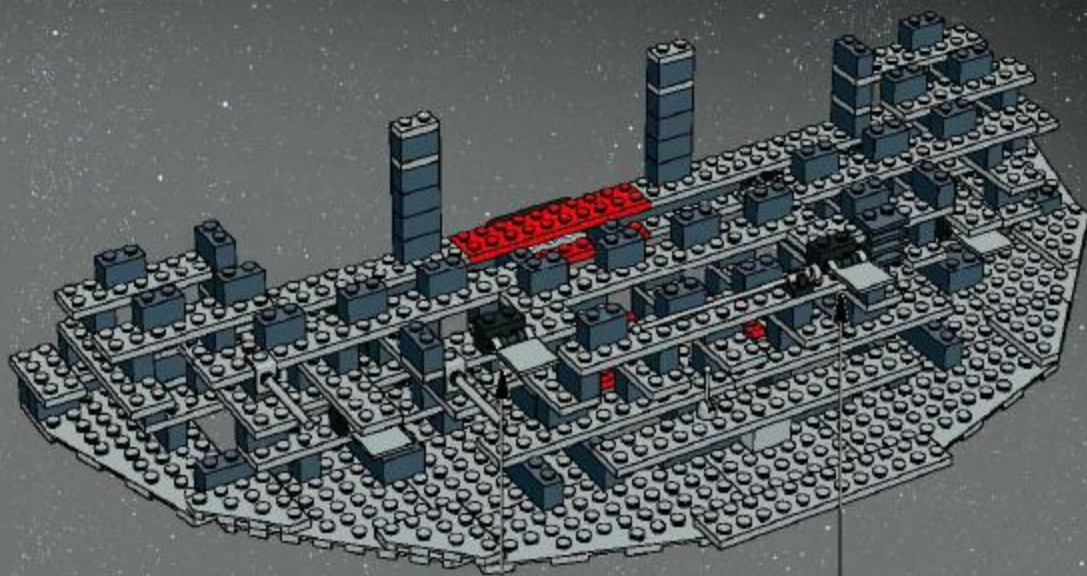

12

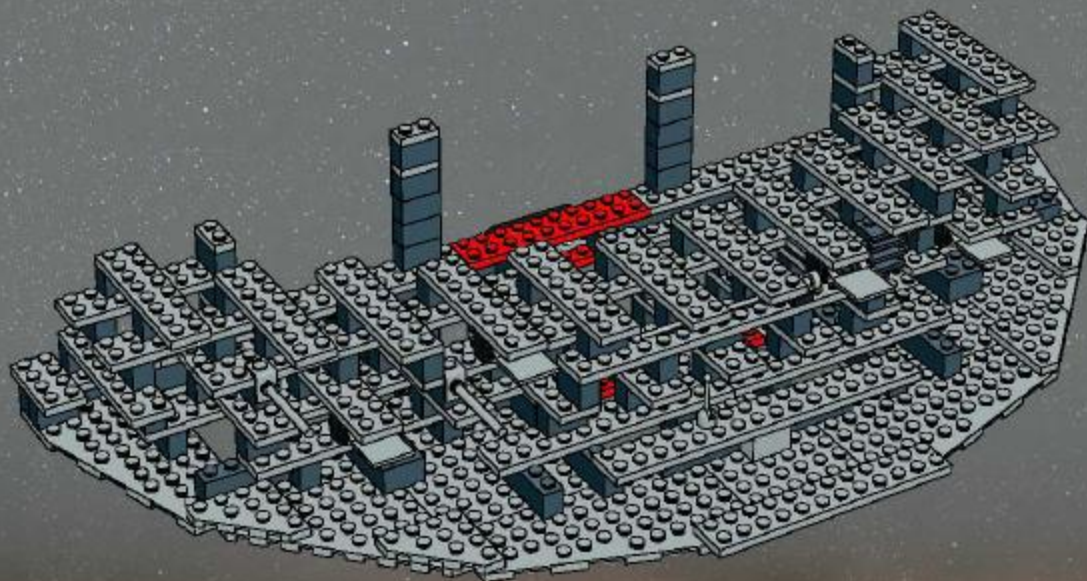



24x

13

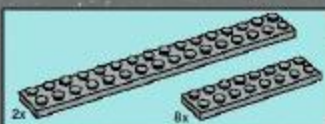
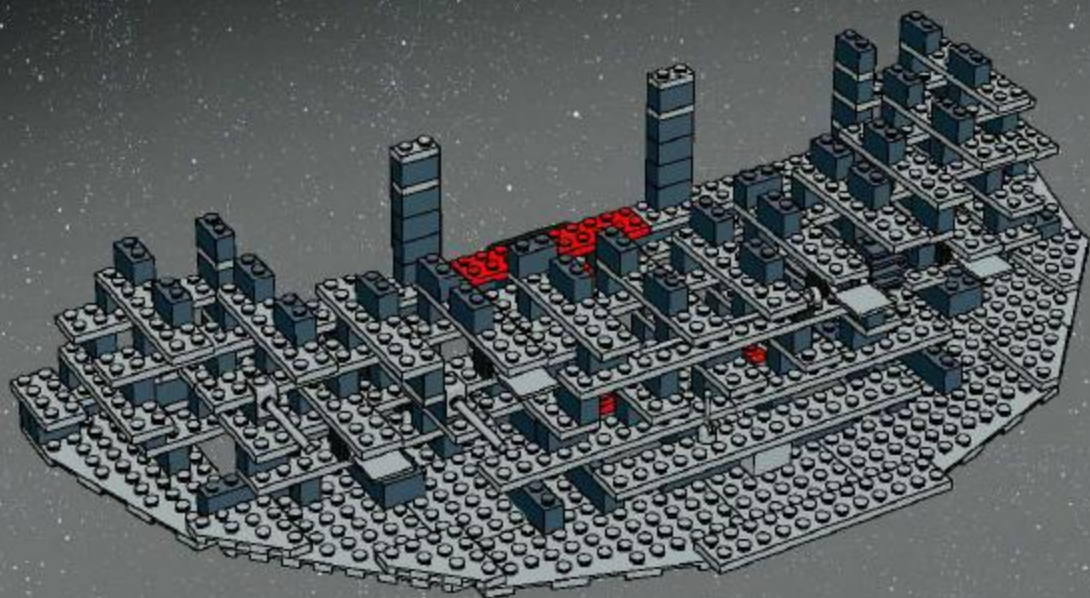

2x

1x

14

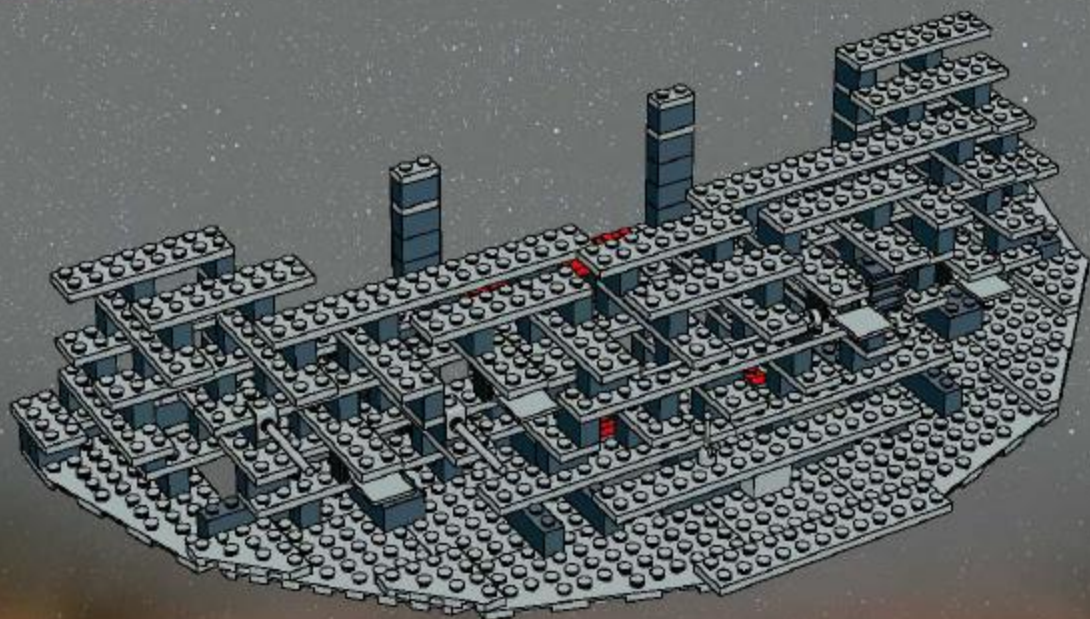

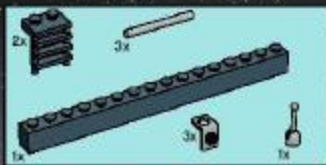

15

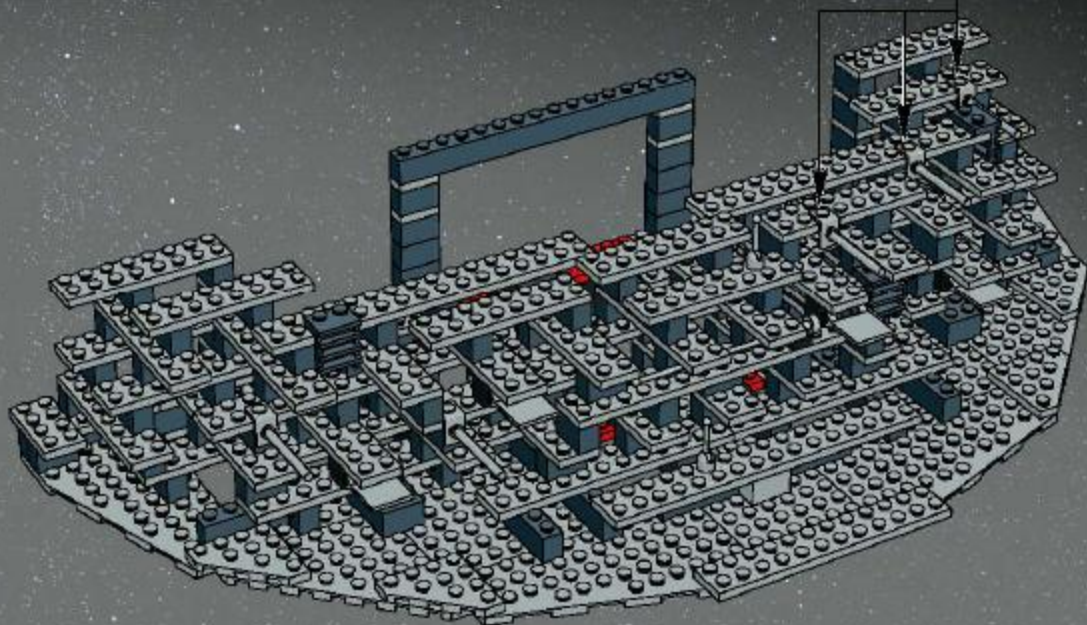

16

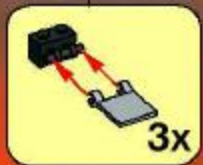
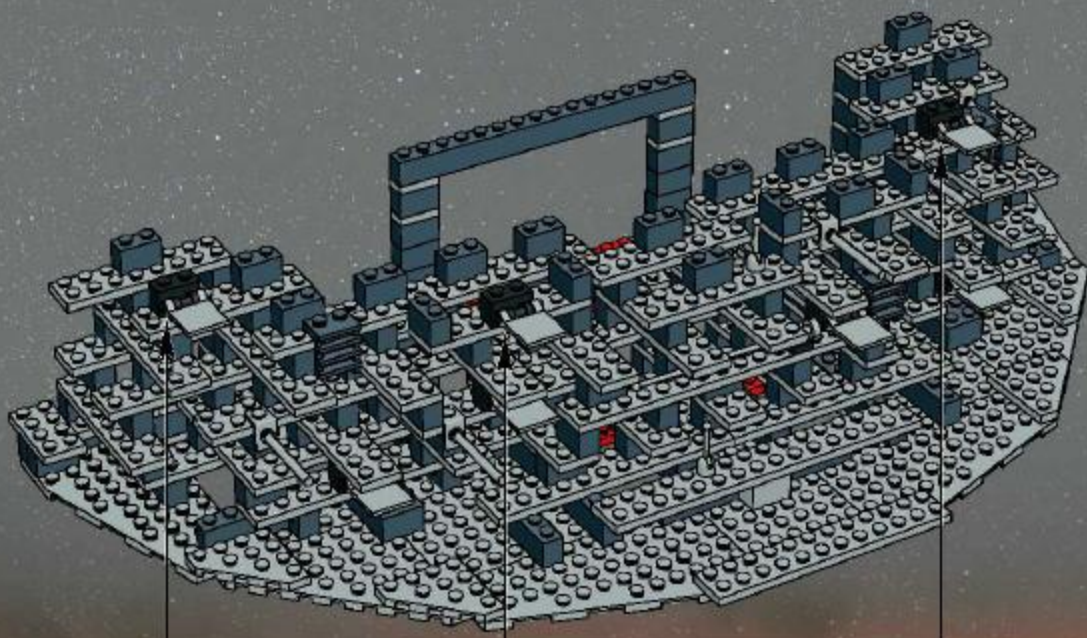



1x

17

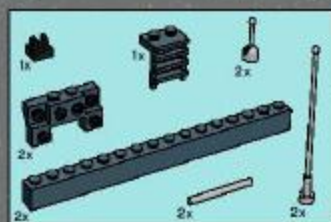
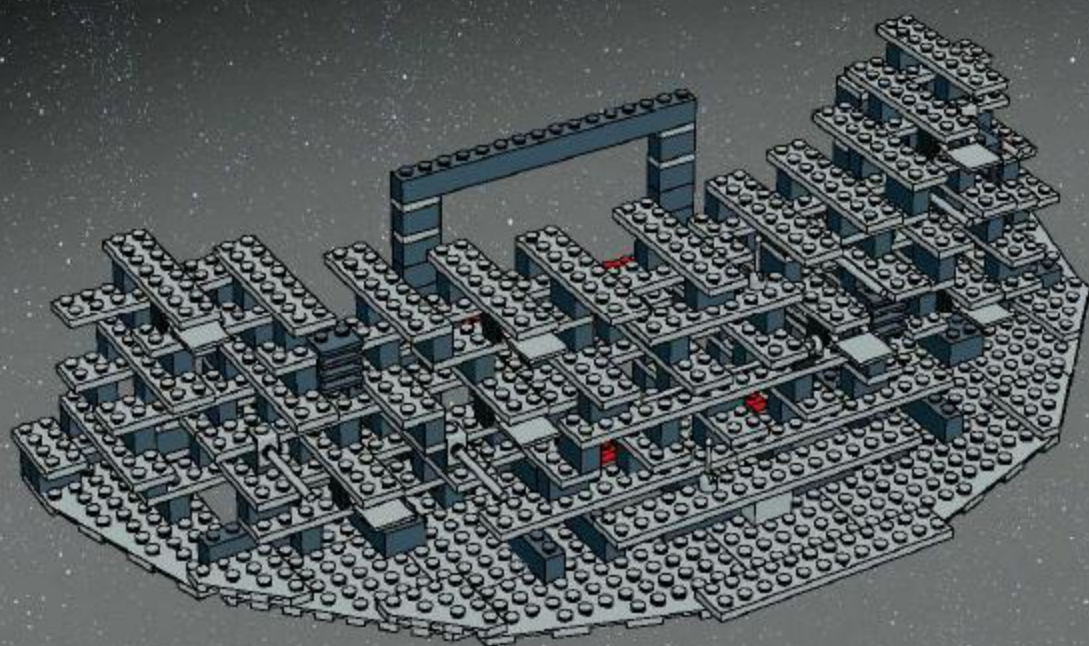

18

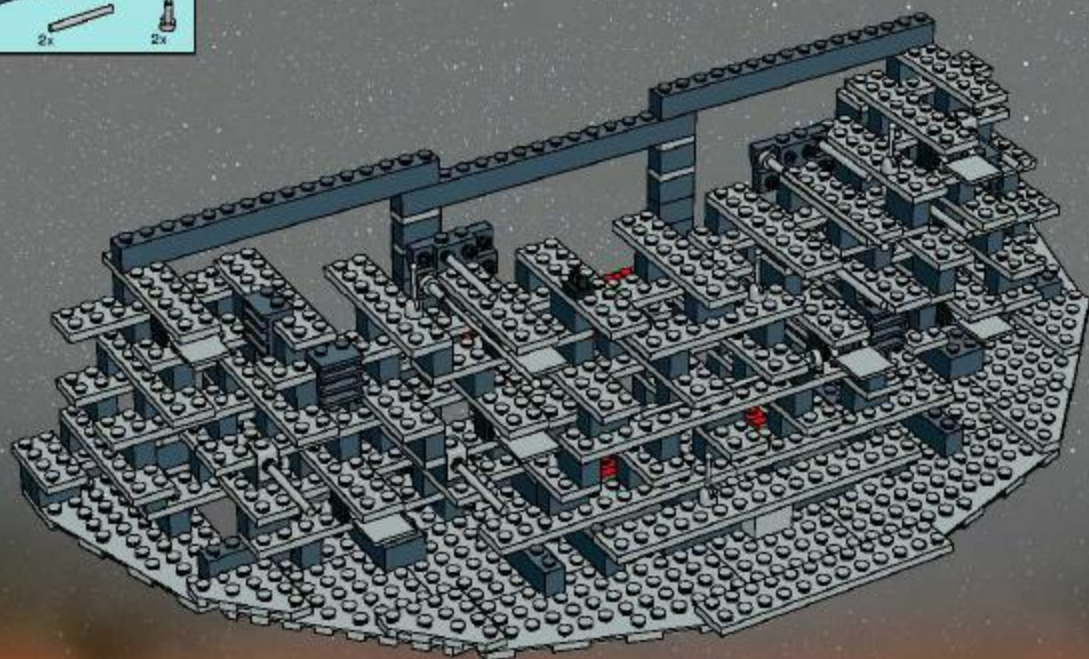

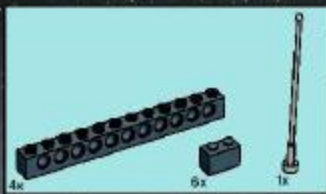

19

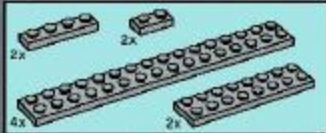
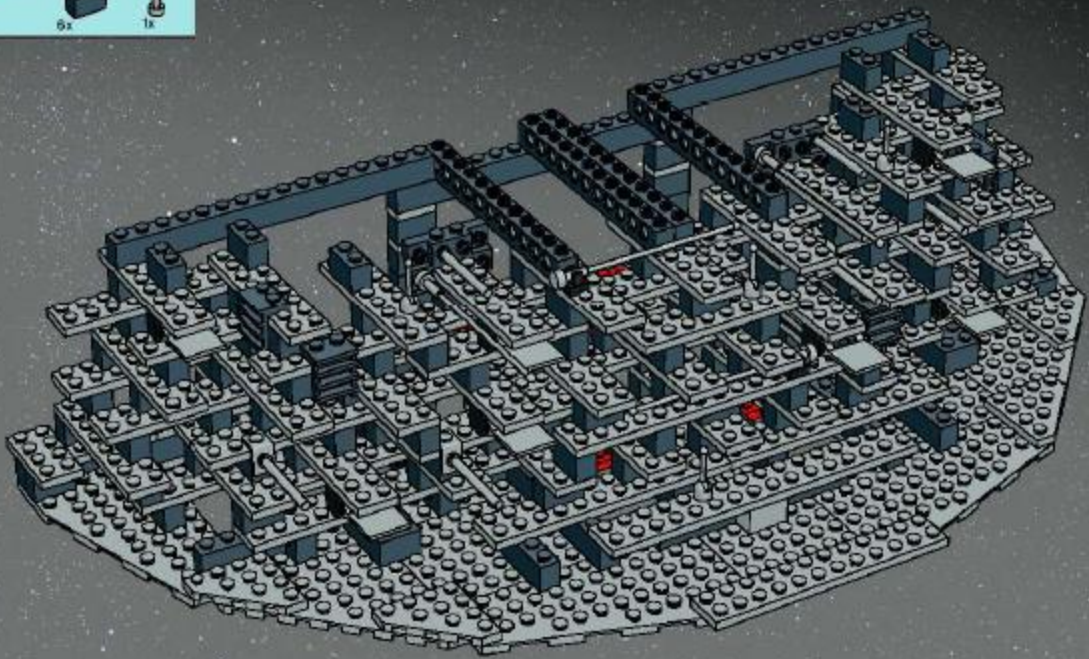

20

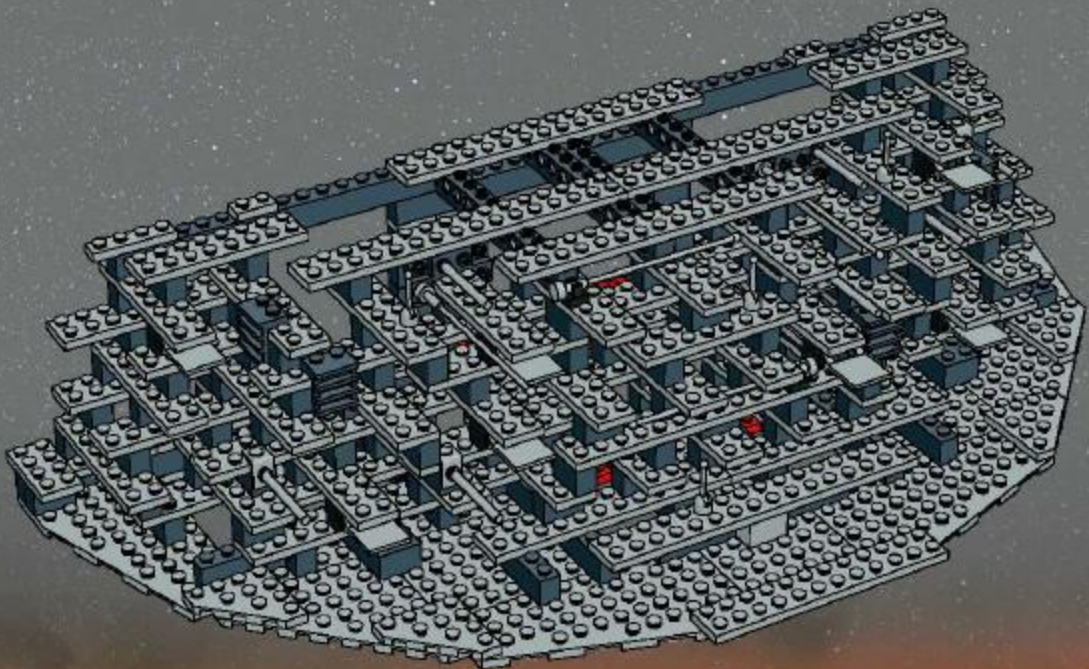



21

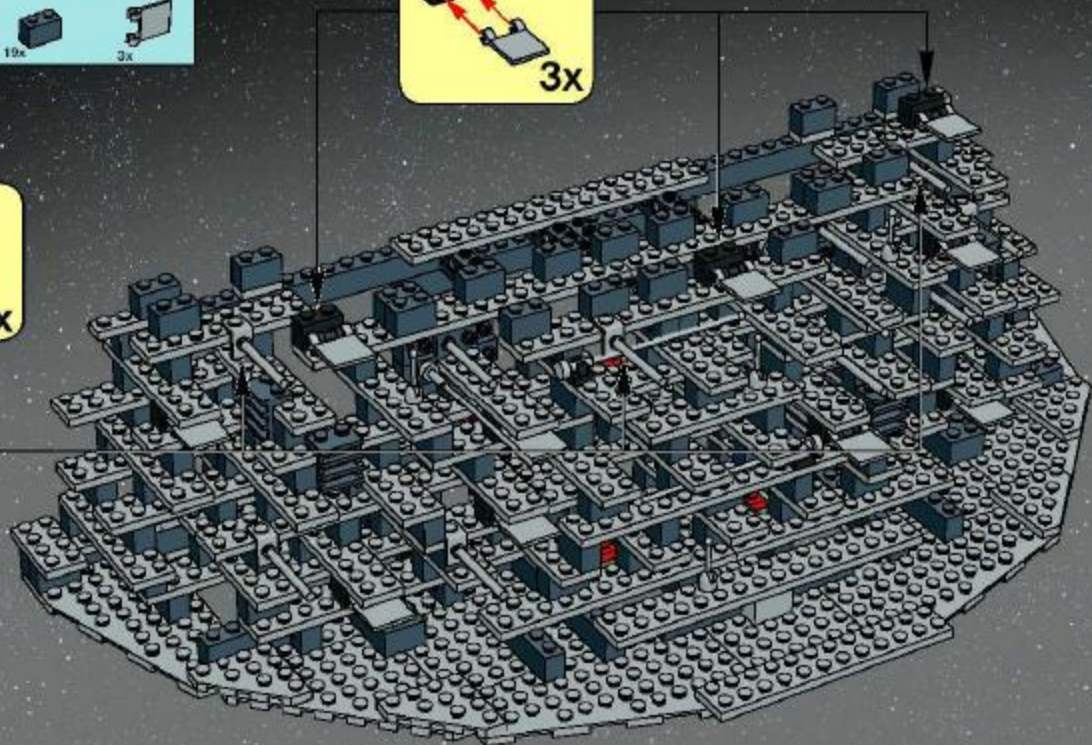

22

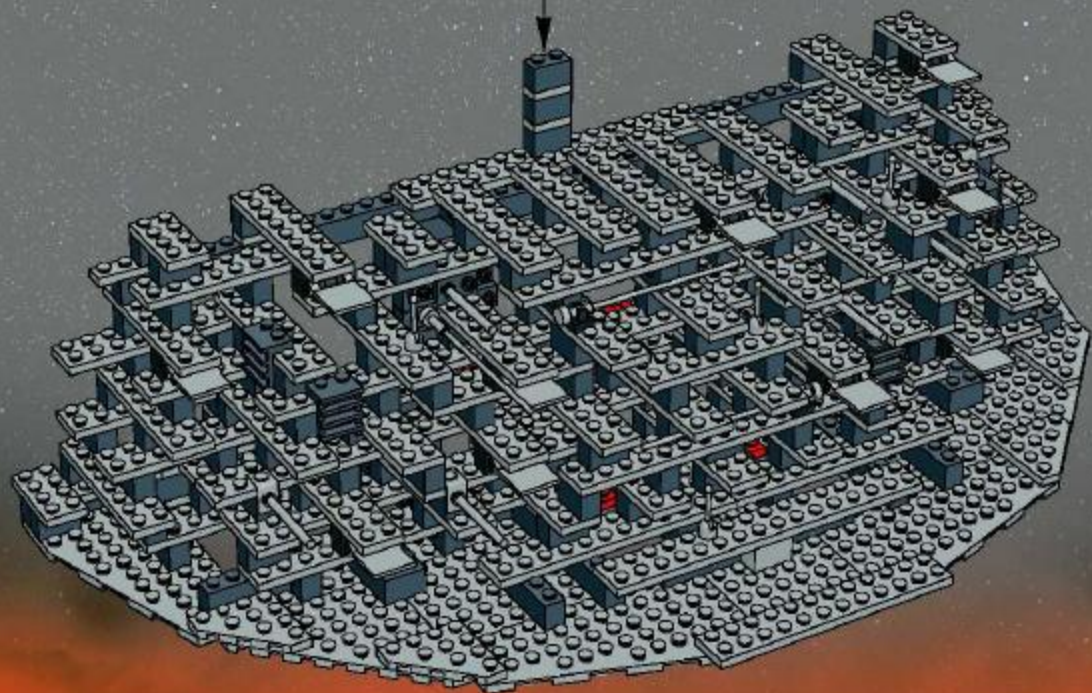
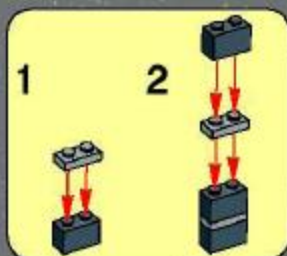



23

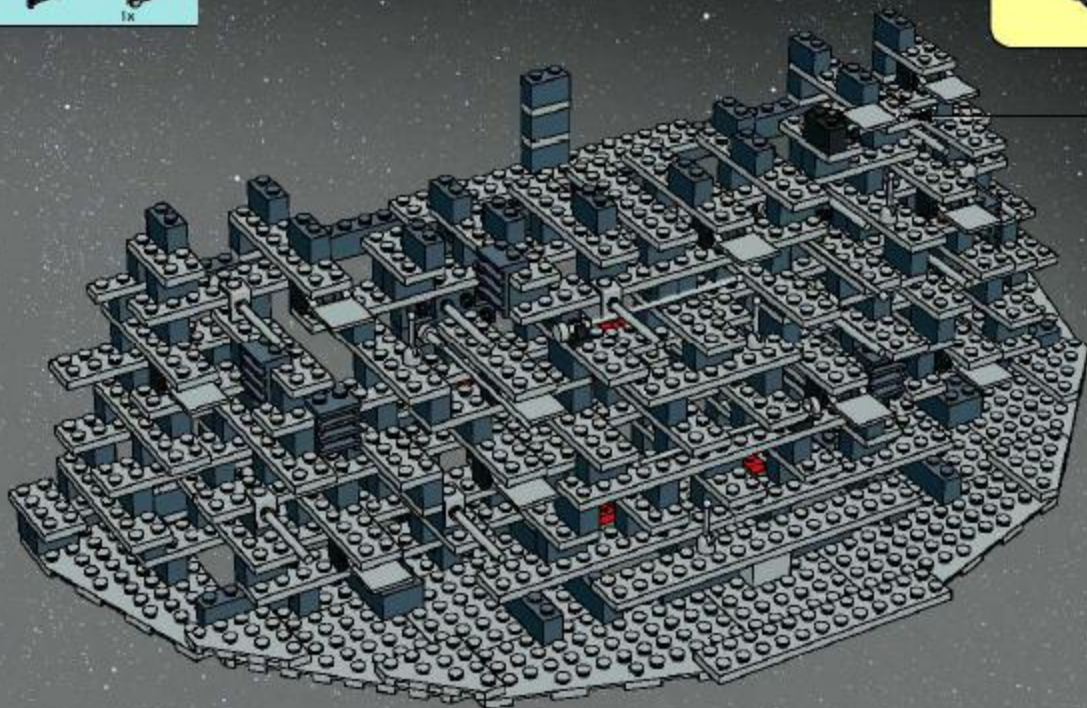

24

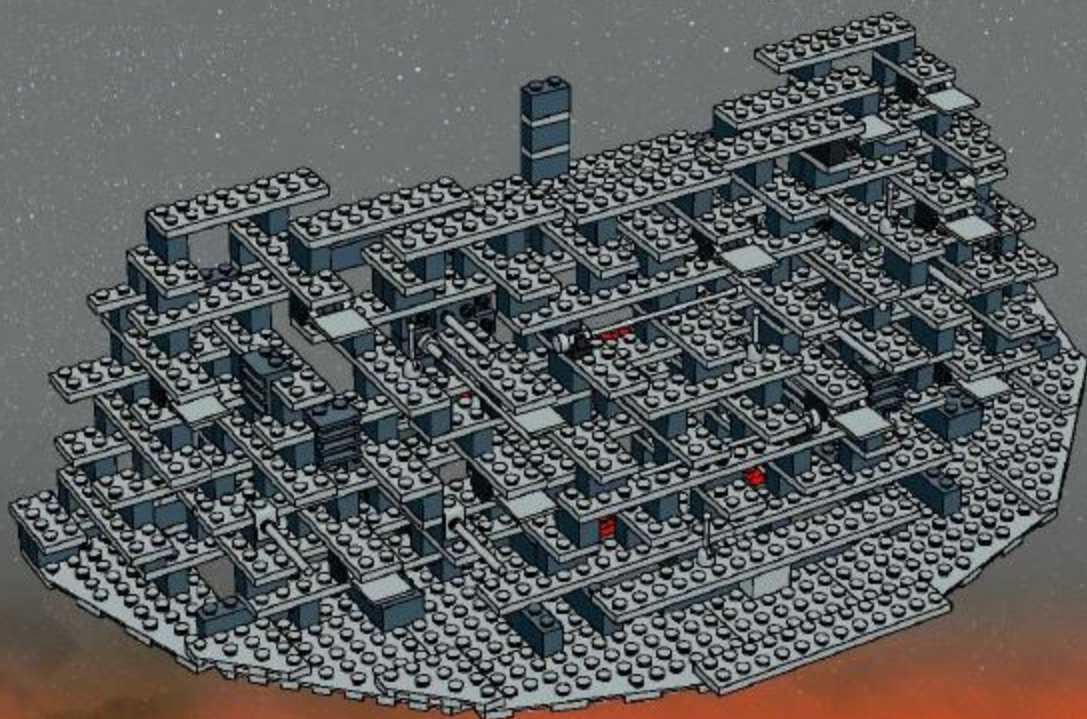

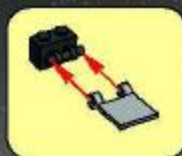
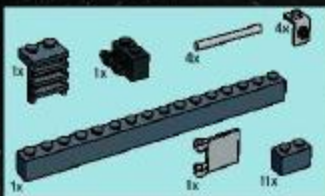

4x

25

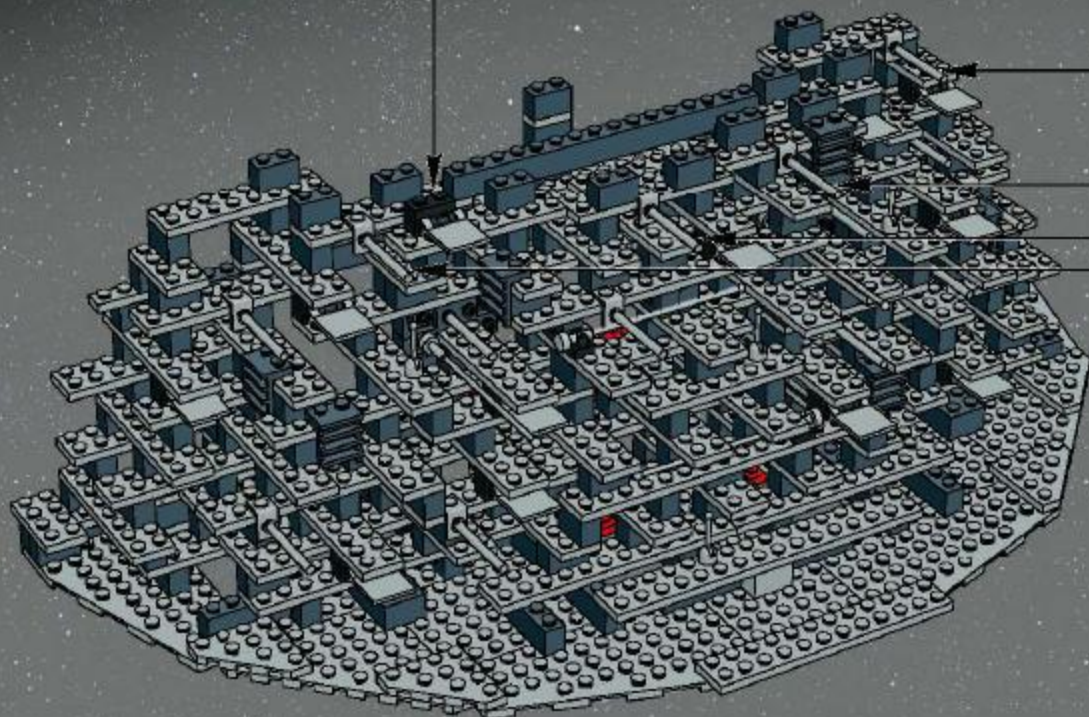

26

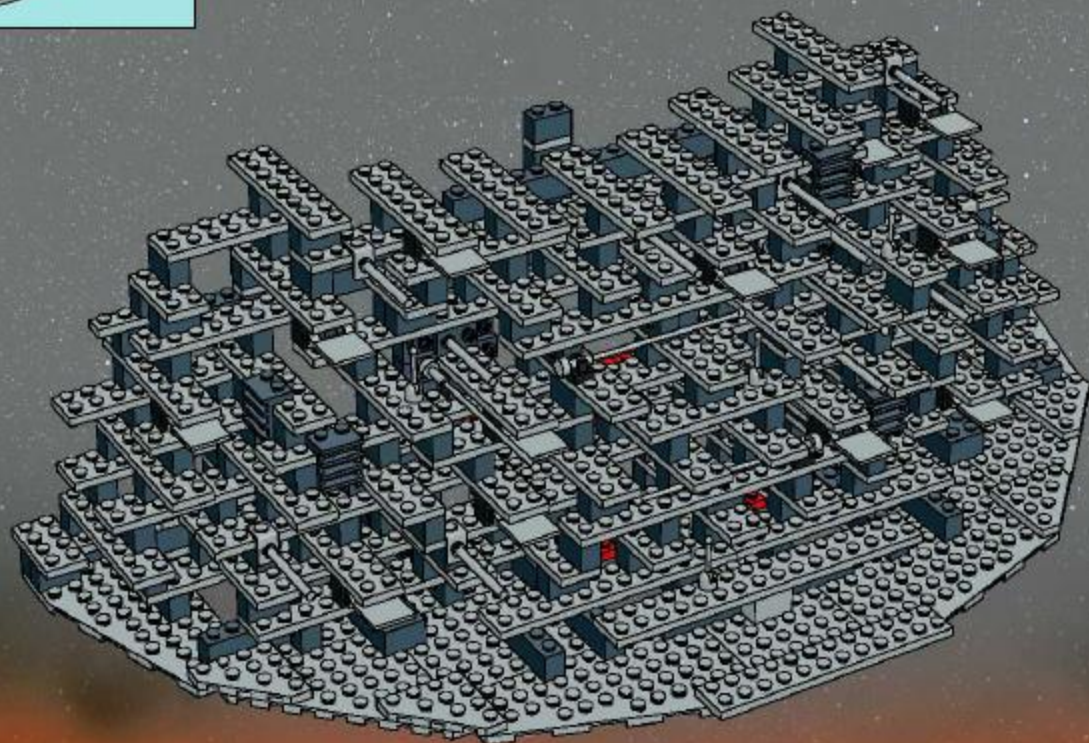

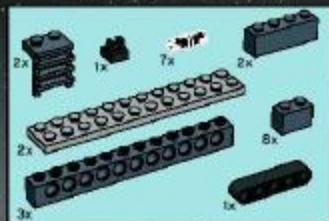

27

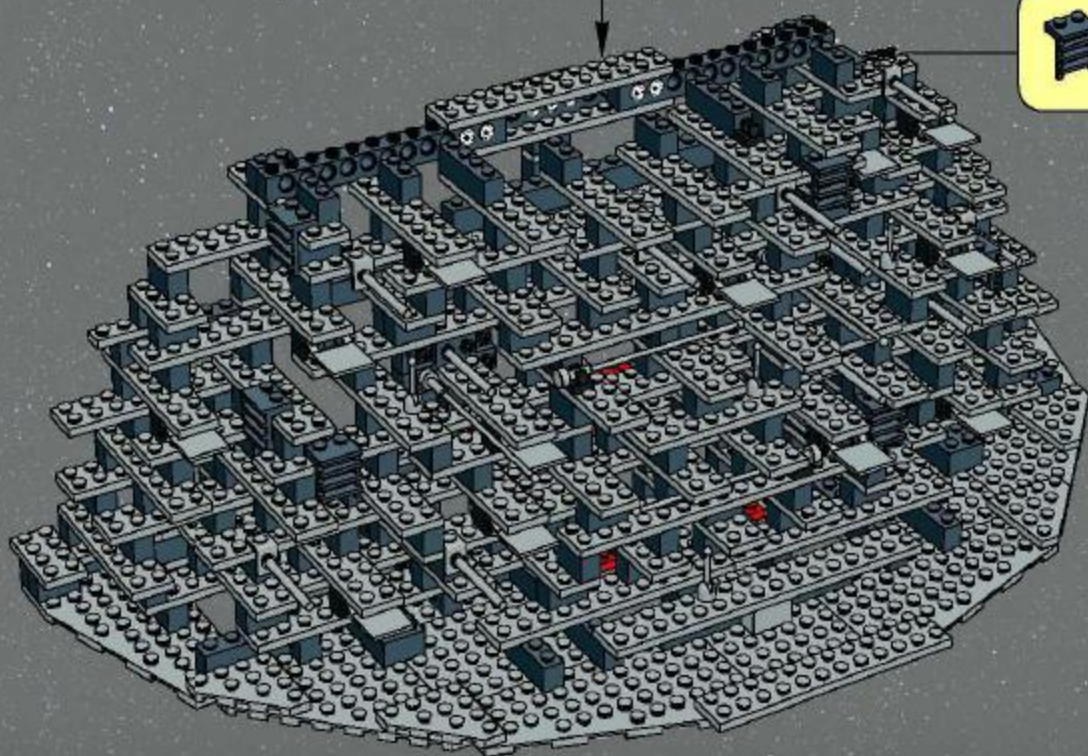
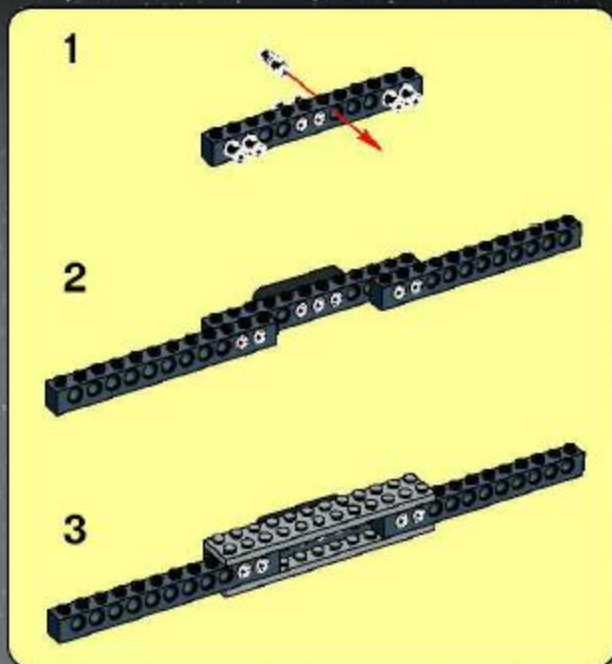

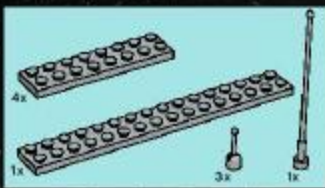

28

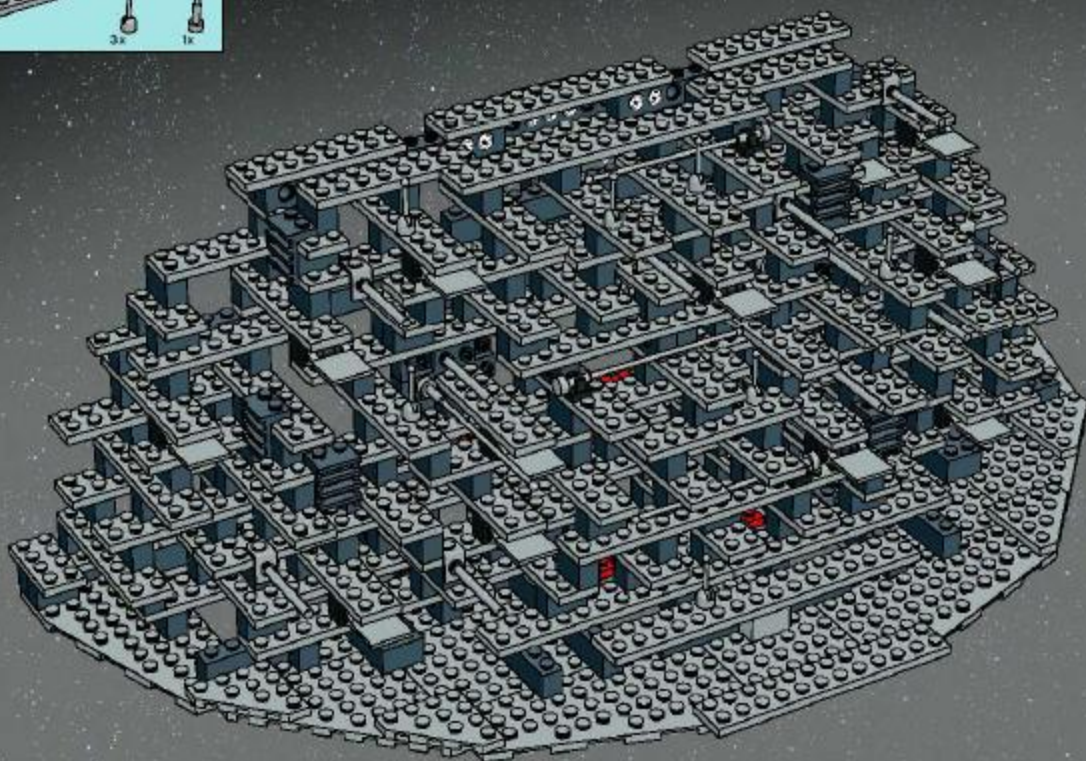

29

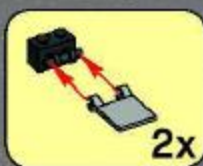



30

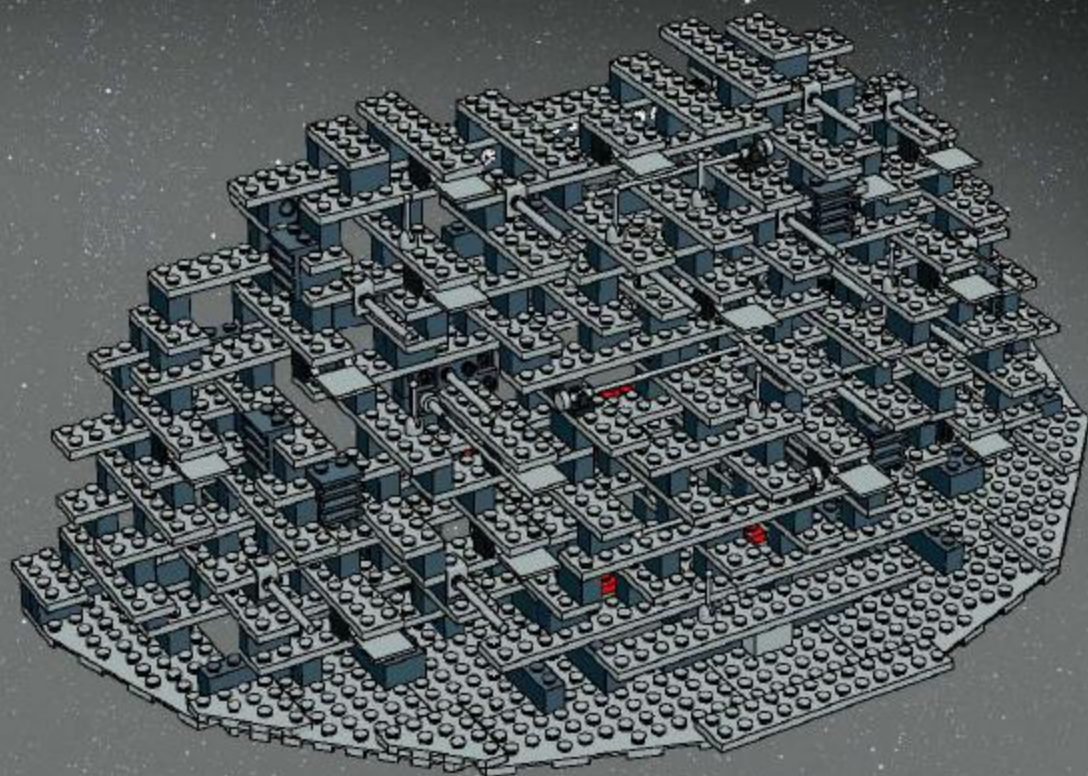

31

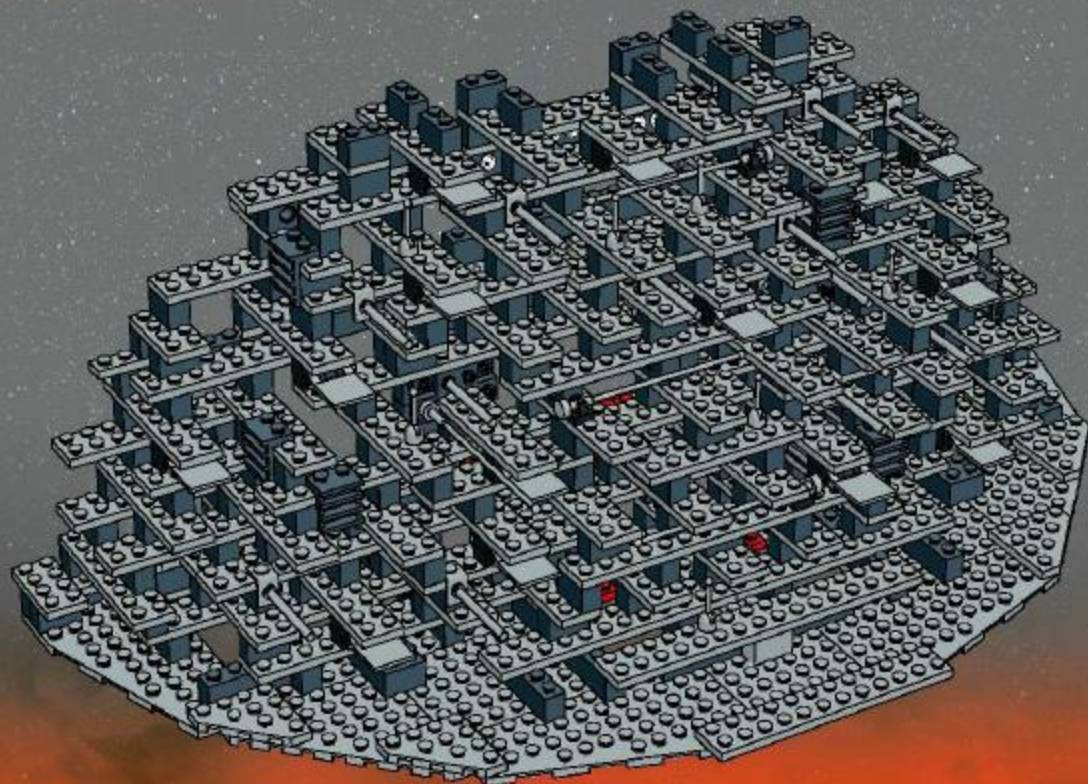



32

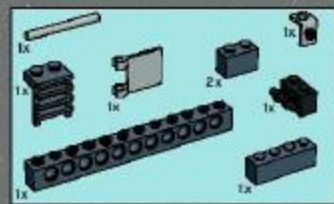

33

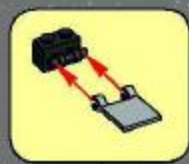



34

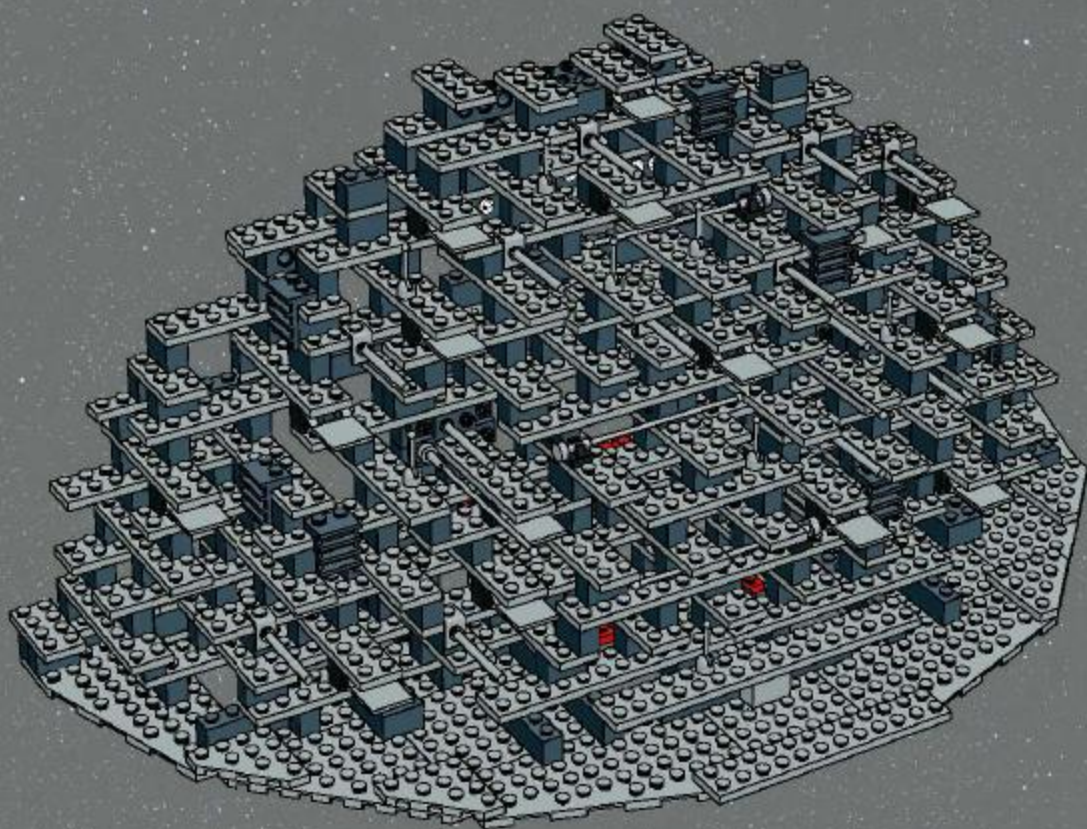

2x

23

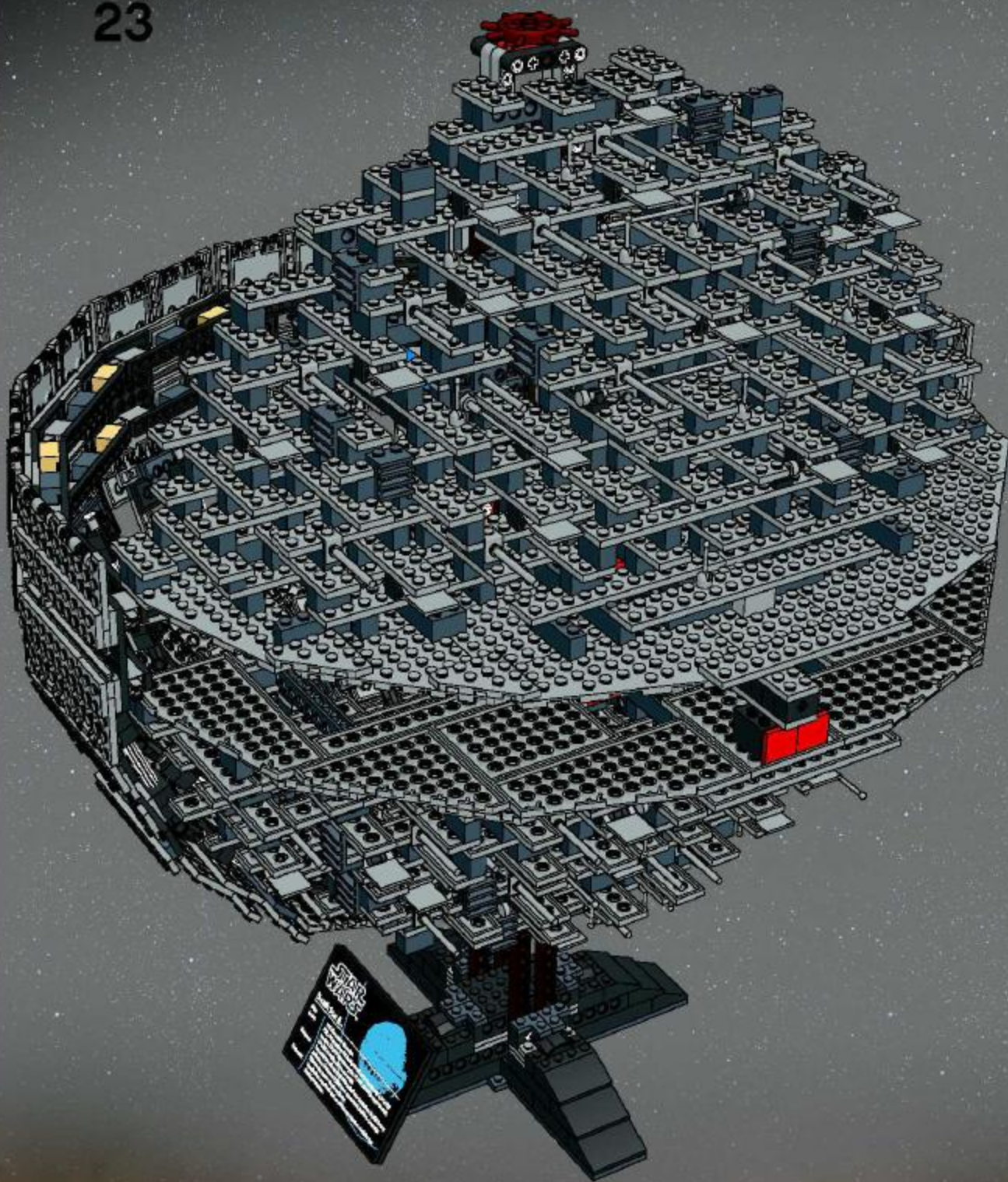



1

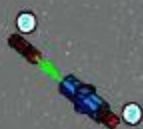

2



3



4





5



6



7





8

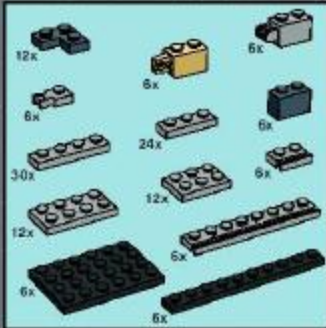
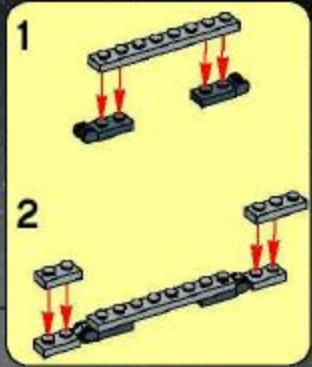
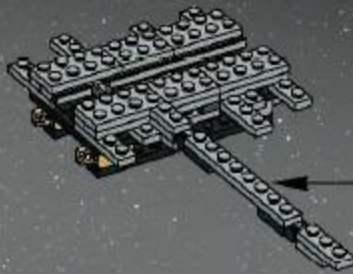

9

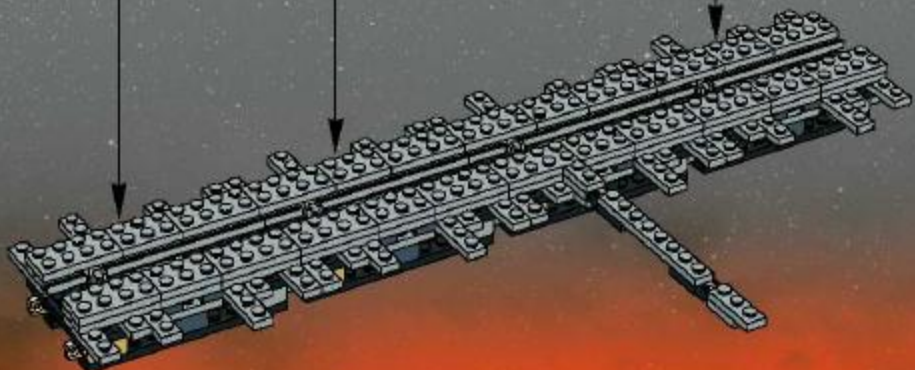
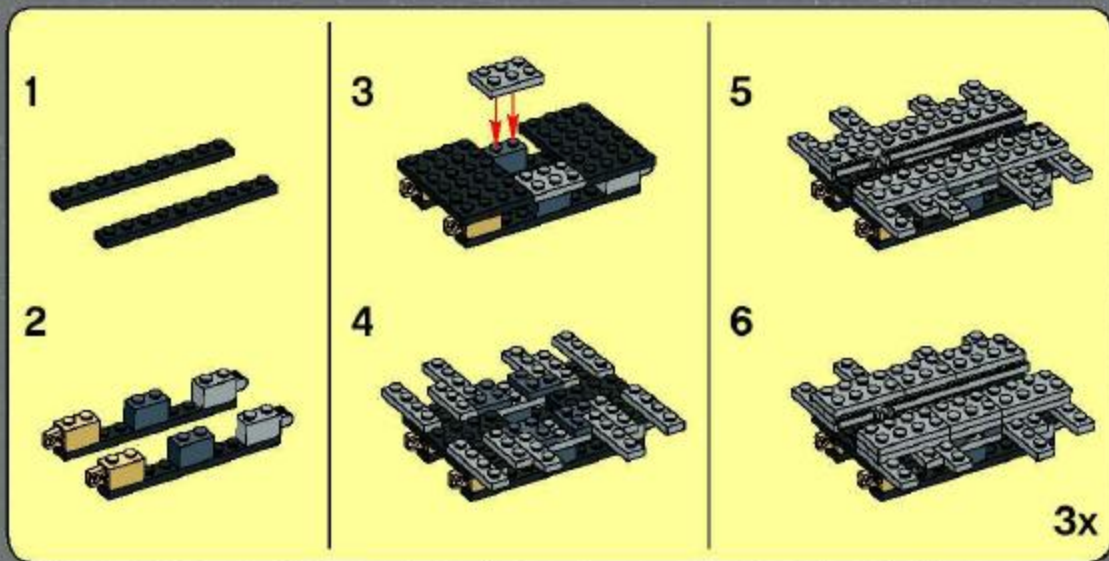



10

Assembly steps 1 through 6:

- Two black 1x16 Technic Bricks.
- Assembly of two sub-components: one with a 1x4 Technic Connector and a 1x4 Technic Pin, and another with a 1x6 Technic Connector and a 1x6 Technic Pin.
- Attachment of a 1x4 Technic Connector and a 1x4 Technic Pin to the sub-components.
- Attachment of a 1x6 Technic Connector and a 1x6 Technic Pin to the sub-components.
- Attachment of a 1x4 Technic Connector and a 1x4 Technic Pin to the sub-components.
- Attachment of a 1x6 Technic Connector and a 1x6 Technic Pin to the sub-components.

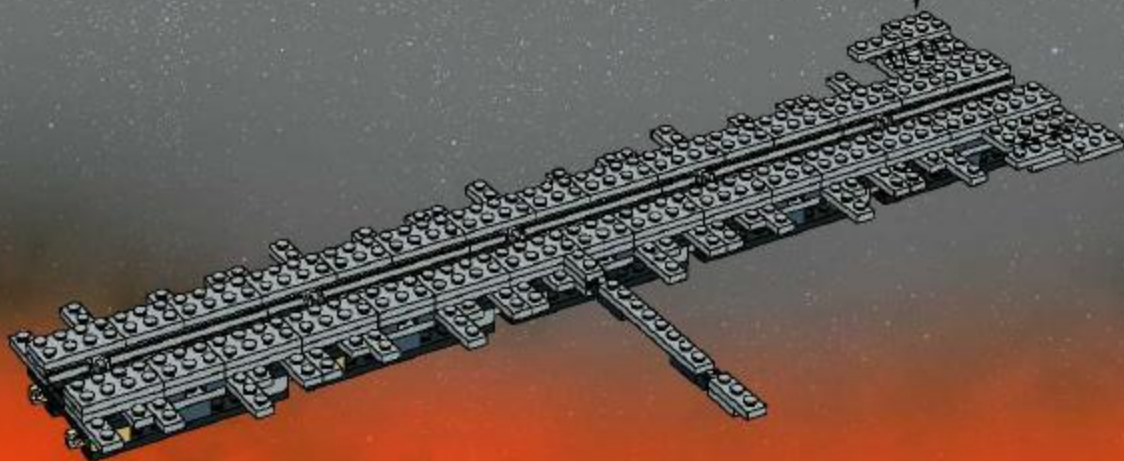

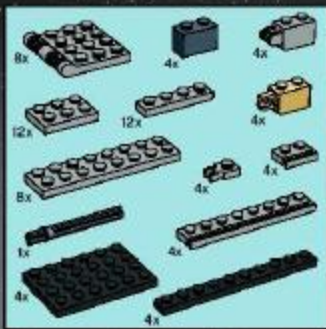

11

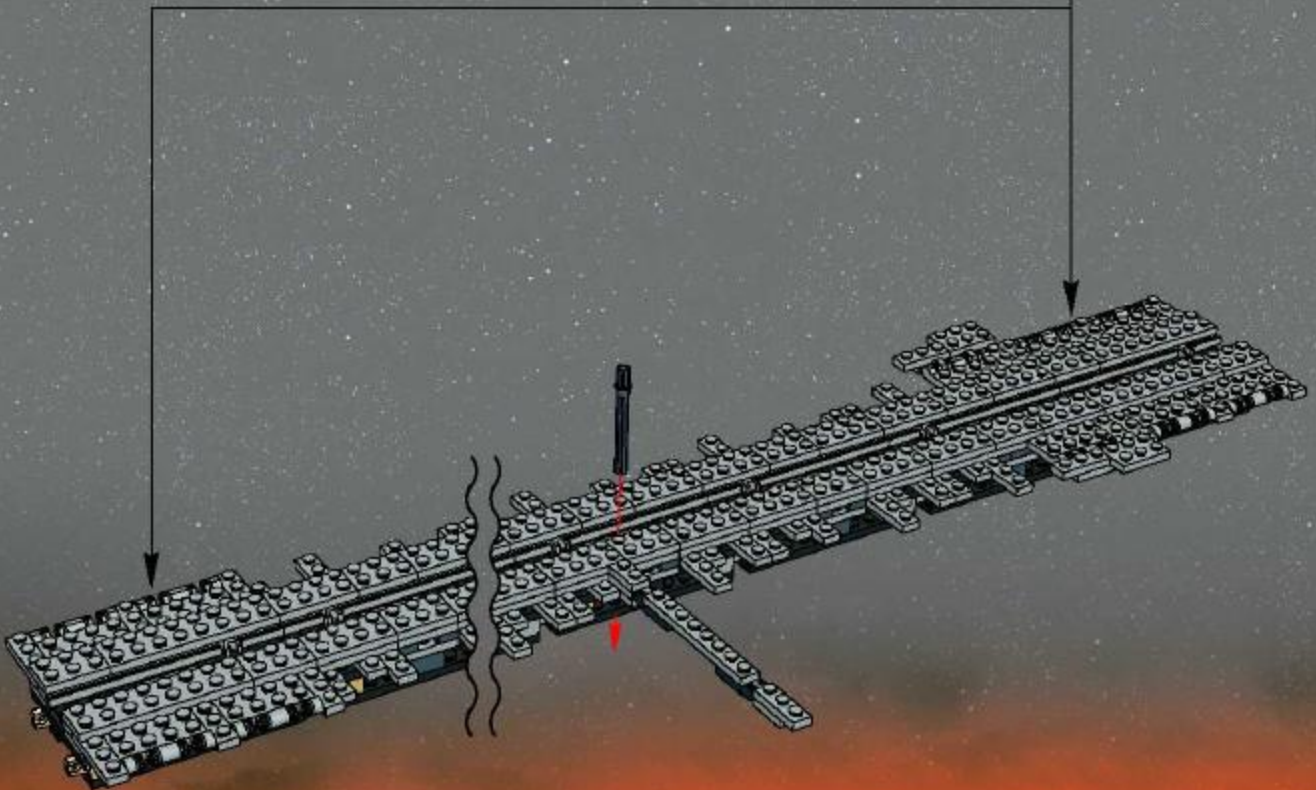
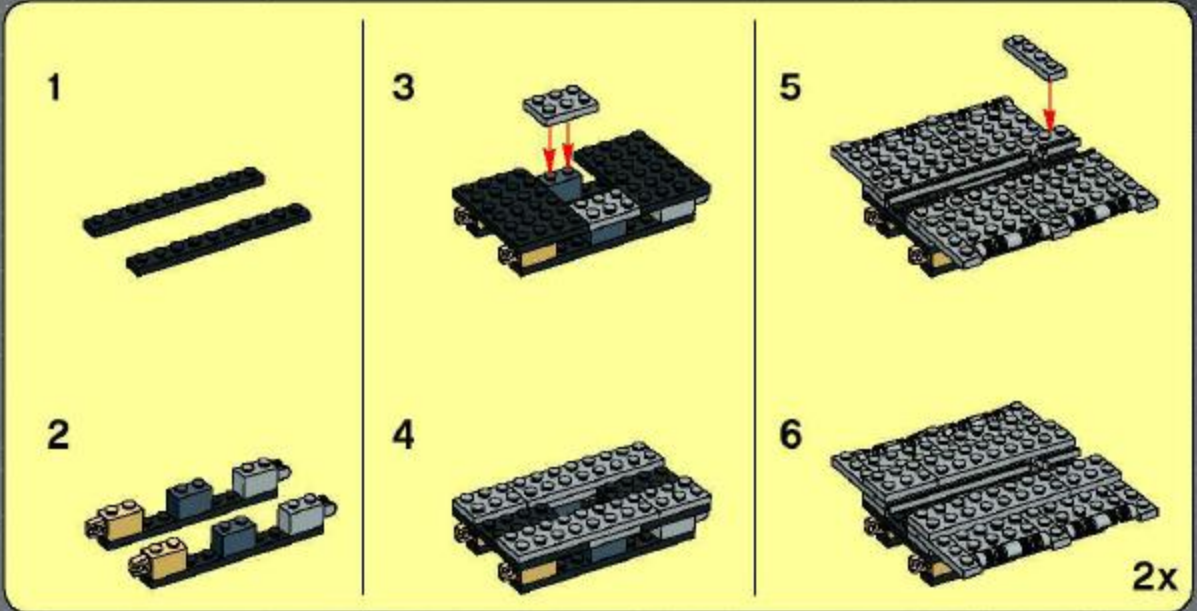

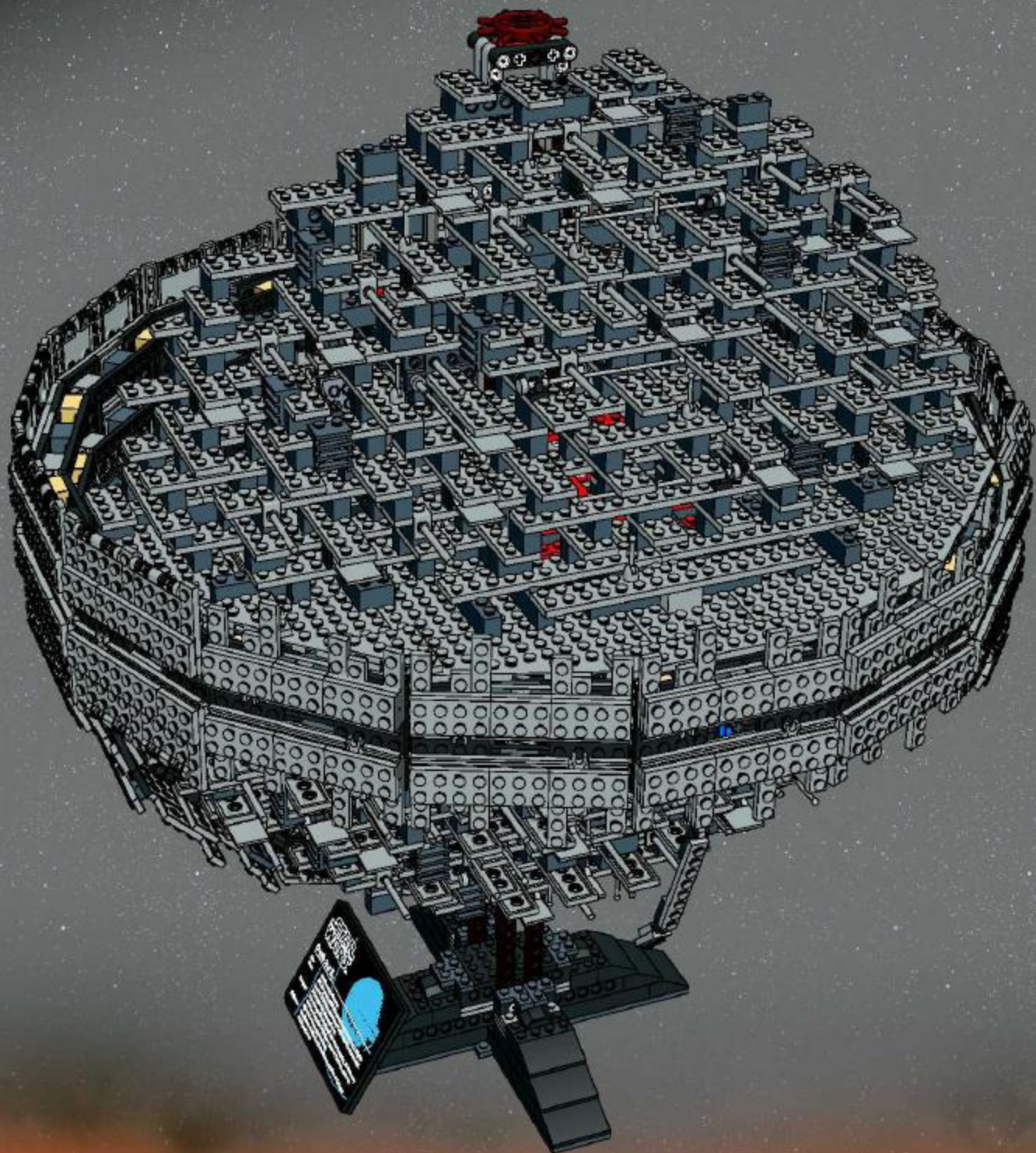



25

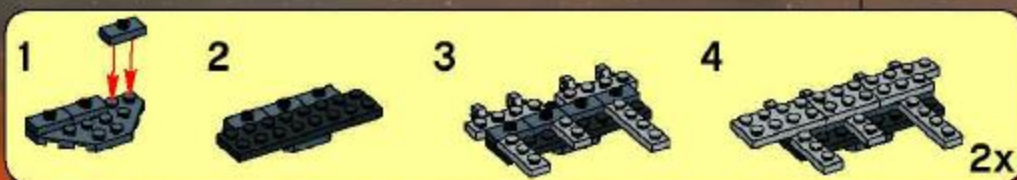



1



2



3



4

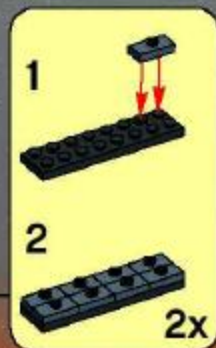
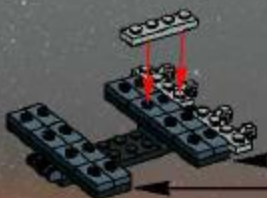

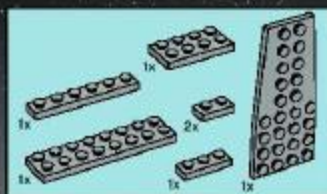

5

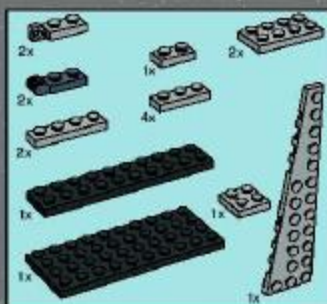

6

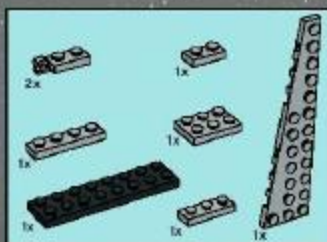
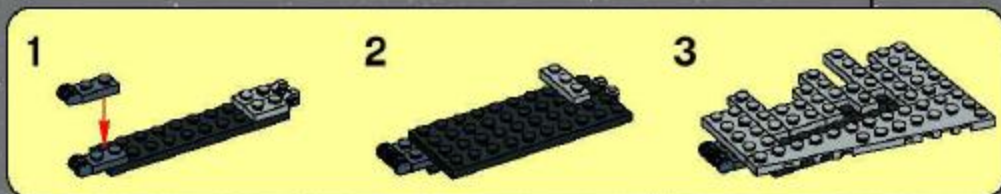
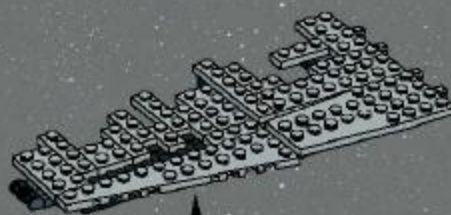

7

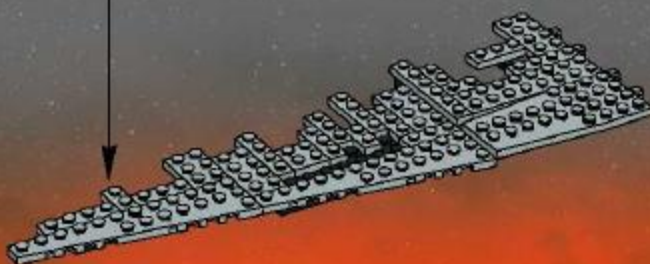

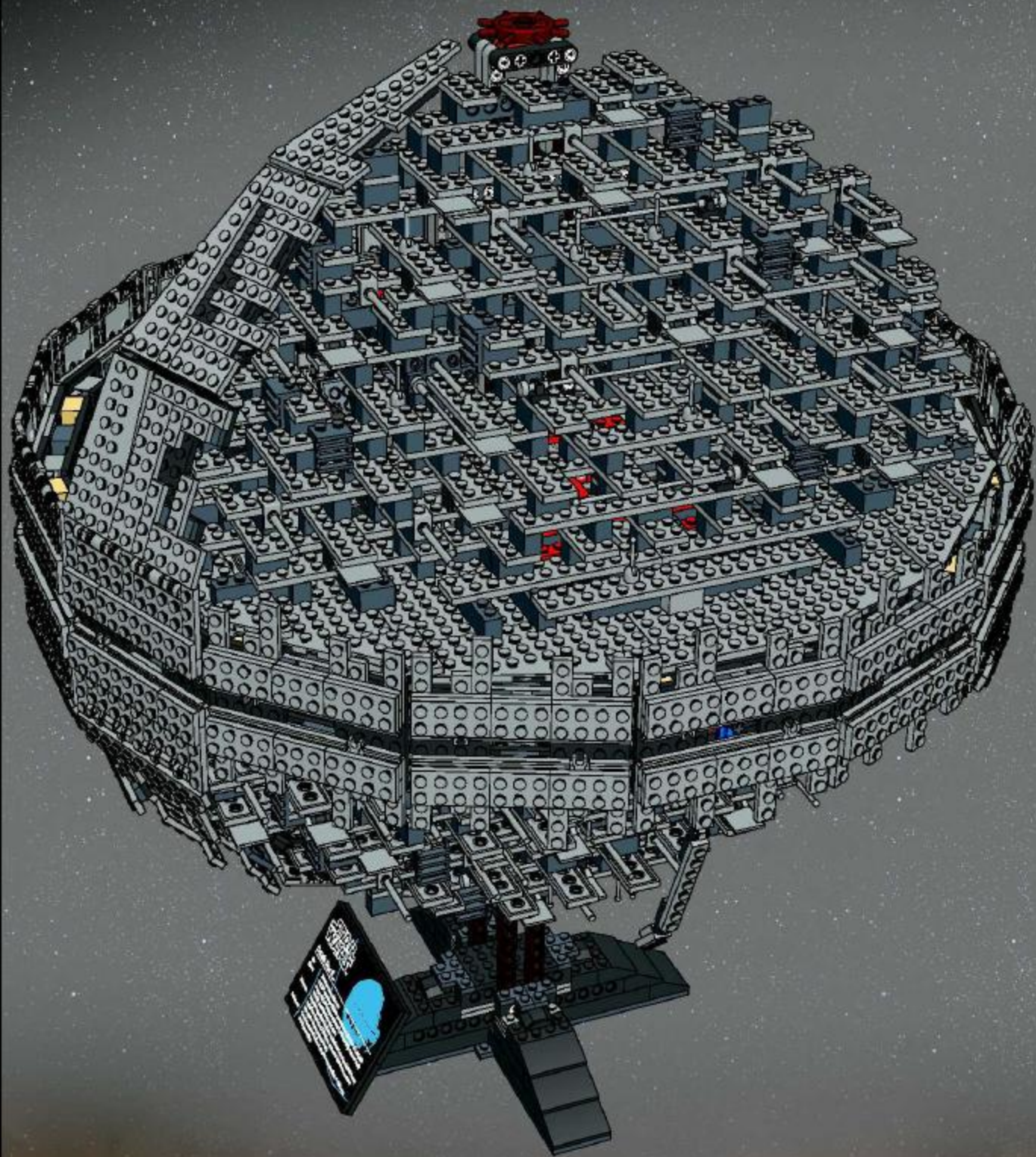



1



2



3



4

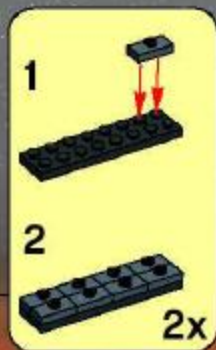
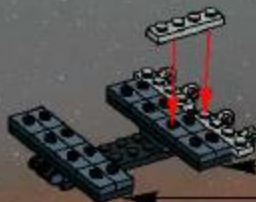

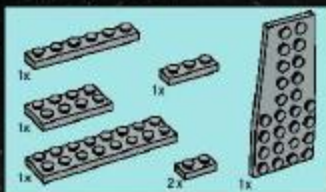

5

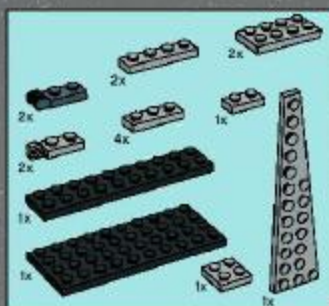

6

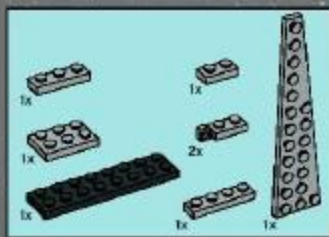

7

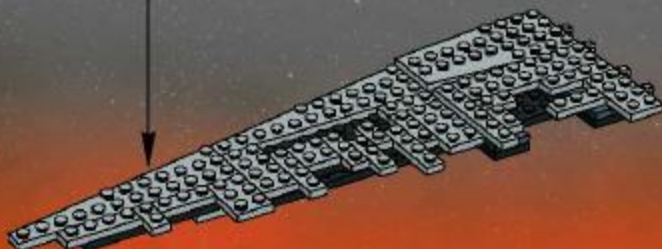



27

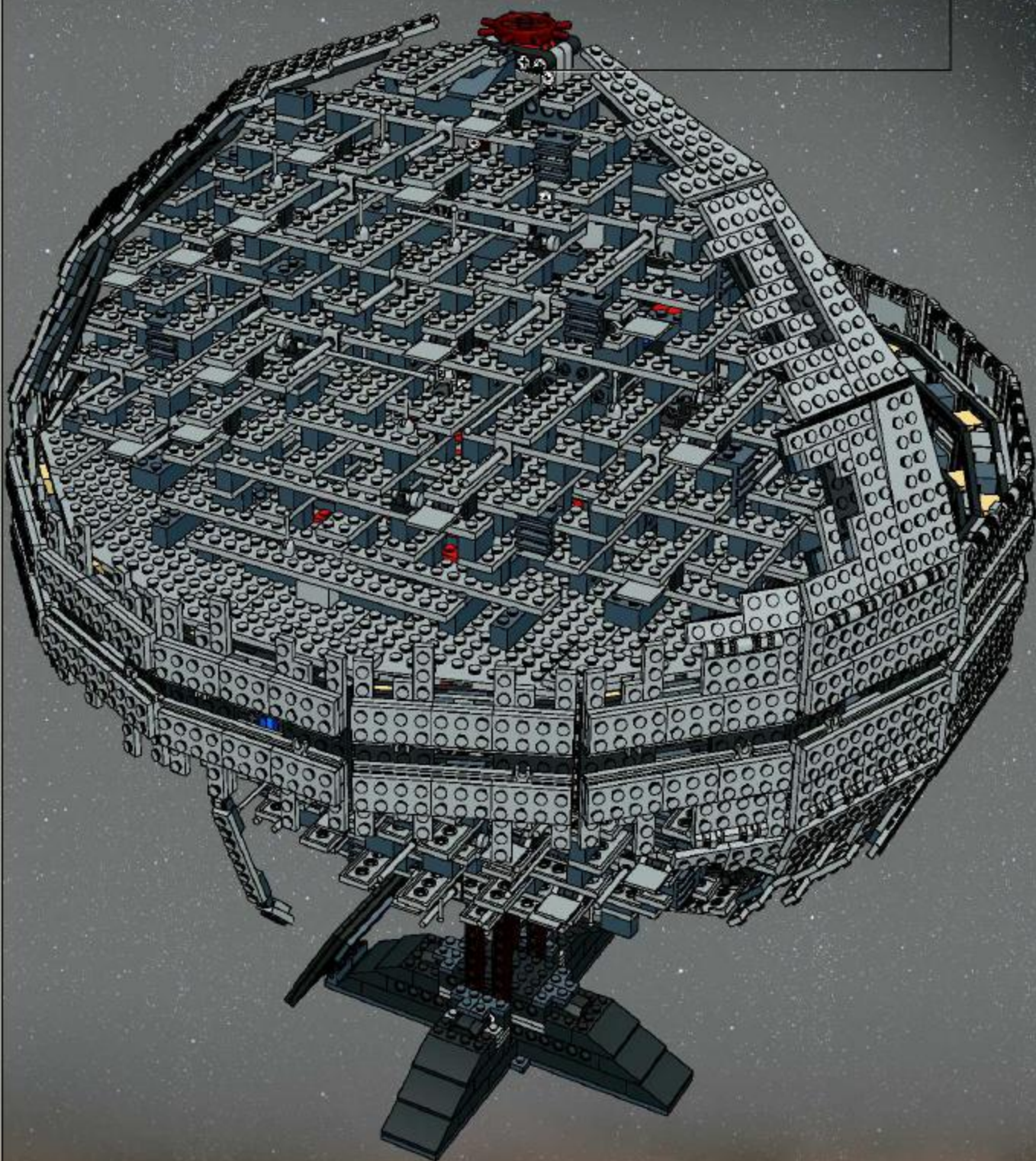
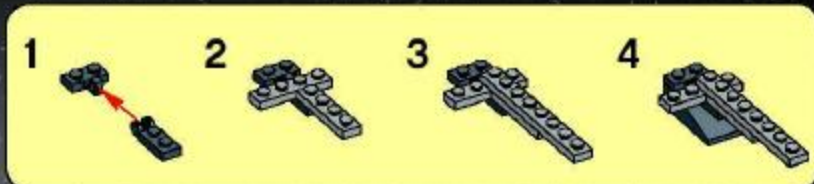



1



2

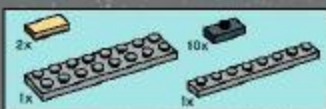

3

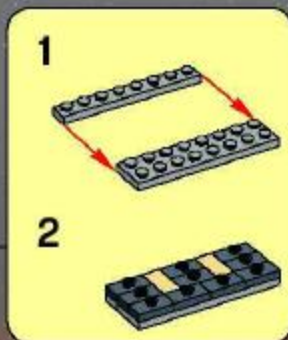



4

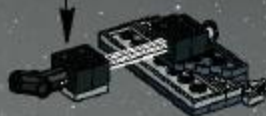
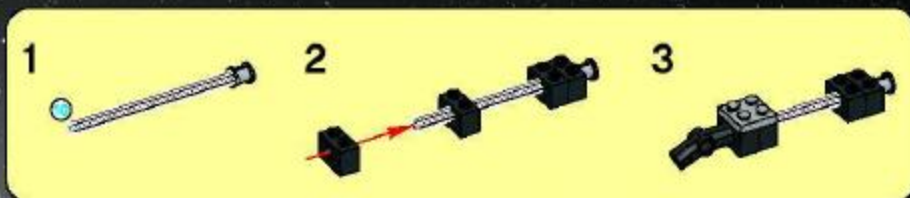

5

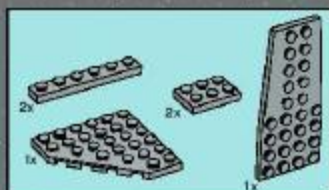
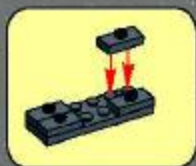

6



7



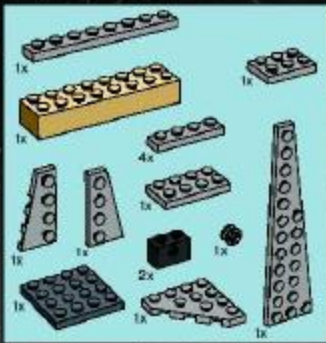

8

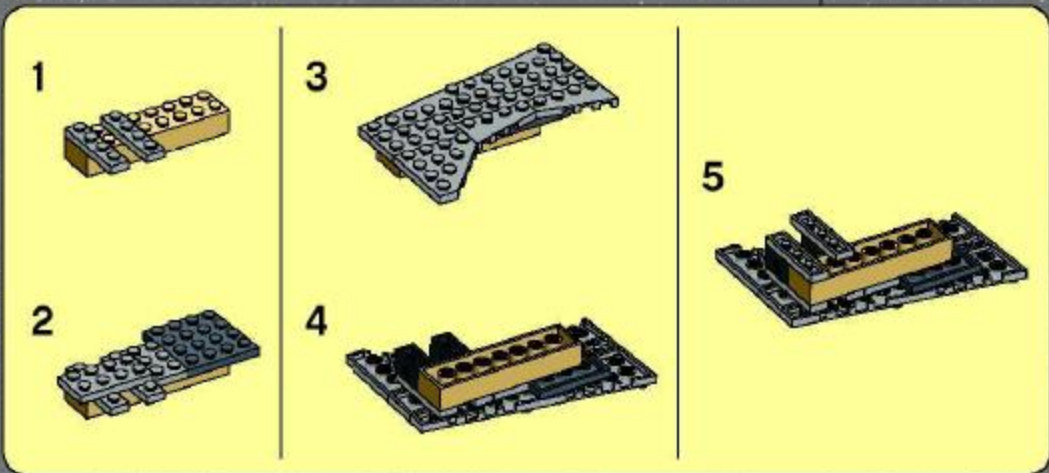
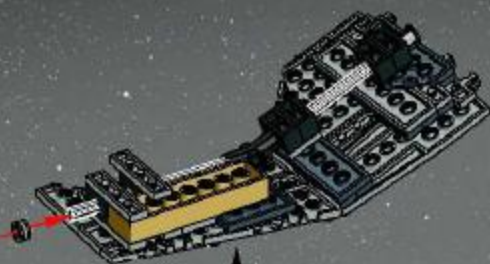

9

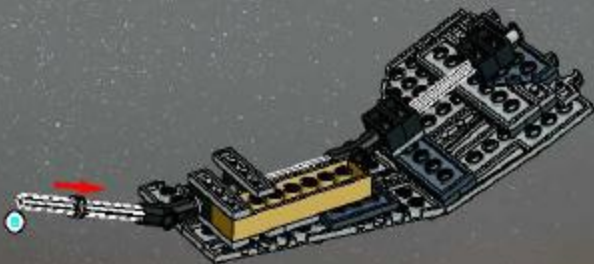

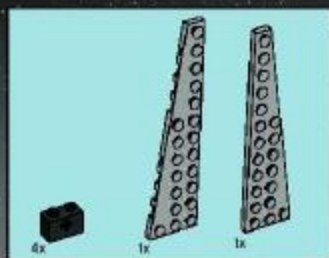

10



11

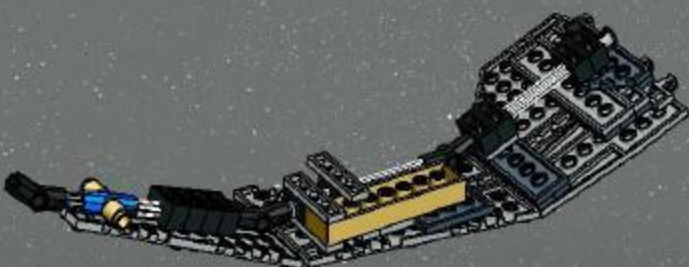
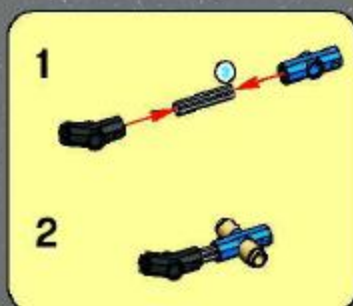

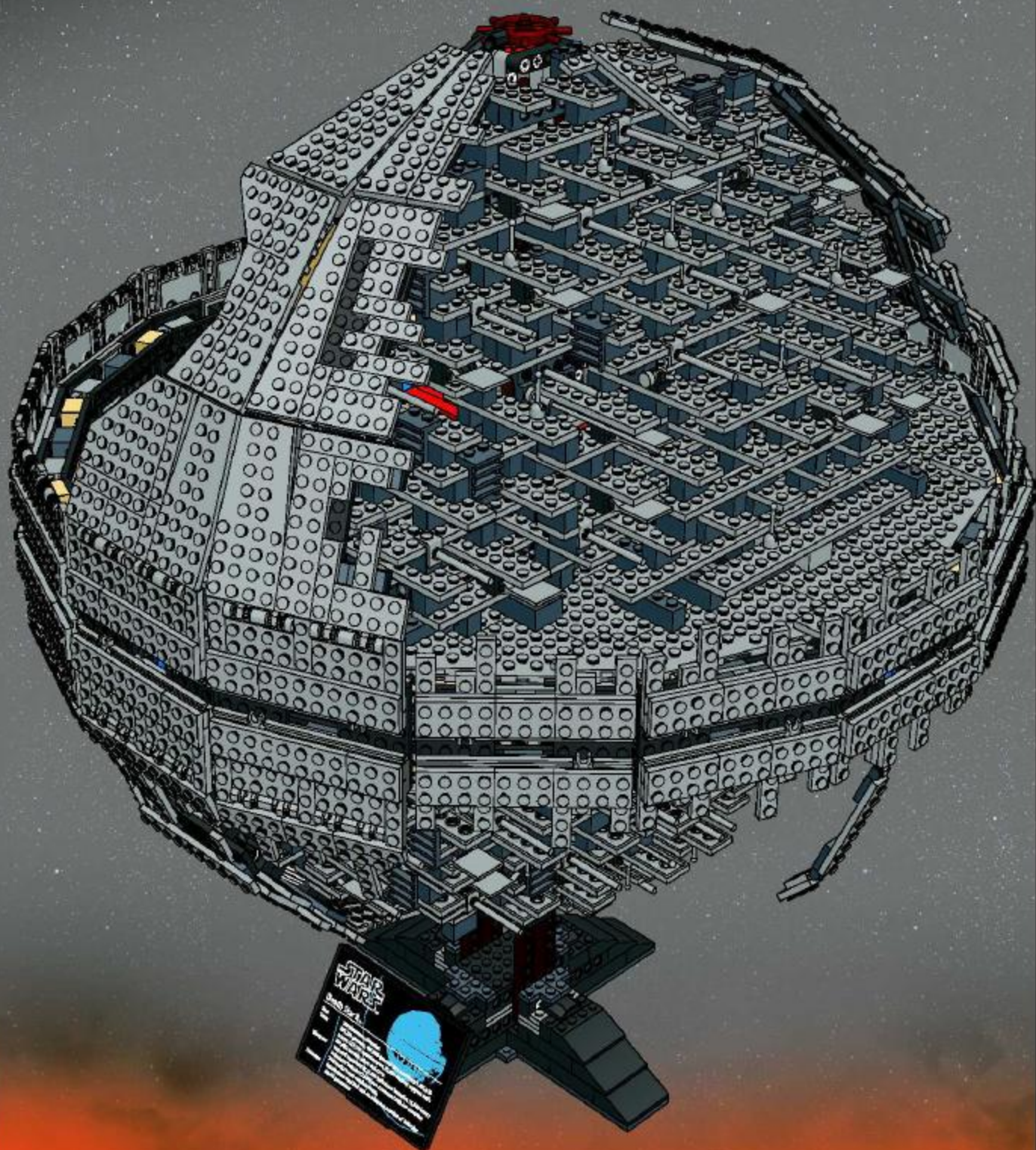



1



2



3

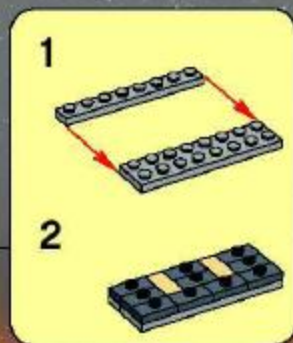



4

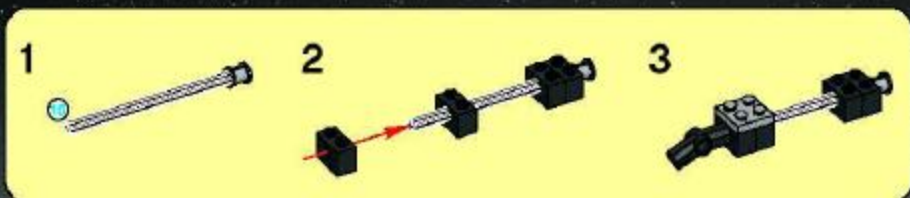

5

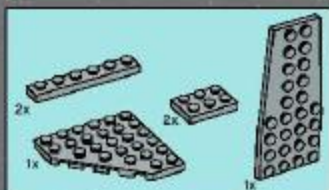
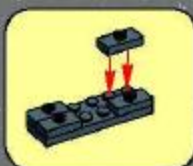

6



7



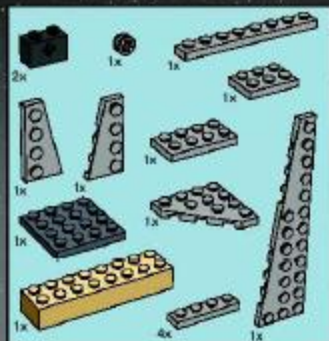

8

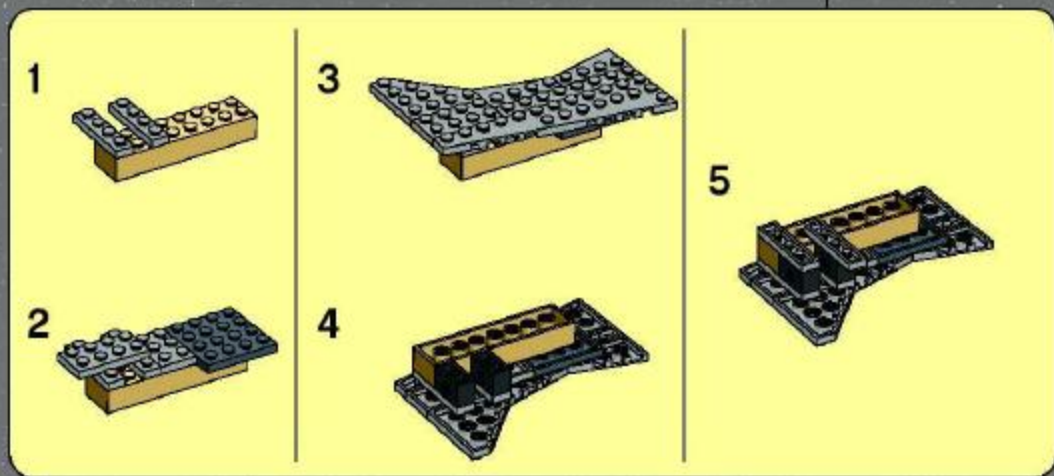
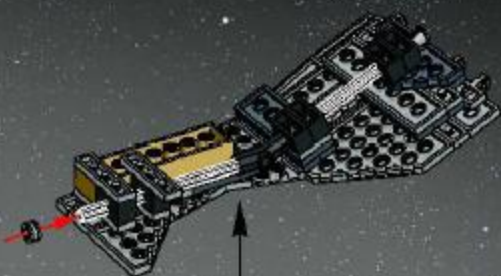

9

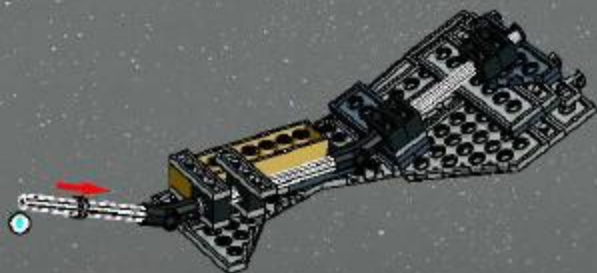

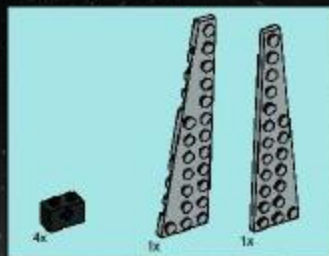

10

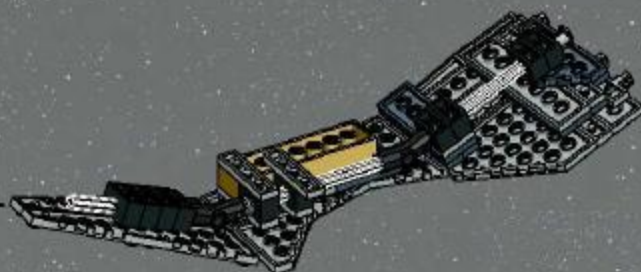
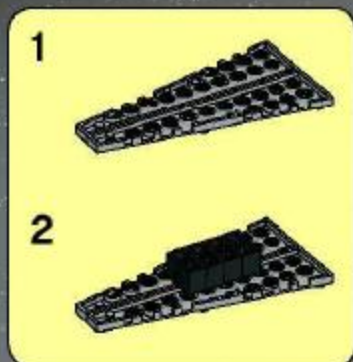

11

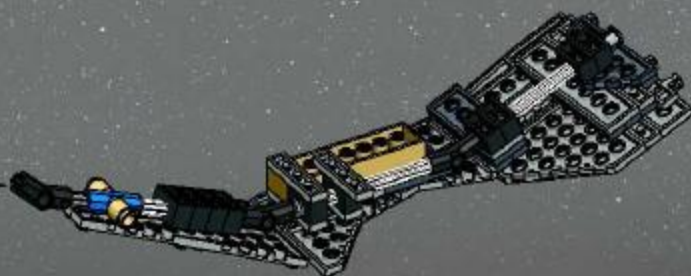
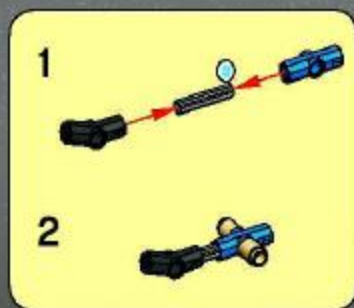

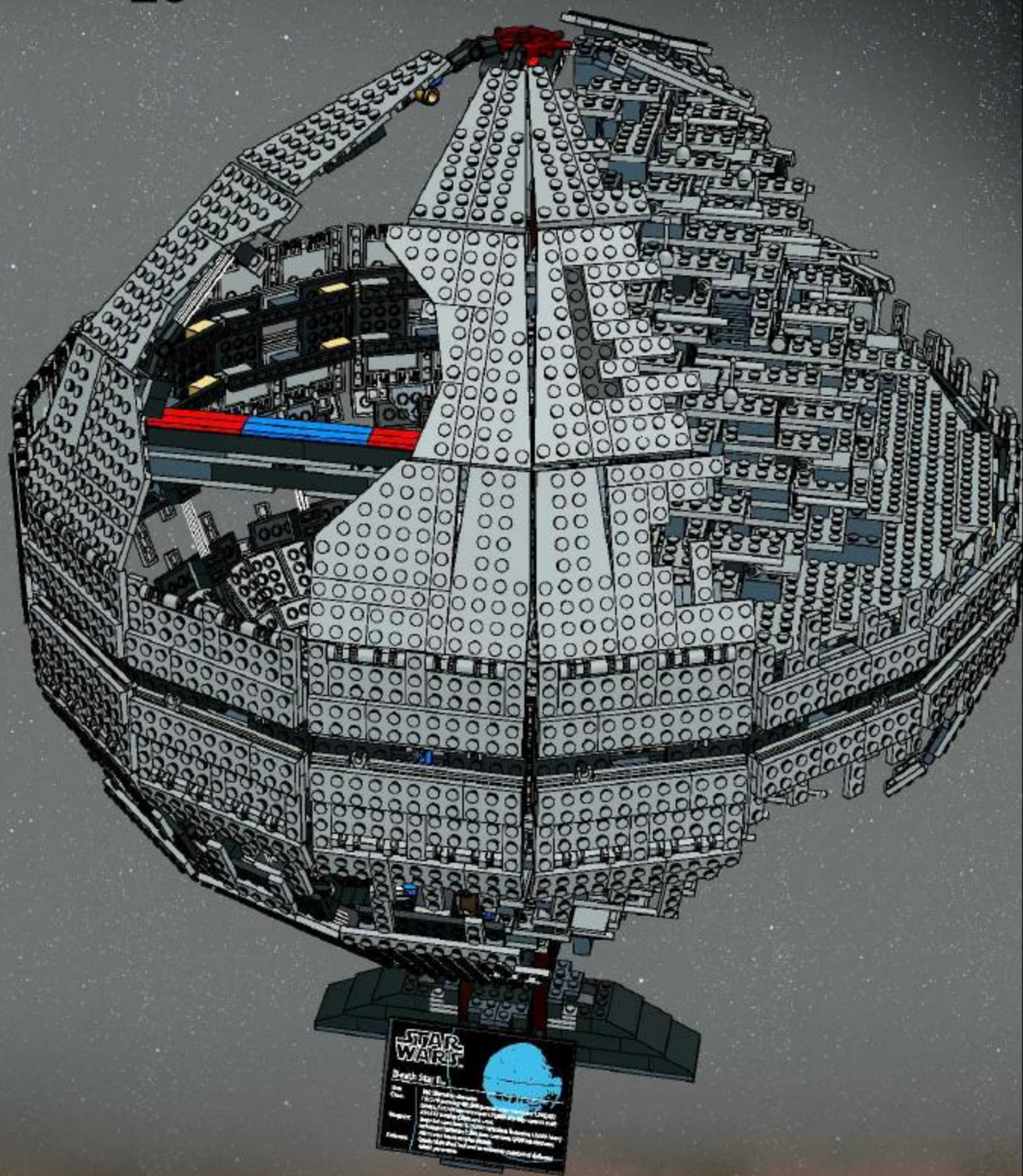



30

1



2



3



4

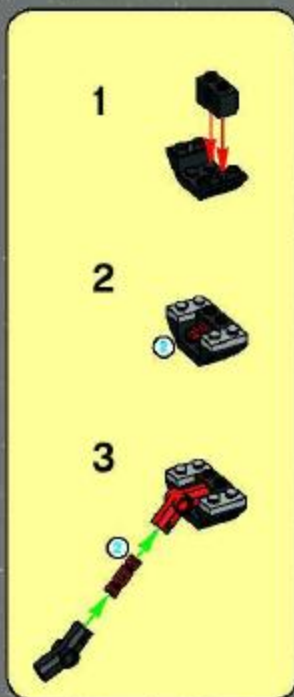
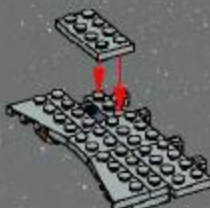

5





STAR WARS
Death Star II

1. The Death Star II is a massive space station that orbits the planet of Endor. It is the second and largest of the Death Stars, and is capable of destroying an entire planet.

2. The Death Star II is a spherical structure that is 160 kilometers in diameter. It is built from a complex network of corridors and rooms, and is capable of housing up to 650,000 troops.

3. The Death Star II is a highly advanced piece of technology, and is capable of firing a powerful laser beam that can destroy an entire planet. It is also capable of launching a fleet of TIE fighters.

4. The Death Star II is a highly secure facility, and is protected by a powerful shield that can deflect incoming attacks. It is also capable of launching a fleet of TIE fighters.

5. The Death Star II is a highly advanced piece of technology, and is capable of firing a powerful laser beam that can destroy an entire planet. It is also capable of launching a fleet of TIE fighters.



1

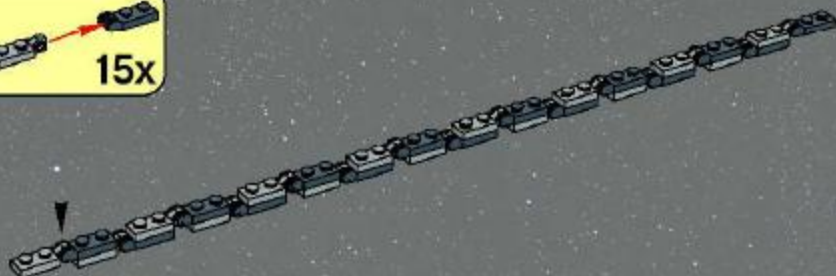
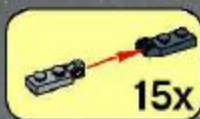

2



3



4

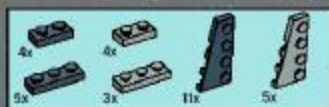

5



6





7

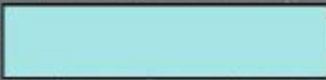

8

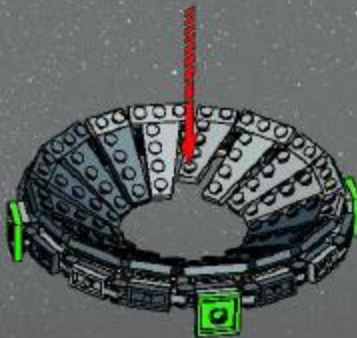

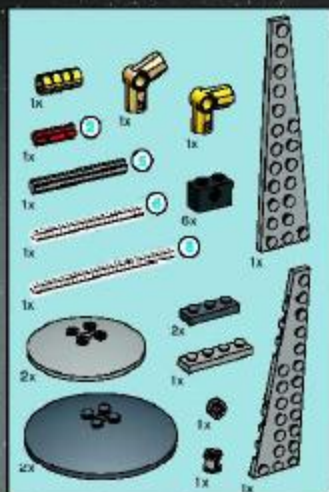

9

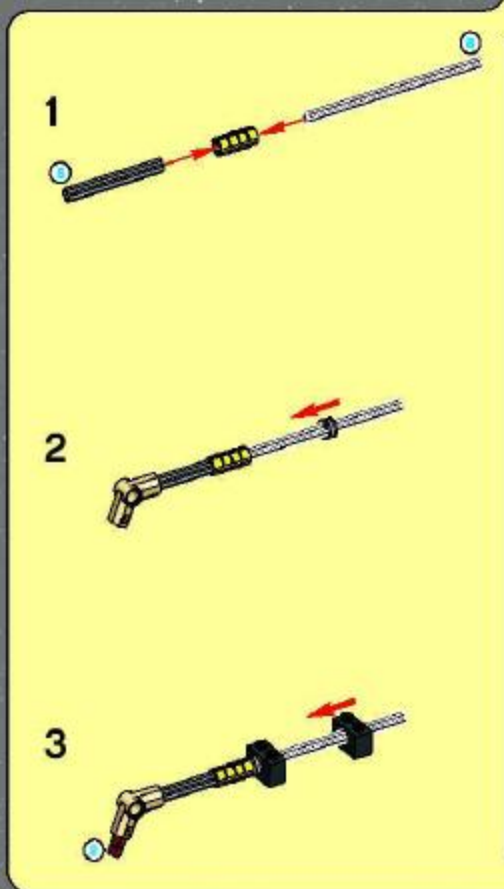

4

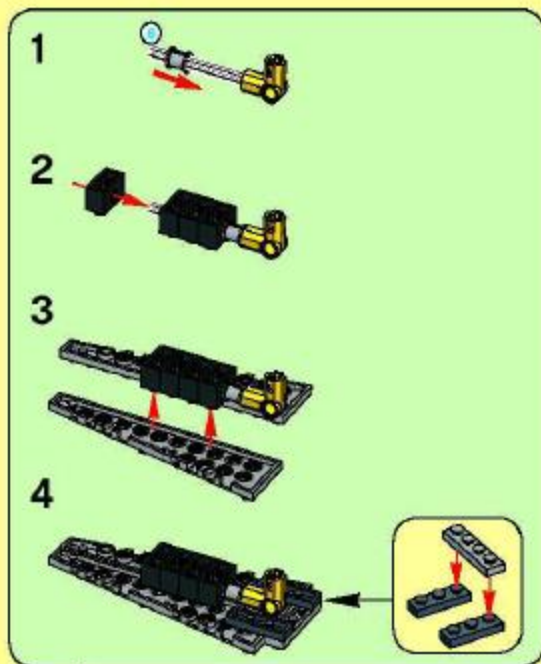
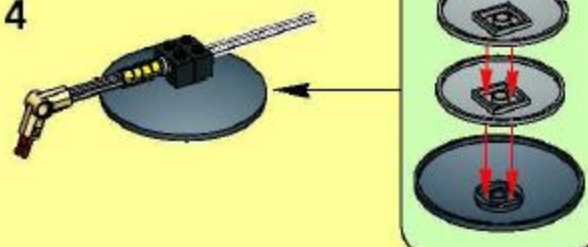

5

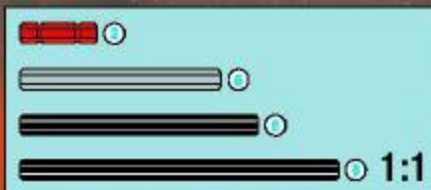
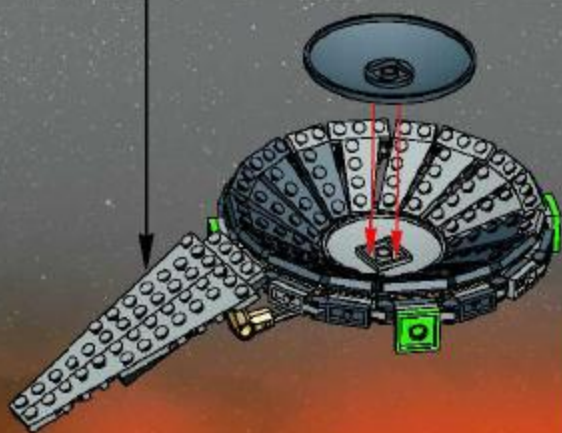



10

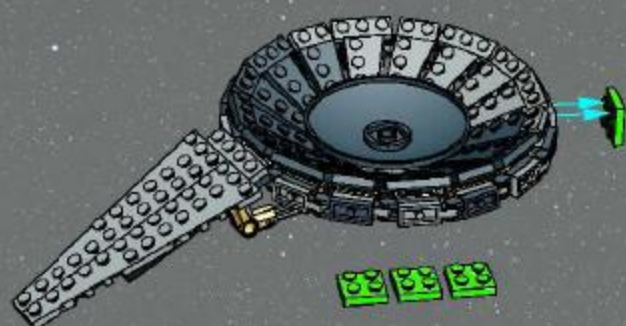

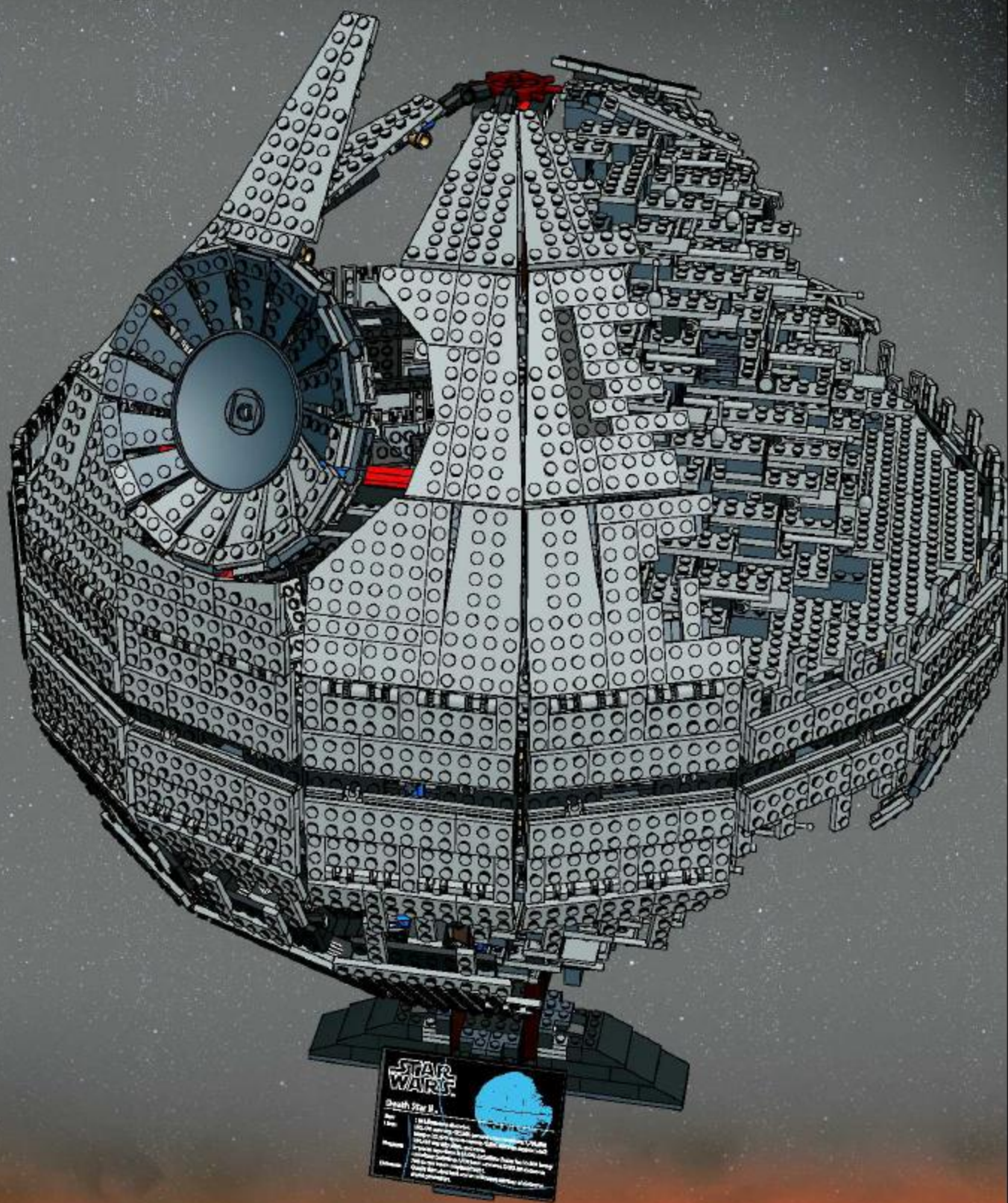



32

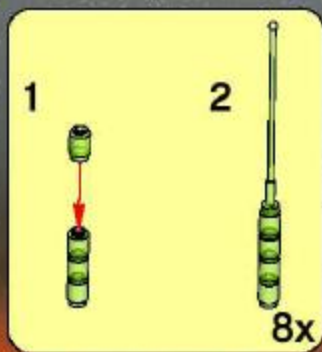
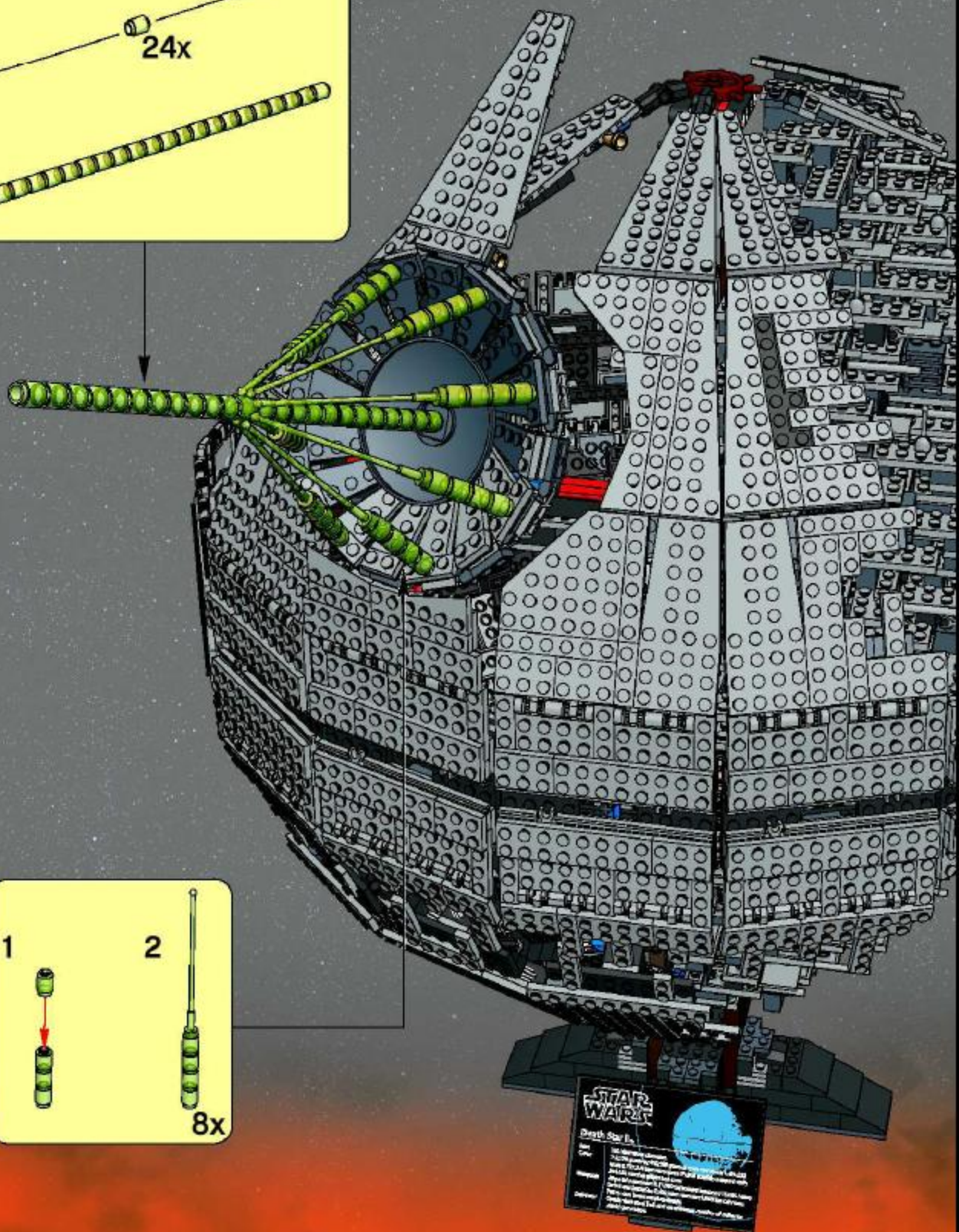
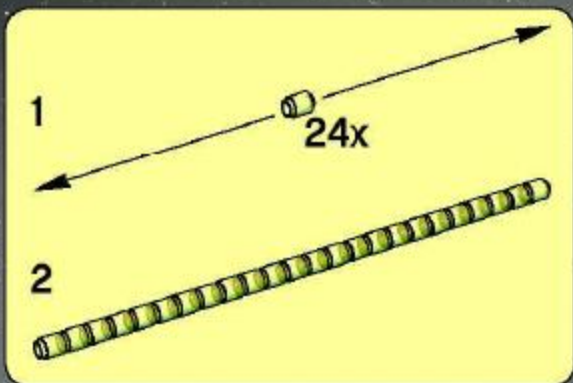



1



2



3



4

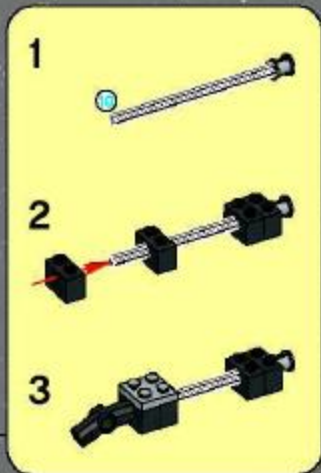
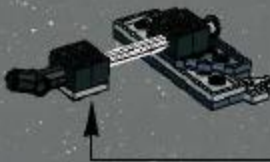

5

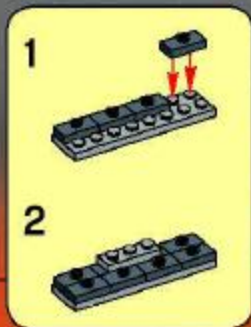

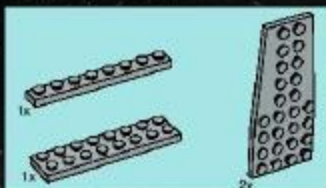

6



7



8



9



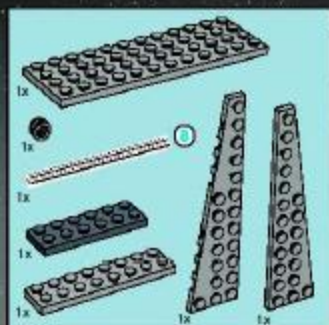

10

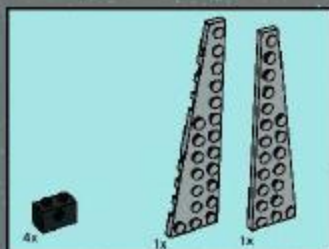
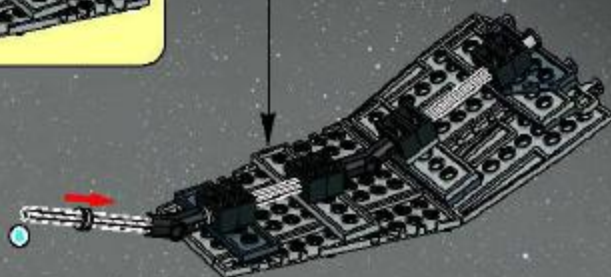
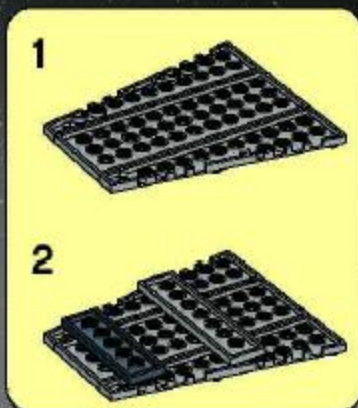

11

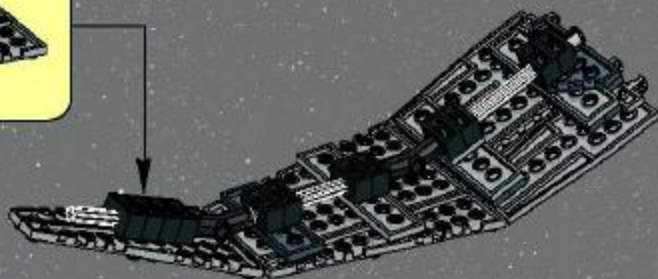
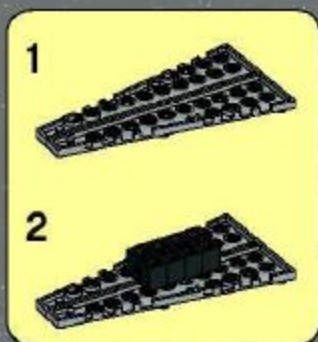

12

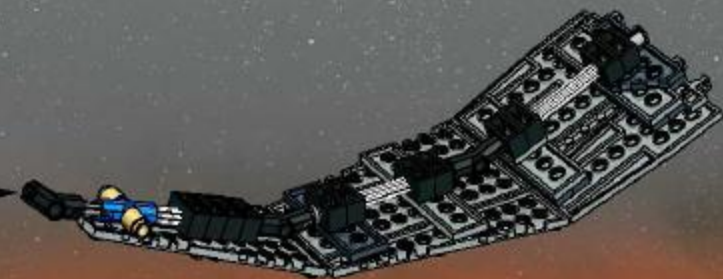
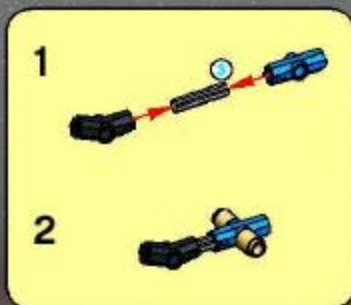

3x

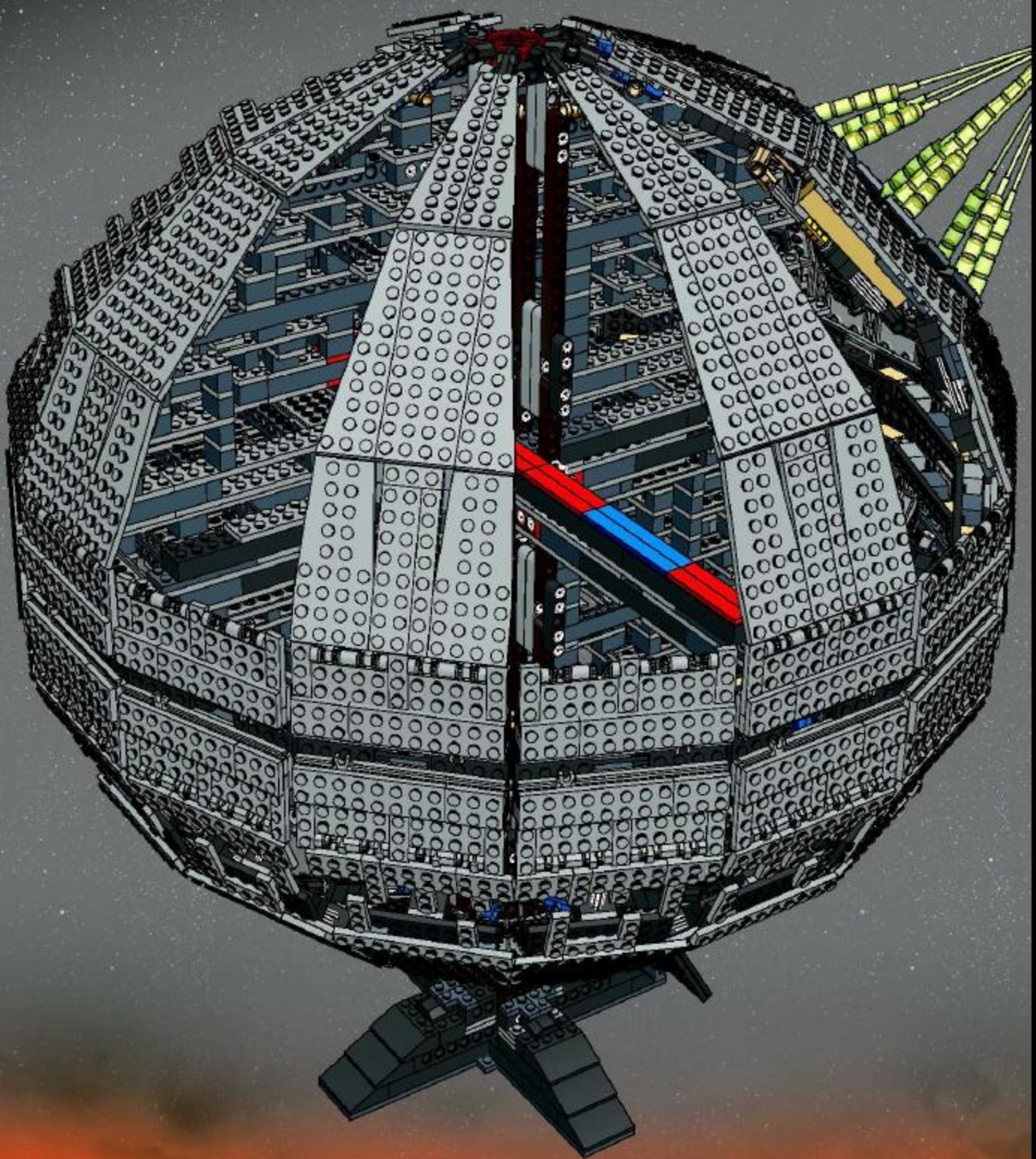



1



2



3



4

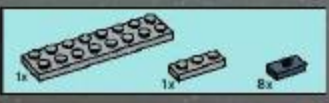
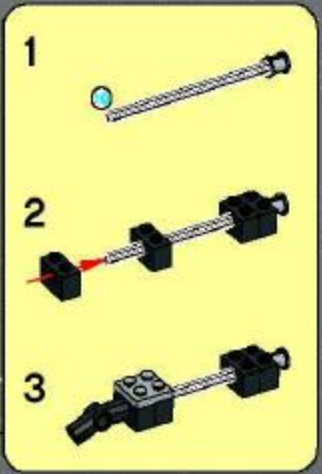
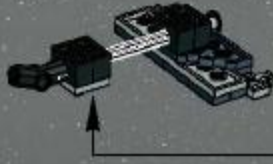

5

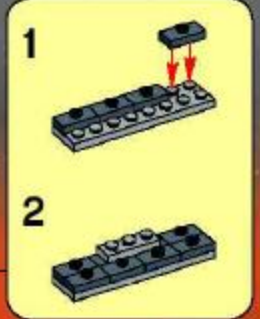

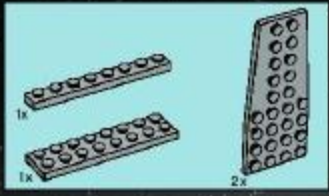

6



7



8

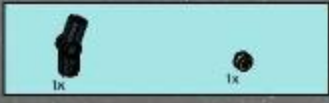

9



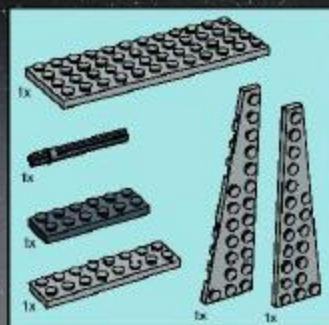

10

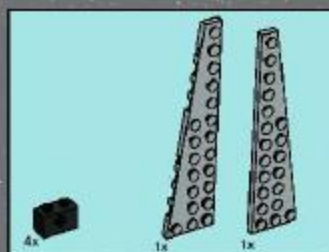
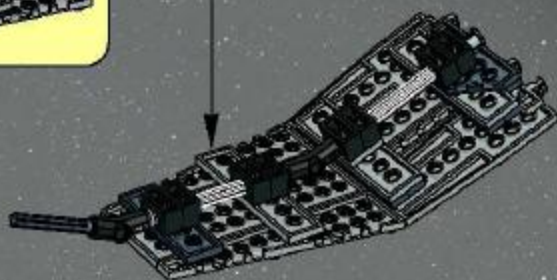
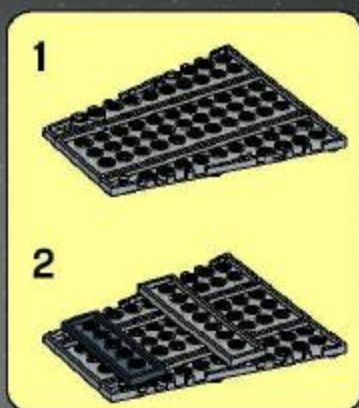

11

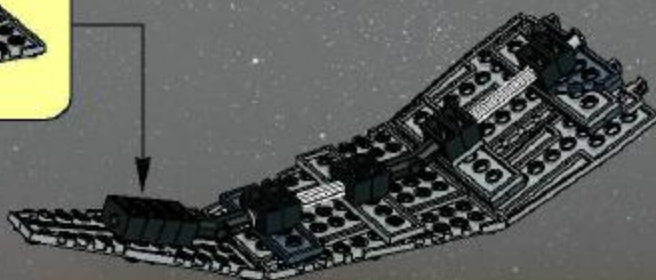
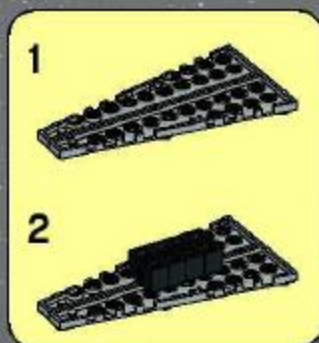

3x

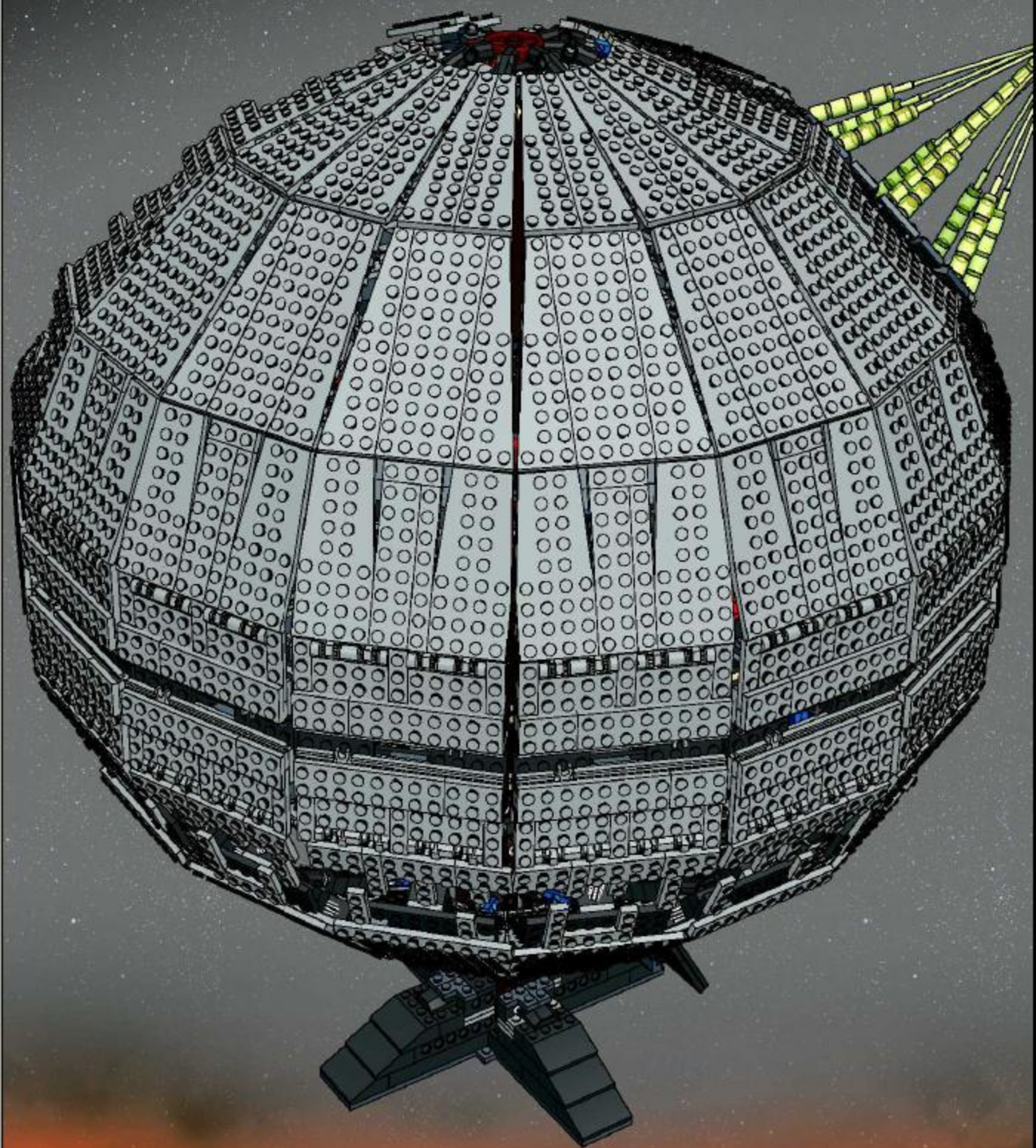

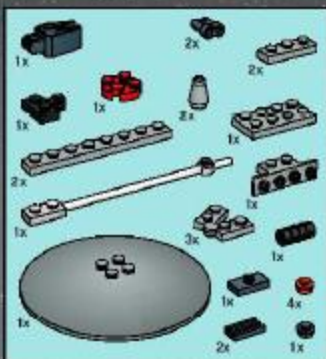

35

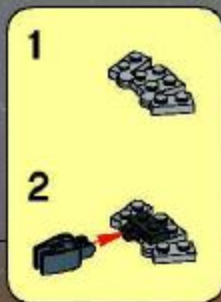

5

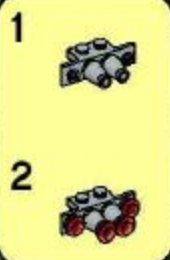

6



7



8



