



TOWN PLAN

10184-1

2008

Kjeld Kirk Kristiansen

Grandson of Founder and Owner of the LEGO Group

1958

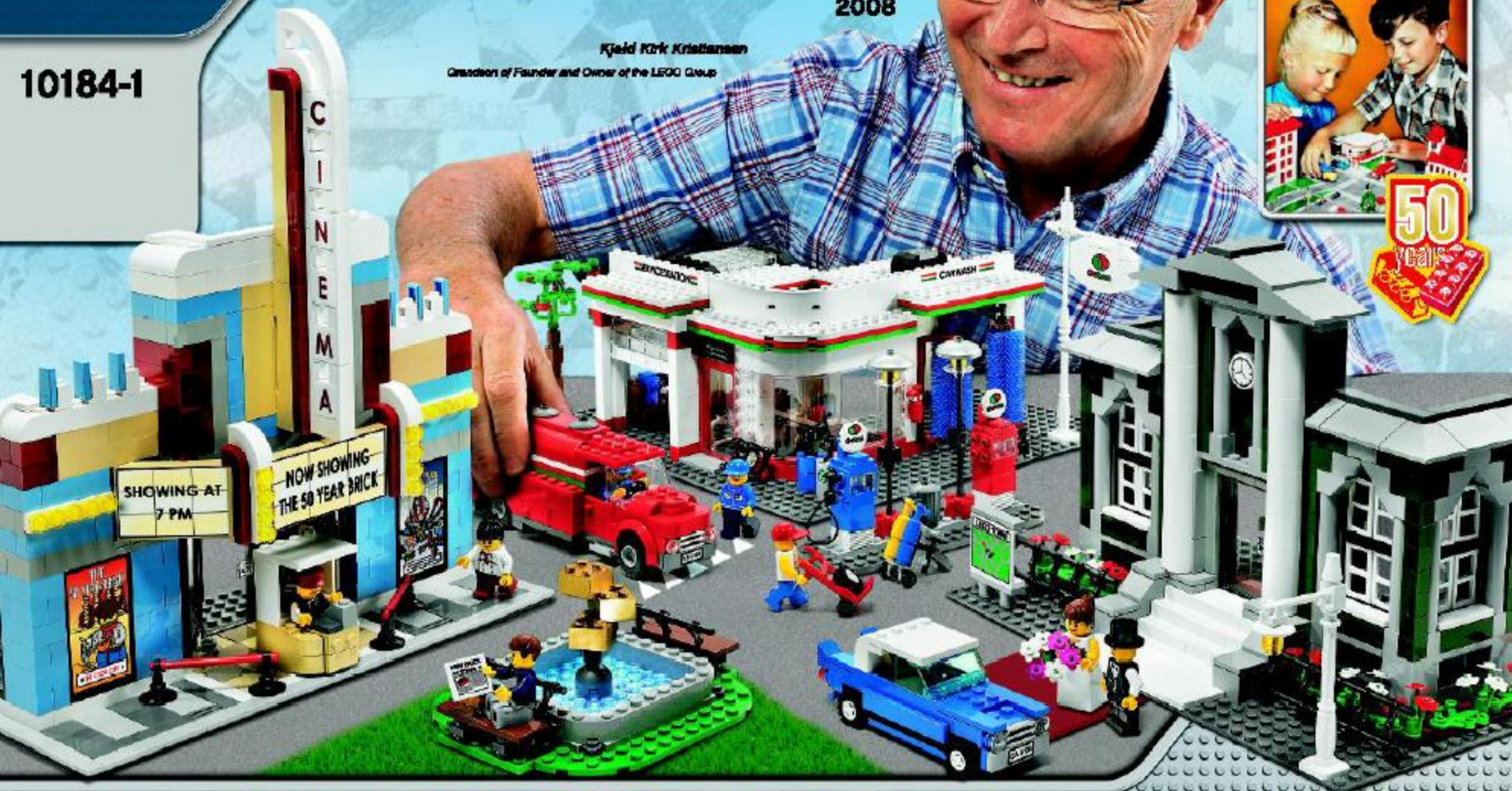



Dear LEGO consumer

It has been a real pleasure to help design this anniversary model, with 2008 marking the 50th anniversary of the original LEGO® brick patent.

Designing the model has led me to think back to my own childhood games, and to the many years it took to develop the LEGO brick as we know it today.

The first LEGO bricks, launched in 1949, were hollow and had slots in each end where you could attach windows and doors. The LEGO name, however, was not placed on all of the bricks. This only became standard practice in 1964, when the LEGO logo was stamped into the top of the hollow element. In 1968, the LEGO name was placed instead on the brick knobs. This repositioning of the name stresses the extensive work undertaken in the form workshop to improve the brick's clutching power – something my father, Godfred Kirk Kristiansen, was heavily involved in.

Improving the LEGO brick's clutching power is about two things: first, the company's fundamental belief in the unlimited possibilities of play, i.e. anything can be built using LEGO elements, and second, my grandfather Ole Kirk Kristiansen's philosophy that when it comes to children "Only the best is good enough".

One early brick prototype had two tubes inside, but it was never marketed because it just wasn't good enough. Finally, in 1957, the solution was found – a brick with three tubes inside that had a perfect three-point connection.

My father was well aware that the discovery might inspire others to find similar solutions. So he continued to search for alternative ways to achieve clutching power.

This resulted in four different alternatives; one was a brick with three crosses instead of tubes, which was used in a LEGO product sold in Italy and Japan.

On 28 January 1958, at precisely 13:58, my father filed for "a patent in Denmark for play building blocks" including drawings and the principles of plastic mold injection. The patent has since been registered in 33 countries.

Since then, my grandfather's dream that every child in the world should be able to play with LEGO bricks has come true. To date more than 400,000,000,000 LEGO elements have been made. That means that, in theory, every person on earth has 62 LEGO elements.

Model 7001 was one of the first boxes to feature the new LEGO brick. It is therefore only natural that in this anniversary year we celebrate the LEGO brick with this special model – inspired by the LEGO System of Play box from 1958 featuring a garage, which was my favourite model back then.



Best regards,

Kjeld Kirk Kristiansen



Lieber LEGO Kunde

Es war mir eine große Freude an der Entwicklung dieses Jubiläummodells anlässlich des 50-jährigen Bestehens des LEGO® Stein-Originals mitzuwirken.

Während wir an dem Modell arbeiteten, musste ich an die Spielzeuge meiner Kindheit denken. Bis der LEGO Stein so aussah, wie wir ihn heute kennen, sind viele Jahre vergangen.

Die ersten LEGO Steine kamen im Jahr 1949 auf den Markt. Sie waren hohl und hatten seitliche Schlitze zum Anbringen von Fenstern und Türen. Der Name LEGO war allerdings nicht auf den Steinen zu finden. Der Schriftzug auf dem Hohlteil wurde erst im Jahr 1954 eingeführt. Seit 1956 befindet sich das Logo stattdessen auf den Knöpfen. Diese Entwicklung bezug auf den Aufwand, der in der Gusswerkstatt betrieben wurde, um die Verbindungsfestigkeit der Steine zu optimieren. Mein Vater, Godfred Kirk Christiansen, war maßgeblich an diesen Arbeiten beteiligt.

Für die Verbesserung der Verbindungsfestigkeit der LEGO Steine gab es zwei Beweggründe: Erstens der Grundgedanke des Unternehmens, dass mit LEGO Elementen einfach alles gebaut werden kann. Und zweitens die Philosophie meines Großvaters Ole Kirk Kristiansen, die darin festhält, dass für Kinder „nur das Beste gut genug ist“.

Die ersten Steinprototypen verfügten über zwei Innenröhren. Diese Version wurde aber nie verkauft, sie war einfach nicht gut genug. Im Jahr 1967 fand man die Lösung: Steine mit drei Röhren, die so die perfekte Dreipunktverbindung boten.

Mein Vater war sich der Tatsache bewusst, dass diese Entdeckung anderen den Anstoß dazu geben würde, ähnliche Lösungen zu entwickeln. Aus diesem Grund suchte er weiter nach alternativen Möglichkeiten für Verbindungssysteme.

Am Ende hatte er vier verschiedene Alternativen entwickelt. Eine bestand aus einem Stein mit drei Kreuzen anstatt der Röhren. Dieses System wurde in einem LEGO Produkt umgesetzt, das in Italien und Japan verkauft wurde.

Am 28. Januar 1958, exakt um 13.58 Uhr, meldete mein Vater in Dänemark ein Patent für das Baustein-Spielkonzept an. Dazu gehörten auch Zeichnungen und das Kunststoff-Spritzgussverfahren. Heute ist das Patent in 33 Ländern eingetragen.

Der Traum meines Großvaters, jedem Kind auf der Erde die Möglichkeit zu geben, mit LEGO Steinen zu spielen, ist heute Realität. Bis zum jetzigen Zeitpunkt wurden mehr als 400.000.000.000 LEGO Elemente hergestellt. Das bedeutet, dass theoretisch jede Person weltweit 62 LEGO Elemente besitzt.

Das Modell 7001 war das erste Set, das den neuen LEGO Stein enthielt. Es ist also ganz selbstverständlich, dass wir den LEGO Stein im Jubiläumjahr anhand dieses Modells feiern – inspiriert vom LEGO System im Spiel aus dem Jahr 1958, zu dem eine Werkstatt gehörte. Das war damals mein Lieblingsmodell.



Mit freundlichen Grüßen,

Kjeld Kirk Kristiansen



Chère cliente, cher client LEGO.

Cela a été pour moi un réel plaisir de contribuer à la création de ce modèle anniversaire, 2008 marquant le 60ème anniversaire du brevet de la brique originale LEGO®.

La création de ce modèle m'a fait repenser à mes propres jeux d'enfance, et aux nombreuses années qui ont été nécessaires pour développer la brique LEGO telle que nous la connaissons aujourd'hui.

Les premières briques LEGO, lancées en 1949, étaient creuses et comportaient des fentes à chaque extrémité où il était possible d'attacher des fenêtres et des portes. Le nom LEGO n'était cependant pas placé sur toutes les briques. Ceci n'est devenu une pratique standard qu'en 1964, lorsque le logo LEGO a été apposé sur le dessus de l'élément creux. En 1966, le nom LEGO a été placé plutôt sur les noeuds des briques. Ce repositionnement du nom souligne le travail effectué dans l'atelier de moulage pour améliorer la puissance d'accroche de la brique, dans lequel mon père, Godtfred Kirk Christiansen, s'est beaucoup impliqué.

Améliorer la puissance d'accroche de la brique LEGO est lié à deux choses : premièrement, à la croyance fondamentale de l'entreprise dans des possibilités de jeu illimitées, c'est-à-dire que tout peut être construit à partir des éléments LEGO, et deuxièmement à la philosophie de mon grand-père Ole Kirk Kristiansen selon laquelle pour les enfants "Seul le meilleur est assez bon".

L'un des premiers prototypes de brique comportait deux tubes à l'intérieur, mais il n'a jamais été commercialisé car il n'était pas assez bon. La solution fut finalement trouvée en 1957, une brique avec trois tubes à l'intérieur qui avait une connexion à trois points parfaites.

Mon père était conscient du fait que cette découverte pouvait inspirer d'autres personnes à trouver des solutions similaires. Il a donc continué à chercher des façons alternatives d'obtenir une puissance d'accroche.

Quatre alternatives différentes ont ainsi vu le jour. L'une d'entre elles était une brique avec trois croix à la place des tubes, qui fut utilisée dans un produit LEGO vendu en Italie et au Japon.

Le 28 janvier 1958, à 13h58 précisément, mon père a déposé "une demande de brevet au Danemark pour des blocs de construction de jeu", comprenant des schémas et les principes de moulage plastique par injection. Le brevet a depuis été déposé dans 33 pays.

Depuis lors, le rêve de mon grand-père, qui voulait que tous les enfants du monde puissent jouer avec les briques LEGO, est devenu réalité. A ce jour, plus de 400 000 000 000 éléments LEGO ont été fabriqués. Ceci signifie qu'en théorie chaque personne sur terre possède 62 éléments LEGO.

Le modèle 7001 a été l'une des premières boîtes comportant la nouvelle brique LEGO. Il est donc tout à fait naturel qu'en cette année d'anniversaire nous célébrions la brique LEGO avec ce modèle spécial, inspiré par le système LEGO de boîte de jeu de 1958, un garage, qui était à l'époque mon modèle préféré.



Melleures salutations,

Kjeld Kirk Kristiansen



#### Estimado consumidor de LEGO

Ha sido un auténtico placer colaborar en el diseño de este modelo, que celebrará en 2008 el quincuagésimo aniversario de la patente original del ladrillo LEGO®.

El diseño de este modelo me ha llevado a recordar mis juegos de niño, y los años que necesitamos para desarrollar el ladrillo LEGO tal y como lo conocemos hoy.

Los primeros ladrillos LEGO que aparecieron en 1949 eran huecos y tenían ranuras en cada extremo que permitían colocar ventanas y puertas. No obstante, no en todos los ladrillos aparecía el nombre de LEGO. Esta práctica sólo comenzó a realizarse con normalidad a partir de 1964, cuando se imprimió el logotipo de LEGO sobre cada uno de los elementos. En 1956 se cambió de posición y se colocó sobre los puntos de conexión. Este cambio de posición del nombre pone de manifiesto el gran trabajo que se realizó en los talleres para mejorar la potencia de conexión del ladrillo; algo en lo que mi padre, Godtfred Kirk Christensen, estuvo activamente implicado.

Mejorar la potencia de conexión de los ladrillos LEGO se basó en dos cosas: la primera, la creencia fundamental de la compañía en sus ilimitadas posibilidades de juego (todo puede construirse con elementos LEGO), y segundo, la filosofía de mi abuelo, Ote Kirk Kristiansen, de que para los niños "sólo lo mejor es suficientemente bueno".

Un primer prototipo de ladrillo tenía dos tubos dentro, aunque nunca se comercializó porque no era lo suficientemente bueno. Finalmente se encontró la solución en 1957: un ladrillo con tres tubos en su interior que tenía una conexión de tres puntos perfecta.

Mi padre sabía muy bien que el descubrimiento podría inspirar a otros a buscar soluciones similares. Así que continuó buscando otras formas de conseguir una mayor potencia de conexión. De su búsqueda surgieron cuatro alternativas, una de ellas fue un ladrillo con tres cruces en lugar de tubos, que se utilizó en un producto LEGO distribuido en Italia y Japón.

El 28 de enero de 1958, exactamente a las 13:58, mi padre solicitó "una patente en Dinamarca para un juego de bloques de construcción" que incluía diagramas y los principios de inyección en moldes de plástico. Desde entonces, la patente se ha registrado en 33 países.

Hoy, el sueño de mi padre de que todos los niños del mundo pudieran jugar con los ladrillos LEGO se ha hecho realidad. Hasta la fecha se han fabricado más de 400.000.000.000 de elementos LEGO. Eso significa que, en teoría, cada persona del mundo tiene 82 elementos LEGO.

El modelo 7001 fue el primero en incluir el nuevo ladrillo LEGO. Por tanto, es natural que en este año de aniversario celebremos el ladrillo LEGO con este modelo especial, inspirado en el sistema de bloques LEGO de 1958 con el que podía construirse un garaje, mi favorito por aquel entonces.



Un cordial saludo,

Kjeld Kirk Kristiansen



#### Estimados clientes LEGO

Foi um grande prazer ajudar na concepção do design deste modelo de aniversário, com 2008 a marcar o 50º aniversário da patente da peça original LEGO®.

O trabalho de design deste modelo fez-me recordar os jogos da minha infância, e os muitos anos que foram necessários para desenvolver a peça LEGO que conhecemos hoje.

As primeiras peças LEGO, lançadas em 1949, eram côncavas e tinham fendas em cada extremidade para poderem ser encaixadas janelas e portas. O nome LEGO, todavia, não era colocado em todas as peças. Isso só passou a ser prática generalizada em 1954, quando o logótipo LEGO passou a ser afixado na parte superior do elemento côncavo. Em 1956, o nome LEGO passou em vez disso a ser colocado nas saliências da peça. Este novo posicionamento do nome enfatiza o extenso trabalho levado a cabo no primeiro workshop destinado a melhorar o poder de encaixe da peça – algo em que o meu pai, Godtfred Kirk Christensen, se comprometeu profundamente.

Melhorar o poder de encaixe da peça LEGO significa duas coisas: primeiro, a convicção fundamental da empresa nas possibilidades ilimitadas de jogo, i.e. tudo pode ser construído com as peças LEGO, e segundo, a filosofia do meu avô Ole Kirk Kristiansen de que quando se trata de crianças, "só o melhor é suficientemente bom".

Um protótipo inicial da peça tinha dois tubos no interior, mas nunca foi comercializado porque simplesmente não era tão bom quanto desejado. Finalmente, em 1957, foi encontrada a solução – uma peça com três tubos no interior que tinha uma conexão de três pontos perfeita.

O meu pai sabia que a descoberta poderia inspirar outros a encontrar soluções similares. Por isso continuou à procura de caminhos alternativos para conseguir o desejado poder de encaixe. Isto resultou em quatro alternativas diferentes; uma foi uma peça com três cruzes em vez de tubos, a qual foi utilizada num produto LEGO vendido em Itália e no Japão.

Em 28 de Janeiro de 1958, precisamente às 13:58, o meu pai registou "uma patente na Dinamarca para blocos de jogo de construção" que incluía desenhos e princípios da injeção da moldagem de plástico. A patente foi desde então registada em 33 países.

Desde então, o sonho do meu avô de que todas as crianças no mundo deveriam ser capazes de brincar com peças LEGO tornou-se realidade. Foram feitos até à data mais de 400.000.000.000 elementos LEGO. Isso significa, teoricamente, que cada pessoa na terra tem 62 elementos LEGO.

O modelo 70071 foi um dos primeiros a apresentar a nova peça LEGO. É por isso muito natural que neste ano de aniversário celebremos a peça LEGO com este modelo especial – inspirado pelo sistema de jogo LEGO de 1959 apresentando uma garagem e que foi o meu modelo favorito naquele tempo.



Com os melhores cumprimentos,

Kjeld Kirk Kristiansen



Kedves LEGO Vásárlói

Nagy örömmre szolgál, hogy segíthettem ennek a jubileumi modellnek a tervezésében, amely a 2008-ban 50 éves, eredeti LEGO® építőelem szabadalom emlékére készült.

A modell tervezése felidézte bennem a gyermekkori játékok emlékét, és azt a sok-sok évet, amely a ma ismert LEGO építőelemek kifejlesztéséhez vezetett.

Az első LEGO építőelemek, amelyek 1949-ben jelentek meg, üregesek voltak és mindegyik oldalukon horony helyezkedett el, amelyekhez ablakot vagy ajtót lehetett erősíteni. A LEGO név azonban nem mindegyik építőelemen volt feltüntetve. Ez csak 1954-ben vált általánossá, amikor a LEGO logót az üreges elem tetőjére nyomták. Később, 1958-ban a LEGO név az építőelem bütökre került. A név áthelyezése kiemeli azt a széleskörű törekvényt, amely műhelymunka formájában az építőelemek csatlakozási erejének növelésére irányult, melynek kidolgozásában édesapám, Godtfred Kirk Kristiansen is törekvényt reoszt vett.

A LEGO építőelemek csatlakozási erejének növelése két alapgondolatra épült: elsősorban a vállalatnak a végtelen játéklehetőségekbe vetett hitére, azaz arra, hogy LEGO elemekből mindent meg lehet építeni, másrészt pedig nagyapám, Ole Kirk Kristiansen filozófiájára, amely szerint, ha gyermekekről van szó, akkor "csak a legjobb az, ami elég jó".

Egyik korai építőelem változat belsejében volt két cső, de ez sosem került a piacra, mert egyszerűen nem volt elég jó. Végül, 1957-ben megtaláltuk a megoldást: egy elemet, amelynek belsejébe három cső került, így tökéletes, hárompontos csatlakozást tett lehetővé.

Édesapám jól tudta, hogy a felfedezése másokat is hasonló megoldásokra inspirálhat. Folytatta tehát a csatlakozási erő fokozásának további lehetőségeit célzó kutatást.

Ez négy különféle megoldást hozott; az egyik a csövek helyett három keresztet eredményezett, amelyeket az Olaszországban és Japánban forgalmazott LEGO termékekben alkalmaztak.

1958. január 28-án, pontosan 13 óra 58 perckor édesapám benyújtott "egy az építőjáték elemre vonatkozó szabadalmat Dániában" amely a játék rajzait és a műanyag fröccsöntés alapelveit tartalmazta. A szabadalmat azóta 33 országban jegyezték be.

Azóta nagyapám álma, hogy a világon minden gyermek játszhasson a LEGO elemekkel, valóra vált. Mára már több mint 400 000 000 000 LEGO építőelem készült. Ez azt jelenti, hogy elméletileg a Föld minden polgárára 62 LEGO elem jut.

Mivel a 7001-es modell volt az új LEGO elemeket tartalmazó egyik játék, természetes, hogy ezen az évfordulón ezzel a különleges LEGO építőelemmel ünnepelünk, amelyet a LEGO System of Play doboz inspirált 1958-ban. Ebből egy garázst lehetett felépíteni, és az volt akkor a kedvencem.



Szívélyes üdvözléssel,

Kjeld Kirk Kristiansen

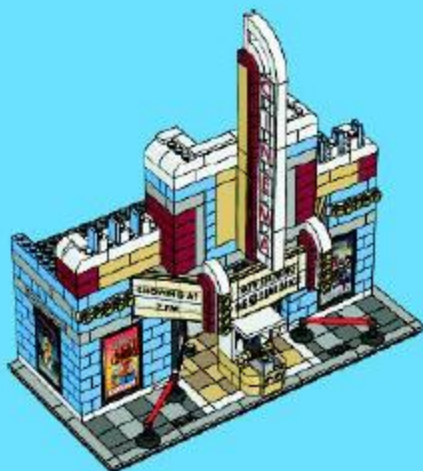



1

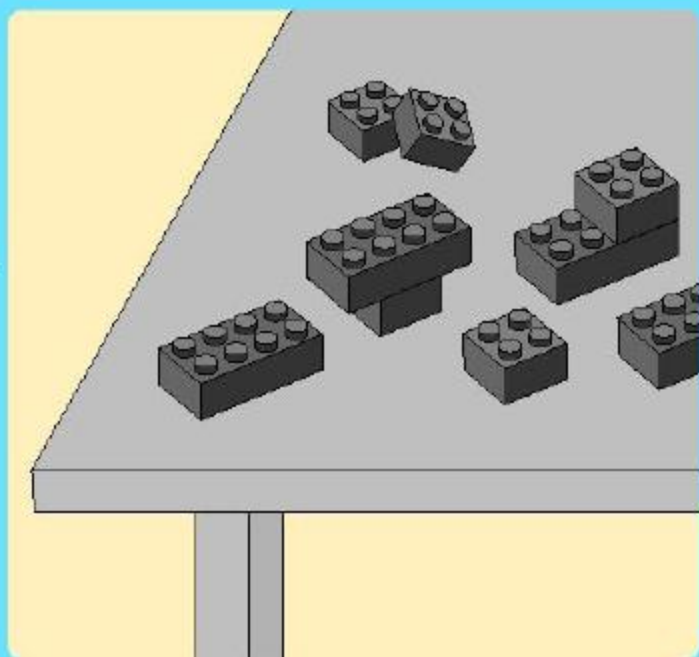
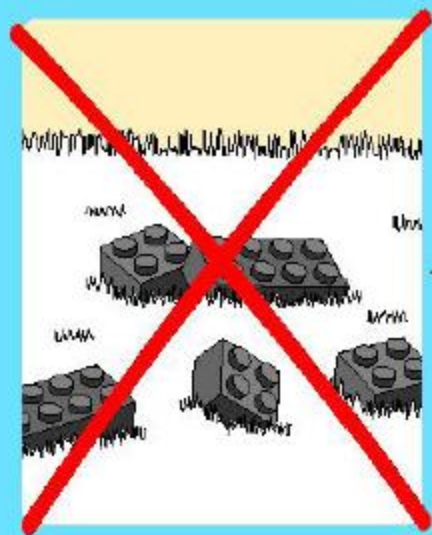

2



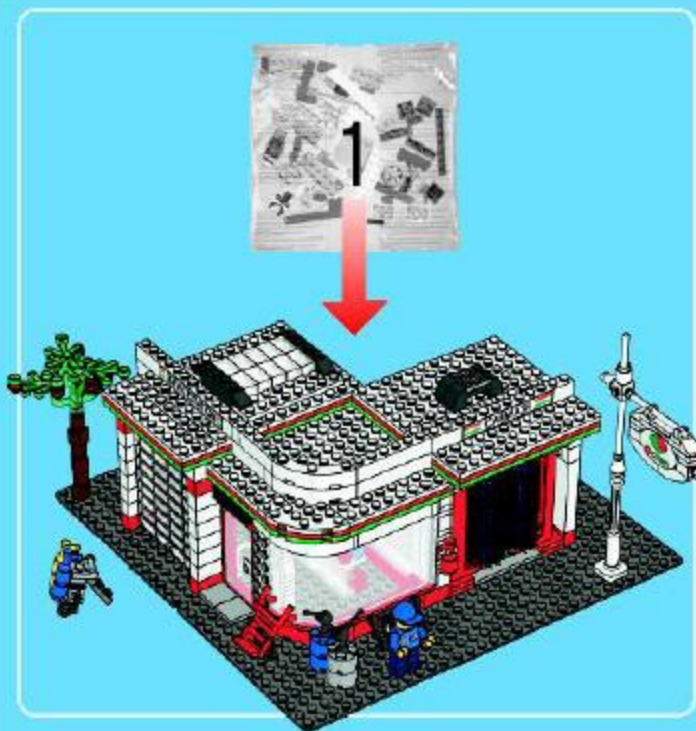

3

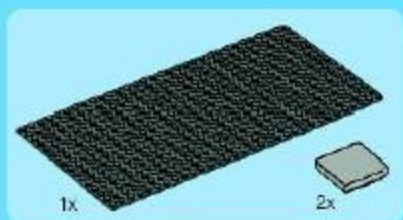

1

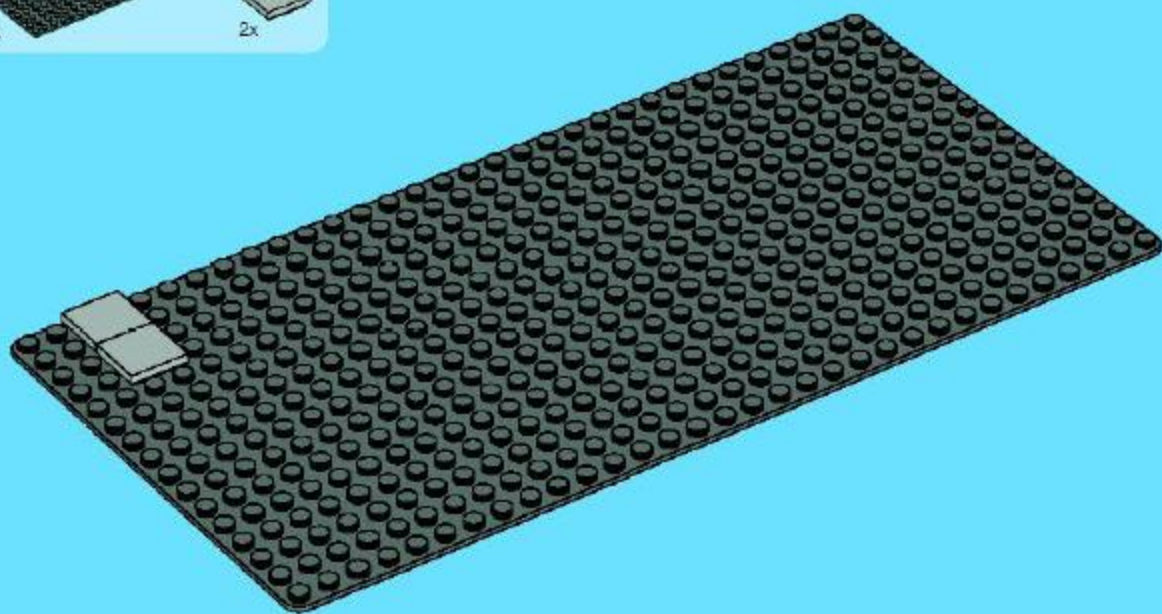

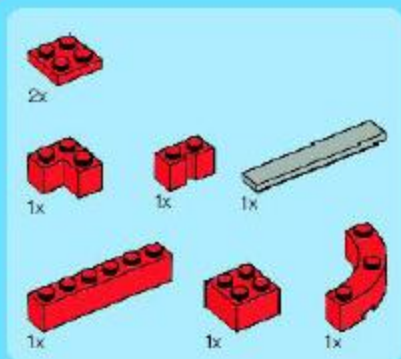

2

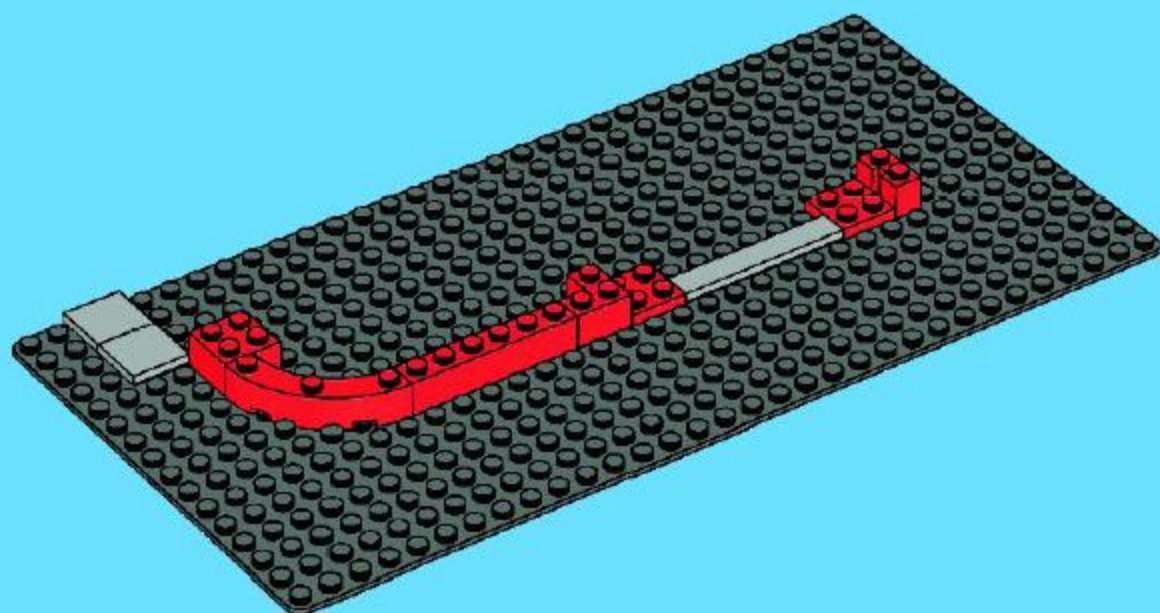

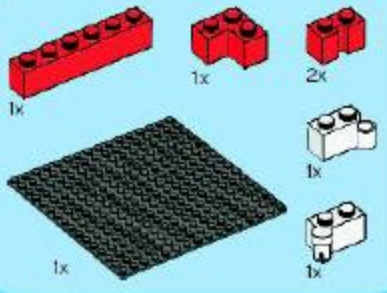

3

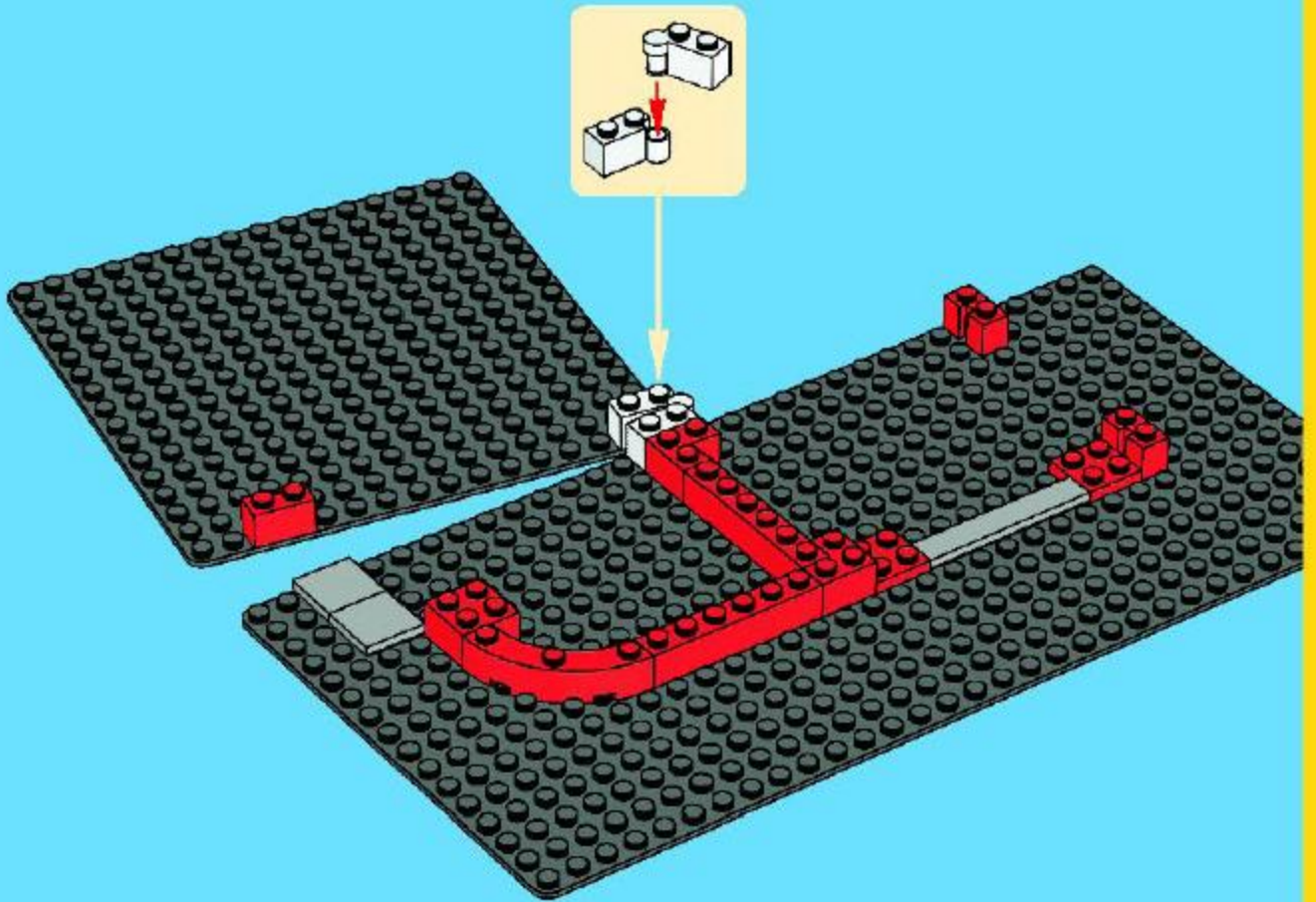

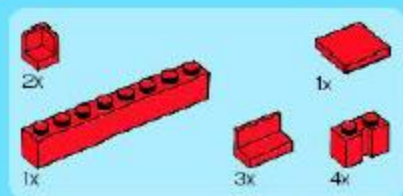

4

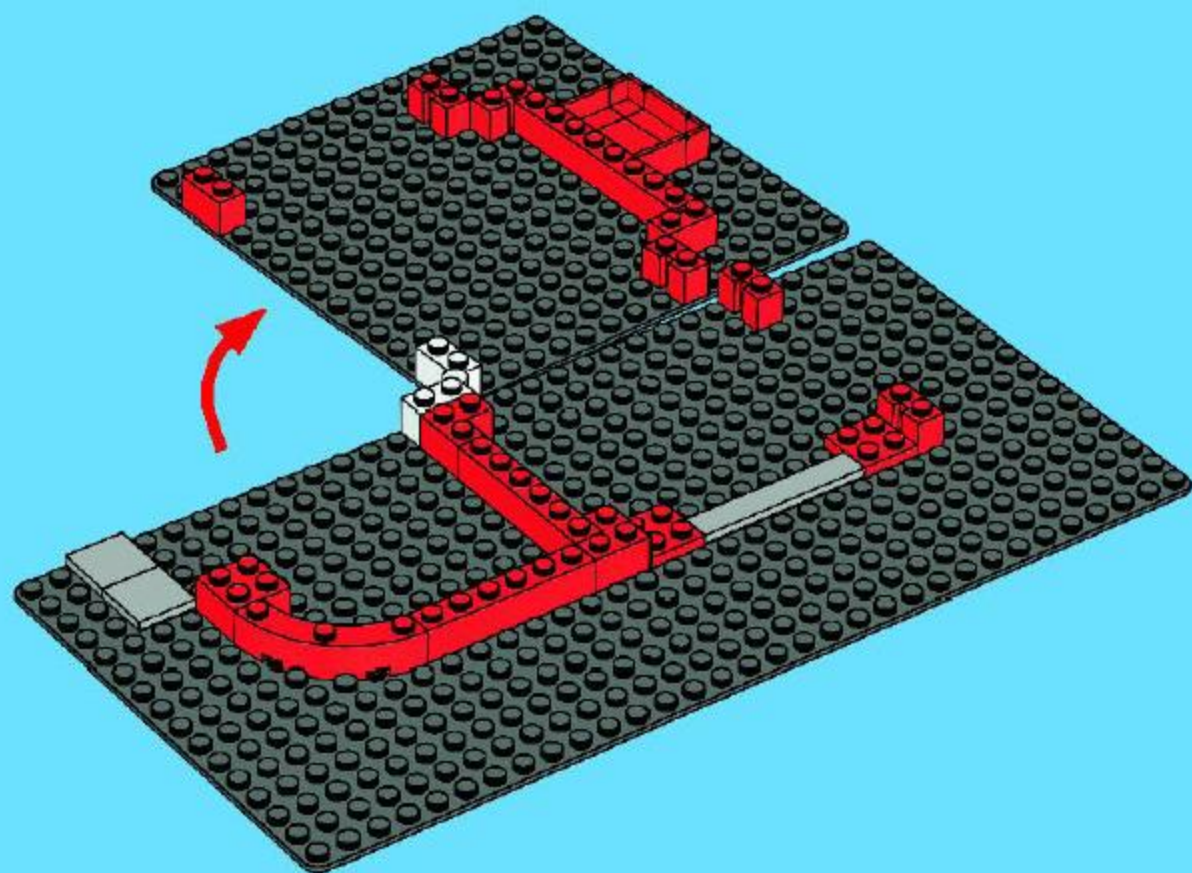



5

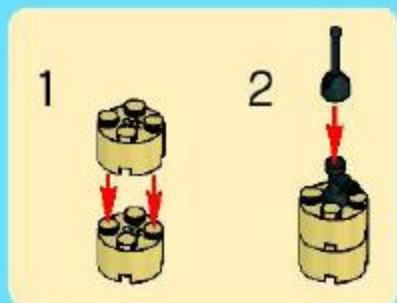



6

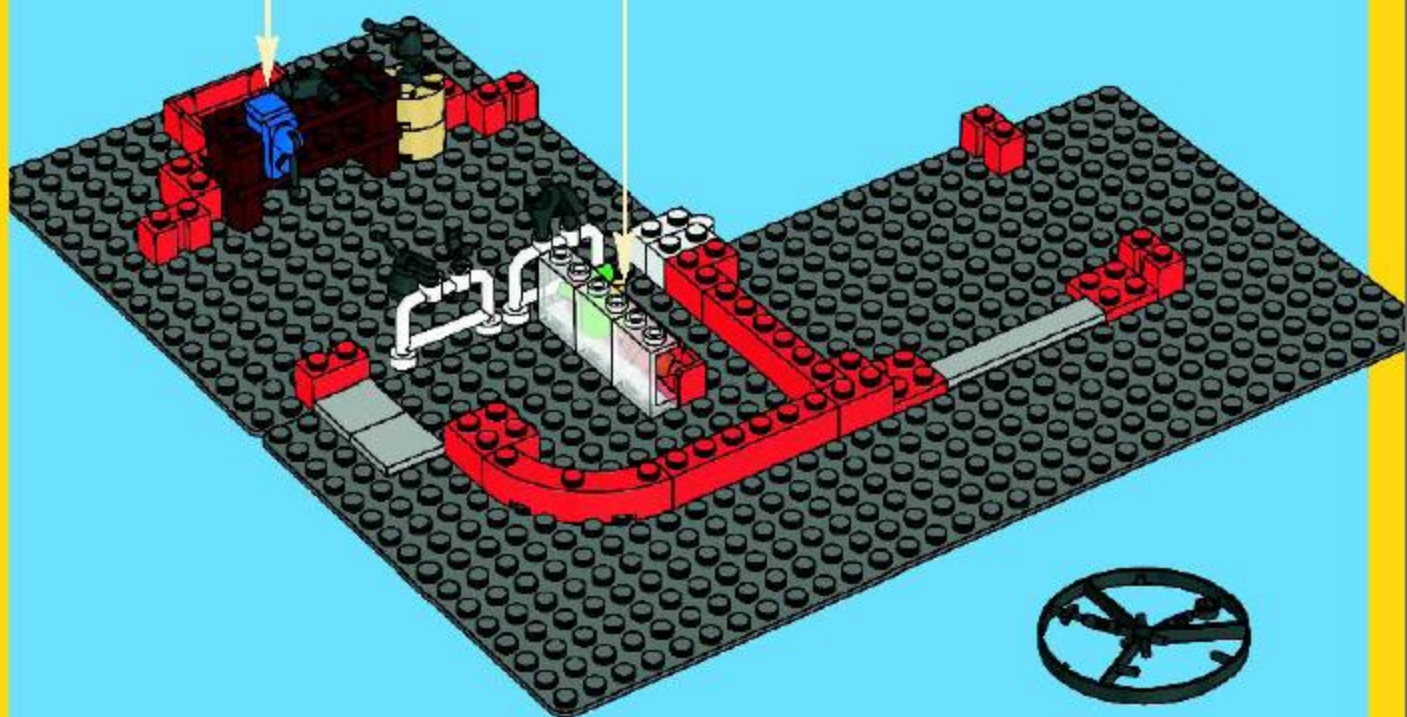
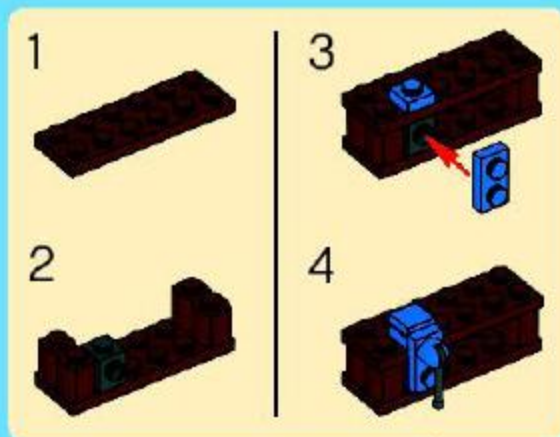





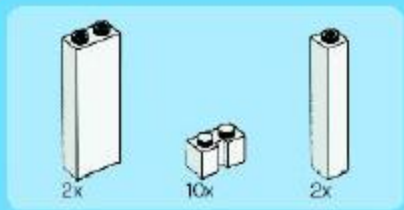

8

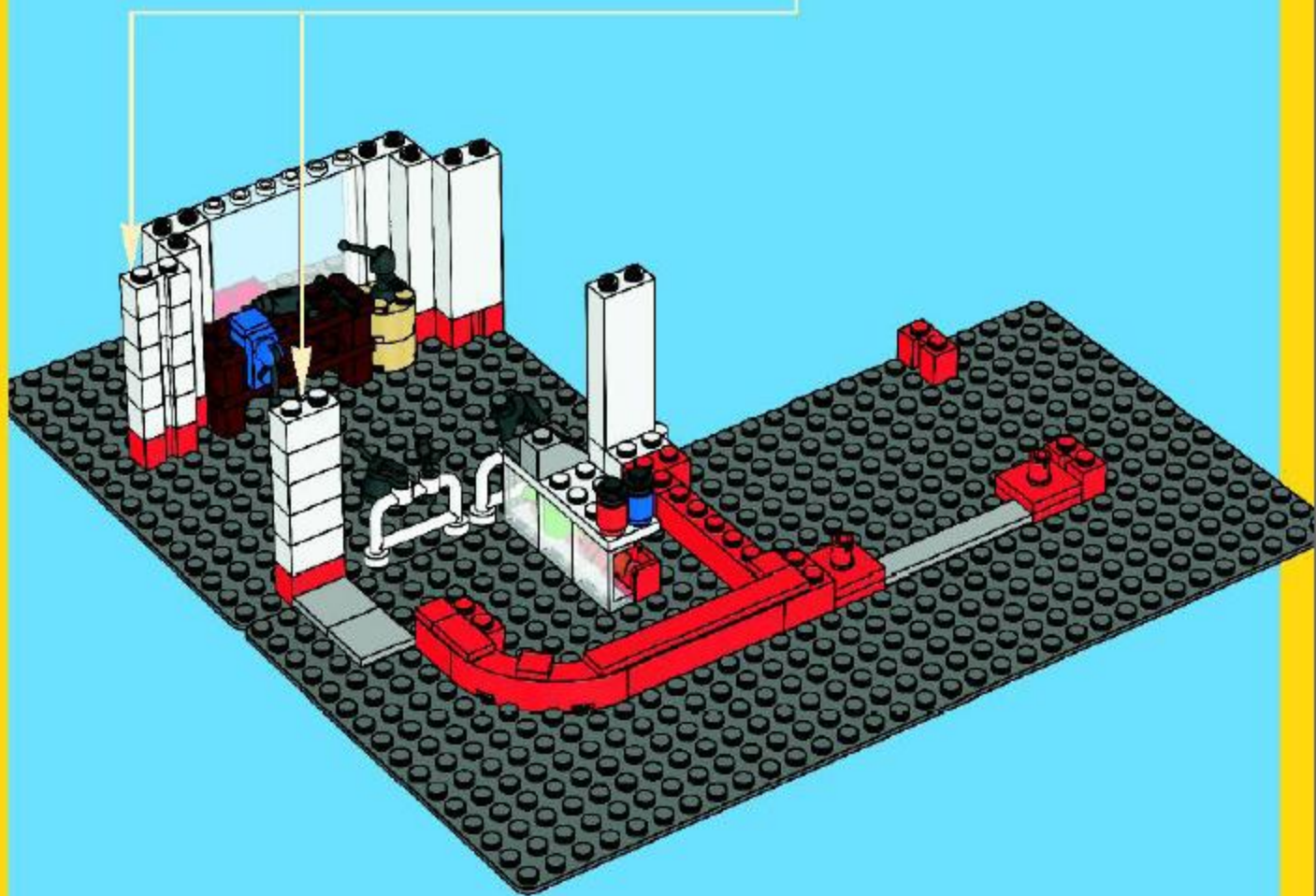
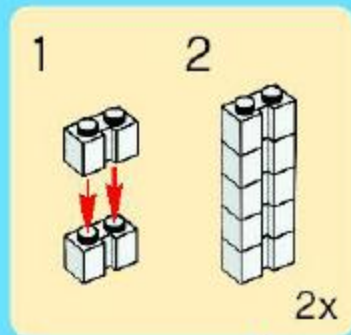

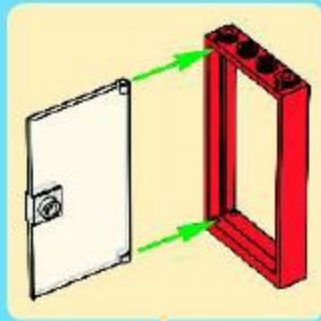
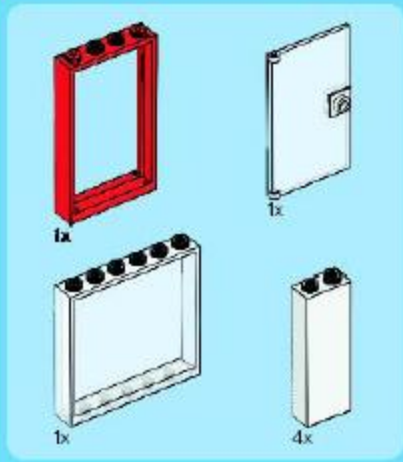

9

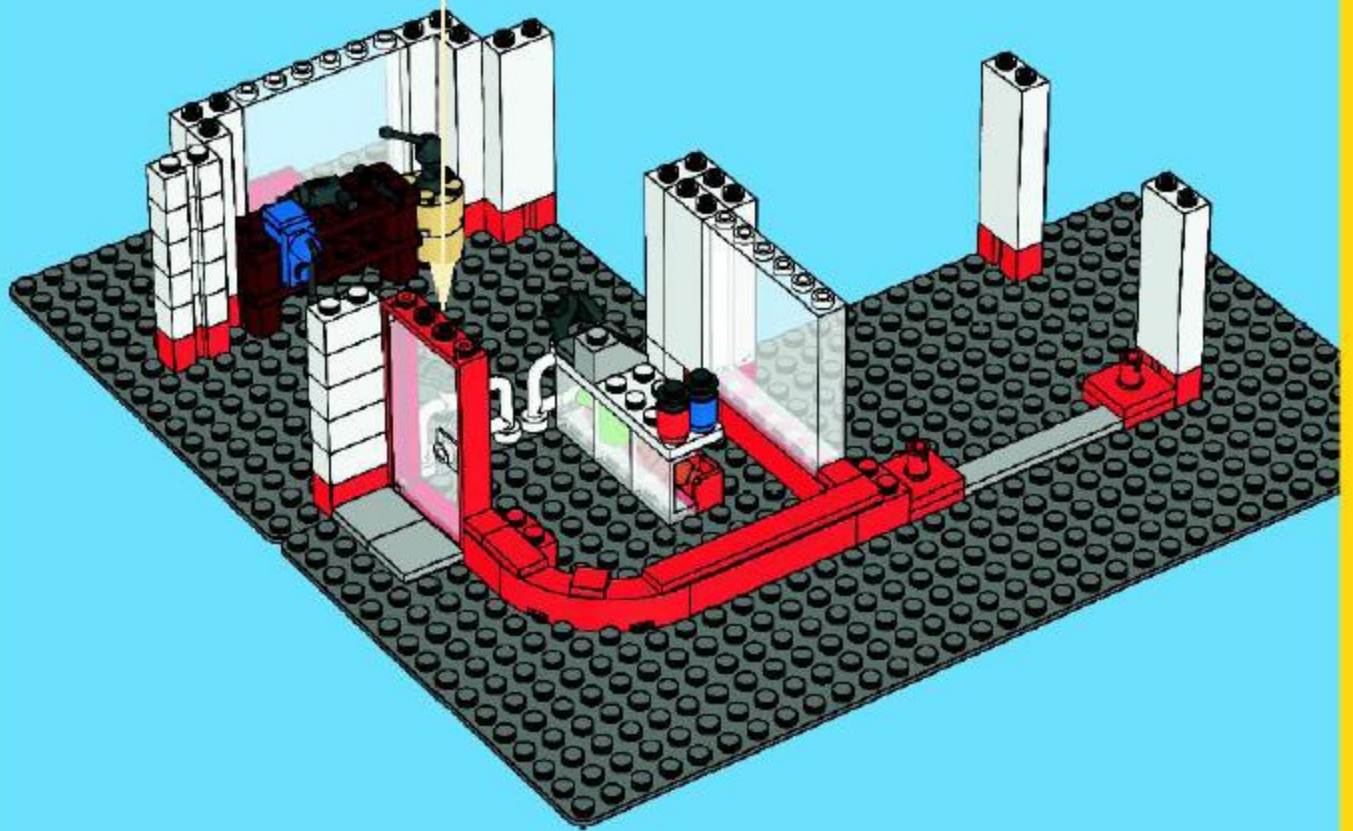

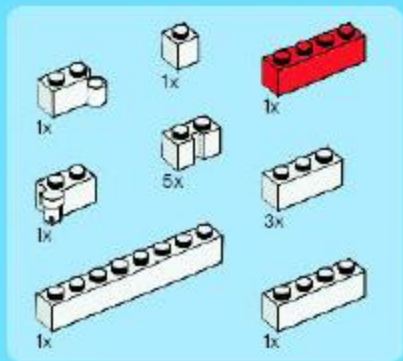

10

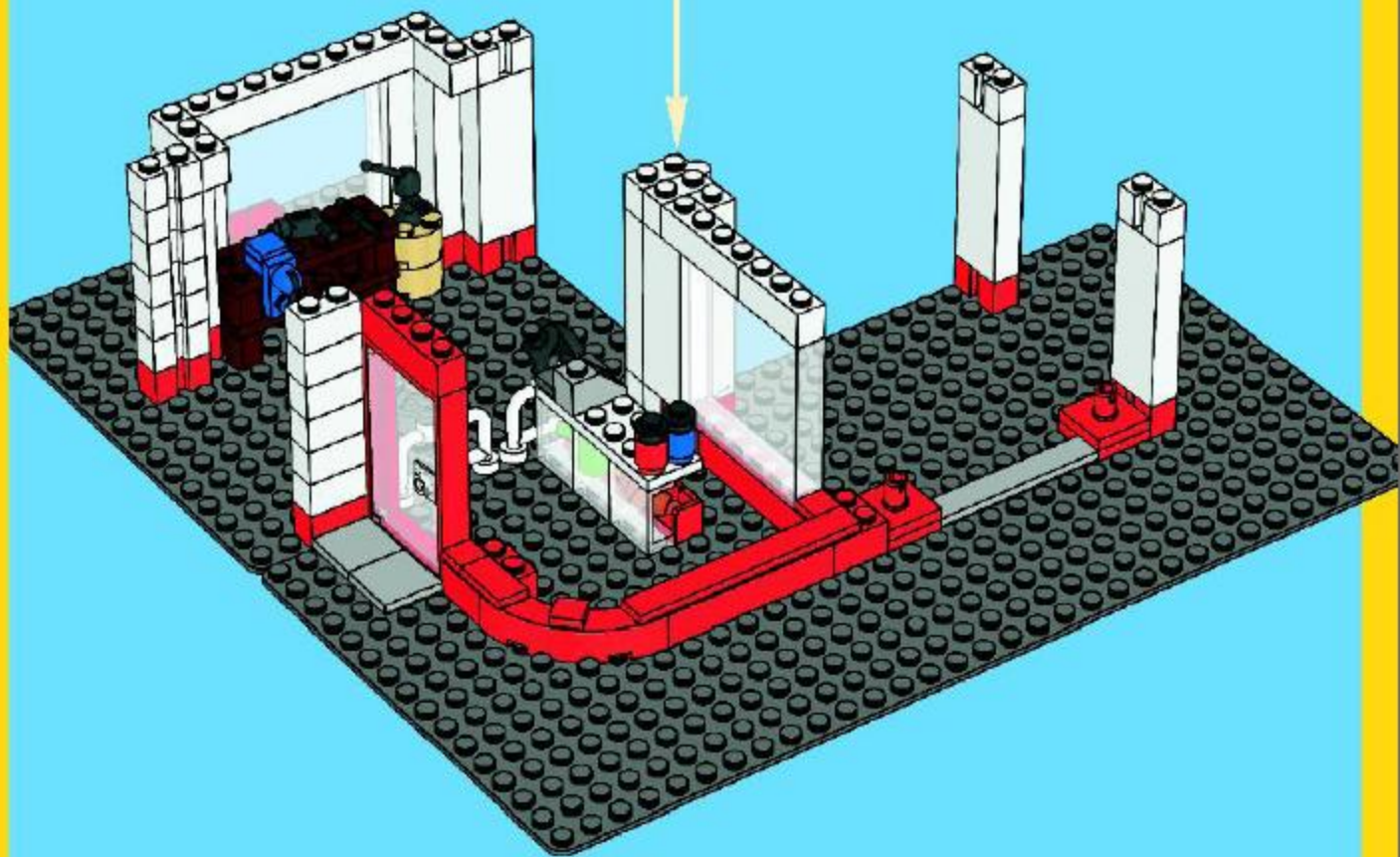

11

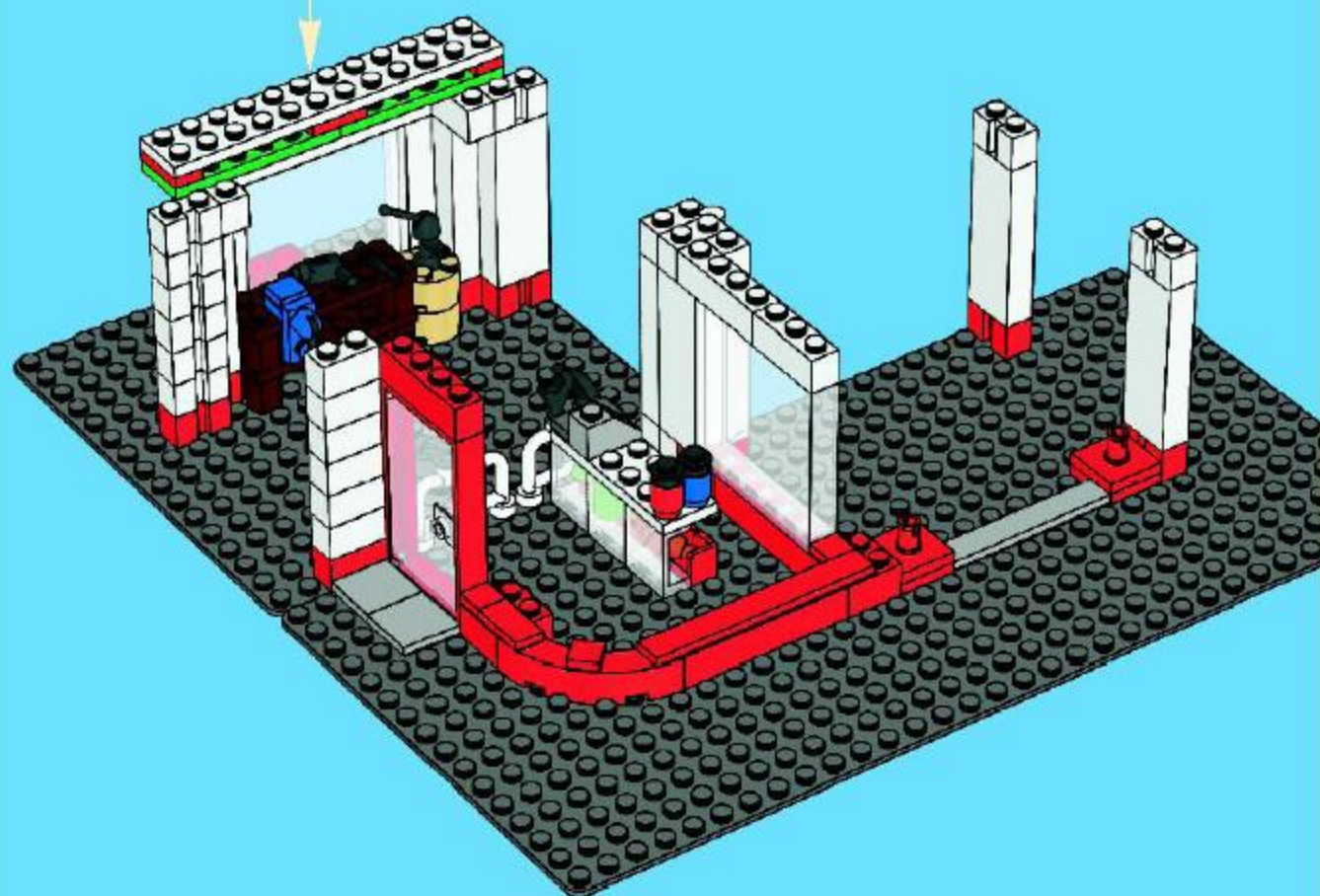
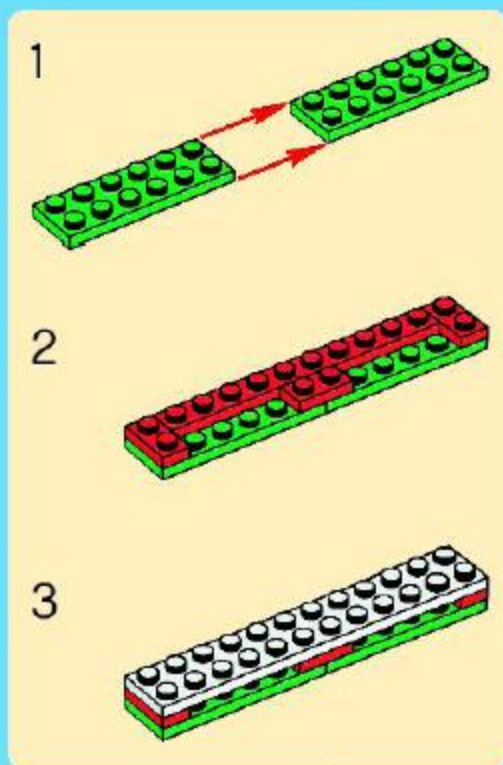
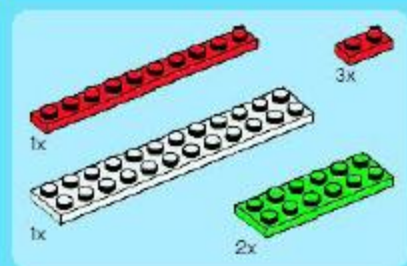

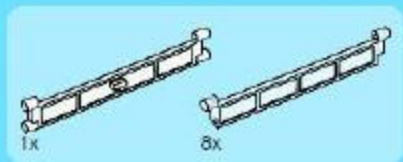

12

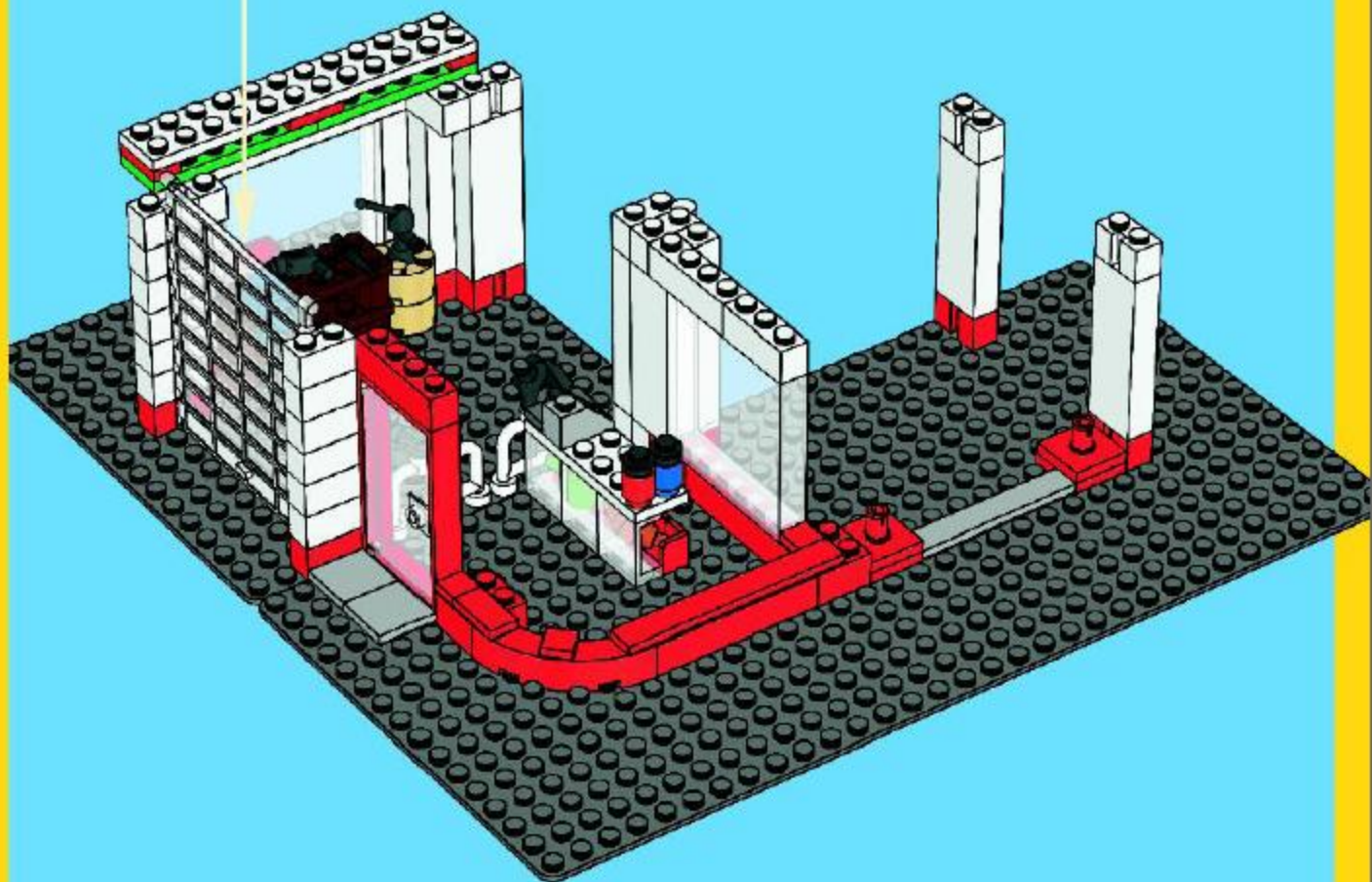
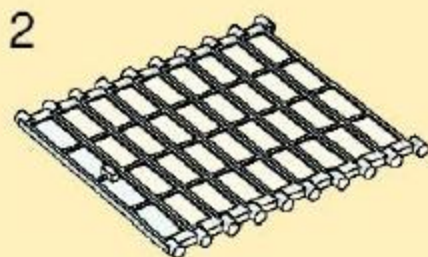
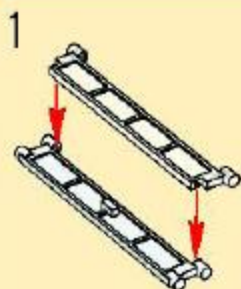

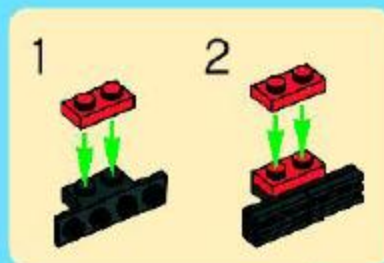
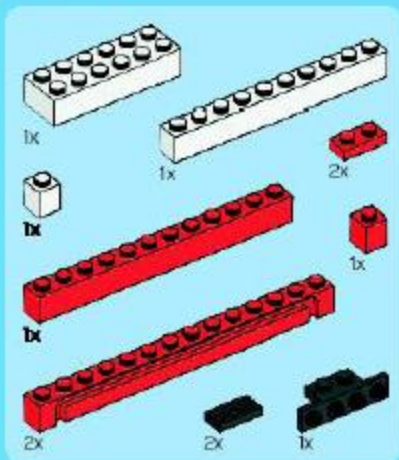

13

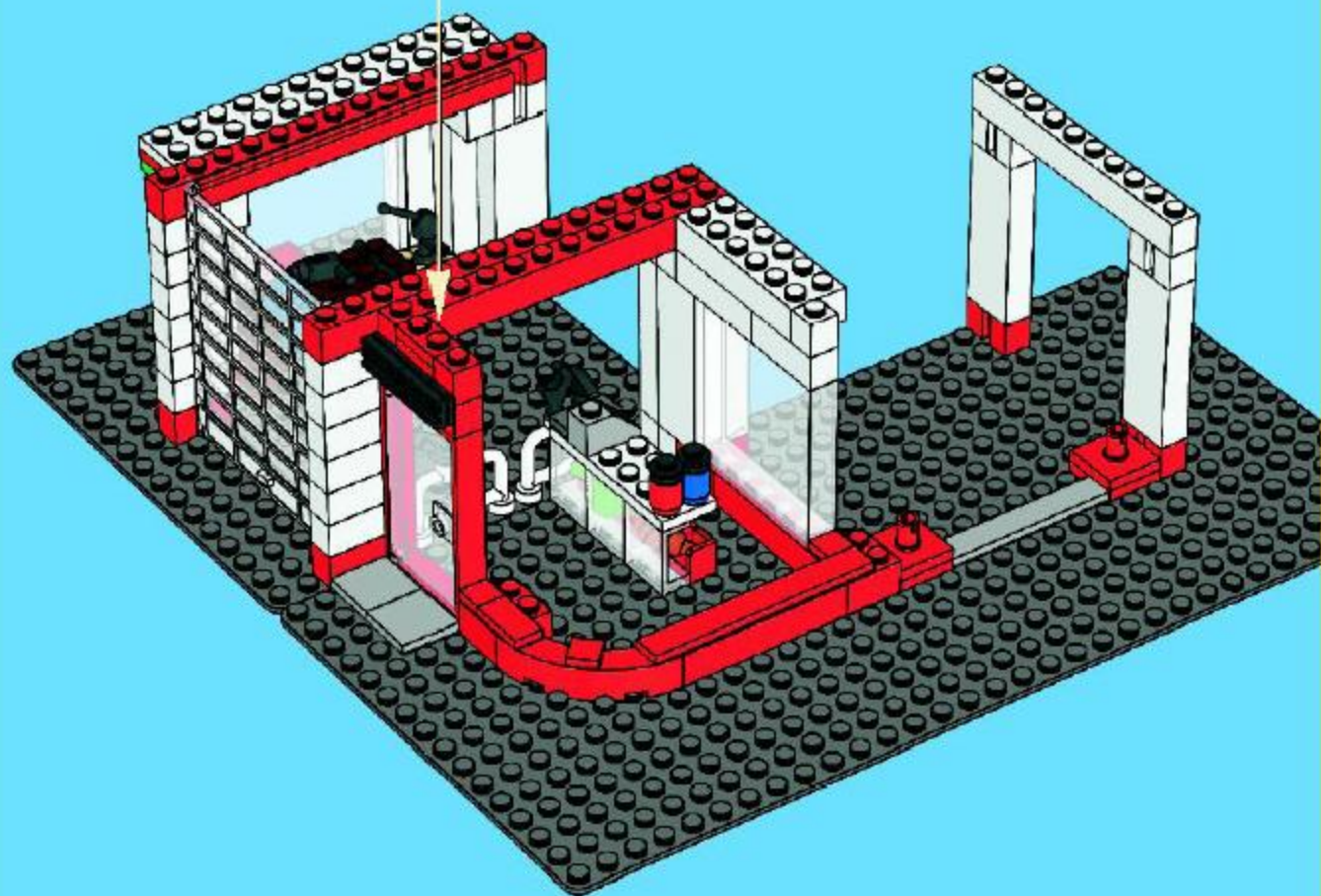

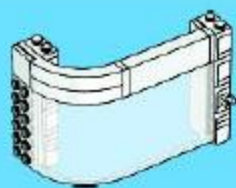

1



2



3



4



5

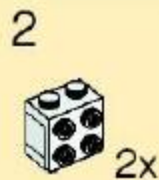
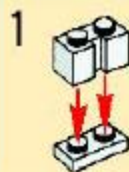

6

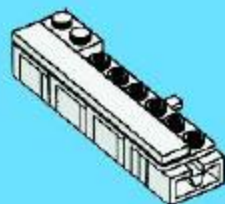

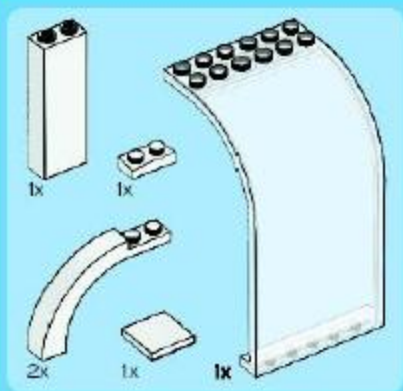

7

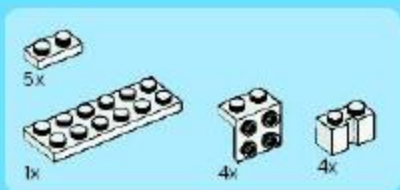
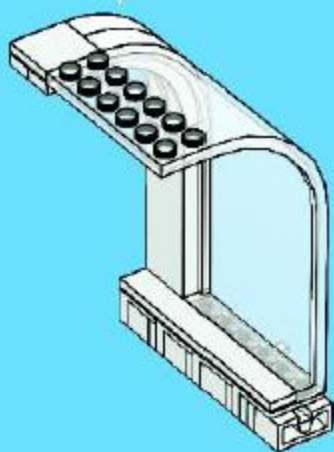
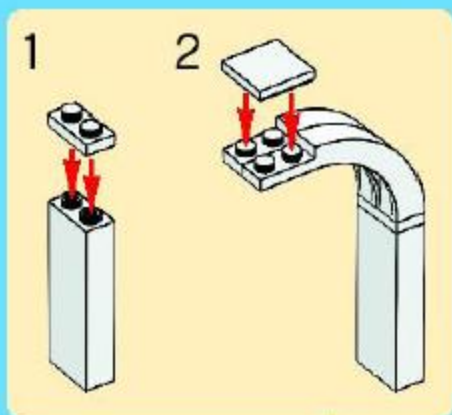

8

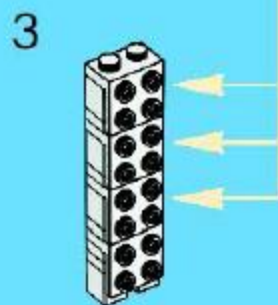
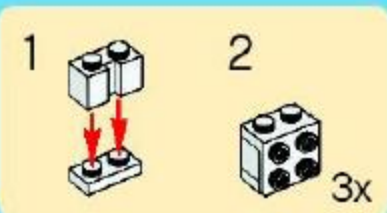
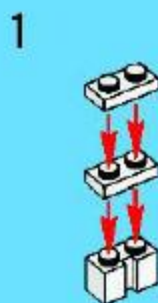



4

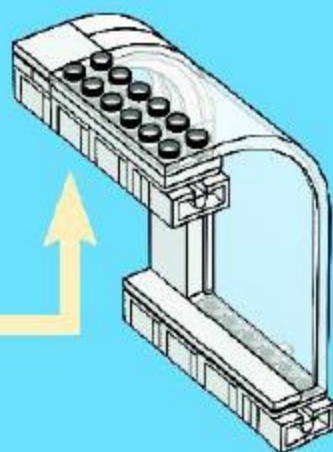
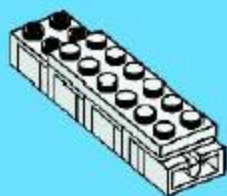

14

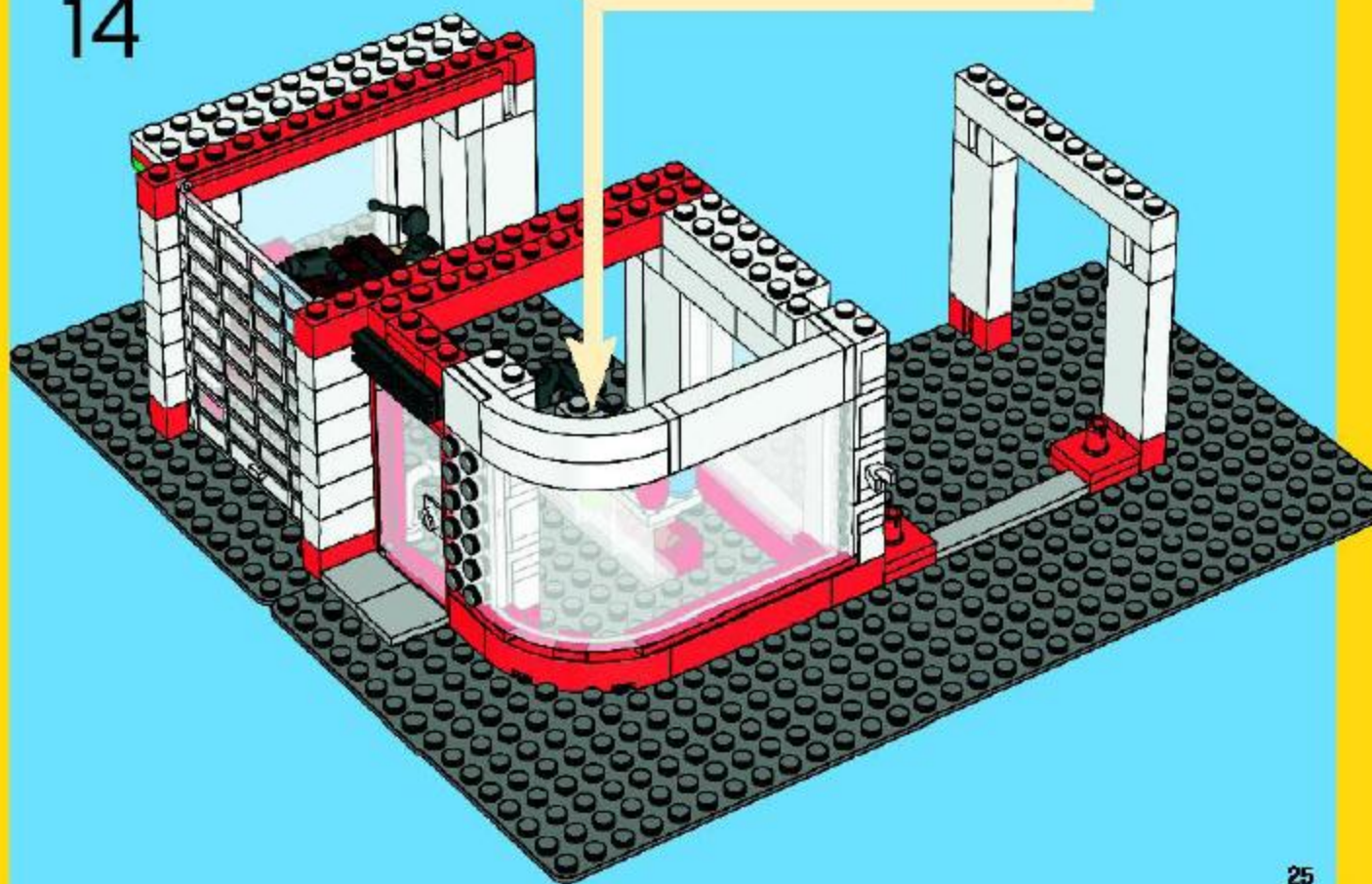

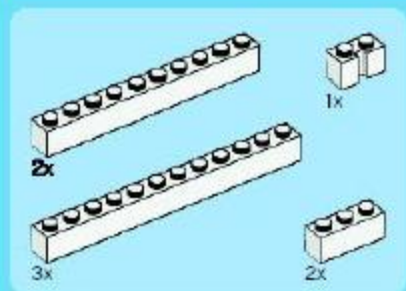

15

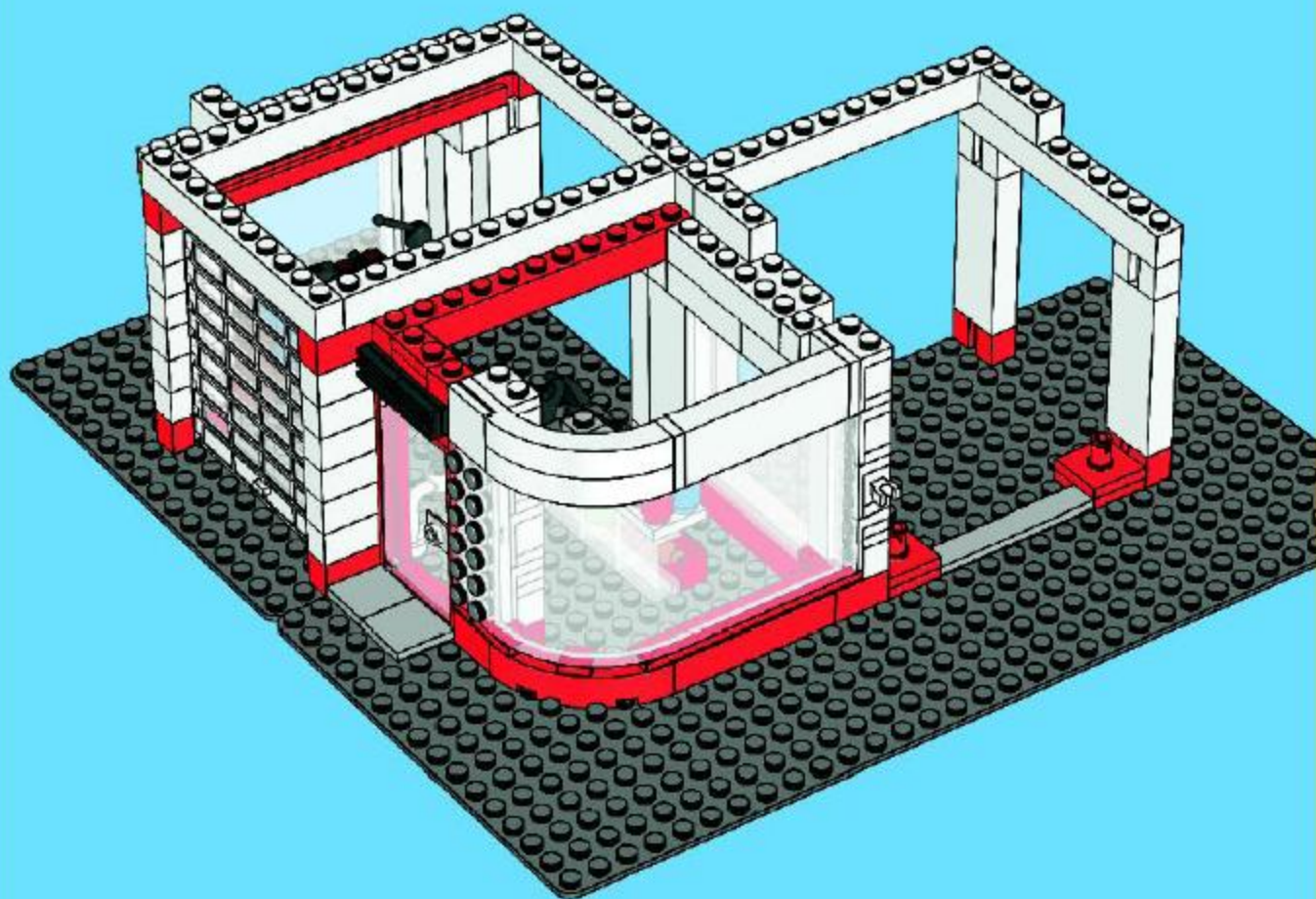

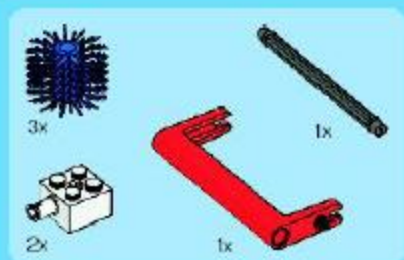

16

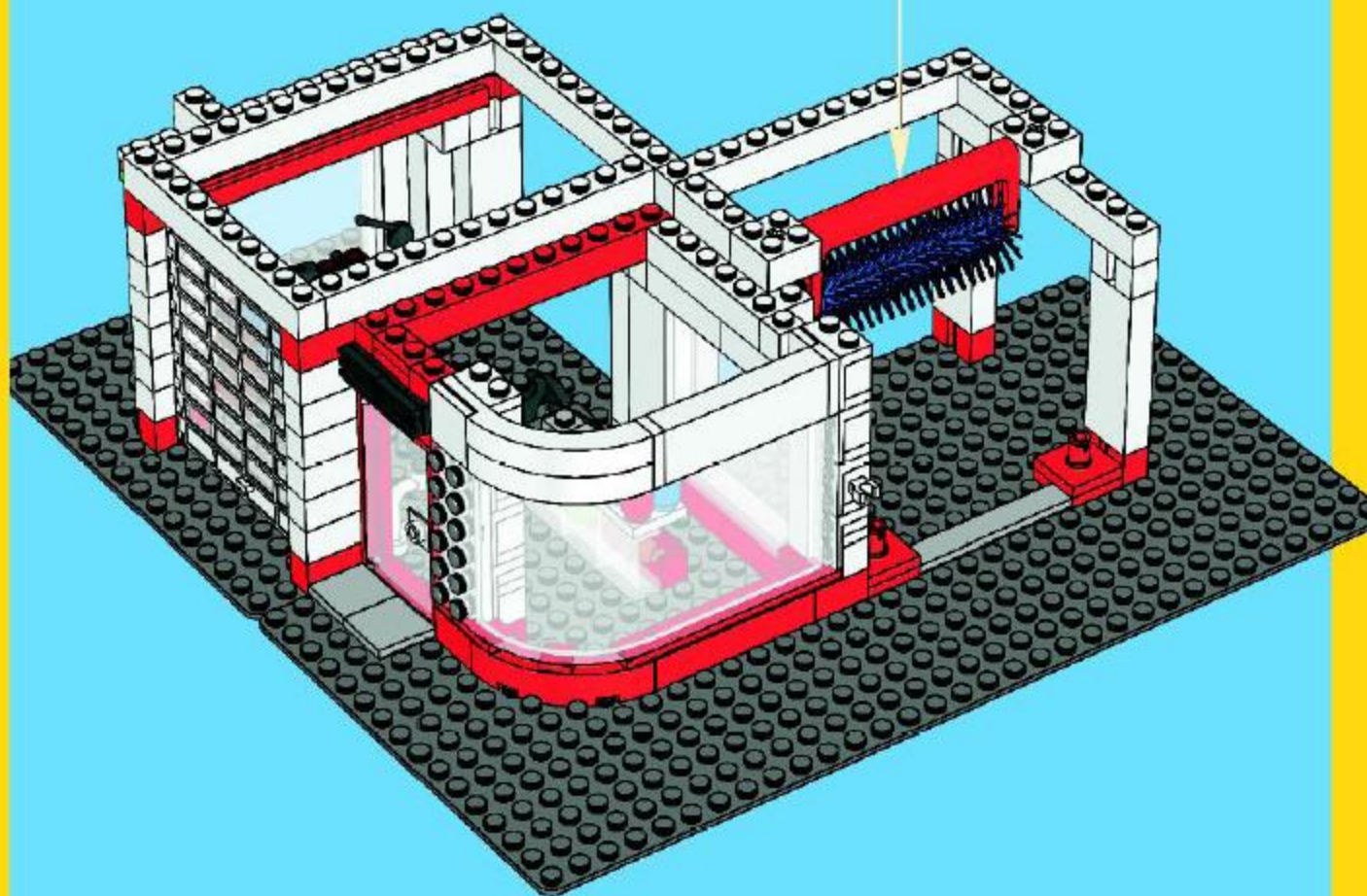
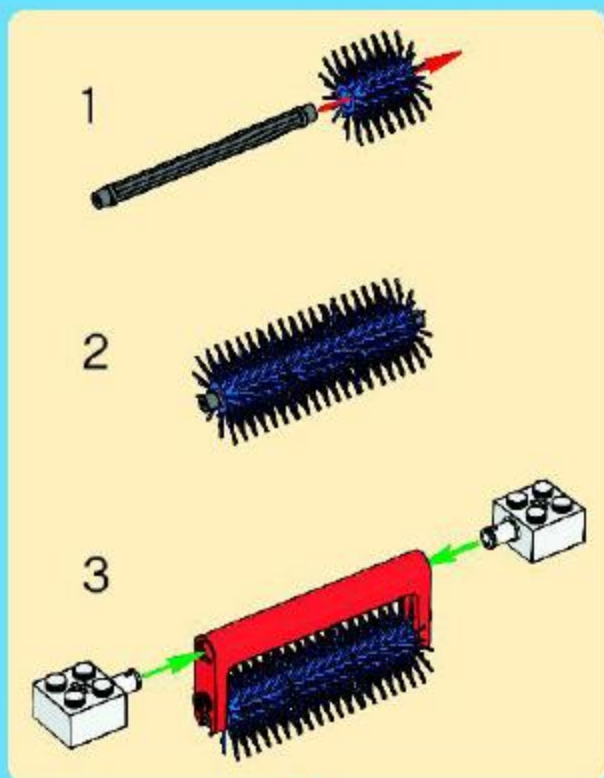

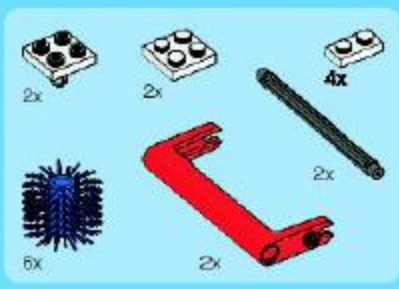

17

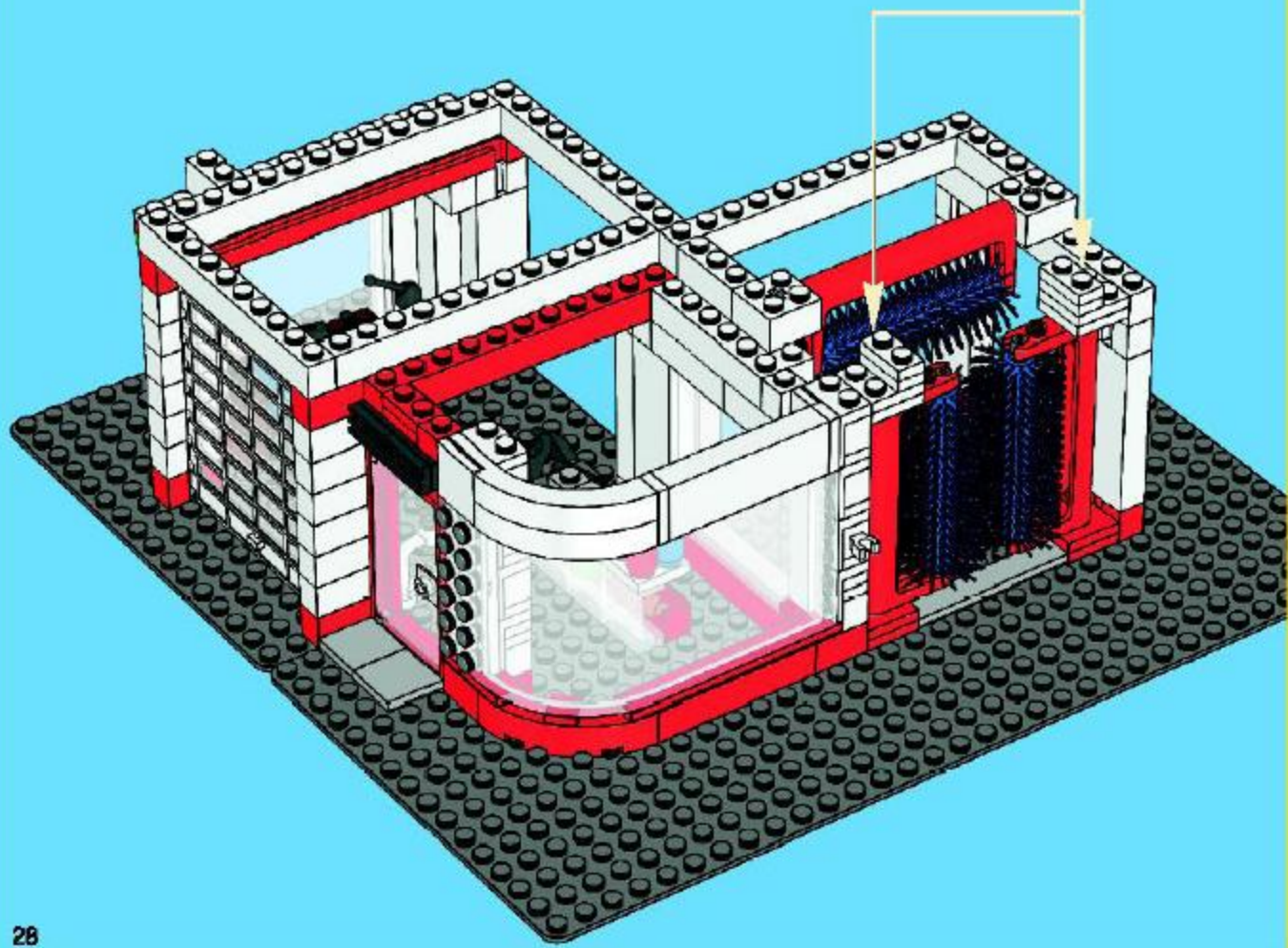
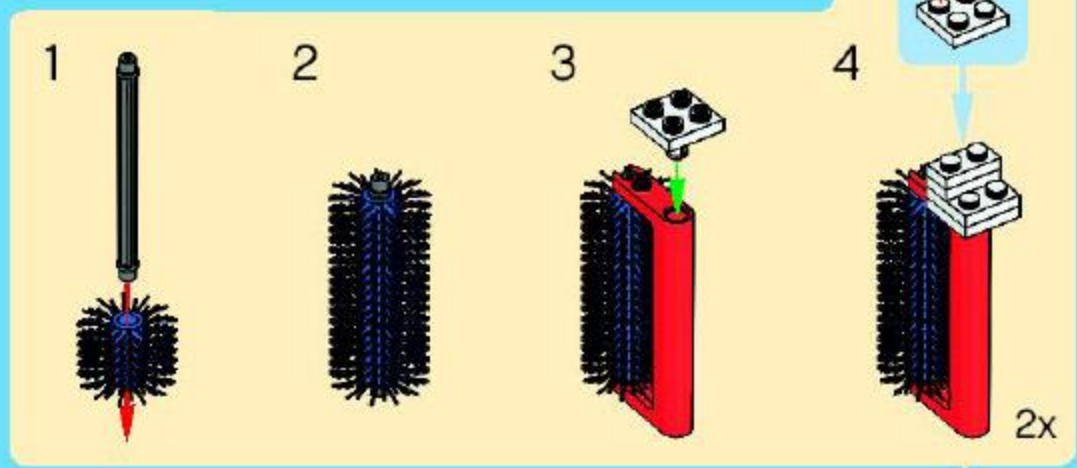

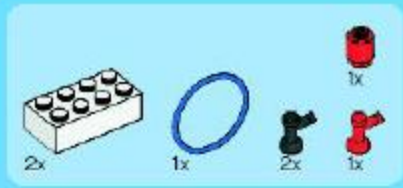

18

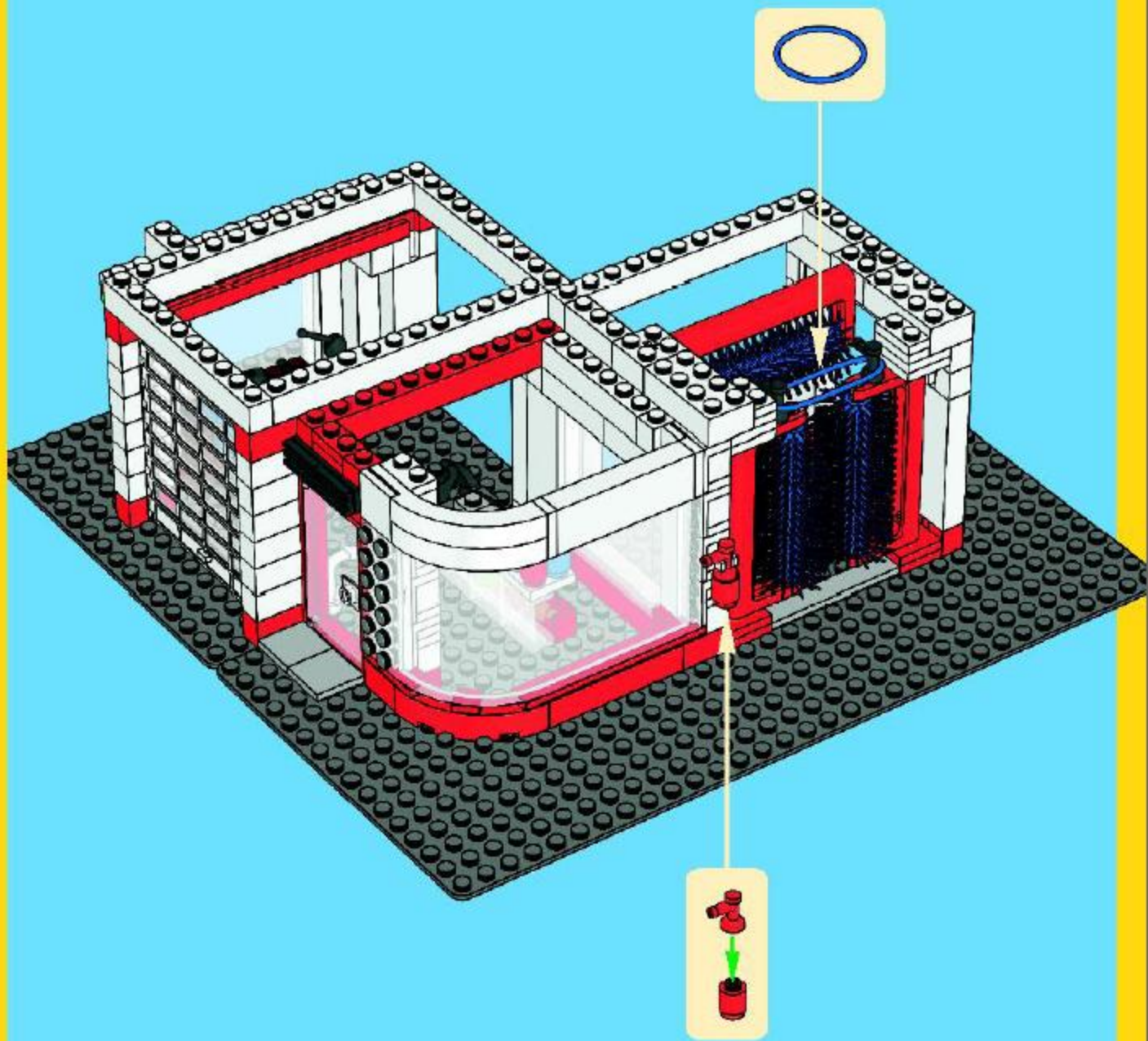

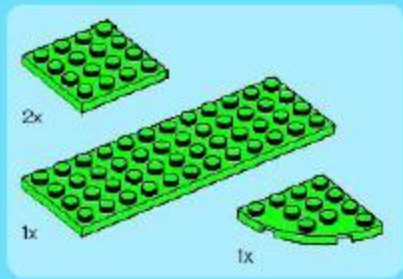

1

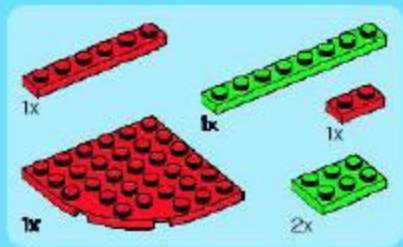
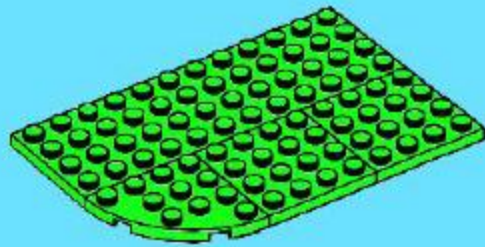

2

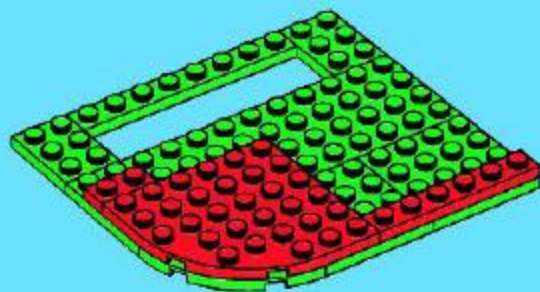

3

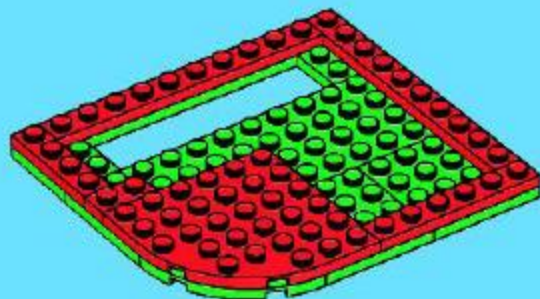

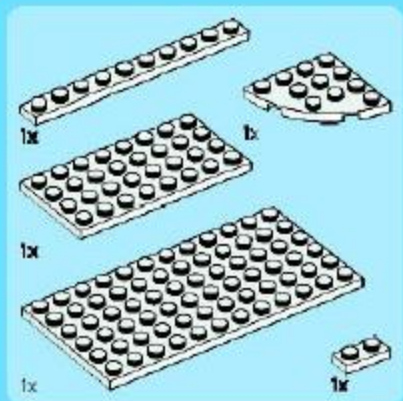

4

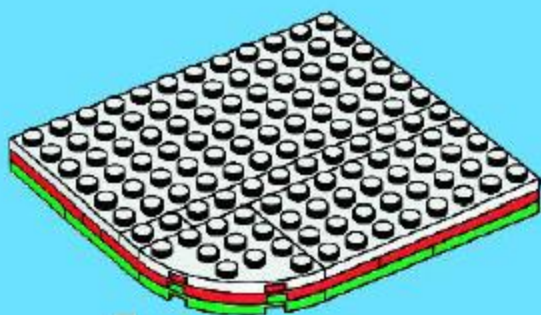

19

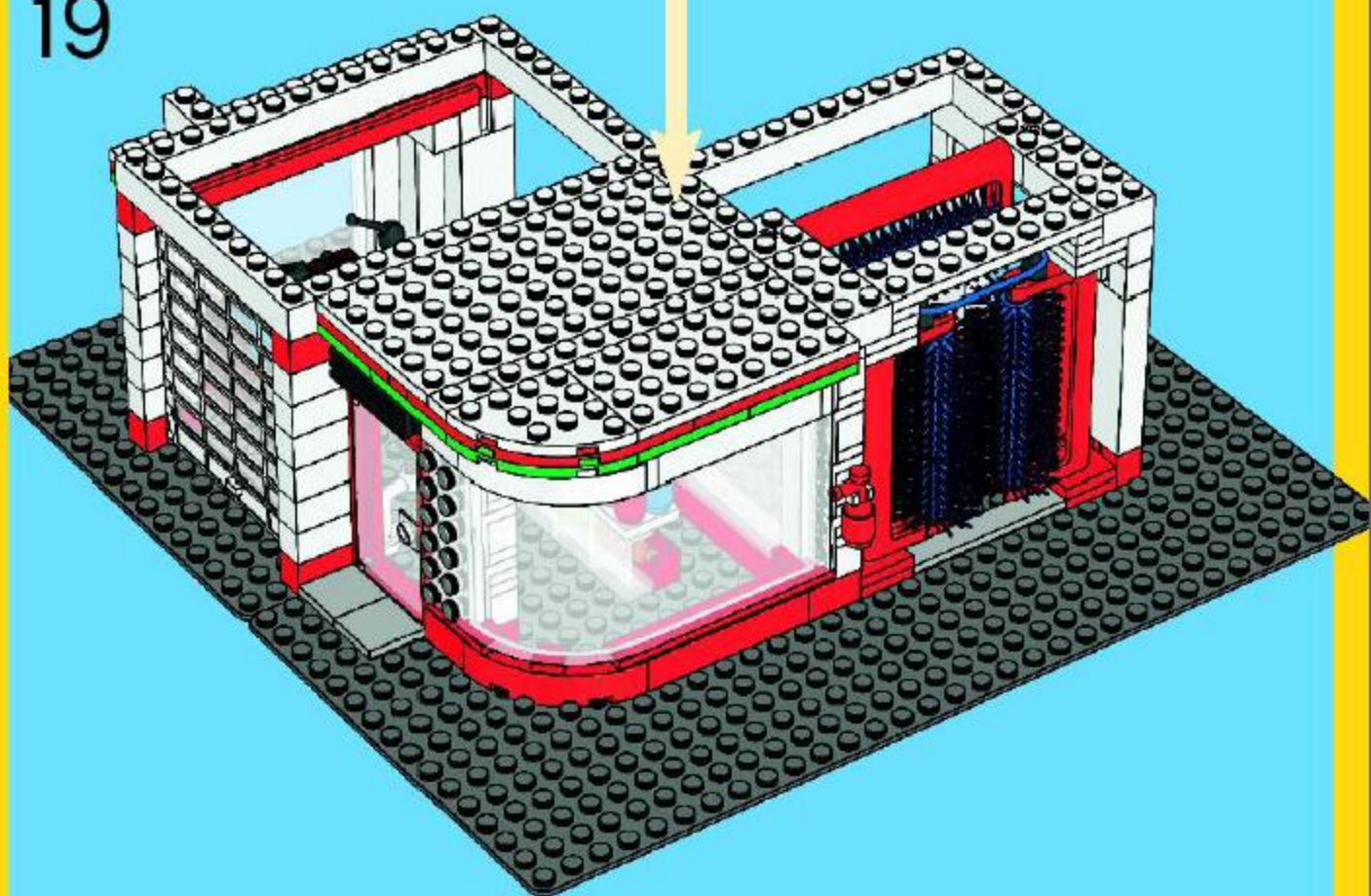

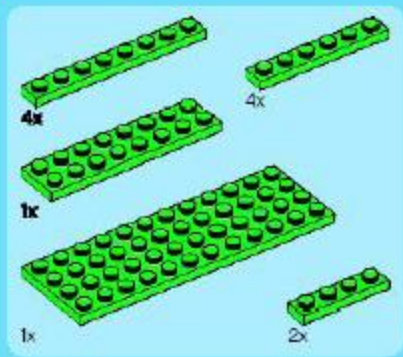

20

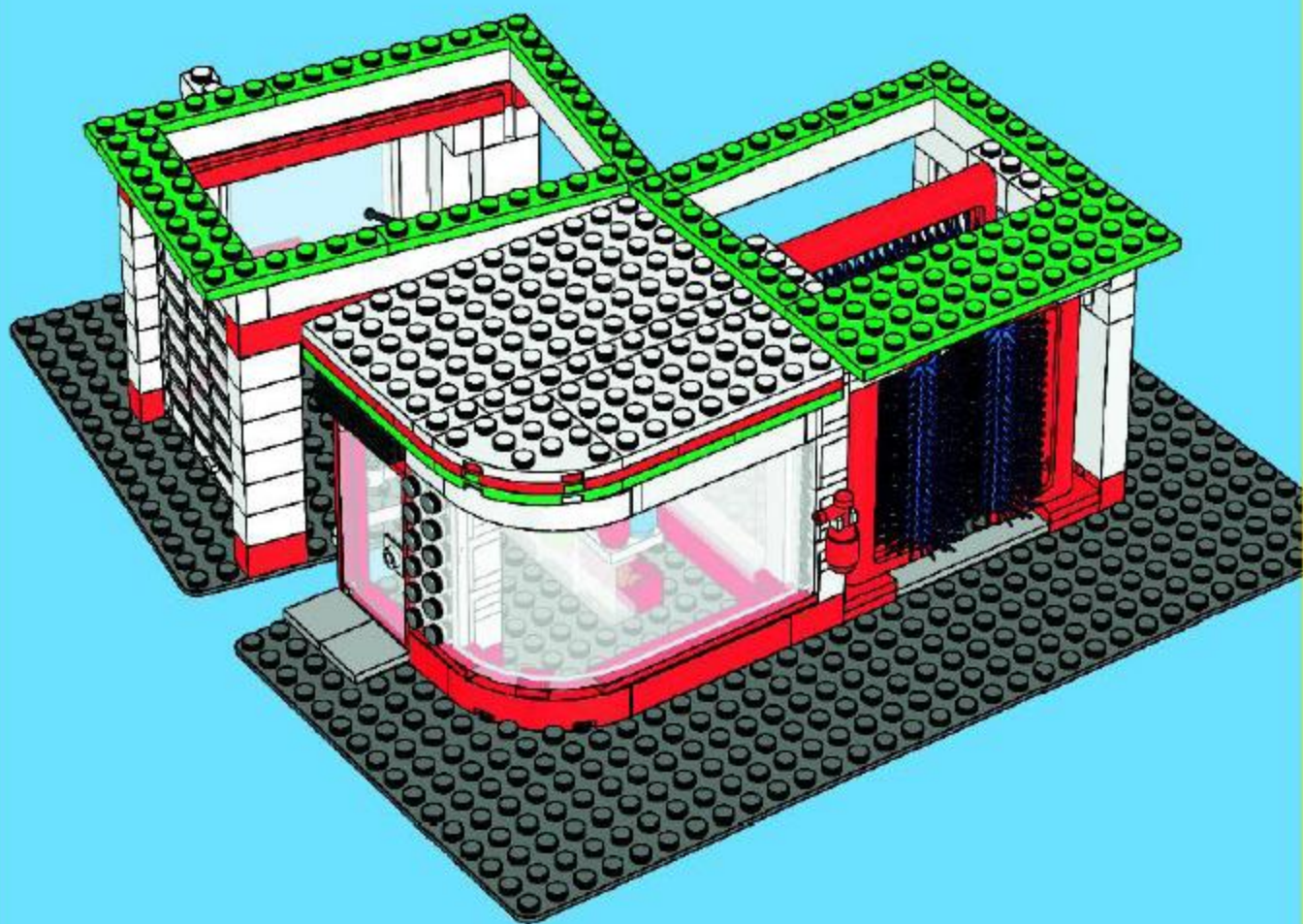



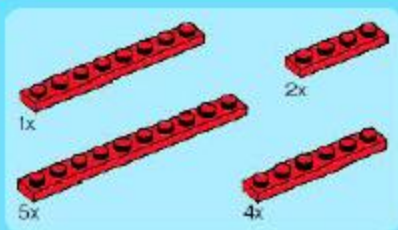

21

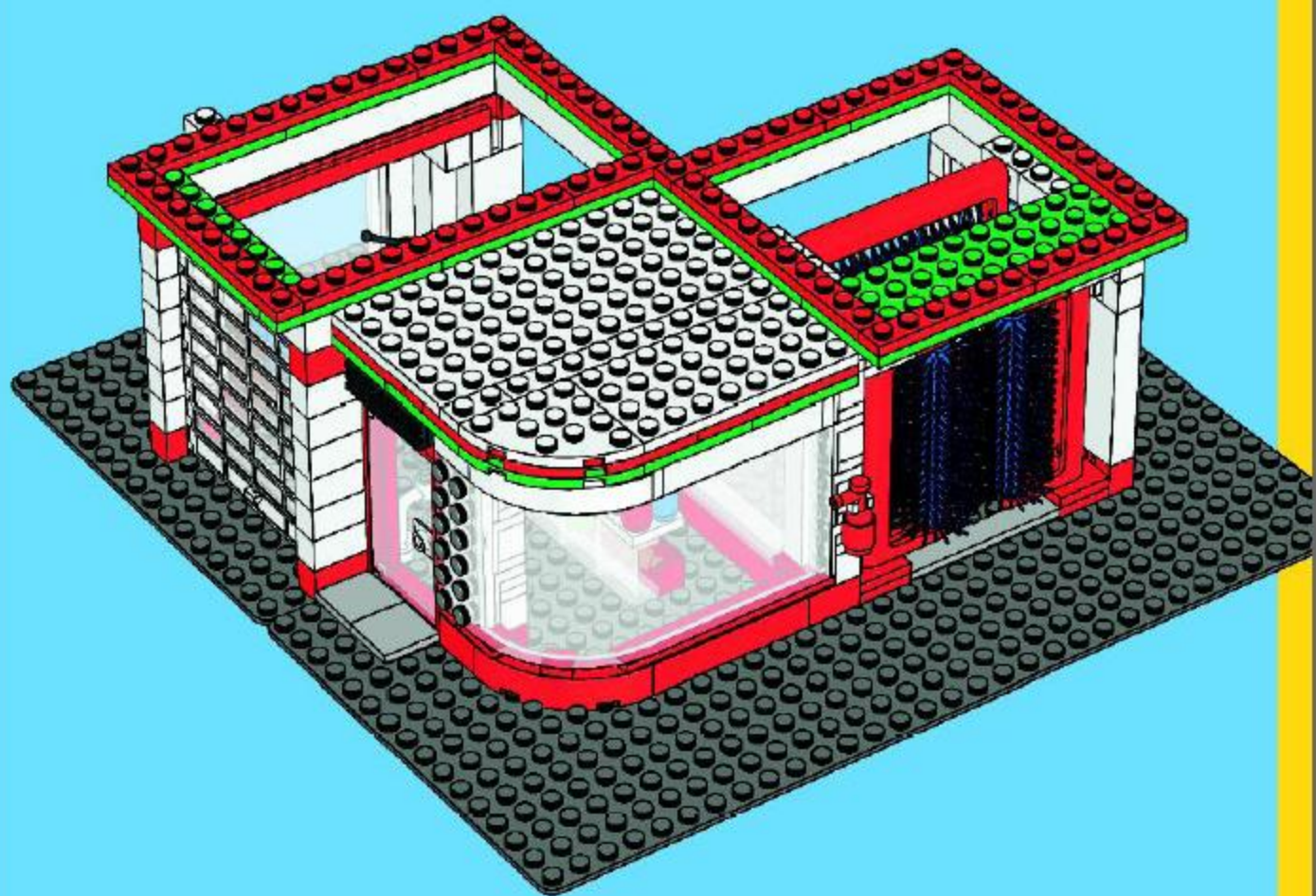

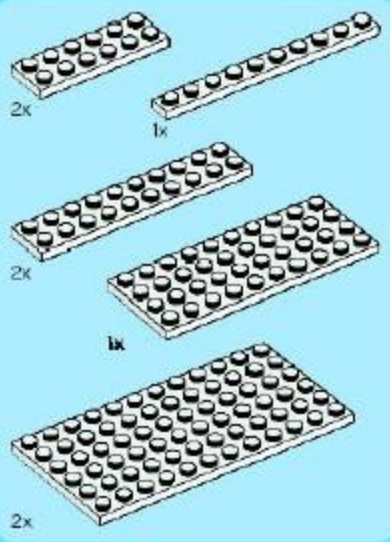

22

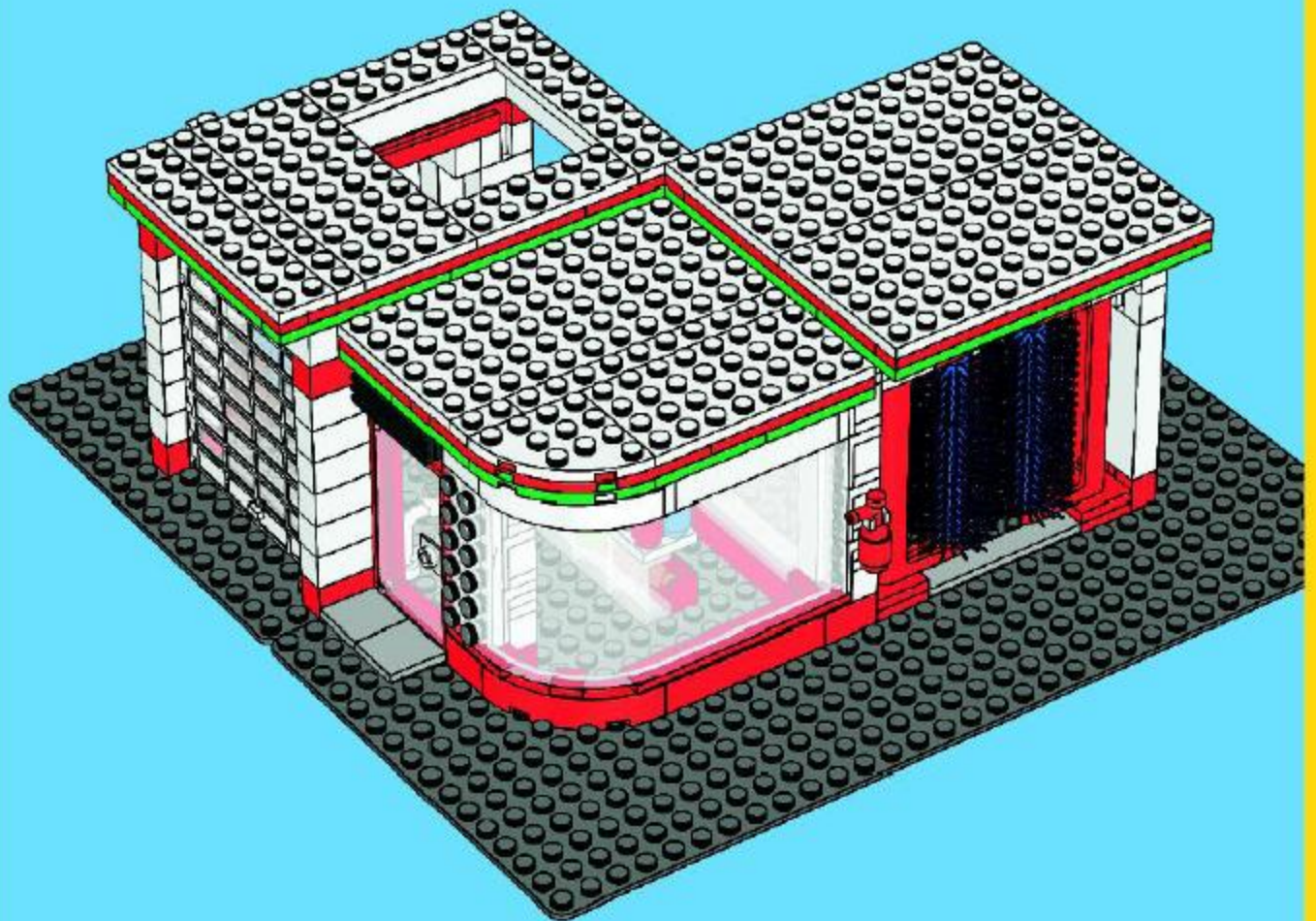



23





1x



10x



4x

# 24

1



2

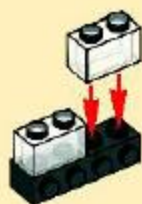

3



4



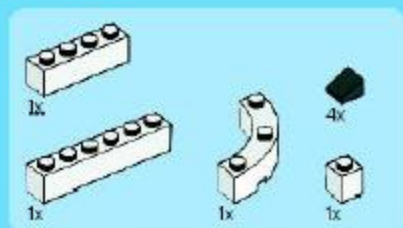

25

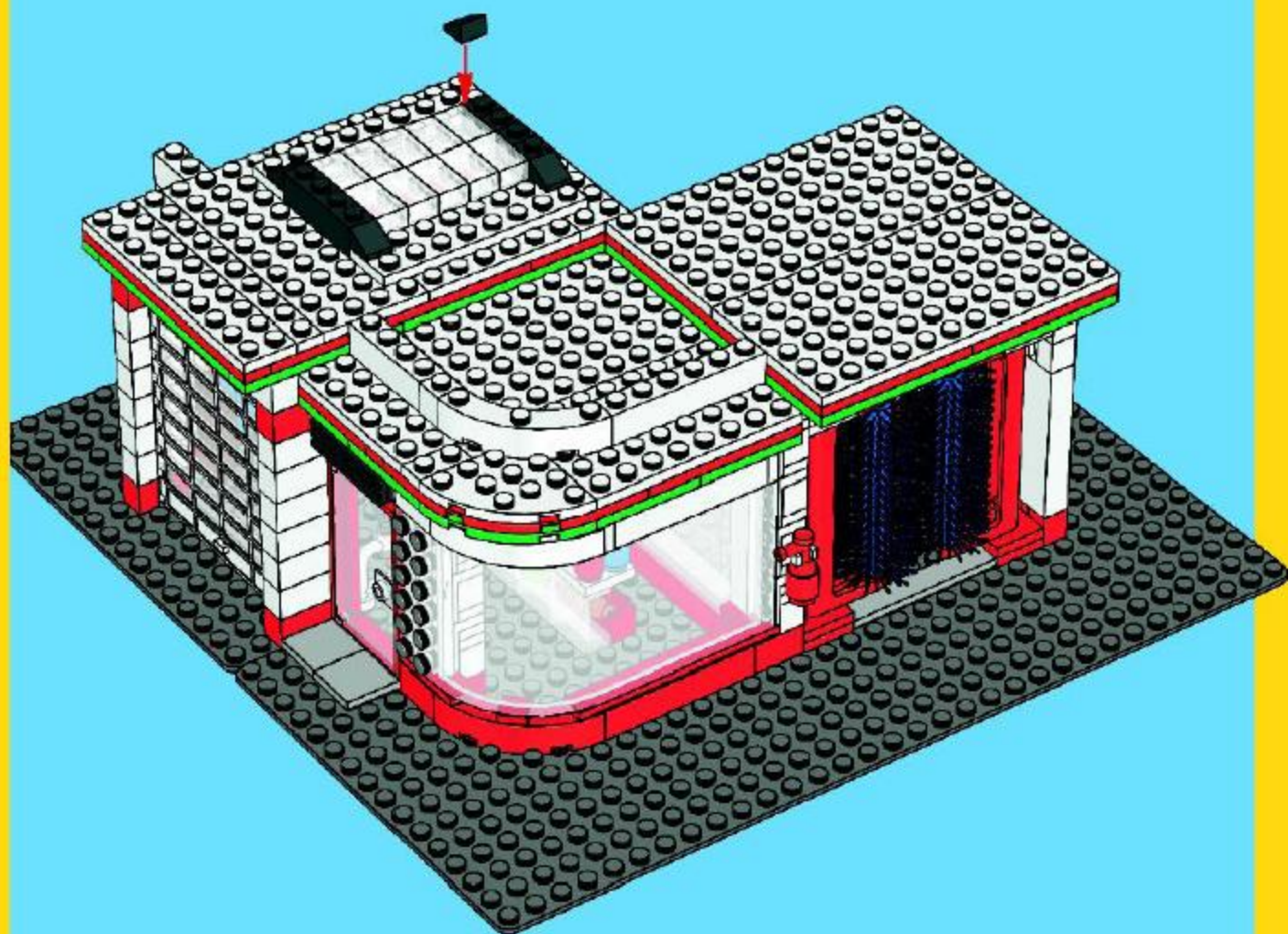

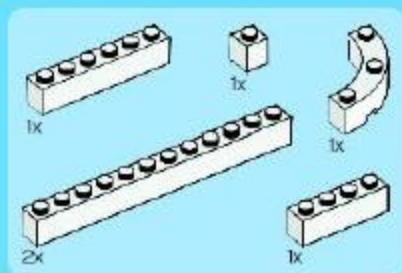

26





4x



2x

27

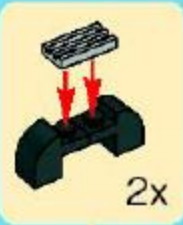

2x





1x



5x



7x



4x



3x



3x

28

1



2



3



1



2



4





5

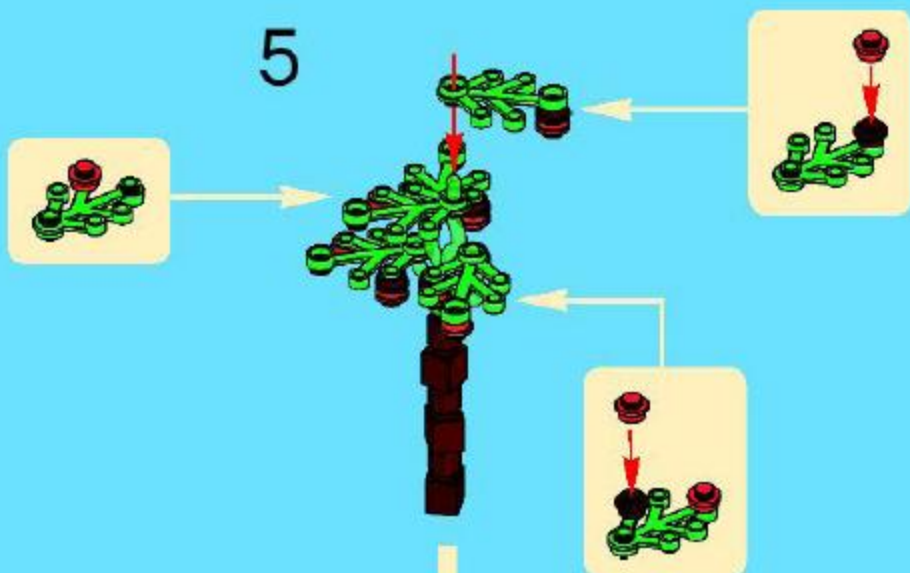



1

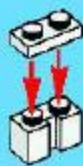

2

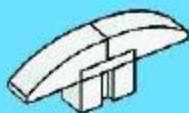

3



2



2x



4

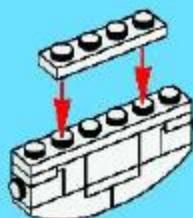



5

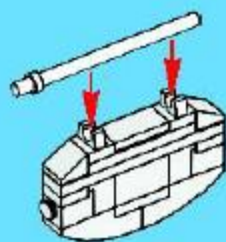

6

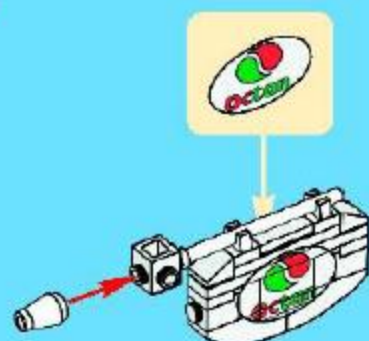

7

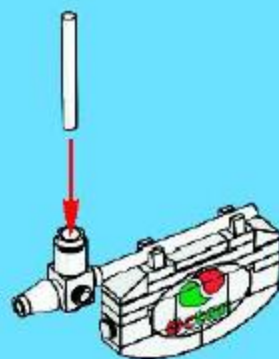

8

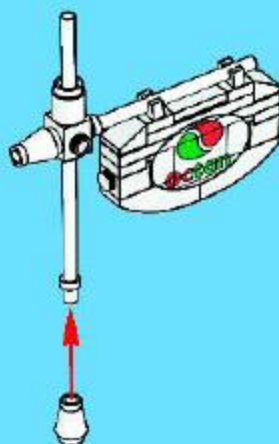



1x

9

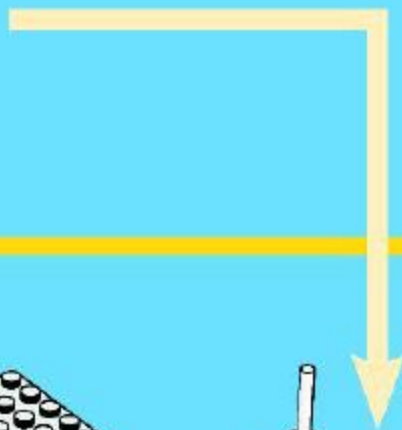
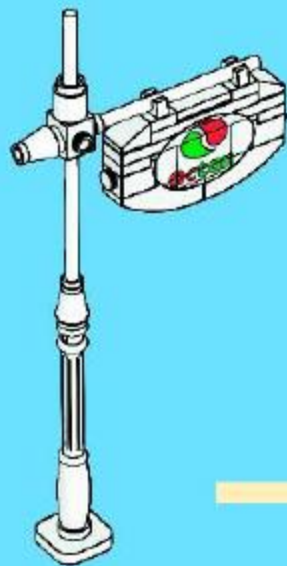



30

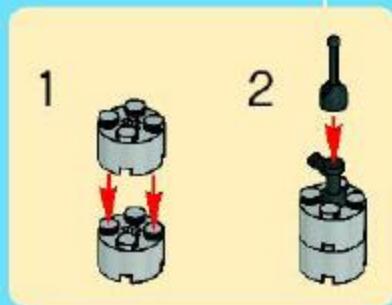
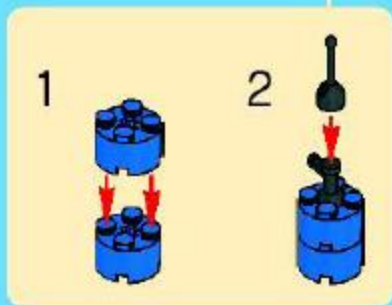
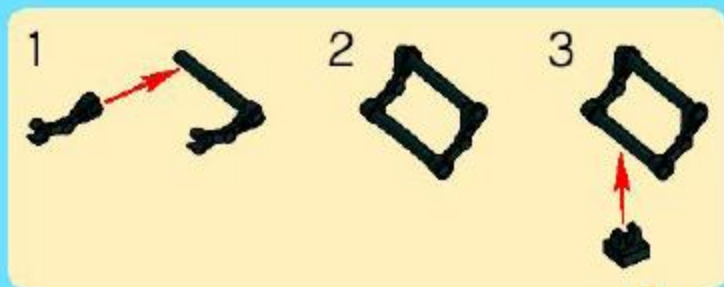



31

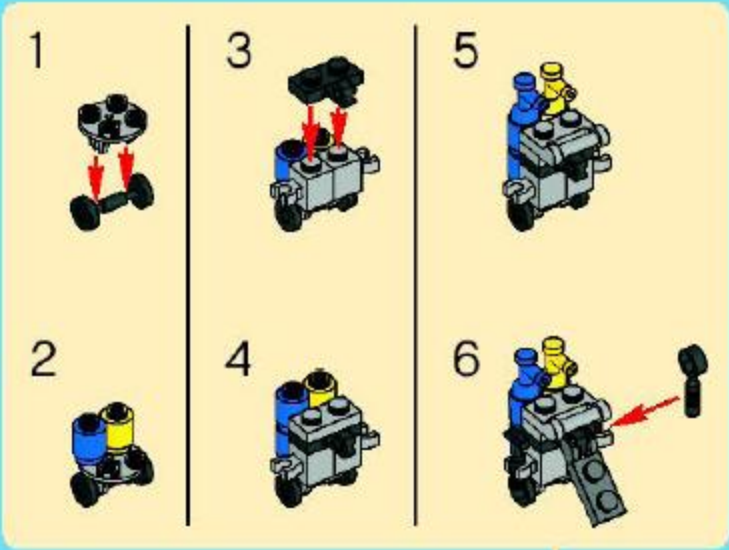



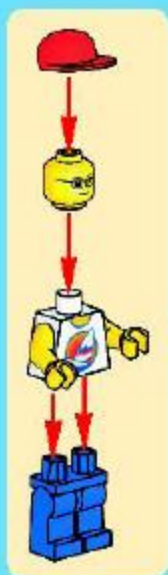



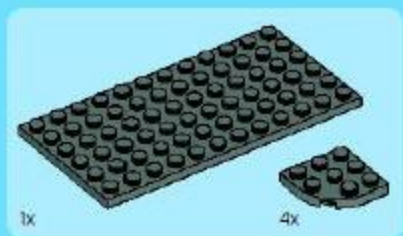

1

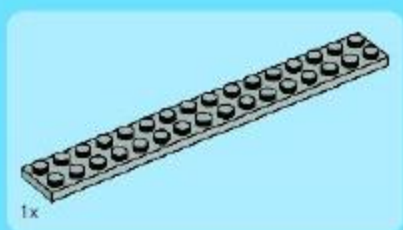

2

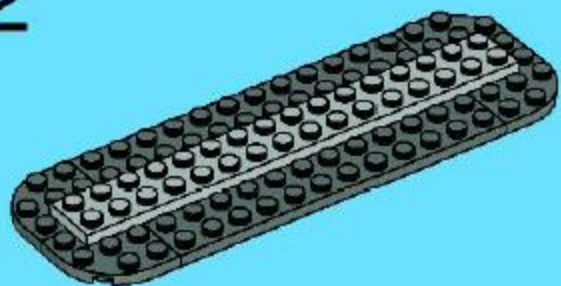

3

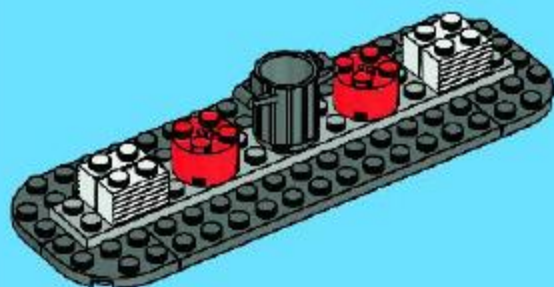

4

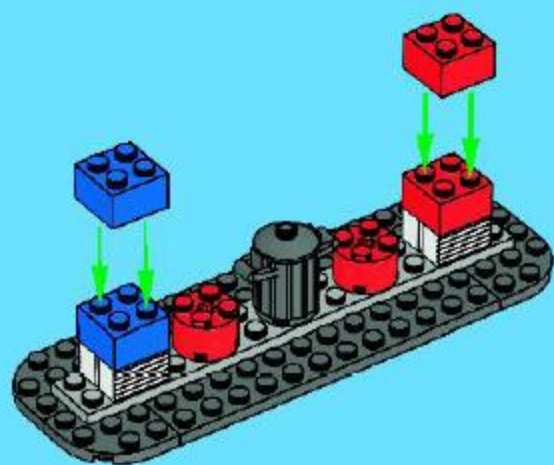



2x



4x

5

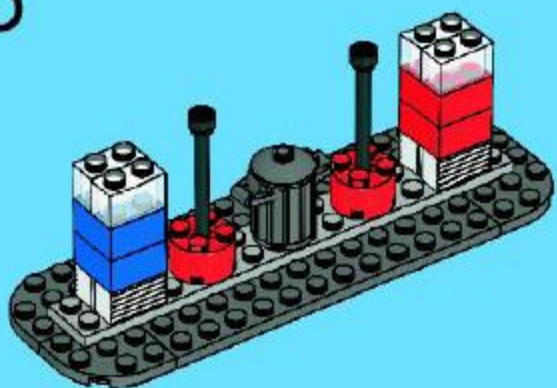

2x

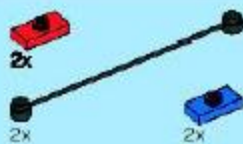

2x



2x



2x



2x

7

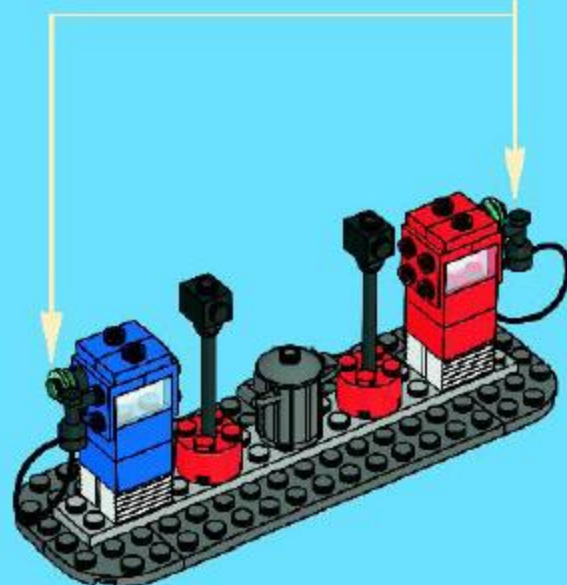
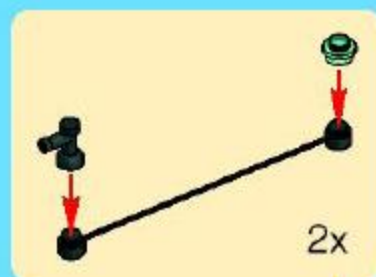

2x



2x



2x

6

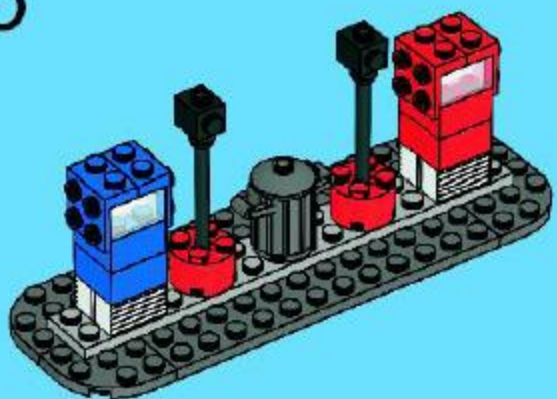



8

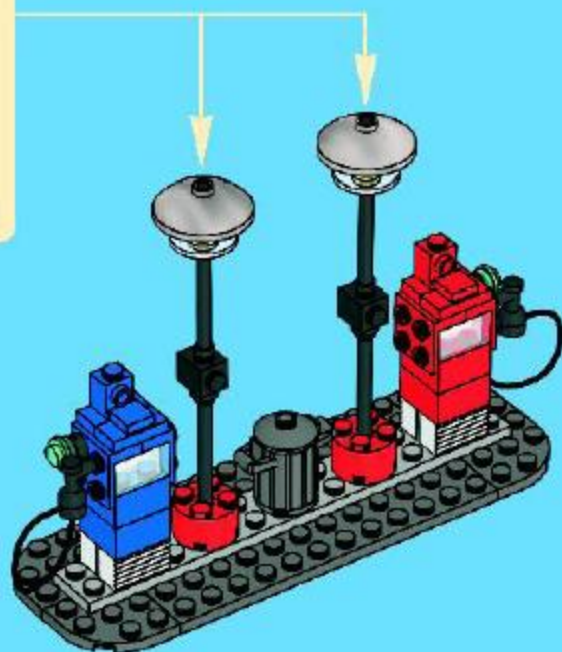
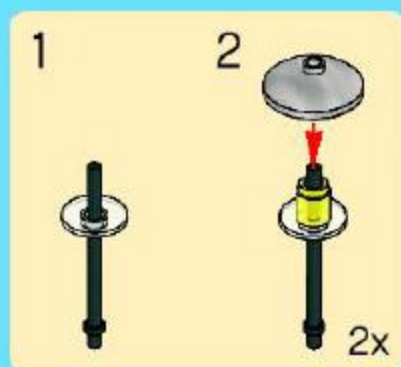

9

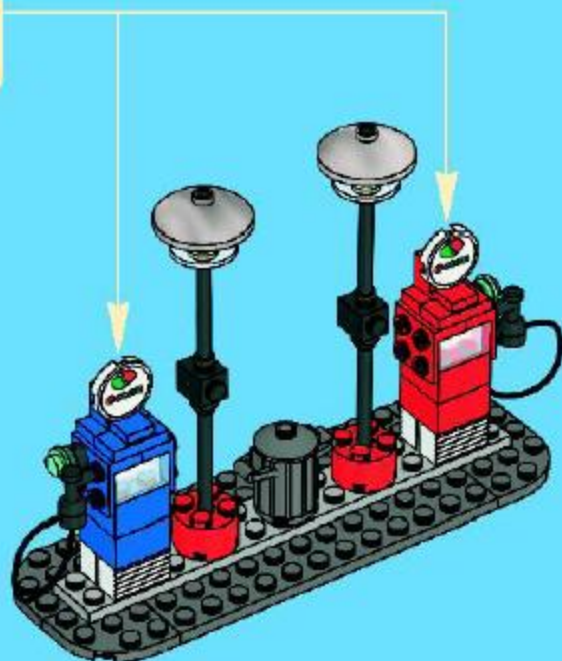



1



2

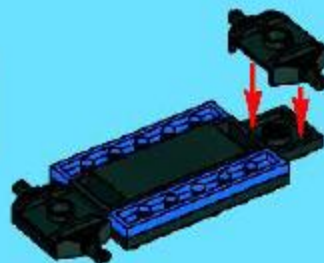

3

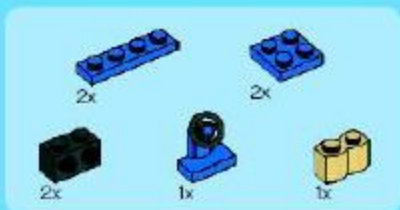
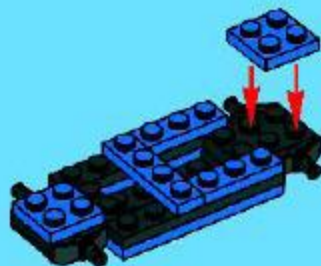

4

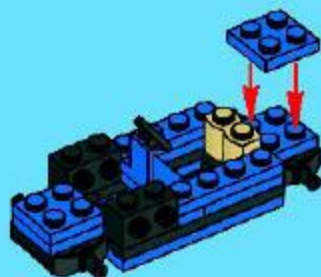

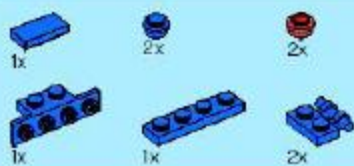

5

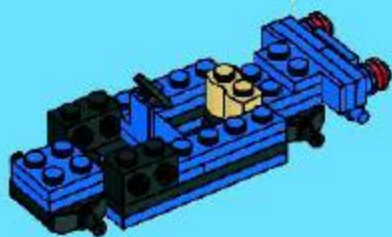
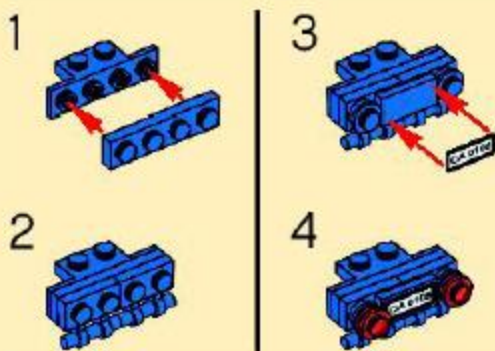

6

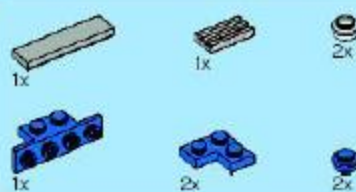
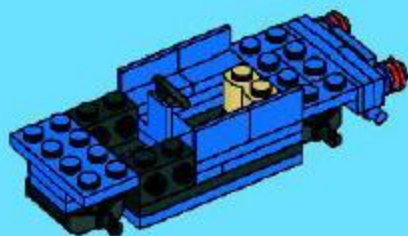

7

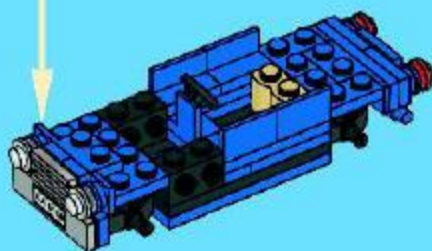
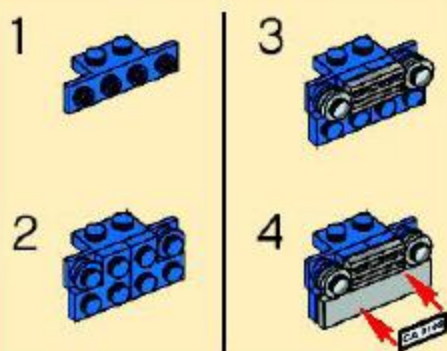

8

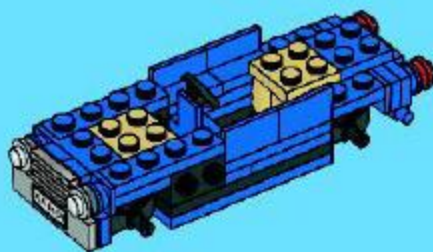

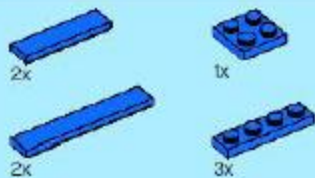

9

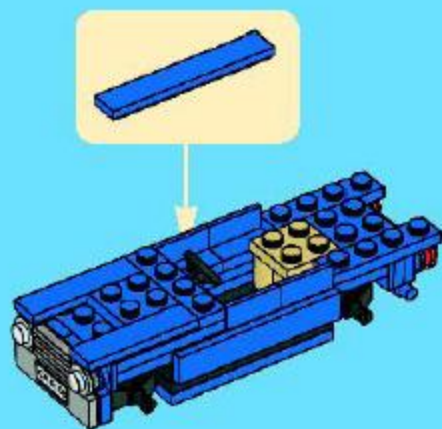

10

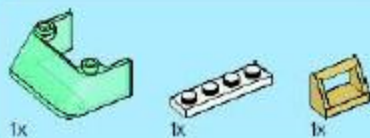
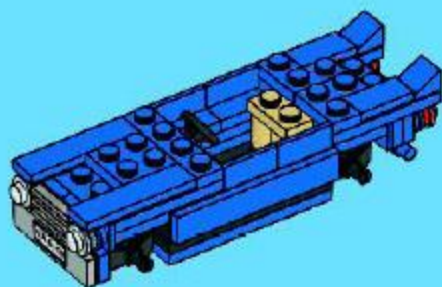

11

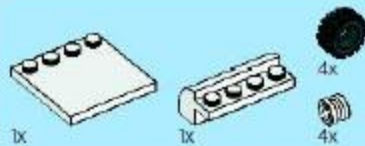
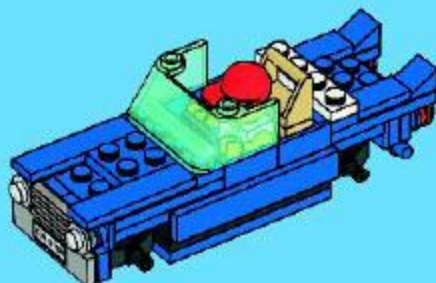

12

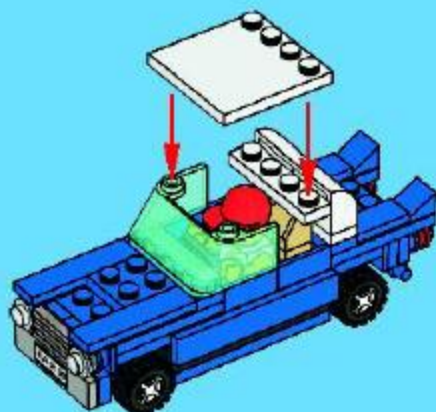

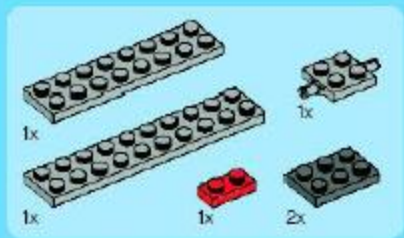
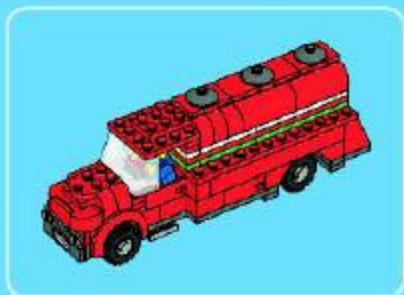

1

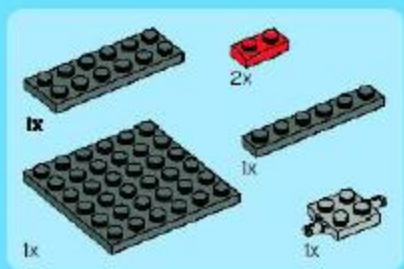
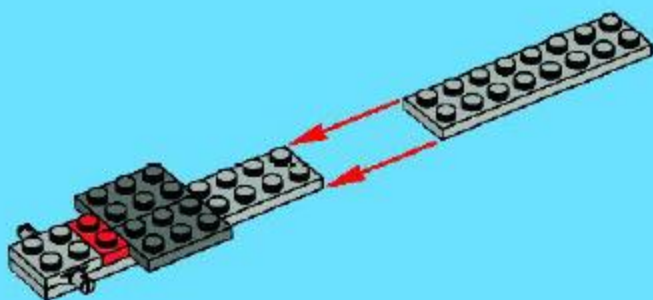

2

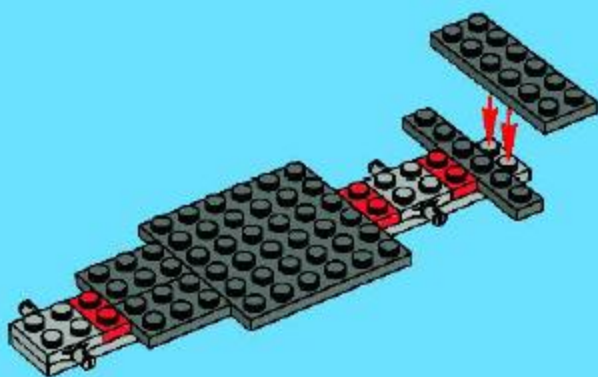



2x



4x

# 3

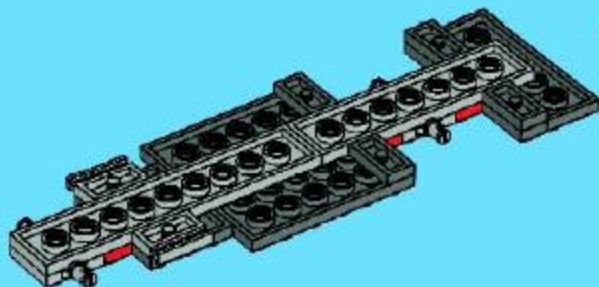

1x



2x



1x



1x

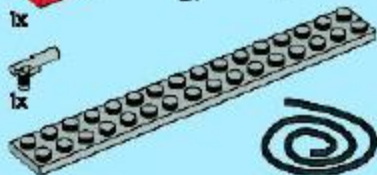

1x



# 4

1



2

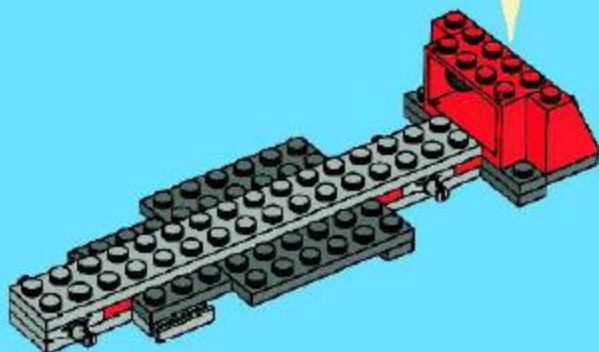



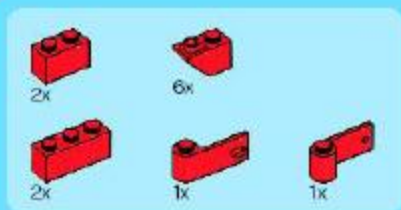

5

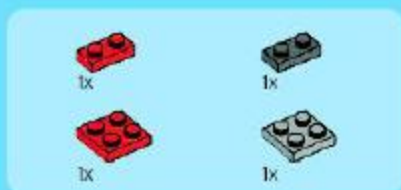
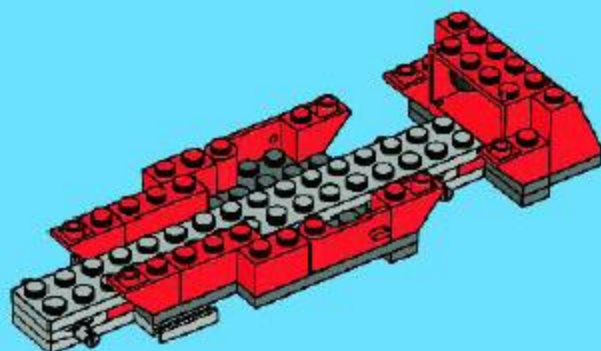

6

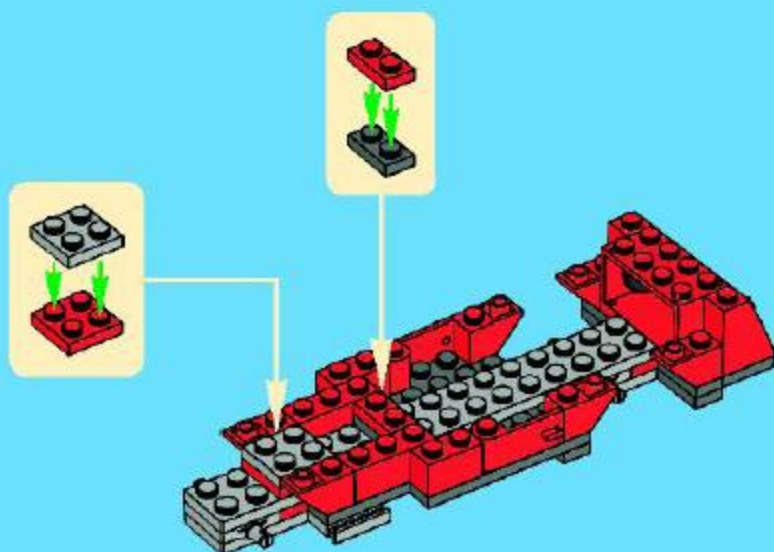

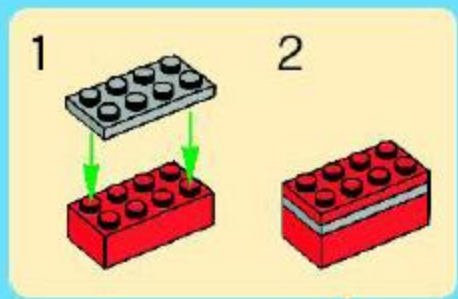
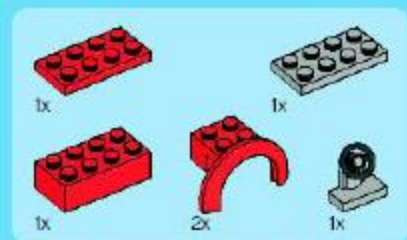

7

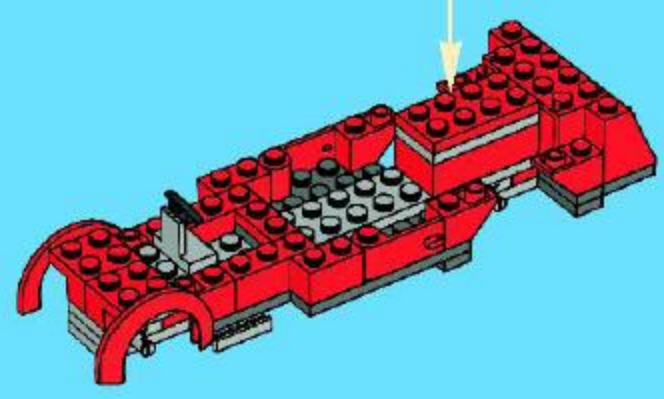

8

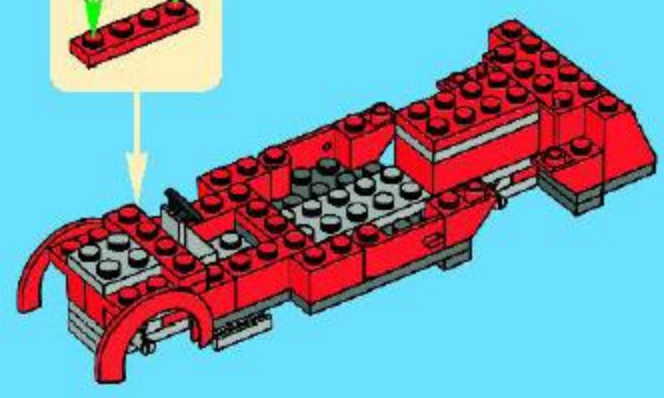
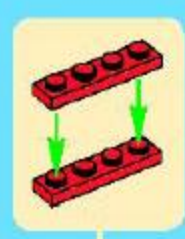

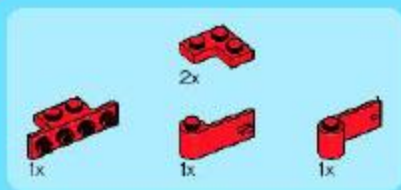

9

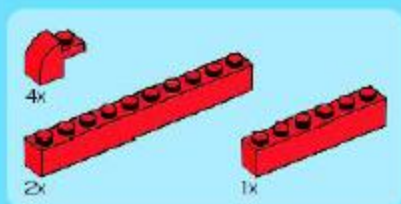
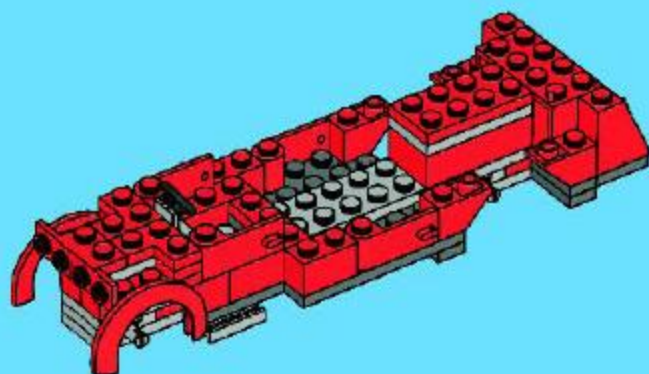

10

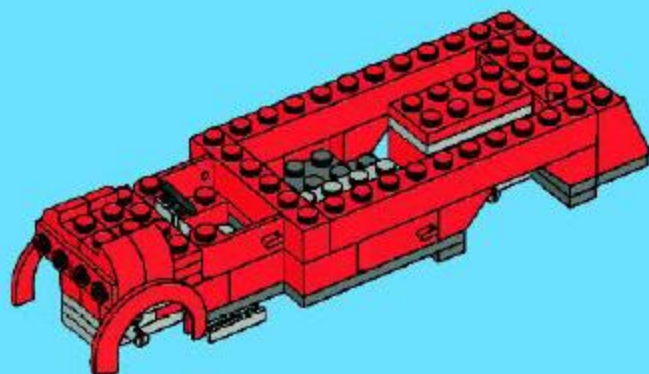

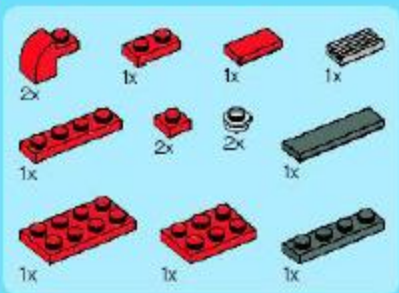

# 11

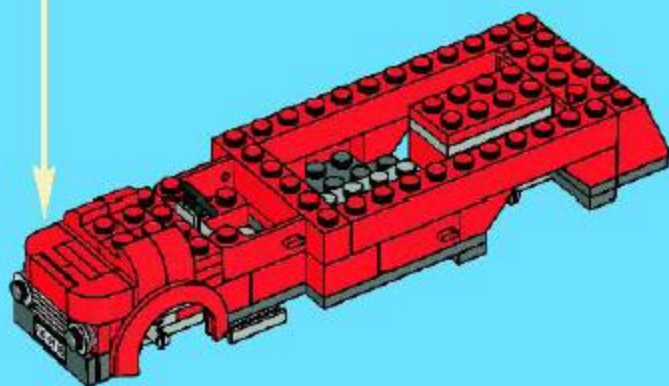
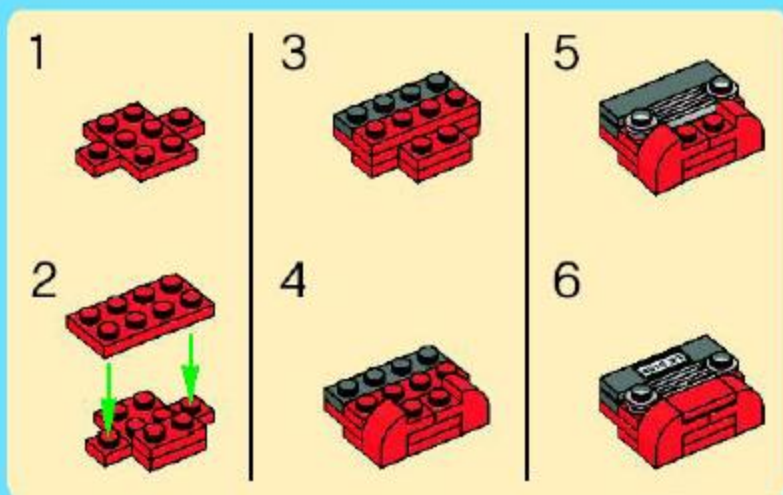

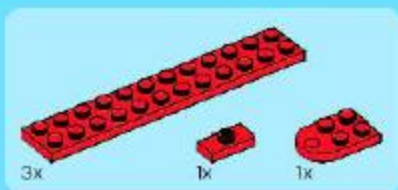

12

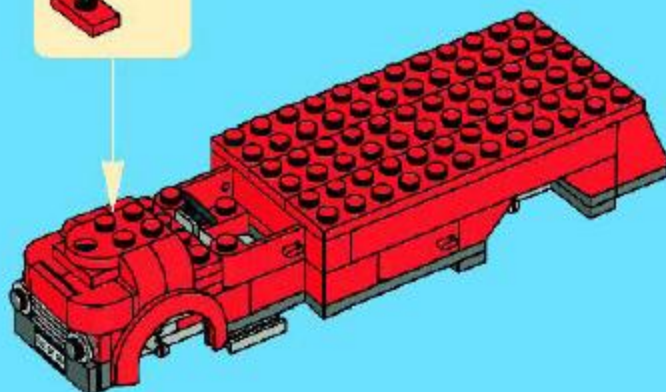

13

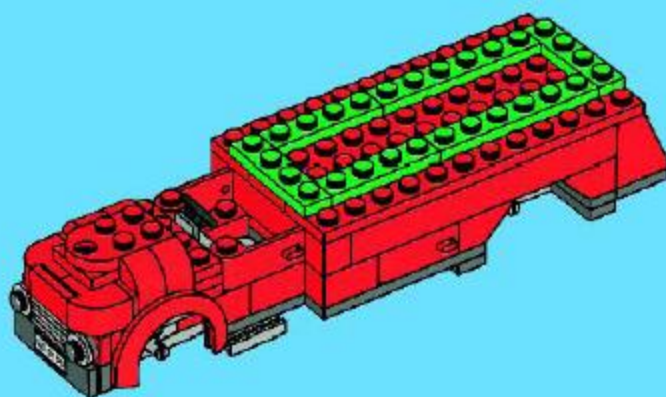



4x



2x

# 14

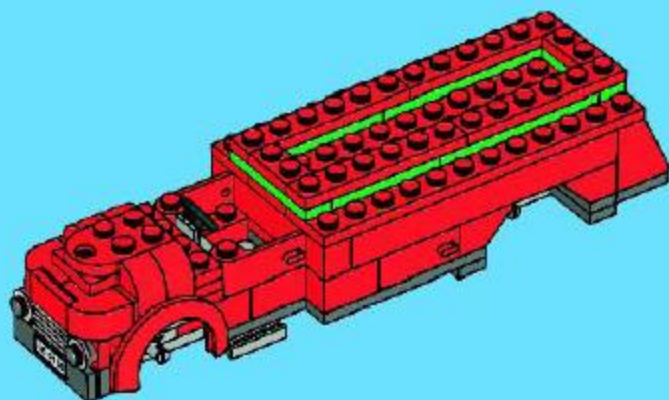

1x



2x



2x



2x



4x

# 15

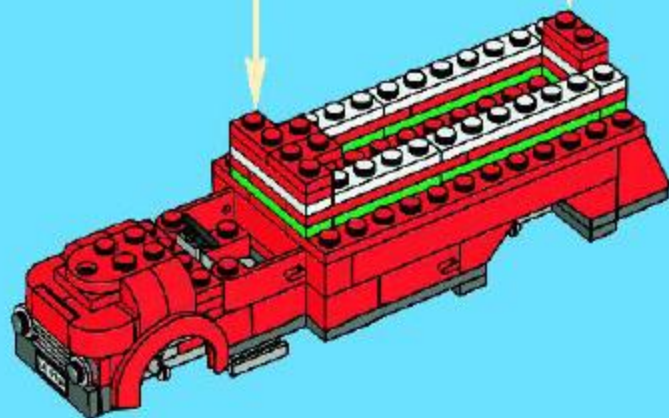
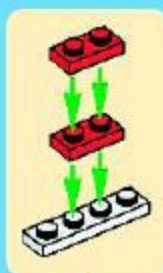
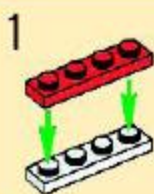



4x



6x

# 16

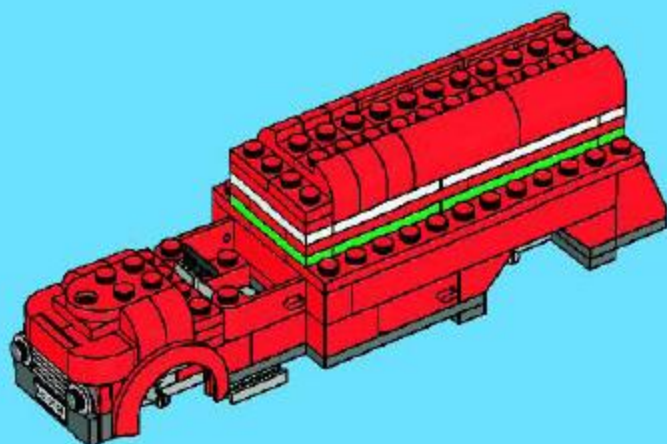

1x



1x

# 17

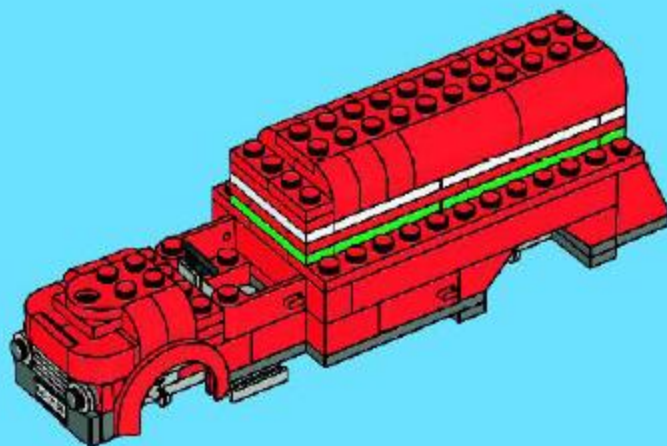

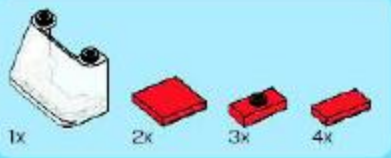

18

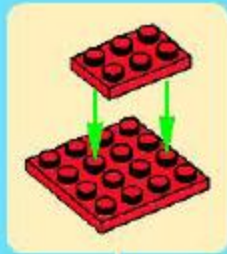
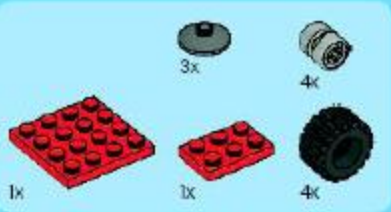
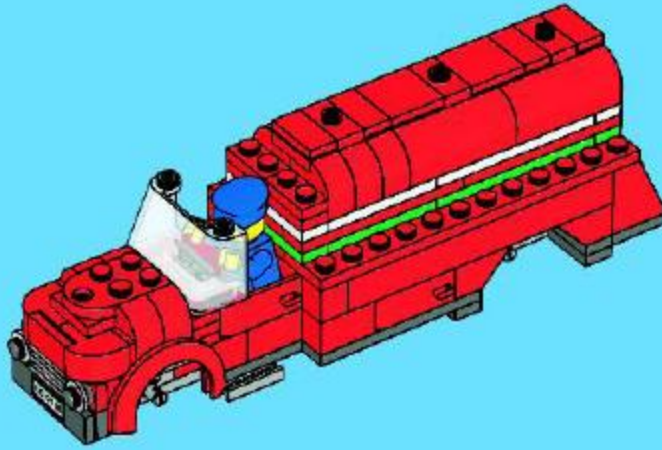

19

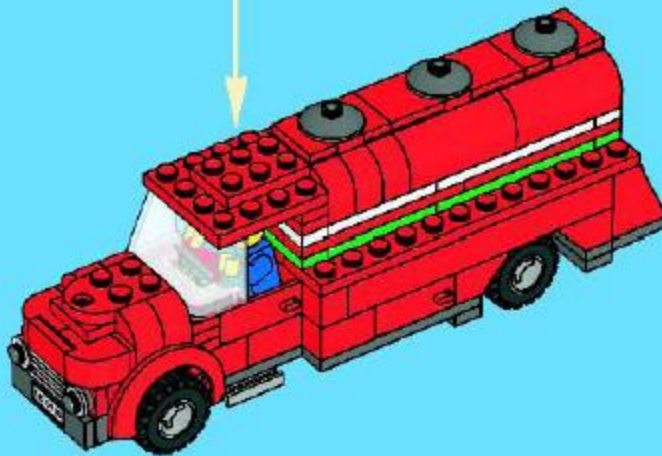





1

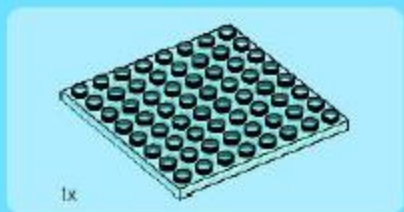
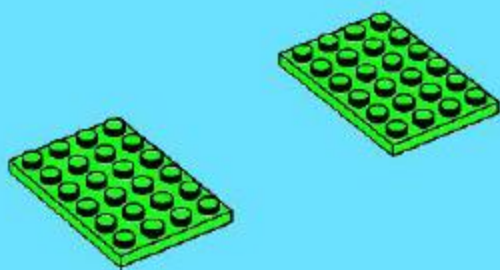

2

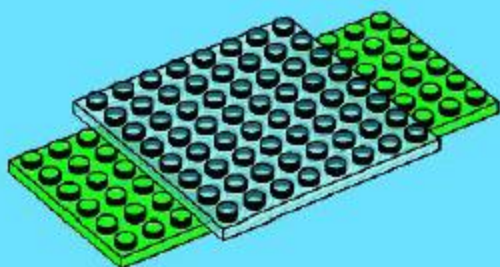



4x

3

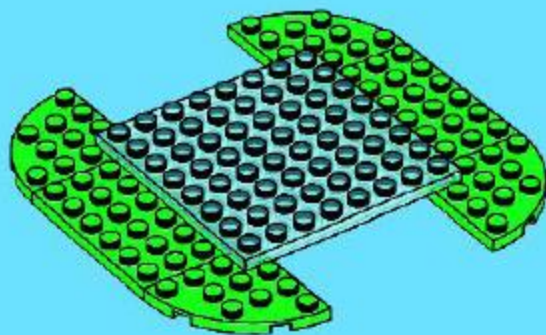

4x



4x

4

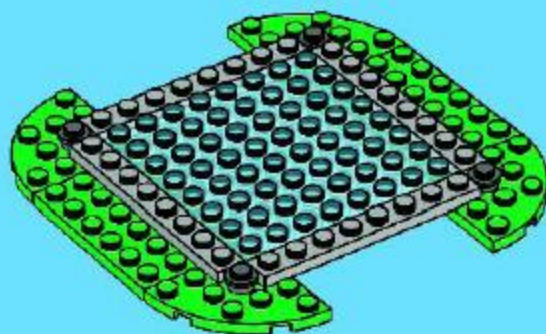

1x



4x



4x



1x



1x

5

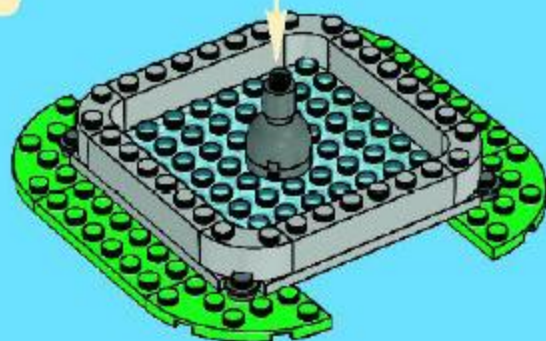



6

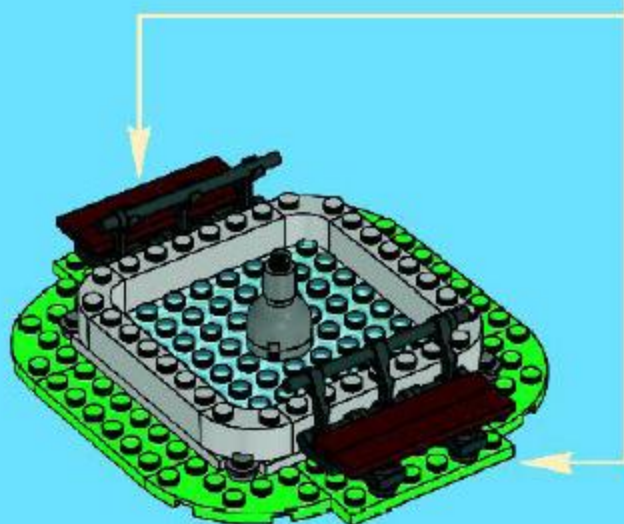
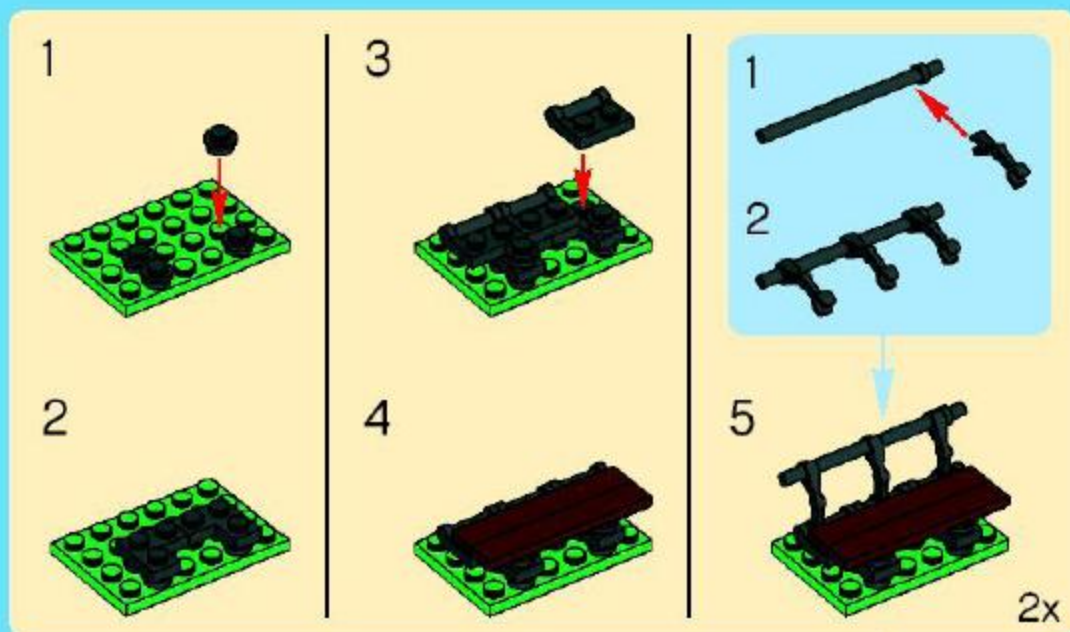



3x

7



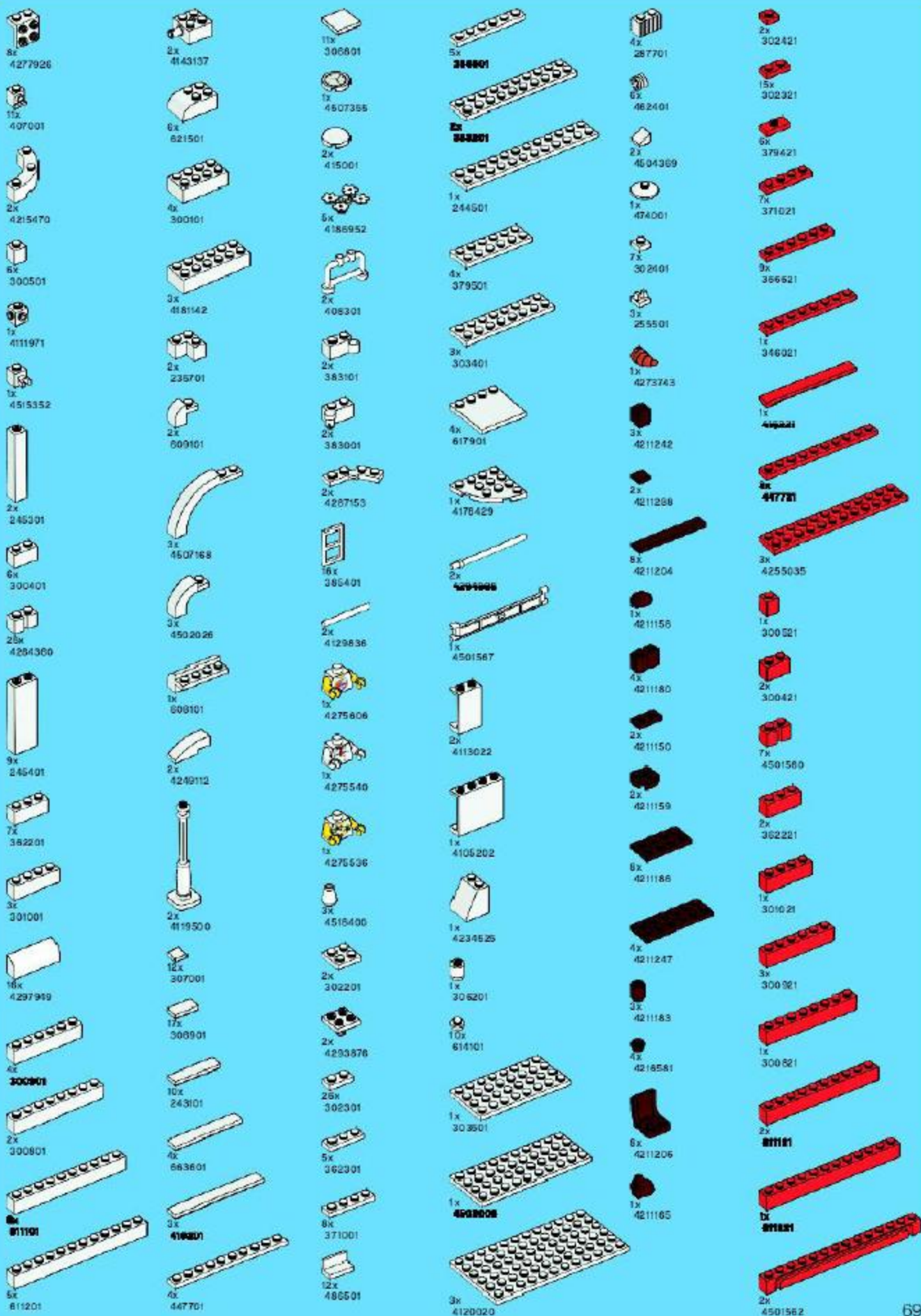

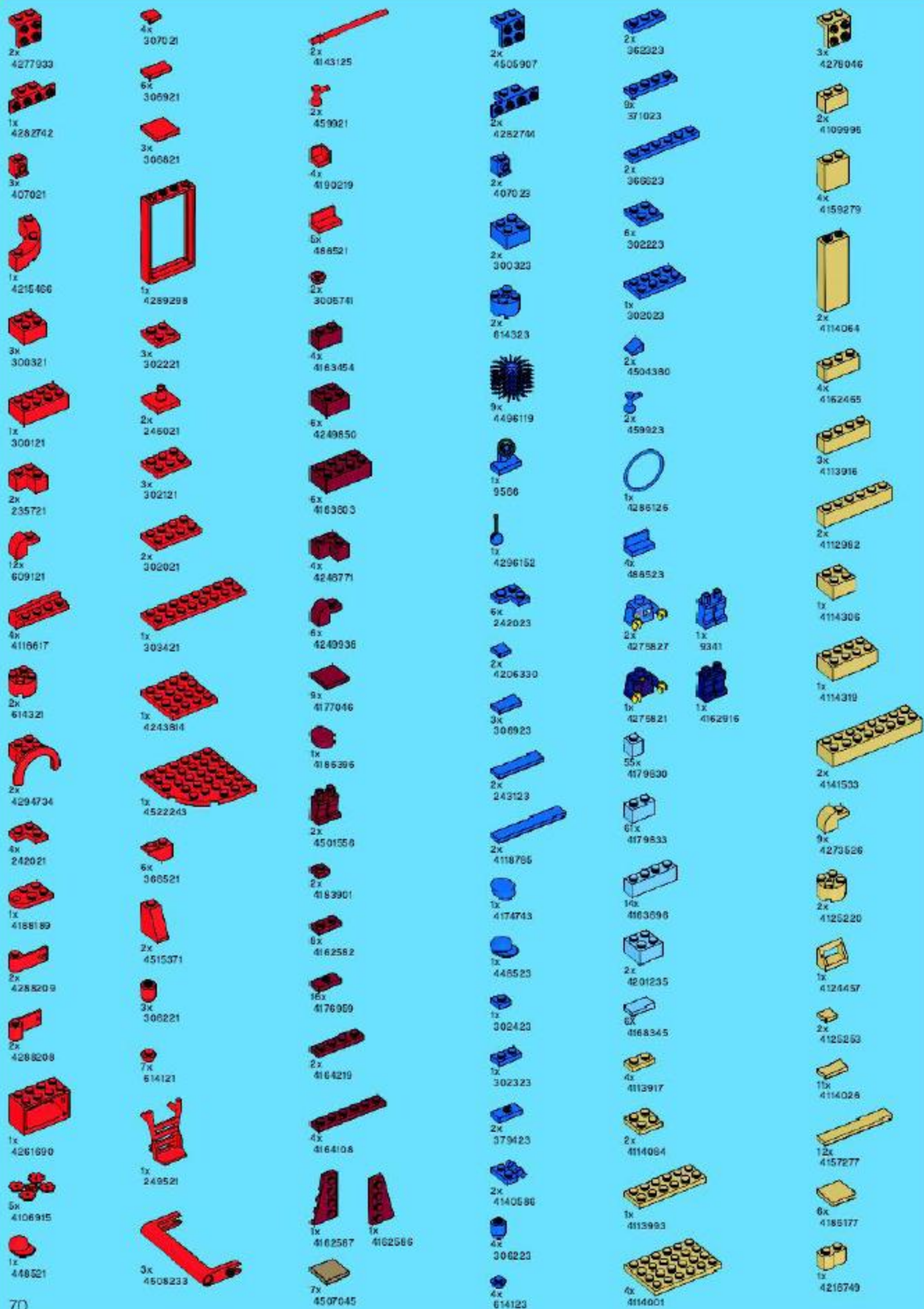

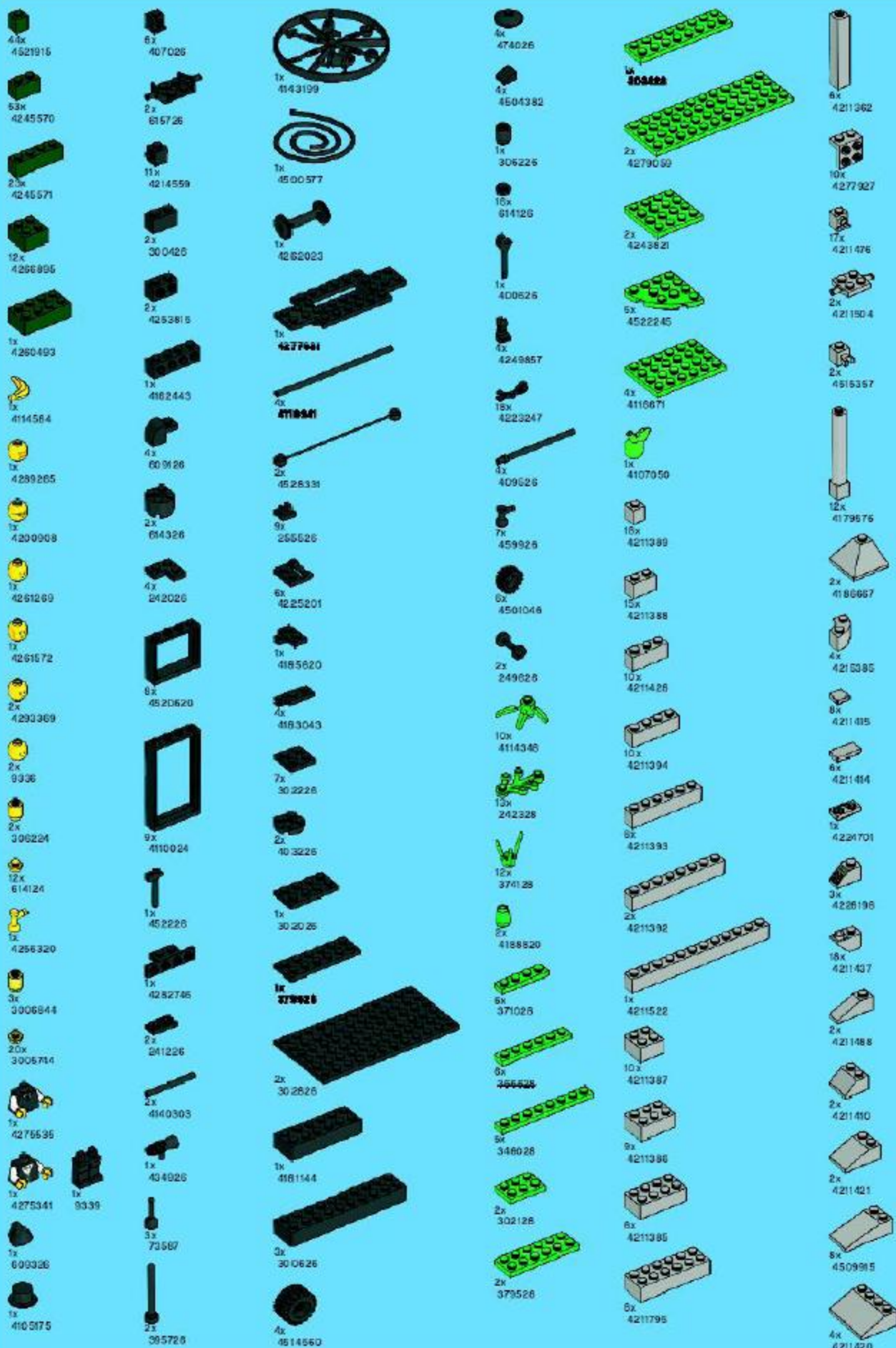



Customer Service  
 Kundenservice  
 Service Consommateurs  
 Servicio Al Consumidor

[www.lego.com/service](http://www.lego.com/service) or dial

 : 00800 5346 5555  

 : 1-800-422-5346





# CREATOR



4996





# STAR WARS™

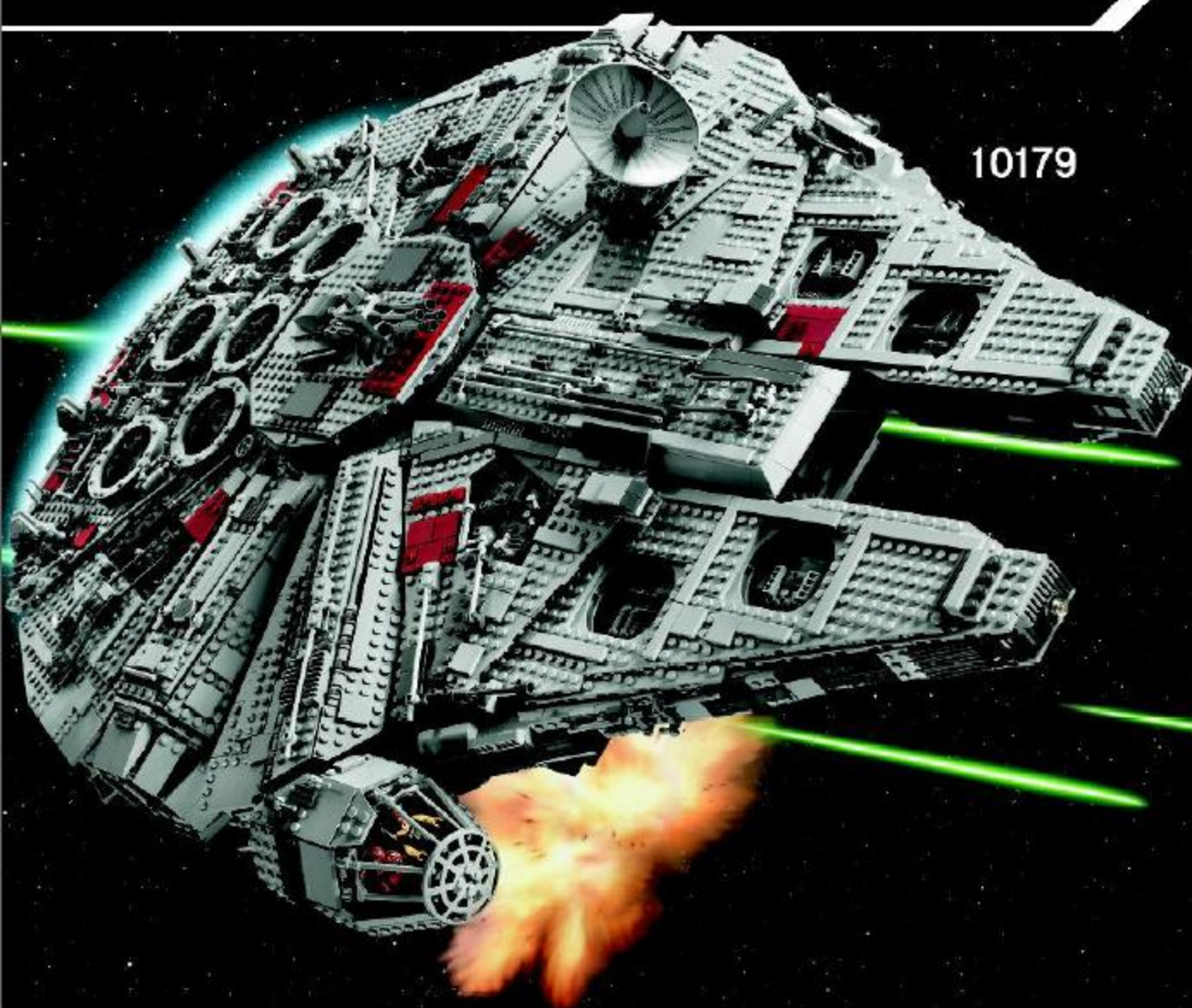

10179



Luke Skywalker™



Princess Leia™



Han Solo™



Chewbacca™



Obi-Wan Kenobi™



Luke Skywalker™ General Veers™ AT-AT Driver™ Snowtrooper™

10178



**+ power Functions™**

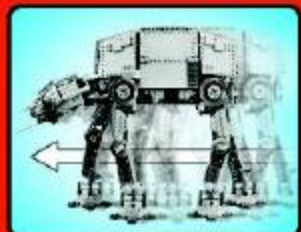

**Includes:**



Battery box



Motor





©2005 The LEGO Group. 4528394

10181

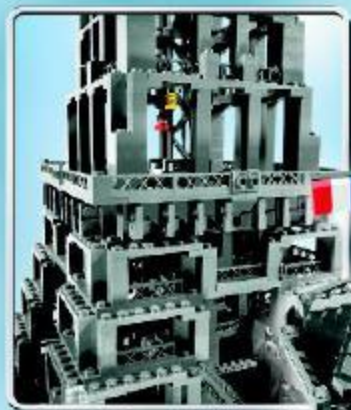



TOWN PLAN

10184-2

2008

Kjeld Kirk Kristiansen

Grandson of Founder and Owner of the LEGO Group

1958

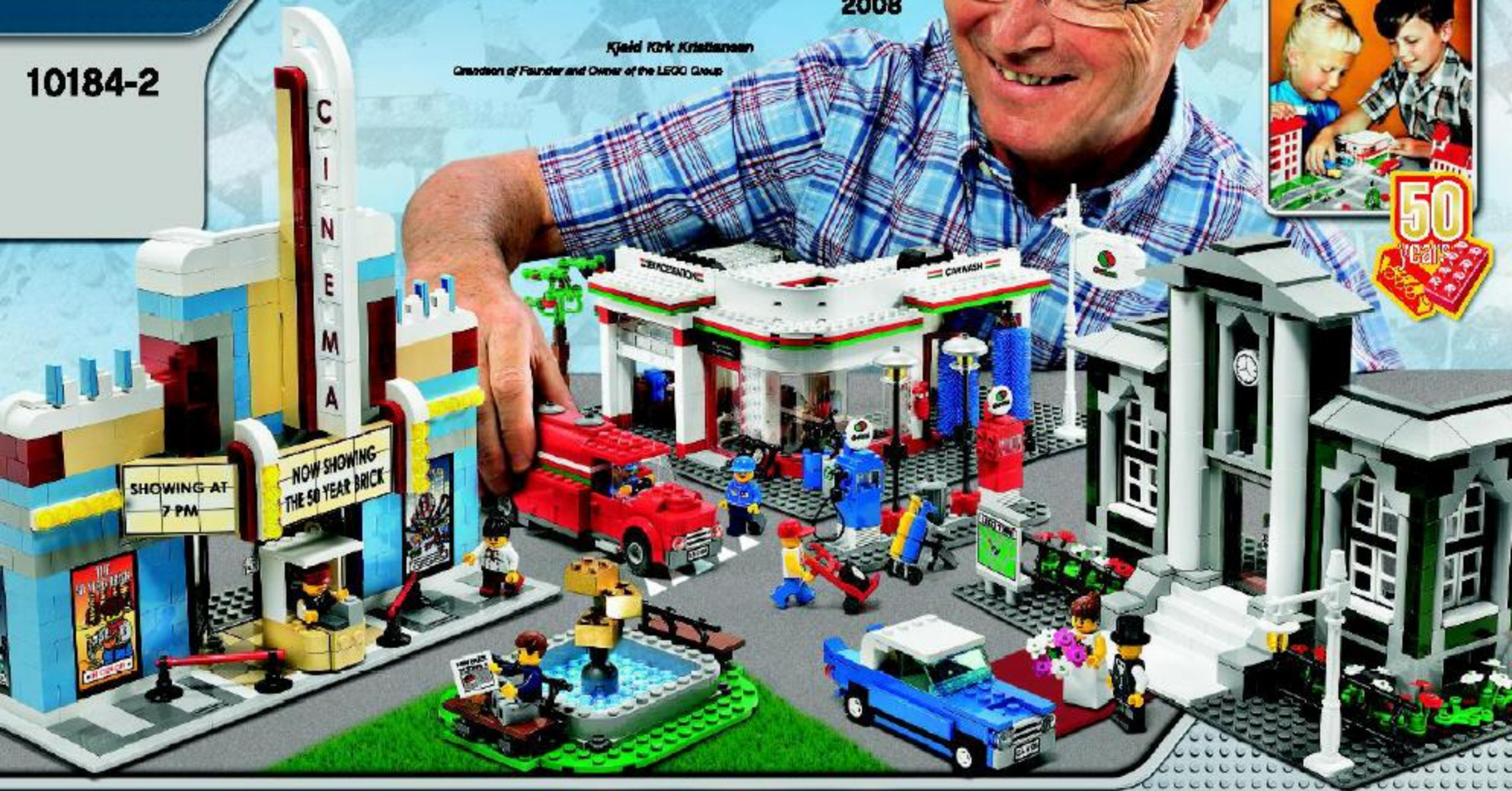

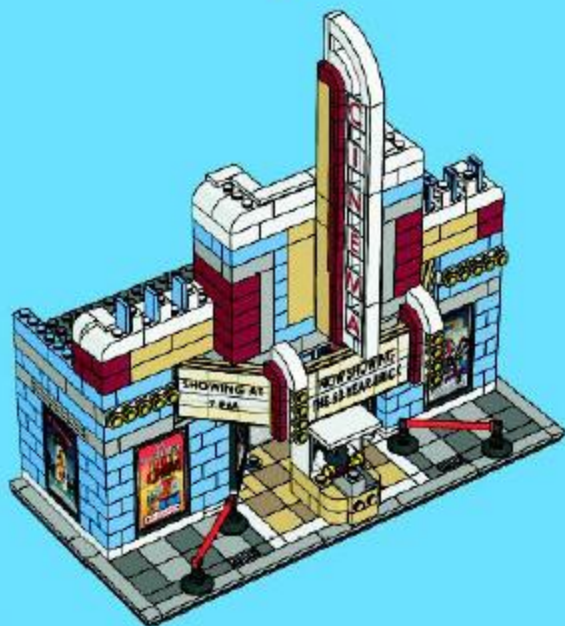

1

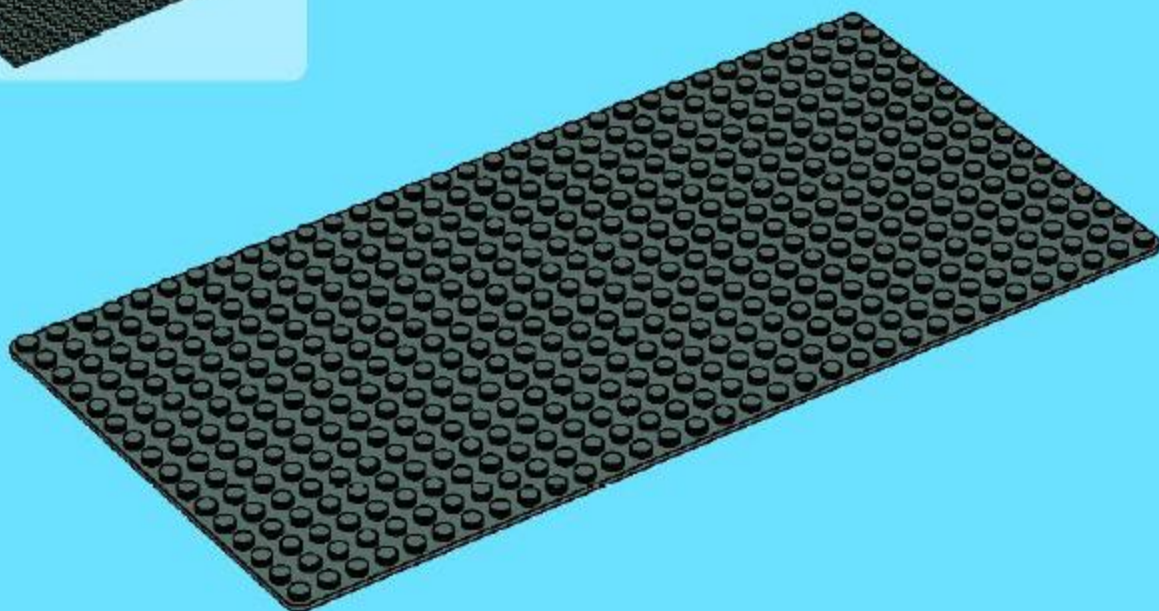



2

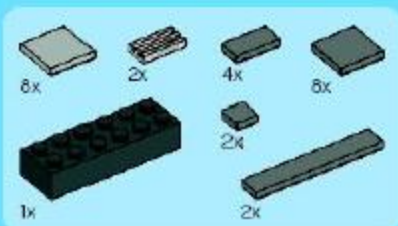
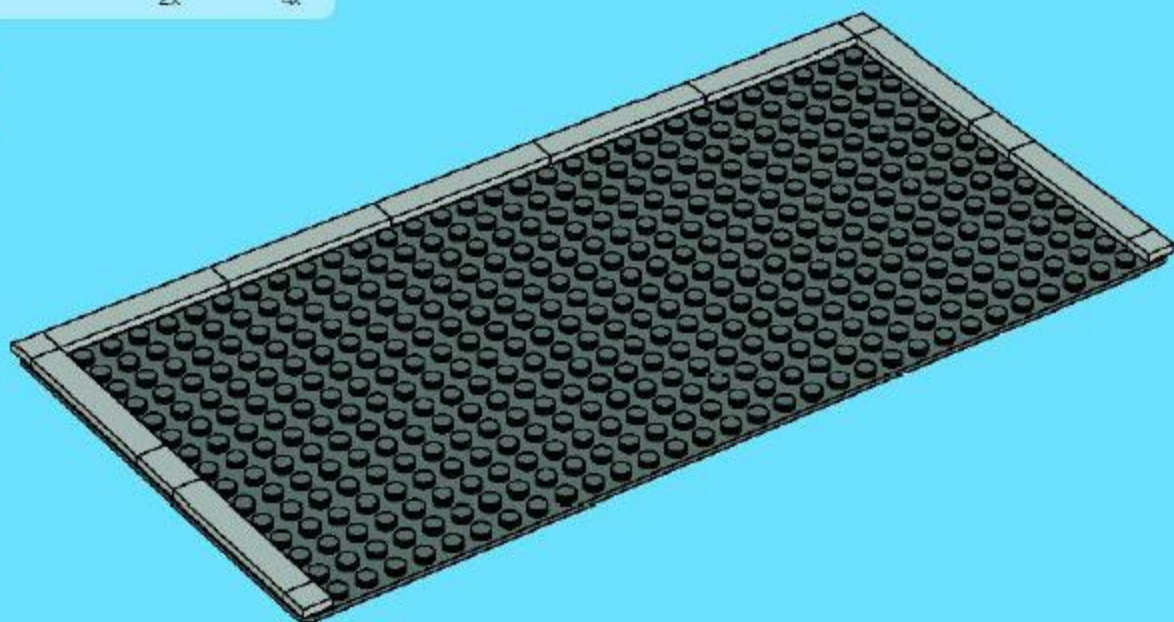

3

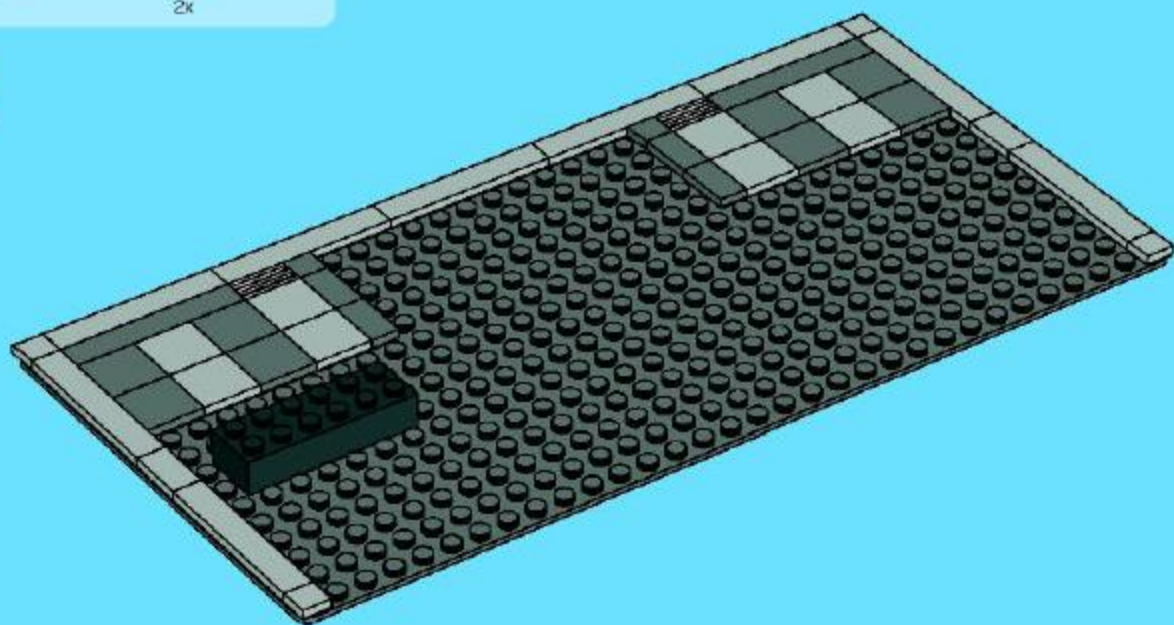

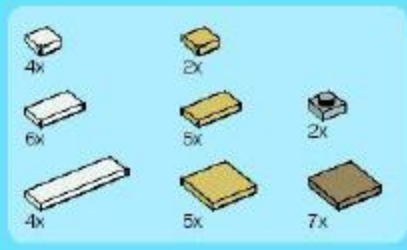

4

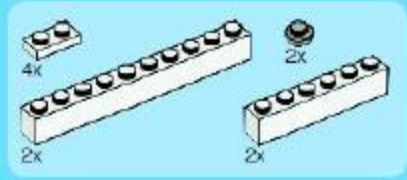
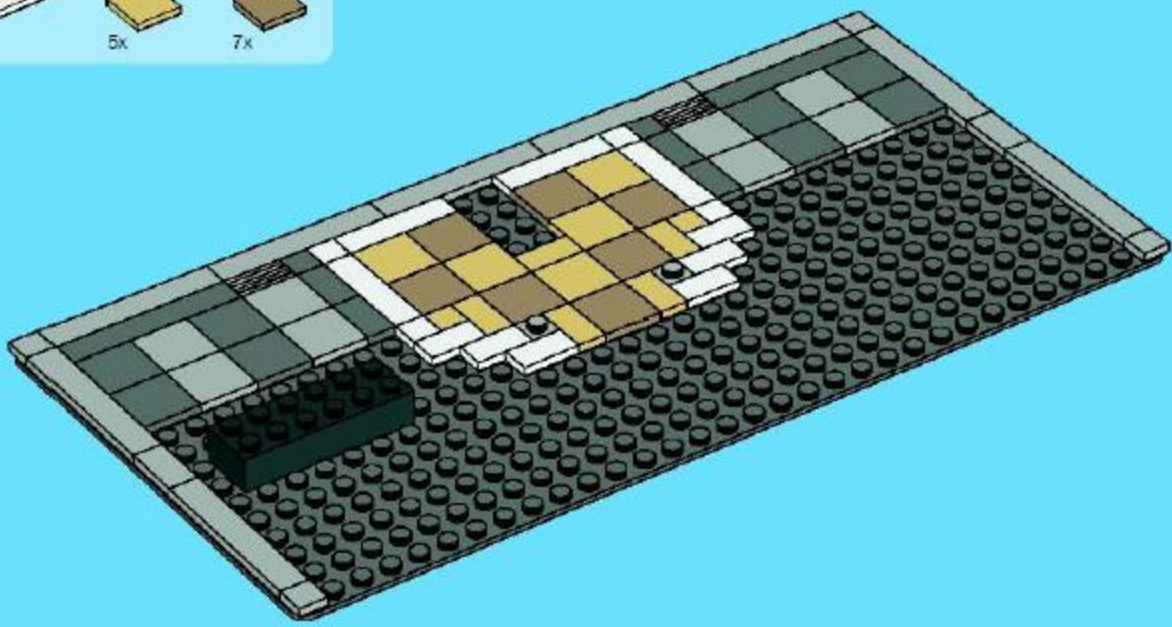

5

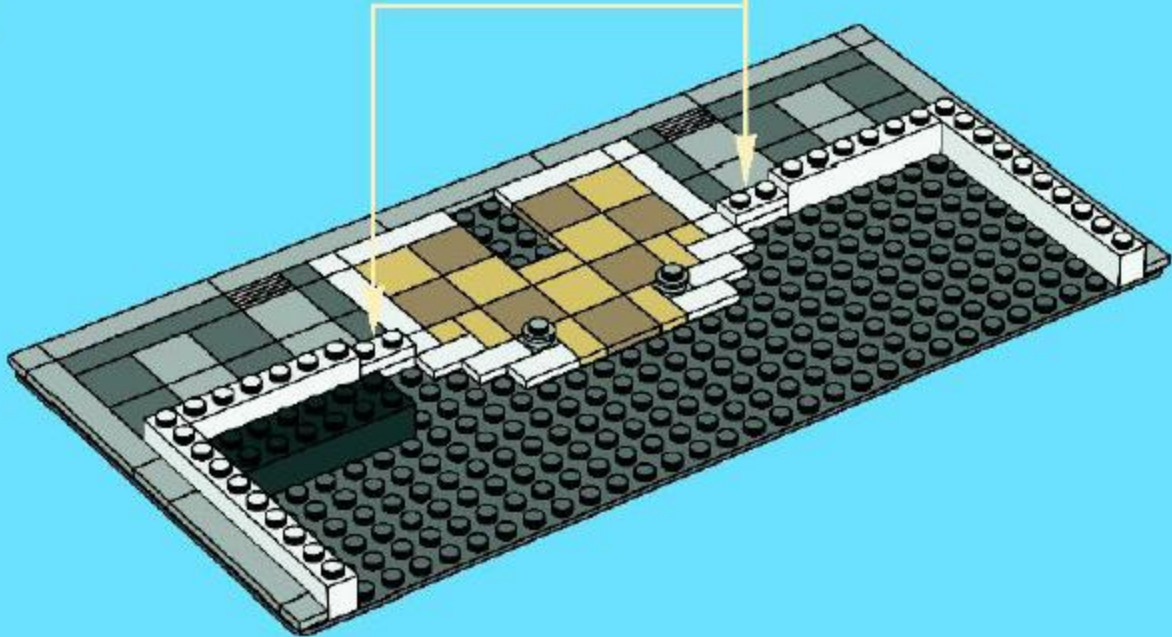
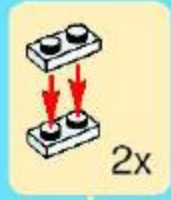



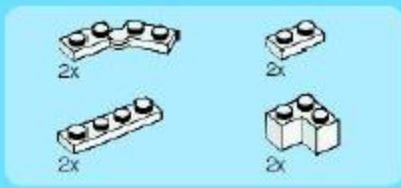

6

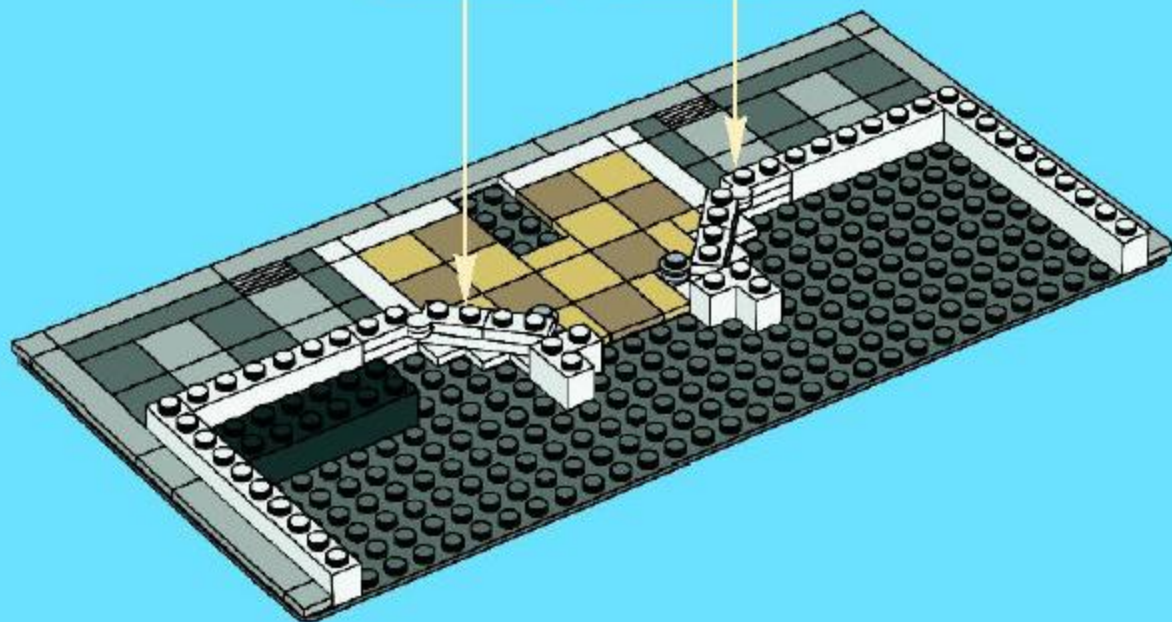
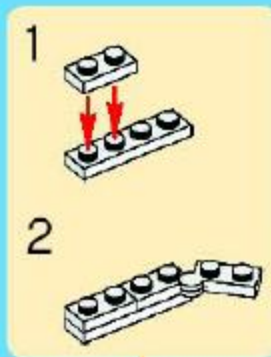
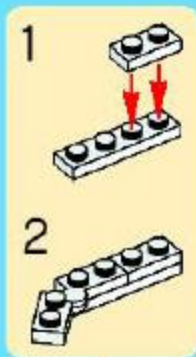

7

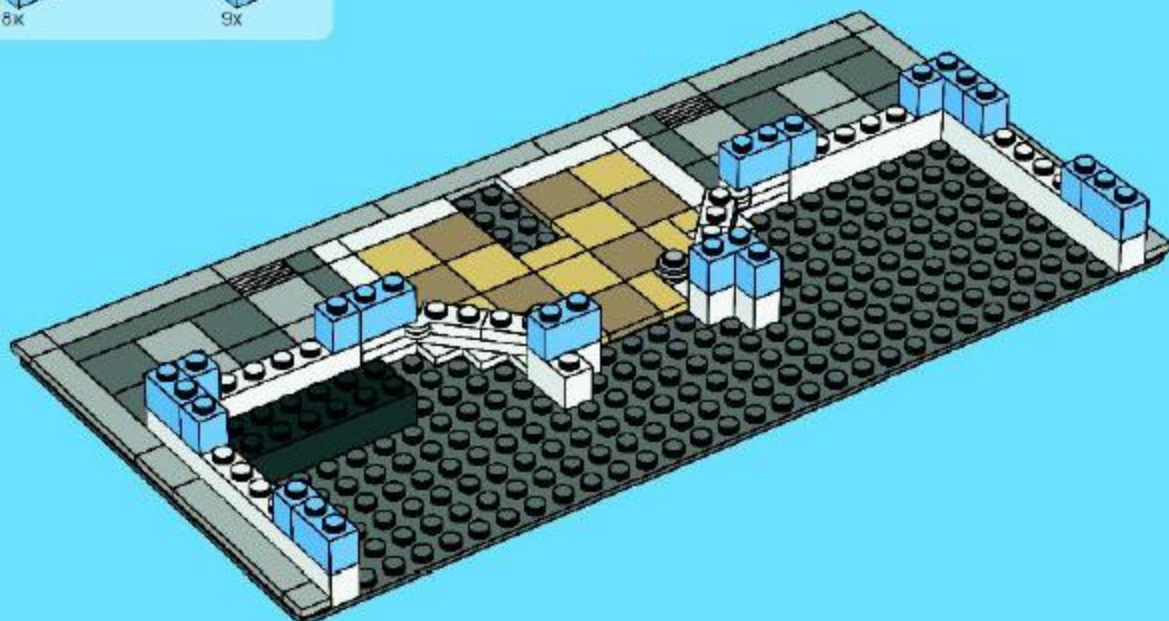



1x



1x

1



4x

2



12x

3



12x



1x



1x

4





5

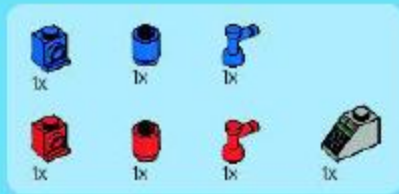

6

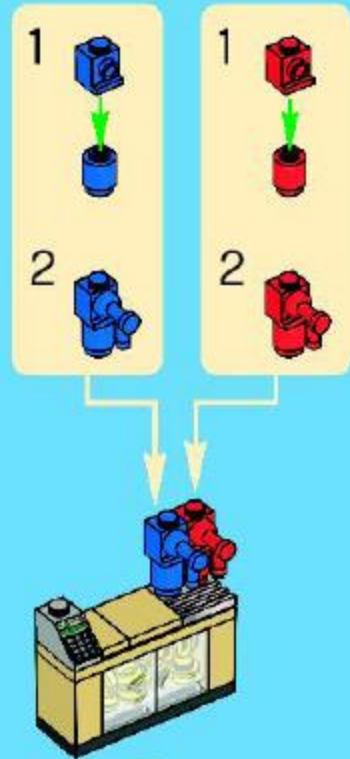

8

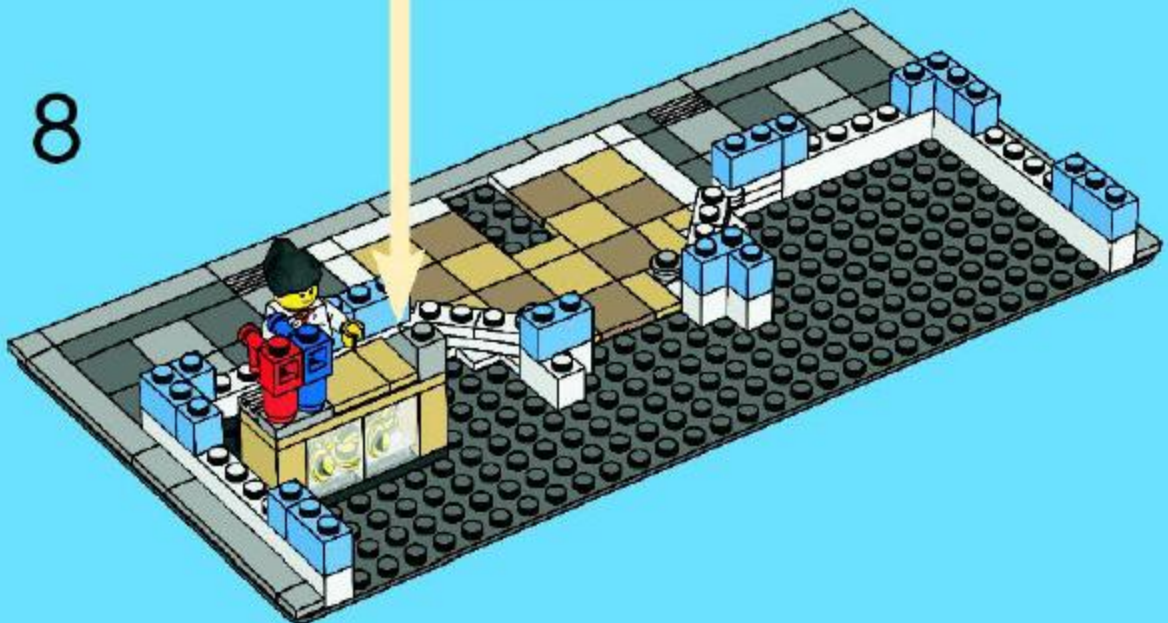



9

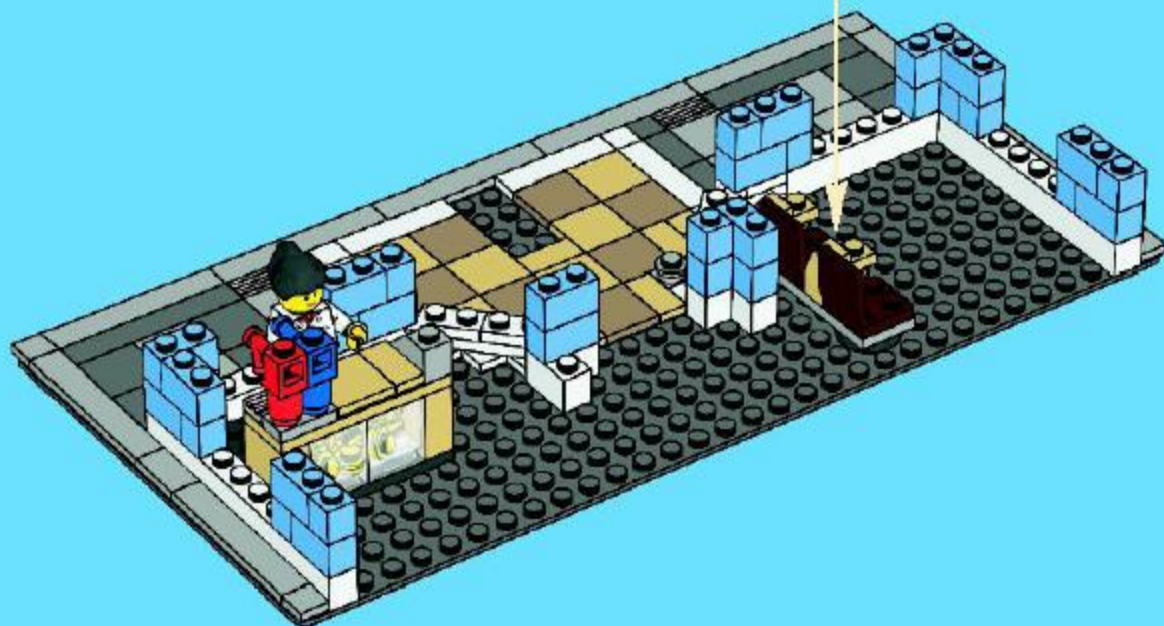
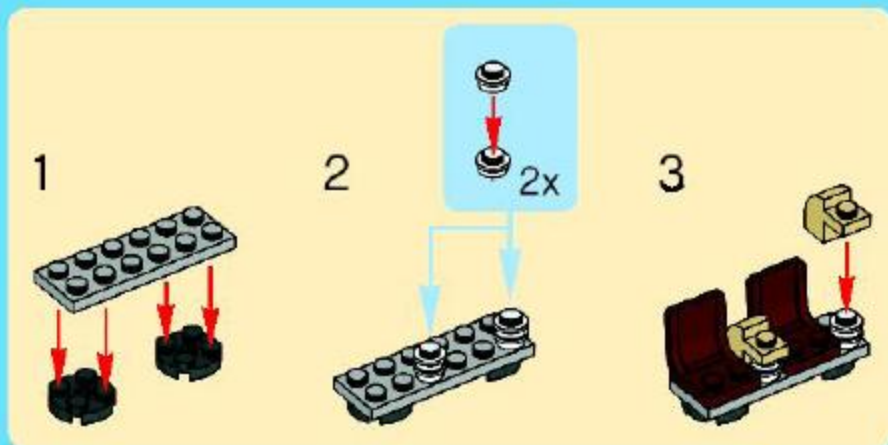

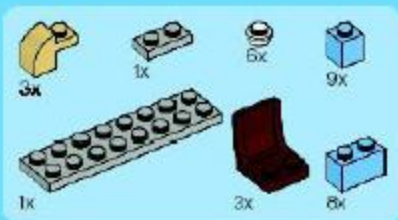

# 10

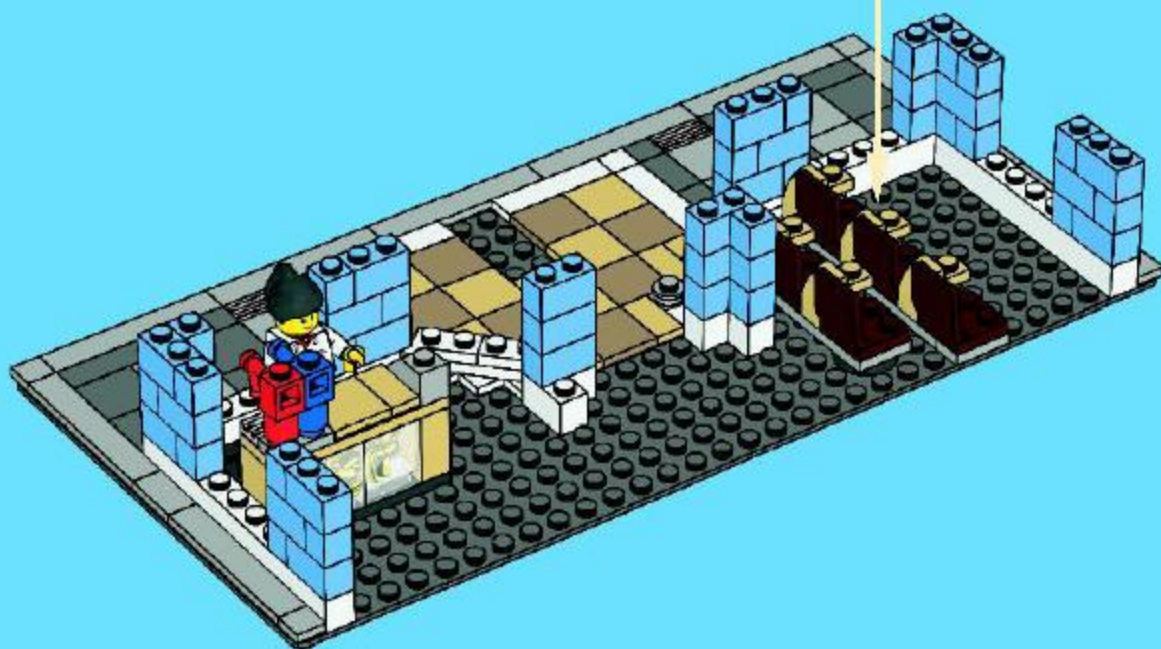
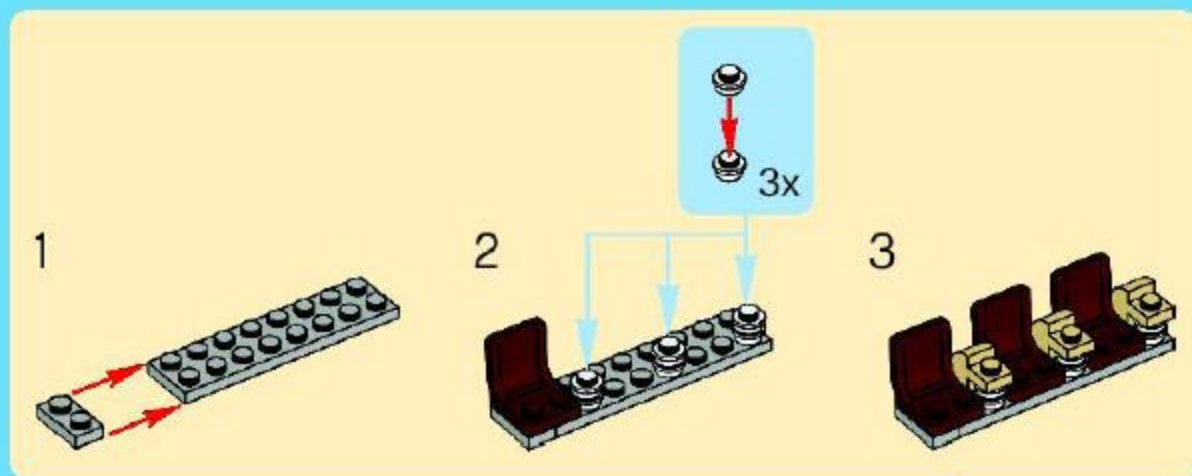

- 10x
- 5x
- 1x
- 1x
- 2x

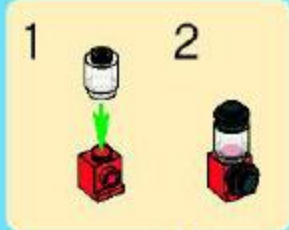

11

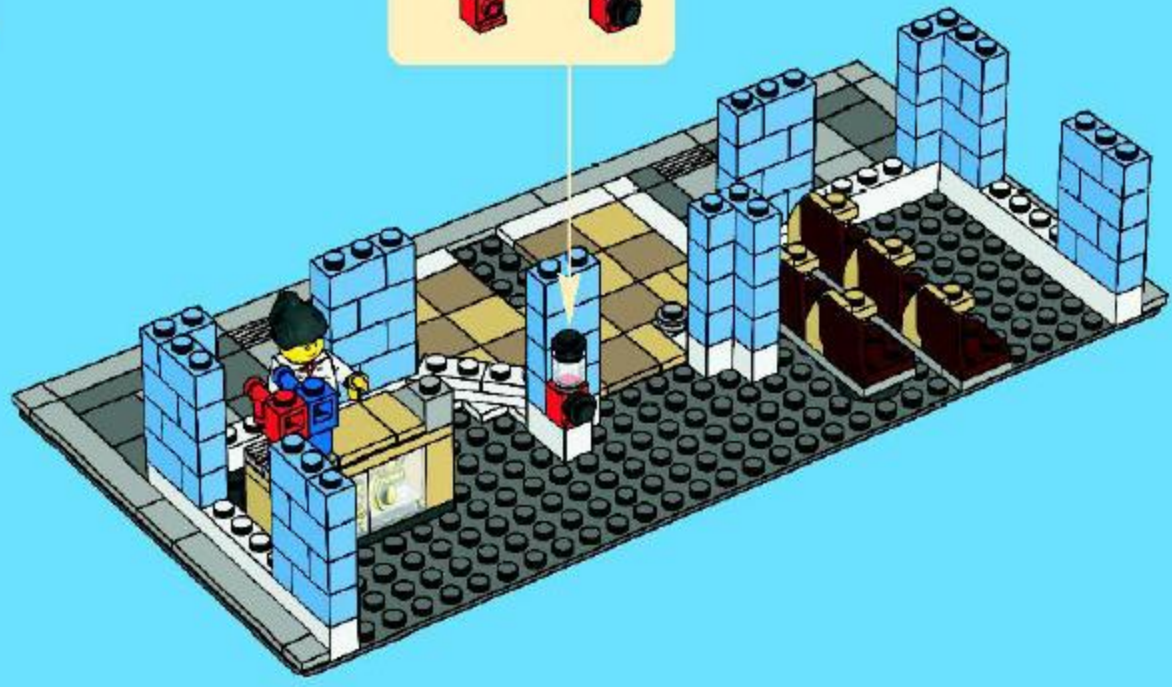

- 9x
- 1x
- 1x
- 7x
- 1x
- 1x

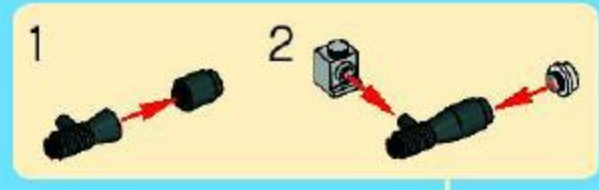

12

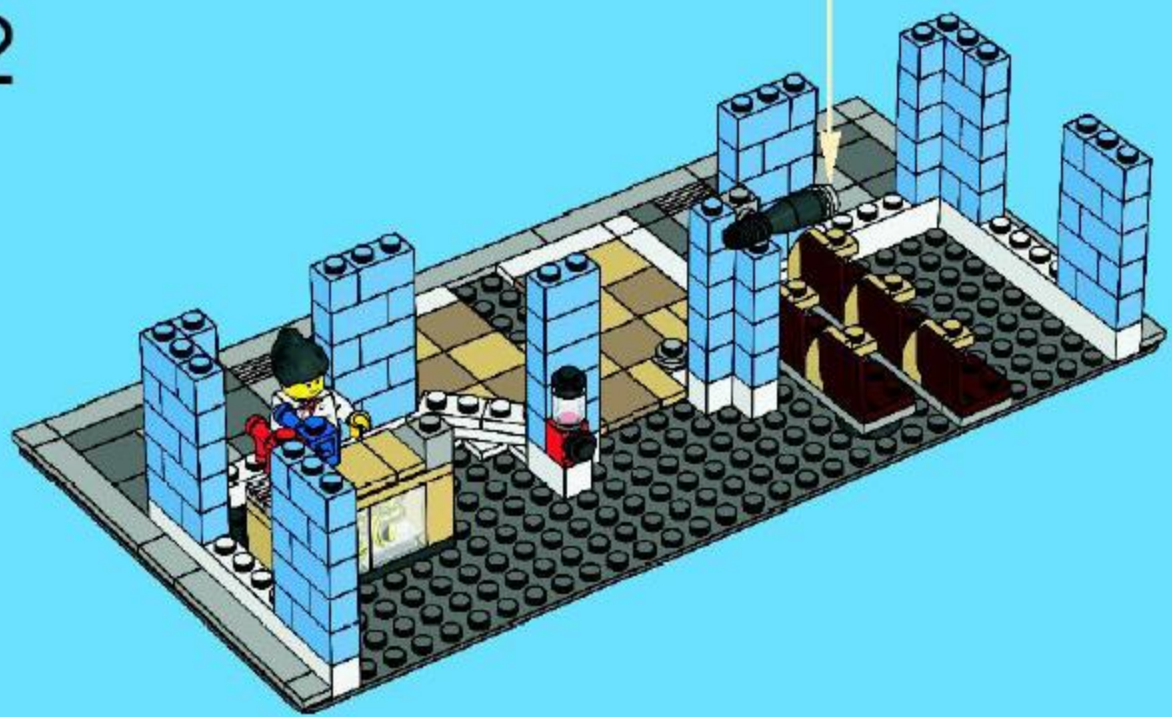

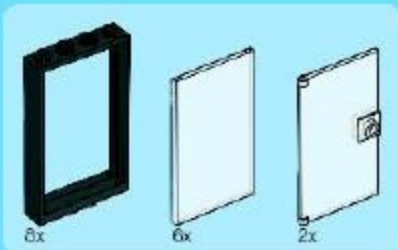

13

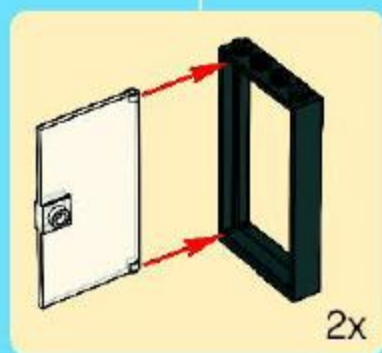

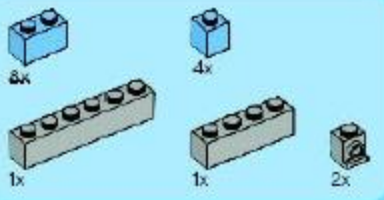

14



15







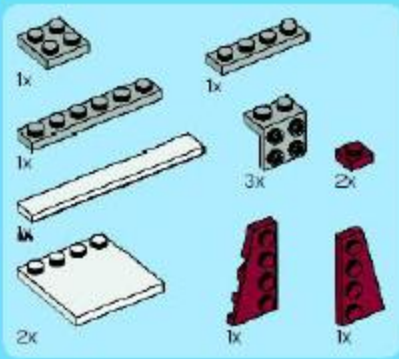

17

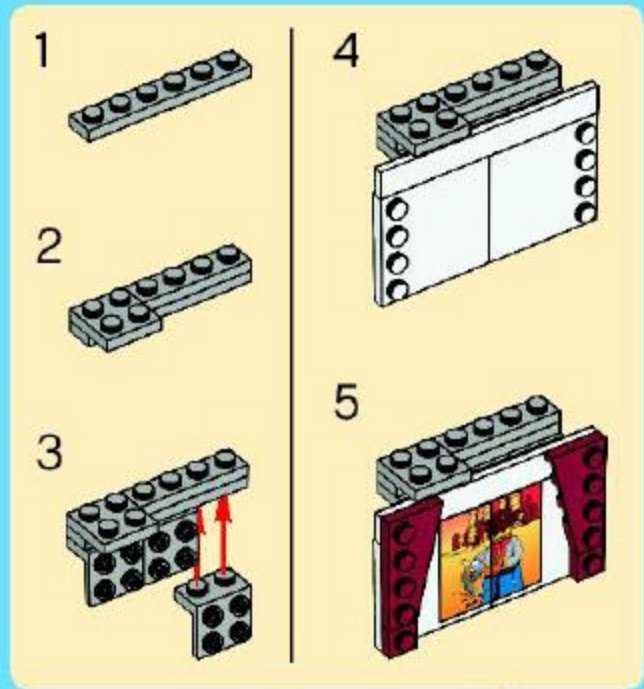

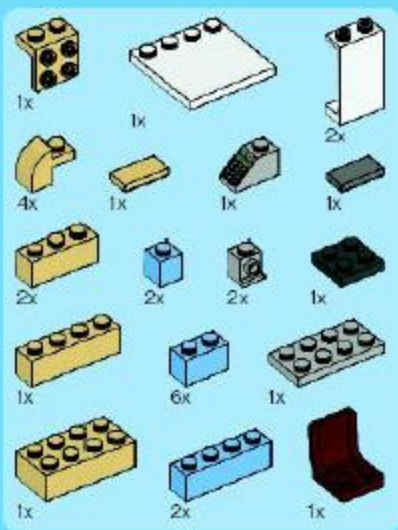

# 18

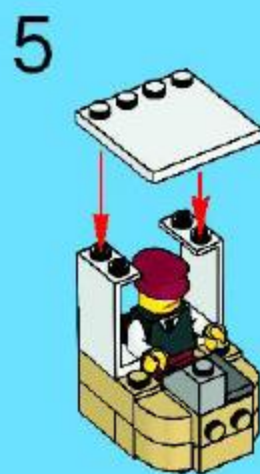
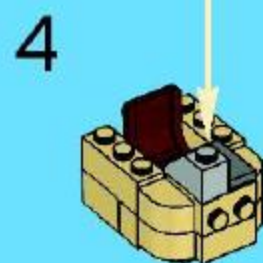
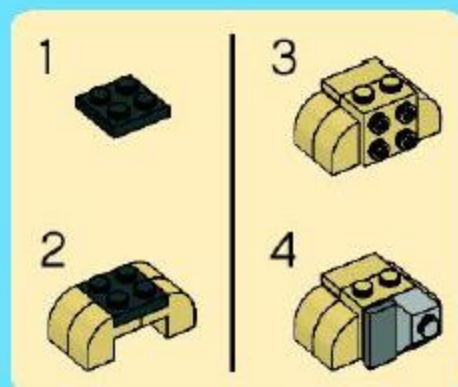
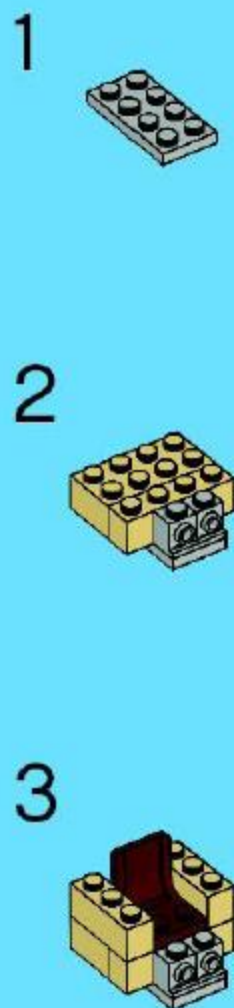



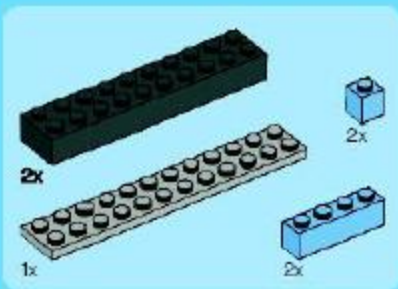

19

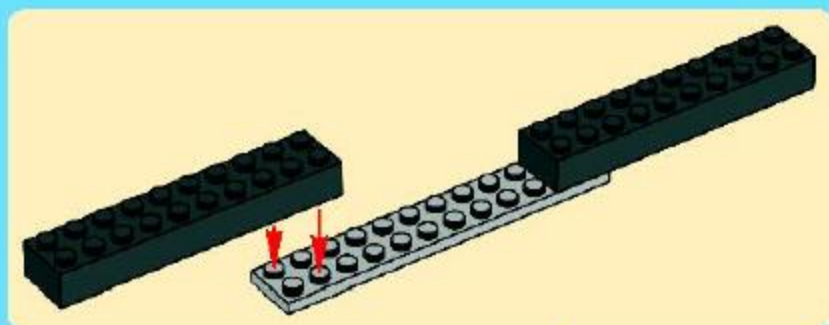

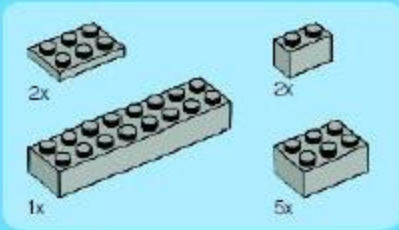

20

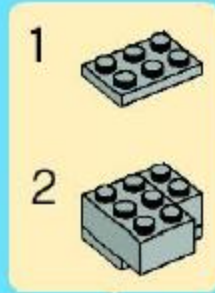
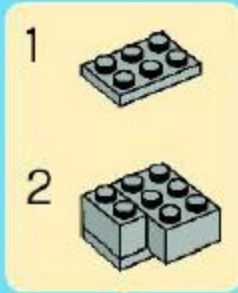

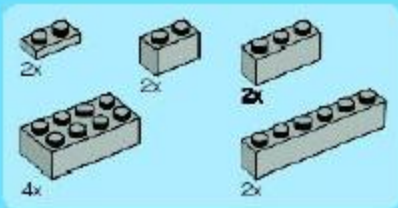

21



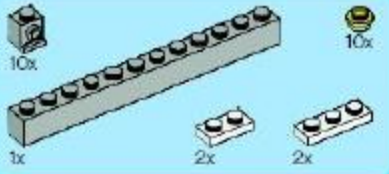

22

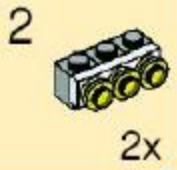
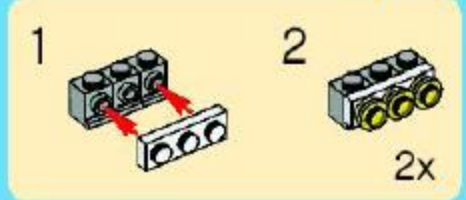
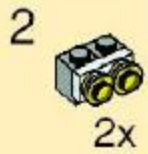
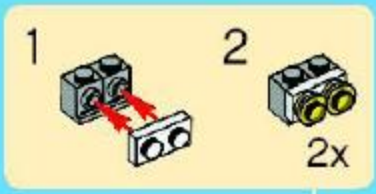



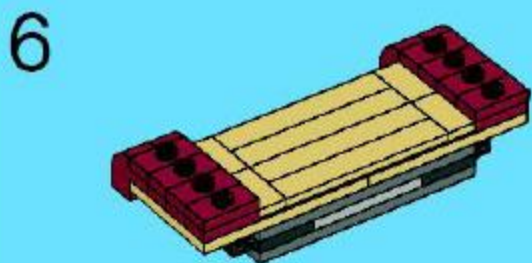
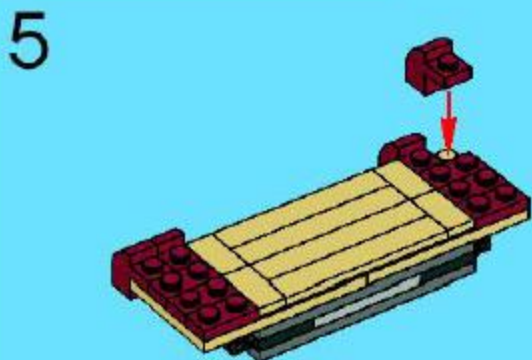
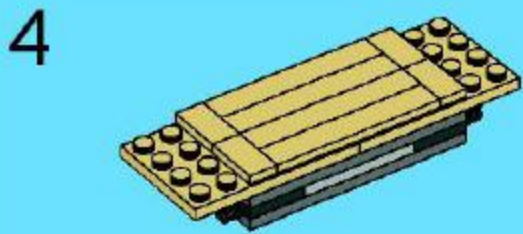
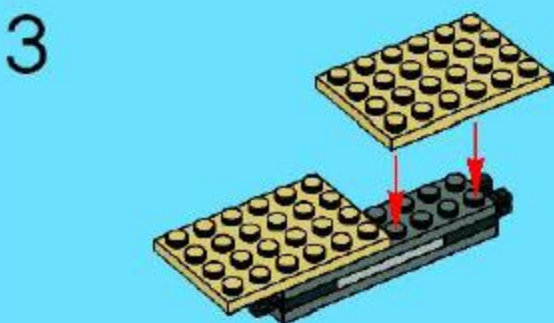
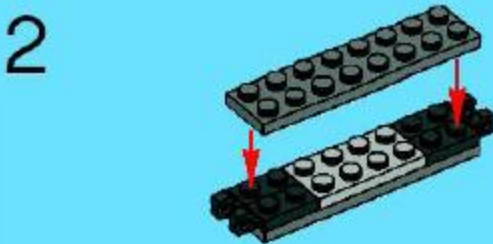
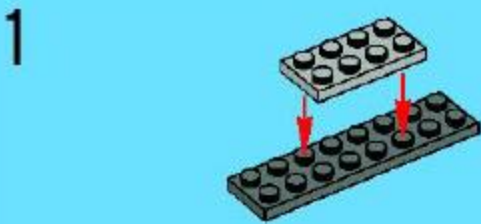
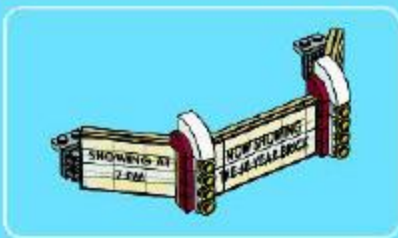



7

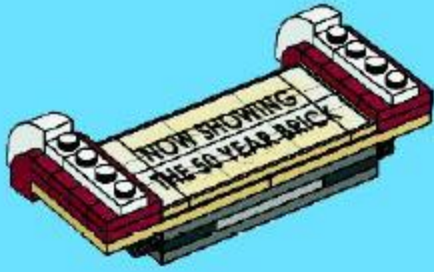

8

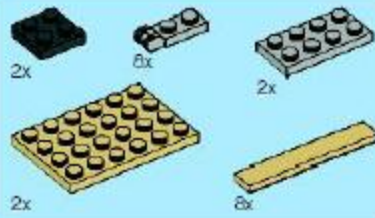
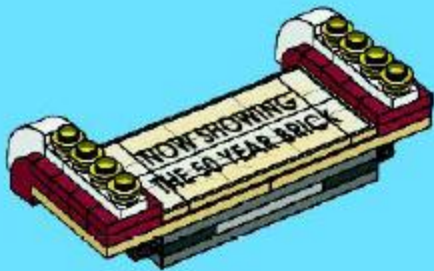

9

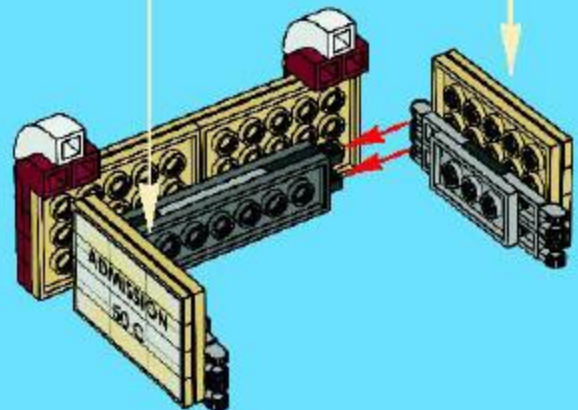
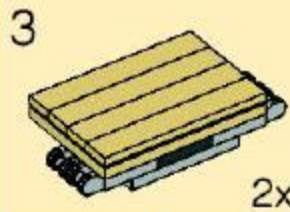
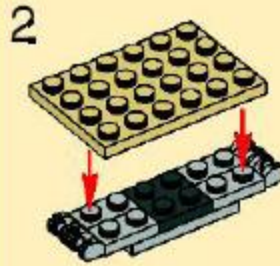
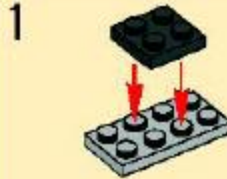



10

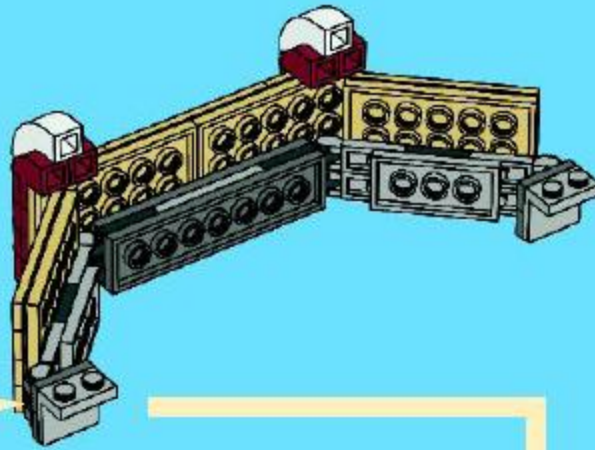
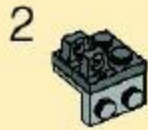

1x

23



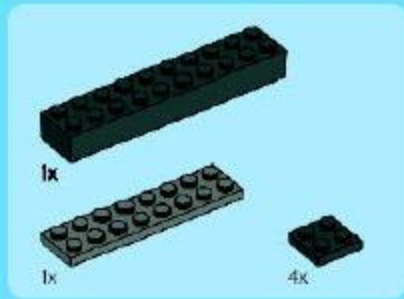

24



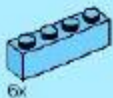

6x



2x

25



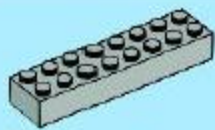

2x

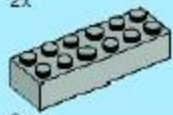

6x



2x

# 26



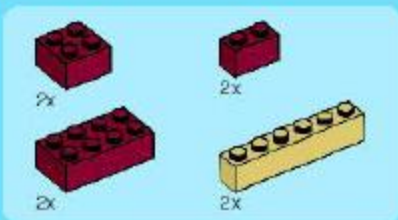

27





2x



2x



2x



4x



2x

# 28





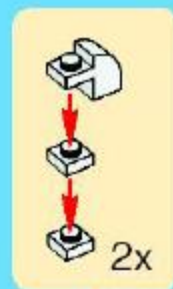
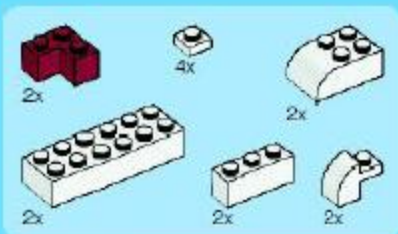

29





2x



2x



2x

# 30





2x



2x



6x



6x



6x

# 31





2x



2x

32



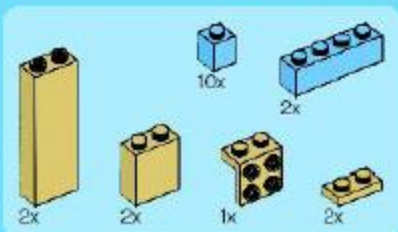

33

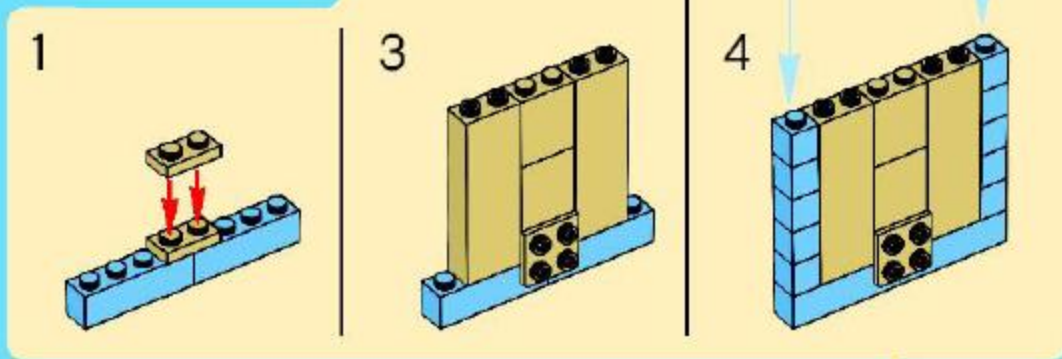

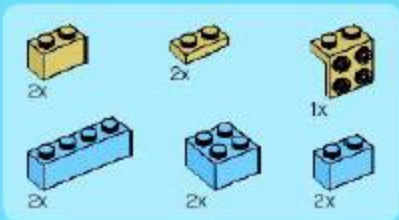

34

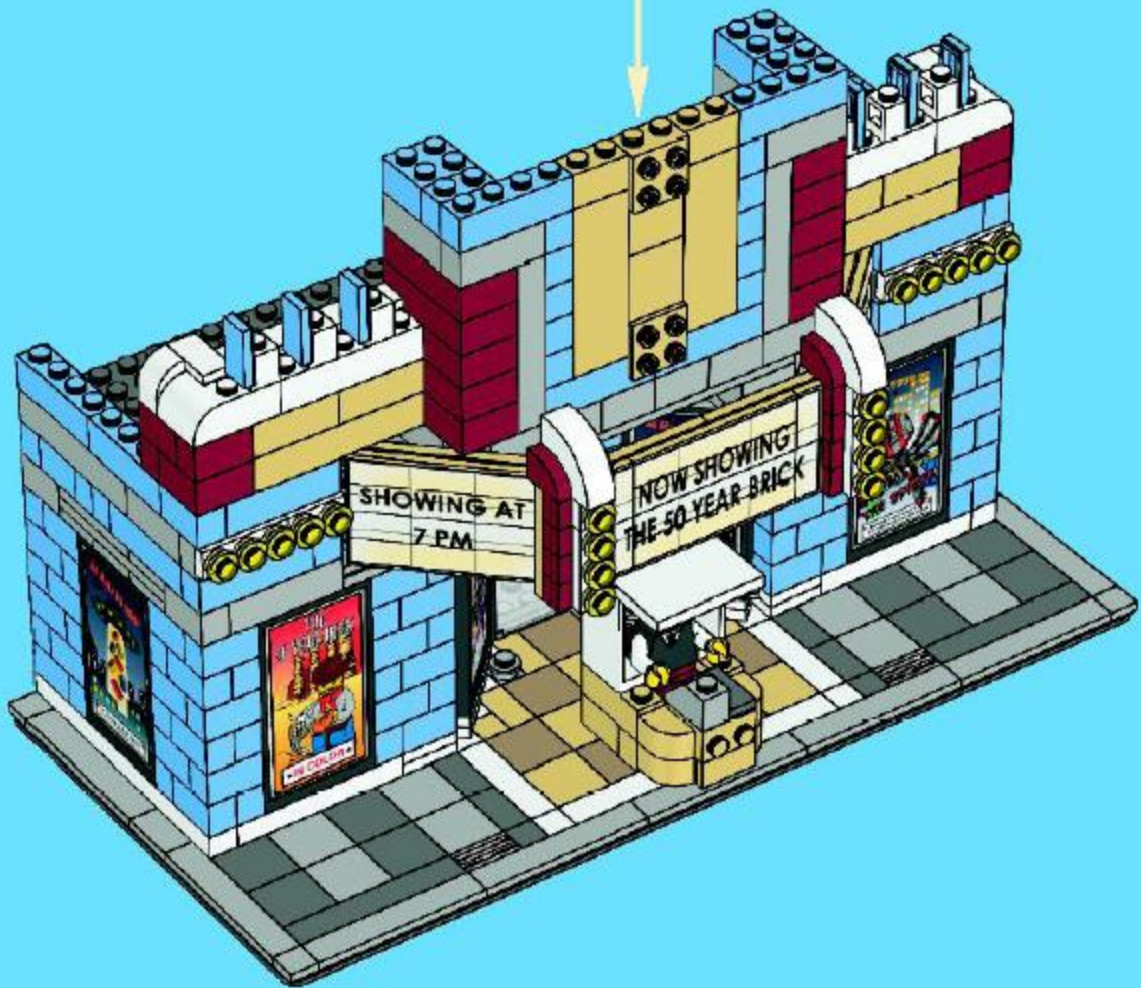
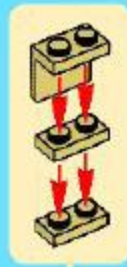

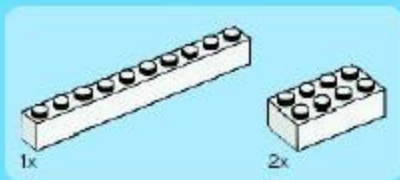

35





1x



4x

# 36





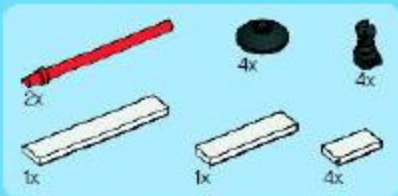

37



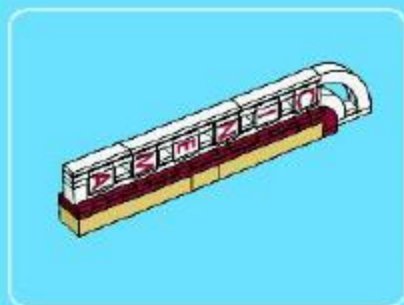

1

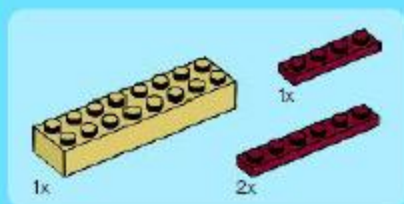
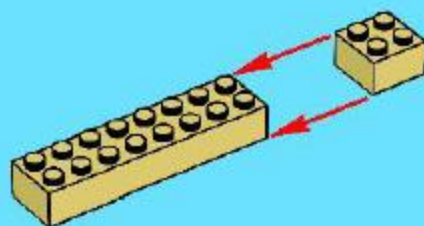

2

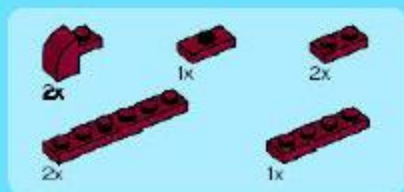
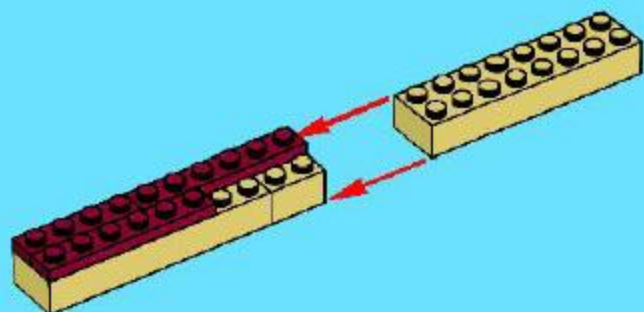

3

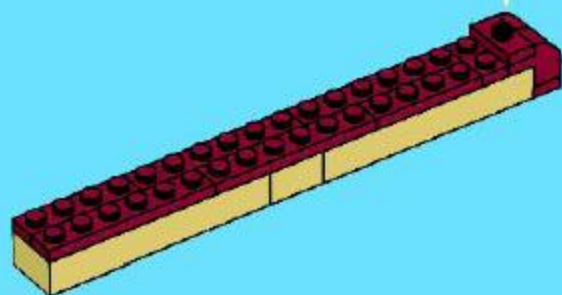
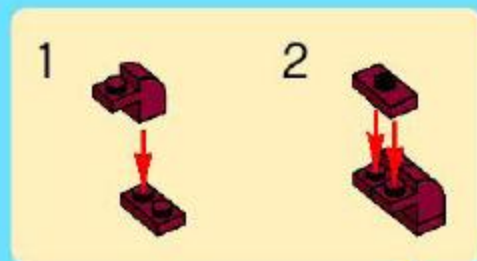



5x



7x

4

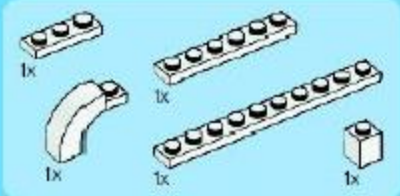
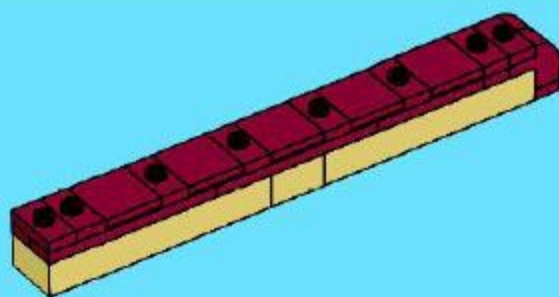

5

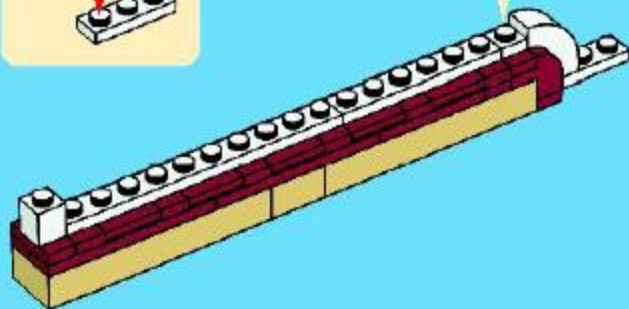
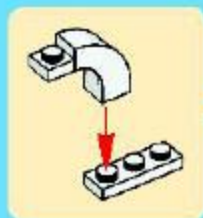

6

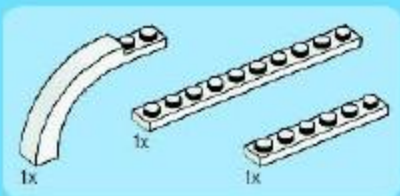
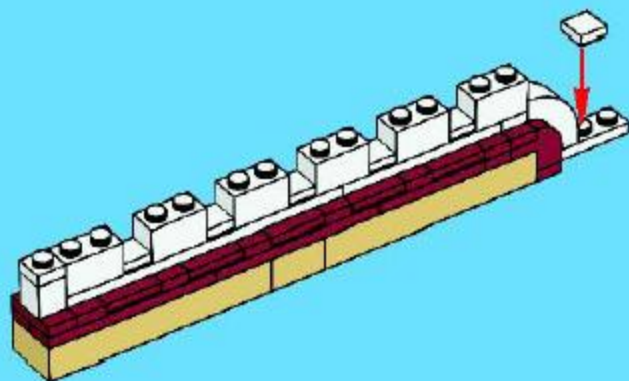

7

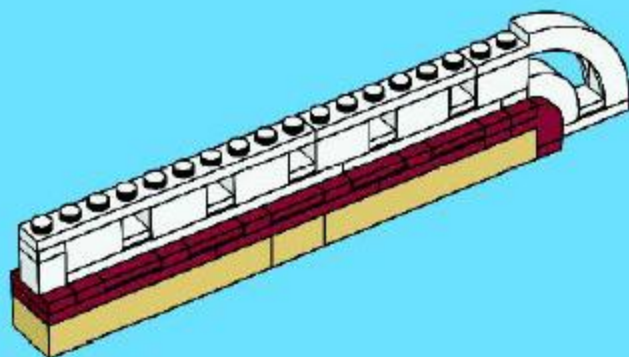

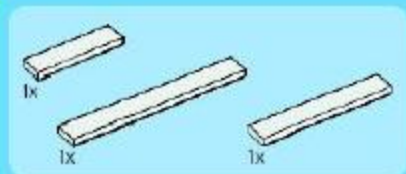

8

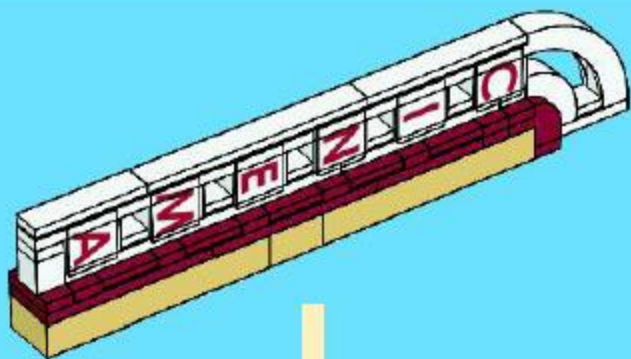

38

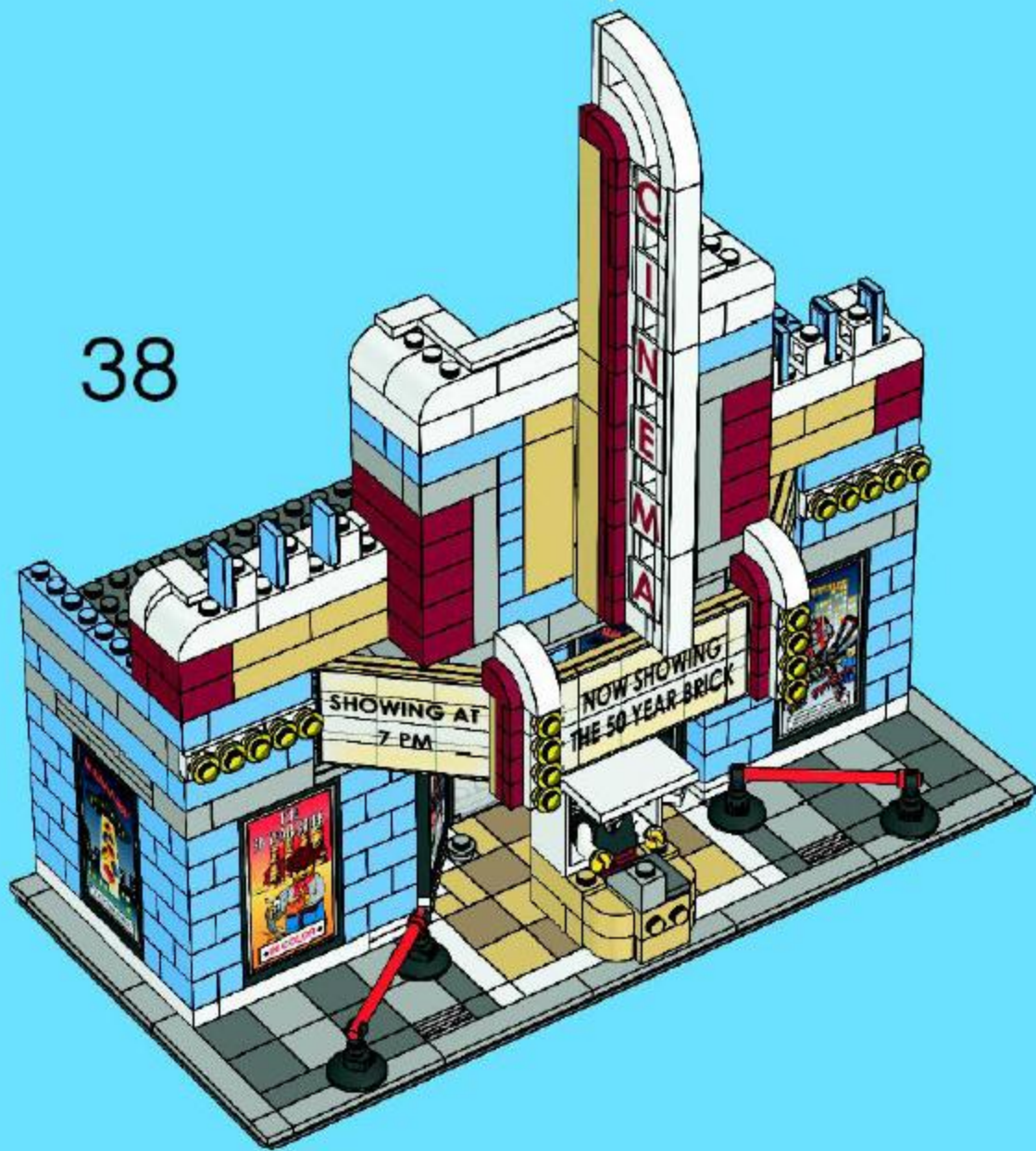

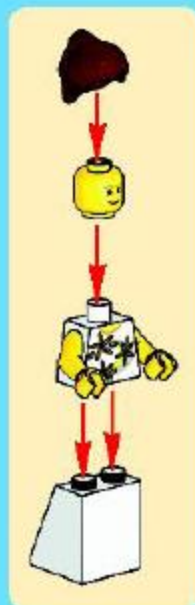
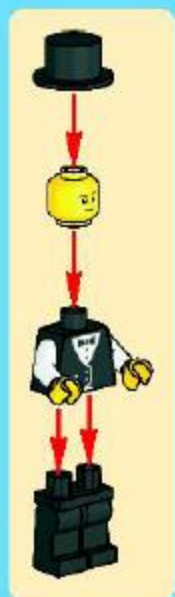

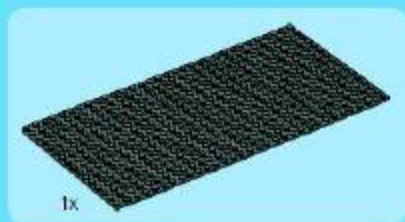

1

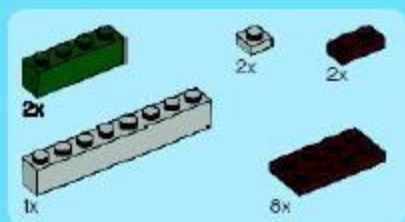
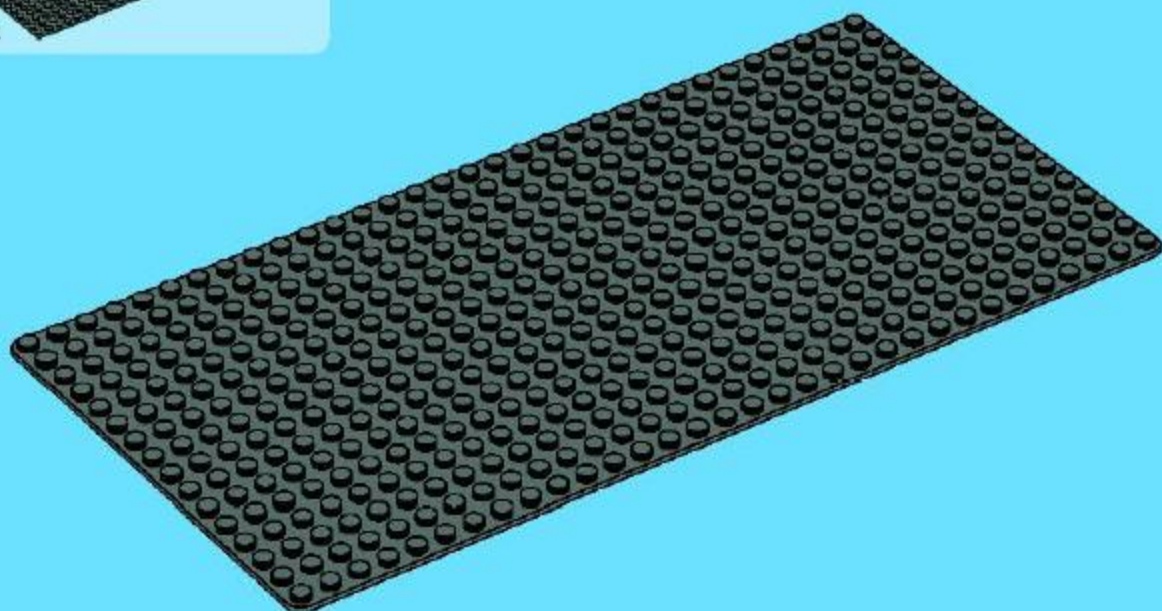

2

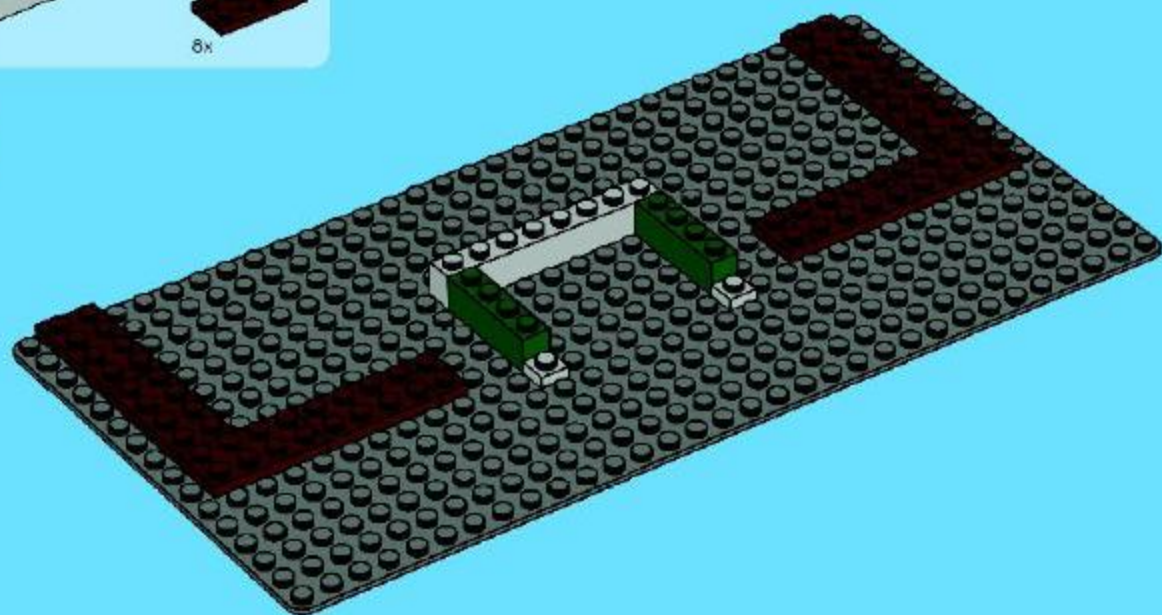

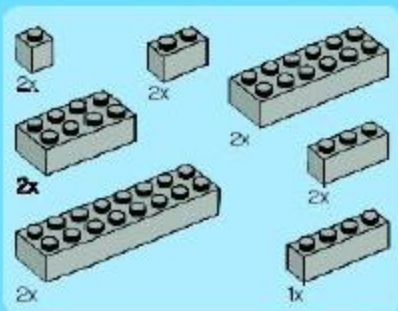

3

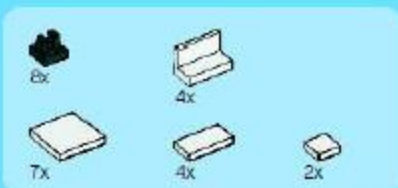
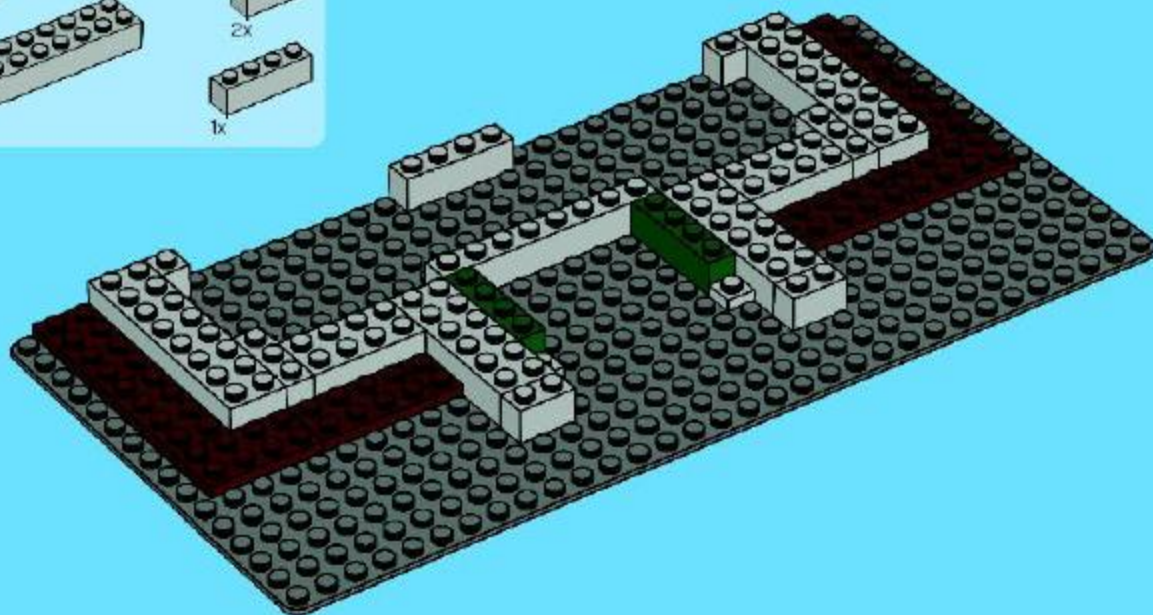

4

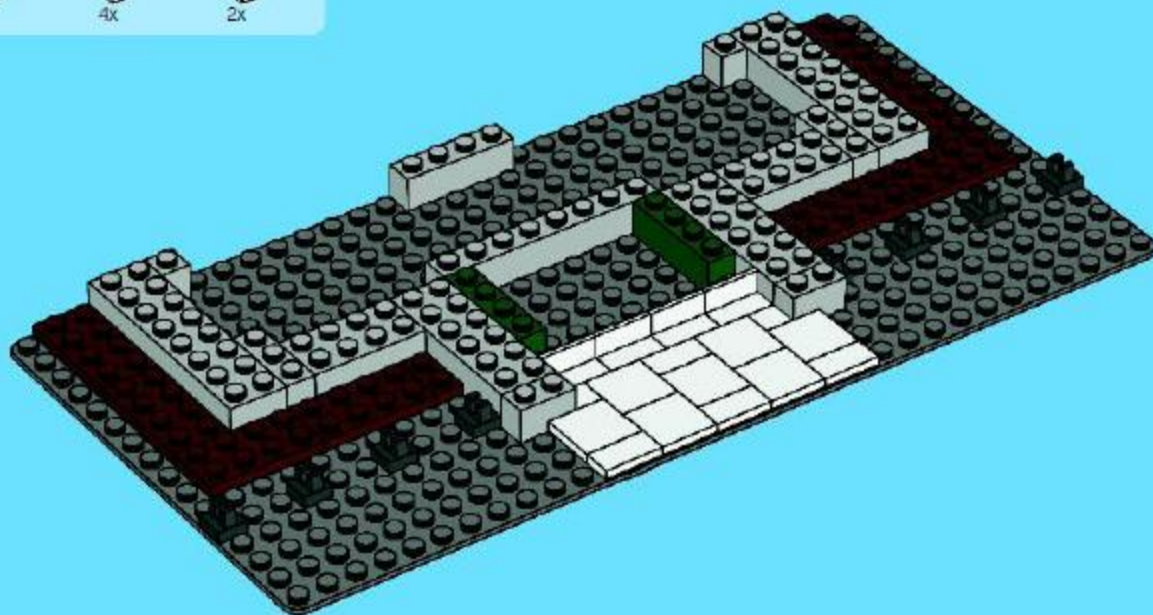

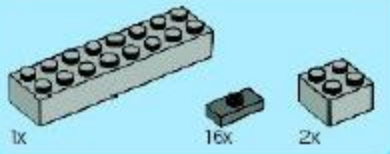

5

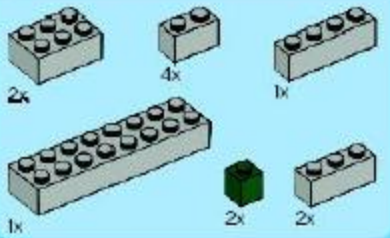

6

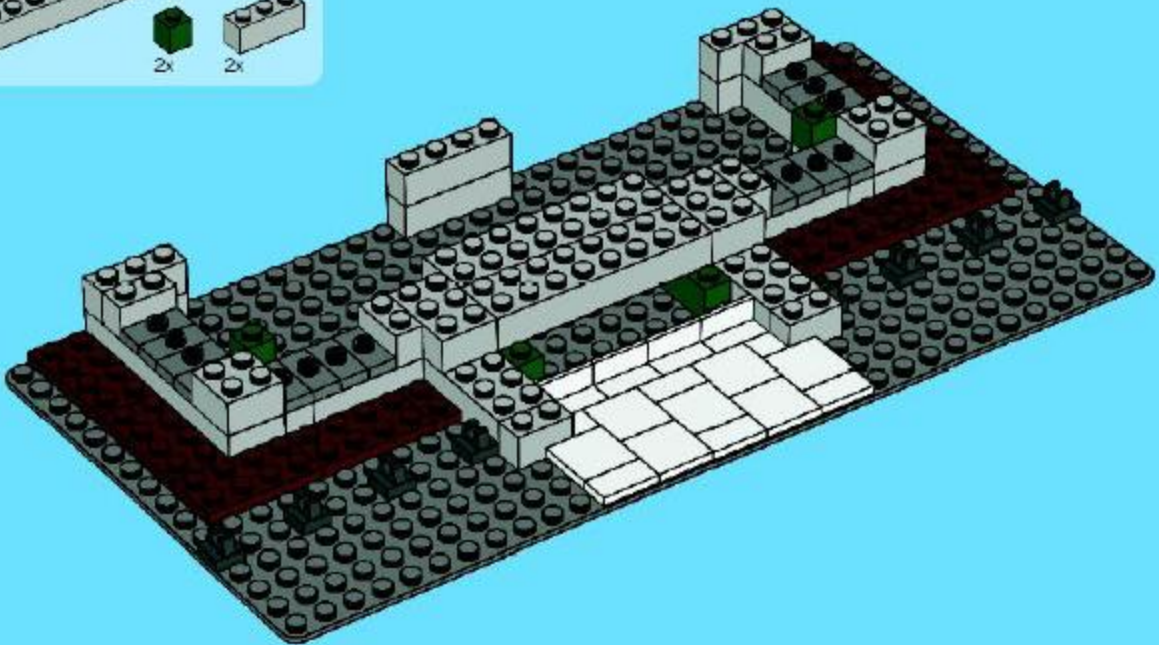



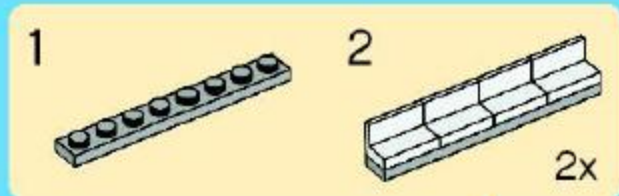
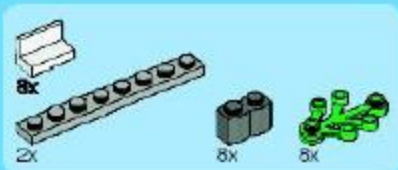

7

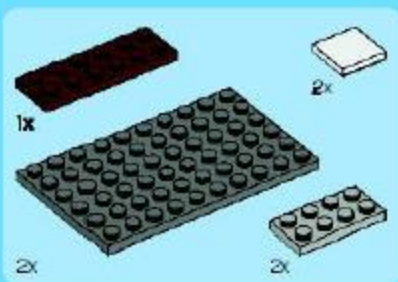
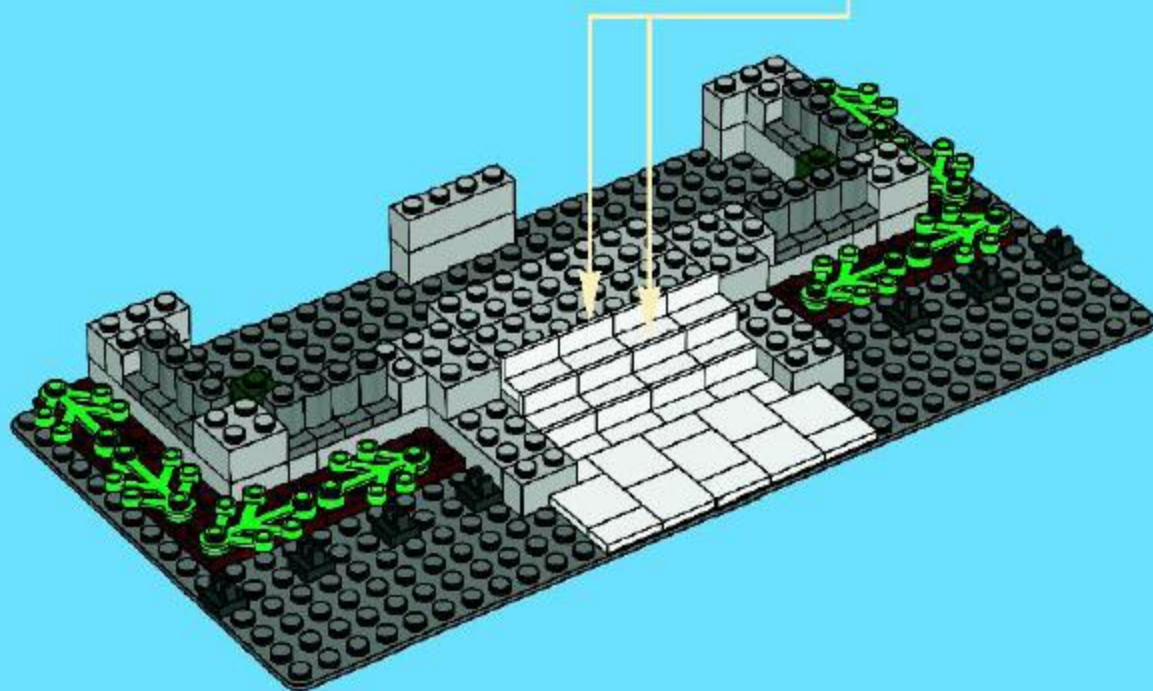

8

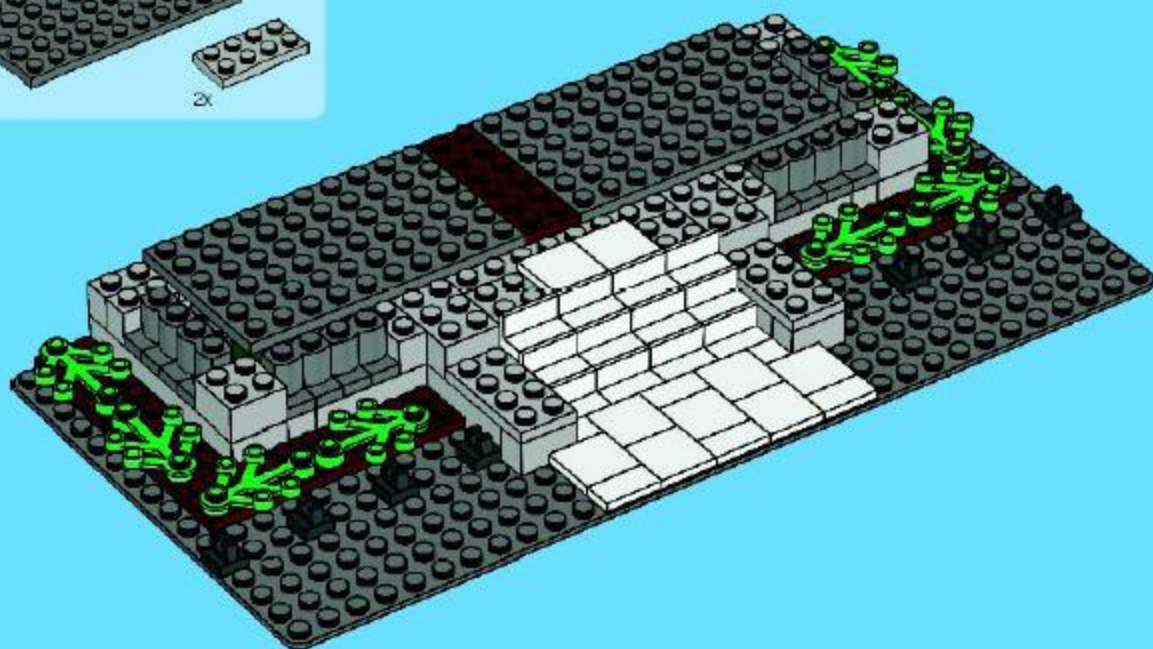

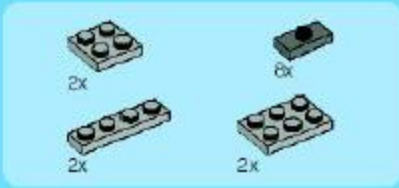

9

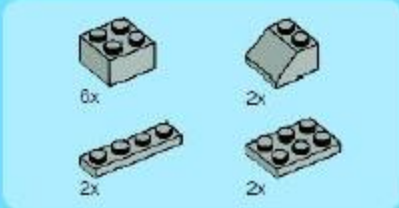
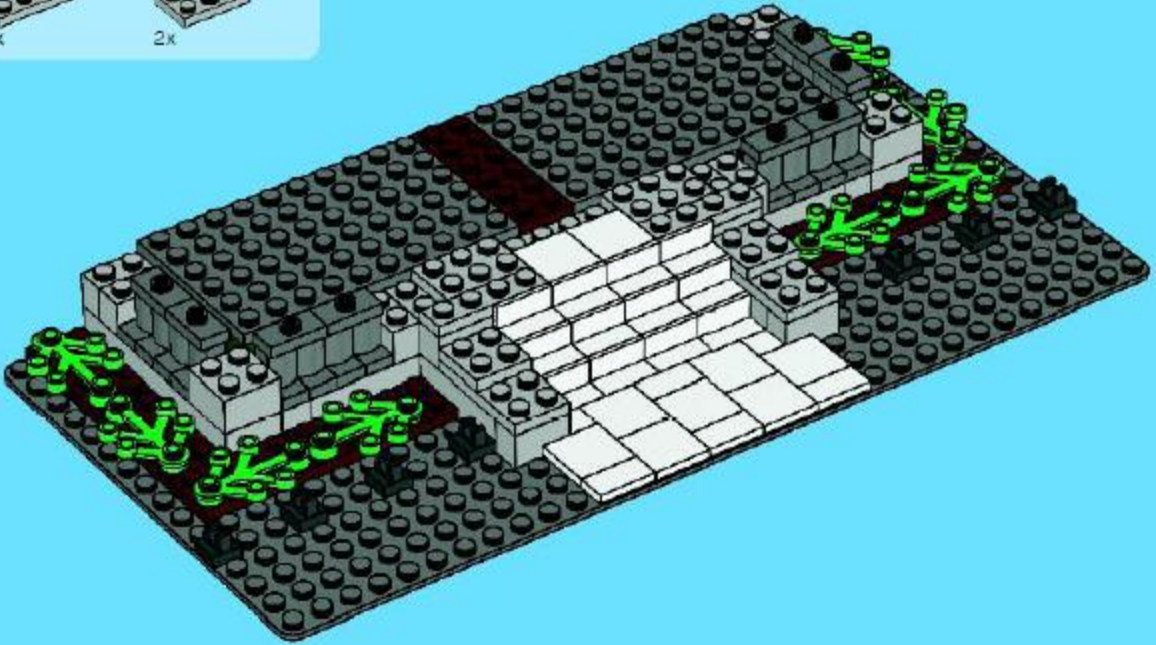

10

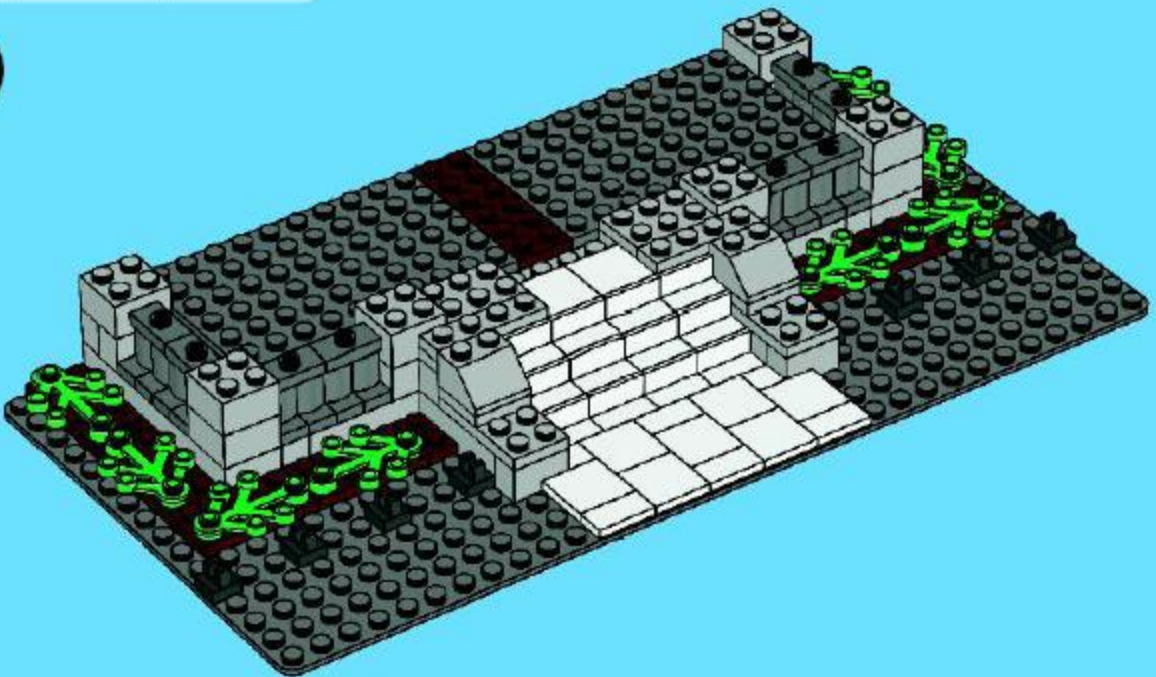



2x



2x



4x



6x

# 11



2x



3x



4x



2x



5x



10x

1



2



6x

1



2



4x

# 12

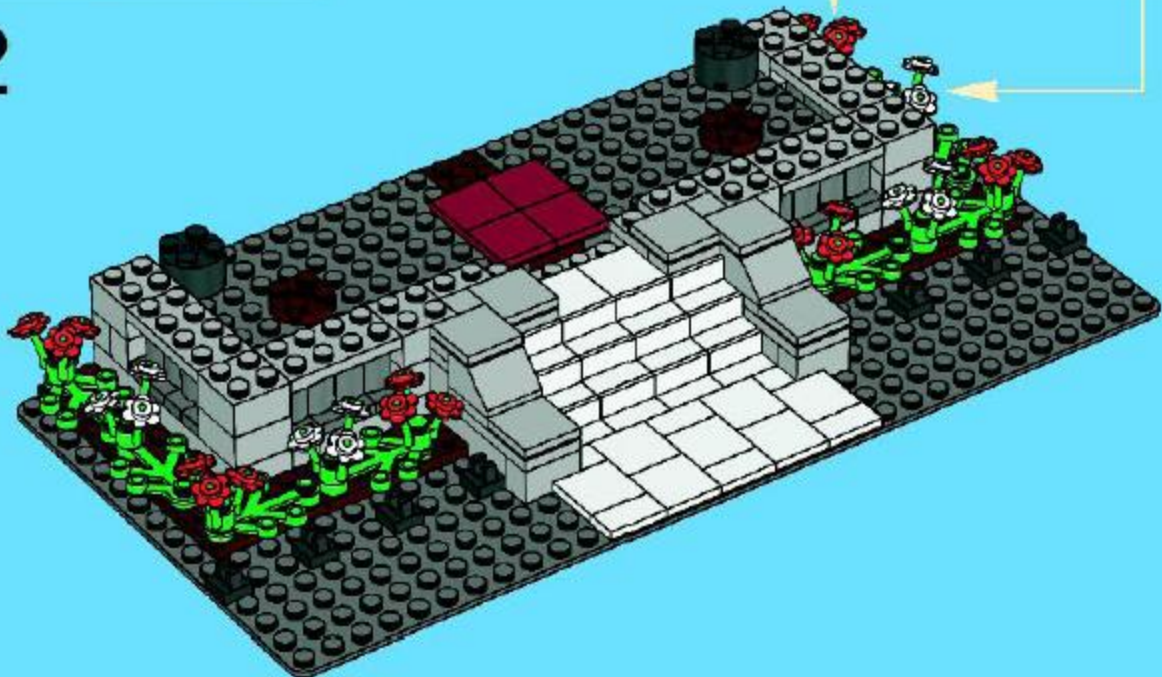



13

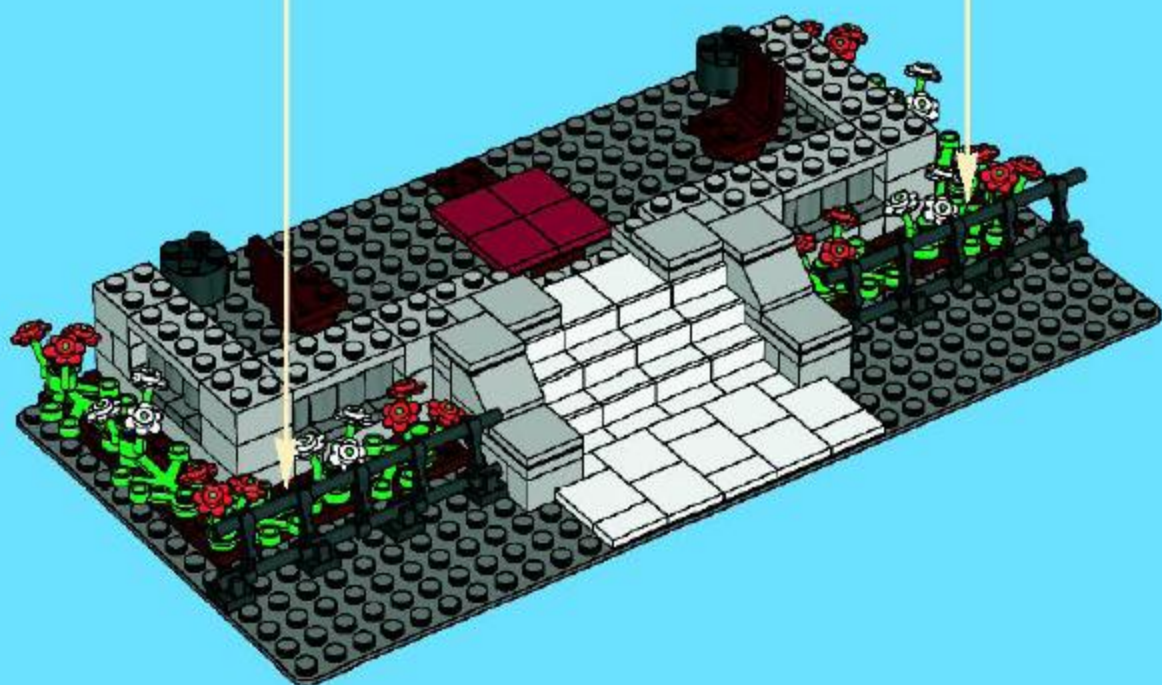
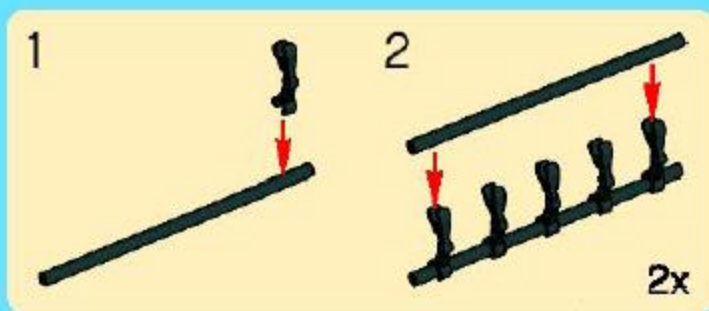



2x



4x



4x



4x

# 14

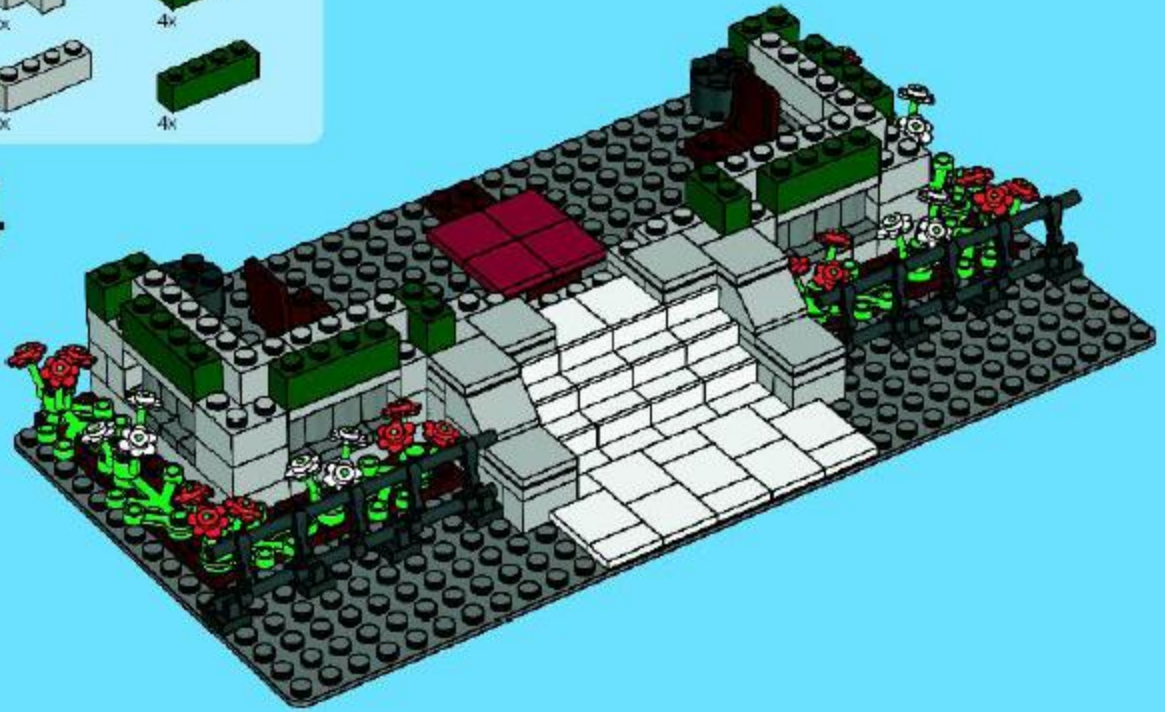

6x



2x



2x



4x

1

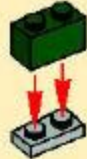

2



2x

# 15

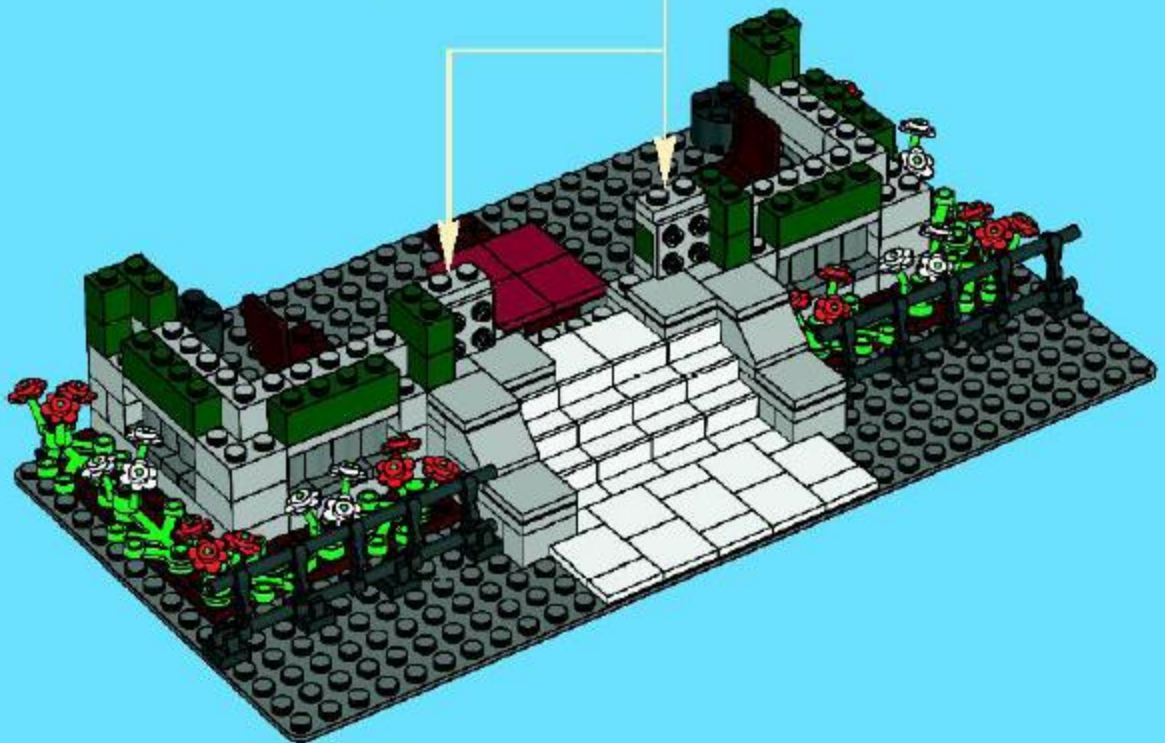



16

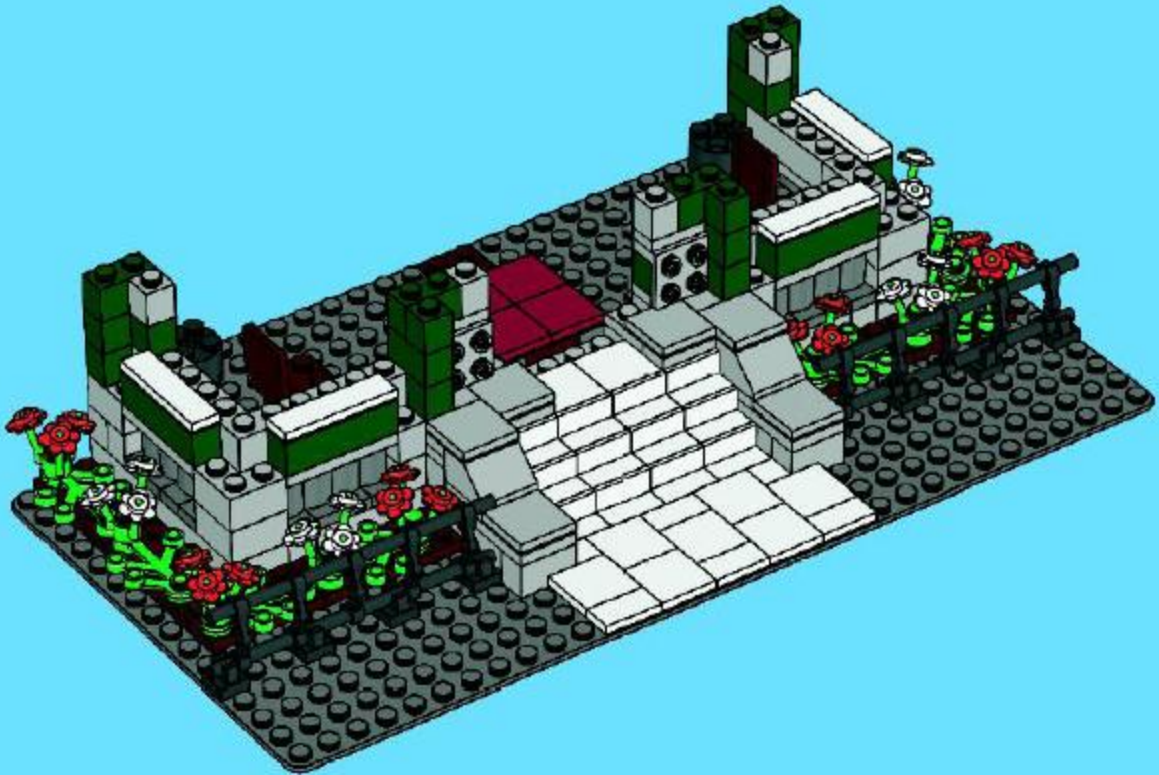

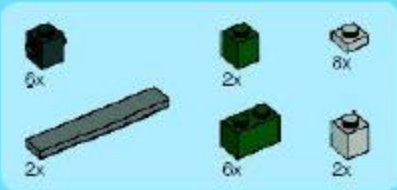

17

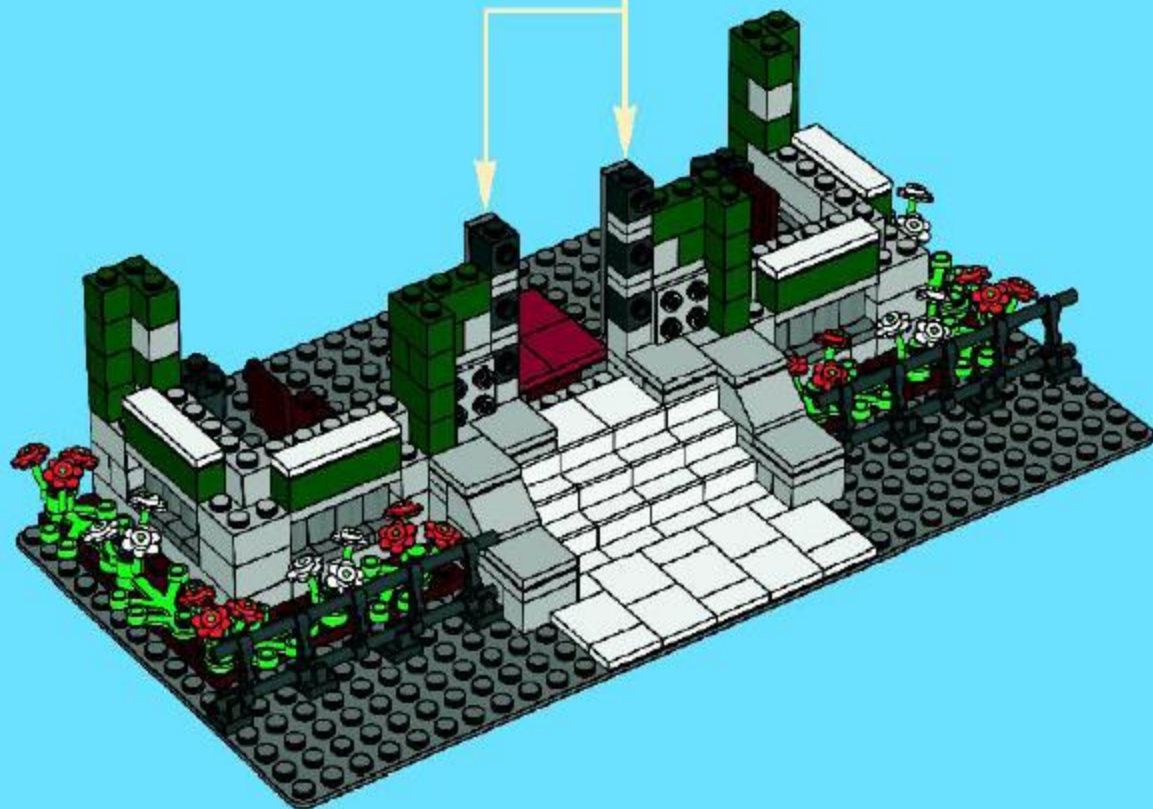
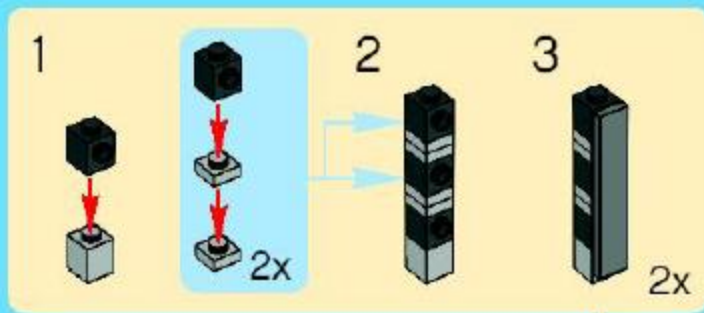

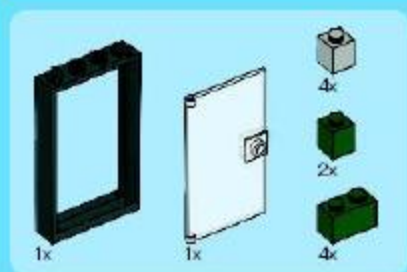

18

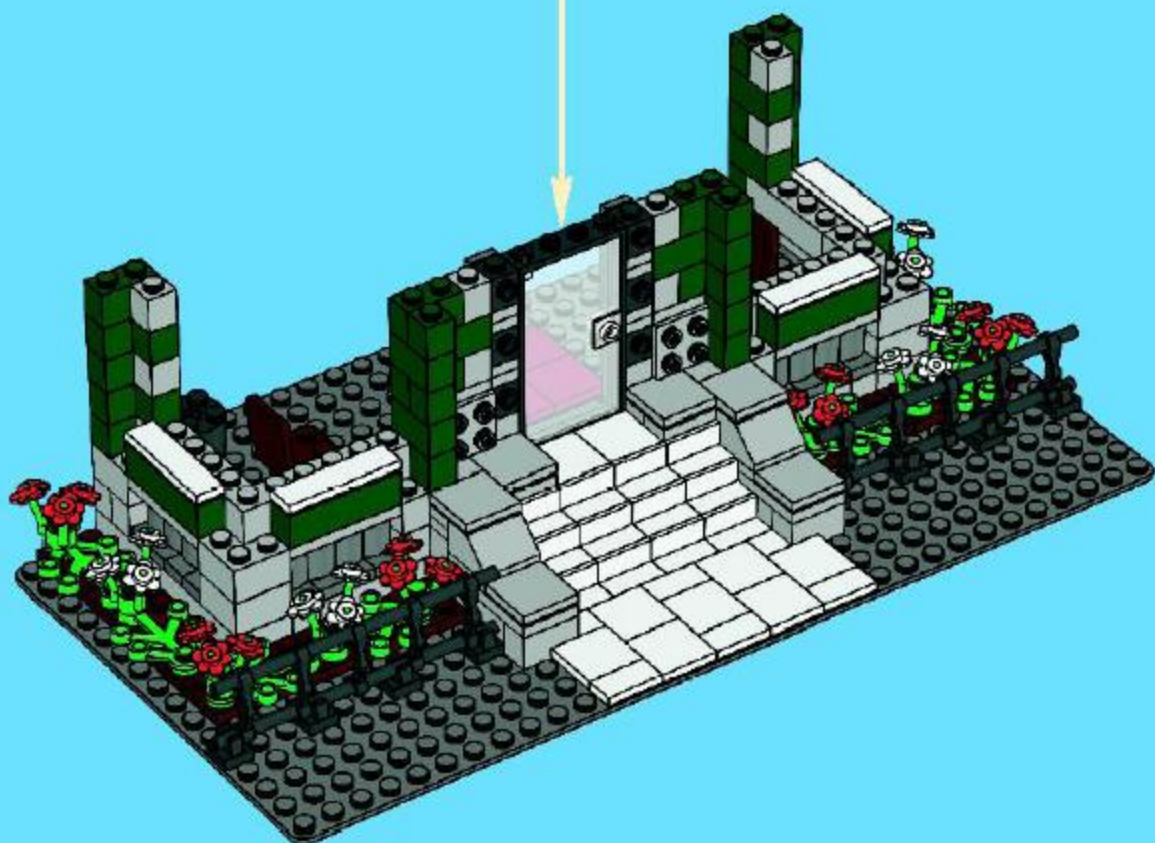
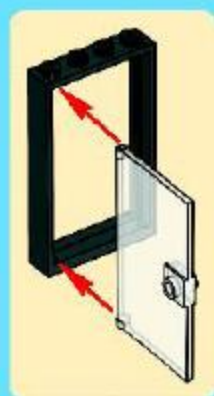



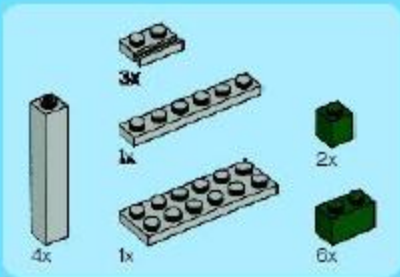

19

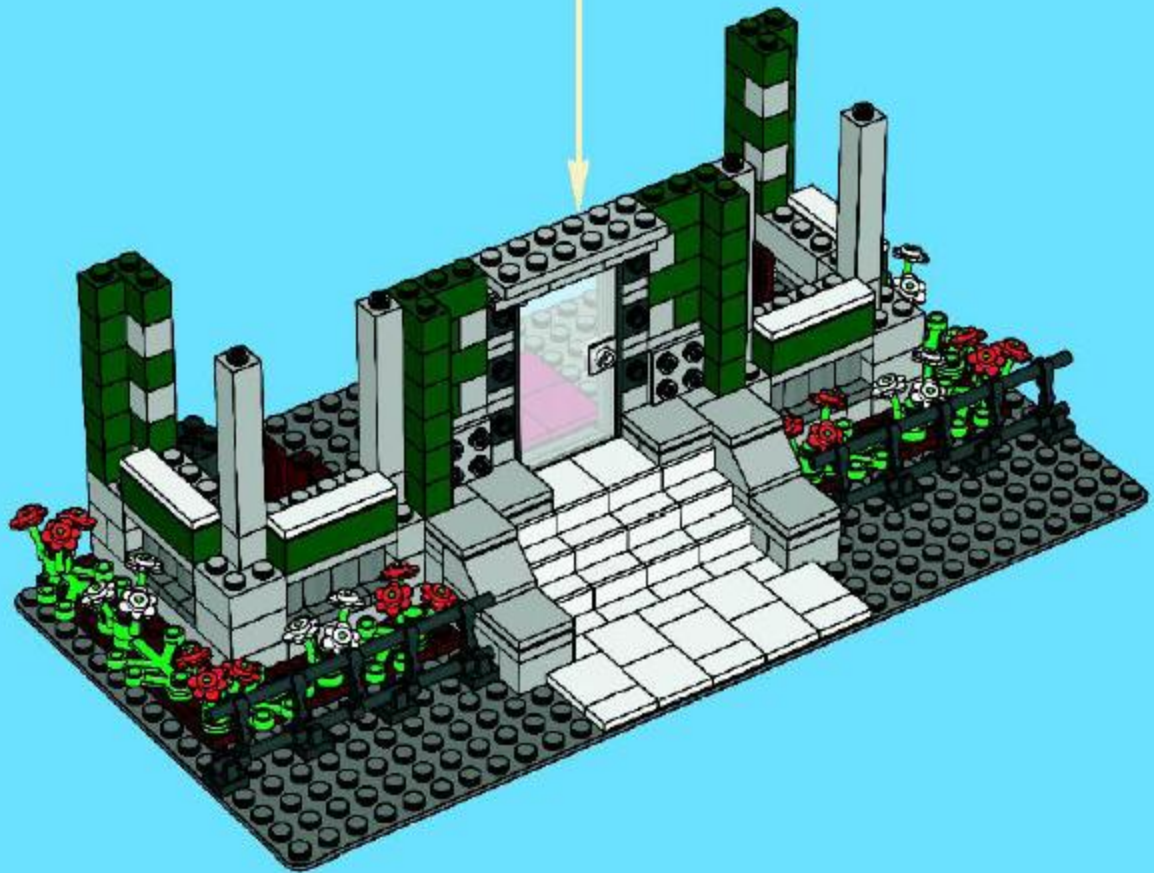
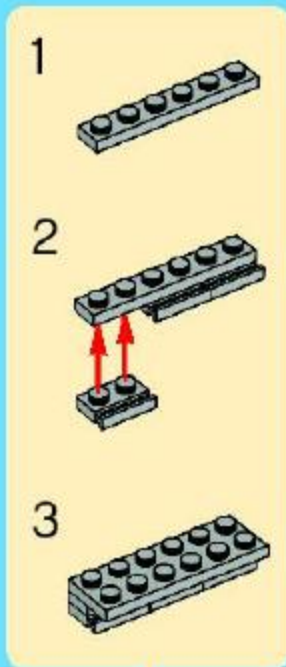



8x



16x

20

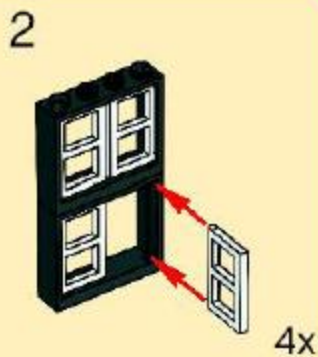
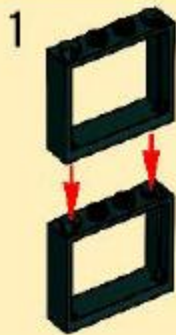

4x



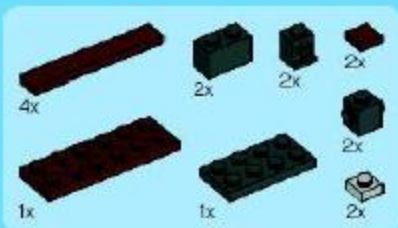

21

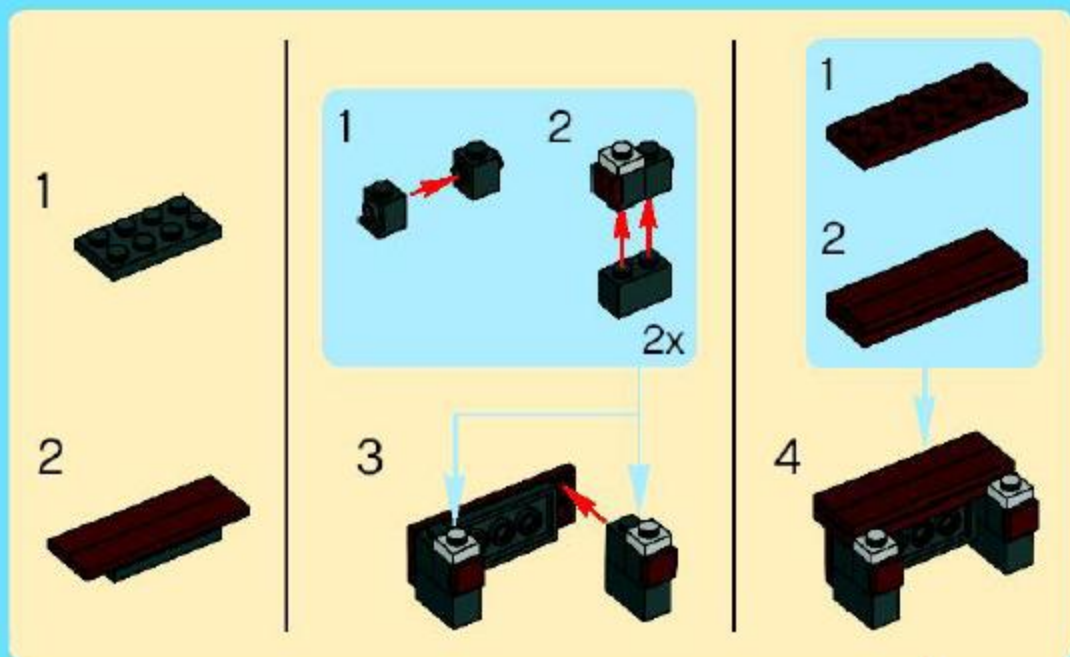

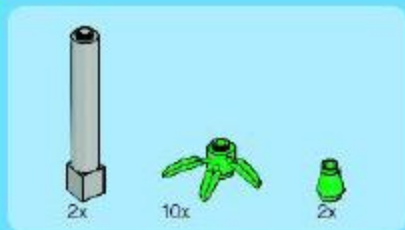

22

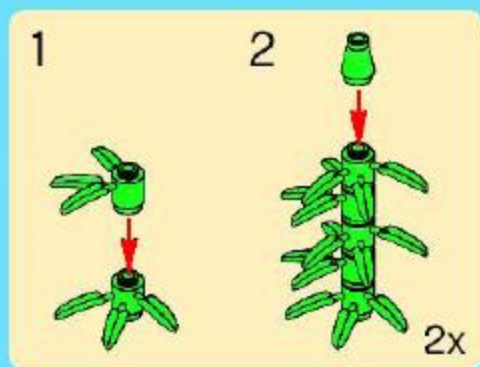

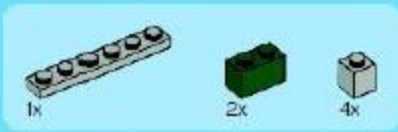

23

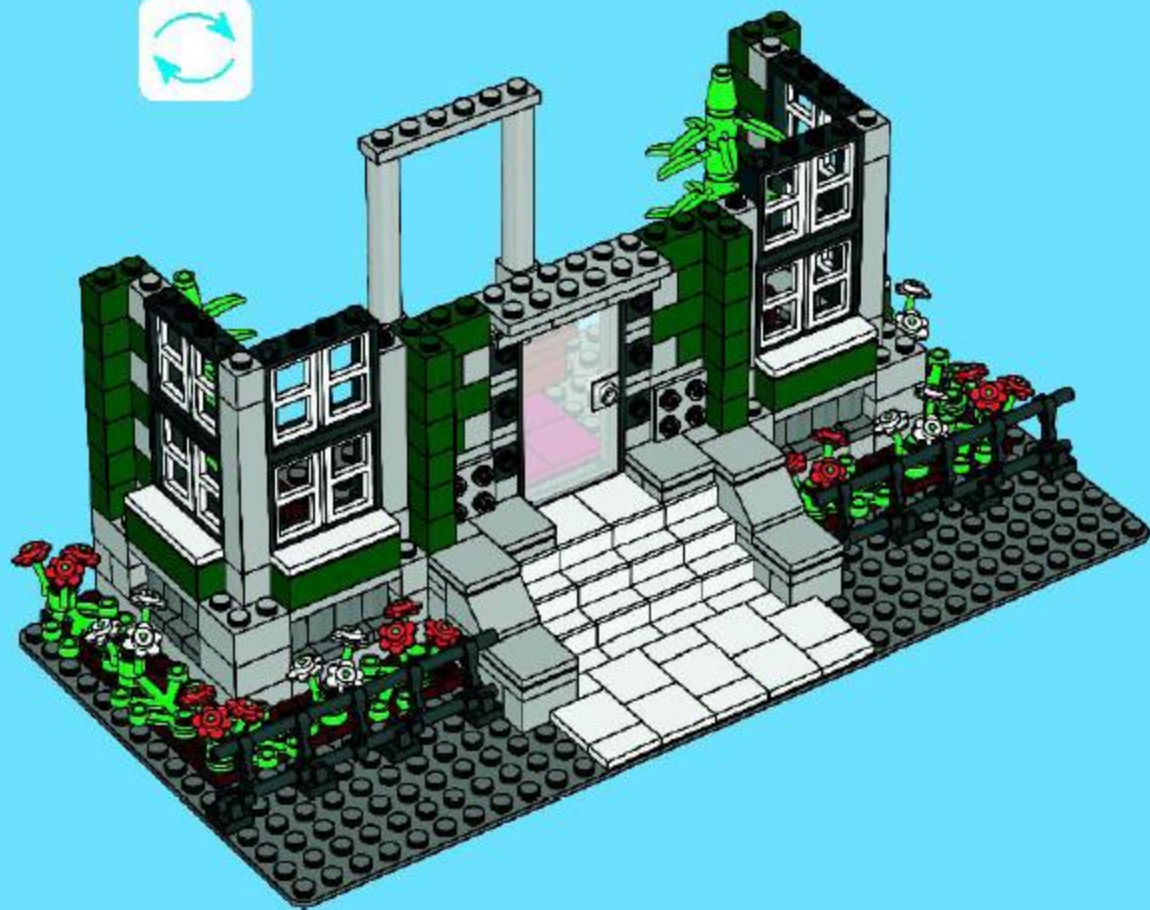



3x



2x



16x

# 24

1



2



2x

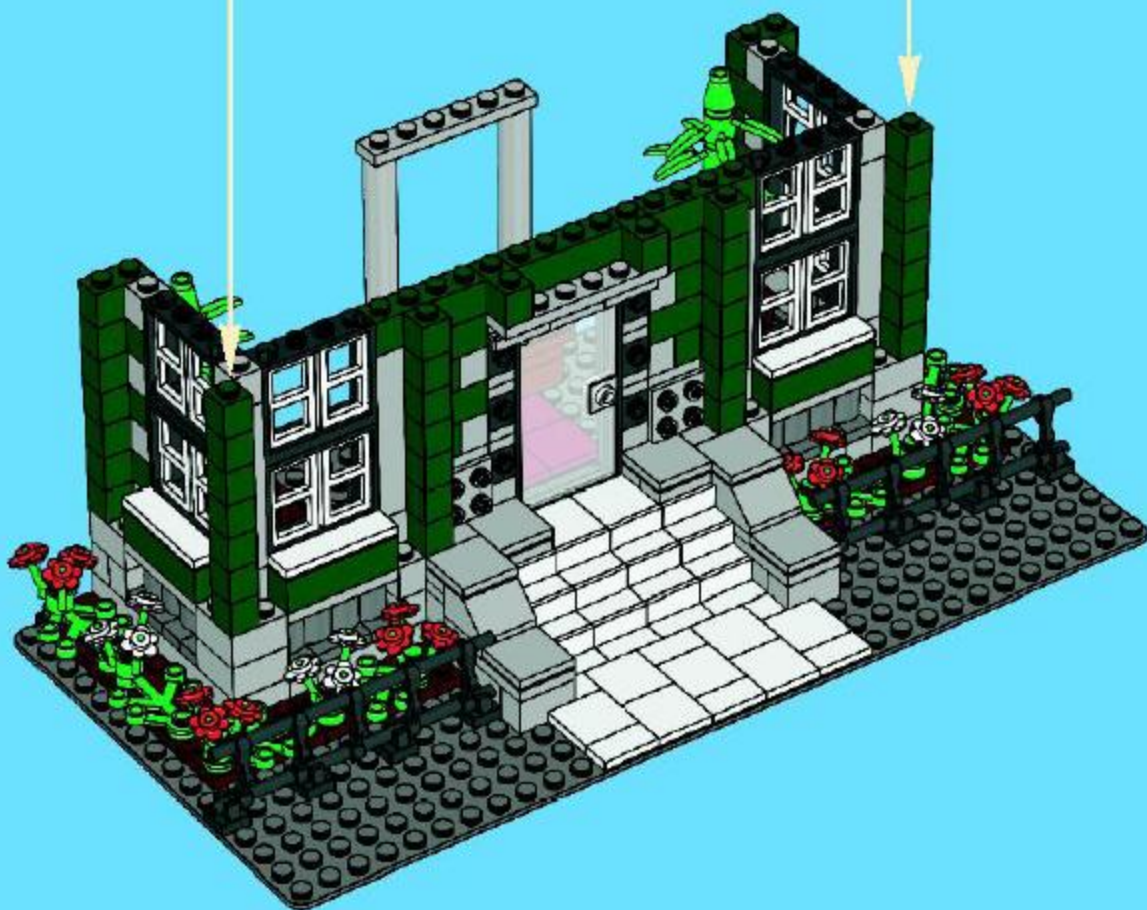



8x



8x

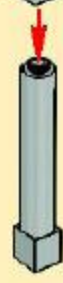

8x

# 25





6x



7x



2x

# 26







1x



6x



8x

27



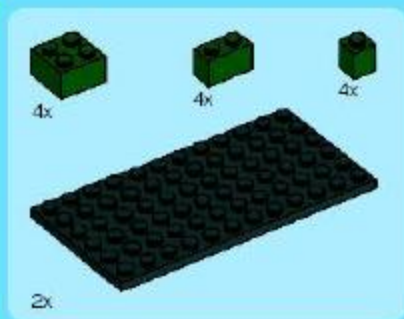

28



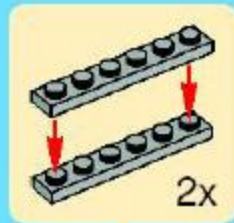
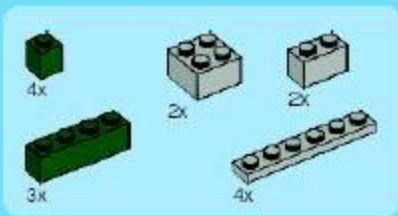

29



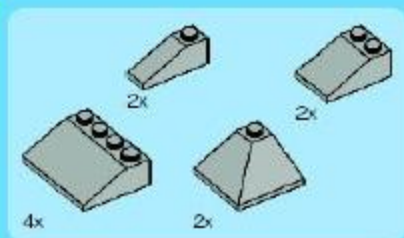

30



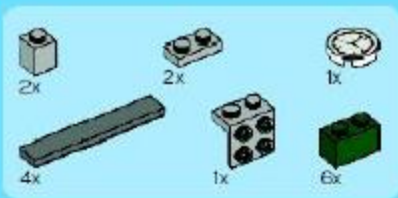

31

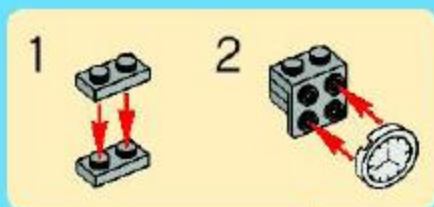

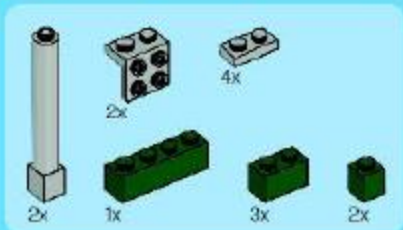

32

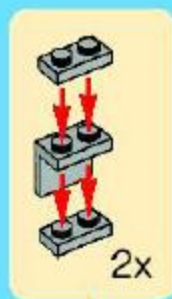



3x



4x



2x

# 33





34





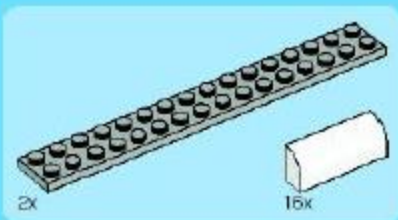

35

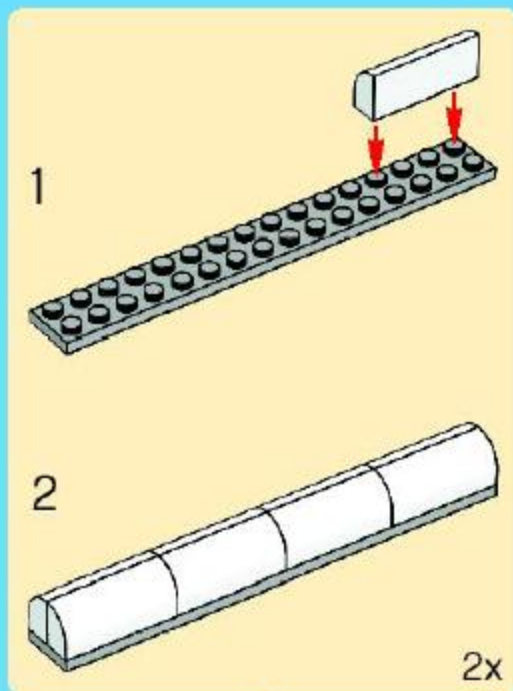

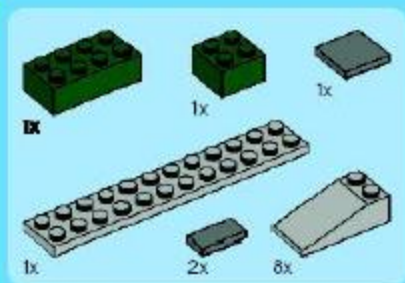

36

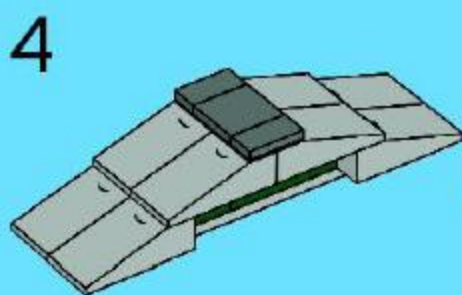
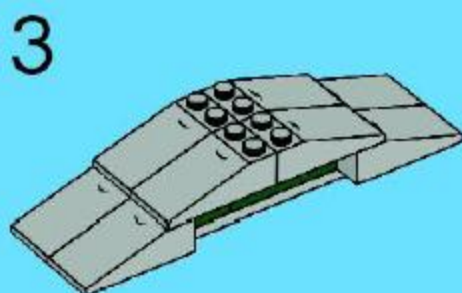
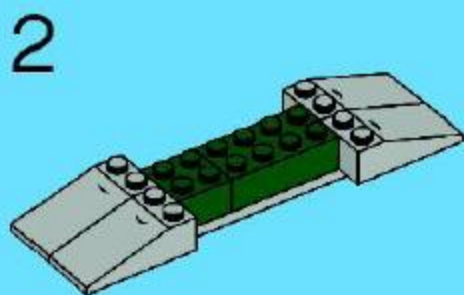
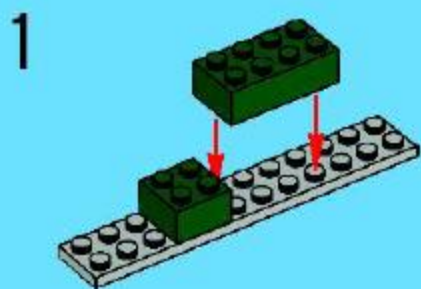



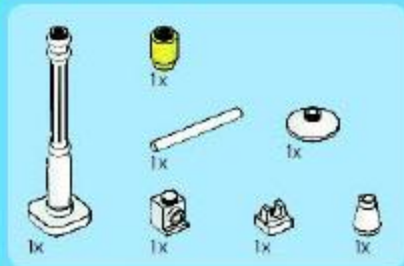

37

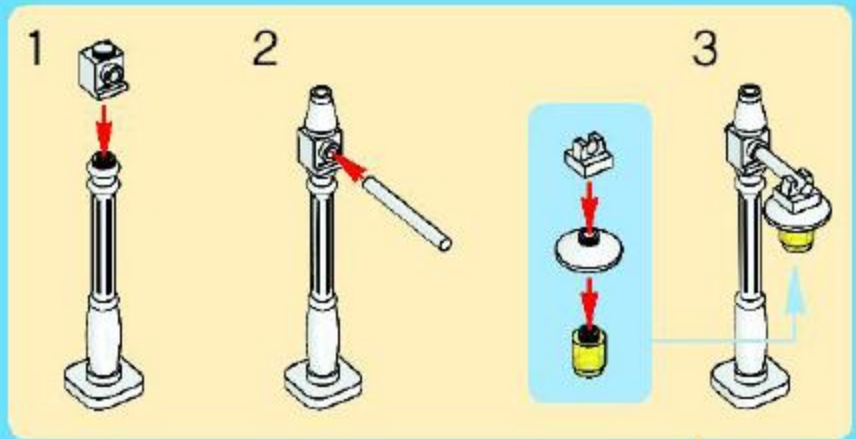

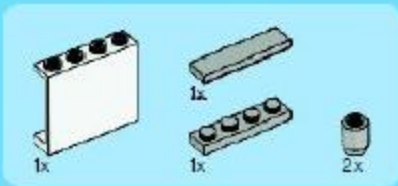

38

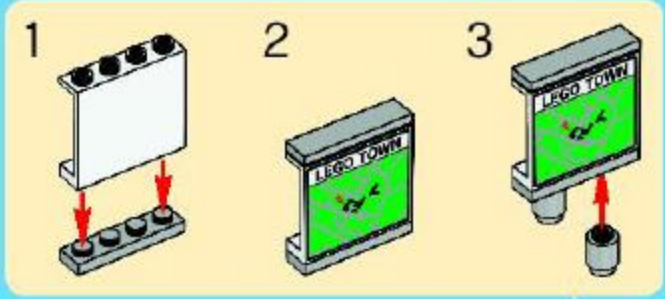

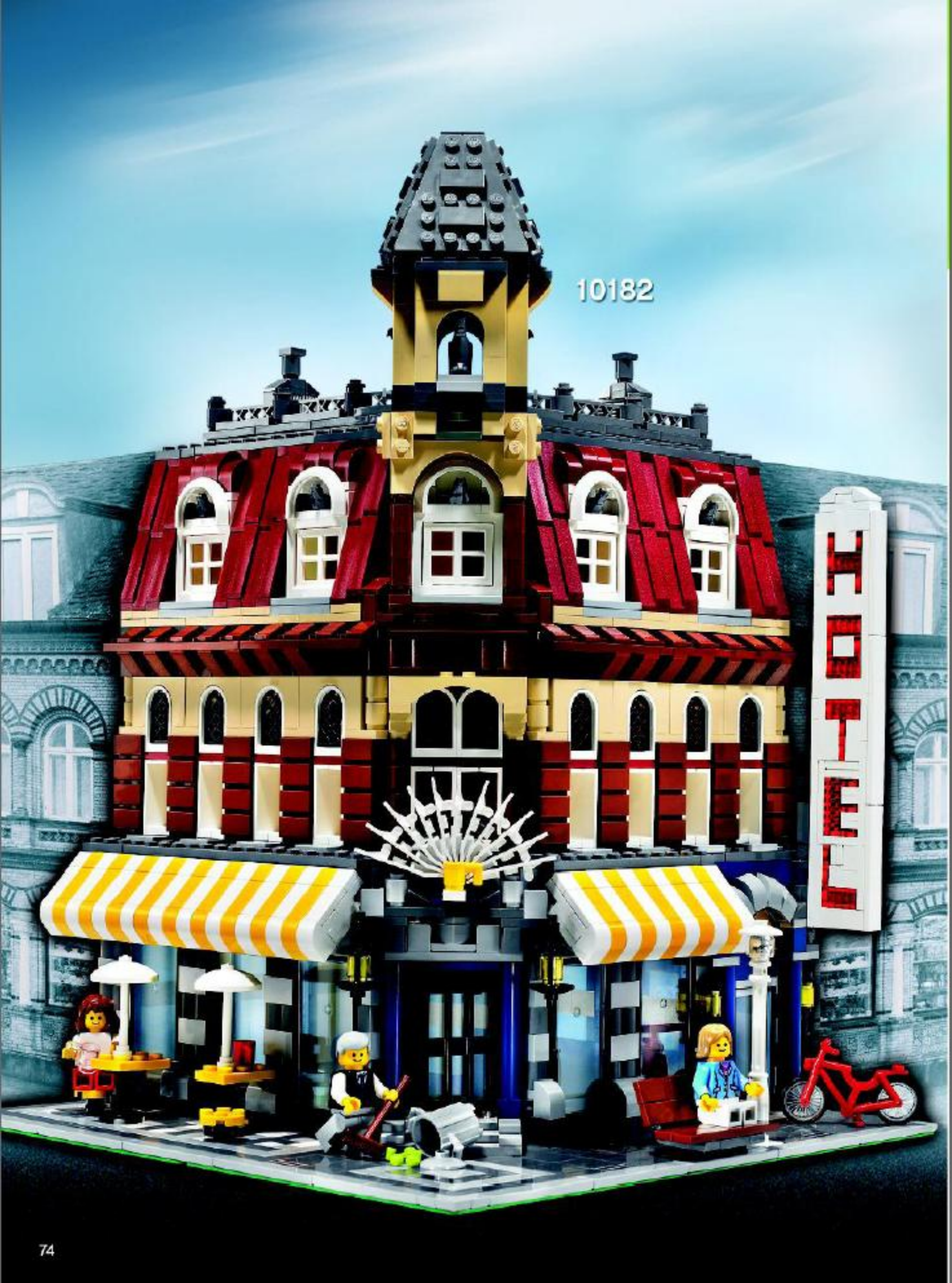

10182





## WIN LEGO® PRODUCTS

No purchase necessary.  
Open to residents of all countries where  
not prohibited.  
Go to [www.](http://www.) for official rules and details.

## WIN LEGO® PRODUCTEN

Kopen niet nodig.  
Open voor alle leeftijden, en in alle landen  
waar geen verbod geldt.  
Ga naar [www.](http://www.) voor officiële regels en details.

## GEWINNE LEGO® PRODUKTE

Die Teilnahme am Gewinnspiel führt zu  
keinerlei Kaufverpflichtungen.  
Sie können in allen nicht ausgeschlossenen  
Ländern teilnehmen.  
Die offiziellen Regeln und nähere Informationen  
finden Sie unter [www.](http://www.)

## GAGNE DES PRODUITS LEGO®

Aucun achat n'est nécessaire.  
Ouvert à tous les âges et aux résidents de  
tous les pays, sauf en cas d'interdiction.  
Rendez-vous sur [www.](http://www.) pour obtenir plus  
de détails et le règlement officiel.

## レゴ®製品を「当てよう」

購入は不要です  
禁止されていない限り、あらゆる  
年代およびあらゆる国の居住者の  
方々にご利用いただけます。  
公認規則および詳細につきましては、  
[www.](http://www.)をご覧ください

