

LAVA DRAGON



3838

LEGO



1



2

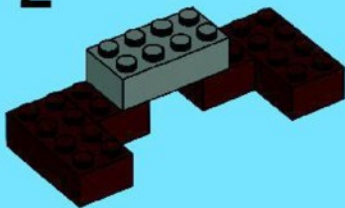

3

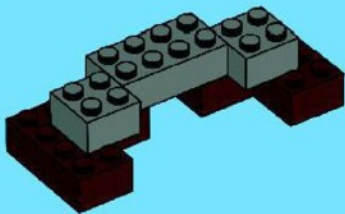

4

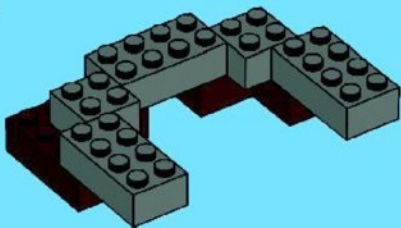

5

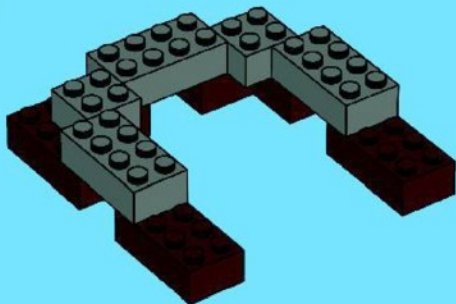

6

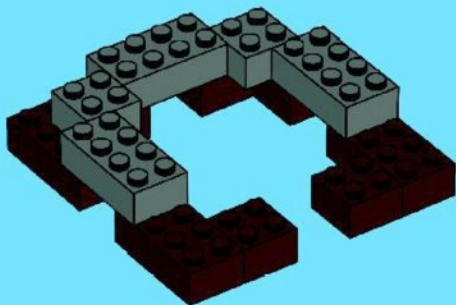

7

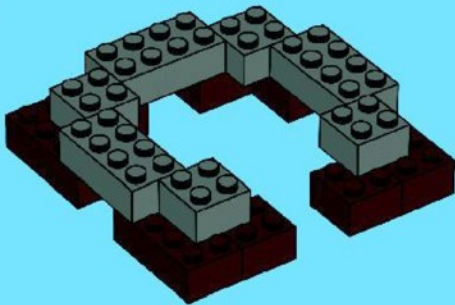

8

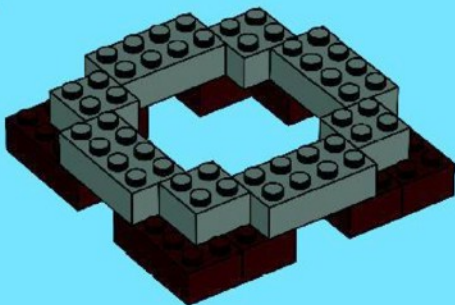

9

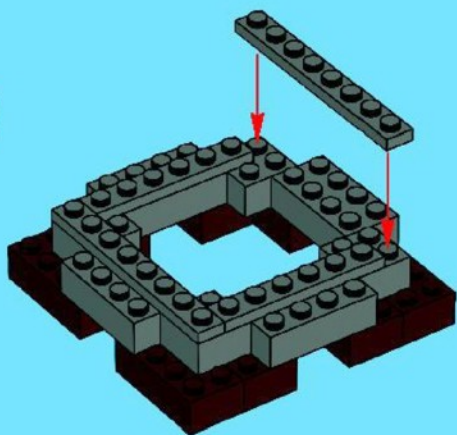

10

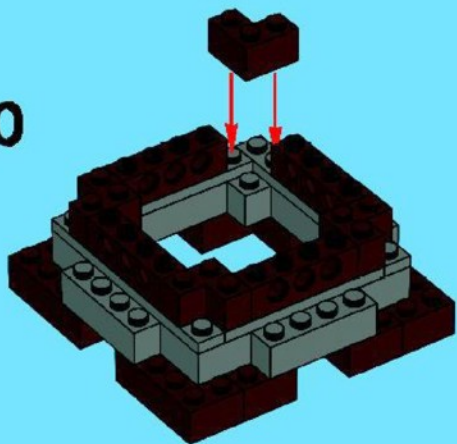

11

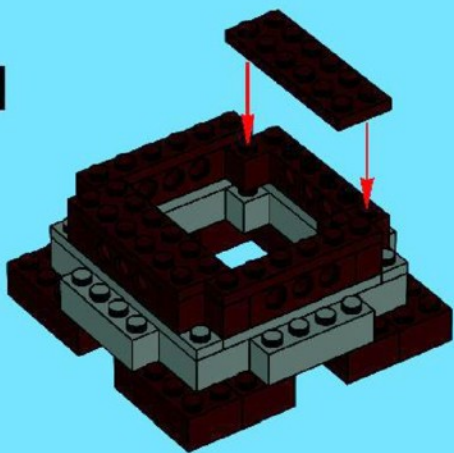



1

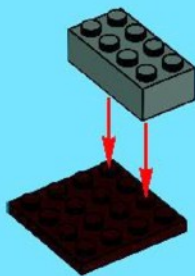

2

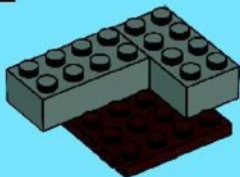

3

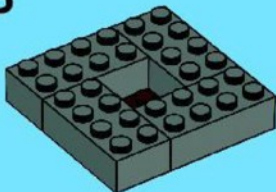

4

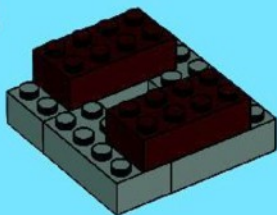

5

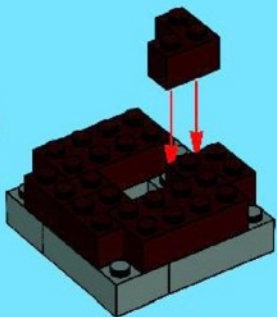

6

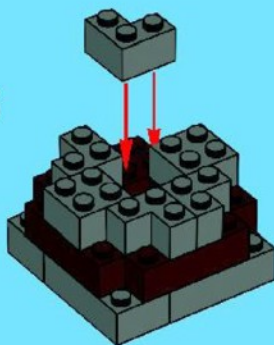

7

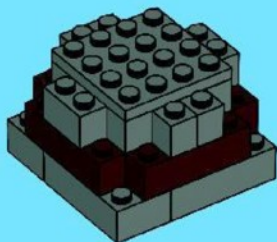

12

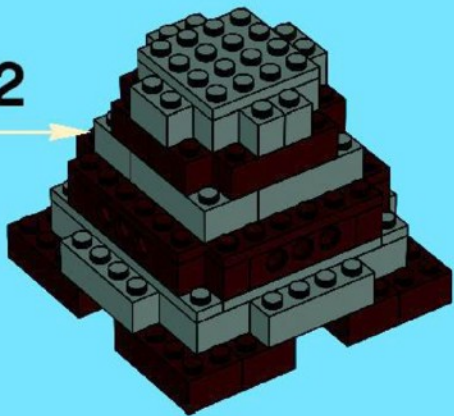

13

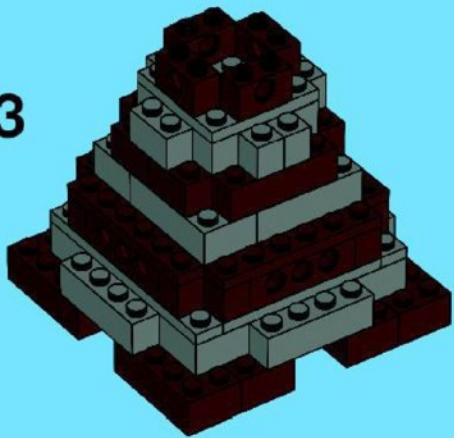

14

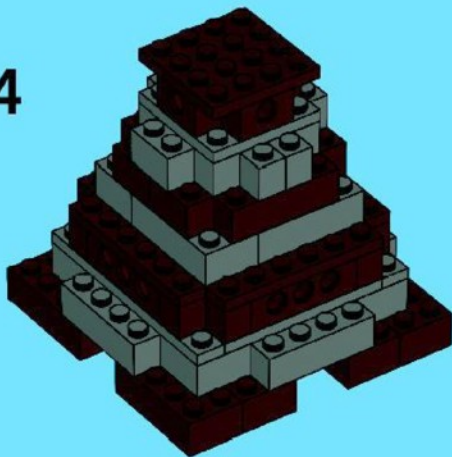

15

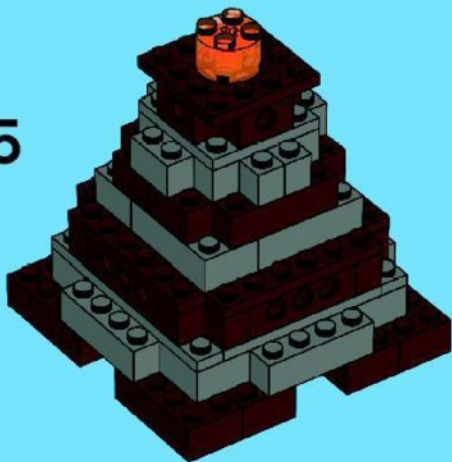

16



17



18

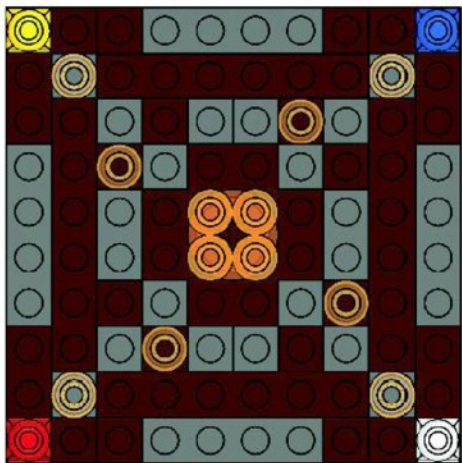

19

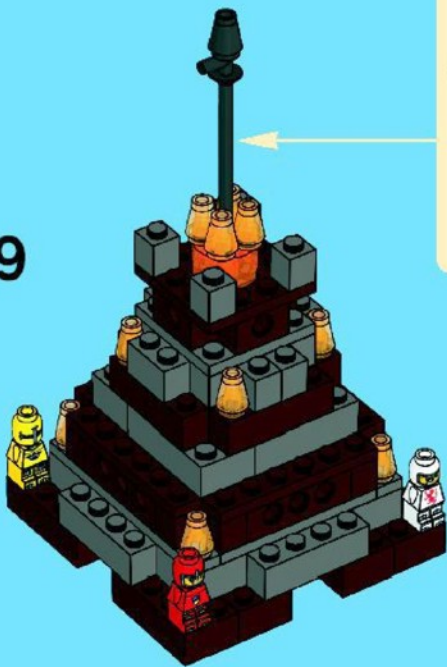



1



2

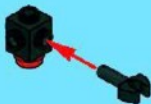

3



4



1



2

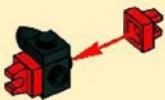

5



6



20

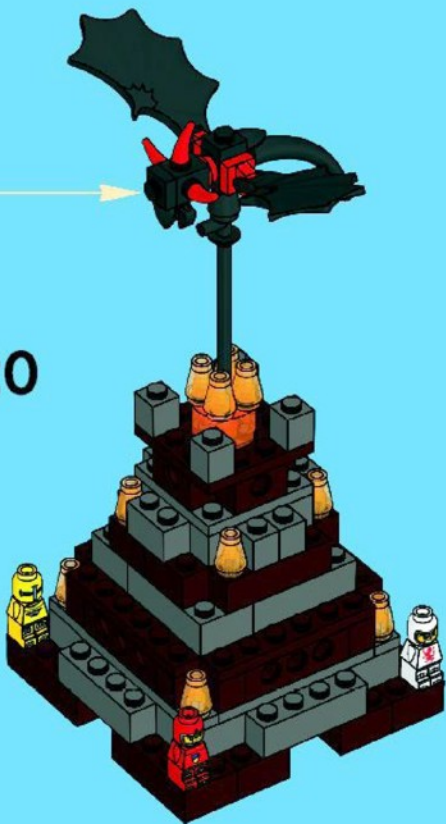

21

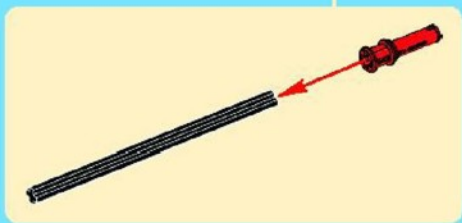

2x
4188771



4x
4211210

6x
4211201

8x
4211200

1x
4211151

2x
4221590

2x
4211247

2x
4243838

4x
4211252

4x
4267994

1x
4140806

9x
307021

3x
4276053

1x
4552302

2x
255521

1x
614121

1x
611647

9x
4206330

1x
4556006

9x
307024

1x
4556007

12x
4567338

2x
473328

2x
4277967

1x
384926

1x
4529236

2x
4273590

2x
400626

1x
4269538

1x
4508453

1x
373726

4x
421098

8x
4211085

4x
4211109

2x
4211056

2x
4210998

1x
4243831

6x
4211060

9x
307001

1x
4556005

1x
4539364



Customer Service
Kundenservice

Service Consommateurs
Servicio Al Consumidor

www.lego.com/service or dial

: 00800 5346 5555
: 1-800-422-5346

MINOTAURUS



3841
Minotaurus
 2-4 7+ 29.00



3838
Robo Champ
 2-3 8+ 19.95



3836
Magicians
 2-4 8+ 19.99



3837
Monsters 4
 2-4 7+ 15.99



3835
Lava Dragon
 2-4 7+ 19.99



3839
Race 3000
 2-4 7+ 29.99



3840
Pirates Cove
 2-4 8+ 19.99



3842
Lunar Command
 2 7+ 14.99



3843
Ramses Pyramid
 2-4 4+ 29.99



3844
Creationary
 2-6 7+ 29.99





FREE! GRATIS! GRATUIT!

LEGO club
MAGAZINE

www.LEGOclub.com



00800 5346 5555*        

  **1-866-534-6258 • 1-877-518-5346**

US & Canada only

Canada seulement

* Free phone. Mobile charges may apply. ** Numero sans Pécun. Des Prestations d'appeler dans les téléphones cellulaires.
* Gratuit partout, partout. Les tarifs des téléphones cellulaires peuvent varier. ** Coste de telefonata in telefoni cellulari.
* Des n° et de grands numéros, sans de payer les frais cellulaires. ** Pour le gratis, rendre payer plus de Post. Charges.



VISIT THE WORLD'S
BIGGEST LEGO® SHOP!

www.LEGOshop.com



WIN LEGO® PRODUCTS

Fill out a survey and you might WIN a cool LEGO product!
NO PURCHASE NECESSARY
Open to all residents where not prohibited
Go to www.nielsen aim.dk/LEGO to fill out a survey for a chance to win a LEGO product.

WIN LEGO® PRODUCTEN

Vul een enquêteformulier in en maak kans op een cool LEGO® product!
Kopen niet nodig
Iedereen in UK landen waar geen enquêteverbod geldt mag deelnemen.
Ga naar www.nielsen aim.dk/LEGO, vul een enquêteformulier in en maak kans op een LEGO product.

GEWINNE LEGO® PRODUKTE

Nimm an der Umfrage teil und GEWINNE ein tolles LEGO® Produkt!
Die Teilnahme am Gewinnspiel führt zu keinerlei Kaufverpflichtungen
Teilnahme in allen nicht ausgeschlossenen Ländern möglich
Wir verlosen unter allen Teilnehmern der Umfrage auf www.nielsen aim.dk/LEGO LEGO Produkte.

GAGNE DES PRODUITS LEGO®

Répondez à un questionnaire et tu pourrais GAGNER un produit LEGO® très cool !
Aucune obligation d'achat.
Ouvert à tous les résidents des pays autorisés.
Visite www.nielsen aim.dk/LEGO pour répondre à un questionnaire et avoir une chance de gagner un produit LEGO.

レゴ®製品を「当てよう」

アンケートに記入して、カッコいいレゴ®製品を当てよう！
お買い上げの必要はありません。
禁止されていない限り、すべての皆様にご利用いただけます。
www.nielsen aim.dk/LEGOにアクセスして、アンケートにご記入ください。当選者にはレゴ製品を差し上げます。



LAVA DRAGON



2-4



7+



15 - 25



- Reglas de juego



- Regras



- Règles



- Rules





¡Una nueva forma de jugar!

Llega LEGO® Games, la primera colección de juegos del mundo que puedes construir, jugar y cambiar. Gracias al exclusivo Dado LEGO, que podrás construir a tu gusto, y a sus reglas, totalmente modificables, LEGO Games representa una nueva forma de divertirse con la familia y los amigos.



Uma nova forma de jogar! Apresentamos os LEGO® Games, a primeira coleção de jogos para construir, jogar e modificar. Com o exclusivo Dado LEGO para construir e regras de jogo modificáveis, os LEGO Games são uma nova forma de te divertires com a família ou amigos.



Jouer autrement Découvrez les jeux de société LEGO® : les premiers jeux de société à construire ! Avec le dé LEGO à construire et les règles du jeu modifiables selon les envies des joueurs, les jeux de société LEGO promettent des heures de divertissement en famille ou entre amis.



A new way to play! Introducing LEGO® Games, the world's first collection of games that you build, play and change. With the unique buildable LEGO Dice and changeable rules, LEGO Games is a new way of having fun together with family and friends.



CONSTRUYE



Demuestra que eres el caballero más valiente de todos siendo el primero en invocar al dragón que vive en la cima del volcán.

Evita la lava y bloquea a tus oponentes durante tu ascenso hacia la victoria.

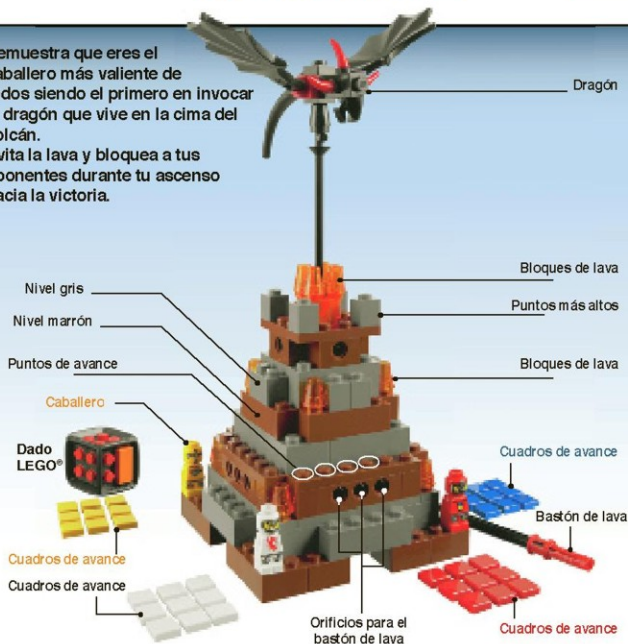

Objetivo del juego

Ganará el primer caballero en alcanzar la cima del volcán e invocar al dragón de lava.

Preparativos

Antes de comenzar a jugar, construye el juego usando las instrucciones de construcción LEGO® que se incluyen con el set. Construir el juego te permitirá familiarizarte con las piezas y el modo de usarlas.

Haciéndolo, encontrarás más sencillo reconstruirlo o cambiar las reglas del juego para otra partida.



Construye el Dado LEGO colocando las dos cubiertas de lava de color naranja sobre dos caras opuestas.

Este set incluye una herramienta que te ayudará a quitar los cuadros del Dado LEGO.

Antes de comenzar una partida nueva, organiza el juego como se indica en la imagen anterior o en la ilustración que encontrarás en la última página de las instrucciones de construcción.

Comenzando por el jugador más joven, cada jugador elige un caballero y toma los nueve cuadros de avance del color correspondiente al caballero elegido. A continuación, coloca uno de sus cuadros de avance en el Dado LEGO, junto a una cubierta de lava de color naranja.



JUEGA

Desarrollo del juego

Comienza el jugador más joven. El turno pasa a partir de entonces de un jugador a otro en el sentido de las agujas del reloj.

Al llegar su turno, el jugador correspondiente lanza el Dado LEGO® y realiza las siguientes acciones:



Caras sin cuadros de avance

- 1) Coloca uno de tus cuadros de avance en la cara del Dado LEGO que has obtenido al lanzarlo, **Y**
- 2) Mueve tu caballero un punto sobre el volcán. Puedes elegir entre mover tu caballero o no hacerlo.



Caras con cuadros de avance

- 1) Coloca uno de tus cuadros de avance en la cara del Dado LEGO que has obtenido al lanzarlo si aún hay espacio y si aún te quedan cuadros de avance, **Y**
- 2) Todos los jugadores cuyos cuadros de avance se encuentren en la cara del Dado LEGO que han obtenido al lanzarlo pueden mover sus caballeros. Comenzando por el jugador que ha lanzado y continuando en sentido horario, los jugadores mueven su caballero un punto por cada cuadro de avance que se haya colocado en la cara obtenida en el Dado LEGO al lanzarlo.

Los caballeros no pueden permanecer sobre otros caballeros ni pasar por encima de ellos.



Caras con una cubierta de lava de color naranja

Coloca un bloque de lava en cualquier punto del volcán para bloquear el avance de otro jugador. Una vez colocado el bloque de lava, comenzando por el jugador que ha lanzado y continuando en sentido horario, los jugadores mueven su caballero un punto por cada cuadro de avance que se haya colocado en la cara obtenida del Dado LEGO.

Los caballeros no pueden permanecer sobre los bloques de lava ni pasar por encima de ellos.

Ejemplos de la función de los cuadros de avance cuando el jugador rojo ha lanzado el Dado LEGO y ha colocado un cuadro de avance de color rojo en él:



El jugador rojo avanza un punto.



El jugador rojo coloca un bloque de lava y, a continuación, avanza un punto. Después, el jugador azul avanza un punto.



El jugador rojo avanza dos puntos.



El jugador rojo avanza dos puntos. A continuación, los jugadores azul y amarillo avanzan un punto cada uno.

Movimiento de los caballeros por el volcán



Cada cuadro de avance permite a un jugador mover su caballero un punto en dirección horizontal por el mismo nivel del volcán. Escalar un nivel, es decir, pasar de un nivel marrón a un nivel gris o de un nivel gris a un nivel marrón. Los caballeros sólo pueden escalar un nivel por cuadro de avance.



Un ● = 1 punto
Los caballeros no pueden moverse en dirección diagonal.

Ganar el juego

El primer jugador en obtener una cubierta de lava de color naranja al lanzar mientras su caballero se encuentra en uno de los puntos más altos del volcán, ganará el juego. ¡El jugador ganador colocará su caballero en el dragón de lava y partirá volando victorioso!

Si el jugador que se encuentra en el punto más alto no obtiene una cubierta de lava de color naranja al lanzar, el juego continúa y los demás jugadores siguen escalando de acuerdo con las reglas descritas anteriormente.



TU JUEGO, TUS REGLAS

El Dado LEGO® te ofrece la libertad de cambiar el juego a tu gusto. Puedes cambiar el área de juego, las piezas e incluso las reglas. Los cambios que hagas harán el juego cada vez más TUYO.

El secreto para hacer bien los cambios es cambiar sólo una cosa cada vez. Así podrás comprobar si el cambio hace el juego más divertido. Si es así, conserva el cambio y prueba con otro.

Cambiar un juego siempre es más divertido si se hace en compañía. Así, todos conocerán las reglas y sabrán qué ha cambiado. Recuerda asegurarte de que todo aquel que juegue conozca las reglas nuevas **ANTES** de empezar a jugar.

Ahora que sabes cómo jugar usando nuestras reglas, prueba alguna de las sugerencias que te ofrecemos a continuación para cambiar el juego y, después, trata de hacer un cambio tú solo.



1) Explosión volcánica

Los jugadores pueden elegir ahora entre dos opciones si obtienen una cubierta de color naranja al lanzar:

- Colocar un bloque de lava en cualquier punto del volcán para bloquear el avance de otro jugador,
- Usar el bastón de lava para atravesar el volcán y hacer caer a un caballero del volcán.

El caballero debe **VOLVER** al punto inicial desde el que comenzó a jugar.



Después de usar el bastón de lava o colocar un bloque de lava, comenzando por el jugador que ha lanzado y continuando en sentido horario, los jugadores mueven su caballero un punto por cada cuadro de avance que se haya colocado en la cara obtenida del Dado LEGO.



2) Cuerda de escalada

Añade una cubierta de color marrón a una de las caras del Dado LEGO.

El jugador que lance y obtenga un cuadro de color marrón podrá ascender uno o más niveles con su caballero sobre una cara lisa del volcán si existe espacio disponible para escalar.

Las flechas amarillas que se muestran en la ilustración de la derecha indican cómo se puede usar la cuerda de escalada para ascender con el caballero dos o más niveles sobre las caras lisas del volcán.

Una vez usada la cuerda de escalada, comenzando por el jugador que ha lanzado y continuando en sentido horario, los jugadores mueven su caballero un punto por cada cuadro de avance que se haya colocado en la cara obtenida del Dado LEGO.

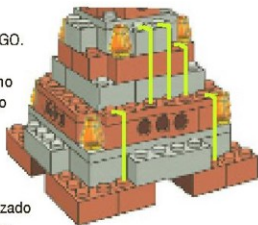

Inventa y comparte tus propias reglas

Inventa tus propias reglas y compártelas con tus amigos. Pon a prueba a tus amigos creando las reglas más originales. Construye, juega y cambia para una mayor diversión.



Consejo de LEGO®
La mejor forma de recoger tus piezas LEGO es inclinarlas antes de tomarlas.



CONSTRUIR

Prova que és o cavaleiro mais valente de todos, sendo o primeiro a chegar ao cimo do vulcão e a invocar o dragão. Evita a lava e bloqueia os teus adversários na escalada para a vitória.

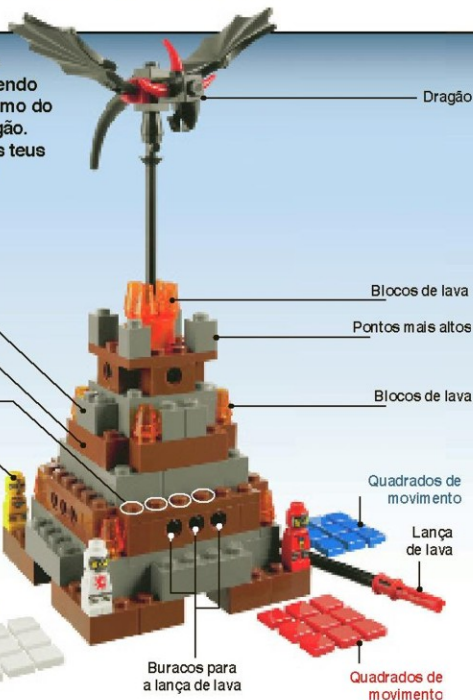

Objectivo do jogo

O primeiro cavaleiro a chegar ao topo do vulcão e a invocar o dragão ganha o jogo.

Preparação para o jogo

Antes de começares a jogar, constrói o jogo com o auxílio das instruções de construção LEGO® fornecidas. Construir o jogo permite uma familiarização com as suas peças e modo de utilização. Isto torna mais fácil reconstruir ou mudar posteriormente as regras do jogo.

Constrói o Dado LEGO colocando as duas peças cor-de-laranja em lados opostos.



A embalagem inclui uma ferramenta para ajudar a remover as peças que compõem as faces do Dado LEGO

Antes do início de cada partida, dispõe as peças no tabuleiro de jogo de forma a chizerem com a foto acima mostrada ou com a foto da última página das instruções de construção.

Começando pelo jogador mais novo, cada jogador selecciona um cavaleiro e pega nos nove quadrados de movimento da cor correspondente, e de seguida coloca um quadrado de movimento no Dado LEGO junto a uma peça de lava cor-de-laranja.



Regras do jogo

O jogo começa pelo jogador mais novo e prossegue no sentido dos ponteiros do relógio.

Quando chega a sua vez, cada jogador lança o Dado LEGO® e realiza uma das acções seguintes, de acordo com o resultado obtido:



Faces do dado sem quadrados de movimento

- 1) Coloca um dos teus quadrados de movimento sobre a face superior do Dado LEGO acabado de ser lançado **E**
- 2) Move o teu cavaleiro uma casa sobre o vulcão. Podes decidir se moves ou não o teu cavaleiro.



Faces com quadrados de movimento

- 1) Coloca um dos teus quadrados de movimento na face superior do Dado LEGO que foi lançado se tiveres espaço suficiente e se ainda tiveres quadrados de movimento de sobra, **E**
- 2) Todos os jogadores que tenham quadrados de movimento na face superior do Dado LEGO lançado podem mover os seus cavaleiros. Começando pelo jogador que lançou o dado e prosseguindo no sentido dos ponteiros do relógio, os jogadores movem o seu cavaleiro uma casa por cada quadrado de movimento indicado na face superior do Dado LEGO.

Os cavaleiros não podem parar em cima de outros cavaleiros ou saltar por cima deles.



Faces com uma peça de vulcão laranja

Move um bloco de lava para qualquer casa no vulcão, de forma a bloqueares os outros jogadores.

Logo que o bloco de lava esteja colocado, começando pelo jogador que lançou o dado e prosseguindo no sentido dos ponteiros do relógio, os jogadores movem o seu cavaleiro uma casa por cada quadrado de movimento indicado na face superior do Dado LEGO.

Os cavaleiros não podem parar em cima de blocos de lava ou saltar por cima deles.

Exemplos de funcionamento dos quadrados de movimento quando o jogador vermelho, após lançamento do dado, acrescentou um quadrado de movimento vermelho ao Dado LEGO.



O jogador vermelho move uma casa



O jogador vermelho coloca um bloco de lava e move uma casa. Em seguida o jogador azul move uma casa.



O jogador vermelho move duas casas



O jogador vermelho move duas casas, e os jogadores azul e amarelo movem cada um uma casa.

Movimento dos cavaleiros sobre o vulcão



Cada quadrado de movimento permite ao jogador mover o seu cavaleiro uma casa horizontal no mesmo nível do vulcão, **OU** escalar um nível do vulcão, por exemplo, mover de um nível castanho para um nível cinzento ou de um nível cinzento para um castanho. Os cavaleiros só podem subir um nível por quadrado.



Um ● = 1 casa
Os cavaleiros não se podem mover na diagonal.

O vencedor do jogo

O primeiro jogador que obtenha no dado uma peça de vulcão laranja quando o seu cavaleiro estiver num dos pontos altos do vulcão, ganha o jogo. O cavaleiro monta o dragão de lava e voa, triunfante, para longe.

Se o jogador situado no ponto mais alto não obtiver uma peça de vulcão laranja ao lançar o dado, o jogo continua com os outros jogadores a escalar, de acordo com as regras acima mencionadas.



Remover a peça LEGO

A melhor forma para retirar as peças do tabuleiro é incliná-las antes de serem puxadas.



VARIAR

O TEU JOGO – AS TUAS REGRAS

O Dado LEGO® dá-te a possibilidade de modificares o jogo e personalizá-lo. Podes alterar a área de jogo, as peças e mesmo as regras. Cada pequena alteração dá um toque mais pessoal ao TEU jogo.

O segredo para alterar um jogo é alterar uma coisa de cada vez. Assim, podes verificar se essa alteração torna o jogo mais divertido. Se isso acontecer, mantém-na e experimenta outra.

Alterar um jogo é sempre mais divertido quando é feito em grupo. Deste modo, todos conhecem as regras e sabem o que foi alterado. Assegura-te de que todos os jogadores conhecem as novas regras **ANTES** de começarem a jogar.

Agora que já conheces as regras de base, experimenta uma das seguintes sugestões de regras para variar o jogo. Depois tenta criar as tuas próprias regras.



1) Erupção vulcânica

Os jogadores têm duas opções quando obtêm a face cor-de-laranja no lançamento do dado:

- Podem mover um bloco de lava para qualquer lado no vulcão e bloquear os outros jogadores, **OU**
- Usar a lança de lava, empurrando um cavaleiro adversário para fora do vulcão.

O cavaleiro REGRESSA à sua posição inicial no jogo.



Logo que a lança de lava ou o bloco de lava tenham sido usados, começando pelo jogador que lançou o dado e prosseguindo no sentido dos ponteiros do relógio, os jogadores movem o seu cavaleiro uma casa por cada quadrado de movimento indicado na face superior do Dado LEGO.



2) Corda de escalada

Acrescenta uma peça castanha a um lado do Dado LEGO.

Quando no lançamento do dado for obtida uma face castanha, o jogador pode fazer o seu cavaleiro subir um ou mais níveis num lado liso do vulcão, desde que haja espaço livre para a subida.

As setas amarelas na imagem à direita indicam por onde a corda de escalada leva o cavaleiro, ao subir um ou mais níveis pela parede lisa. Logo que a corda de escalada tenha sido usada, começando pelo jogador que lançou o dado e prosseguindo no sentido dos ponteiros do relógio, os jogadores movem o seu cavaleiro uma casa por cada quadrado de movimento indicado na face superior do Dado LEGO.

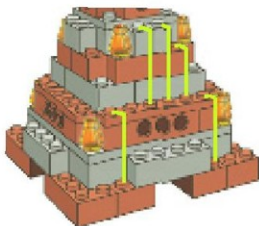

Inventa e partilha as tuas regras

Testa a tua imaginação. Inventa as tuas regras e partilha-as com os amigos. Põe os teus amigos à prova, criando as regras mais originais. Constrói, joga e altera as regras para uma maior diversão.

CONSTRUIRE



Prouvez que vous êtes le plus courageux des chevaliers en arrivant avant les autres au sommet du volcan pour chevaucher le dragon de lave !

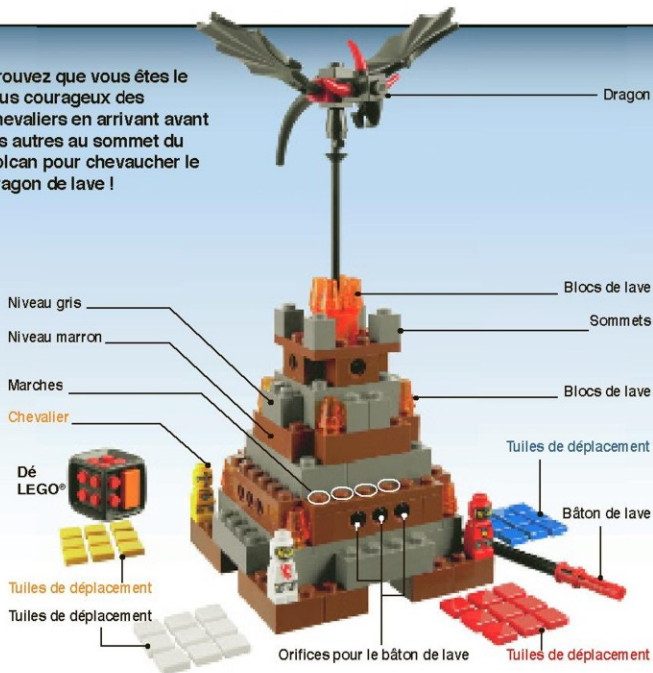

But du jeu

Le premier chevalier qui parvient au sommet du volcan et chevauche le dragon de lave remporte la partie.

Préparation

Avant de commencer à jouer, construisez le jeu selon la notice de montage LEGO® fournie. Cette première étape de construction vous familiarisera avec les pièces du jeu et leur utilisation. Il vous sera ainsi plus facile de reconstruire le jeu ou d'en modifier les règles par la suite.

Avant chaque nouvelle partie, remettez les pièces en place comme sur l'image figurant ci-dessus ou celle figurant à la dernière page de la notice de montage.

Assemblez le dé LEGO en plaçant les deux tuiles de lave orange sur des faces opposées.



Cette boîte contient un outil facilitant le démontage du dé LEGO.

Chaque joueur, en commençant par le plus jeune, choisit un chevalier et prend les 9 tuiles de déplacement de la couleur correspondante, puis place une tuile de déplacement sur le dé LEGO à côté d'une tuile de lave orange.



JOUER

Déroulement de la partie

Le joueur le plus jeune commence. La partie continue dans le sens des aiguilles d'une montre.

Quand vient son tour, le joueur lance le dé LEGO® et exécute une des actions suivantes selon le résultat obtenu :

Faces sans tuiles de déplacement

- 1) Placez une de vos tuiles de déplacement sur la face supérieure du dé LEGO **ET**
- 2) Déplacez votre chevalier d'une case sur le volcan. Vous pouvez choisir de déplacer votre chevalier ou non.

Faces avec tuiles de déplacement

- 1) Placez une de vos tuiles de déplacement sur la face supérieure du dé LEGO, s'il reste de la place sur cette face et qu'il vous reste des tuiles de déplacement **ET**
- 2) Tous les joueurs ayant des tuiles de déplacement sur la face supérieure du dé peuvent déplacer leur chevalier. Le joueur qui a lancé le dé commence ; les autres joueurs concernés suivent dans le sens des aiguilles d'une montre, déplaçant leur chevalier d'une case par tuile de déplacement visible sur la face du dé LEGO obtenue.

Un chevalier ne peut ni s'arrêter sur un chevalier adverse, ni passer par dessus.

Faces avec une tuile de lave orange

Déplacez un bloc de lave où vous le voulez sur le volcan pour essayer de bloquer les autres joueurs.

Une fois le bloc de lave placé, chaque joueur, en commençant par celui qui a lancé le dé et en poursuivant dans le sens des aiguilles d'une montre, déplace son chevalier d'une case par tuile de déplacement visible sur la face du dé LEGO obtenue.

Un chevalier ne peut ni s'arrêter sur un bloc de lave, ni passer par dessus.

Exemples de fonctionnement des tuiles de déplacement lorsque le joueur rouge, après avoir lancé le dé, a ajouté une tuile de déplacement rouge sur la face supérieure du dé :



Le joueur rouge se déplace d'une case



Le joueur rouge place un bloc de lave puis se déplace d'une case. Le joueur bleu se déplace ensuite d'une case.



Le joueur rouge se déplace de deux cases



Le joueur rouge se déplace de deux cases, puis les joueurs bleu et jaune se déplacent d'une case chacun.

Déplacement des chevaliers sur le volcan

Chaque tuile de déplacement permet à un joueur de déplacer son chevalier d'une case horizontalement sur le même niveau du volcan **OU** de grimper d'un niveau sur le volcan, par exemple d'un niveau marron vers un niveau gris ou d'un niveau gris vers un niveau marron. Un chevalier ne peut grimper que d'un niveau par tuile de déplacement.



Un ● = 1 case
Les chevaliers ne peuvent pas se déplacer en diagonale.

Fin de la partie

Le premier joueur dont le dé tombe sur une tuile de lave orange alors que son chevalier se trouve sur l'un des sommets du volcan gagne la partie. Le vainqueur place son chevalier sur le dragon de lave et devient le maître du dragon !

Si le joueur parvenu au sommet n'obtient pas de tuile de lave orange à son lancer de dé, les autres joueurs continuent la partie selon les mêmes règles.



Astuce LEGO

La meilleure façon de retirer des pièces LEGO du plateau de jeu consiste à les incliner au lieu de tirer dessus verticalement.



VARIANTES – TON JEU, TES RÈGLES

Le dé LEGO® vous permet de modifier le jeu selon vos envies. Vous pouvez changer l'environnement du jeu, les pièces et même les règles. Chaque changement donne une touche plus personnelle à VOTRE jeu.

Le secret est de ne changer qu'un seul élément à la fois. De cette façon, vous pouvez voir si la modification apportée rend la partie plus amusante. Si c'est le cas, conservez ce changement et essayez-en un autre.

Modifier un jeu est toujours plus amusant en groupe. Chacun connaît ainsi les règles et sait ce qui a été modifié. Pensez à vérifier que chaque joueur a compris les nouvelles règles **AVANT** de commencer la partie.

Maintenant que vous savez comment jouer selon les règles de base, essayez les règles suivantes pour varier le jeu. Vous pouvez aussi essayer d'inventer vos propres règles !



1) Éruption

Les joueurs ont maintenant deux options lorsque le dé indique Orange :

- Déplacez un bloc de lave où vous le voulez sur le volcan pour essayer de bloquer les autres joueurs **OU**
- Passez le bâton de lave à travers le volcan pour faire tomber un chevalier se trouvant de l'autre côté. Celui-ci **RETOURNE** à sa position de départ.



Une fois que le bâton de lave a été utilisé ou un bloc de lave déplacé, chaque joueur, en commençant par celui qui a lancé le dé et en poursuivant dans le sens des aiguilles d'une montre, déplace son chevalier d'une case par tuile de déplacement visible sur la face supérieure du dé.



2) Corde d'escalade

Ajoutez une tuile marron sur une des faces du dé LEGO.

Lorsque le dé indique une face avec une tuile marron, vous pouvez grimper d'un ou plusieurs niveaux.

La tuile marron permet aux joueurs de se déplacer d'une case.

Ce mouvement peut faire grimper le chevalier d'un ou plusieurs niveaux.

Le chevalier peut maintenant grimper plusieurs niveaux à la fois sur une paroi verticale et lisse du volcan, à condition qu'il y ait une case libre au-dessus de lui.

Sur l'illustration ci-contre, les flèches jaunes indiquent les possibilités de déplacement lorsque le dé indique une face avec une tuile marron. Une fois que la

corde a été utilisée, chaque joueur, en commençant par celui qui a lancé le dé et en poursuivant dans le sens des aiguilles d'une montre, déplace son chevalier d'une case par tuile de déplacement visible sur la face supérieure du dé.

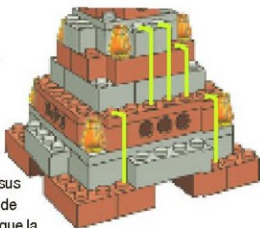

Inventez et partagez vos propres règles

Mettez votre imagination à l'épreuve et essayez d'inventer de nouvelles règles. Si elles fonctionnent, chargez vos « règles maison » sur jeux.LEGO.fr pour les partager. Ou voyez ce que d'autres ont imaginé et essayez de jouer selon leurs propres règles maison.

Rendez-vous sur notre site Internet !

Le site jeux.LEGO.fr regorge de bonus super sympas. Une petite vidéo montre comment jouer et présente les autres jeux de société LEGO. Vous trouverez également d'autres façons plus amusantes les unes que les autres de construire, jouer et changer le jeu !



BUILD

Prove you are the bravest knight of all by being the first one to summon the dragon from the top of the volcano. Avoid the lava and block your opponents as you climb to victory.

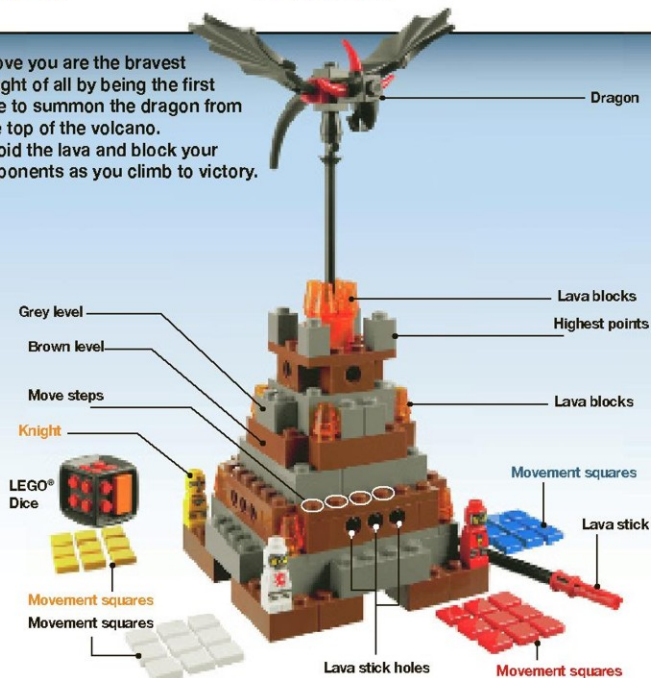

Aim of the game

The first knight to climb to the top of the volcano and summon the lava dragon wins.

Setting up the game

Before you start playing, build the game using the LEGO® building instructions provided in the set.

Building the game teaches you more about the pieces and how you can use them.

This makes it easier to rebuild or change the rules of your game later on.

Build the LEGO Dice by placing the two orange lava tiles on opposite sides.



This set includes a tool to help you take tiles off the LEGO Dice

Before each new game, reset the game to match the picture above, or the image on the last page of the building instructions.

Starting with the youngest player, each player selects a knight and takes the nine movement squares that match the colour of the knight selected, and then places one movement square on the LEGO Dice next to an orange lava tile.



Playing the game

The youngest player starts first. Play then continues clockwise.
Each turn a player rolls the LEGO® Dice and does the following:



Sides without movement squares

- 1) Place one of your movement squares onto the side of the LEGO Dice you rolled, AND
- 2) Move your knight one step on the volcano. You can decide whether to move your knight or not.



Sides with movement squares

- 1) Place one of your movement squares onto the side of the LEGO Dice you rolled if there is space remaining and if you still have movement squares left, AND
- 2) All players with movement squares showing on the side of the LEGO dice rolled can move their knights. Starting with the player who rolled and continuing clockwise, players move their knight one step for each movement square on the side of the LEGO Dice rolled.

Knights cannot stand on top of, or over other knights or climb over them.



Sides with orange volcano tile

Move one lava block anywhere on the volcano to block the other players. Once the lava block is placed, starting with the player who rolled and continuing clockwise, players move their knight one step for each movement square on the side of the LEGO Dice rolled.

Knights cannot move on top of, or over lava blocks.

Examples of how movement squares function when the red player has rolled and added a red movement square to the LEGO Dice:



Red player moves one step



Red player places one lava block and then moves one step. Then the blue player moves one step



Red player moves two steps



Red player moves two steps, and blue and yellow players move one step each



Moving knights on the volcano

Each movement square allows a player to either move his or her knight one step horizontally along the same level of the volcano, **OR** Climb up one level of the volcano, e.g. move from a brown level to a grey level or from a grey level to a brown level. Knights can only climb one level per movement square.



One = 1 step

Knights cannot be moved diagonally.

Winning the game

The first player to roll an orange volcano tile when his or her knight is standing on one of the highest points of the volcano wins the game.

The winning player places his or her knight on the lava dragon and flies off victorious!

If the player at the highest point does not roll an orange volcano tile, the game continues with the other players climbing according to the rules mentioned above.



The LEGO tilt
The best way to pick up your LEGO pieces is by tilting them before you pick them up.



CHANGE

YOUR GAME – YOUR RULES

The LEGO® Dice gives you the freedom to change the game and make it your own. You can change the playing area, the pieces and even the rules. Every little change makes it more and more YOUR game.

The secret to changing a game is to change only one thing at a time. That way, you can see if the change makes the game more fun. If it does, keep it and then try another.

Changing a game is always more fun when done together. That way everyone knows the rules and knows what is being changed. Remember to make sure everyone playing is aware of any new rules **BEFORE** you start playing.

Now that you know how to play the game using our rules, try one of the following suggestions to change the game, and then try to make a change of your own.



1) Volcanic explosion

Players now have two options when rolling orange:

- Move one lava block anywhere on the volcano to block the other players, **OR**
- Use the lava stick by pushing it through the volcano to knock a knight off the volcano.

The knight RETURNS to its starting position at the beginning of the game.



Once the lava stick or lava block has been used, starting with the player who rolled and continuing clockwise, players move their knight one step for each movement square on the side of the LEGO Dice rolled.



2) Climbing rope

Add one brown tile to one side of the LEGO Dice.

When rolling brown the player can take his knight up one or more levels on a smooth side of the volcano if there is a free space available to climb to.

The yellow arrows on the illustration to the right indicate where the climbing rope takes the knight up two or more levels on the smooth wall.

Once the climbing rope has been used, starting with the player who rolled and continuing clockwise, players move their knight one step for each movement square on the side of the LEGO Dice rolled.

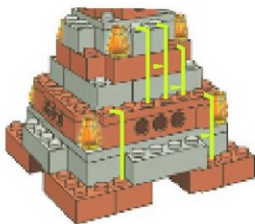

Invent and share your own rules

Challenge yourself, and see which new rules you can create. If they work, upload your "house rules" of the game to games.LEGO.co.uk and share them with others. Or check out what others have created and try playing the game using their house rules

Go online!

games.LEGO.co.uk is packed with cool features. There is a short video showing you how to play the game, and all of the other exciting LEGO Games. You can also find more fantastic ways to Build, Play and Change your games.

FREE! GRATIS! GRATUIT!

LEGO

club
MAGAZINE™

www.LEGOclub.com



00800 5346 5555*



1-866-534-6258 • 1-877-518-5346

USA Canada only

Canada seulement

* FreePhone. Mobile charges may apply. ** Numéro sans frais. Des frais peuvent s'appliquer avec les téléphones cellulaires.

* Toll-free/Free, Kosten für Land's own Mobile/Par défaut les lignes mobiles. ** Grands téléphones au "voix" costo lip.

* Des or est gratis/nummer, når du ringer fra fasttelefon. ** Det er gratis, når du ringer från en fast telefon.



VISIT THE WORLD'S
BIGGEST LEGO® SHOP!

www.LEGOshop.com



3835
Robo Champ

2-3 6+ 10-15



3836
Magikus

2-4 6+ 10-20



3837
Monster 4

2-4 7+ 15-20



3838
Lava Dragon

2-4 7+ 15-25



3839
Race 3000

2-4 7+ 20-30



3840
Pirate Code

2-4 8+ 15-25



3841
Minotaurus

2-4 7+ 20-30



3842
Lunar Command

2 7+ 15-30



3843
Ramses Pyramid

2-4 8+ 20-40

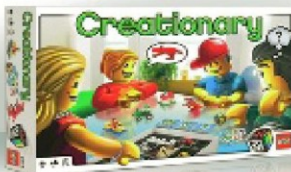

3844
Creationary

3-8 7+ 30-60

