



CITY

4644



1

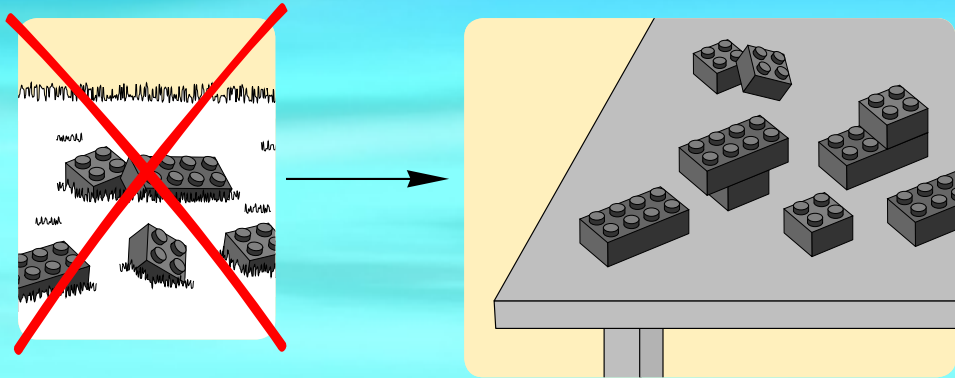

2

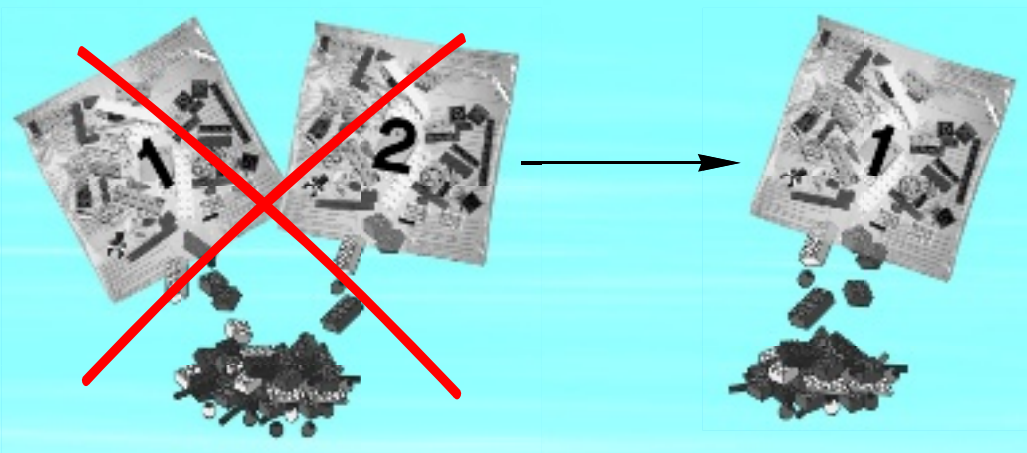

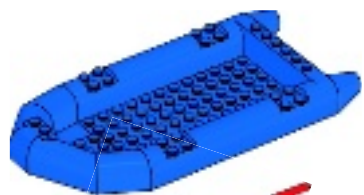

+



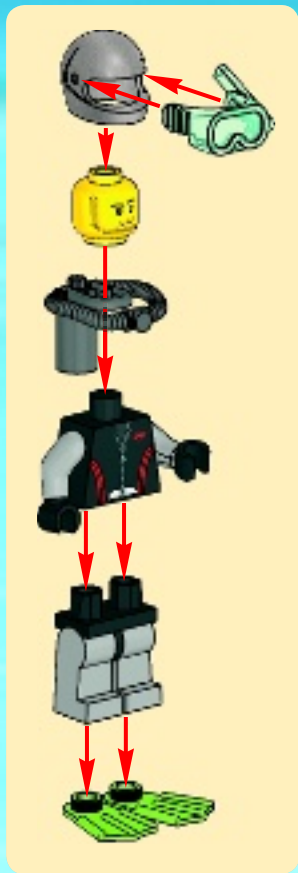

1



2

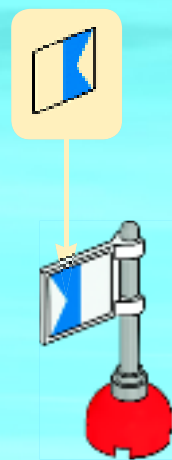

1

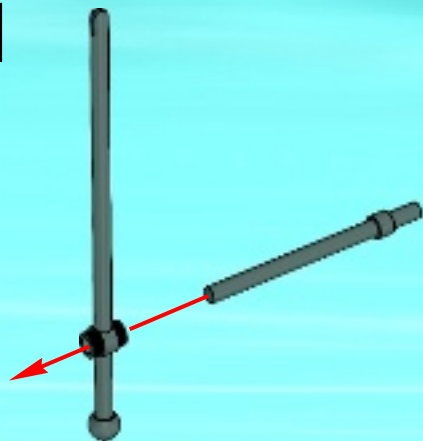

2



3

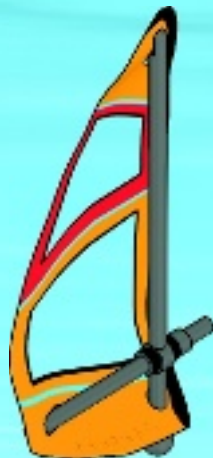

4



5





1

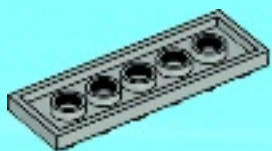

2



3

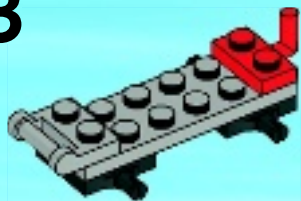

4



5

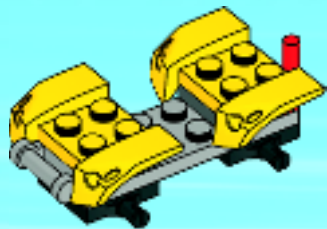

6



7

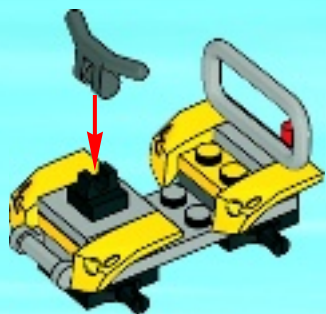

8





1

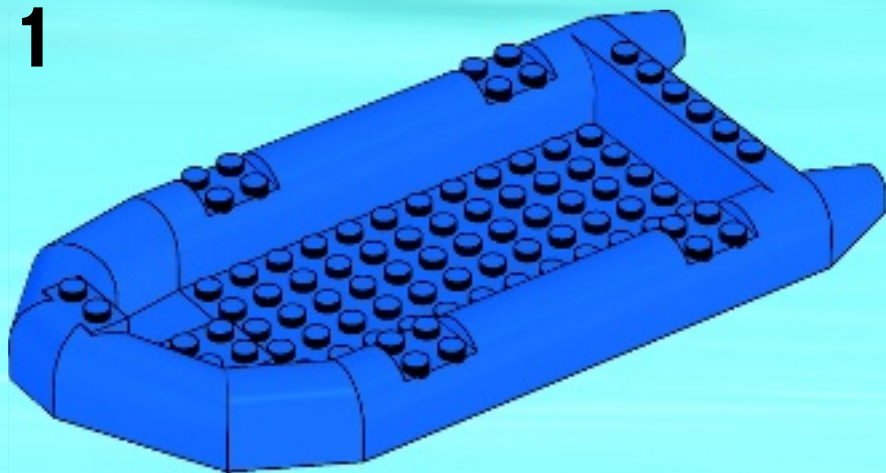

2

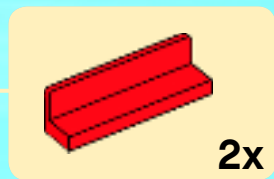
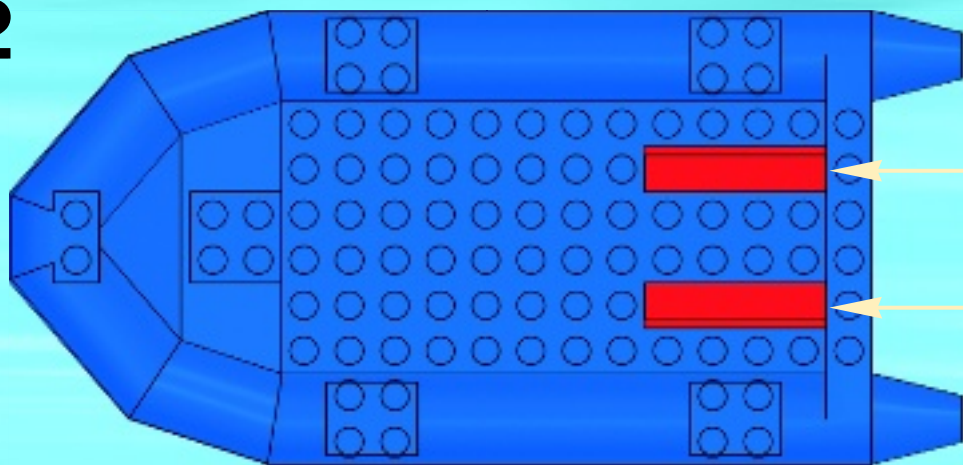

3



4

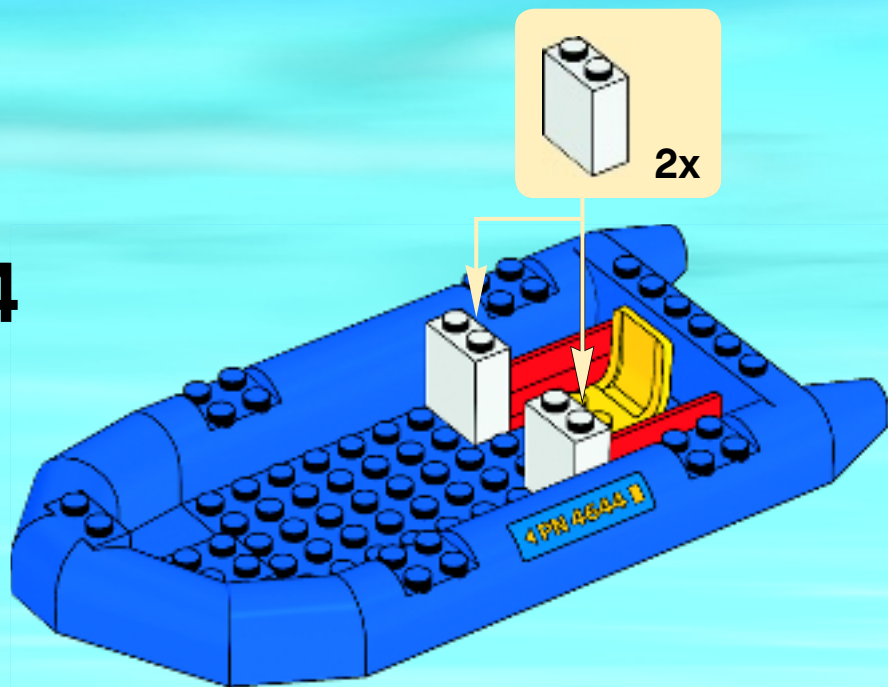

1

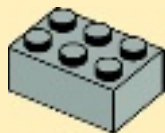

2



3



5

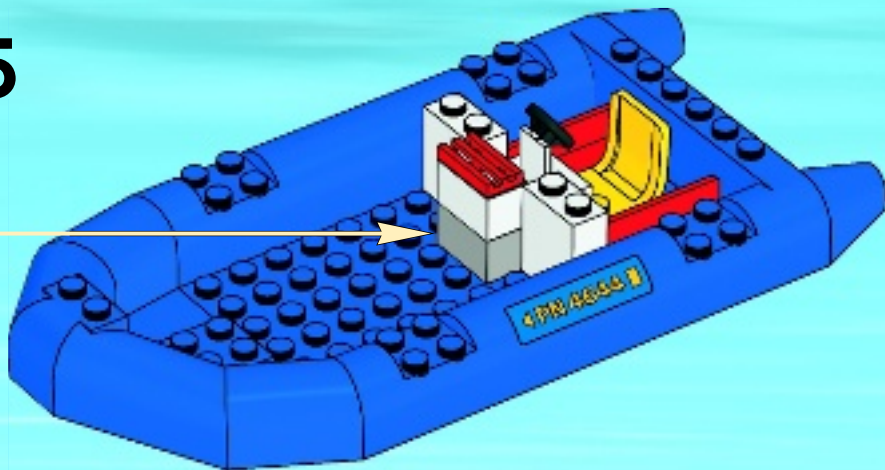

6

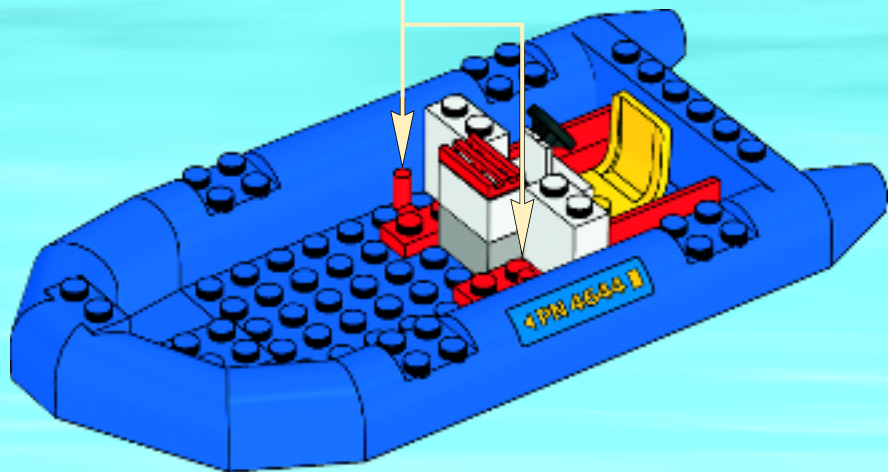

7

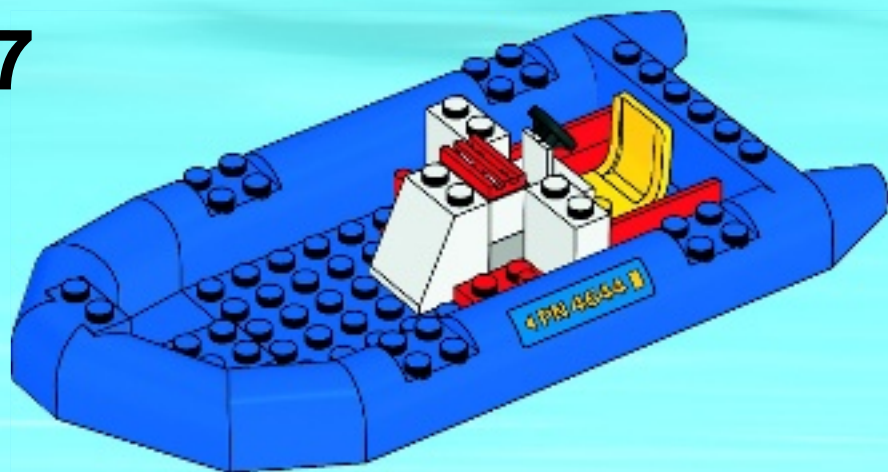

8

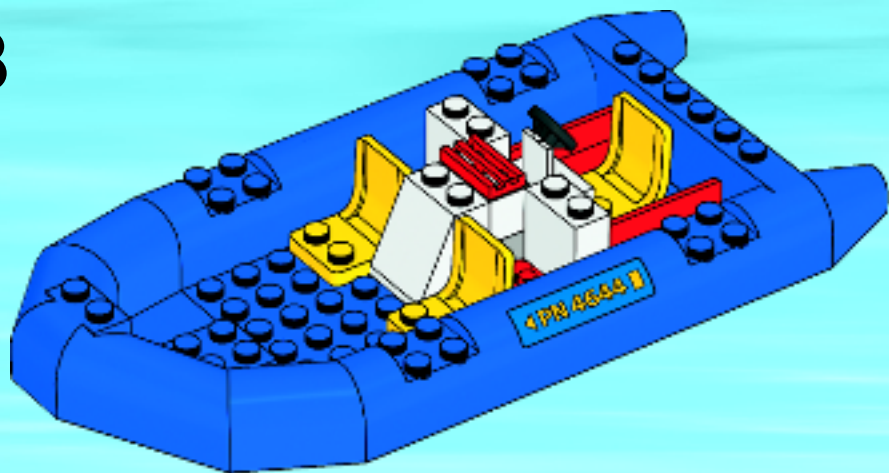

9

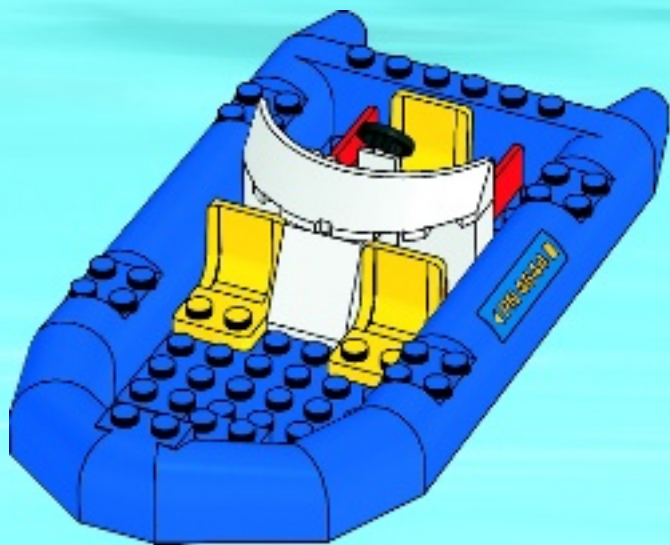

10

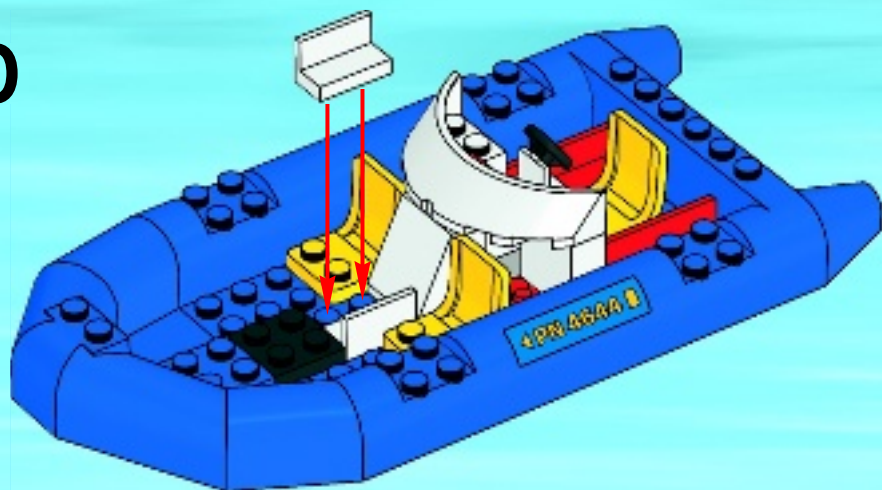

11

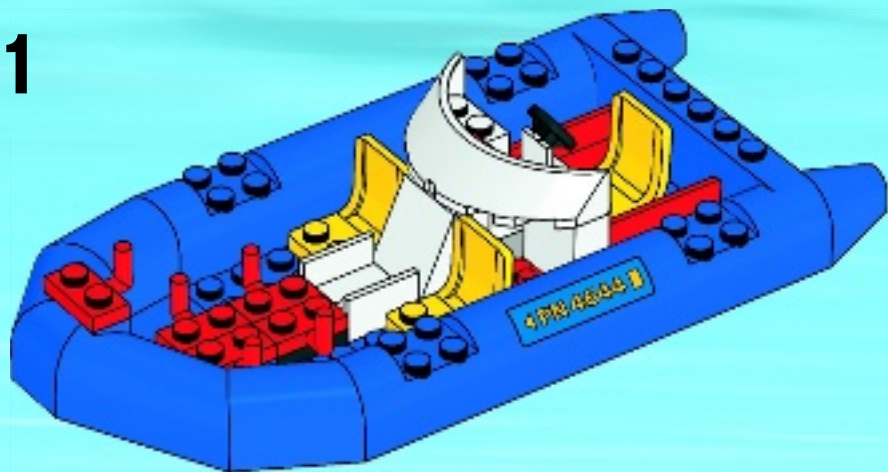

12

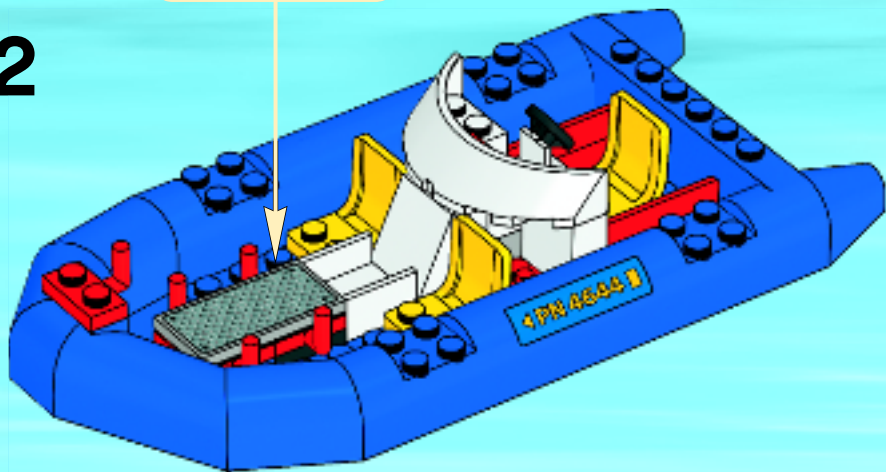
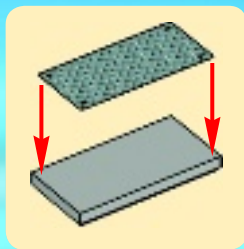

13

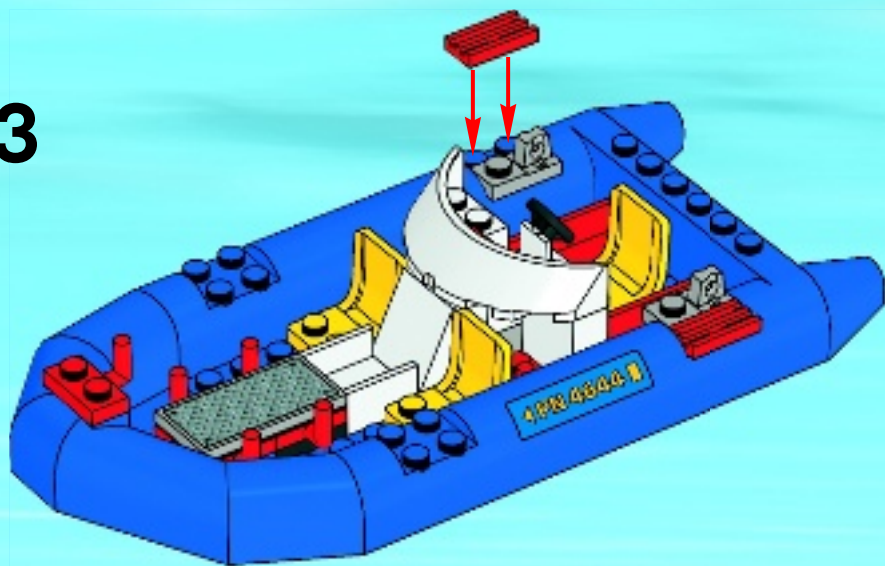

14

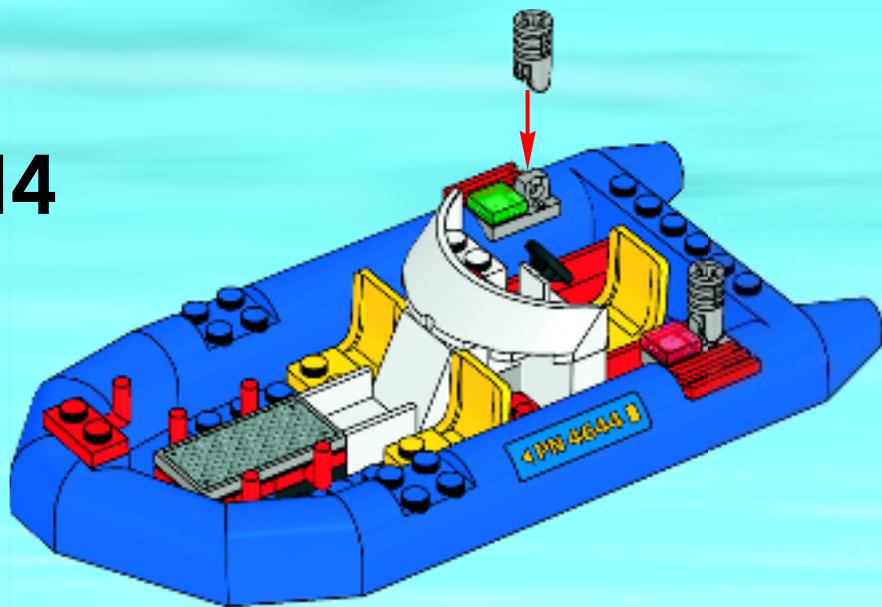

15

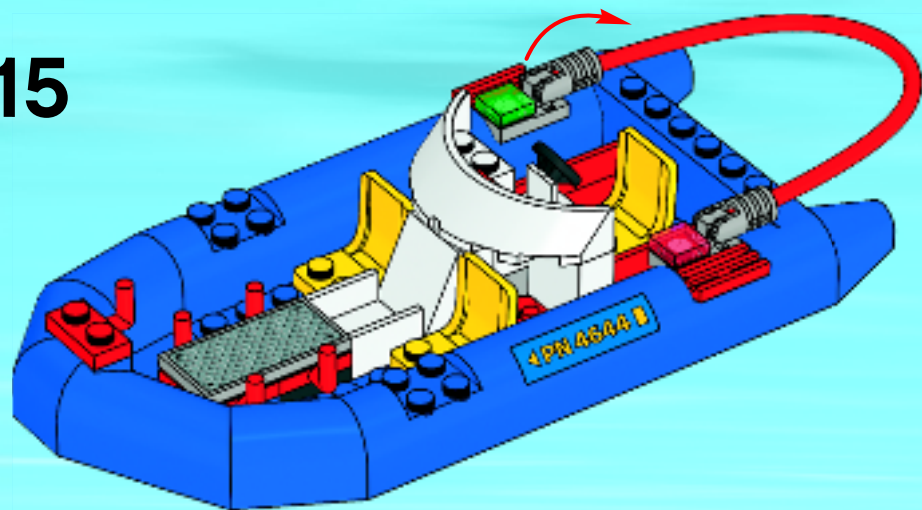

16

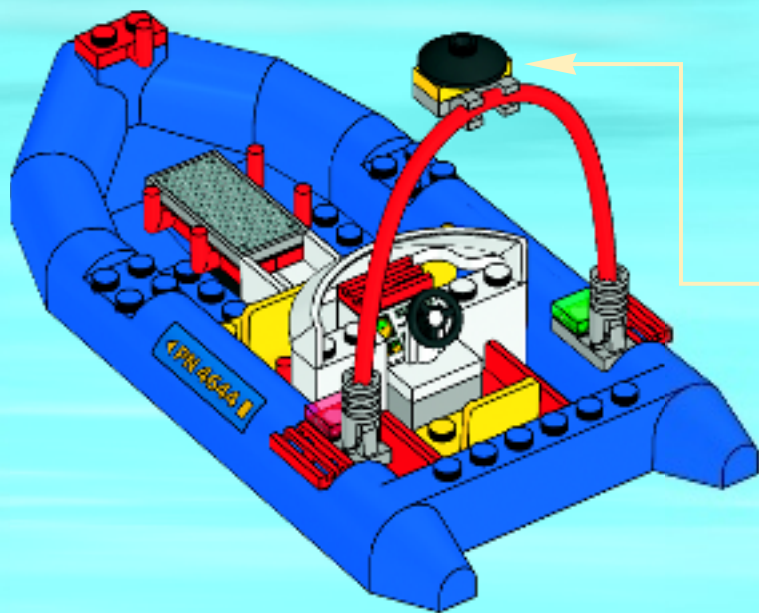

1

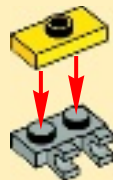

2



17

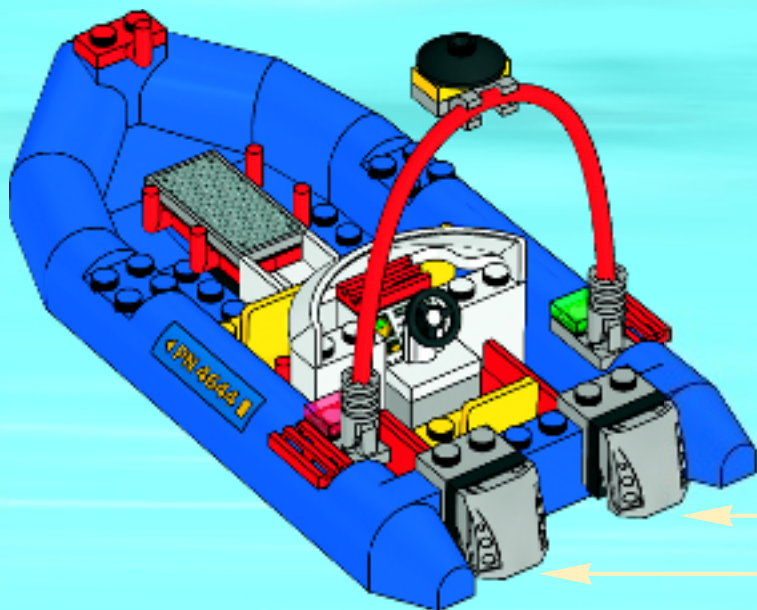

1



2

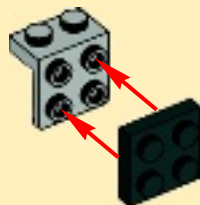

3



2x

18

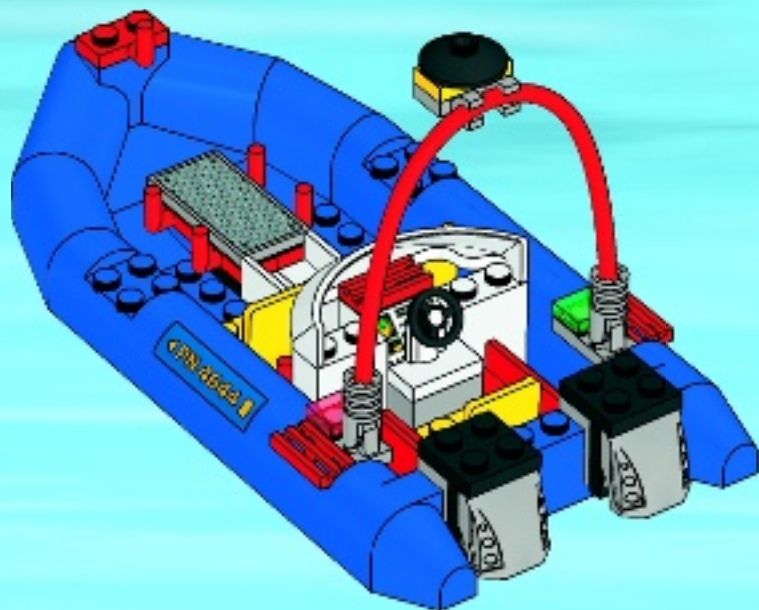

19

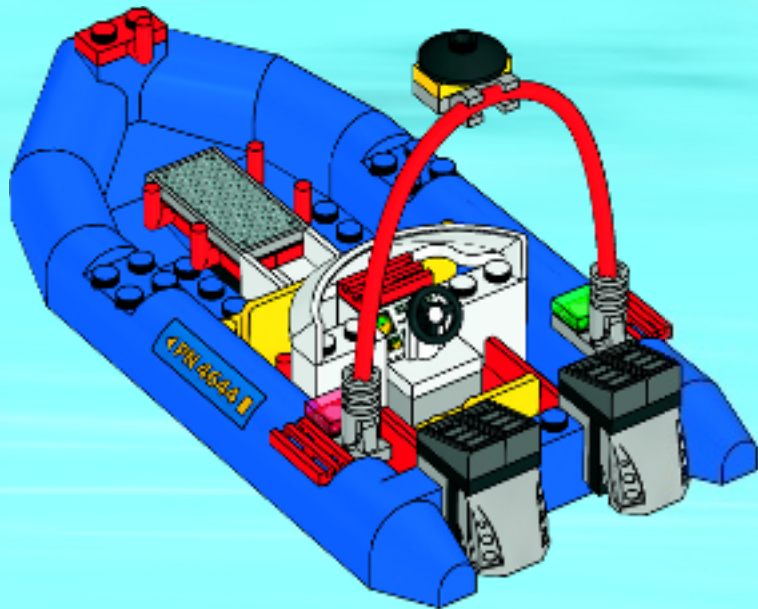

20

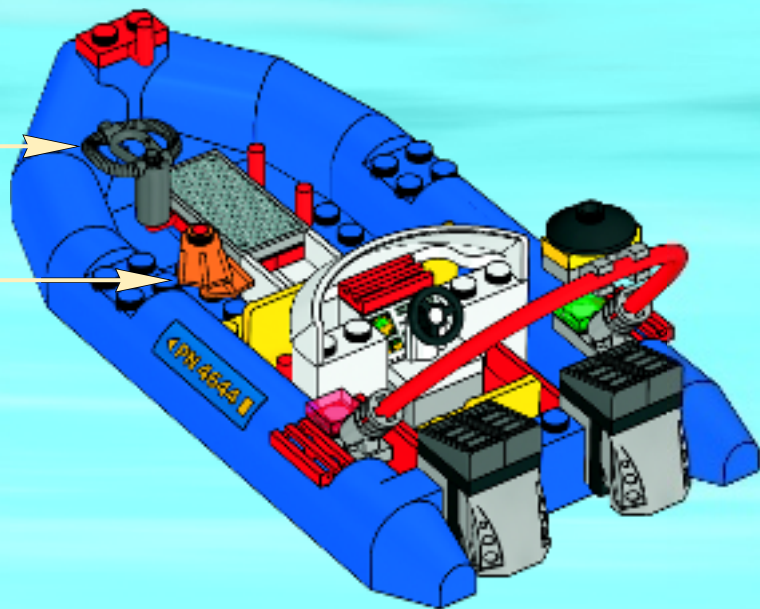

21





CITY

4644



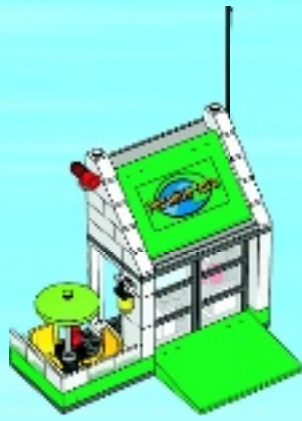
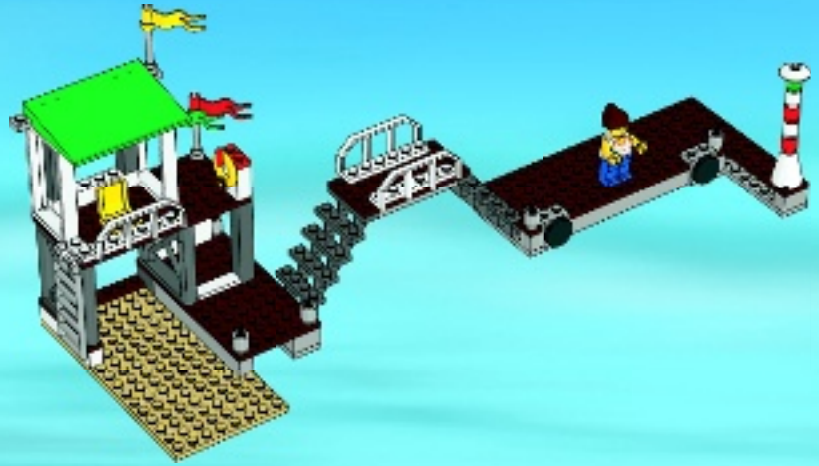



+

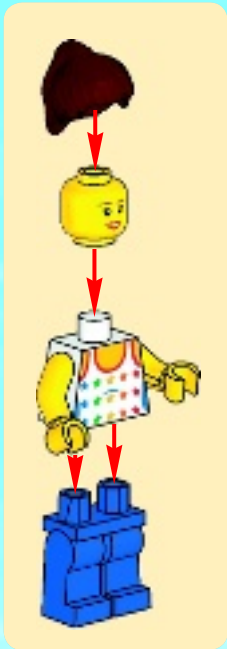
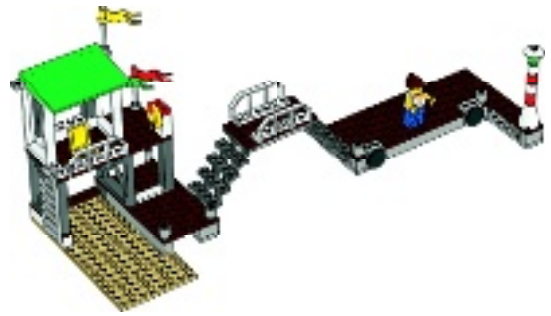

1

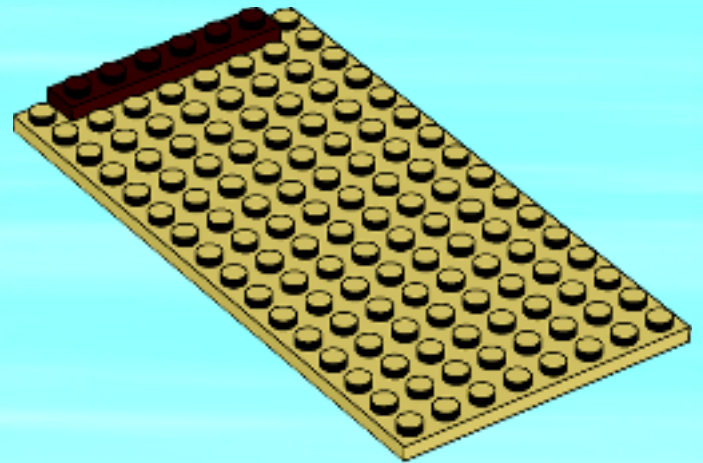

2

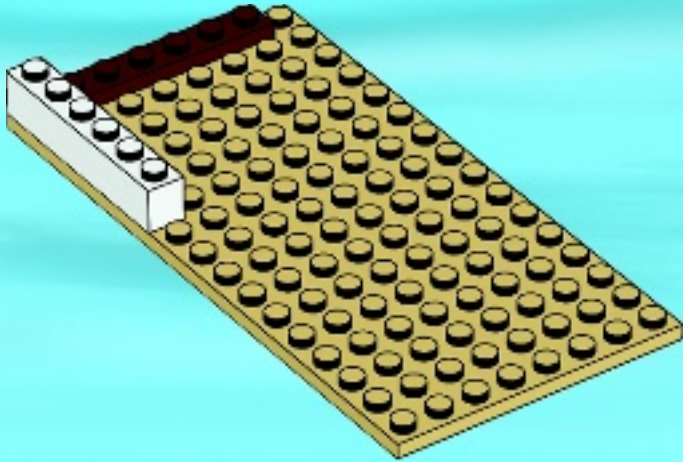

3

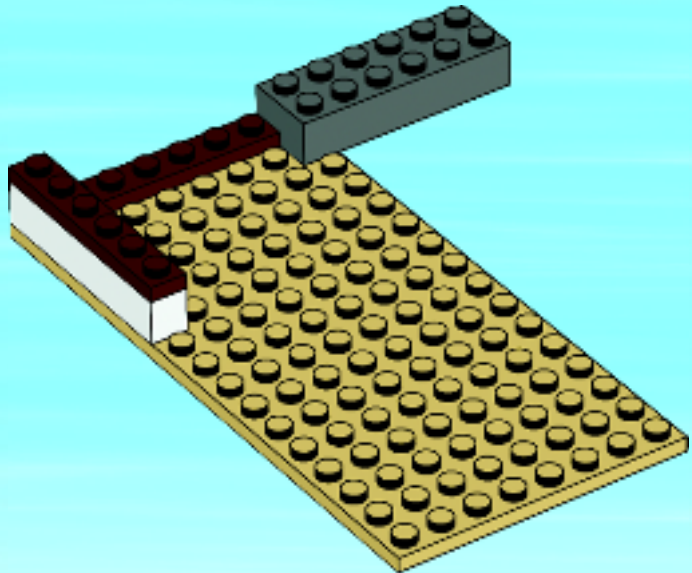

4

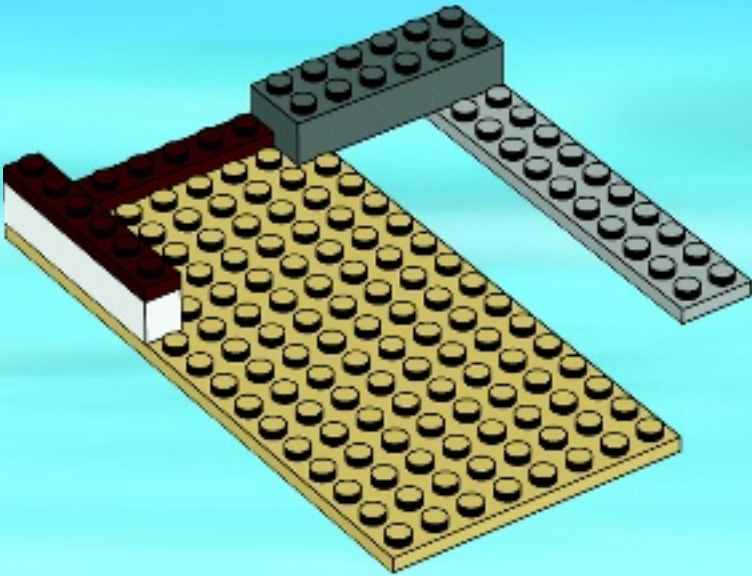

5

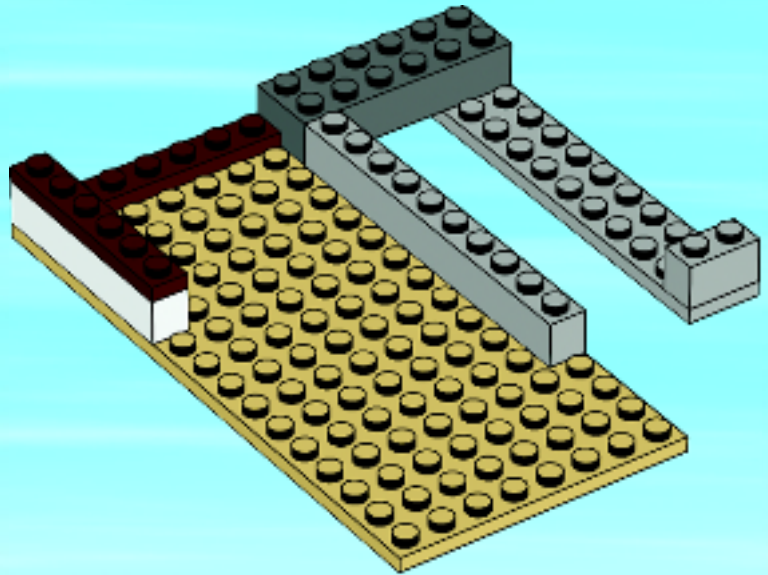

6

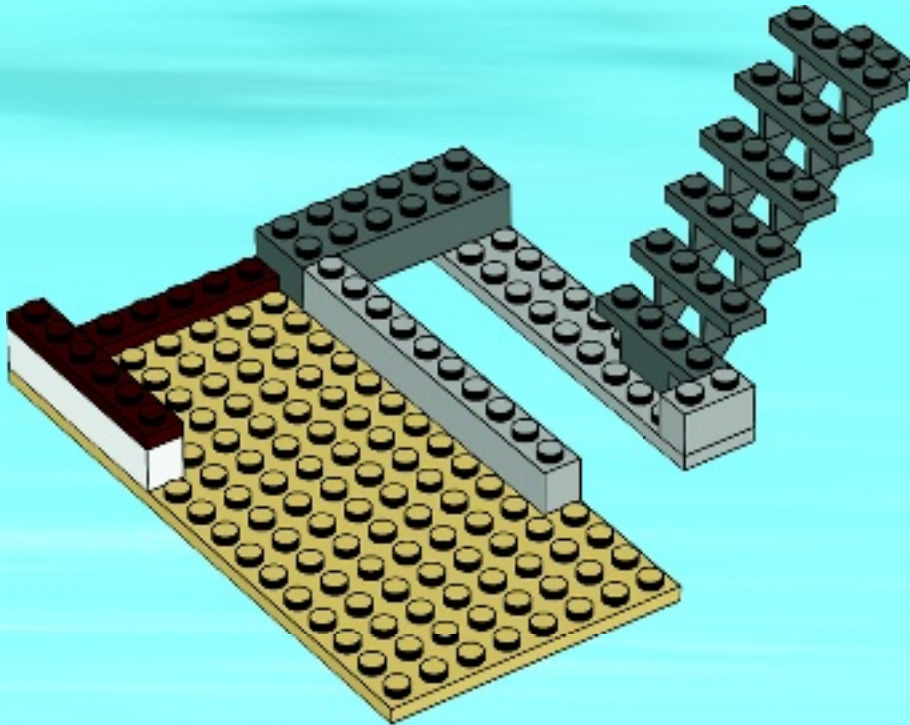

7

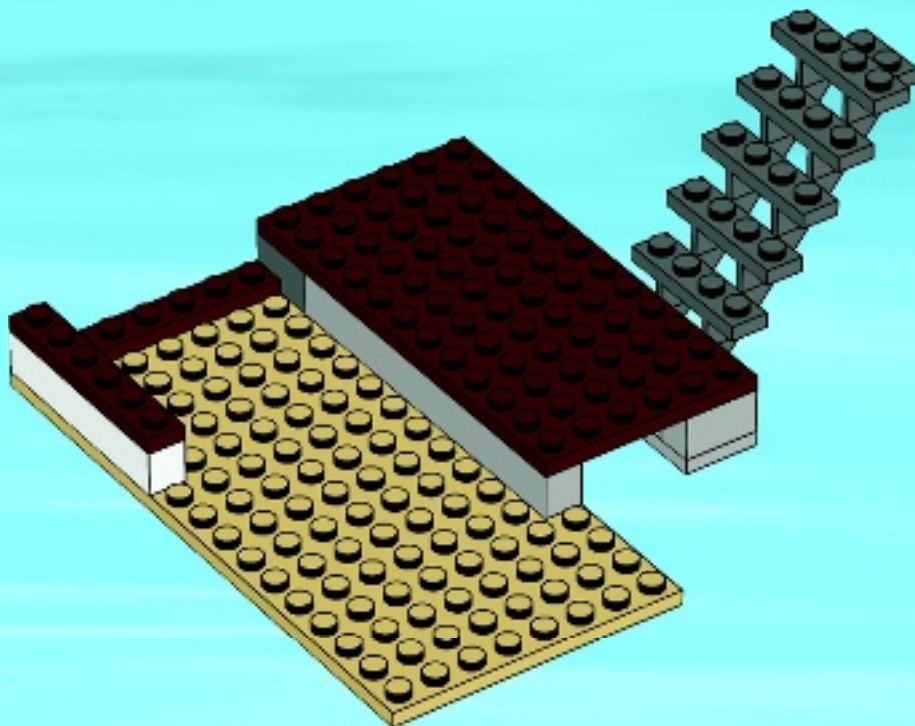

8

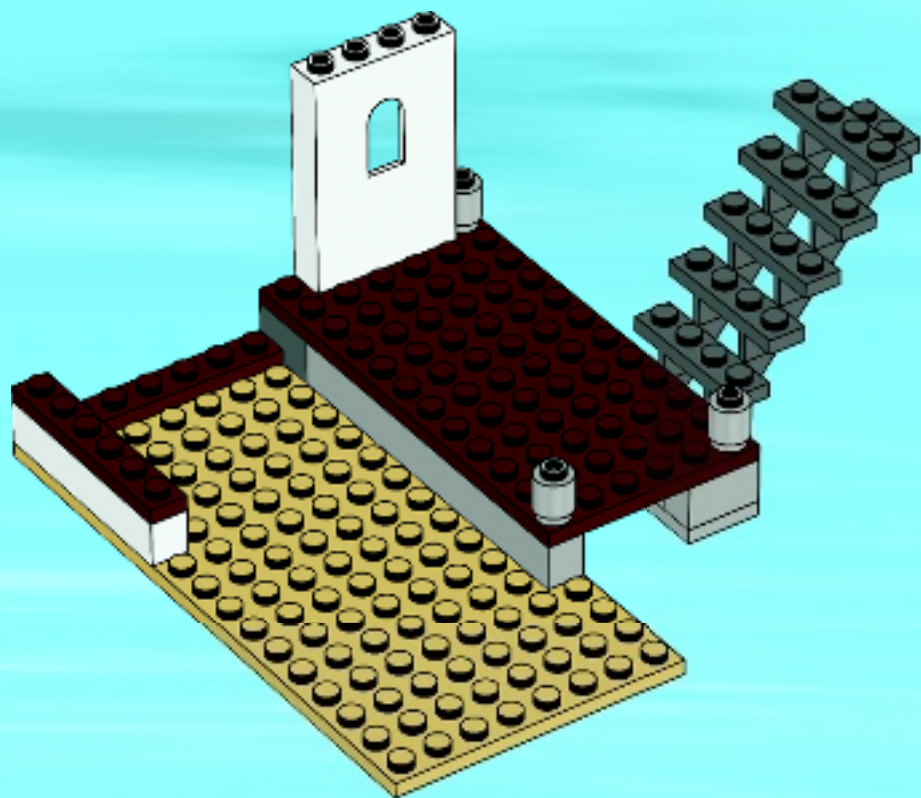

9

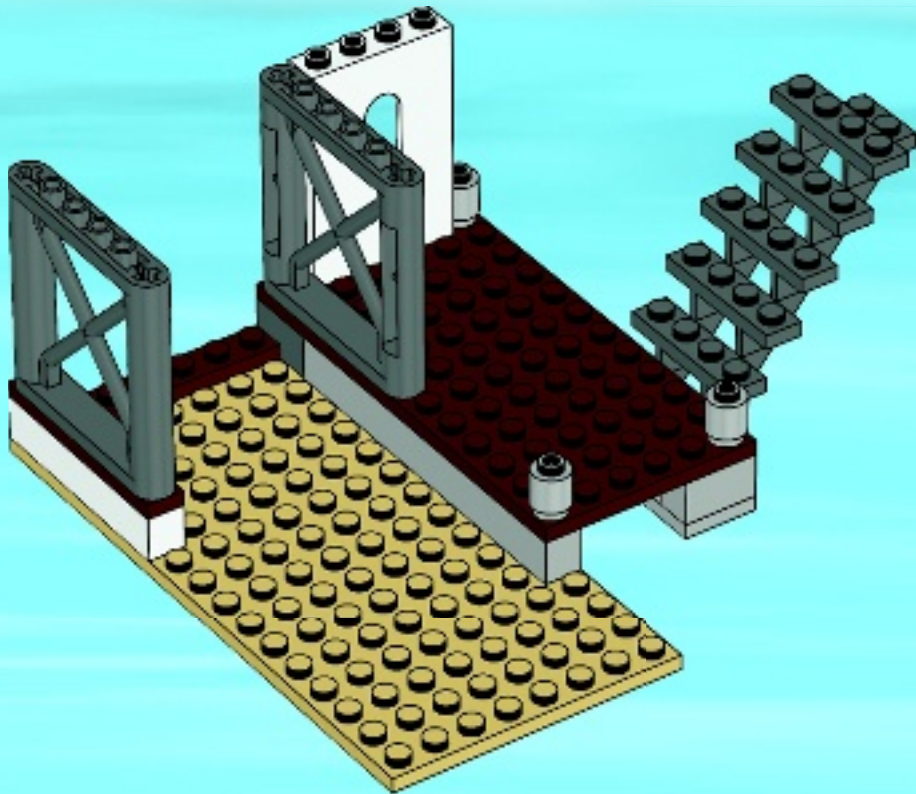

11

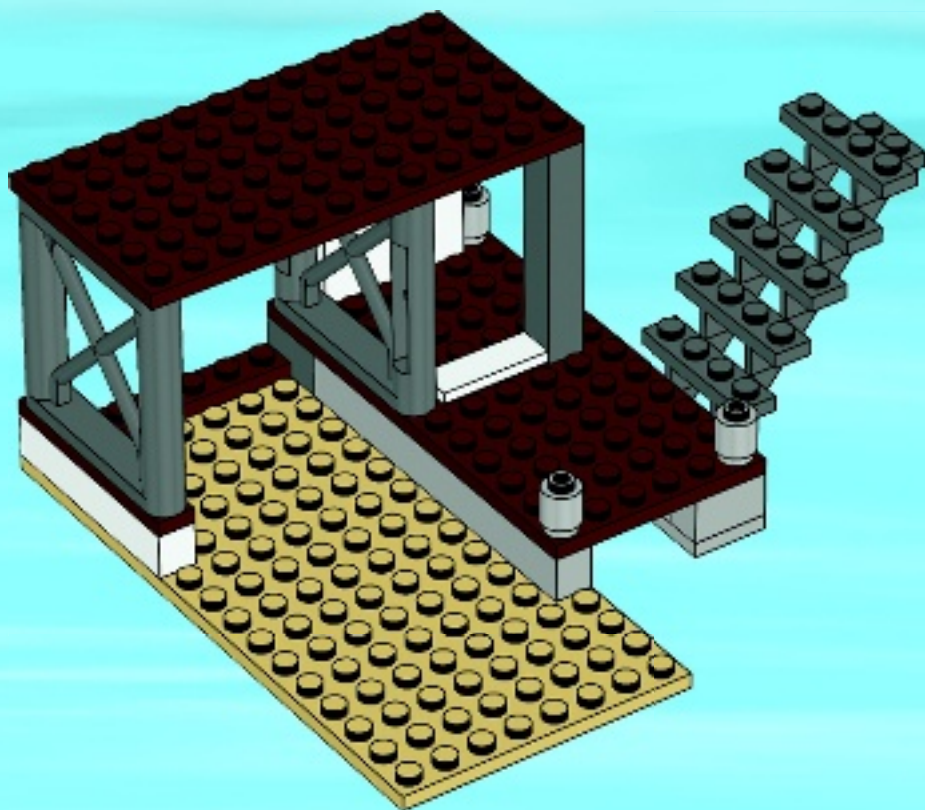

12

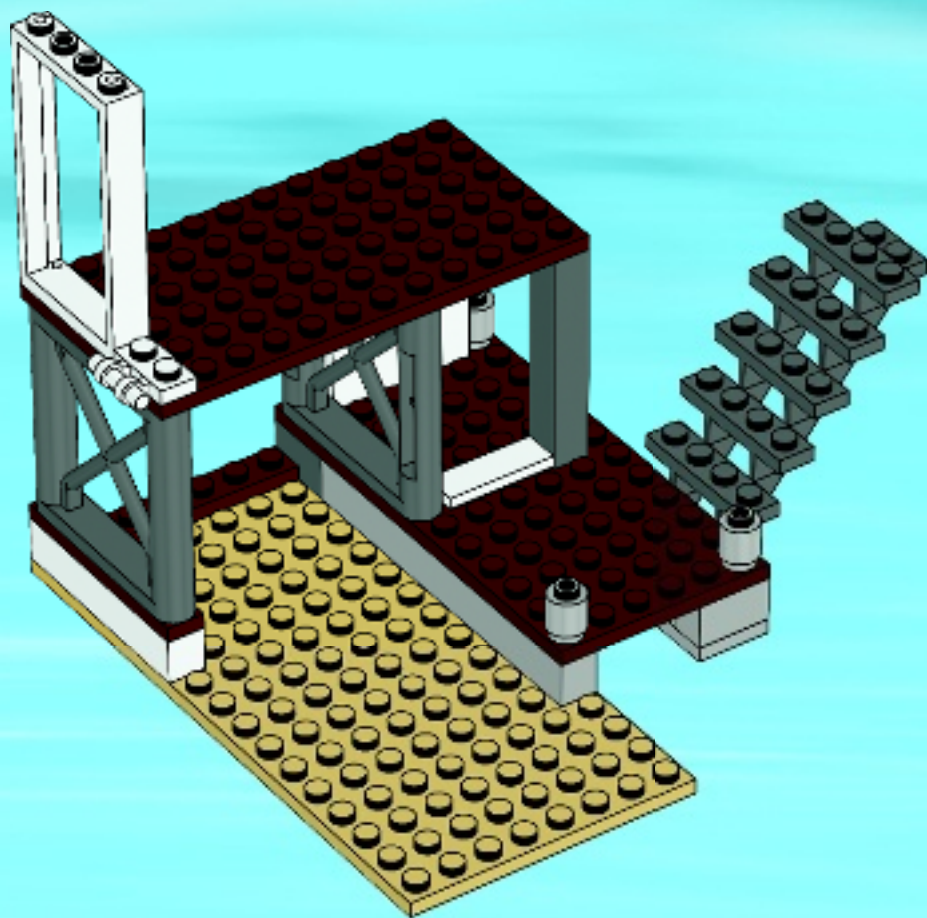

13

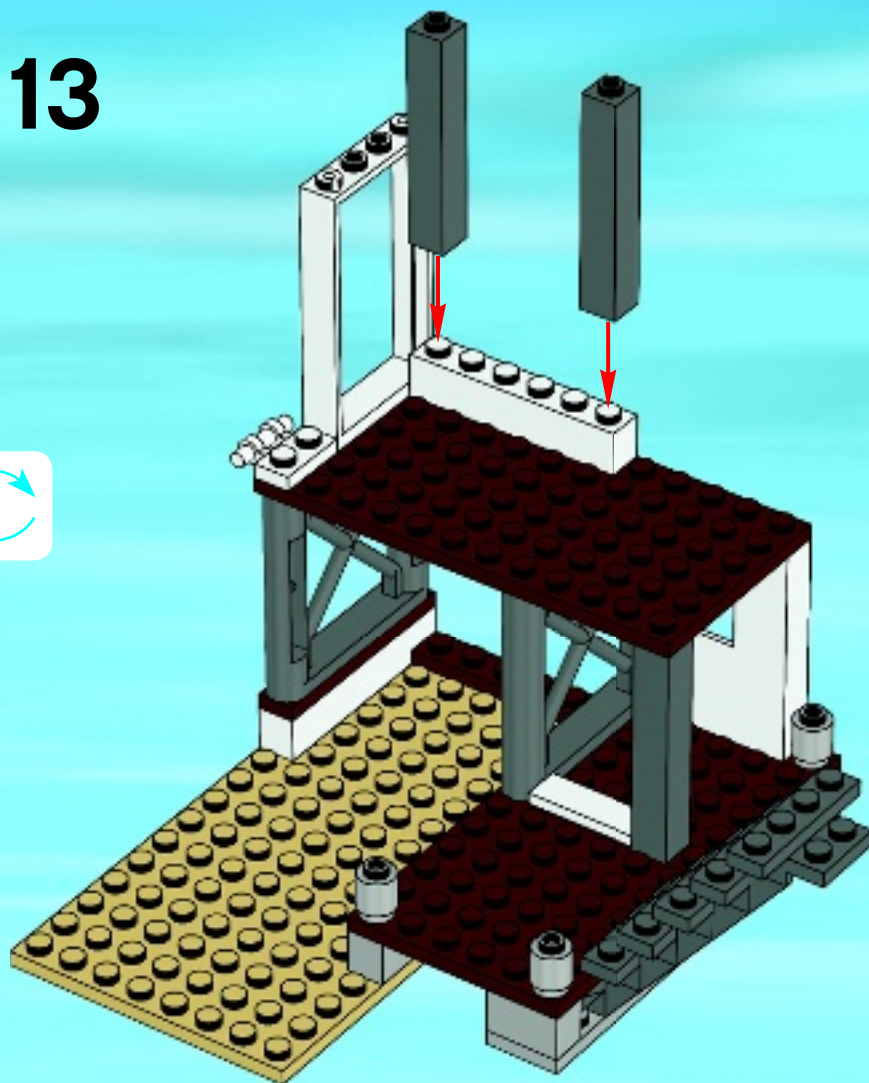

14

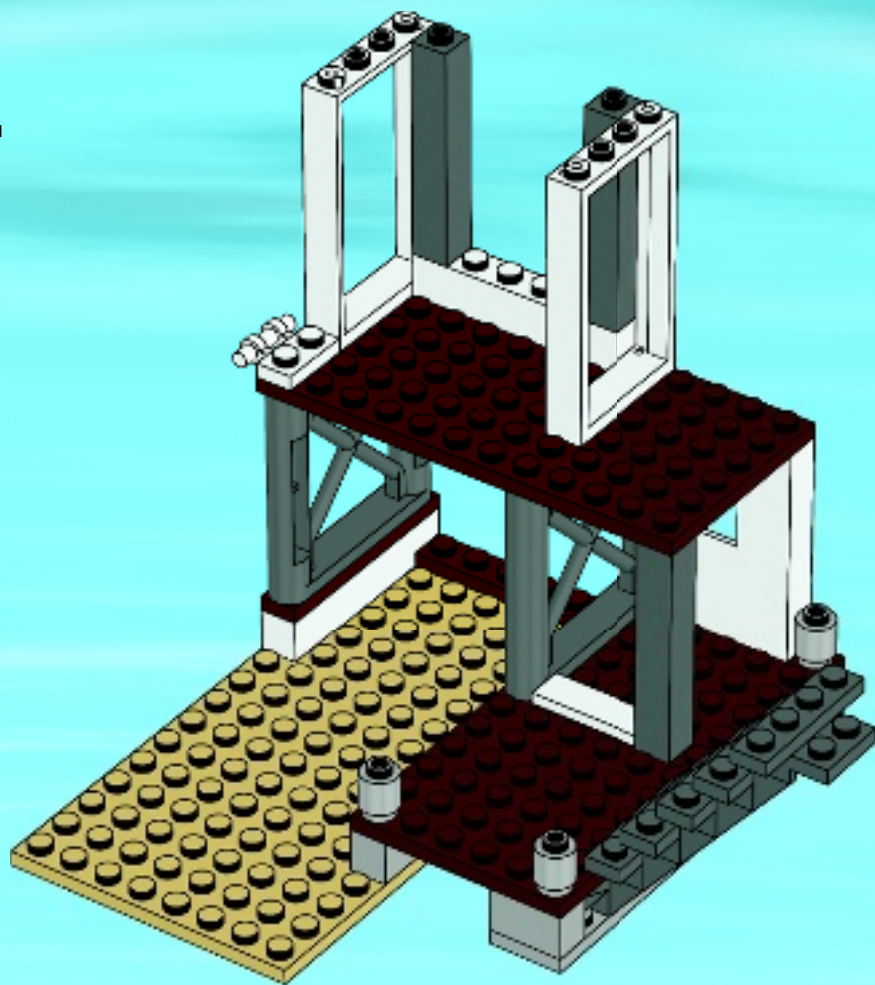

15

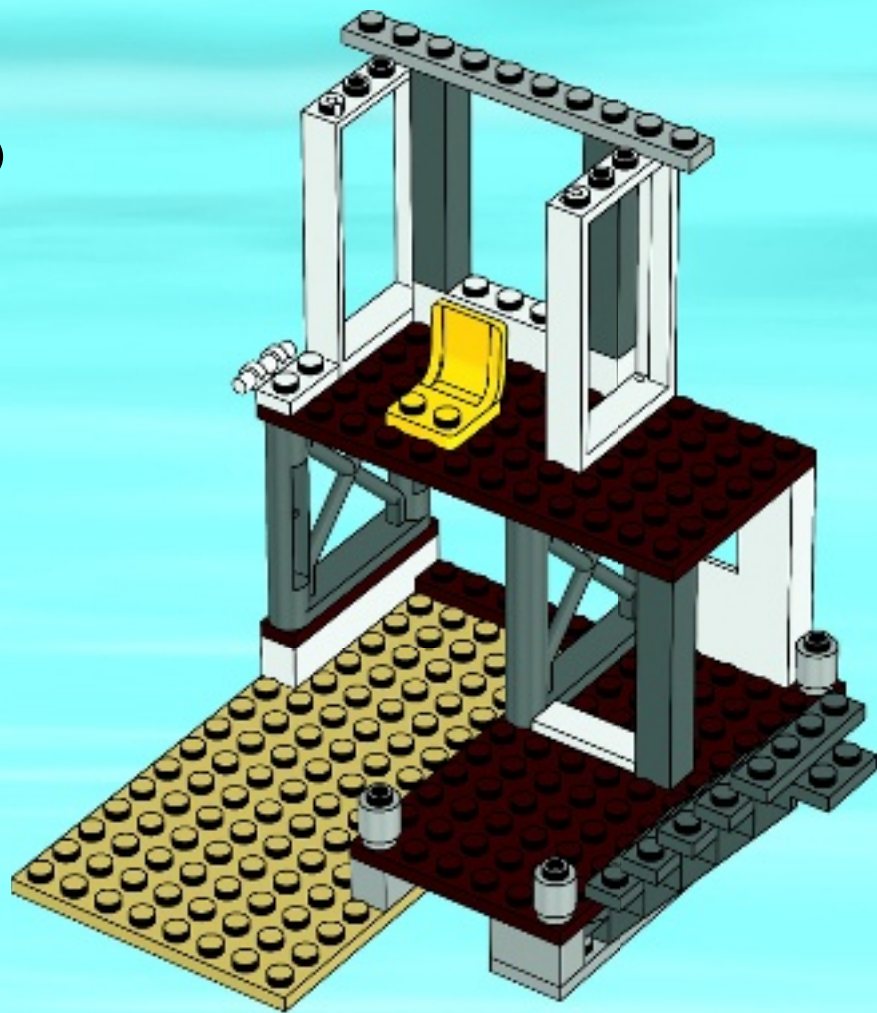

16

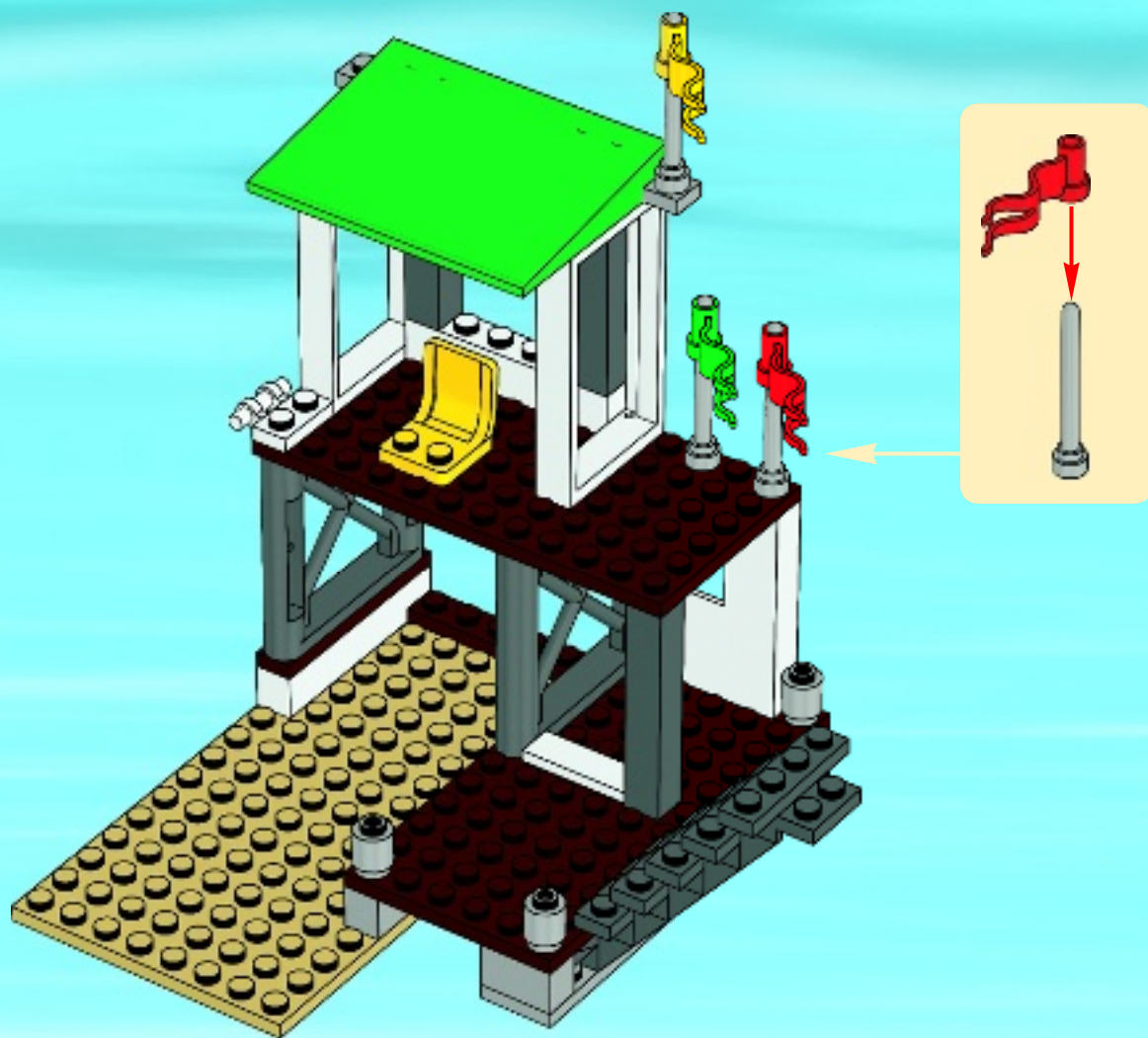

17

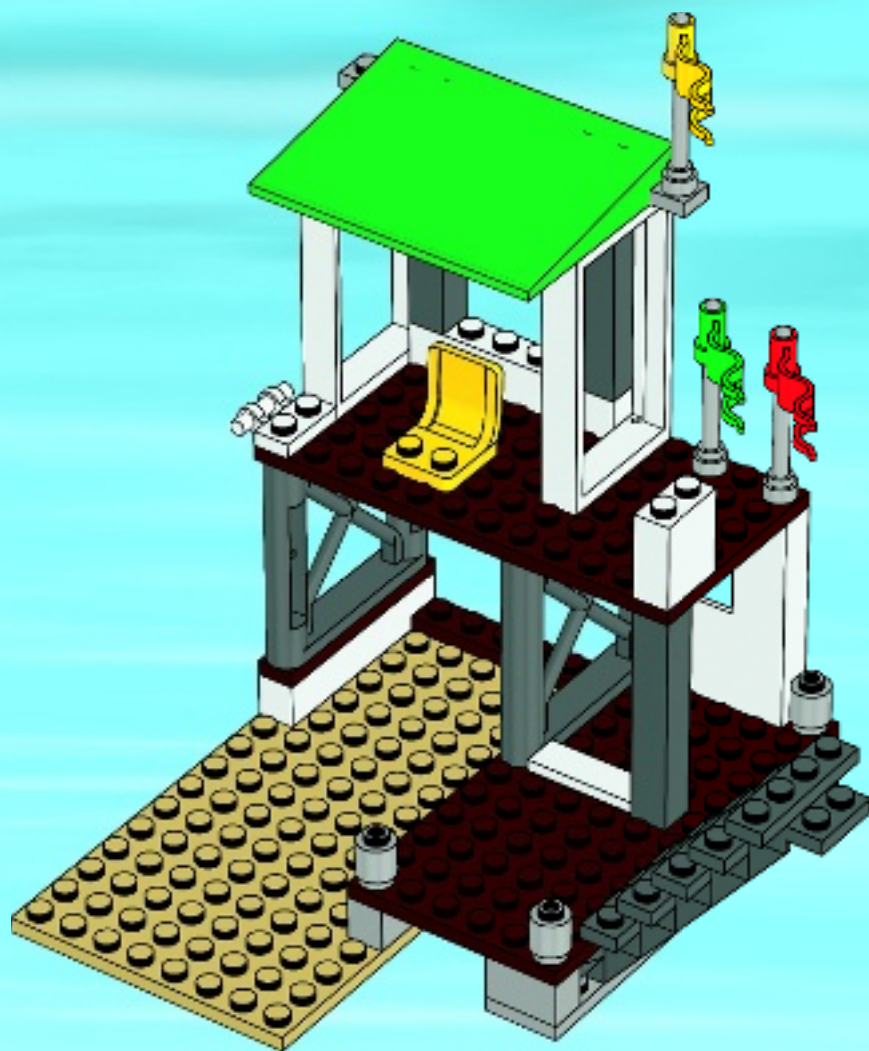

18

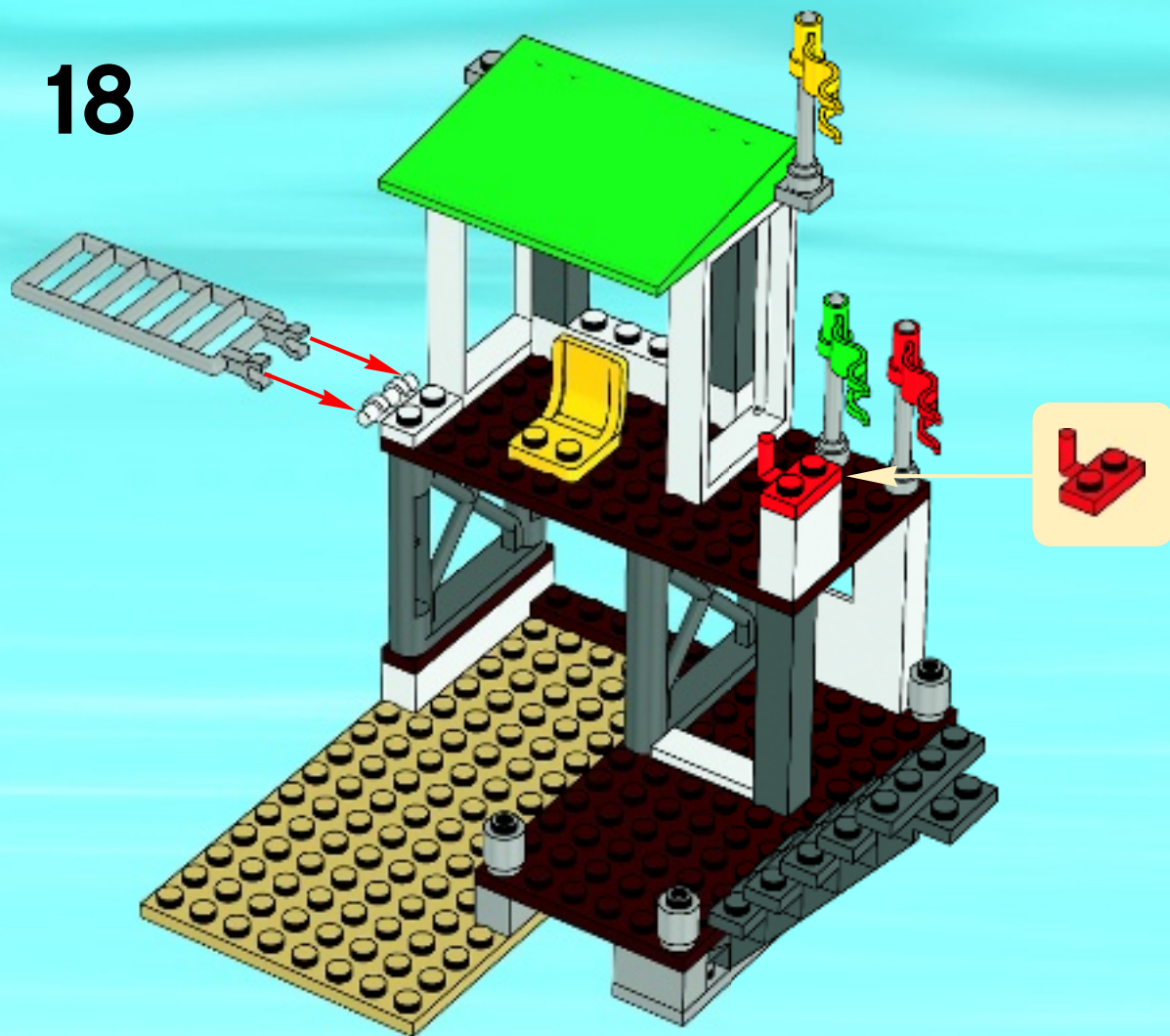

19

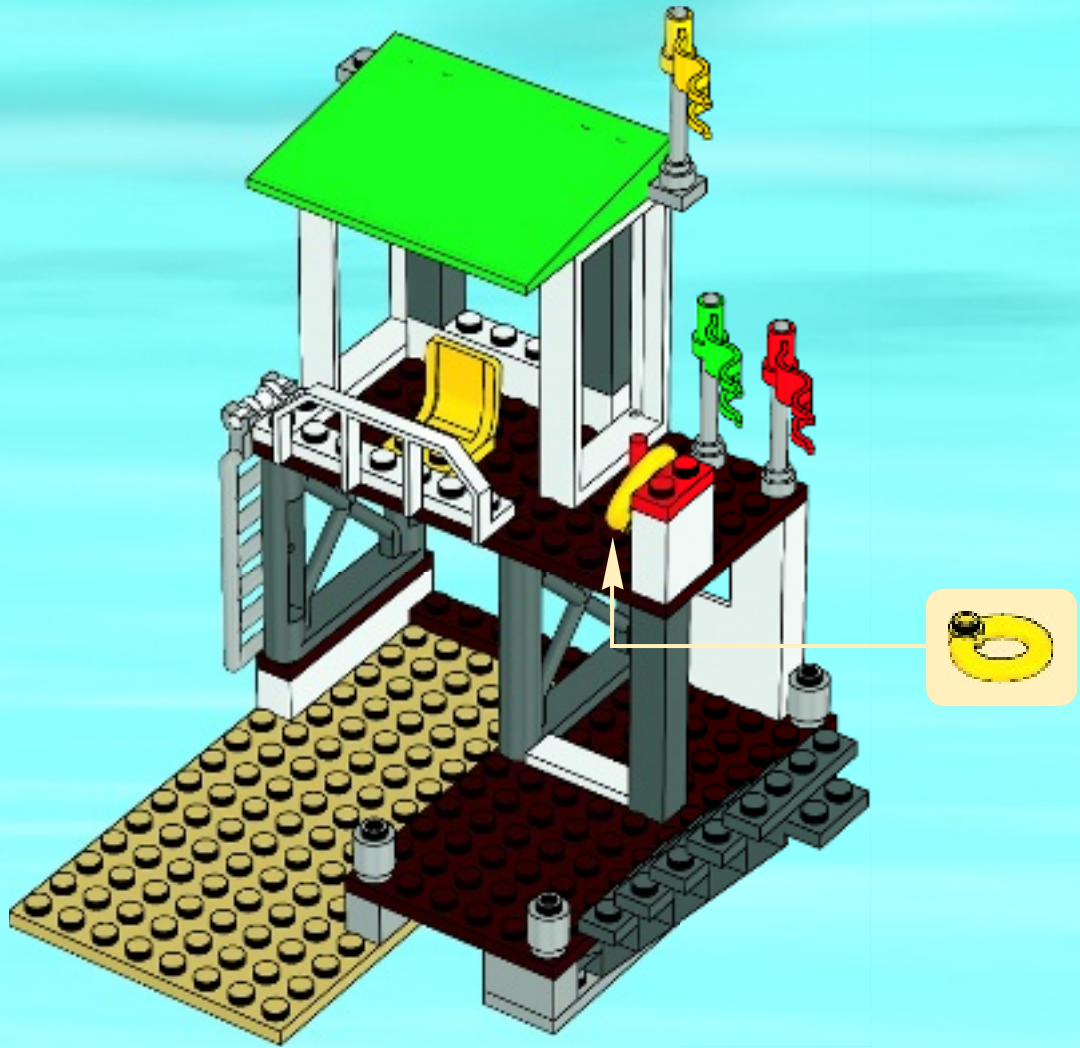

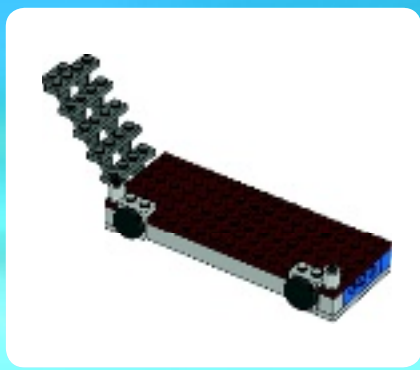

1

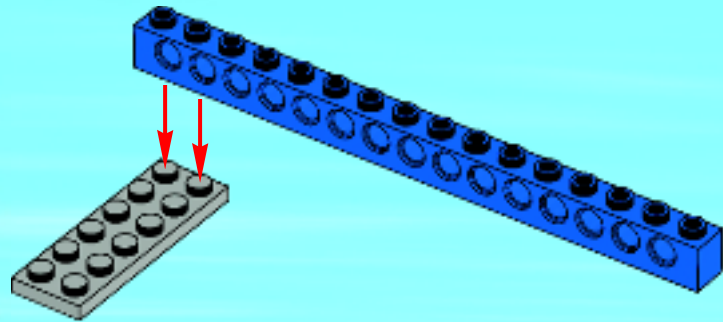

2

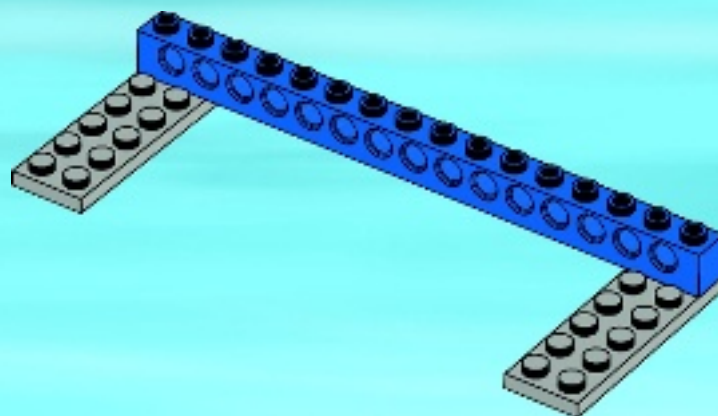

3

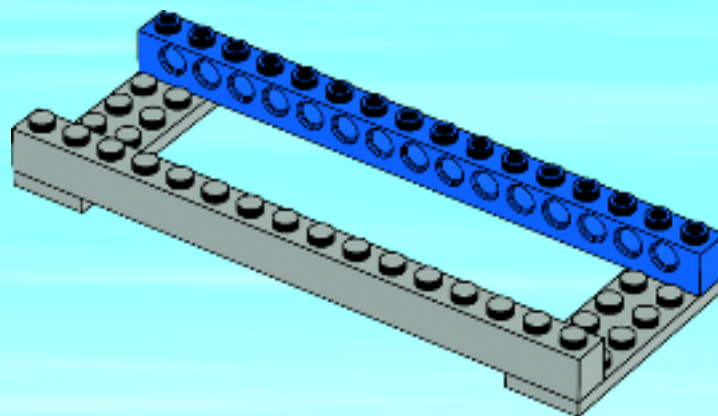

4

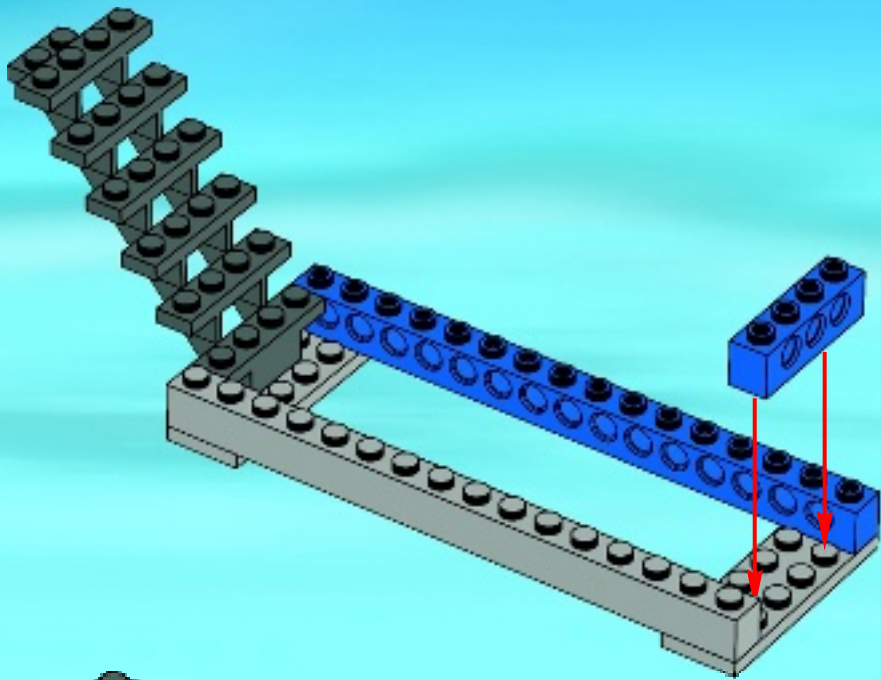

5

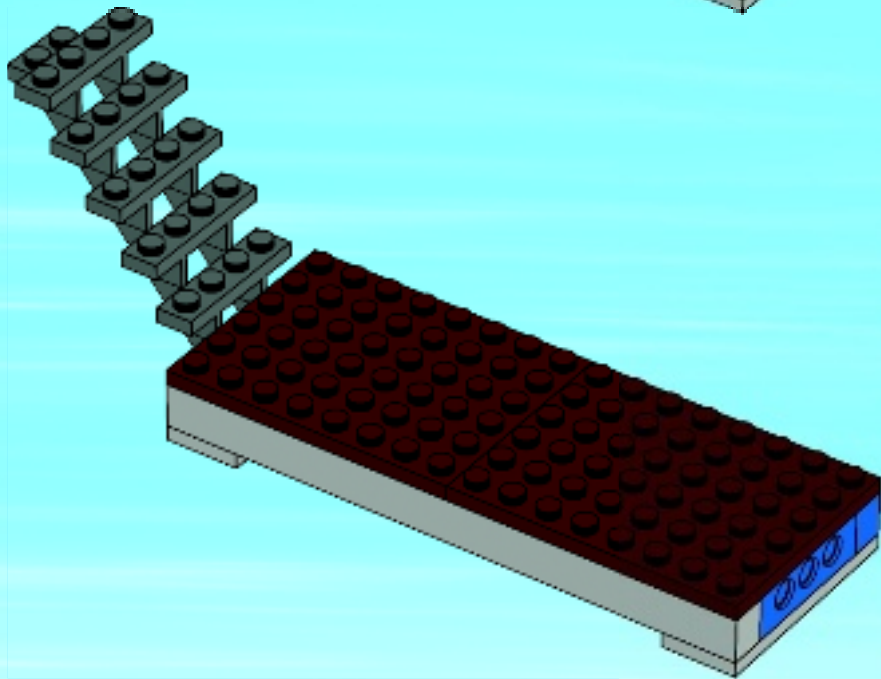

6

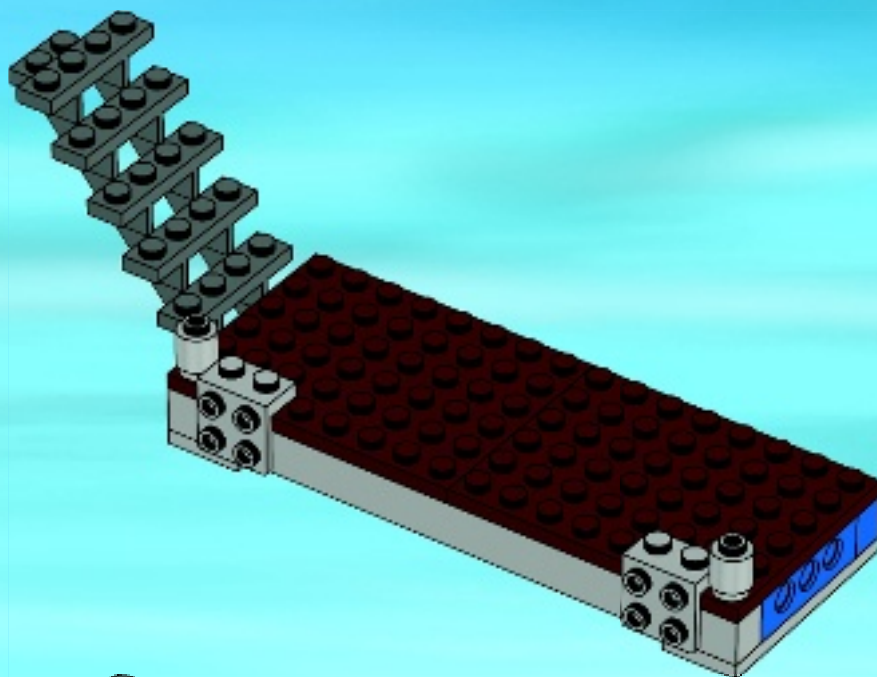

7

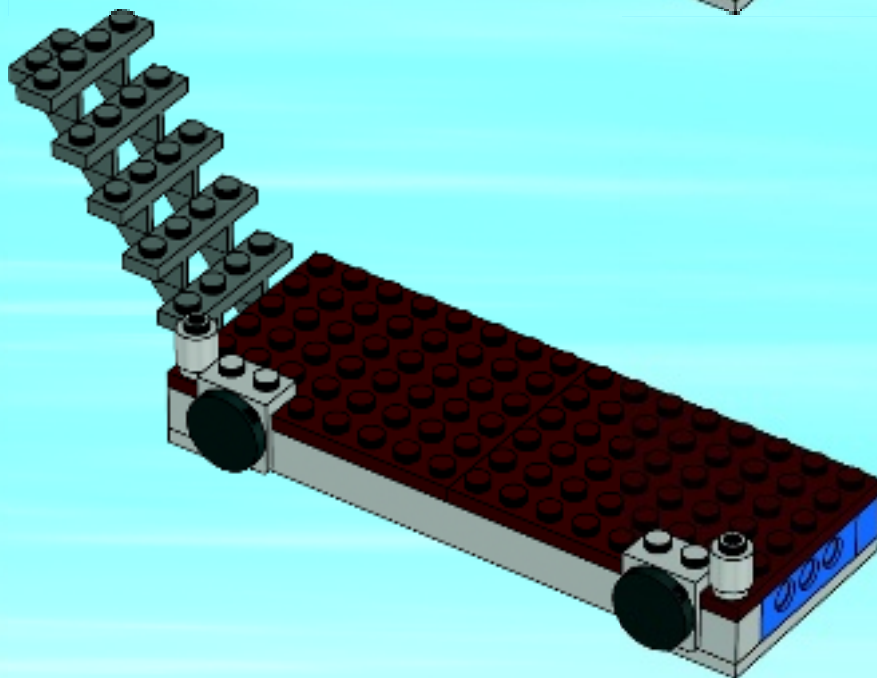

8

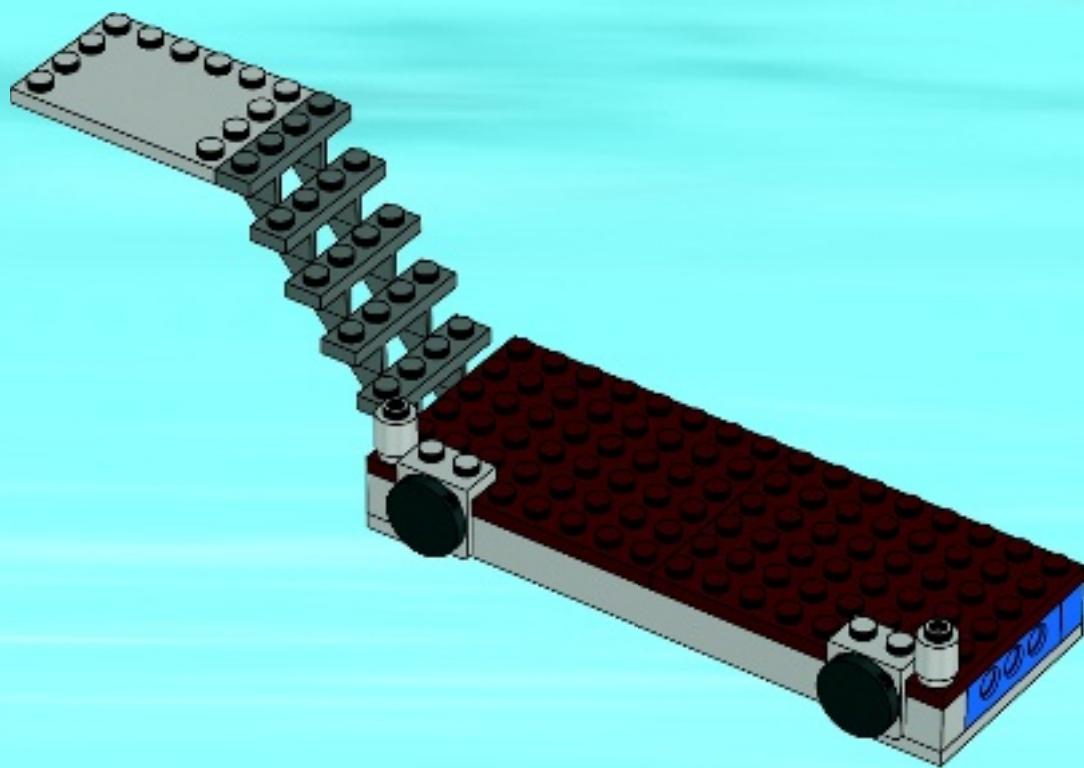

9

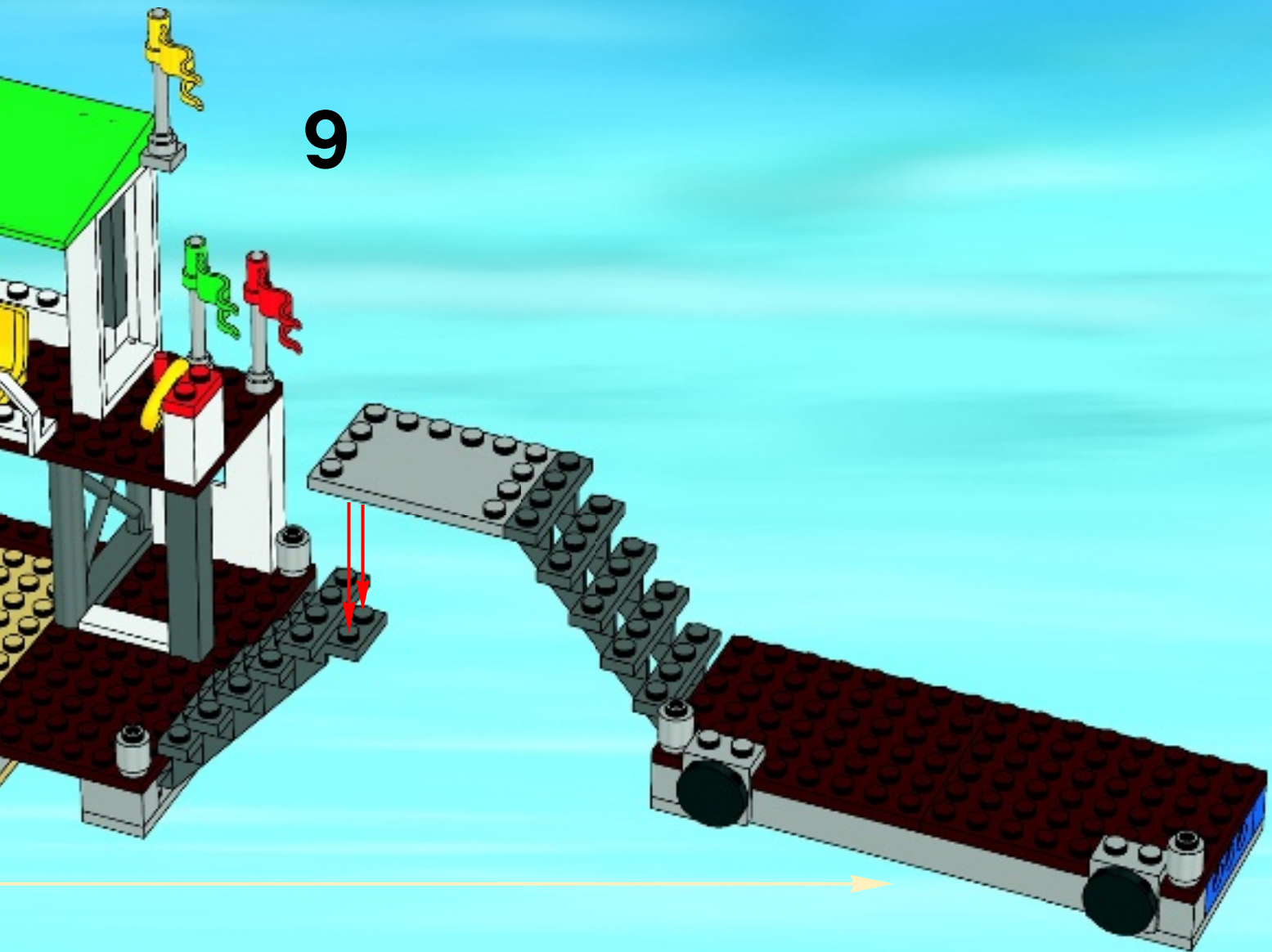

10

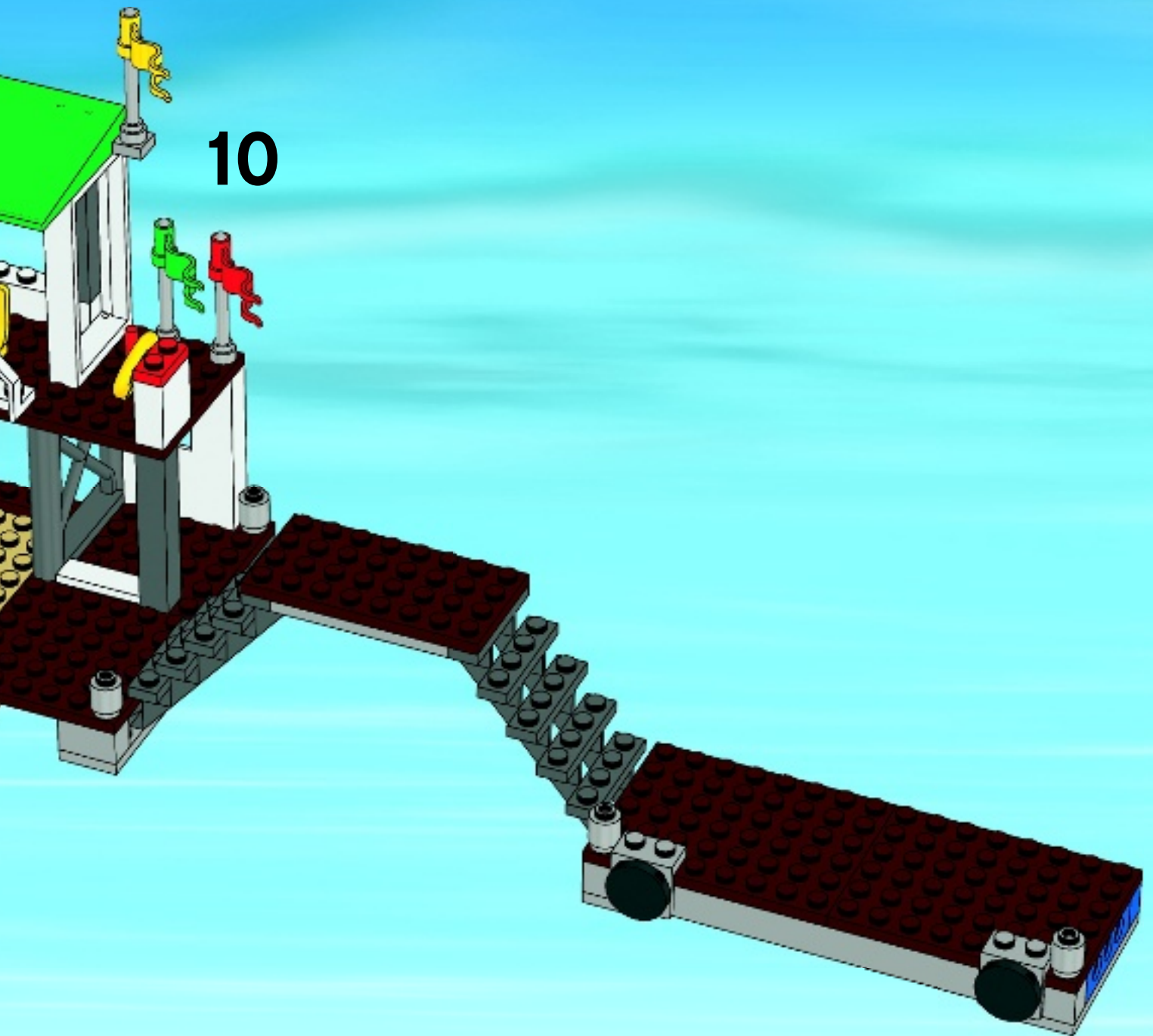

11

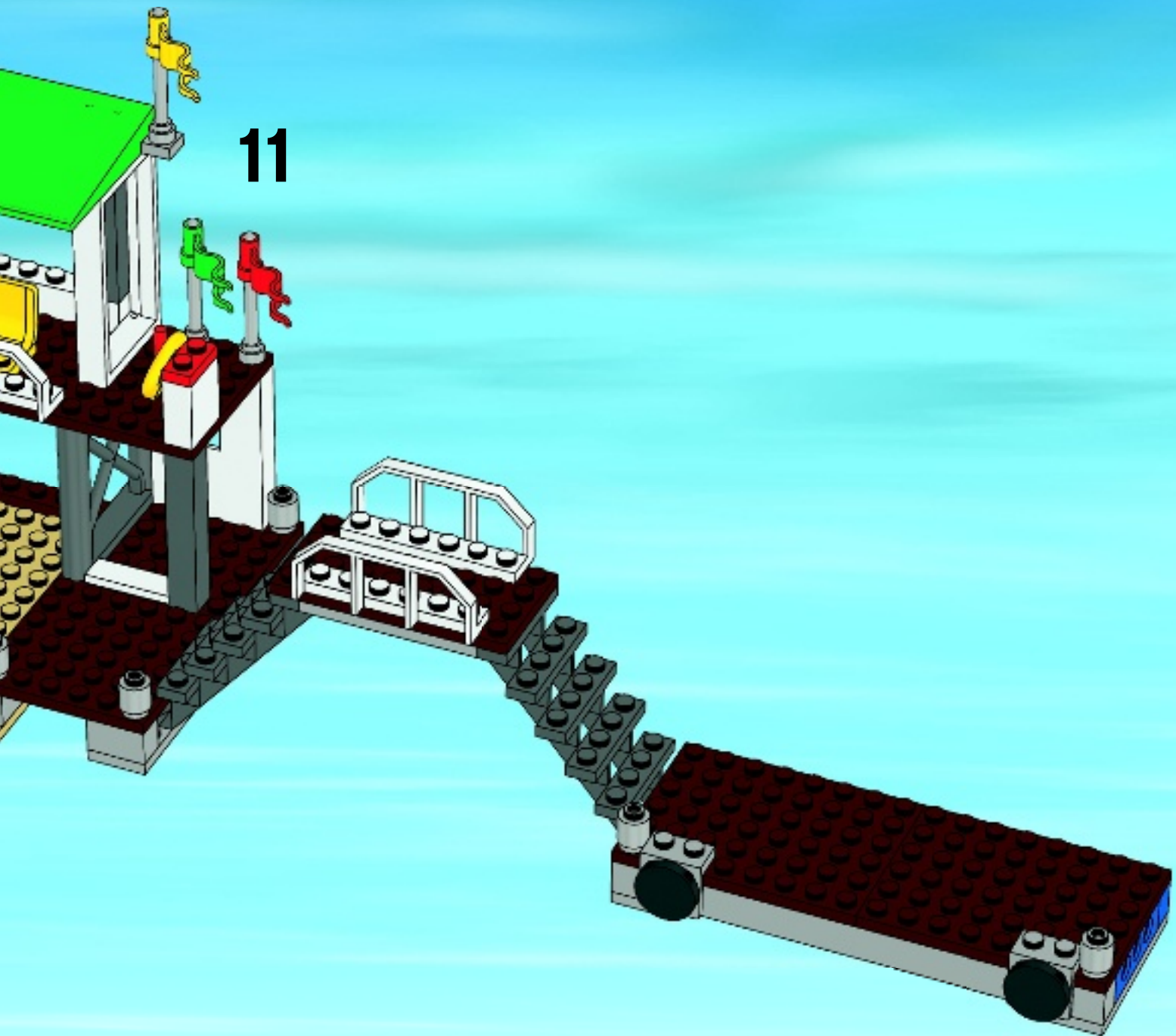

1

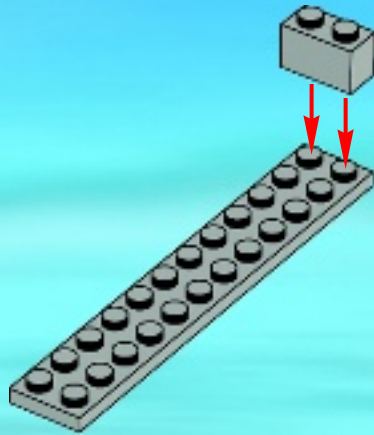

2

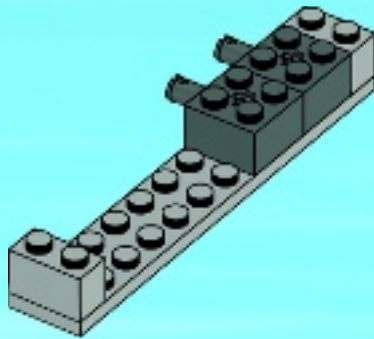

3

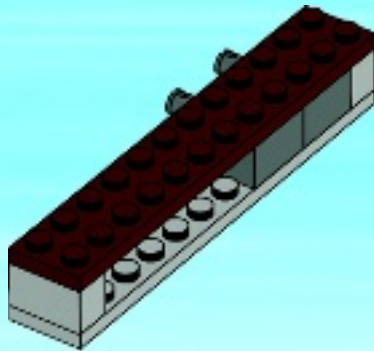

12

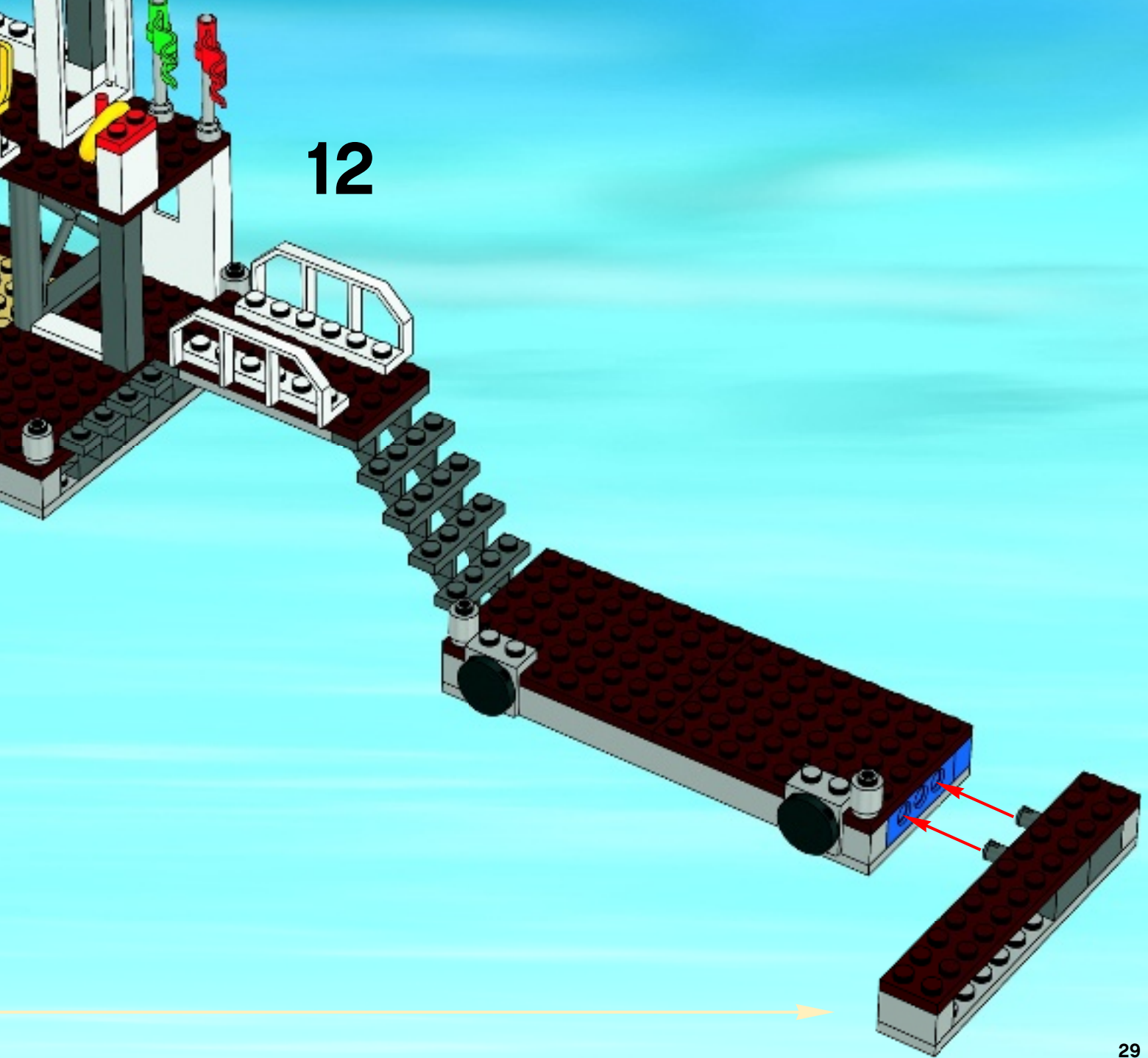

1



2



3



13

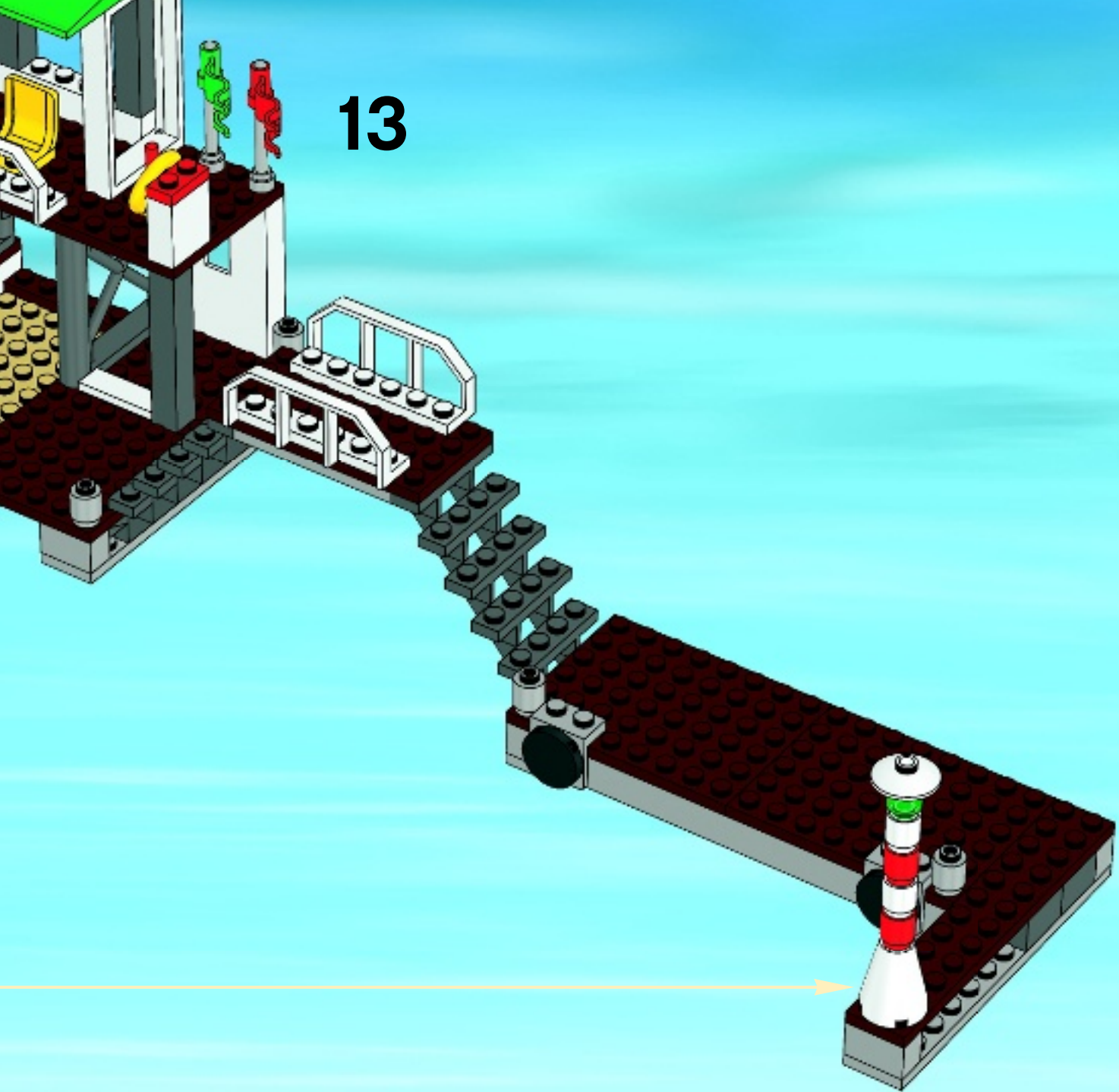



+



1

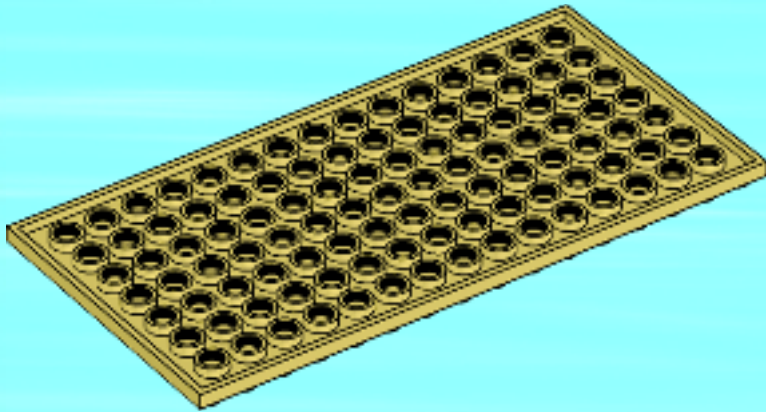

2

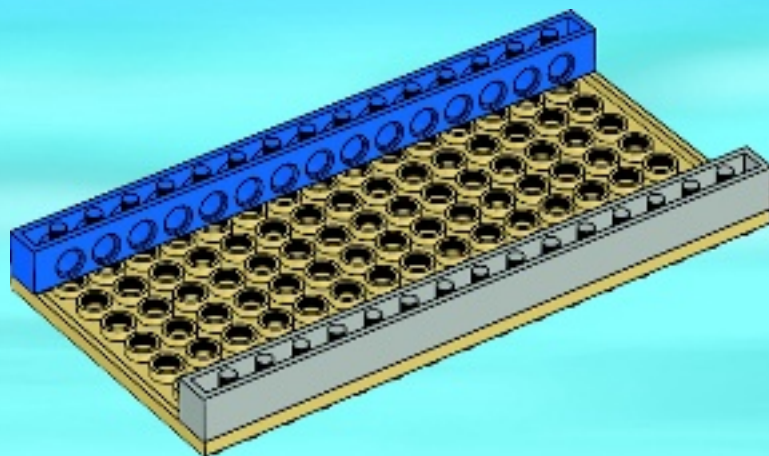

3

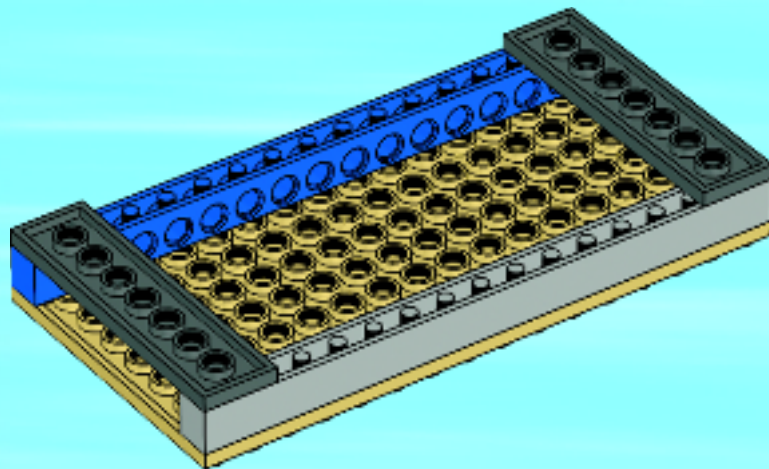

4

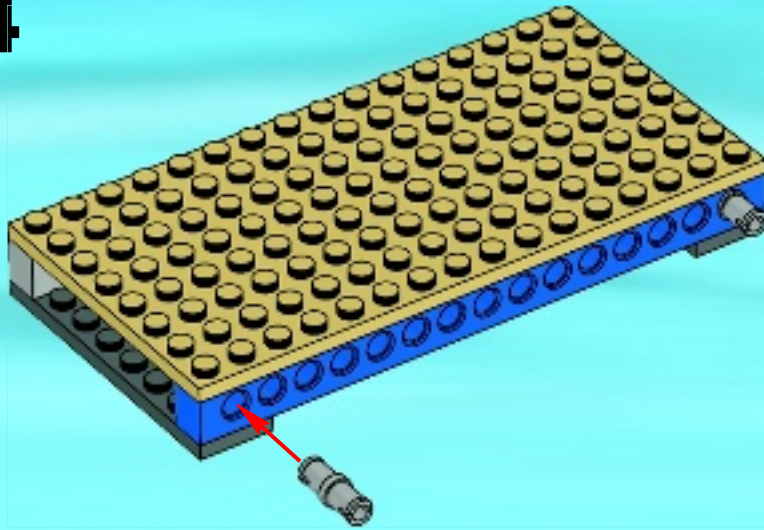

5

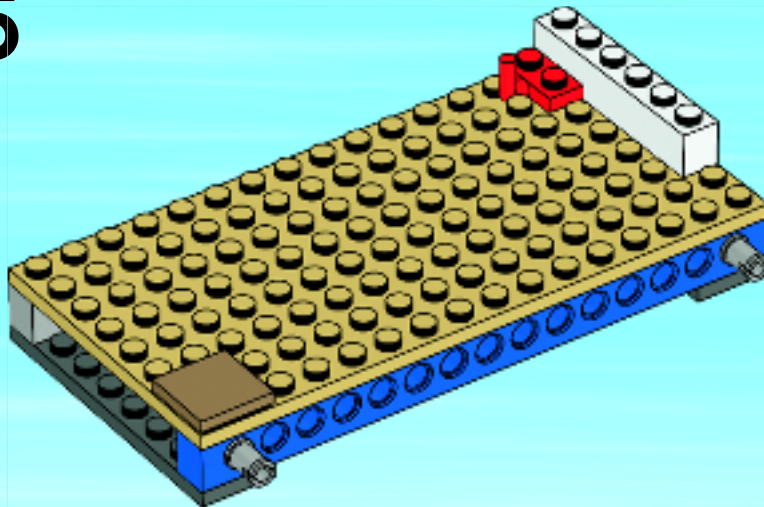

6

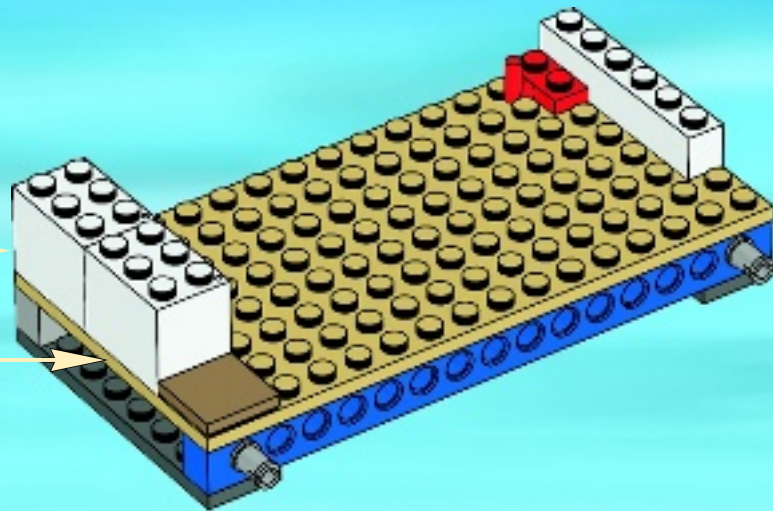
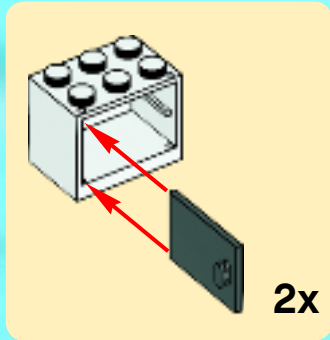

7

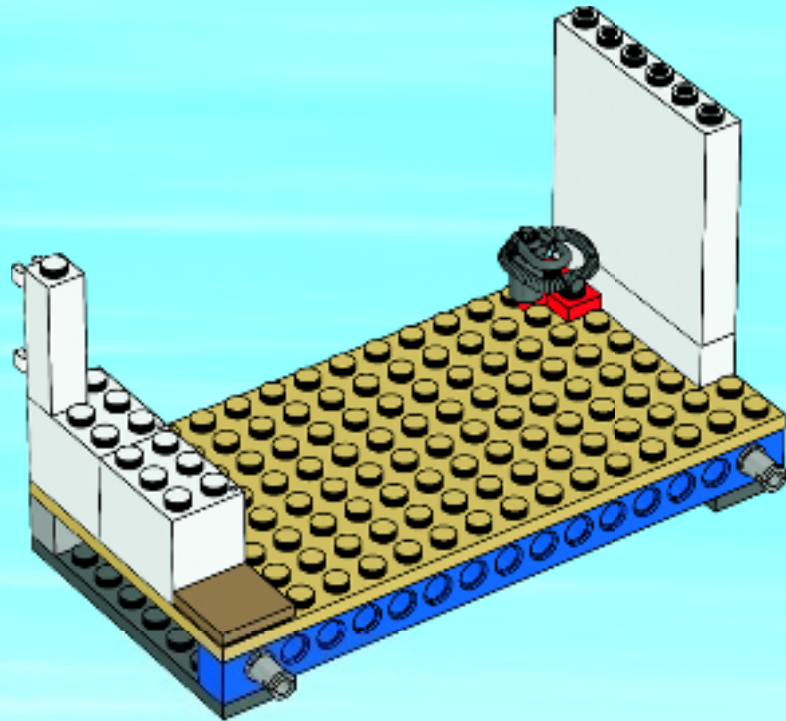

8

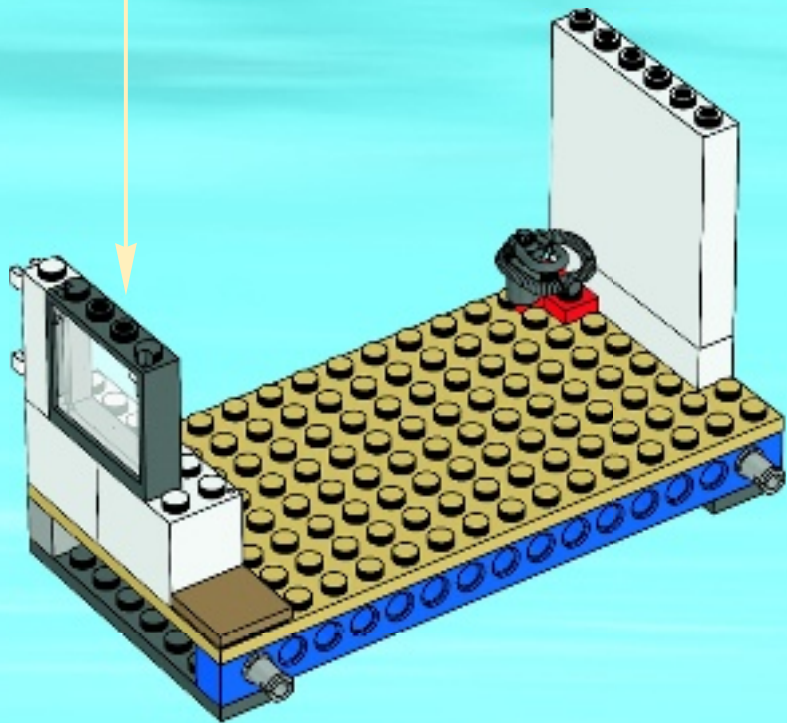
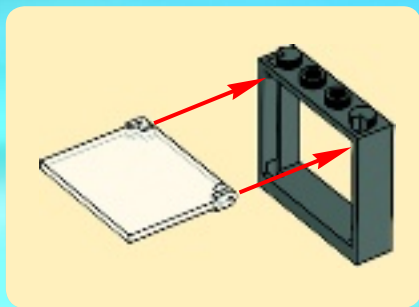

9

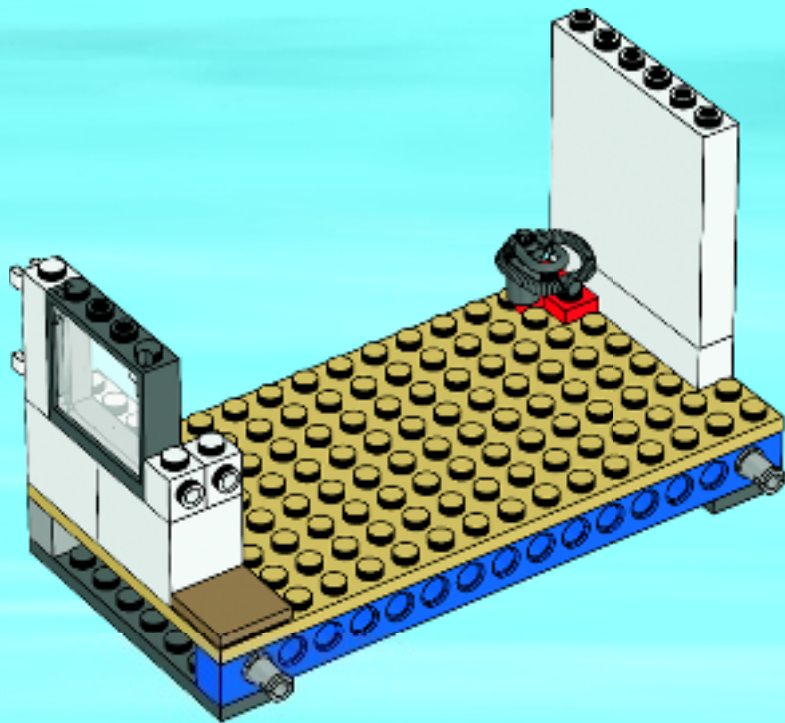

10

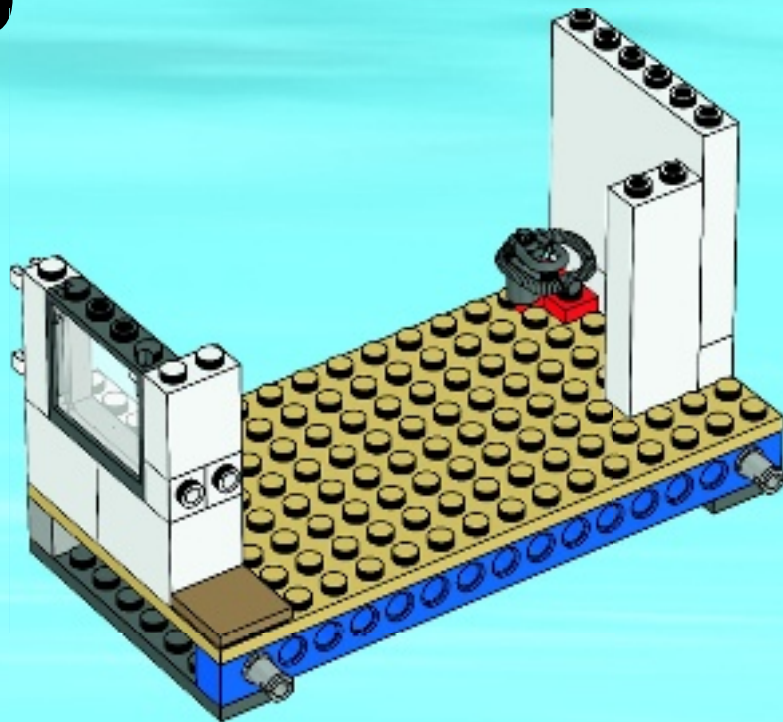

11

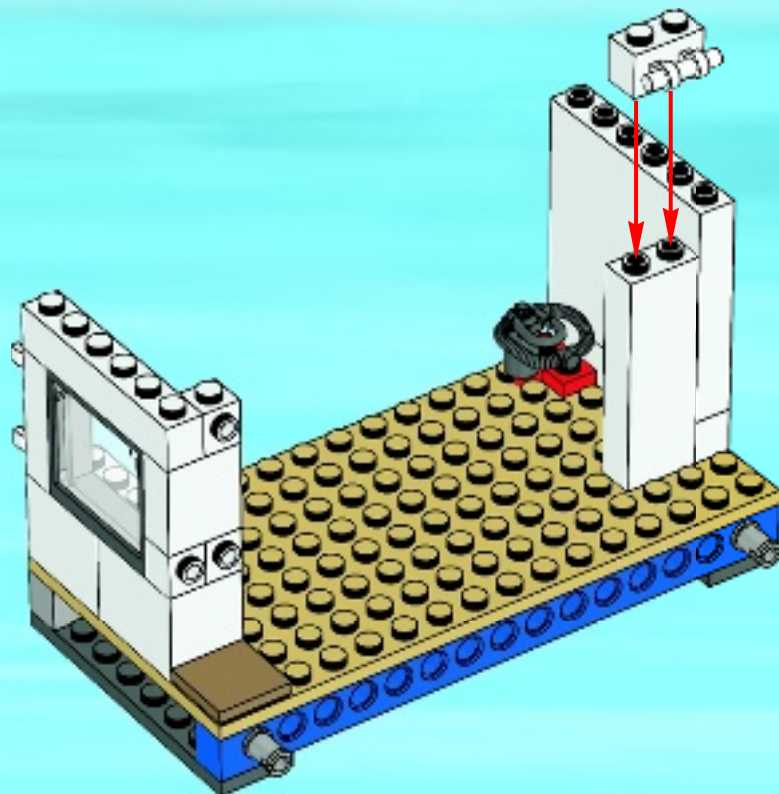

12

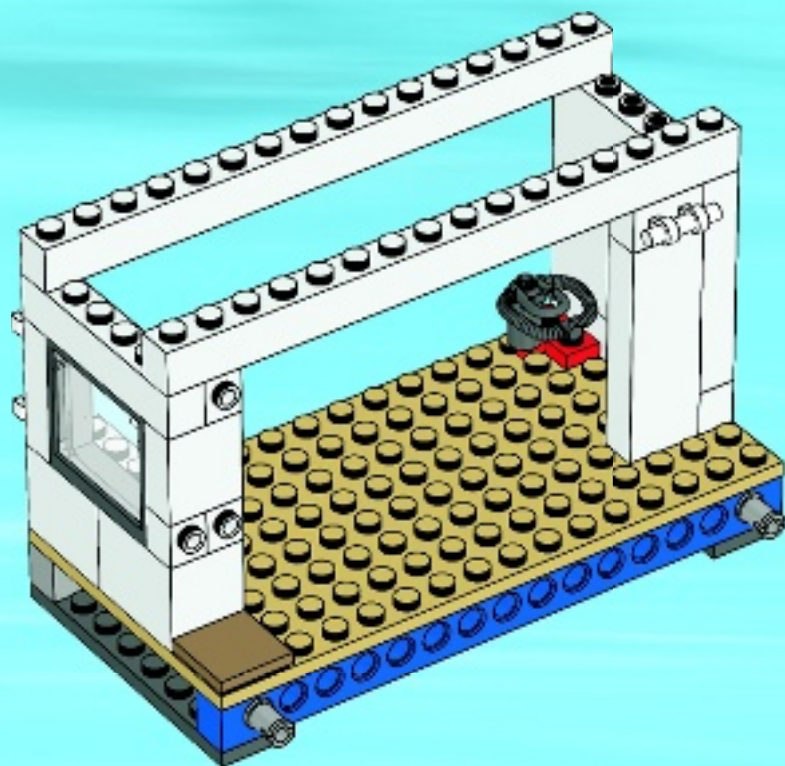

13

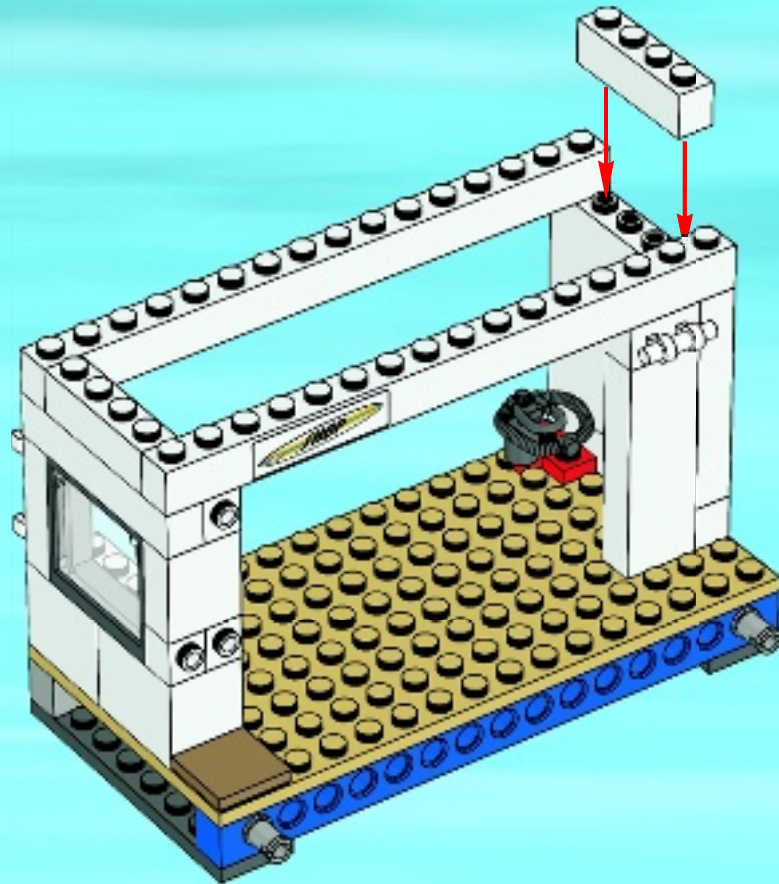

14

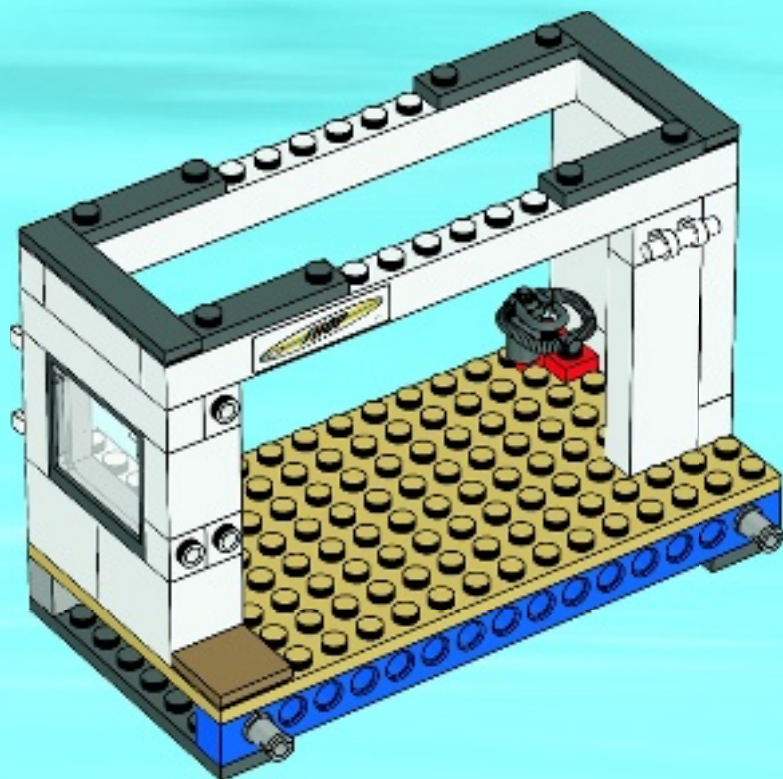

15

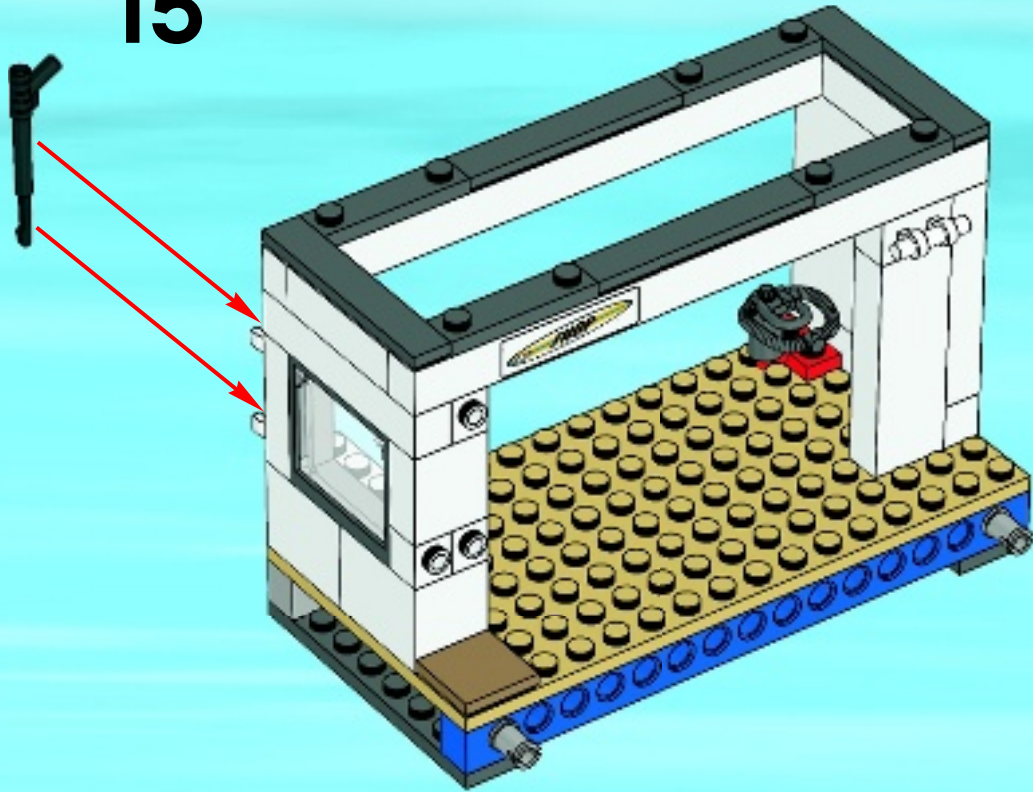

1

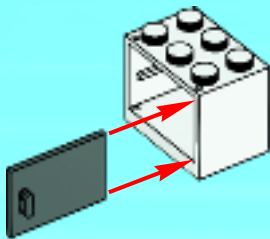

2



3

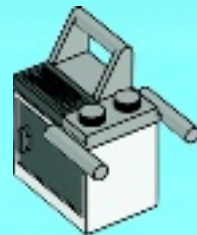

4

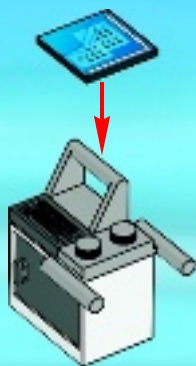

5



16

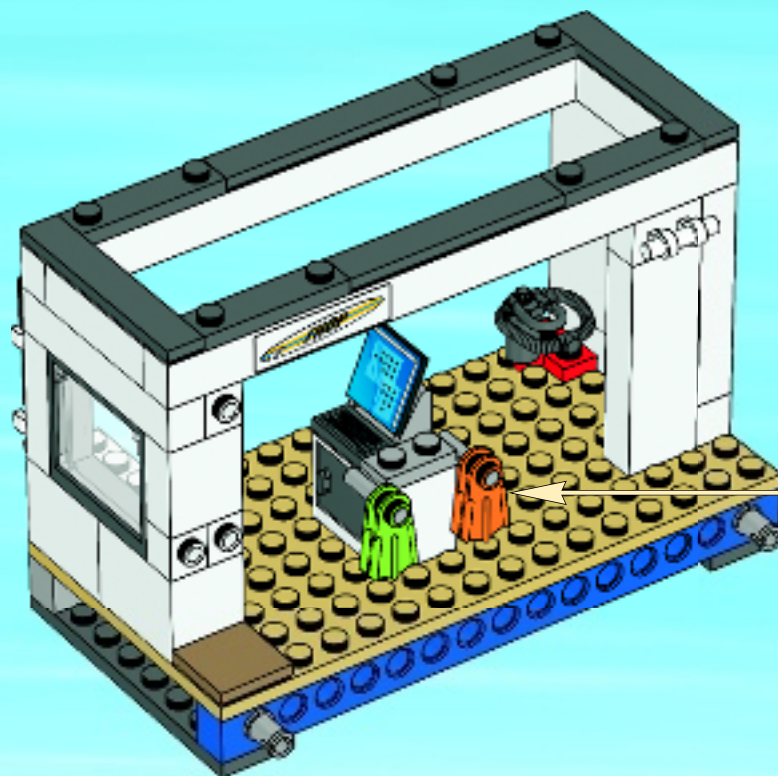

17

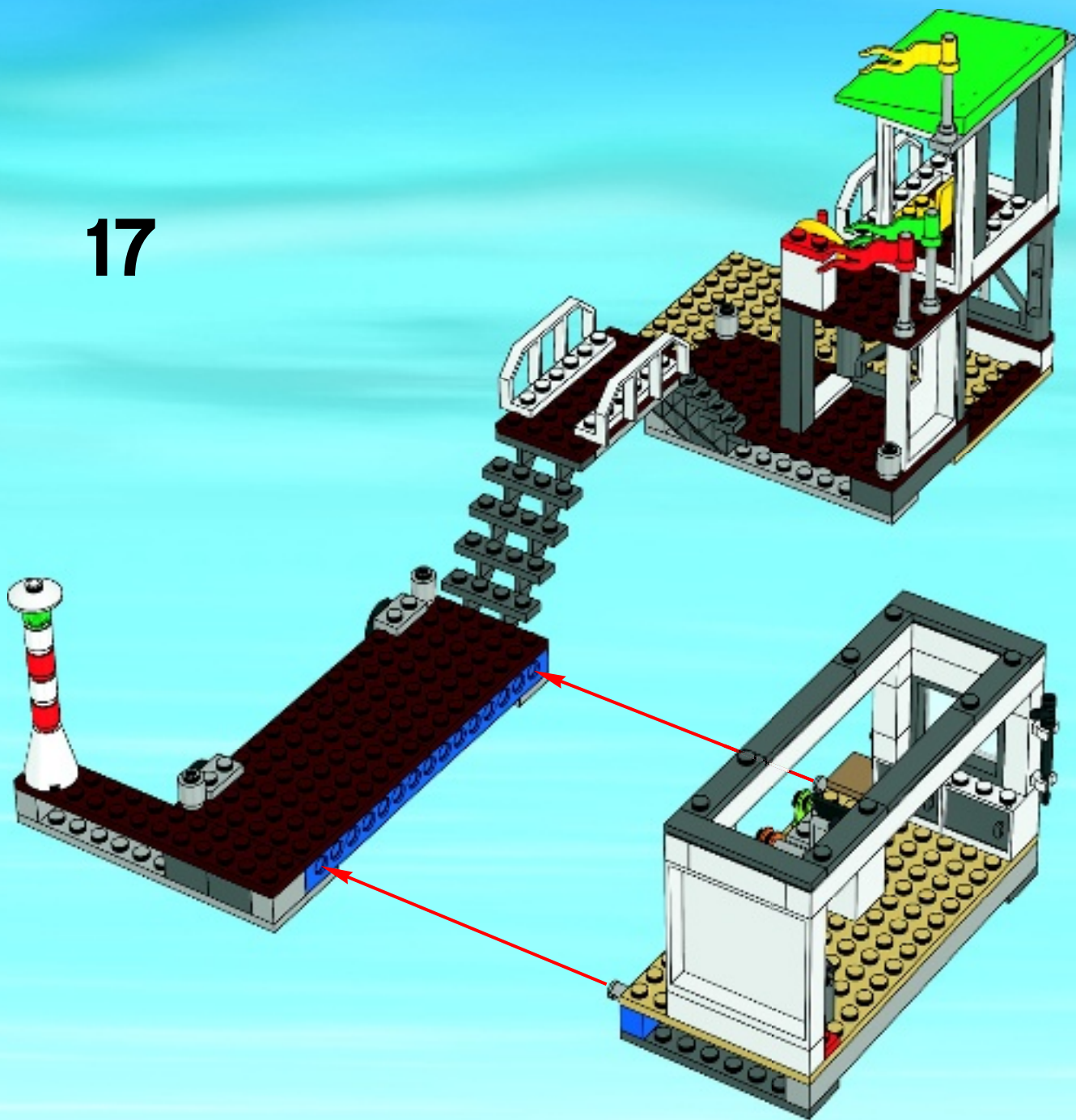

18

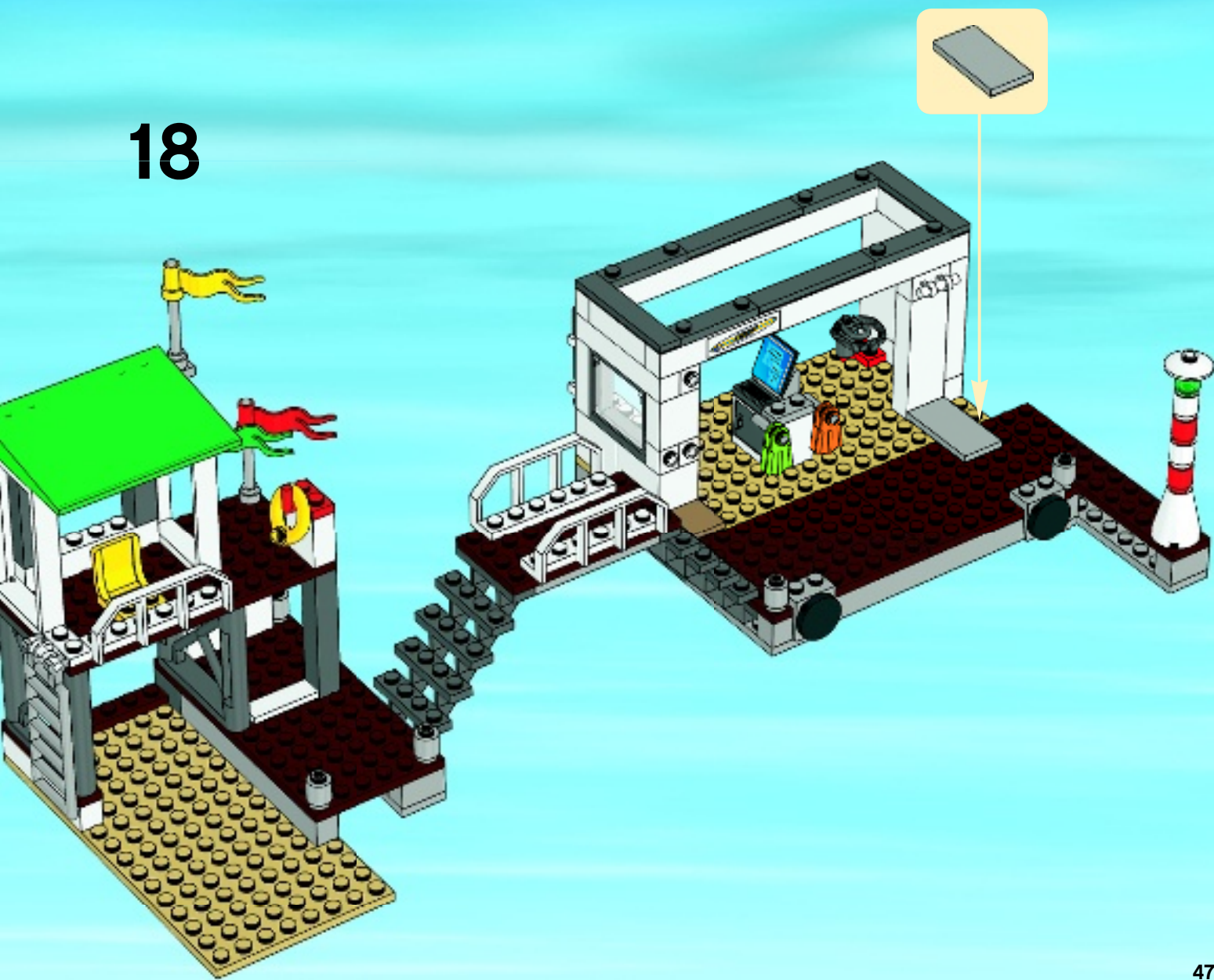

19

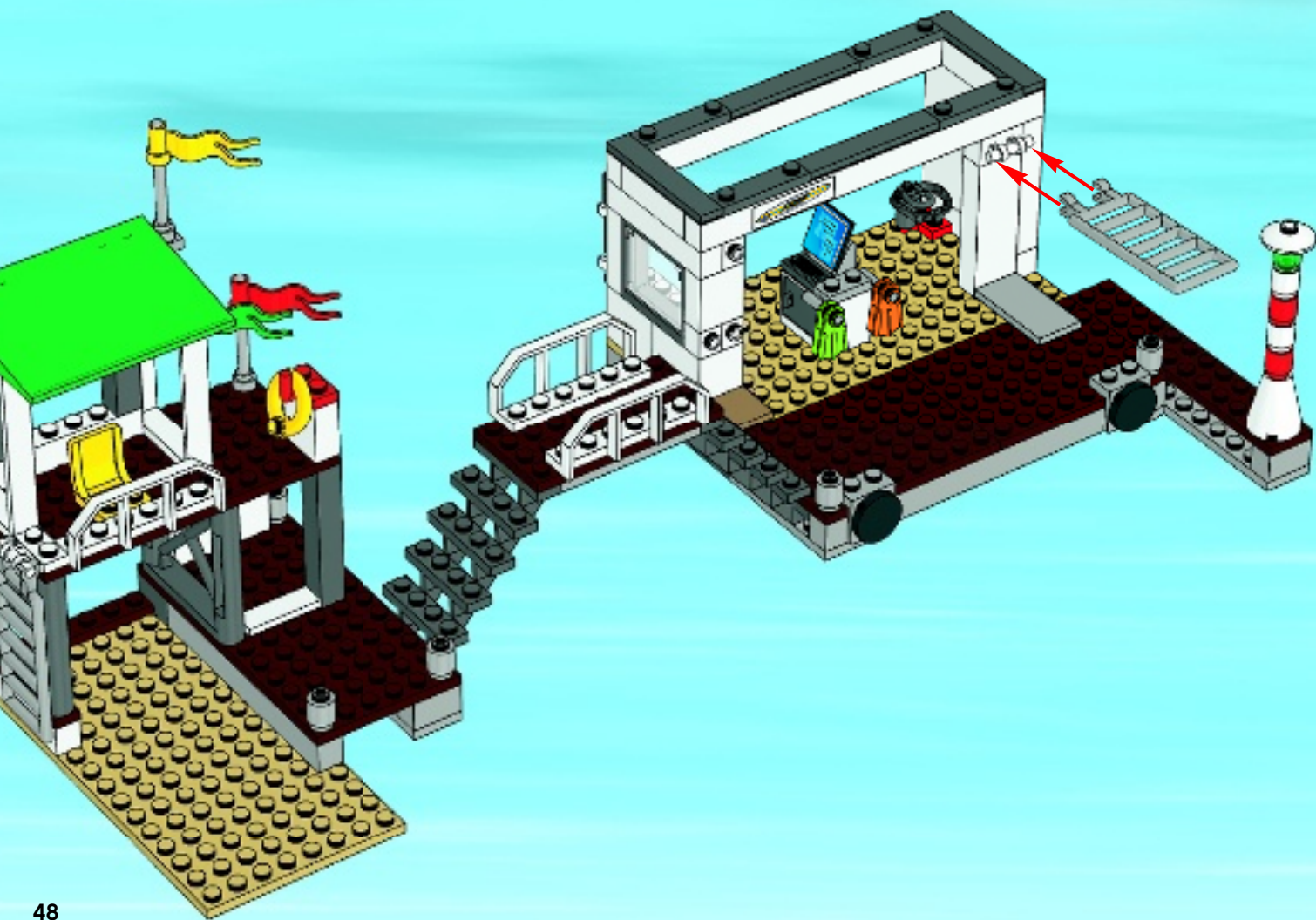

20

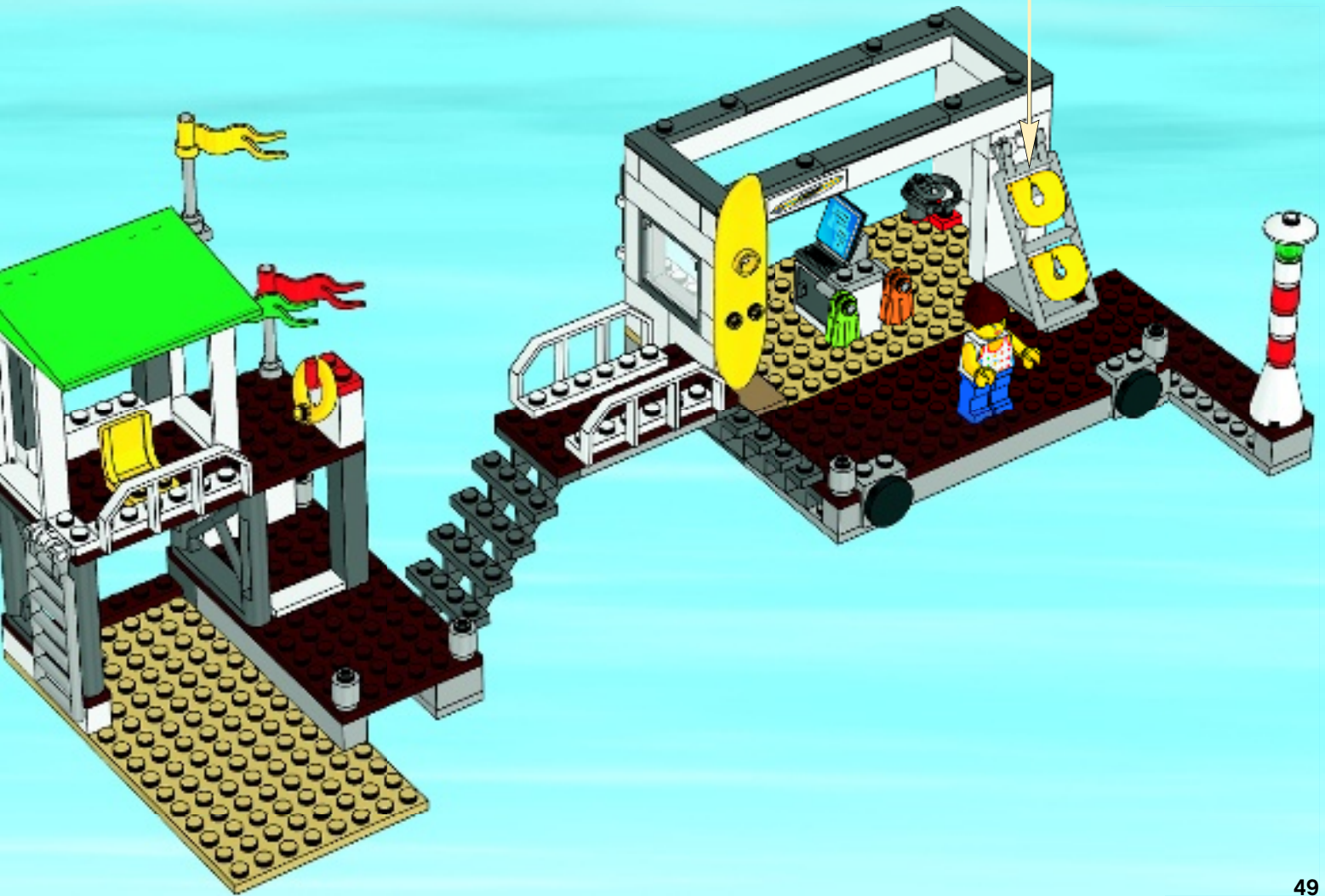
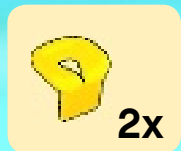



4



1

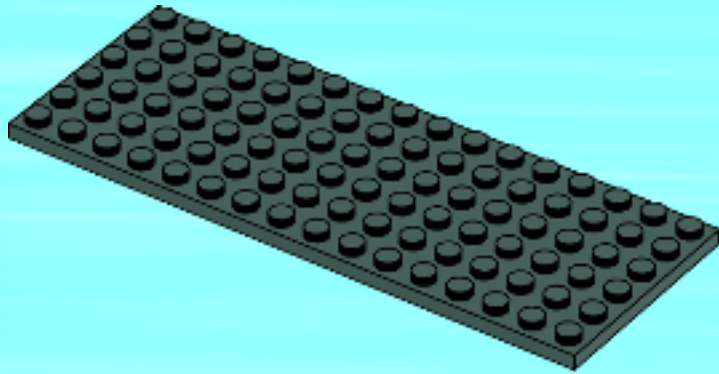

2

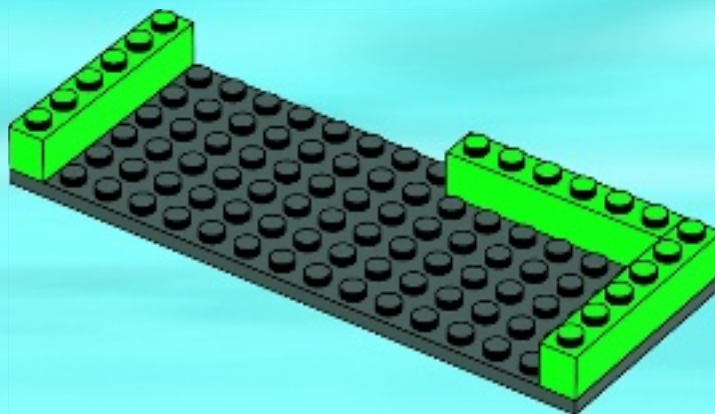

3

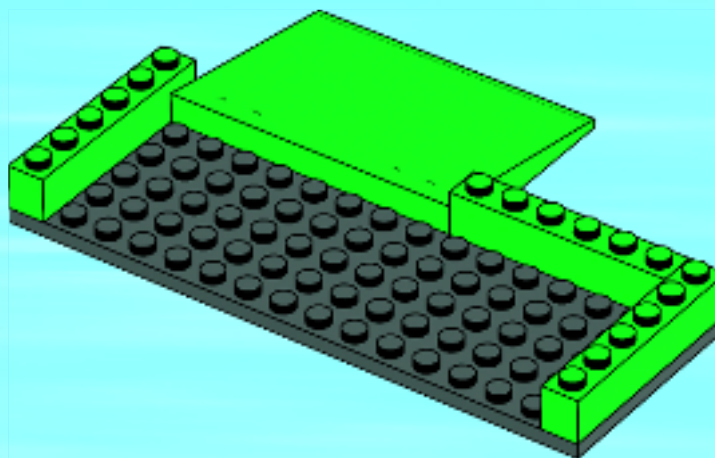

4

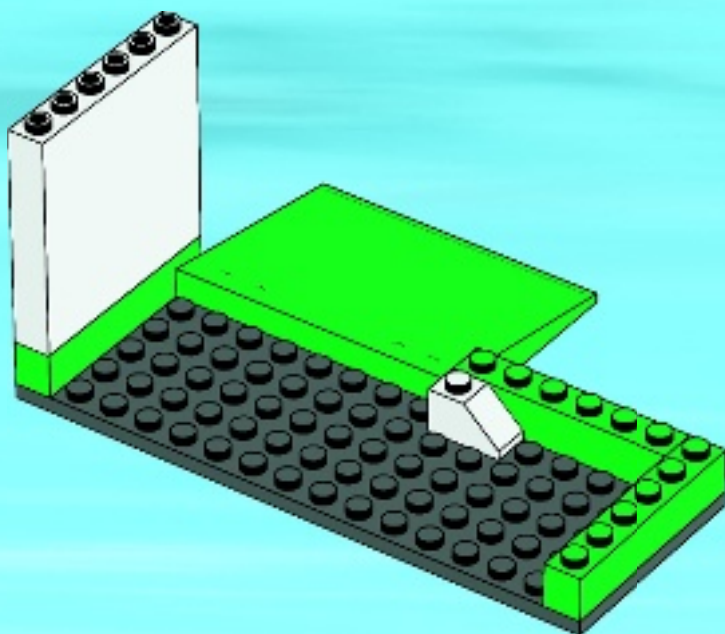

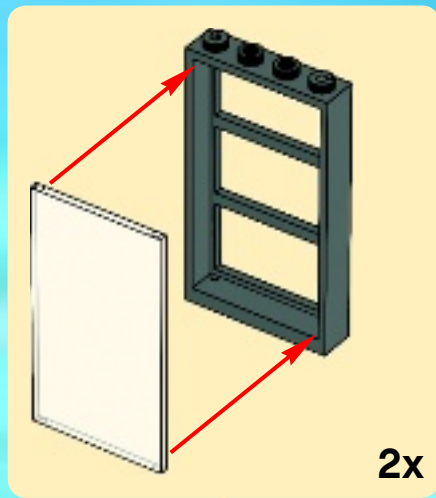

5

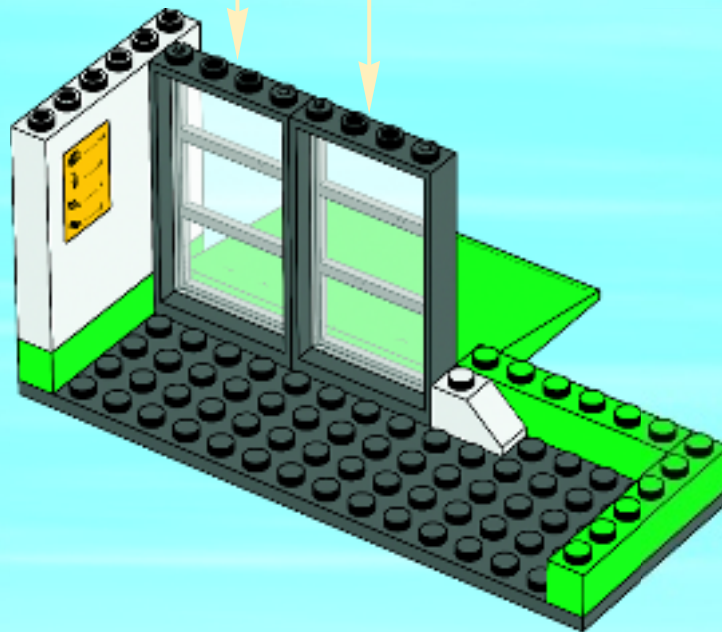

6

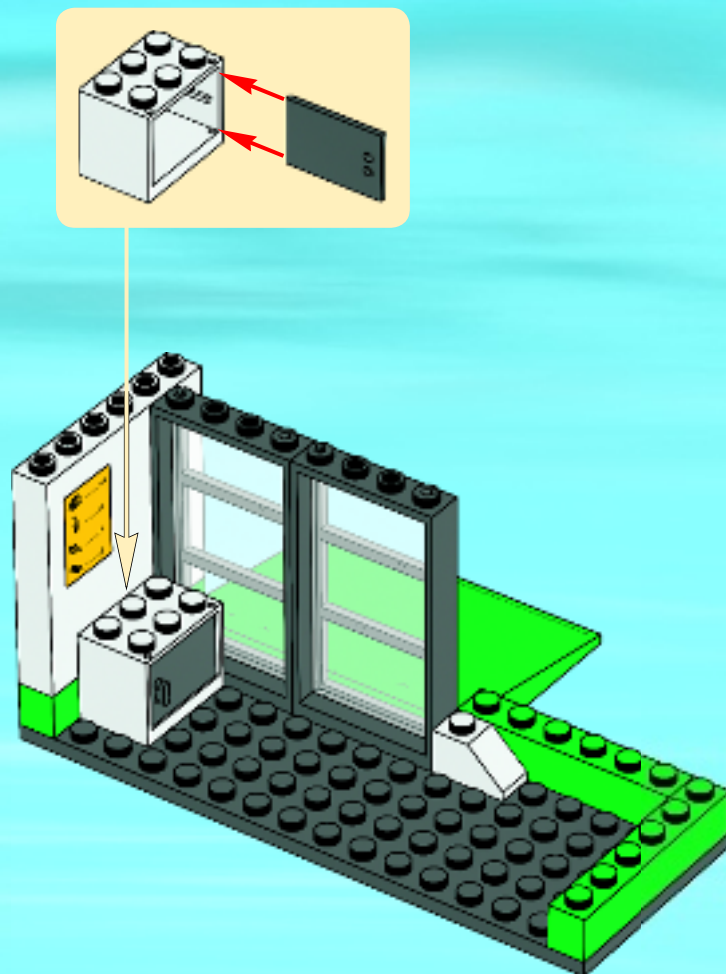

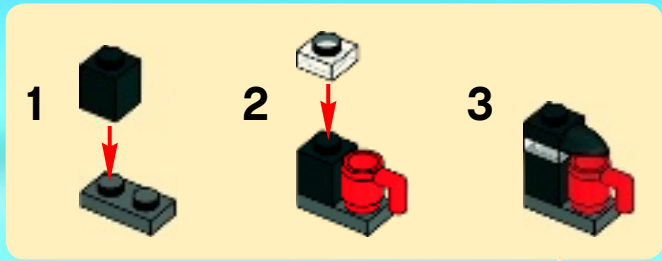

7

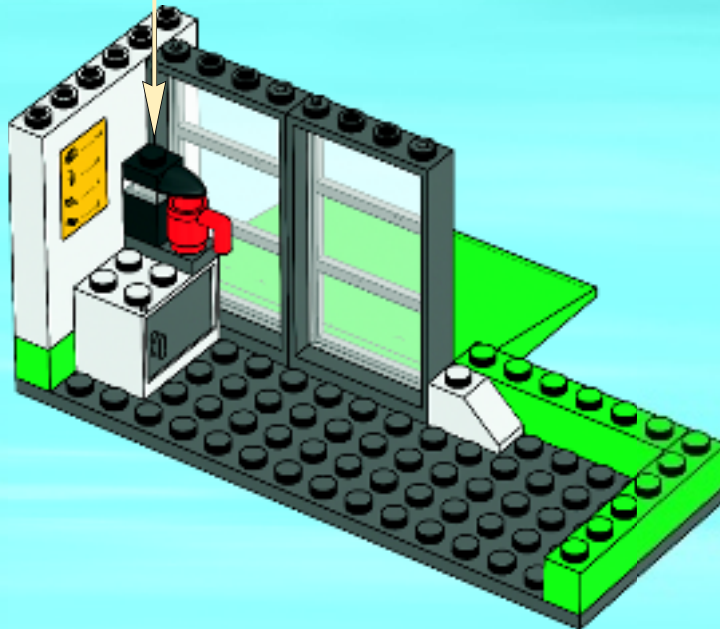

8

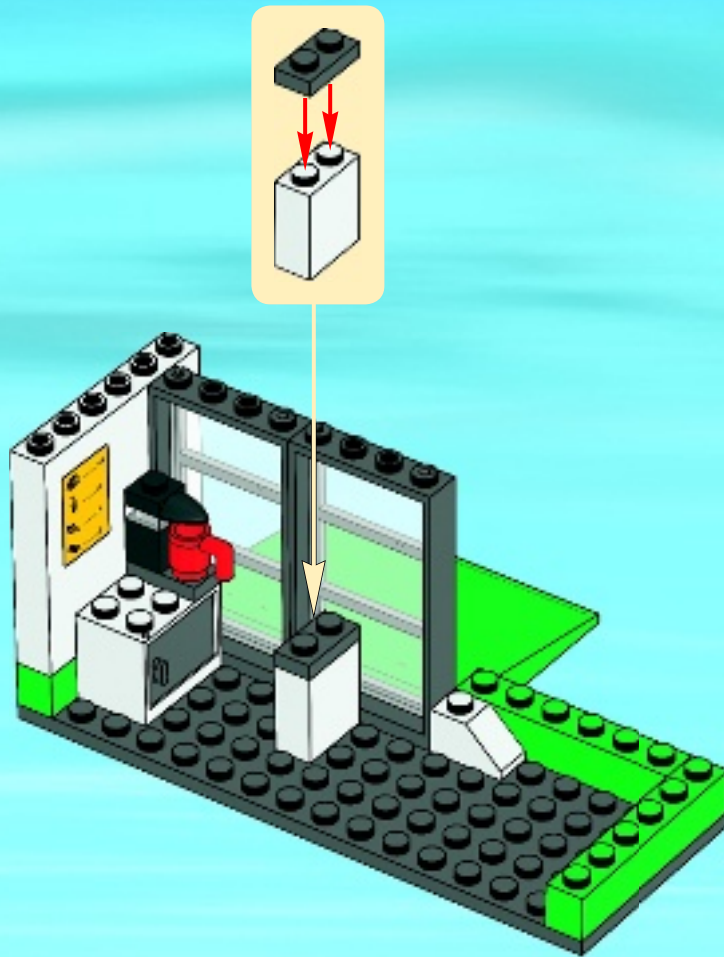

9

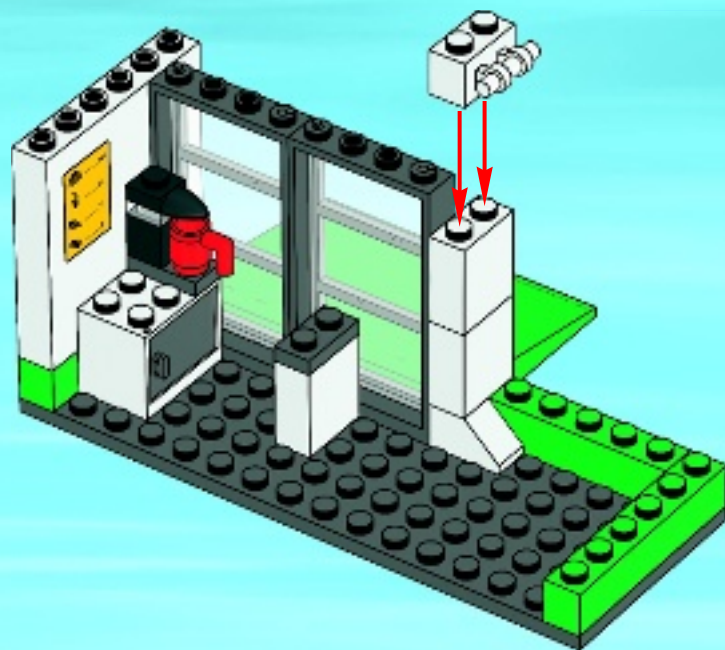

10

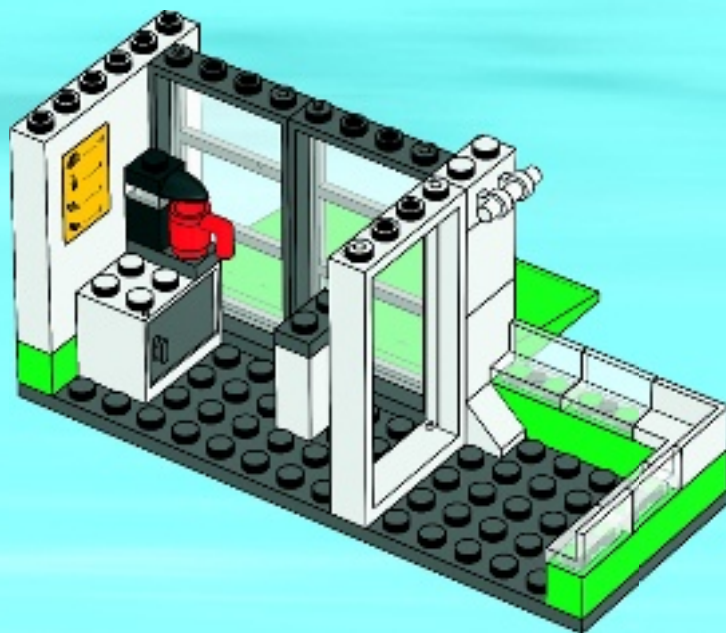

11

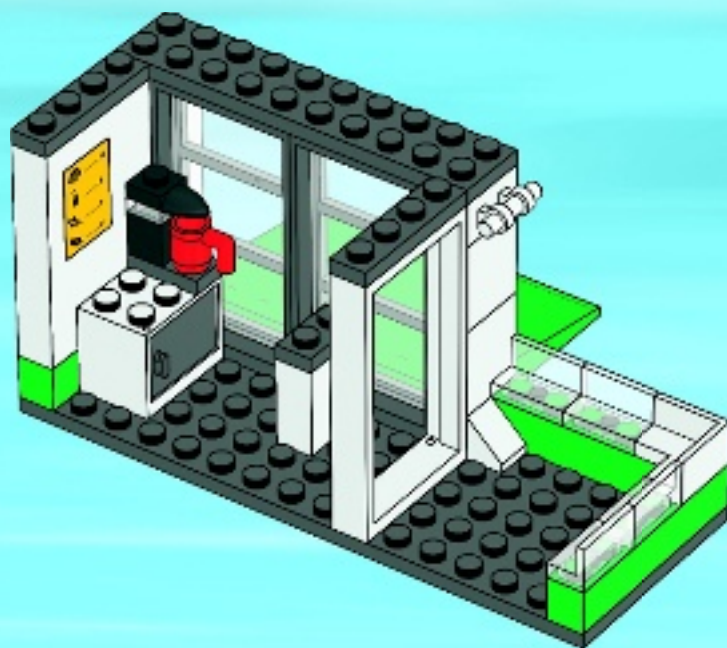

12

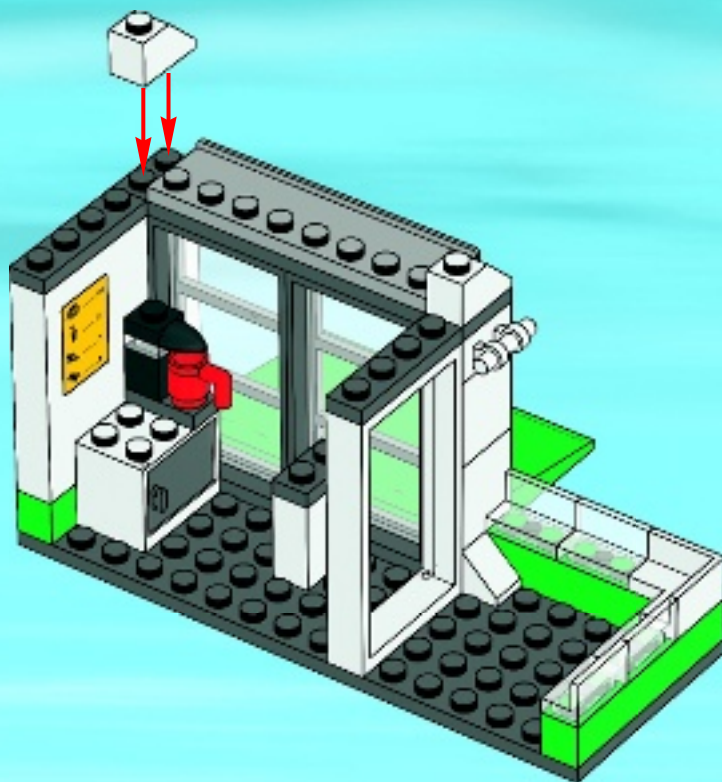

13

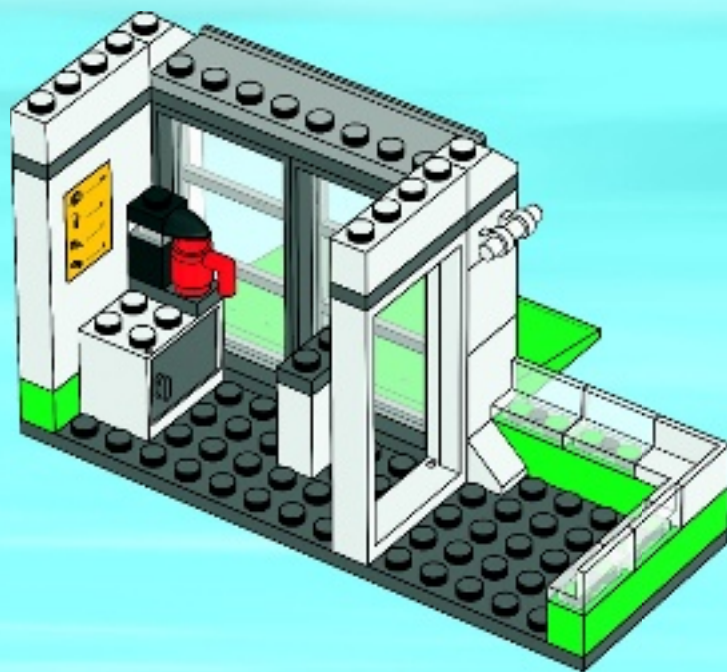

14

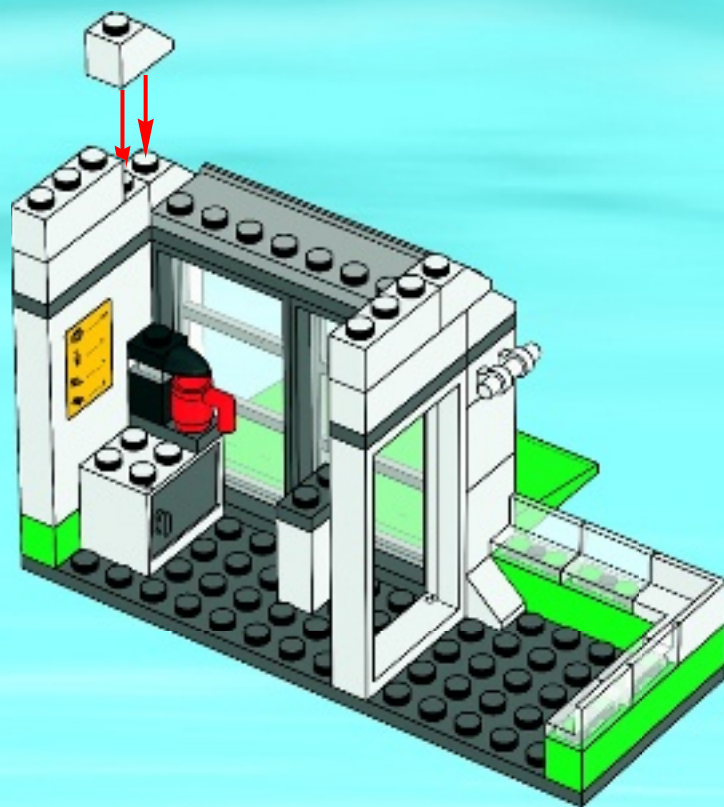

15

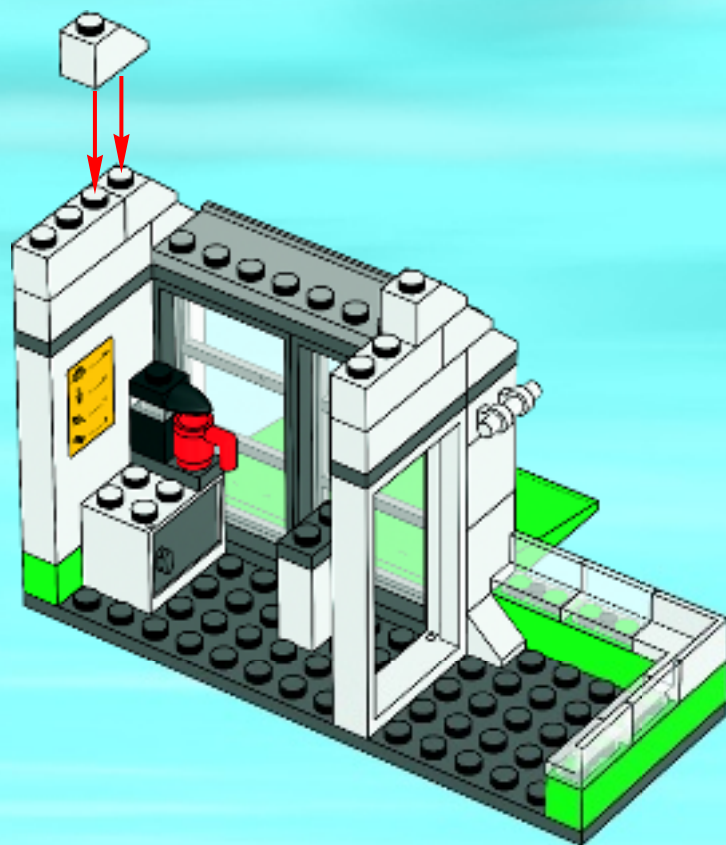

1

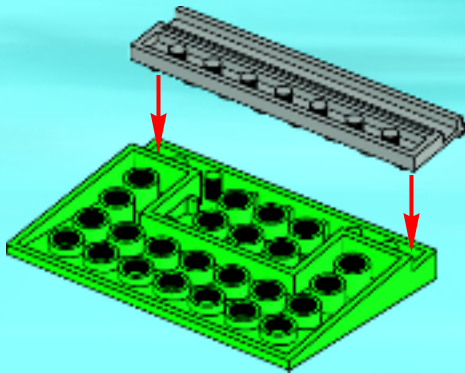

2

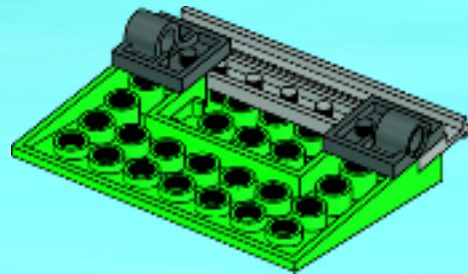

3

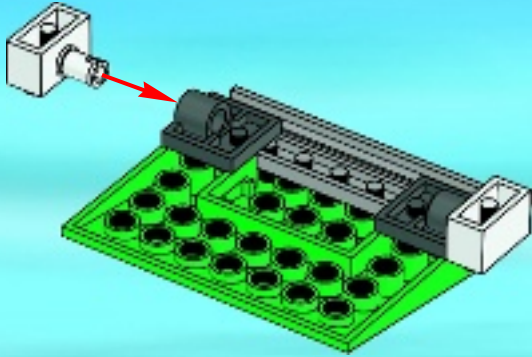

4



16

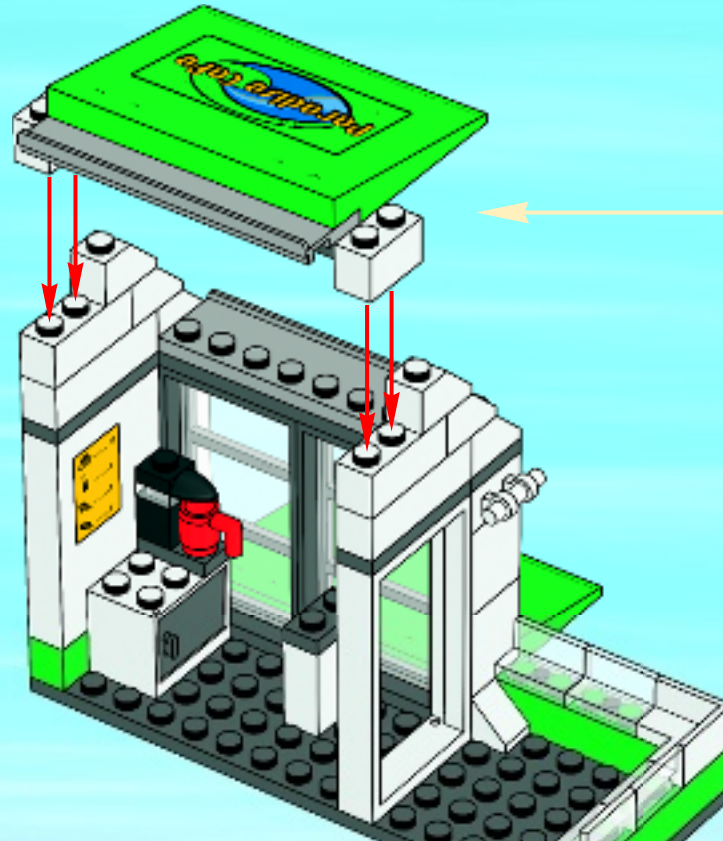

17

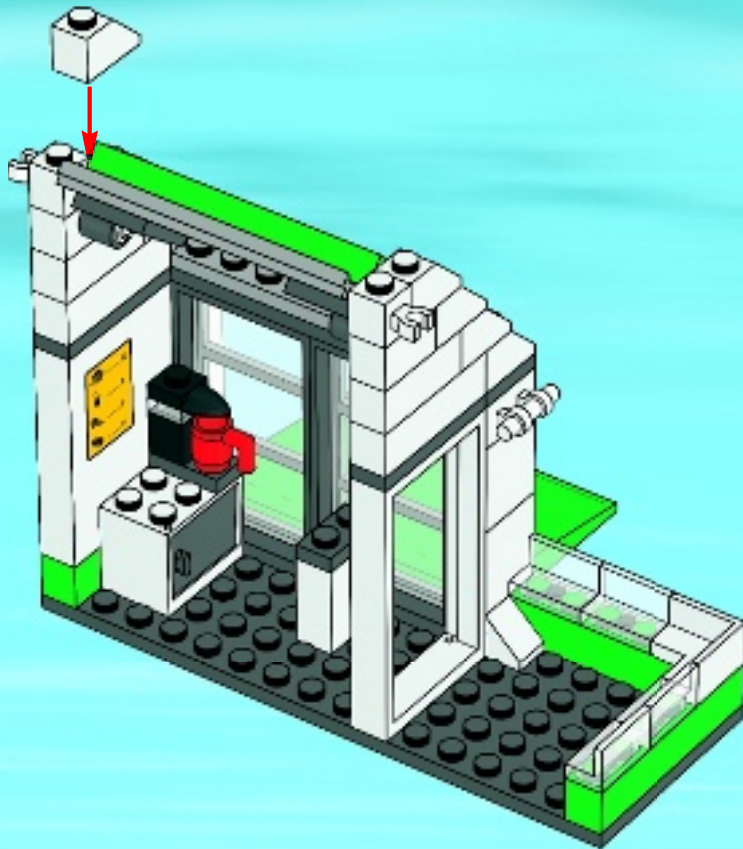

18

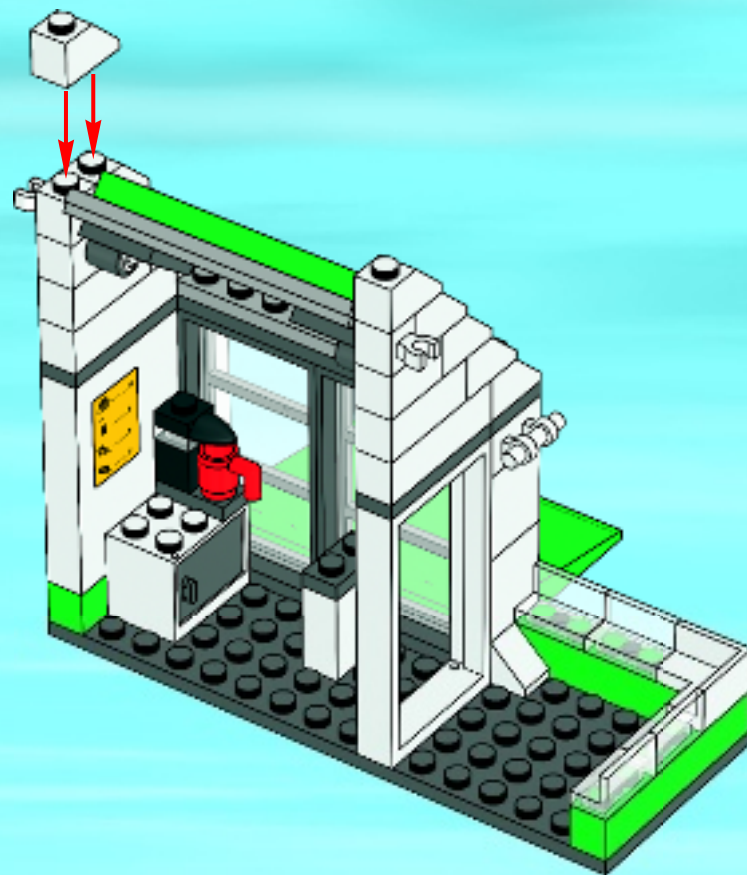

19

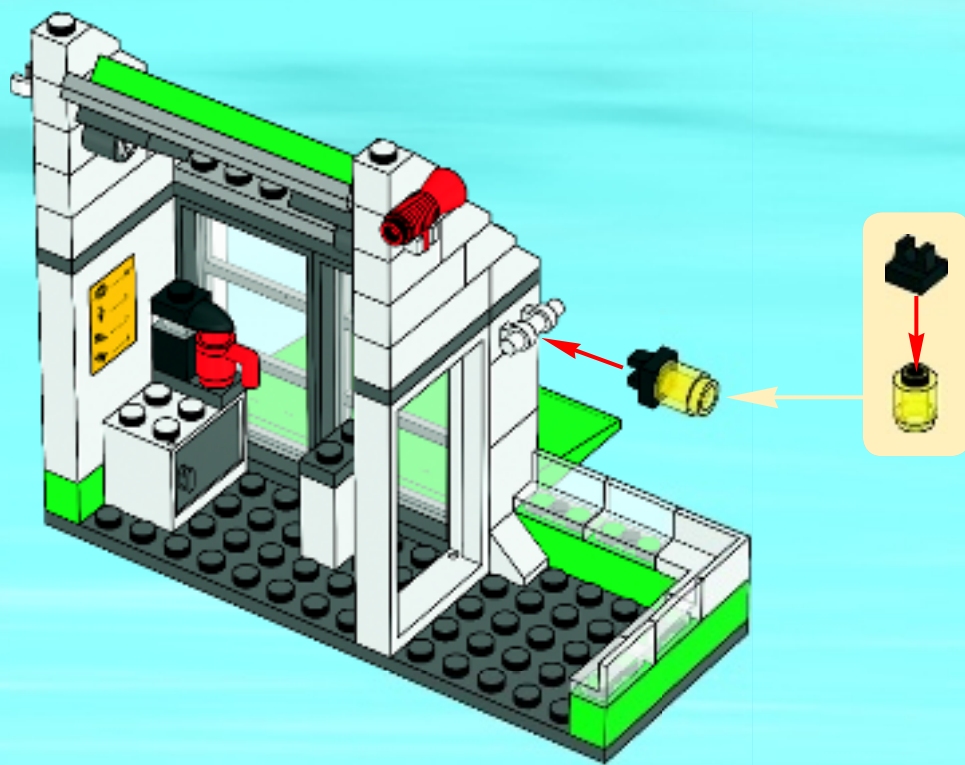

20

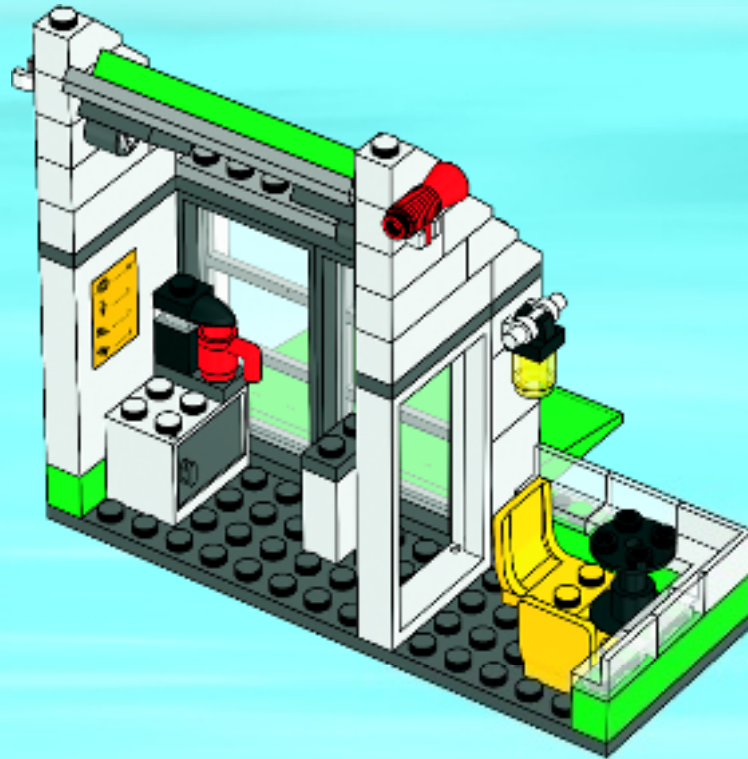

21

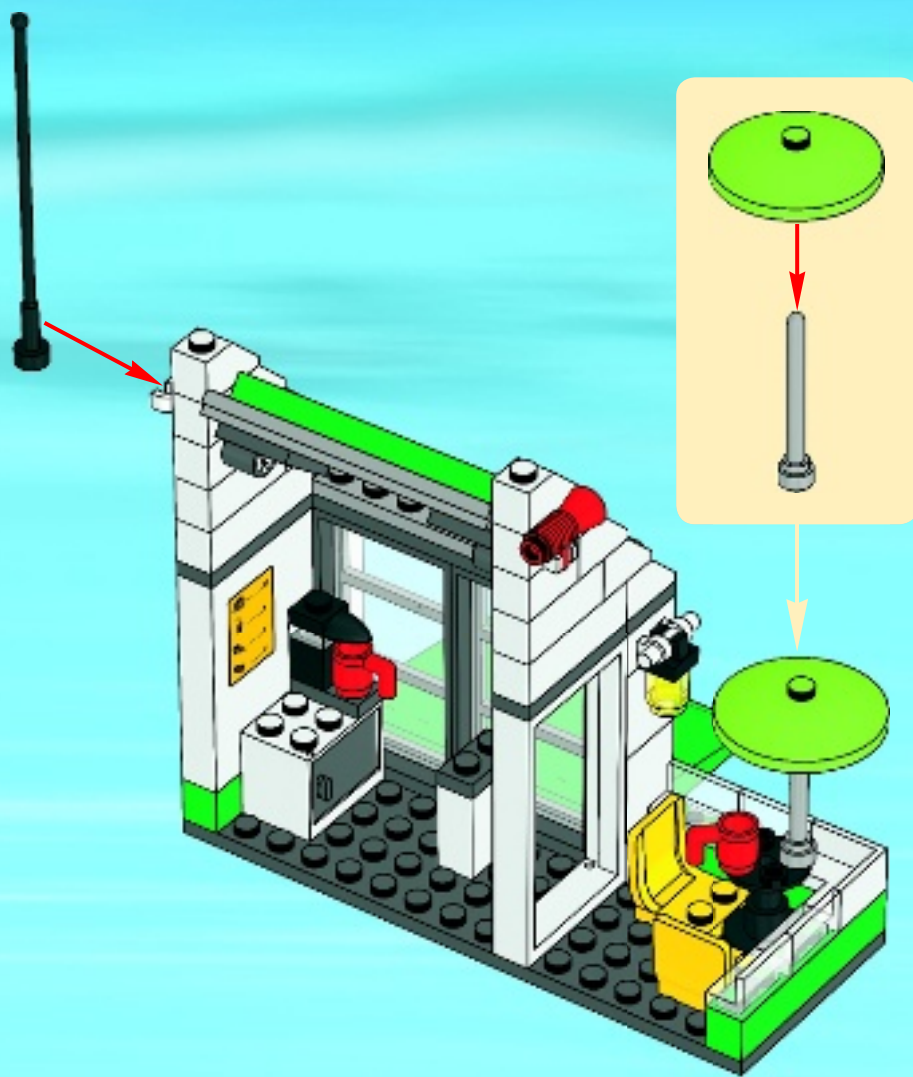

22





CITY



7279



7285



7286



7287



7288



7498

LEGO CITY

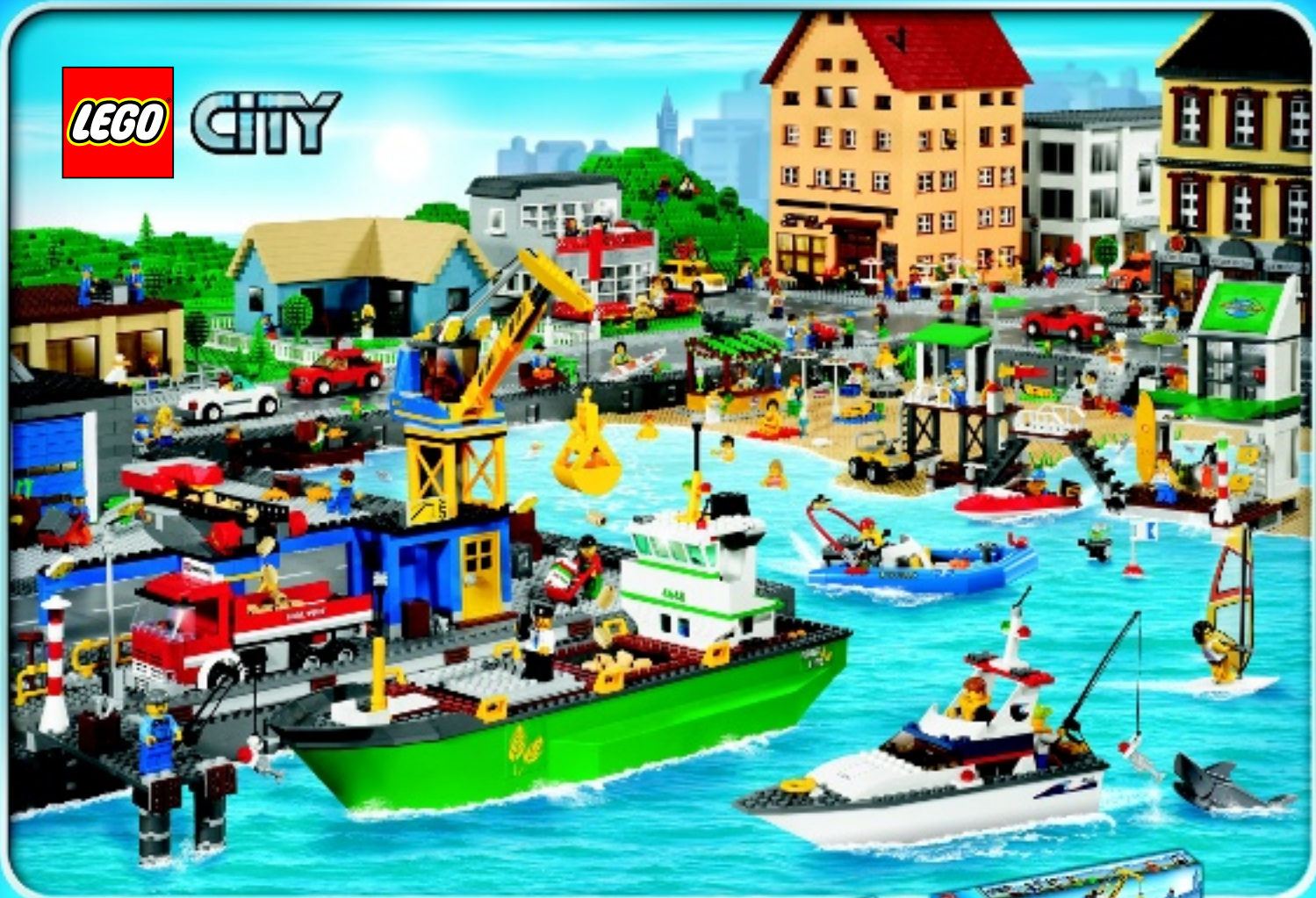

4641



4642



4643



4644



4645



7x
4113261



1x
245401



2x
4160228



2x
4140626



2x
306201



3x
4558952



2x
4533763



1x
4563684



2x
362201



4x
301001



4x
300901



2x
246501



2x
246501

74



1x
394201



11x
4121932



1x
4234525



1x
4288083



1x
4558168



2x
486501



1x
4610290



1x
4140583



1x
474001



4x
4619665



3x
4541956



2x
4504228



3x
4612145



1x
4523403



1x
4612153



1x
4549988



1x
4570026



1x
4528413



1x
9551



1x
4567890



1x
4538625



2x
4504228



2x
4609726



2x
4609726



2x
4609726



2x
4609726

2x
4609726



1x
4216657



3x
241221



1x
434921



2x
4171662



1x
449521



1x
4562544



2x
389921



10x
4611701



2x
306221



1x
4612138



1x
379424



2x
4283123

2x
4609726

2x
4609726

2x
4609726

2x
4609726

2x
4609726

2x
4609726



6x
407924



1x
4593753



1x
74333



1x
4194017



1x
4261572



1x
4610938



1x
4570664



1x
4586454



1x
4527354



3x
4260843



1x
4550738



3x
4612143

3x
4612143

3x
4612143

3x
4612143

3x
4612143

3x
4612143

3x
4612143



3x
4111844



1x
449528



1x
3003941



2x
4499885



1x
3006844



1x
3006848



1x
4216384



1x
370123



2x
9341



1x
4567909



2x
370323

2x
370323

2x
370323

2x
370323

2x
370323

2x
370323

2x
370323

2x
370323

2x
370323



1x
300526



5x
302226



2x
255526



1x
394026



2x
460026



2x
415026



1x
474026



1x
4547041



1x
256926



2x
4570199



1x
4568933



1x
4273590

1x
4273590

1x
4273590

1x
4273590

1x
4273590

1x
4273590

1x
4273590

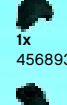
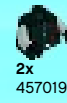
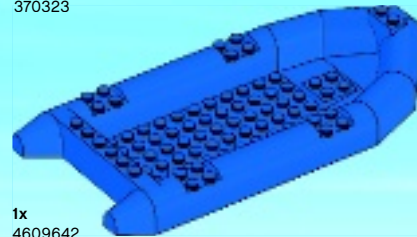
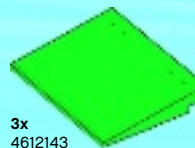

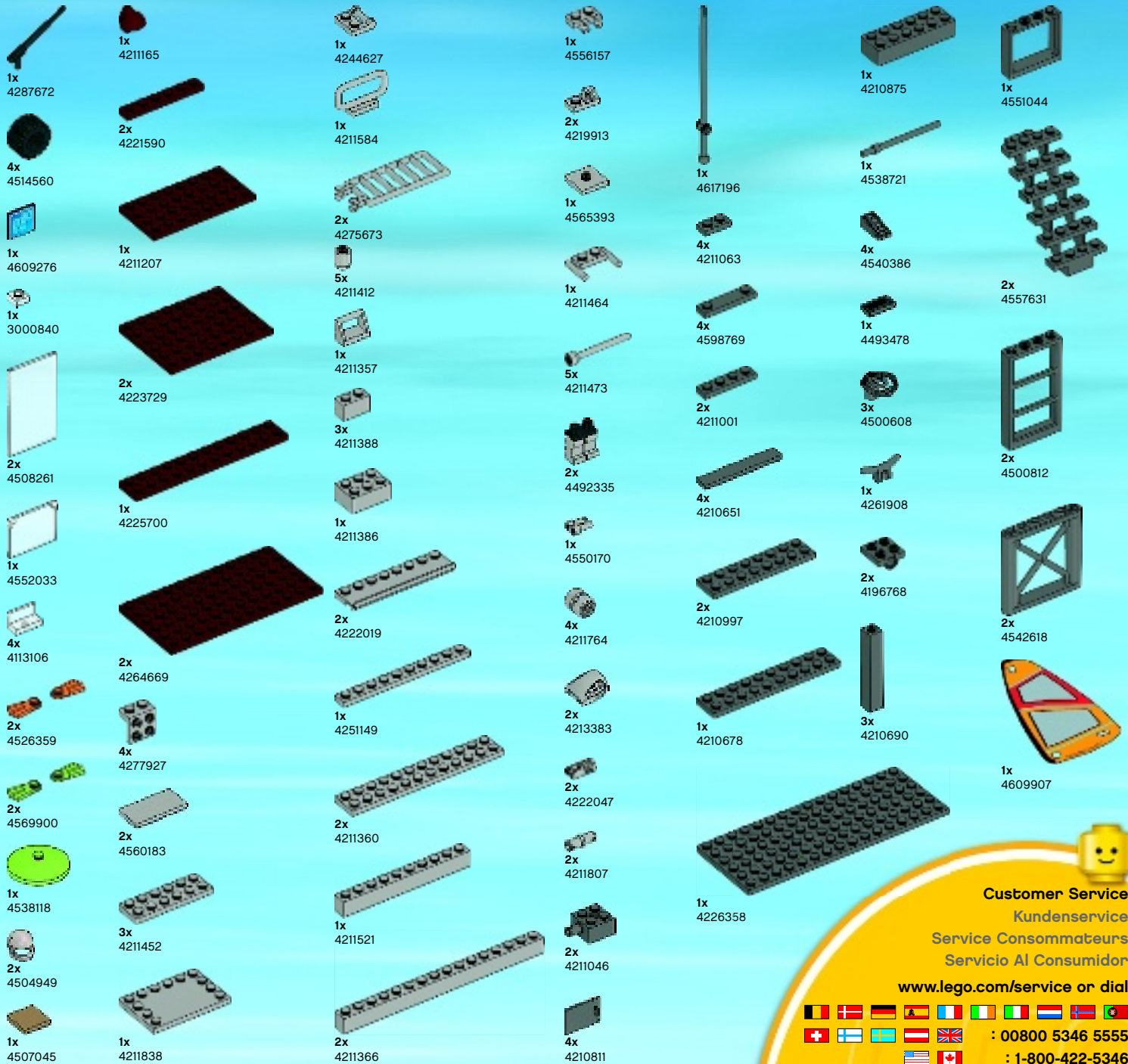

Customer Service
Kundenservice
Service Consommateurs
Servicio Al Consumidor

www.lego.com/service or dial



: 00800 5346 5555
 : 1-800-422-5346



WIN!

Go to www.LEGOsurvey.com/product
to fill out a survey for a chance
to win a cool LEGO® Product.

No purchase ssary.

Open to all residents where not prohibited.



www.LEGO.com



www.LEGOsurvey.com/product

GEWINNE! WIN!

Nimm an der Umfrage auf
www.LEGOsurvey.com/product
teil und hab die Chance ein cooles
LEGO® Produkt zu gewinnen!

Die Teilnahme am Gewinnspiel führt zu keinerlei
Kaufverpflichtungen. Teilnahme in allen nicht
ausgeschlossenen Ländern möglich.

Ga naar www.LEGOsurvey.com/product,
vul een enquêteformulier
in en maak kans op een
cool LEGO® product.

Geen aankoopverplichting.
Iedereen mag deelnemen, uitgezonderd
ingezetenden van landen waar een
enquêteverbod geldt.

GAGNE! 当てよう!

Visite www.LEGOsurvey.com/product
pour répondre à un
questionnaire et avoir une chance de
gagner un produit LEGO® très cool!

Aucune obligation d'achat.
Ouvert à tous les résidents des pays
autorisés.

www.LEGOsurvey.com/product にアクセスして、
アンケートにご記入ください。当選者にはレゴ®
製品を差し上げます。

お買い上げの必要はありません。

禁止されていない限り、すべての皆様にご利用いただけます。