



# DINO

5886



1

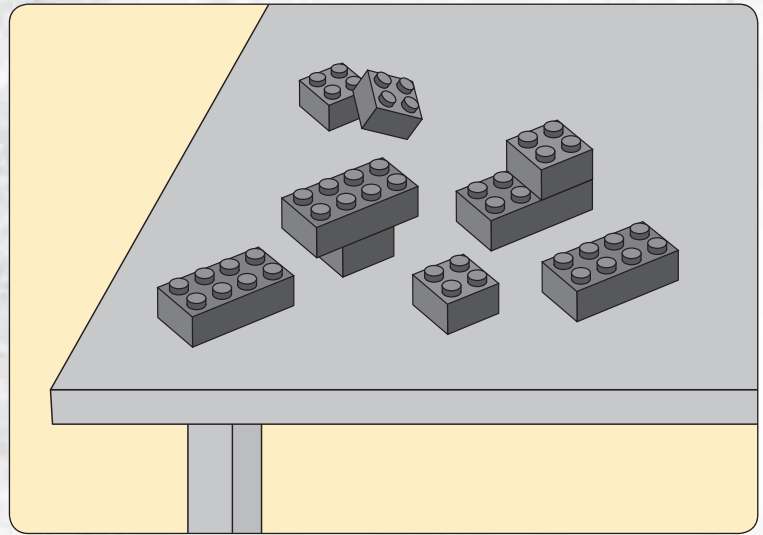
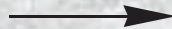
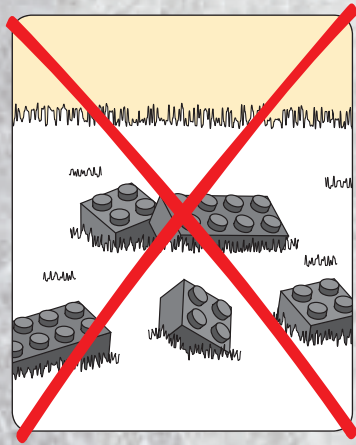

2





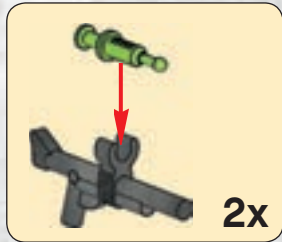
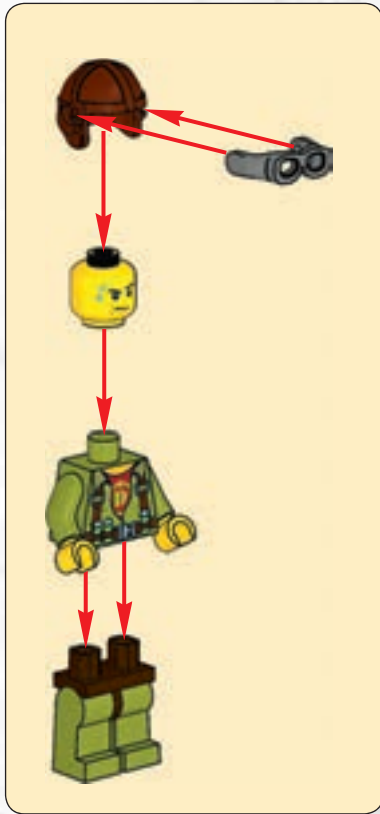

1



2

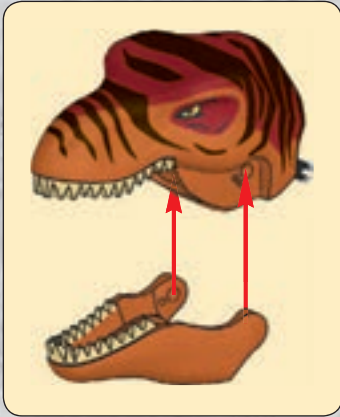



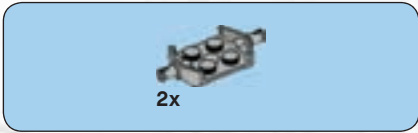
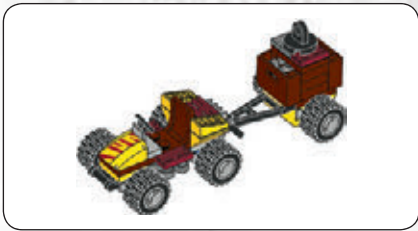

1

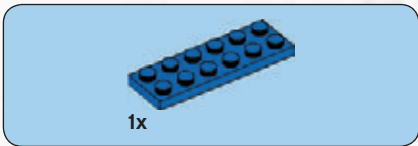

2



3

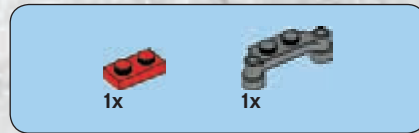
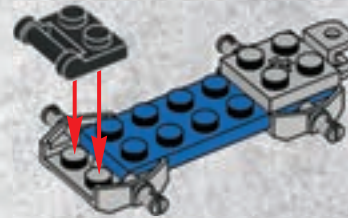

4



5



5

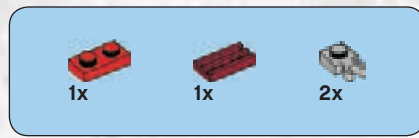

6

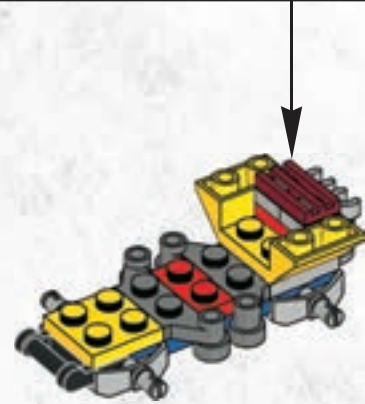





7

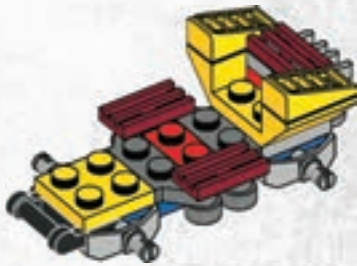

8

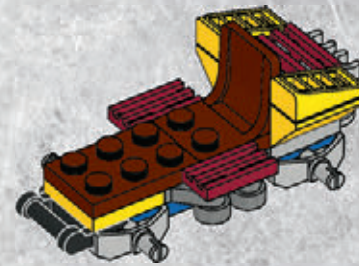



1x



1x

# 9

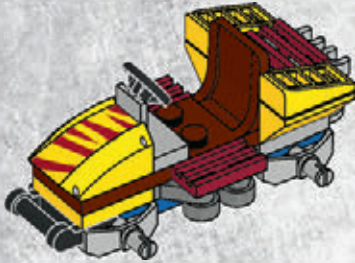

4x



4x

# 10

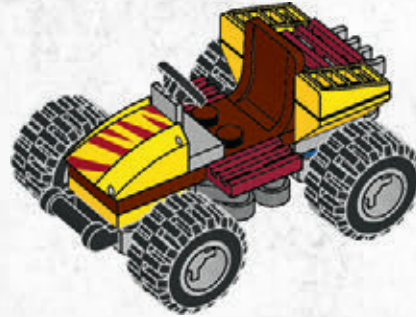





1

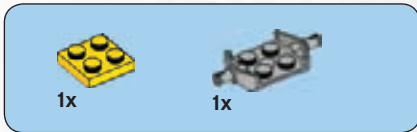
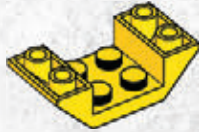

2

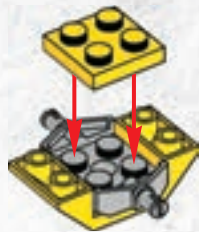

3



4

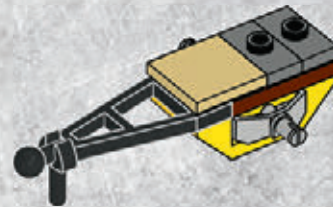

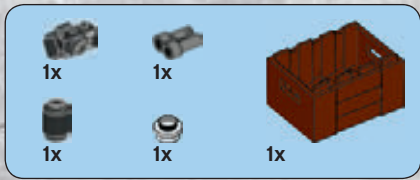

5

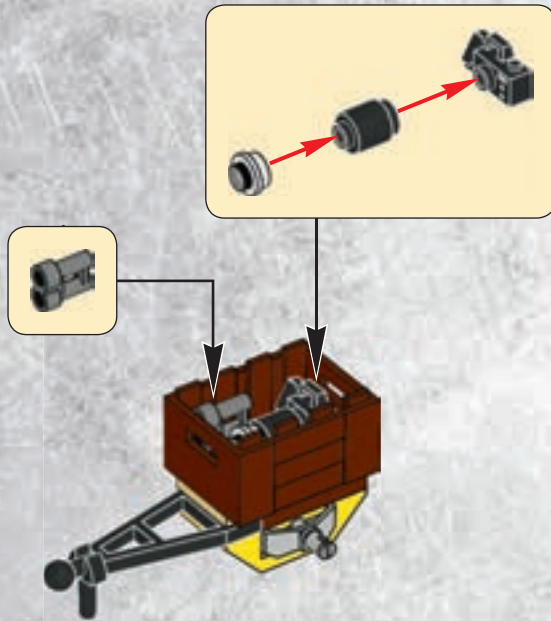

6

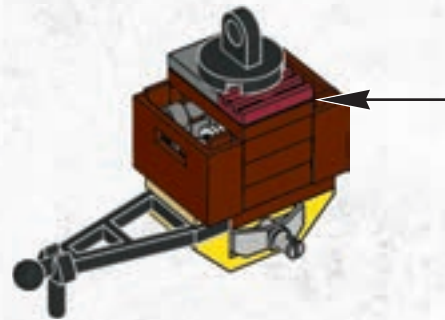



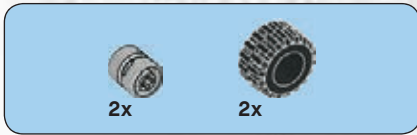

7

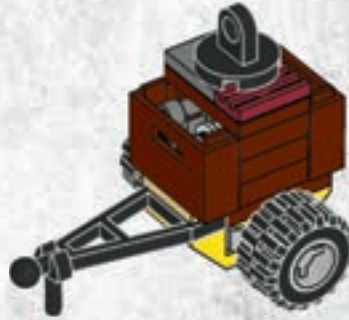

8

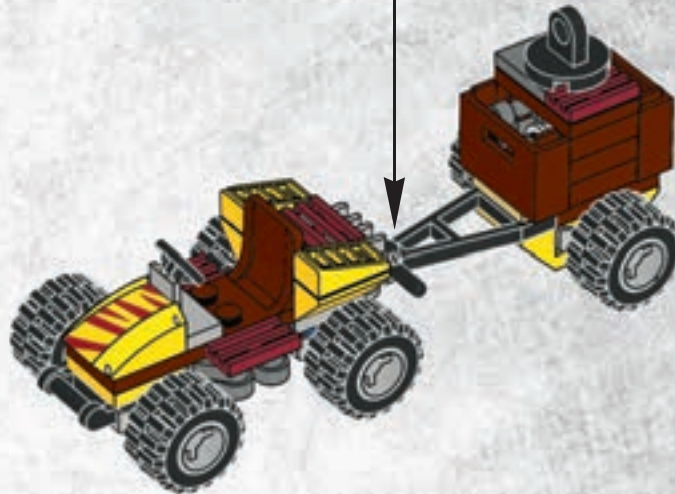

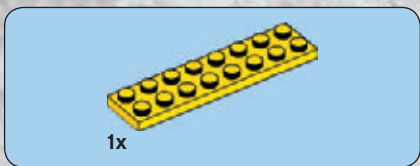

1

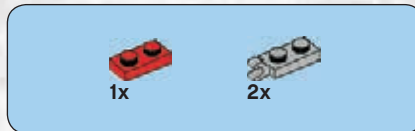

2

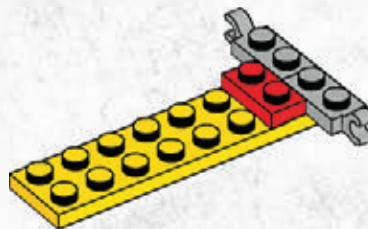



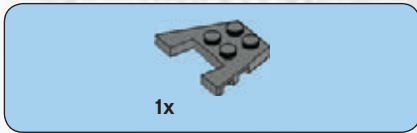

**3**

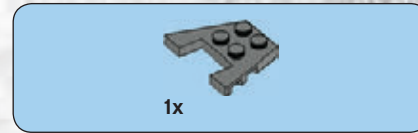
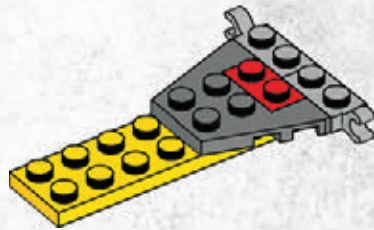

**4**

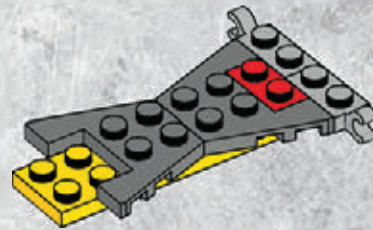



5

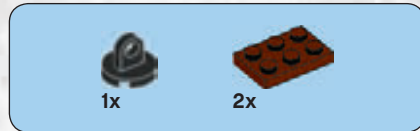
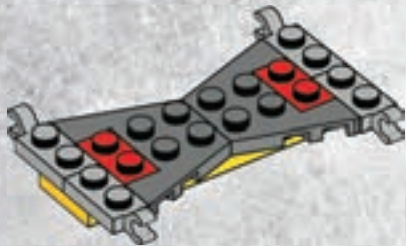

6







7



8

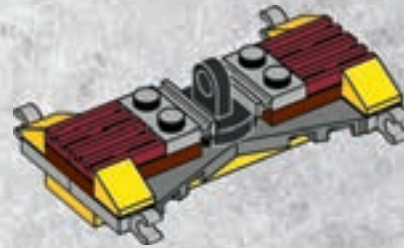

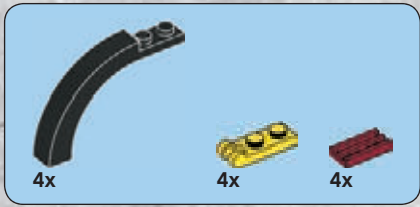

9

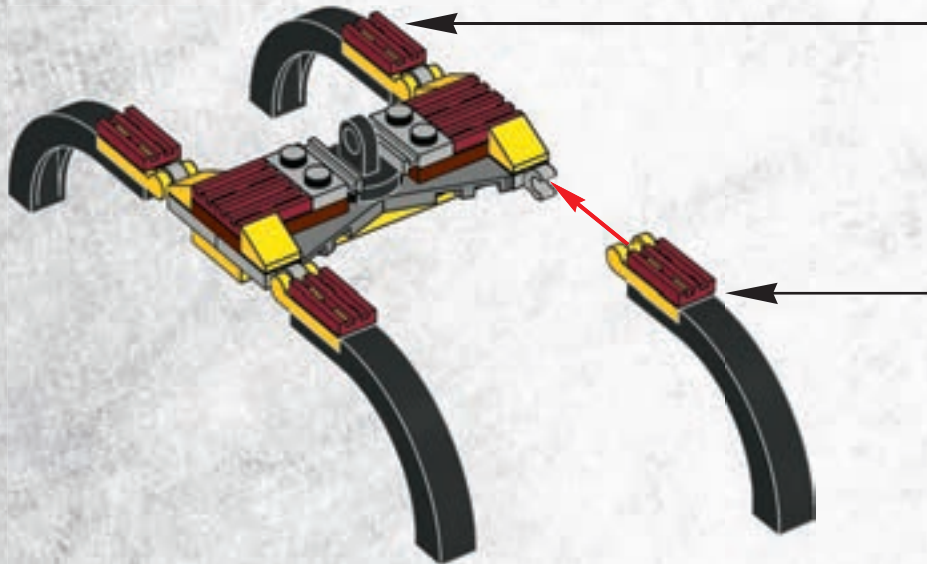



10

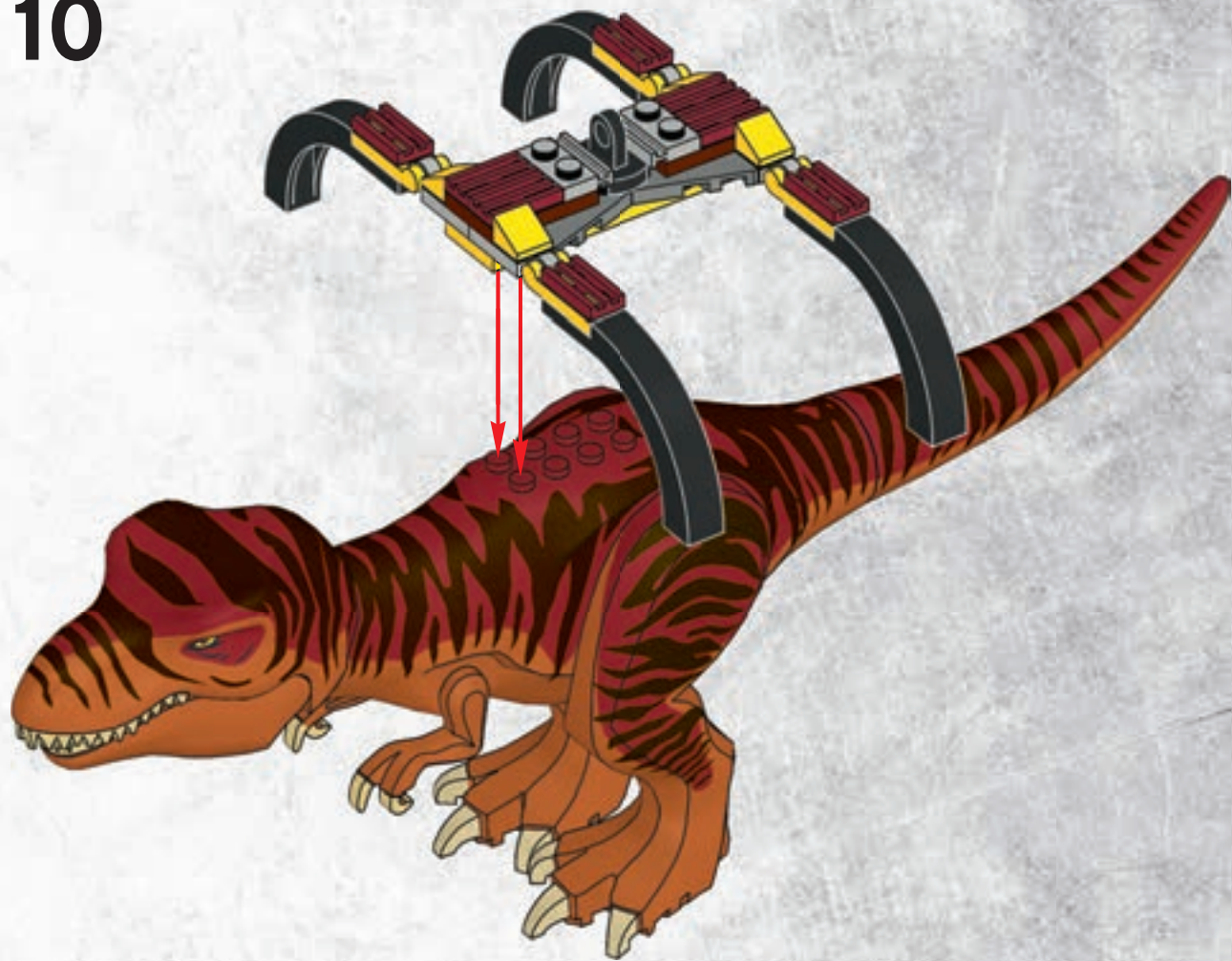

11





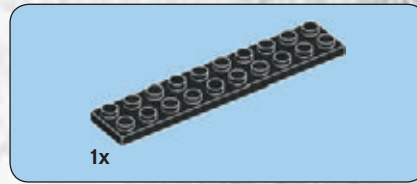
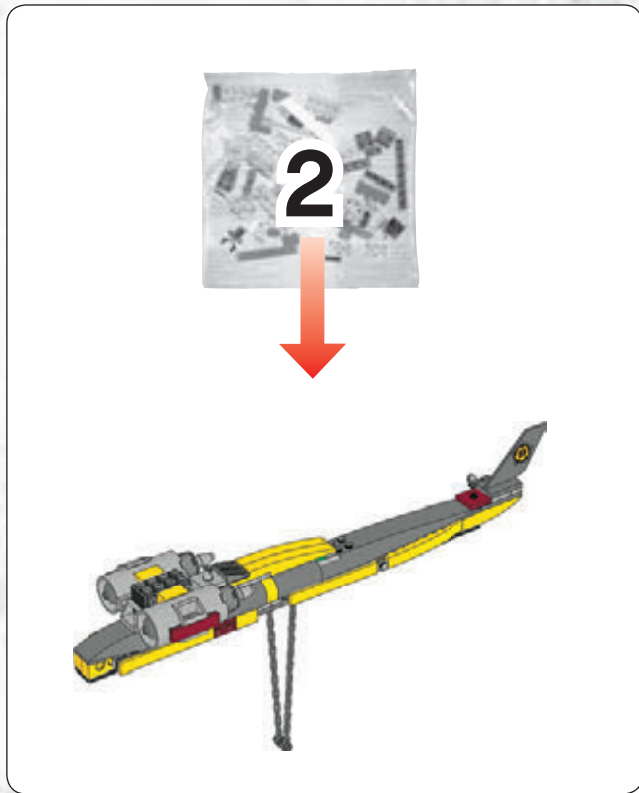

1



2

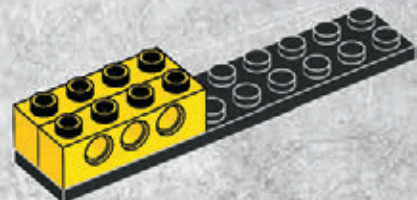



3

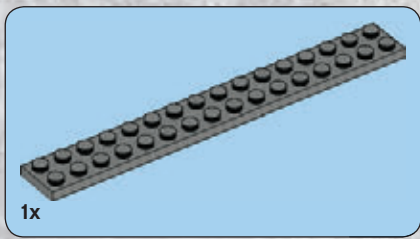

4

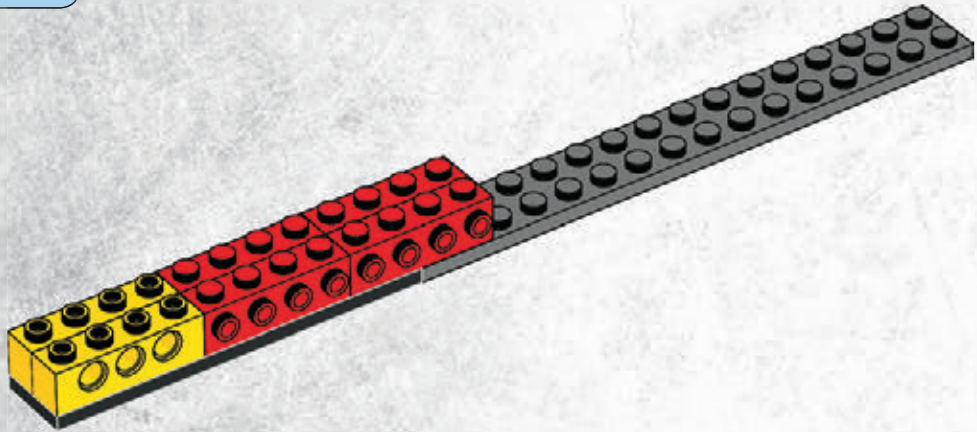



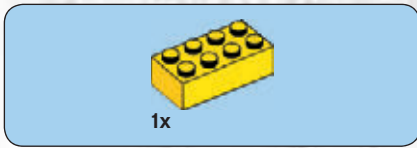

5

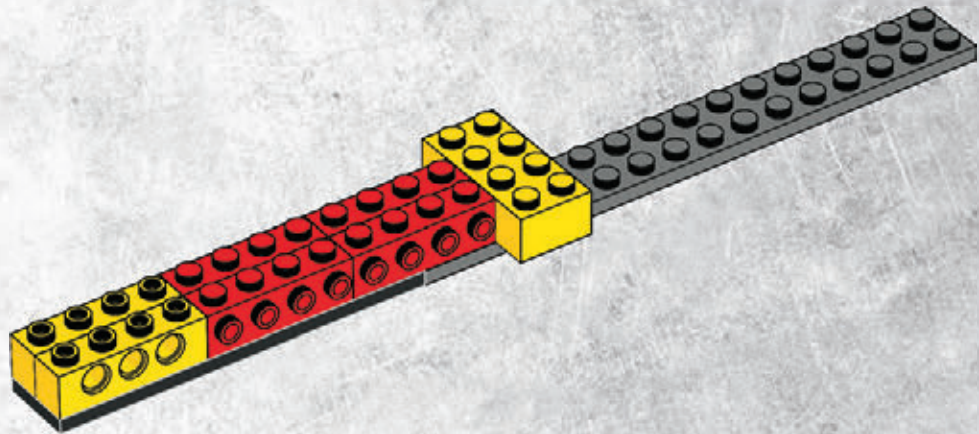



2x

6

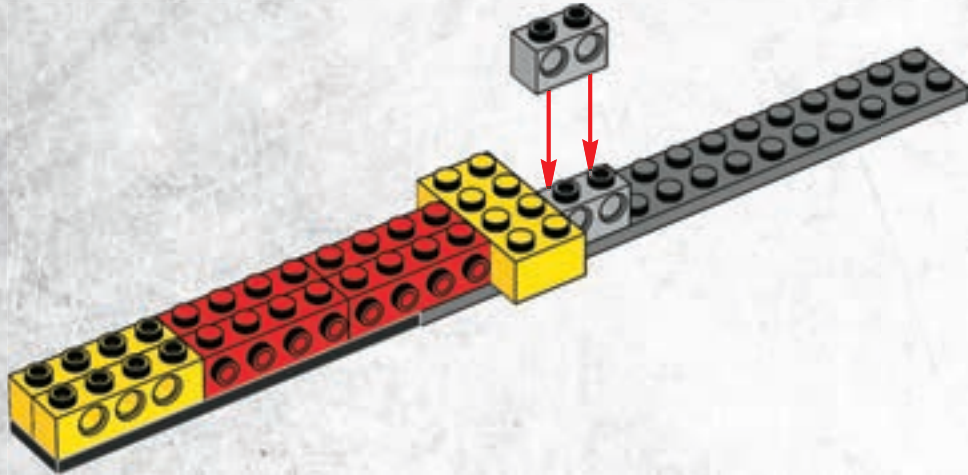

1x

7

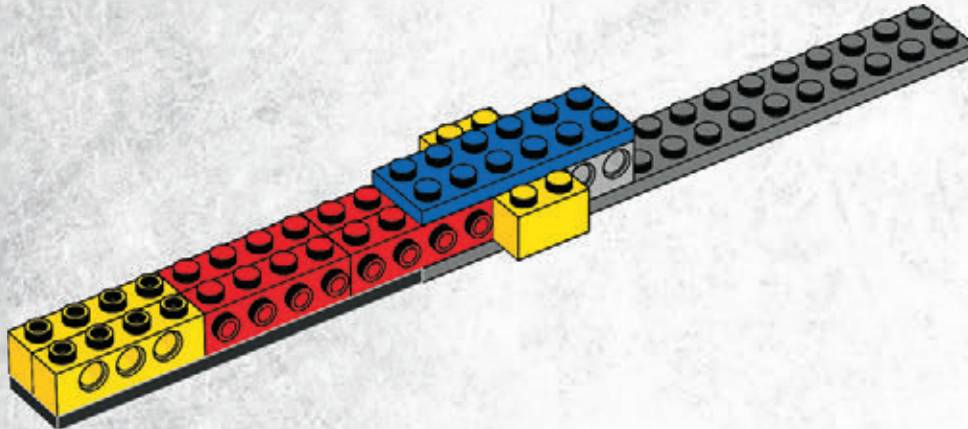





8

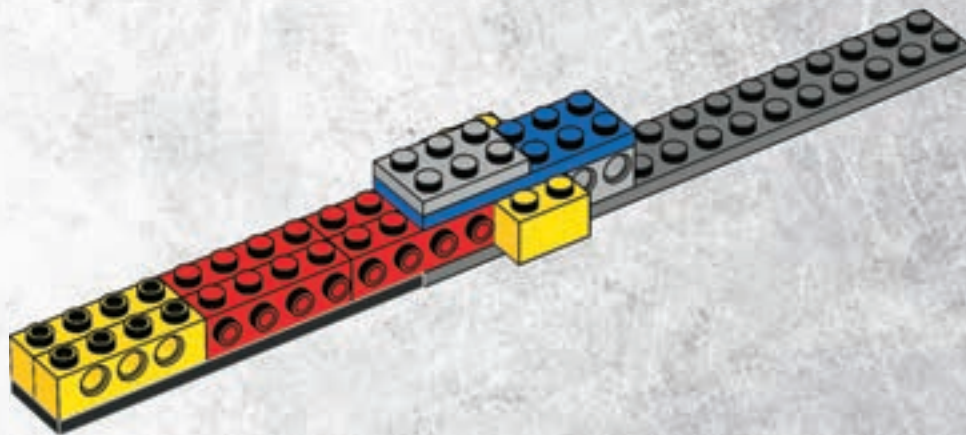

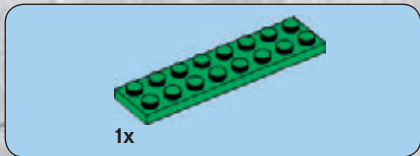

9

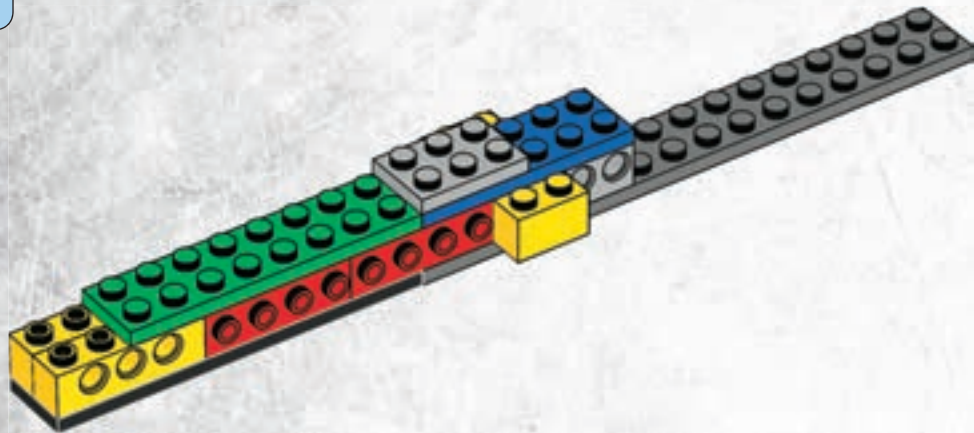

10

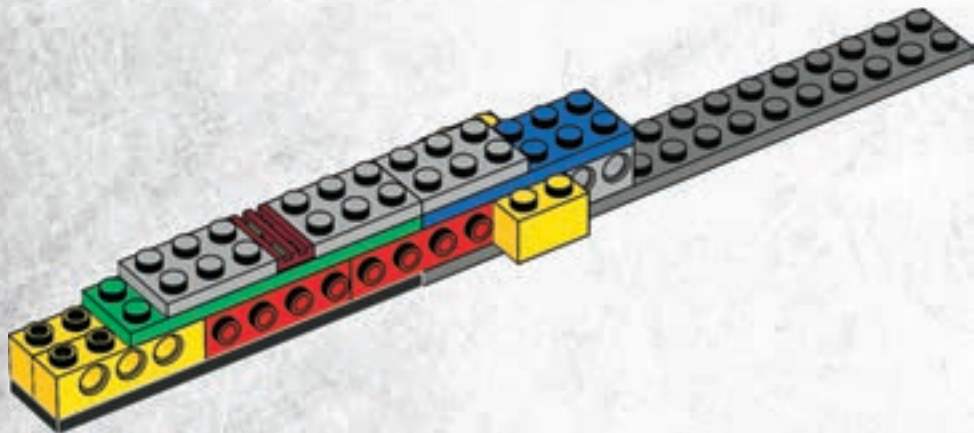





# 11

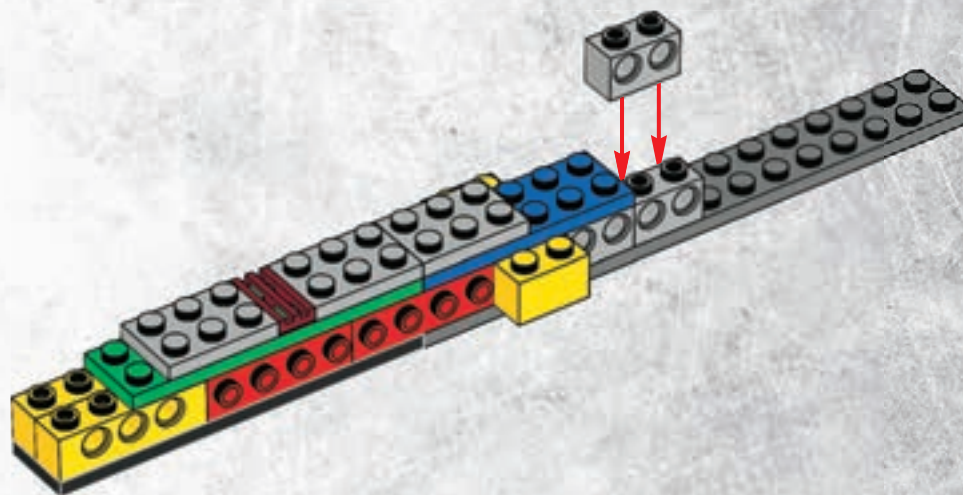

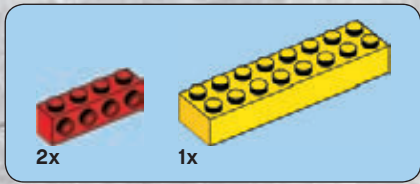

12

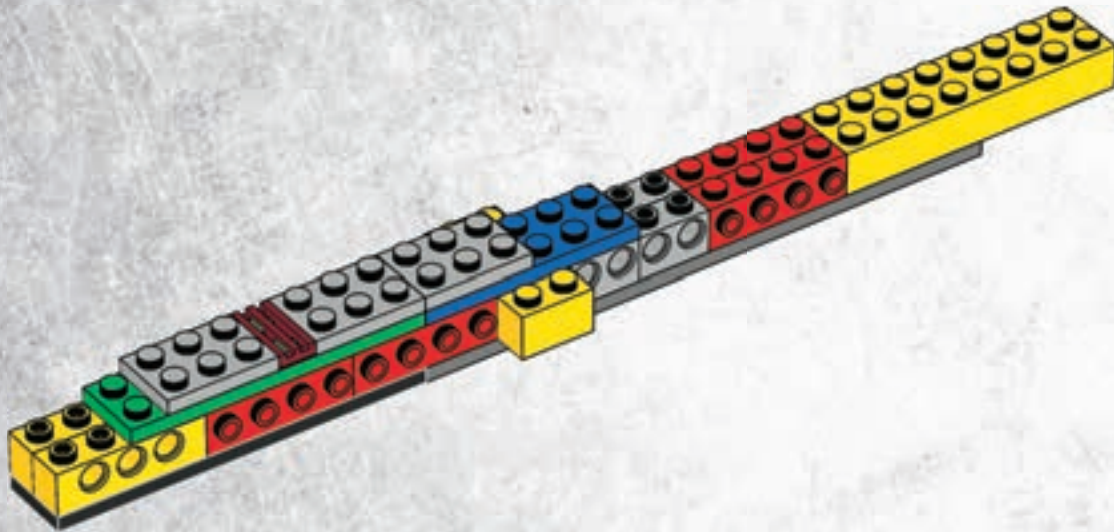



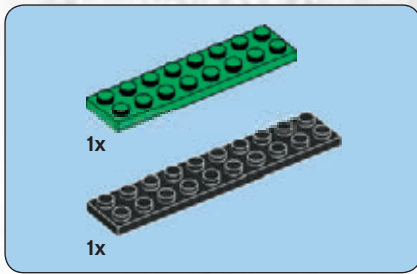

# 13

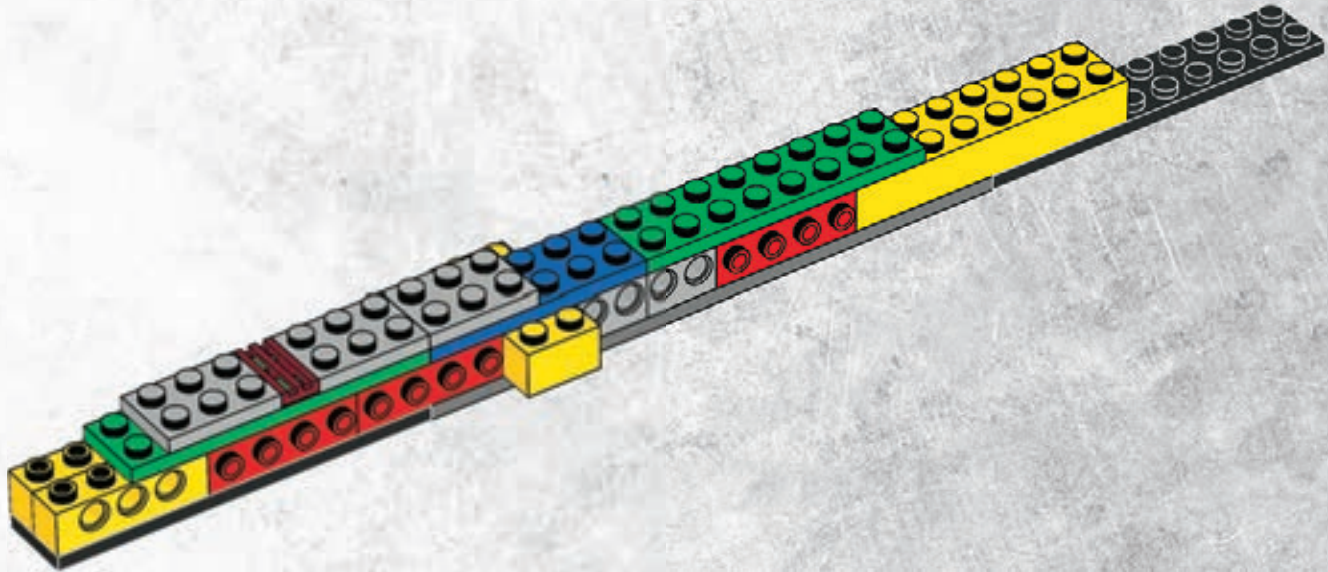



14

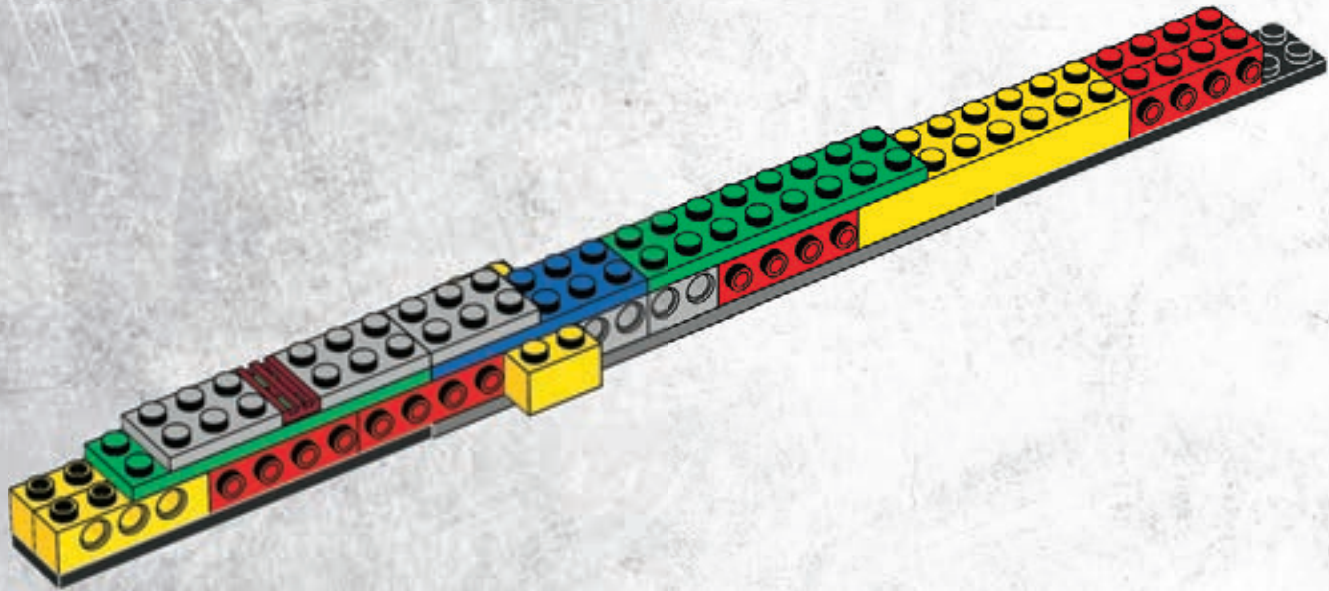



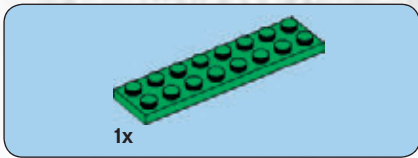

15

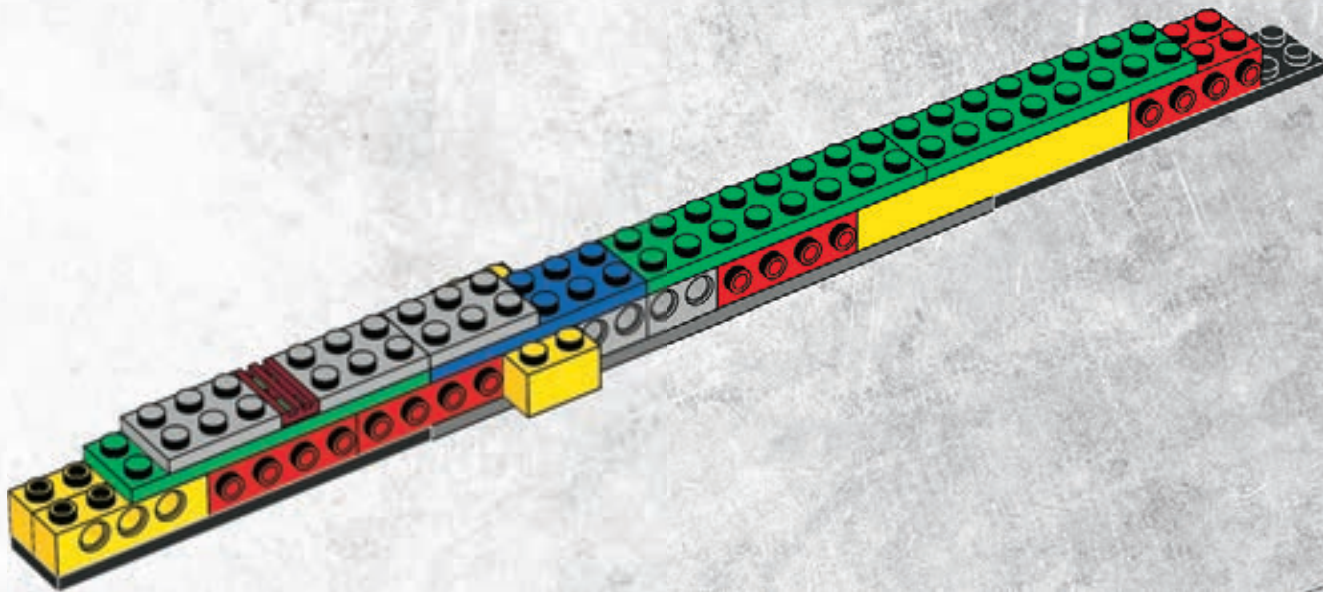

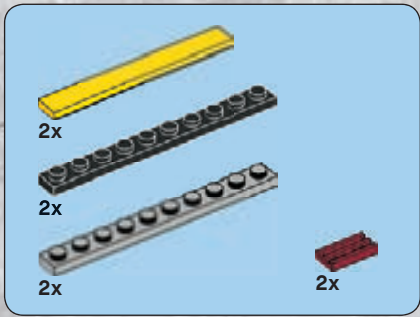

16

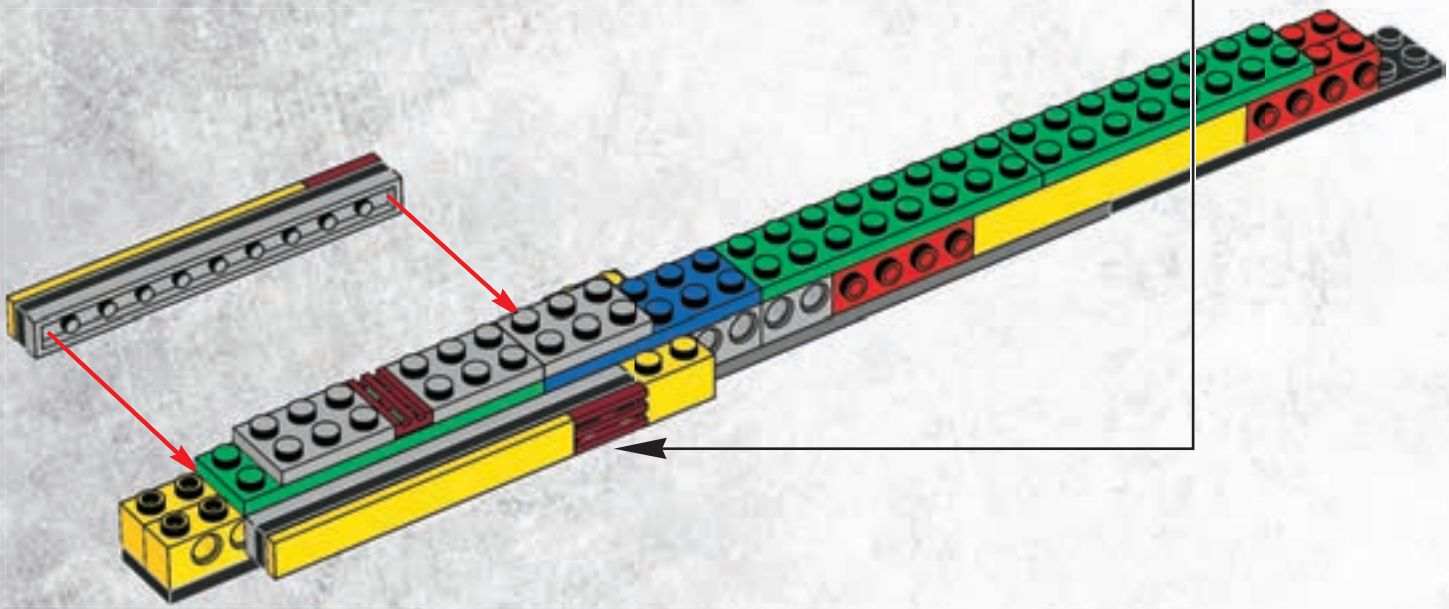
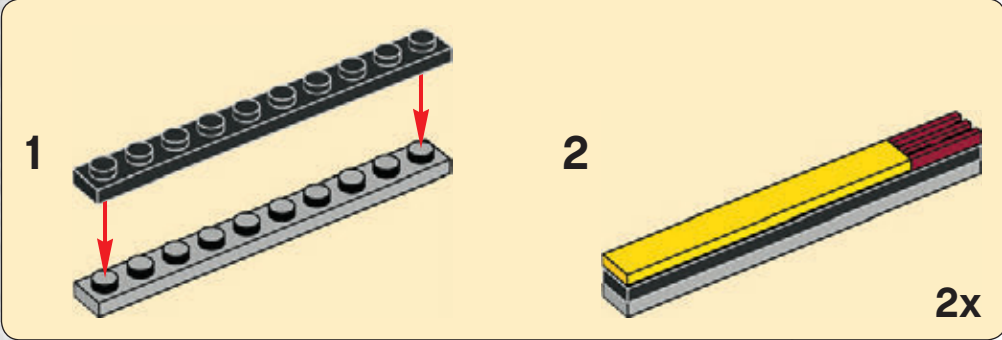



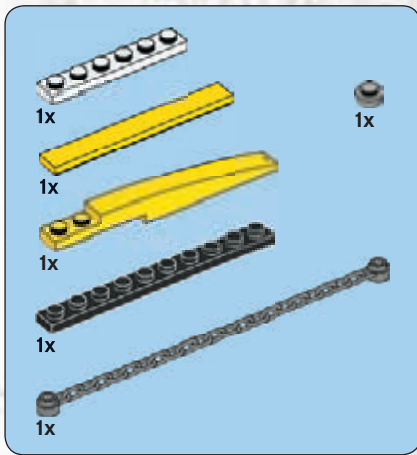

# 17

1



2



3



4

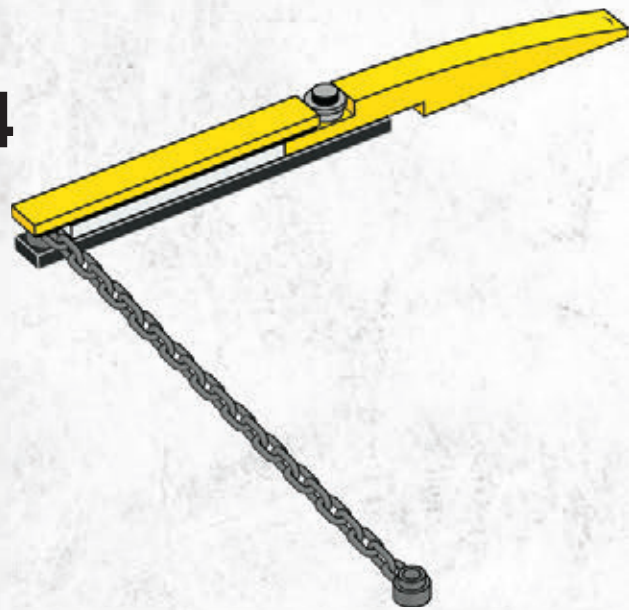



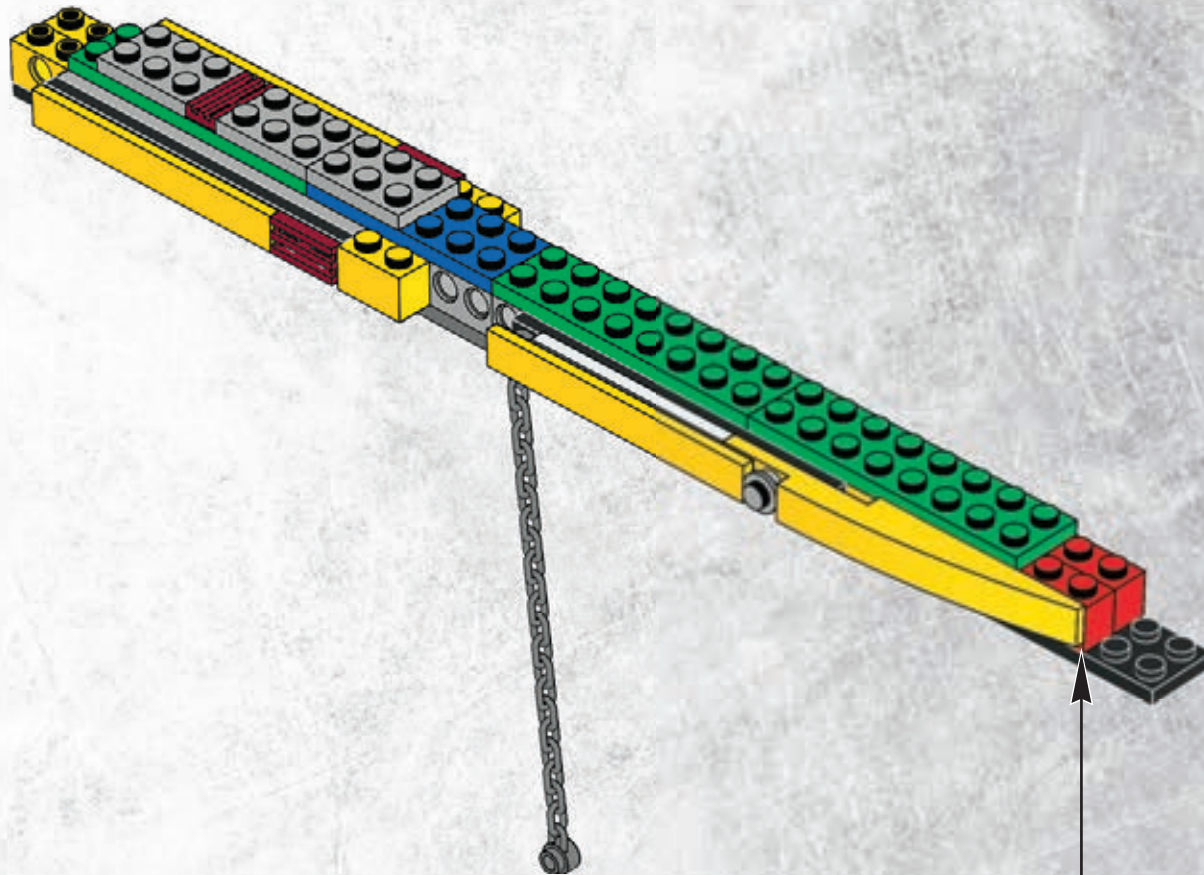

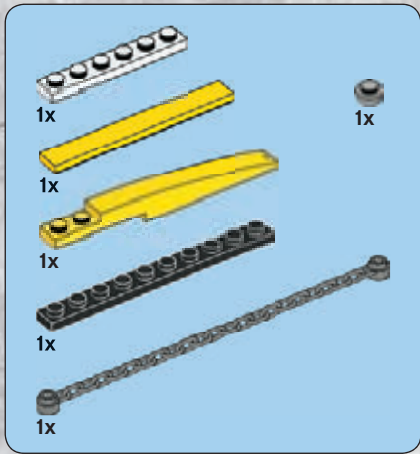

18

1

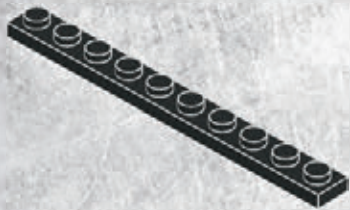

2





3



4

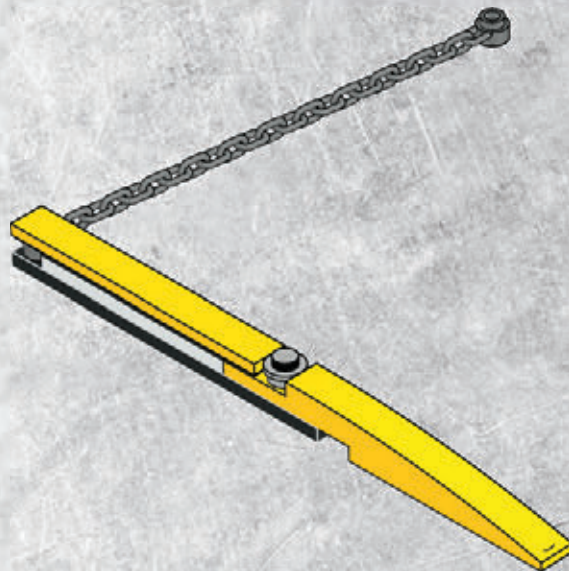

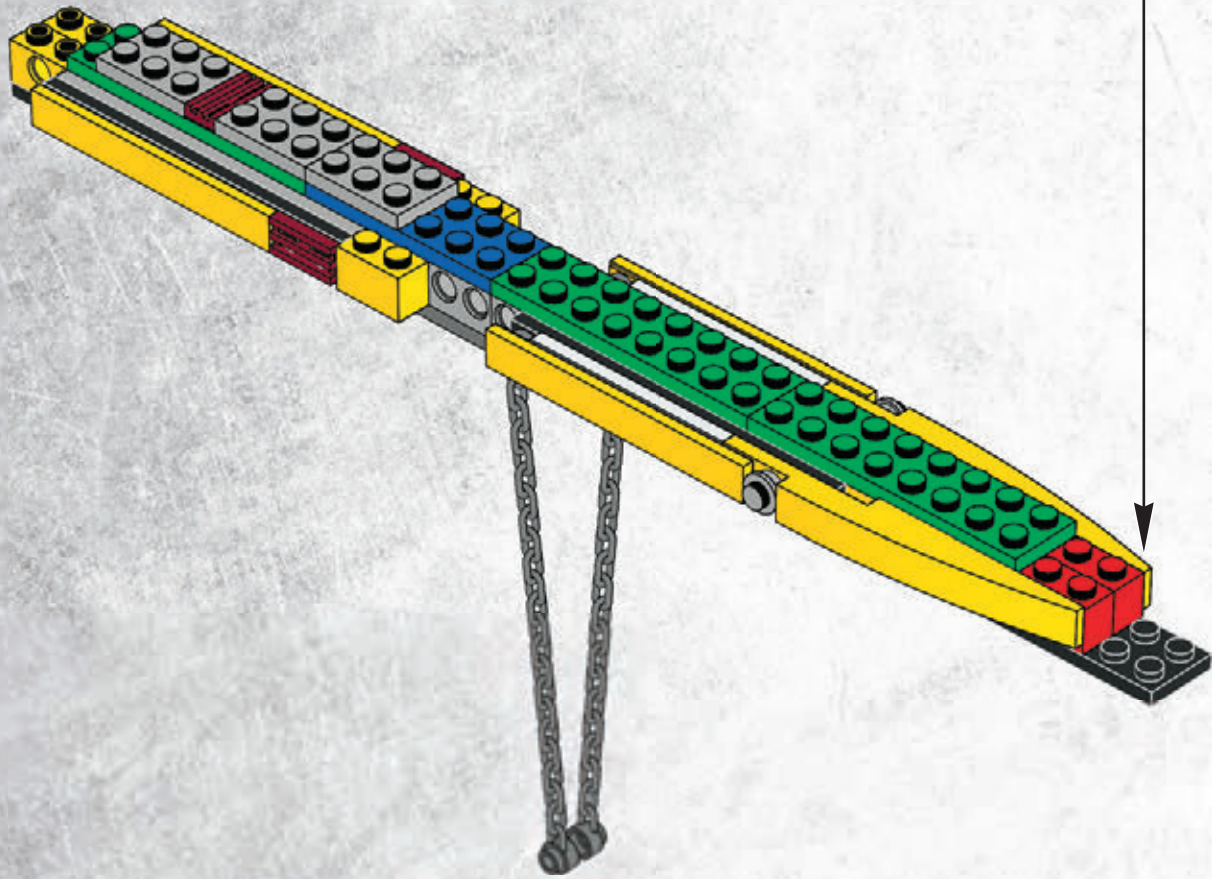



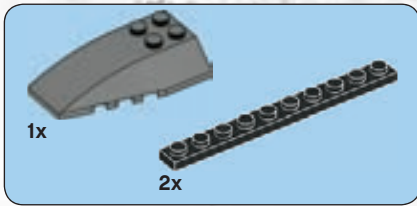

19

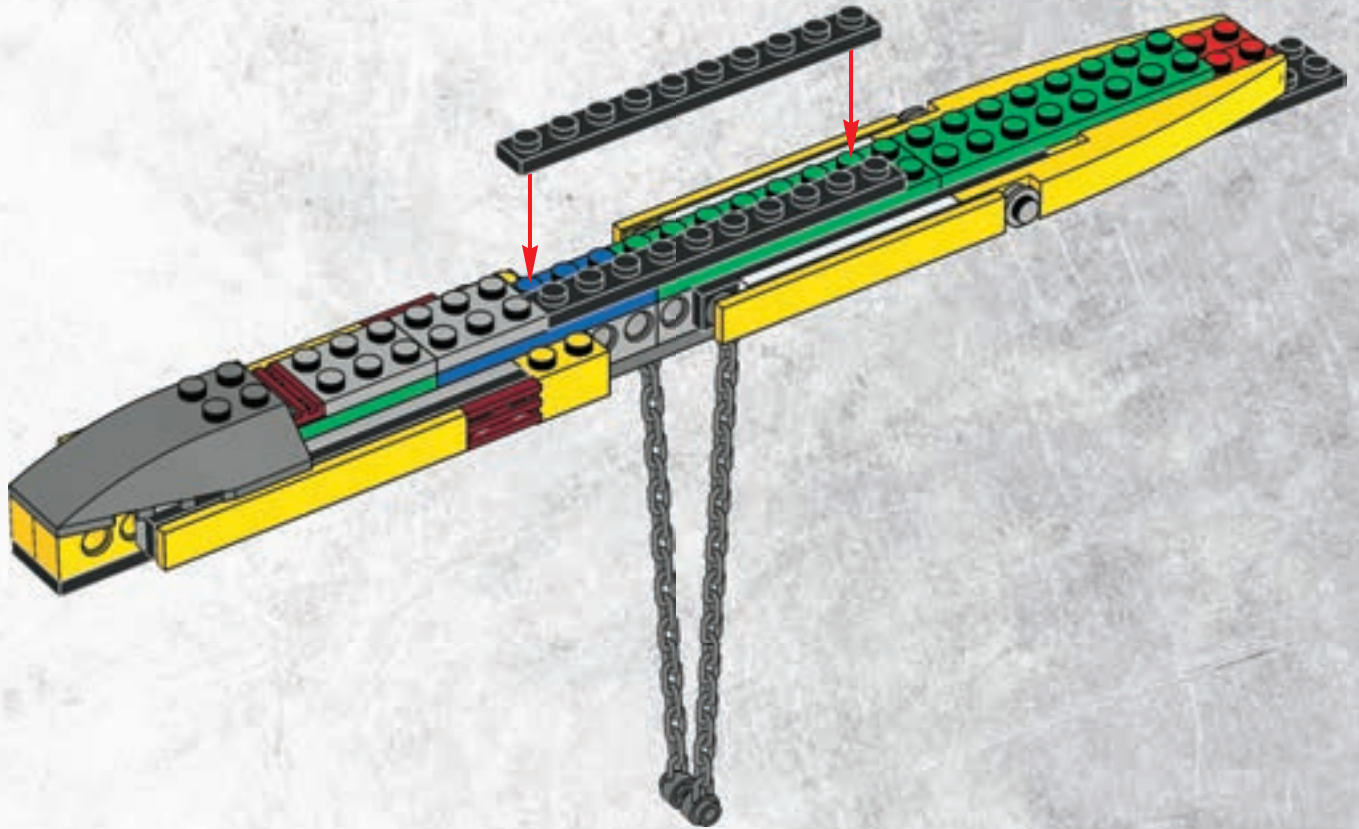

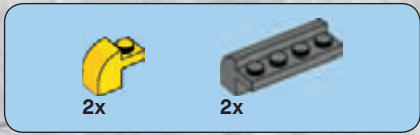

20

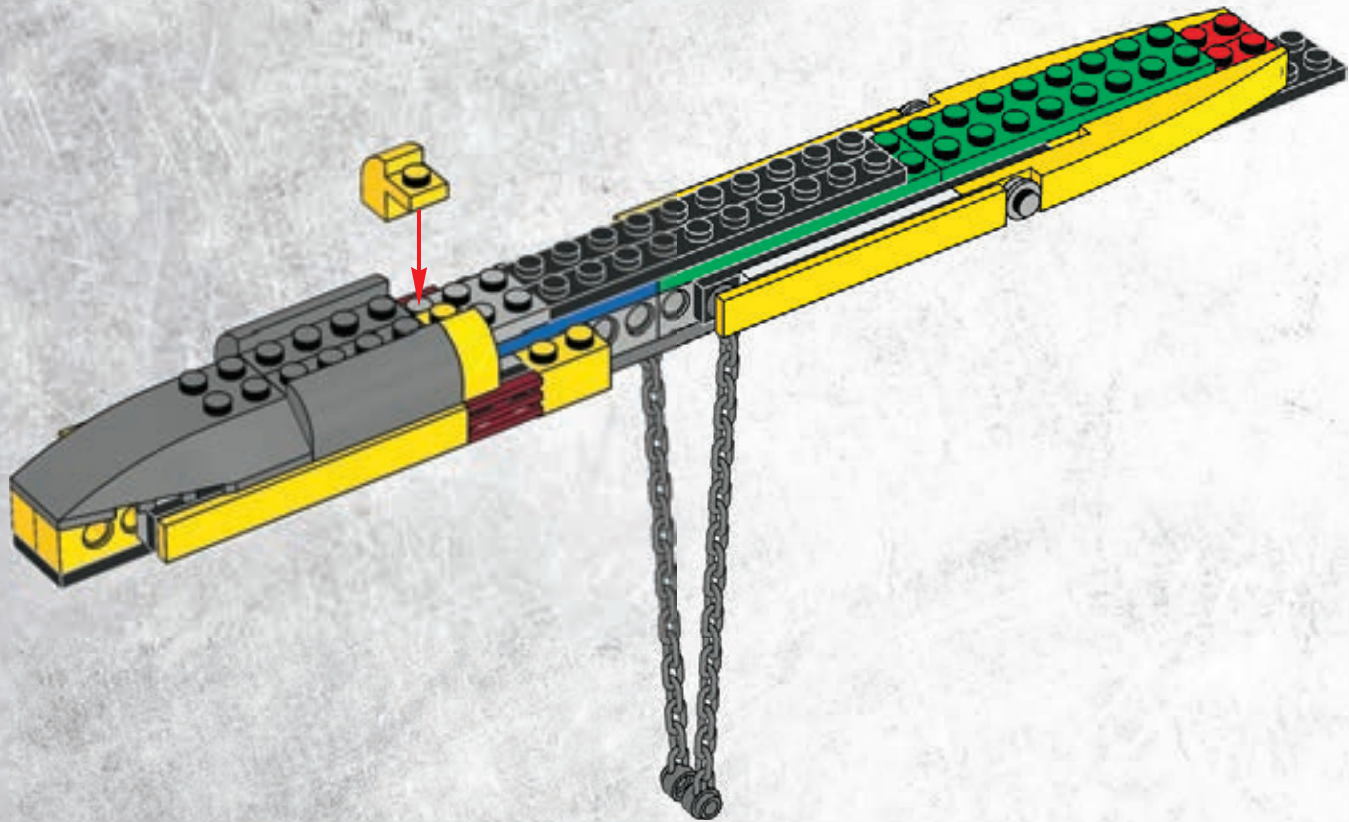



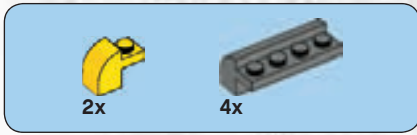

21

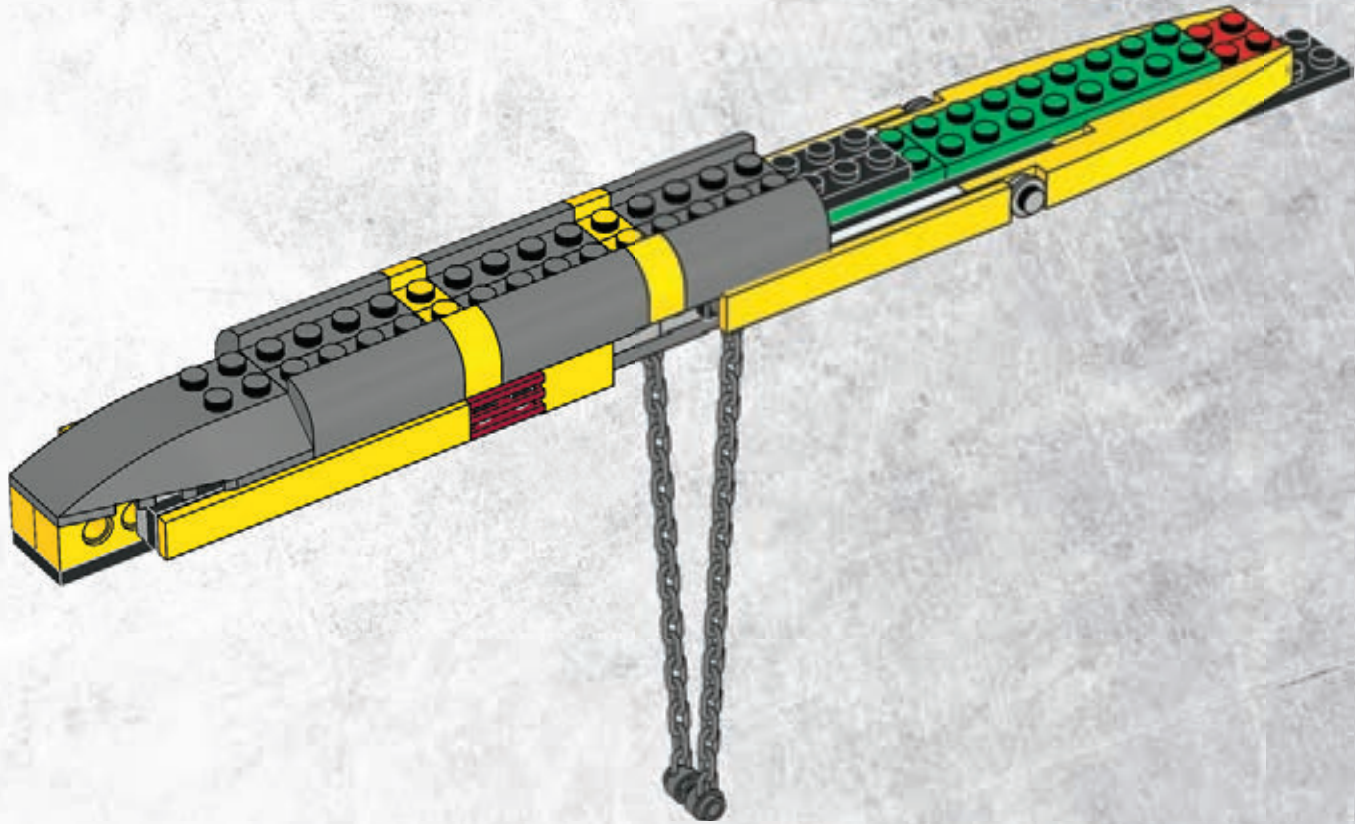

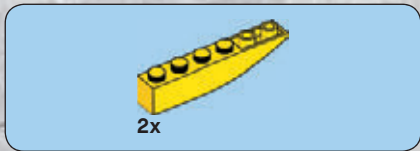

22

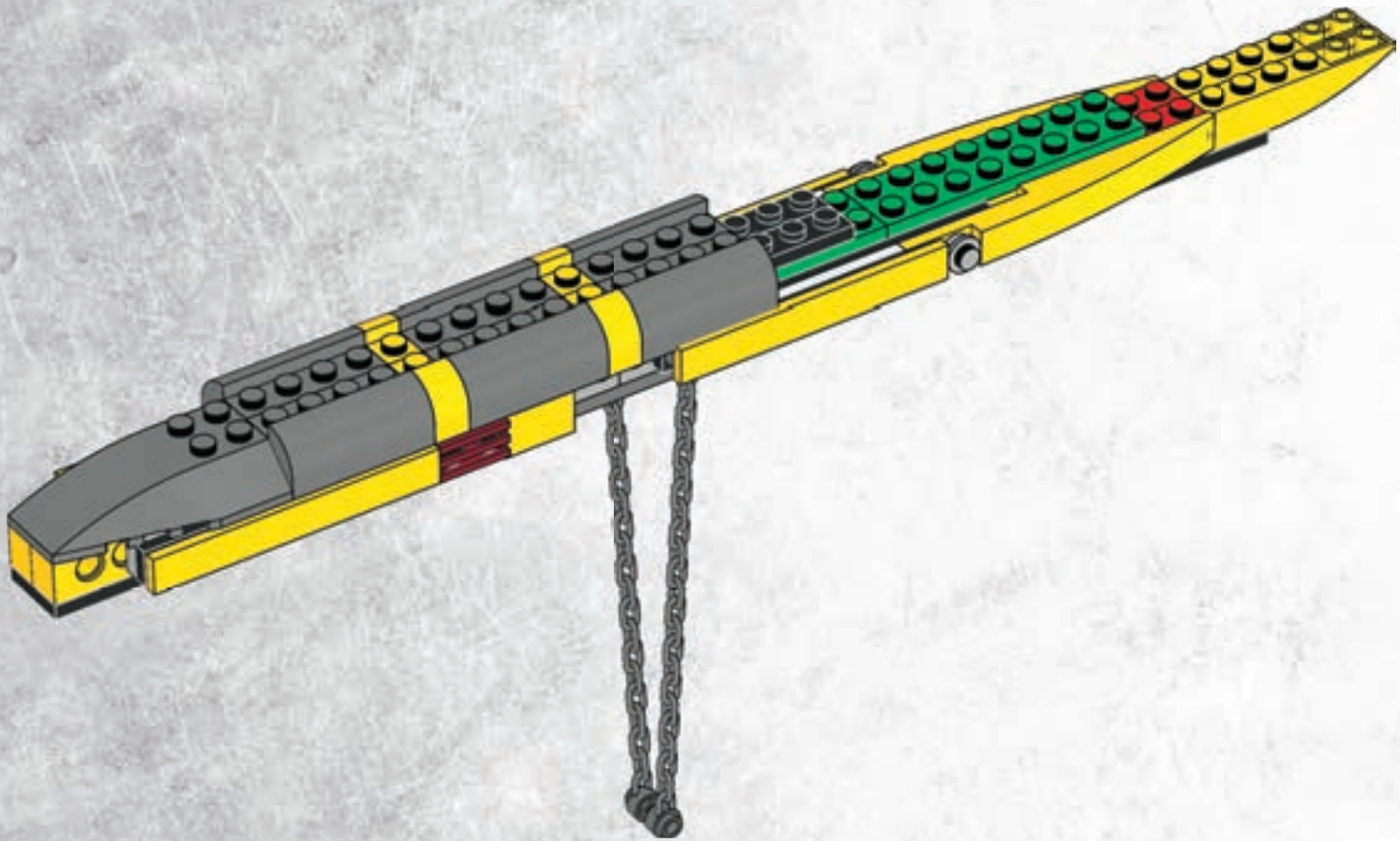



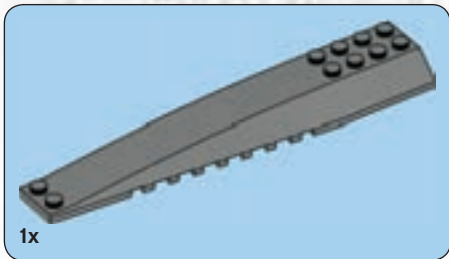

23

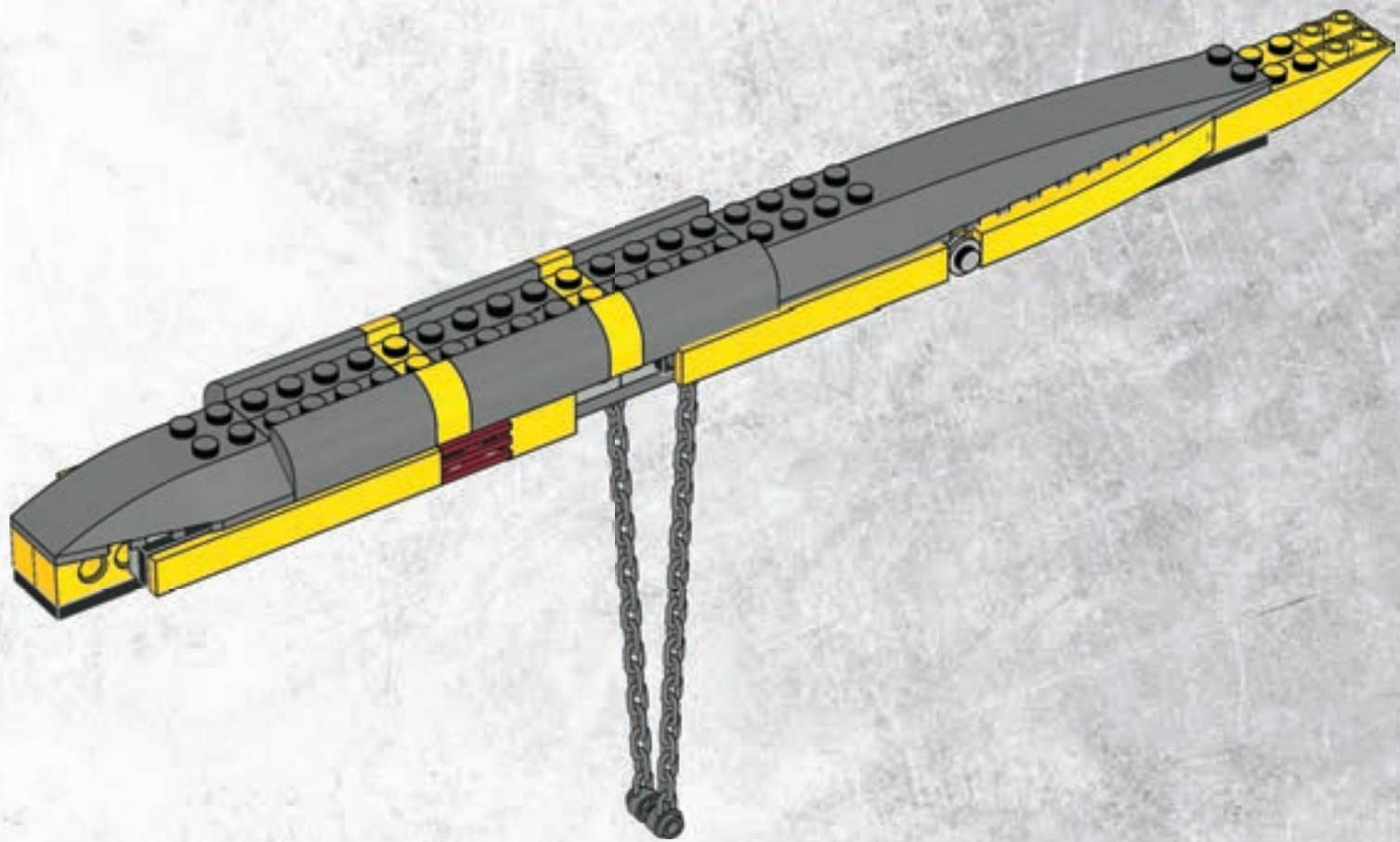

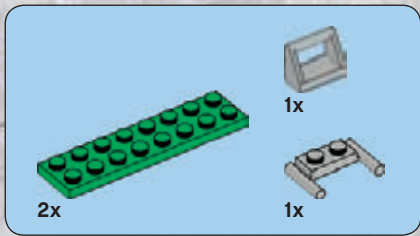

24

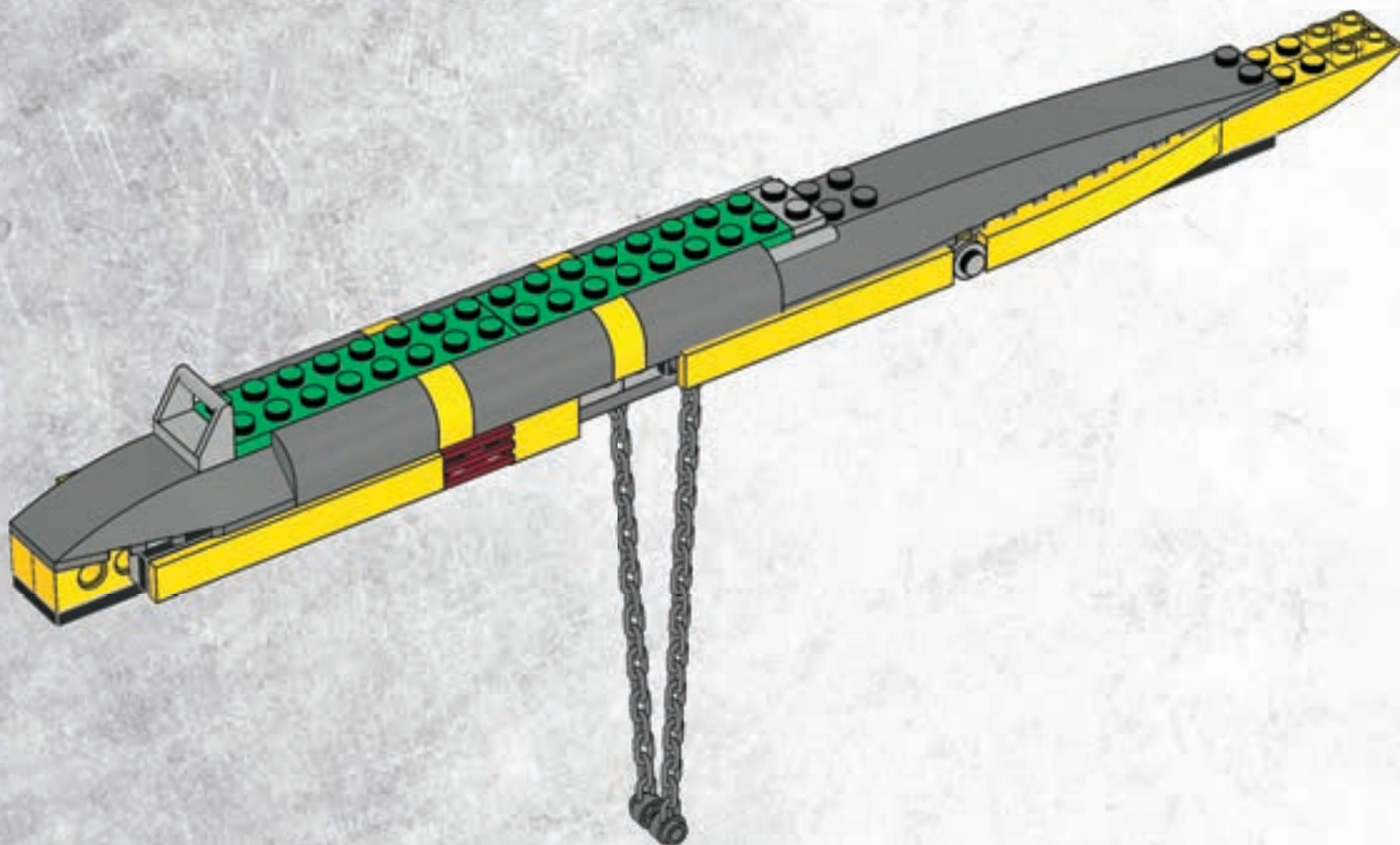



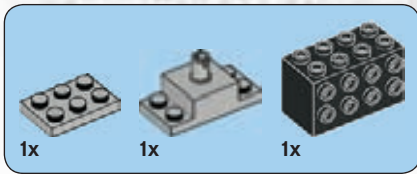

25

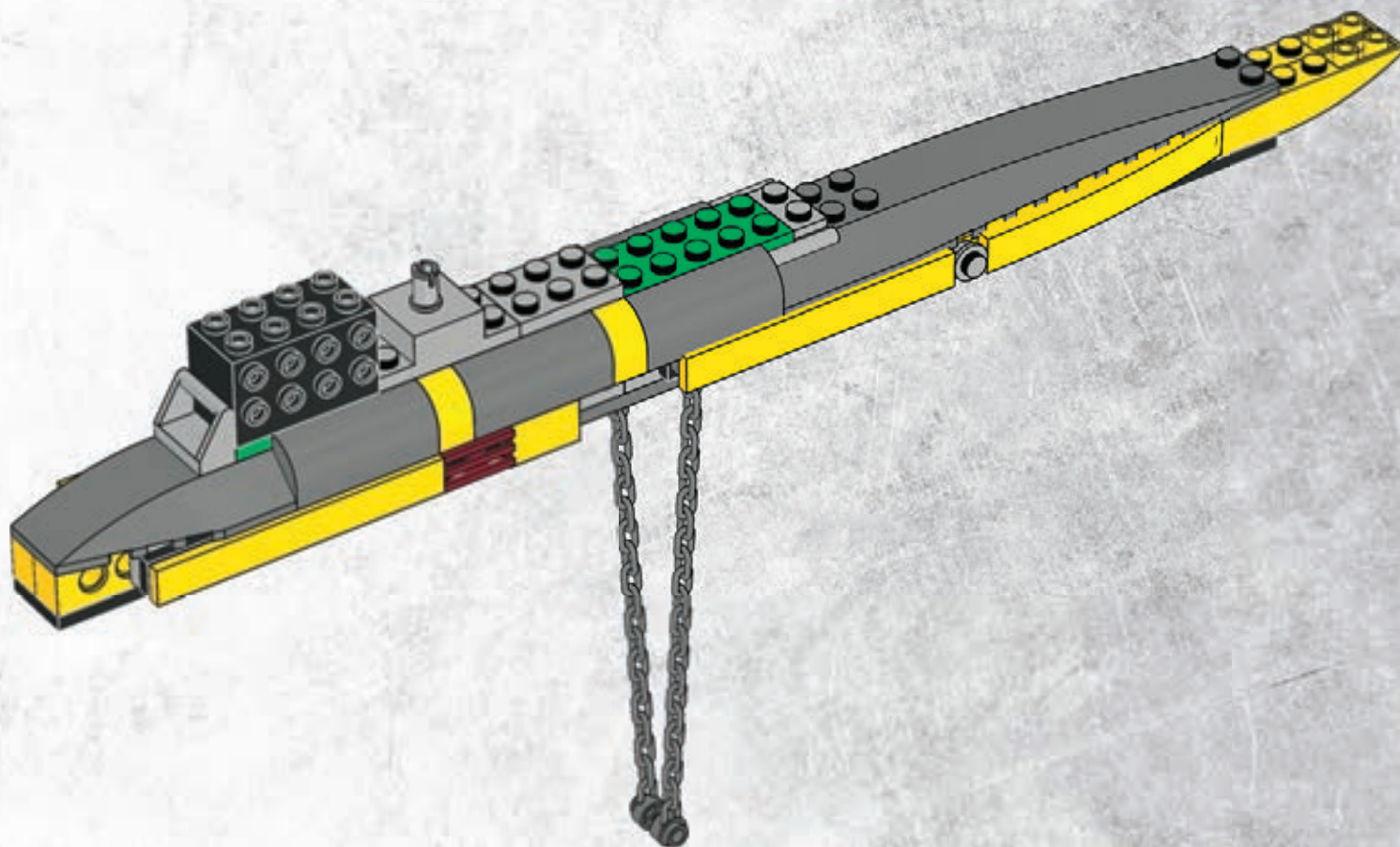

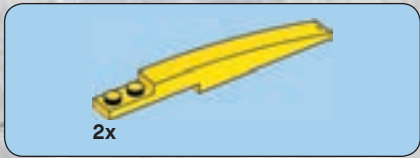

26

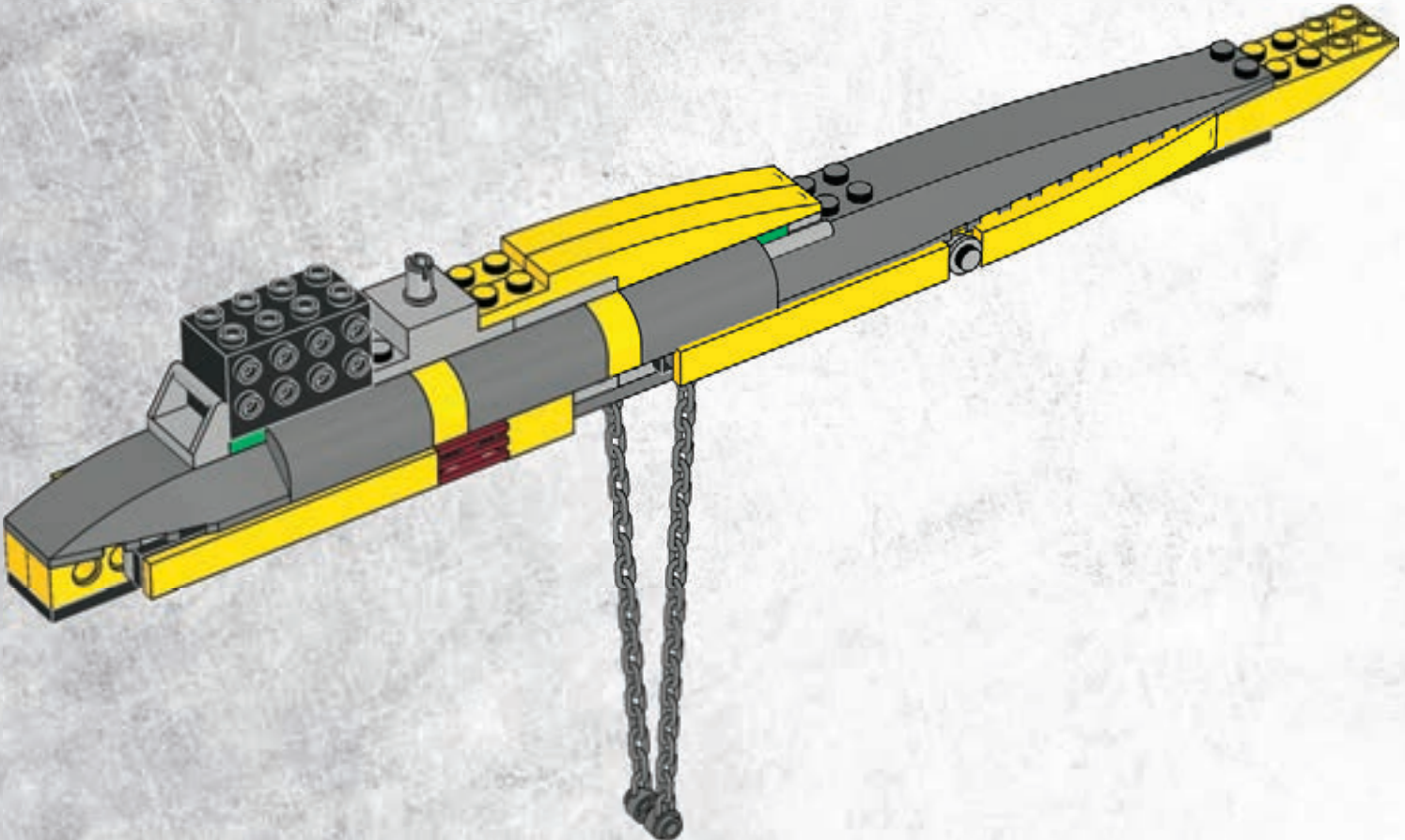





27

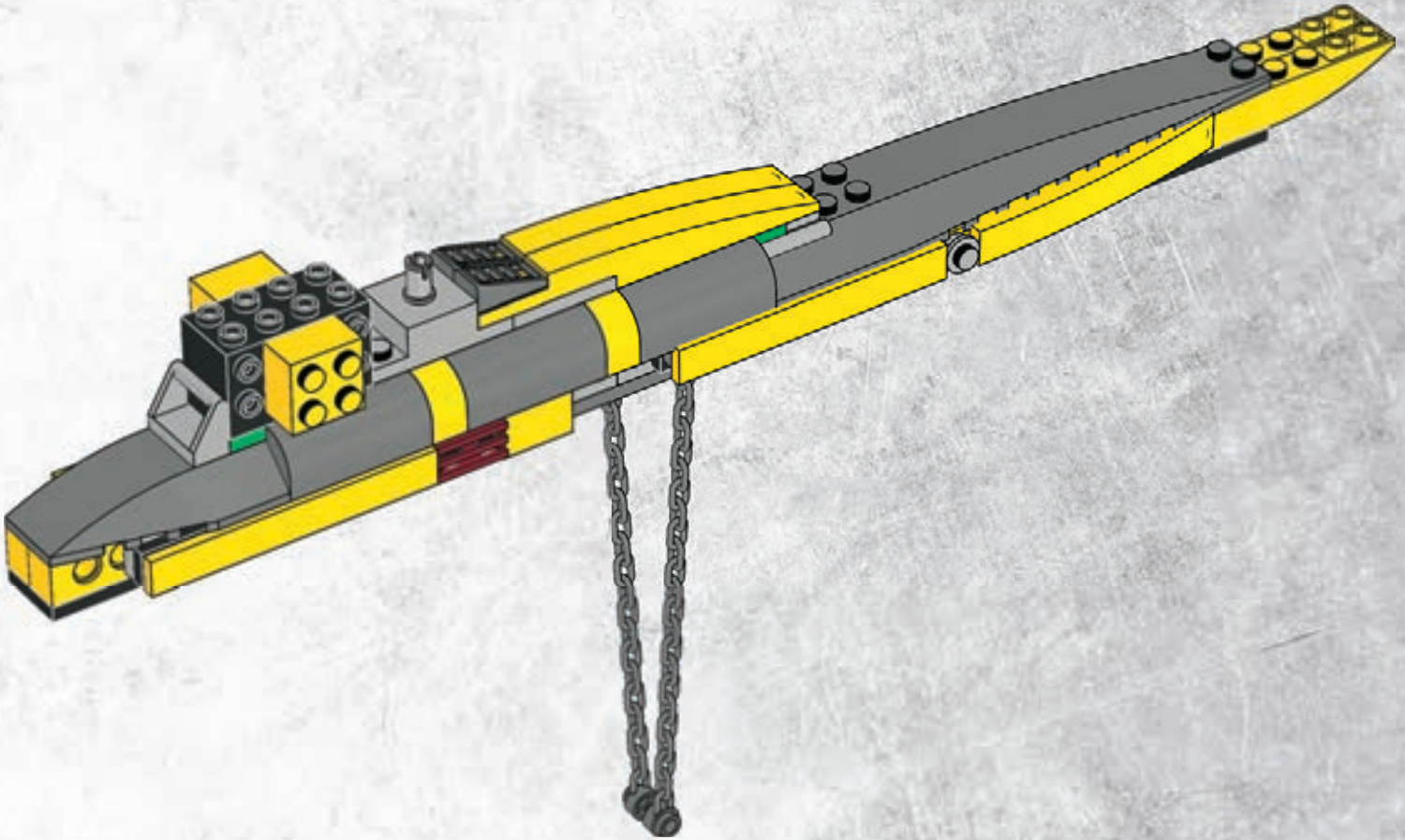

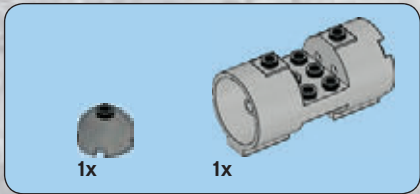
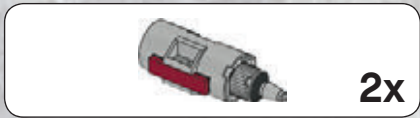

1

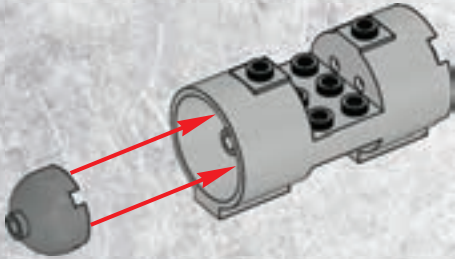

2

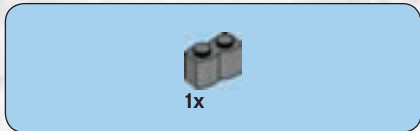
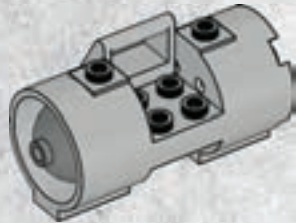

3

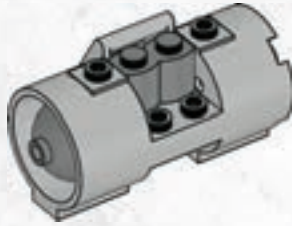

4

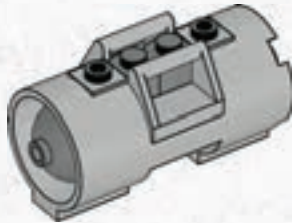





5

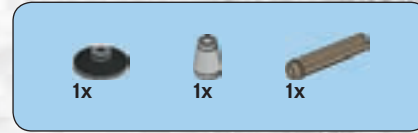
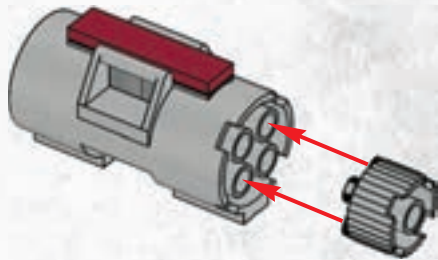

6

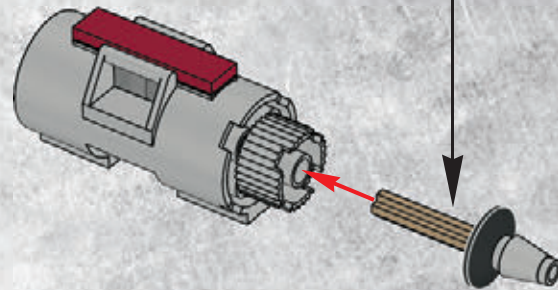
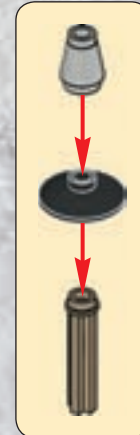

2x

28

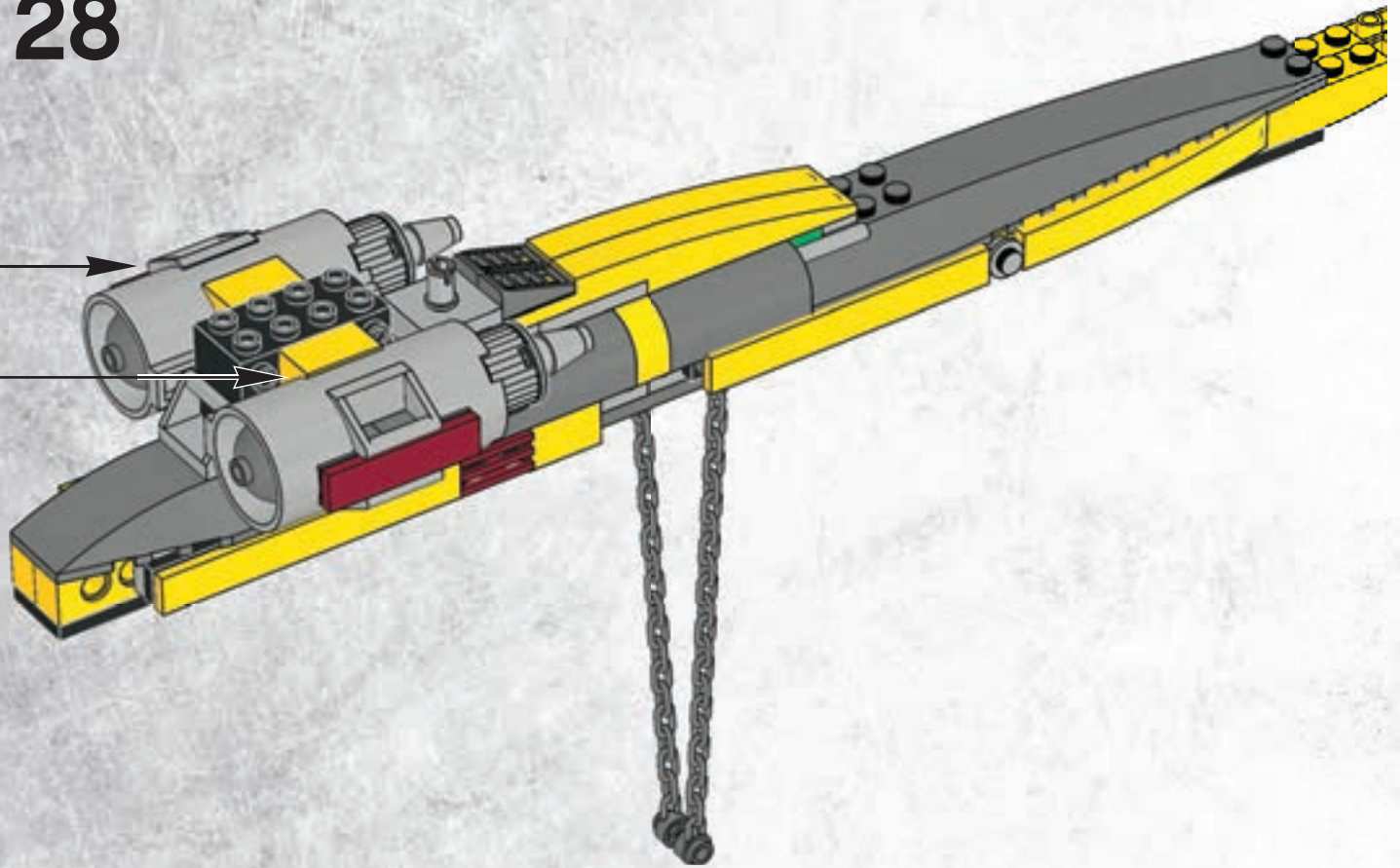



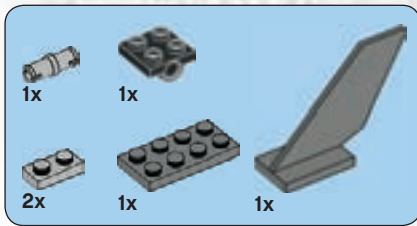

**29**

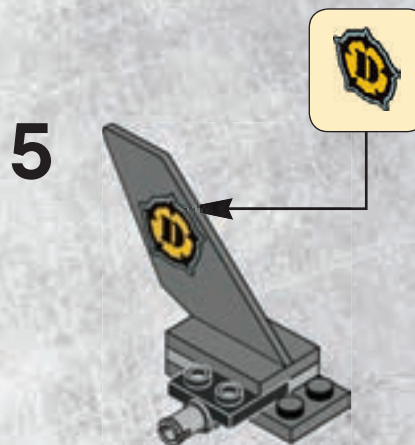
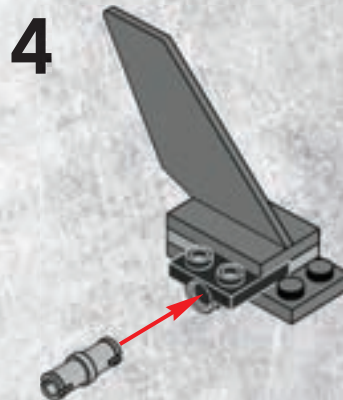
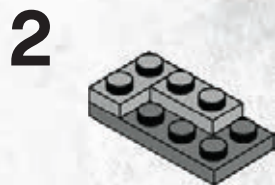

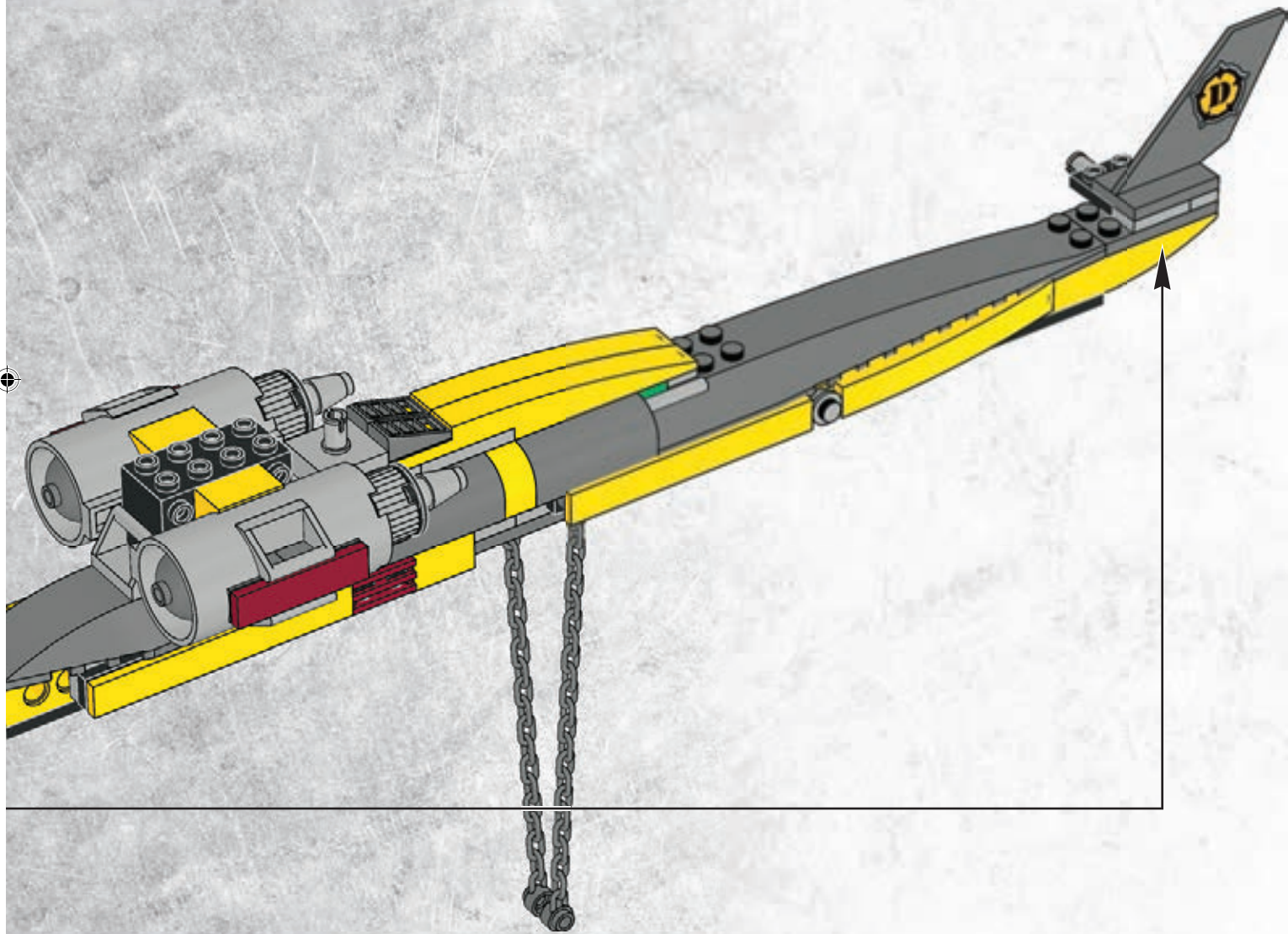





# 30

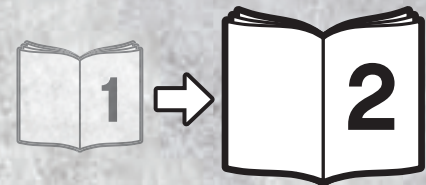
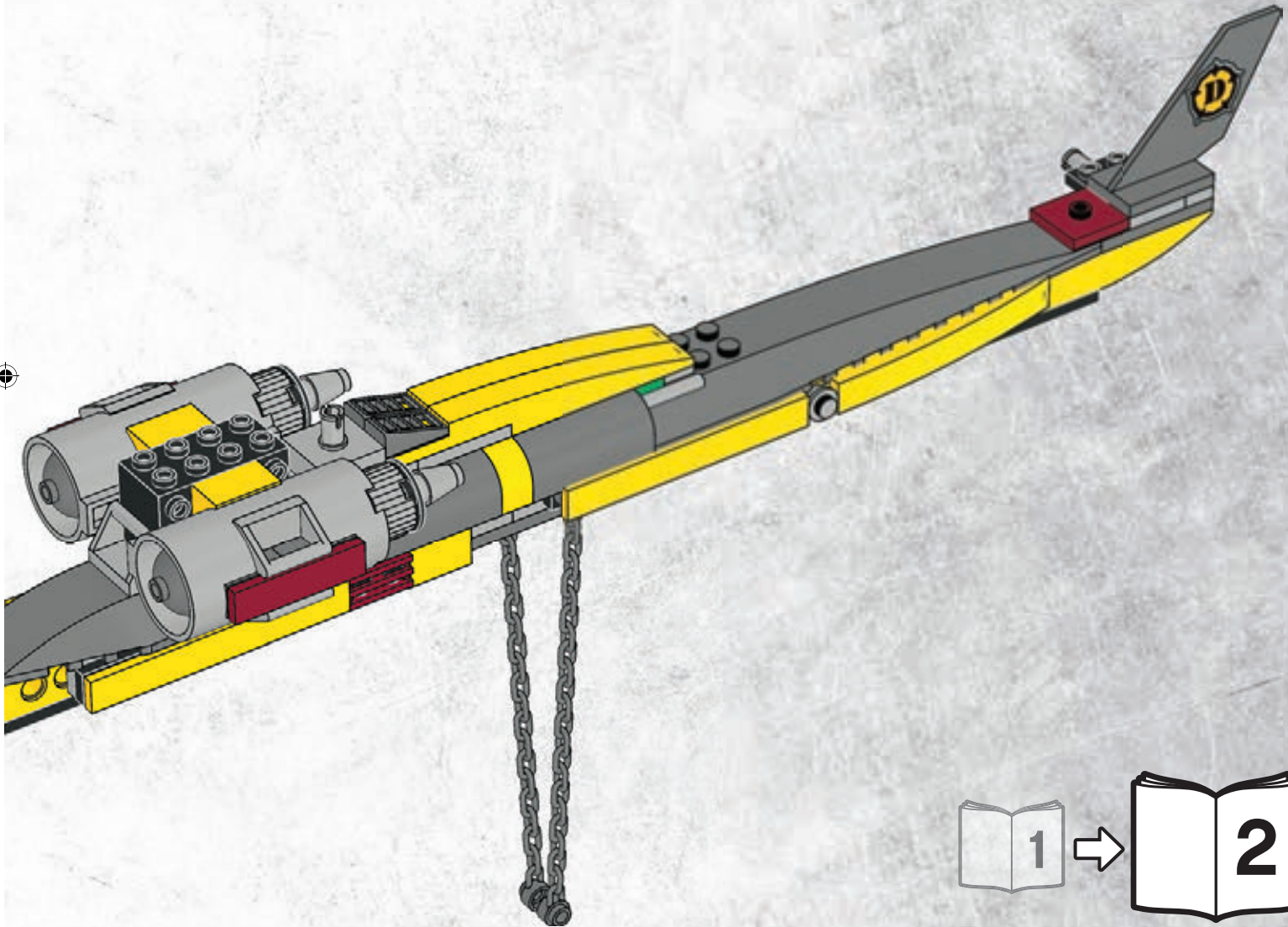





6002939

LEGO and the LEGO logo are trademarks of the LEGO Group. ©2012 The LEGO Group.







# DINO

5886





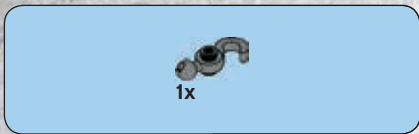
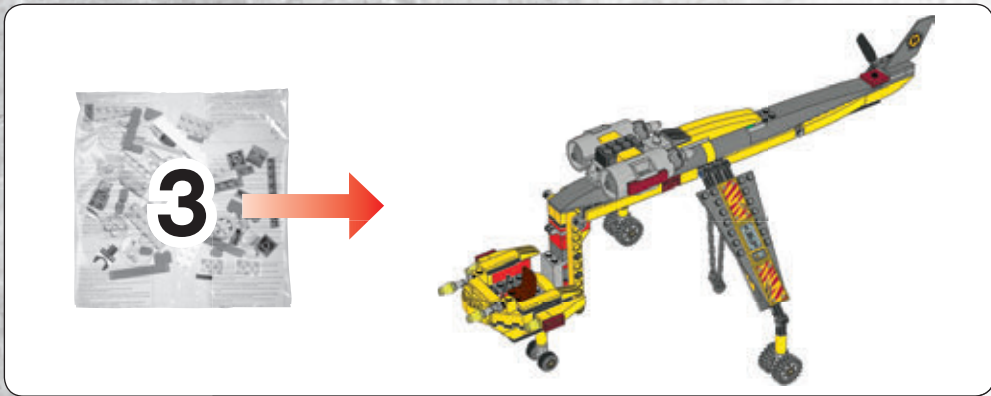

1

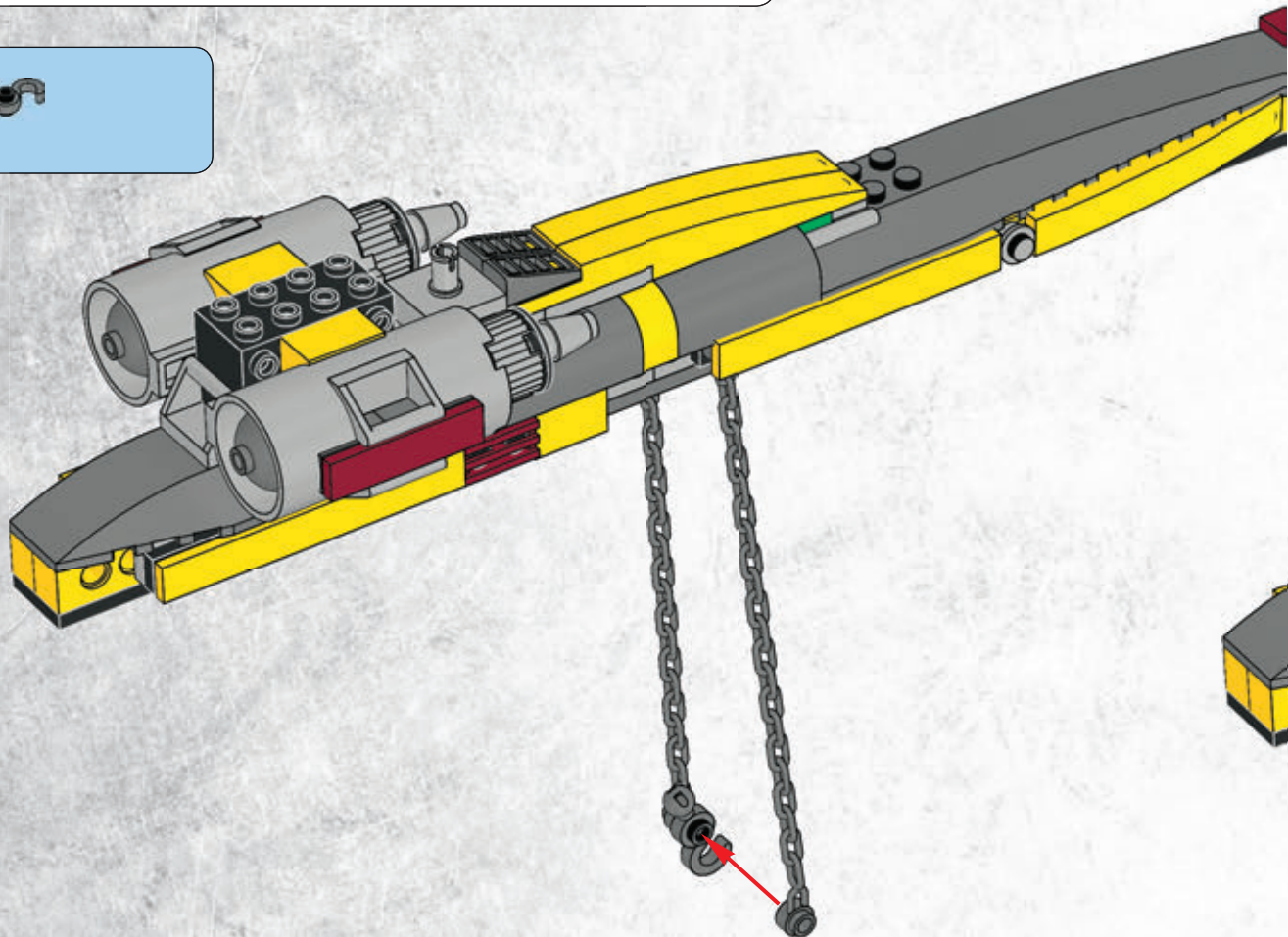

2



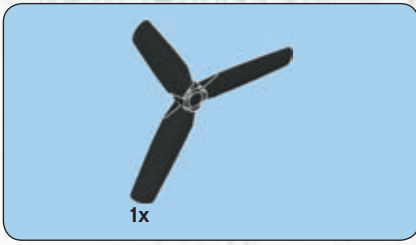

2

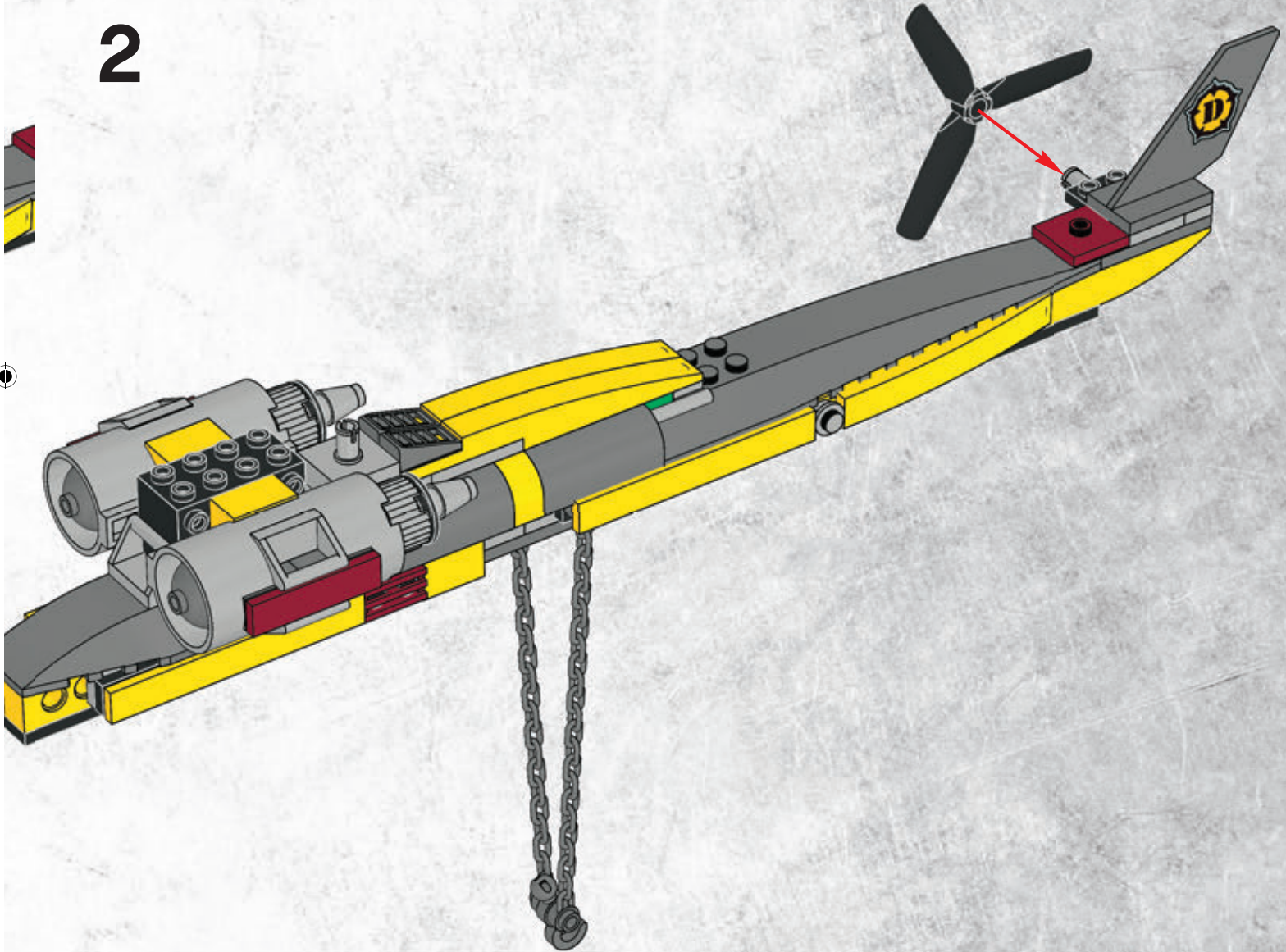

3



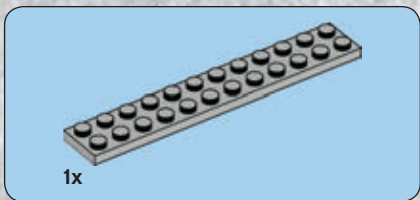

1x

1

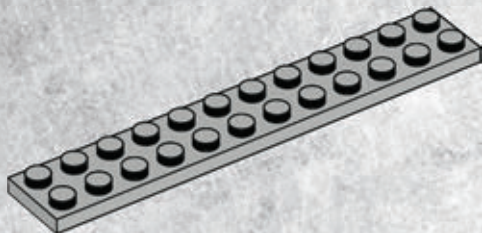

4



2x

2

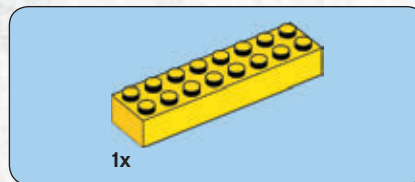
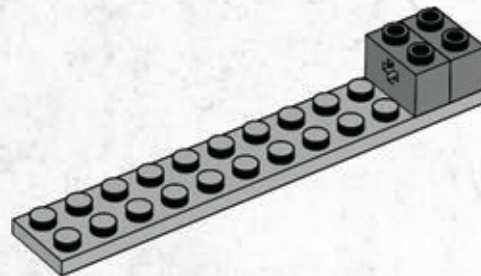

1x

3

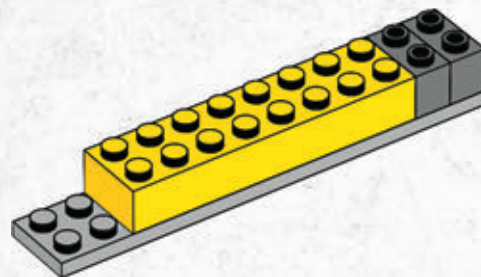





4

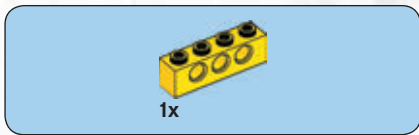
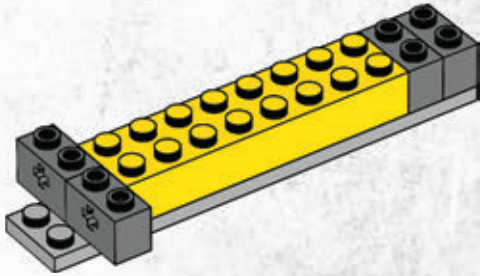

5

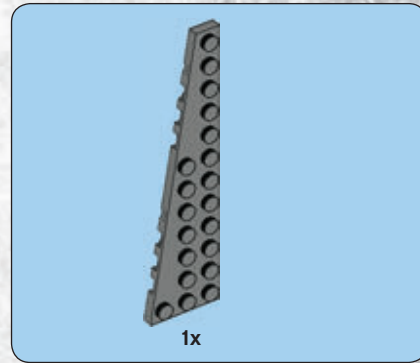
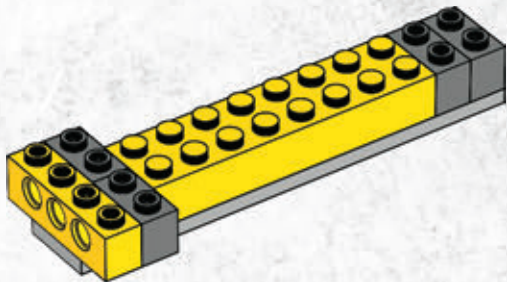

6

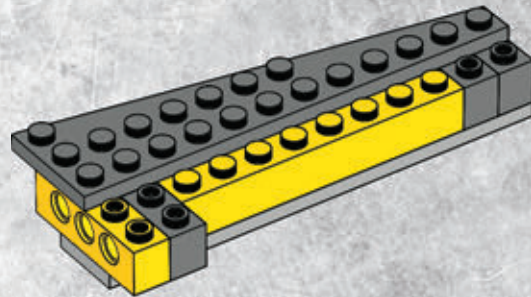

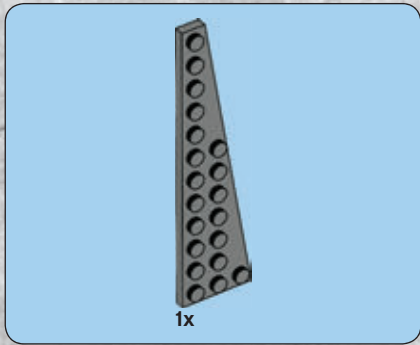

7

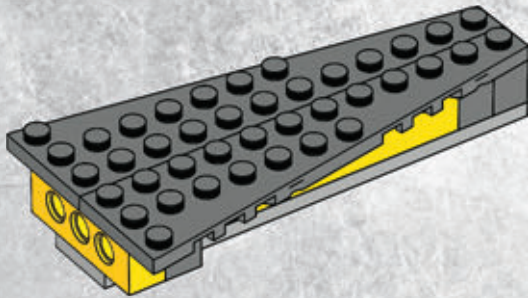

6

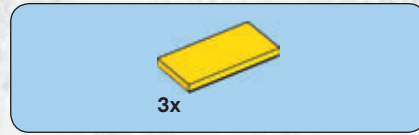

8

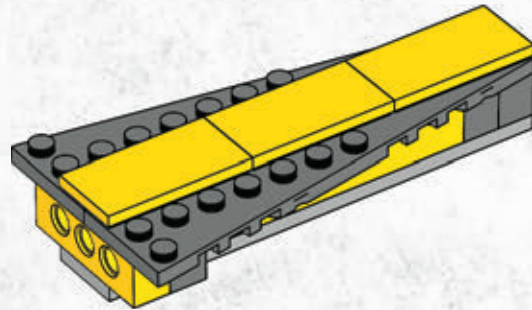



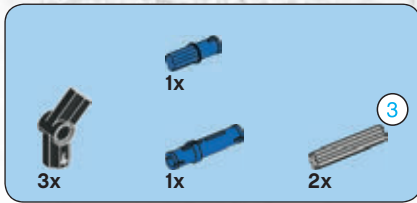

9

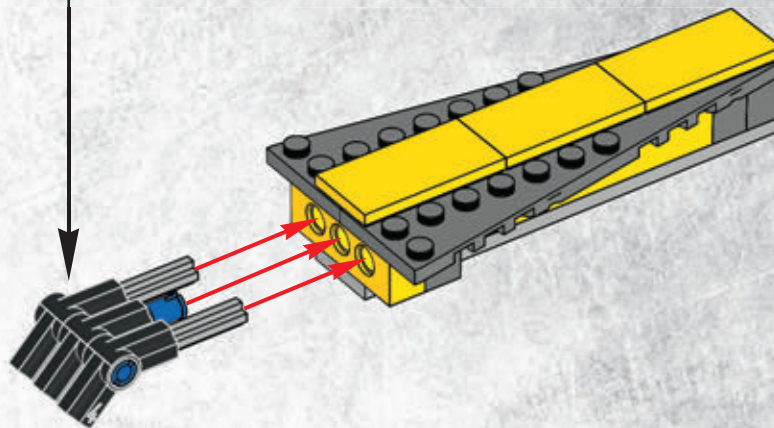
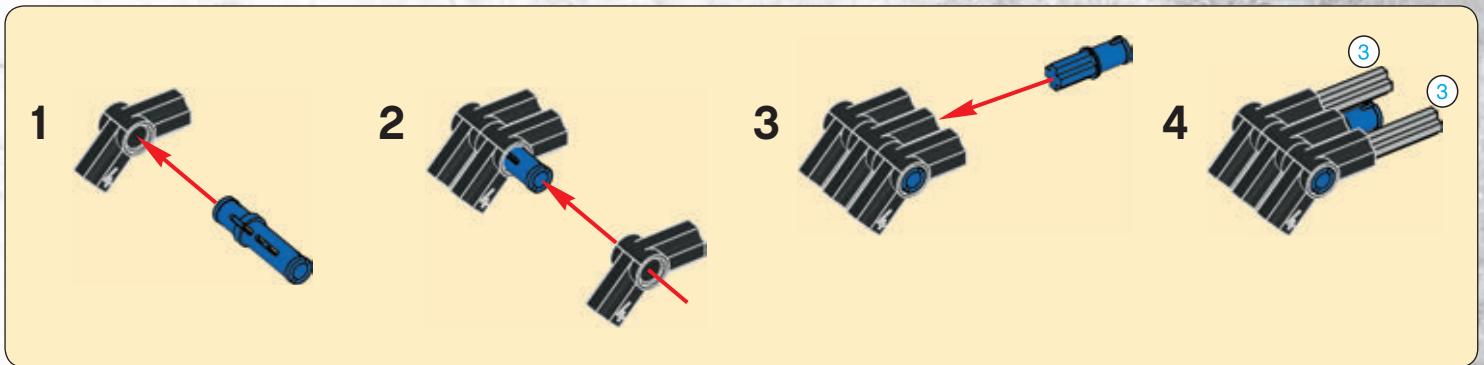

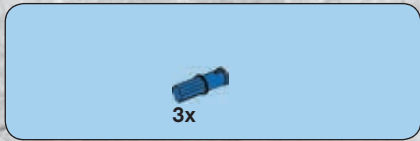

10

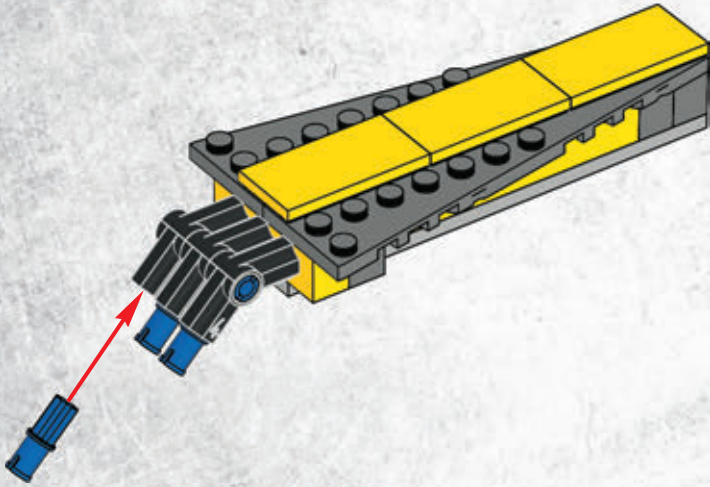



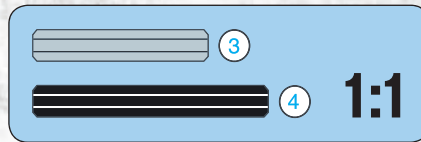
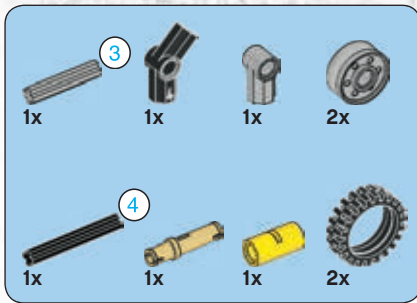

# 11

1

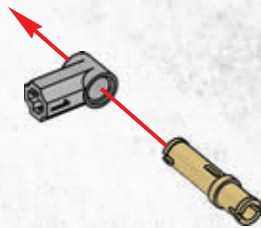

3

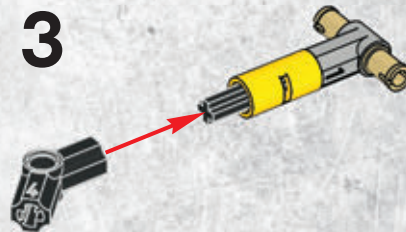

2

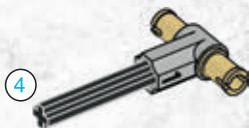

4

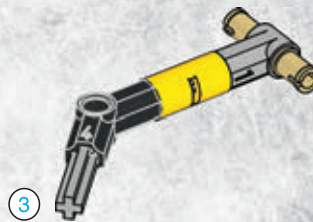

5



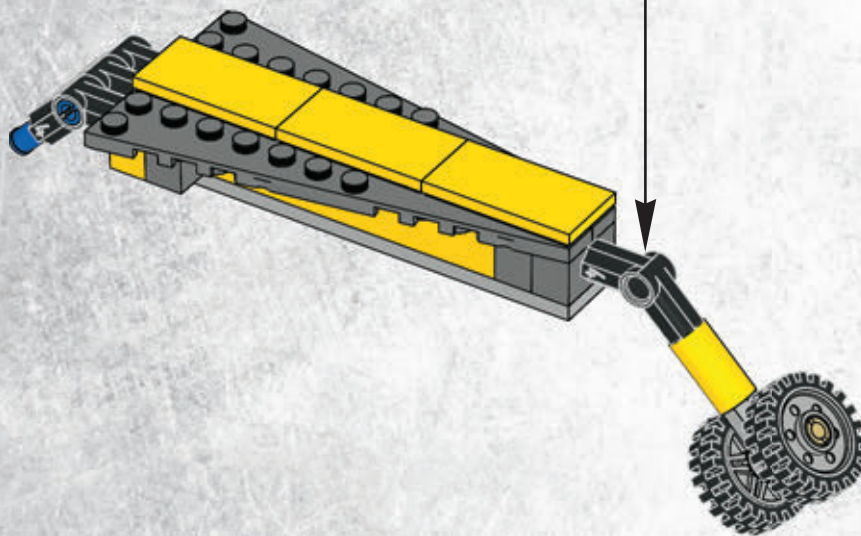

**2x**



12





13

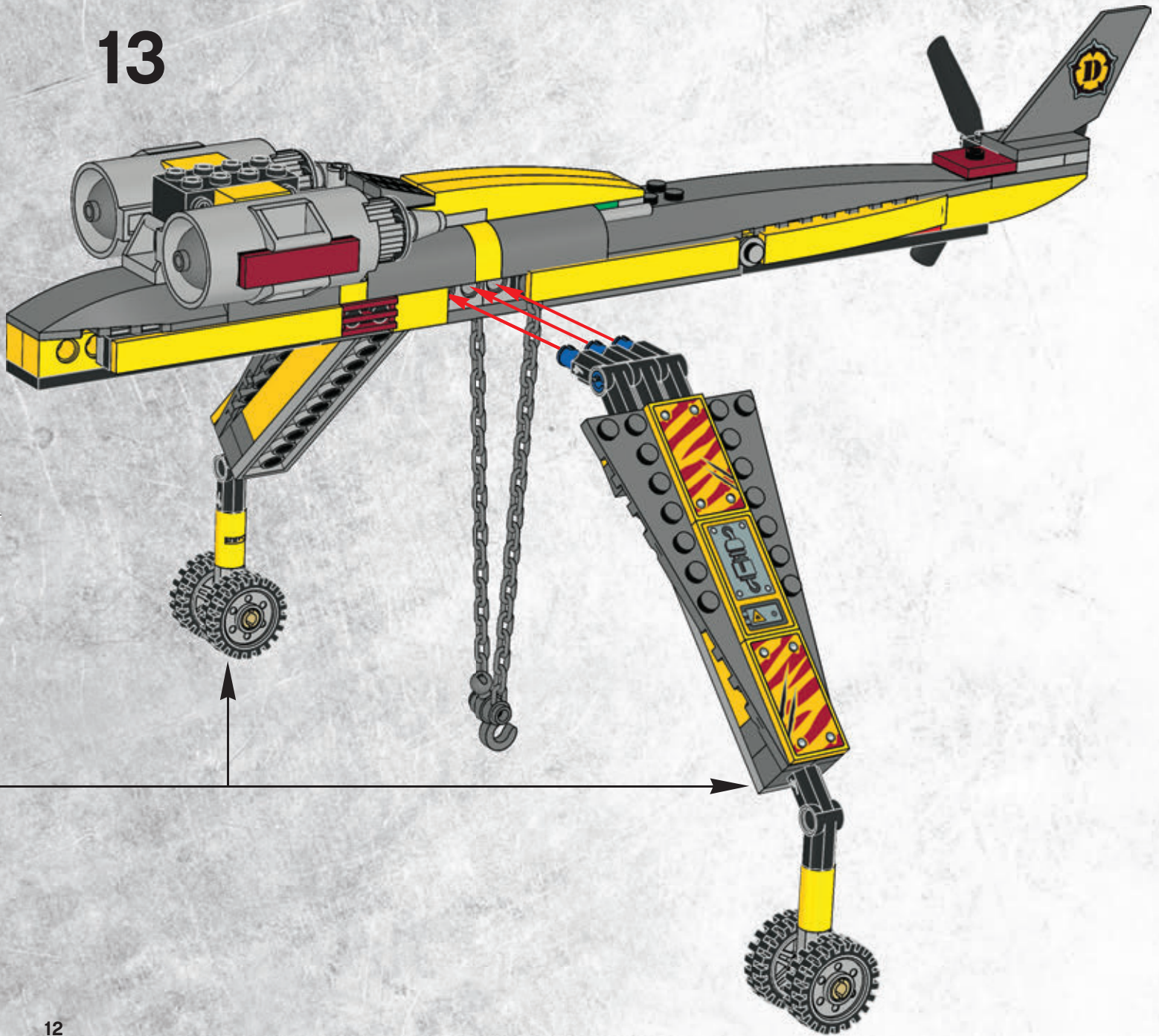

12



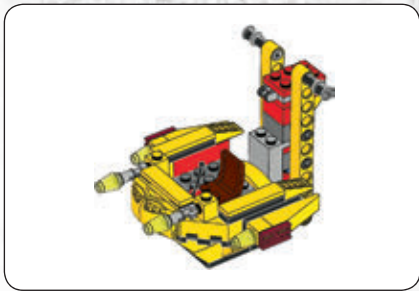

**1**

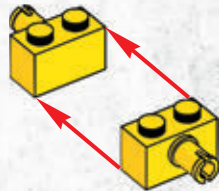

**2**

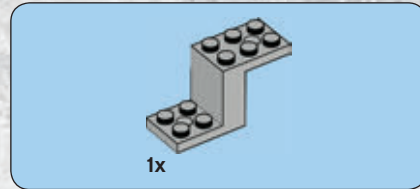

**3**

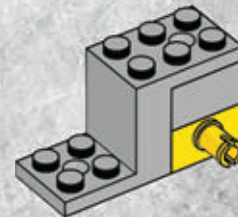

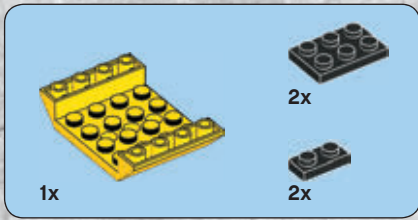

4

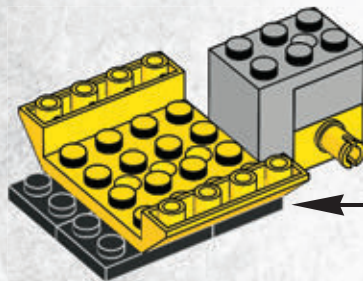
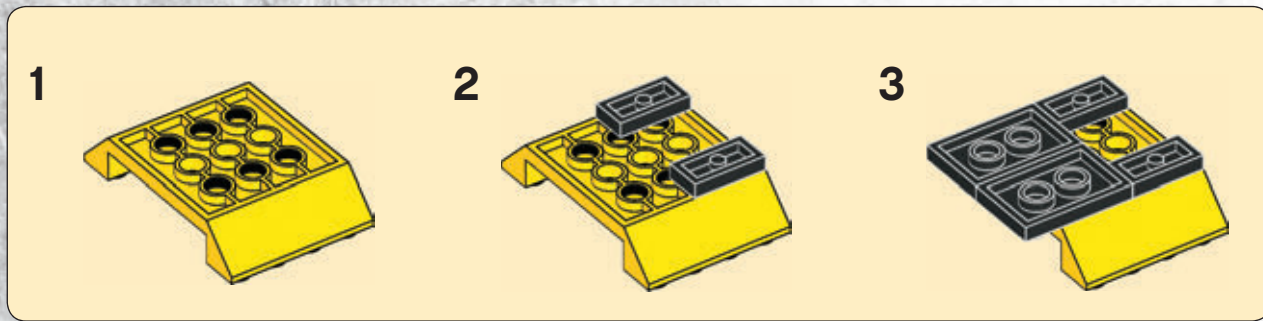





5

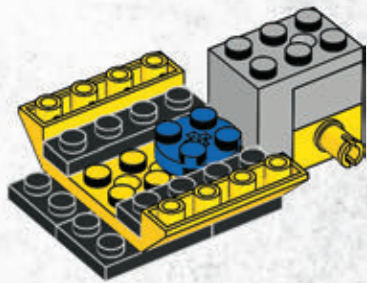

6

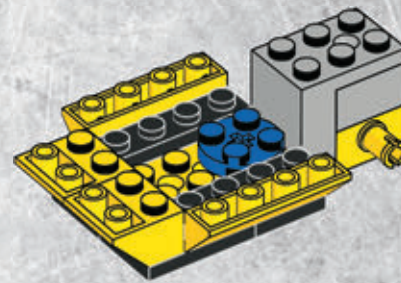



2x



1x

# 7

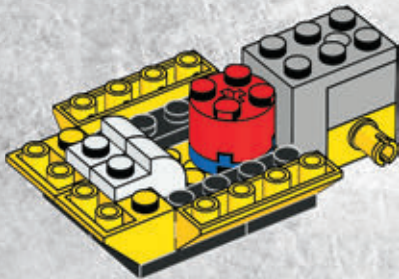

2x

# 8

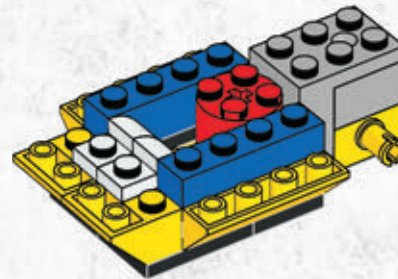





9

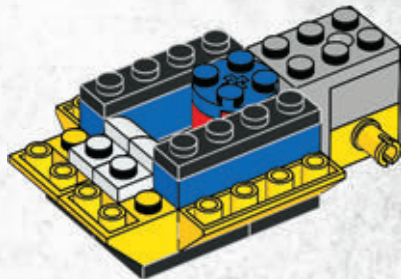

10

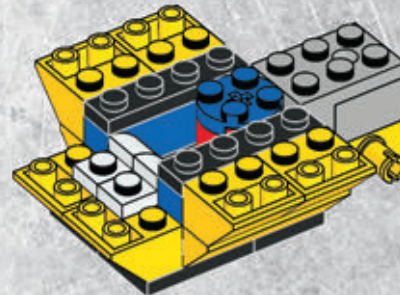



2x

# 11

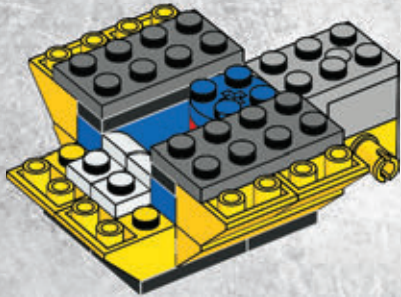

2x

# 12

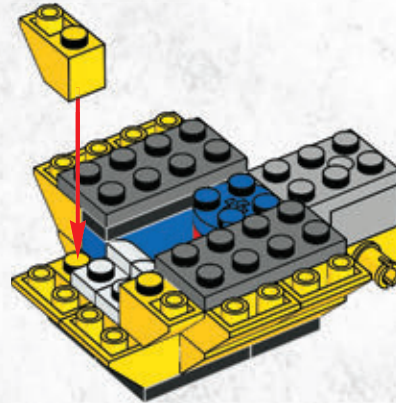





13

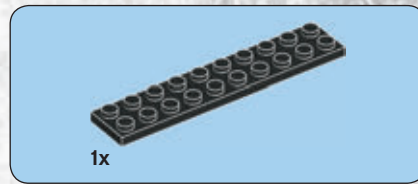
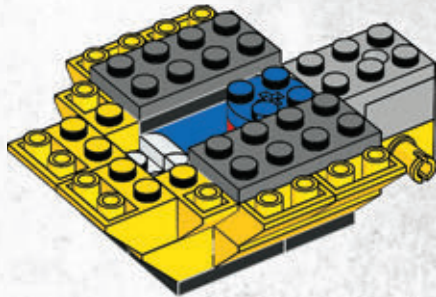

14

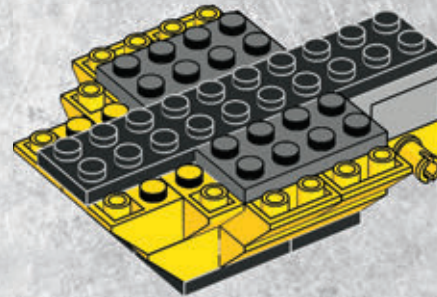



15

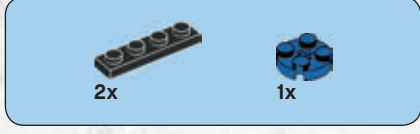
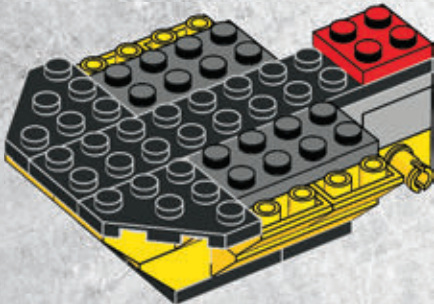

16

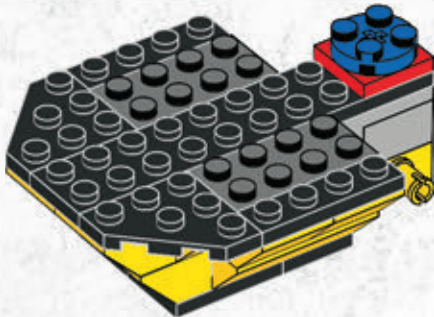



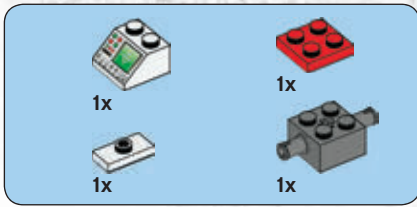

# 17

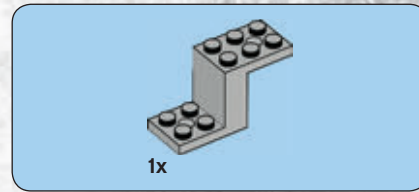
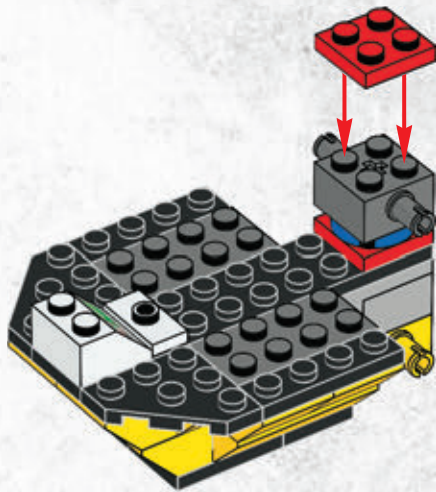

# 18

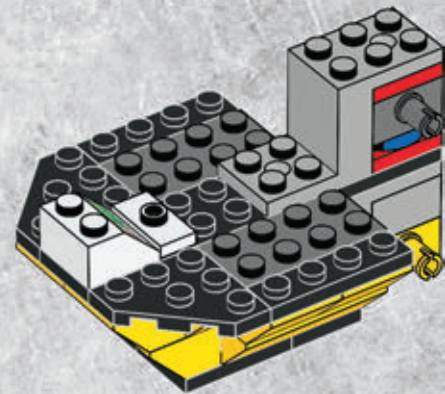

21



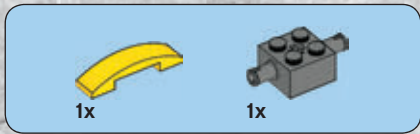

19

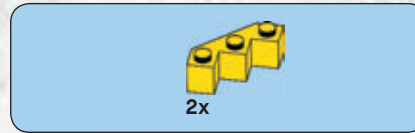
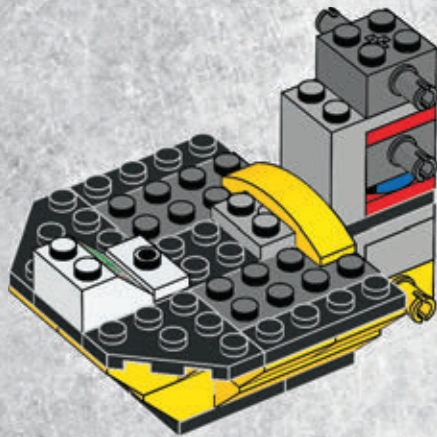

20

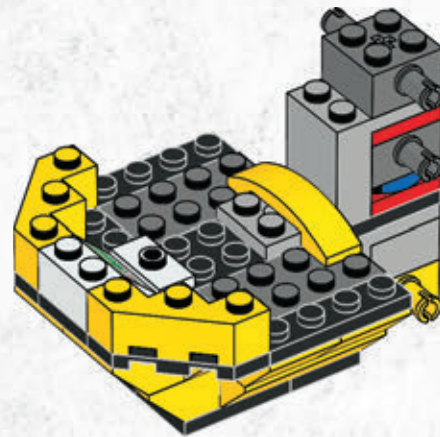



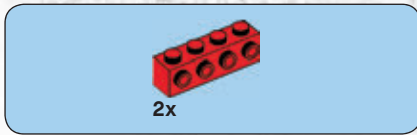

21

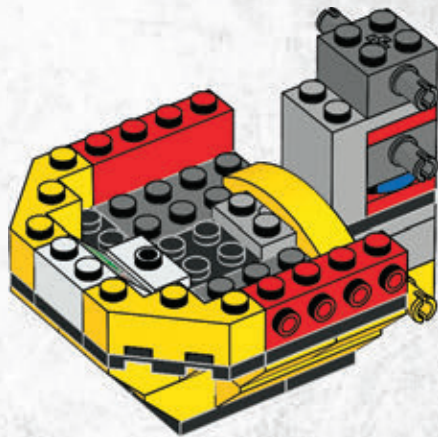

22

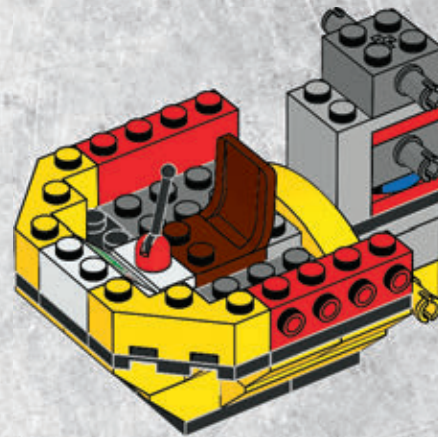





# 23

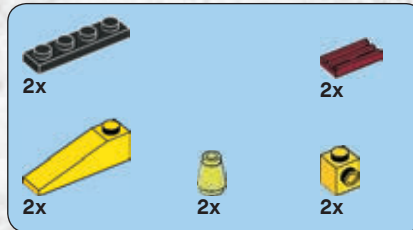
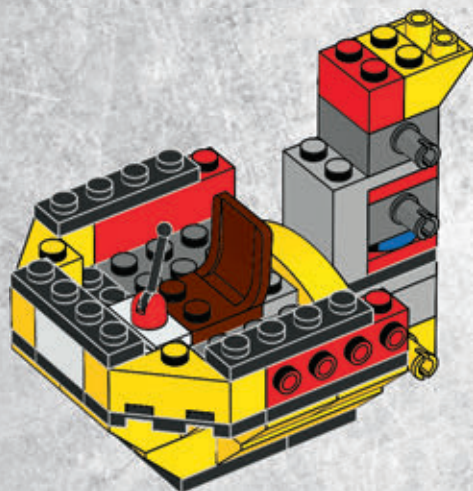

# 24

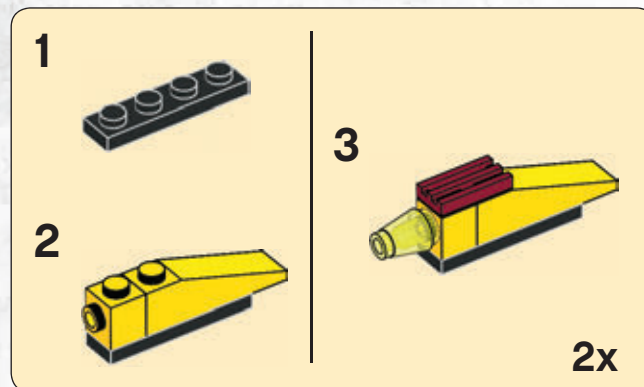

2x

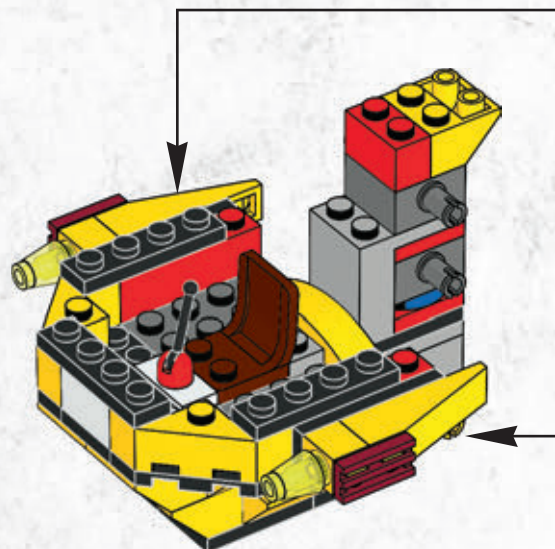

24



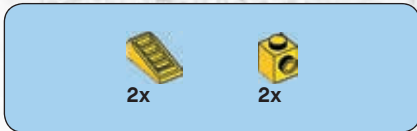

# 25

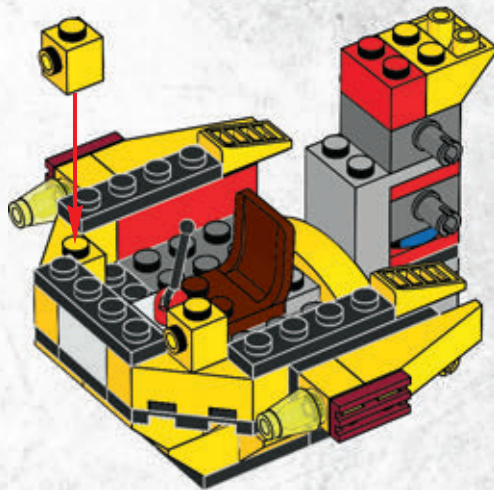

# 26

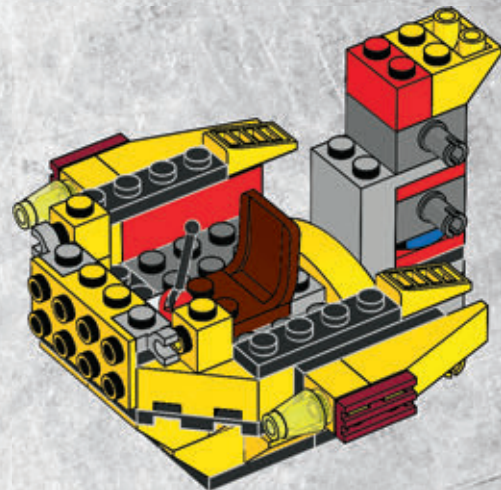



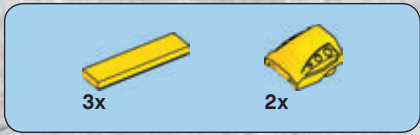

# 27

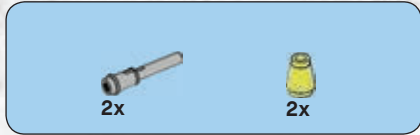
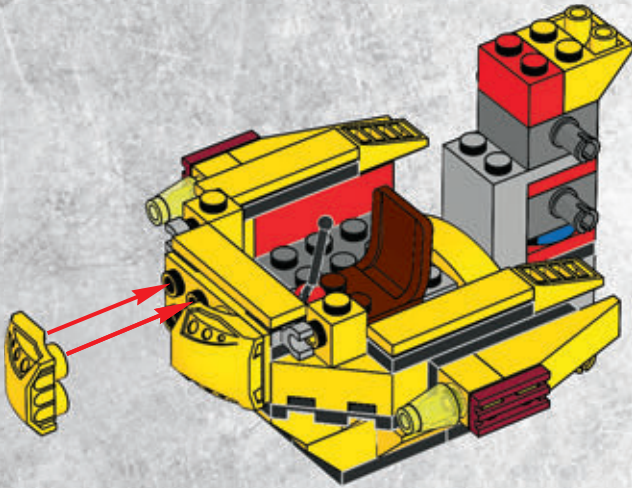

# 28

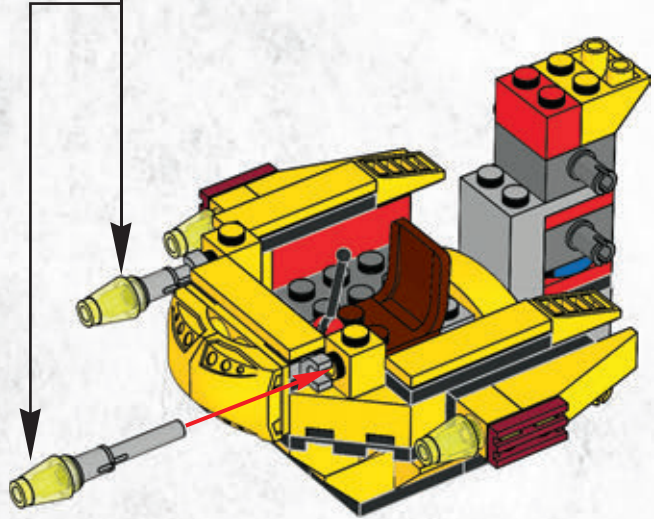
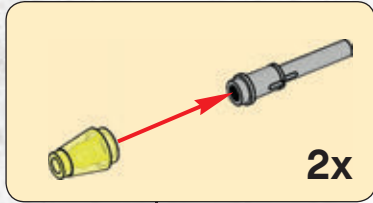





# 29

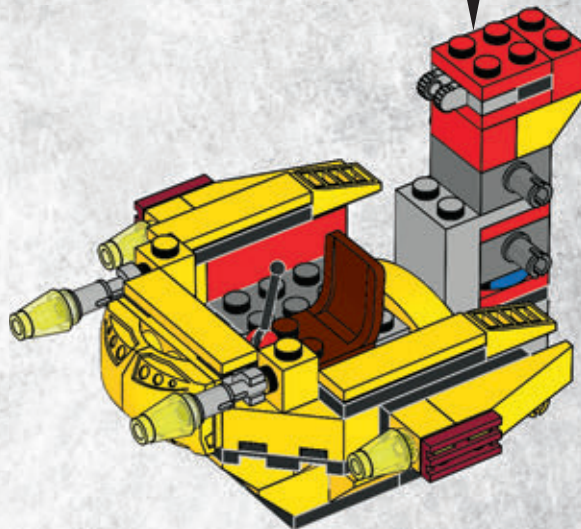
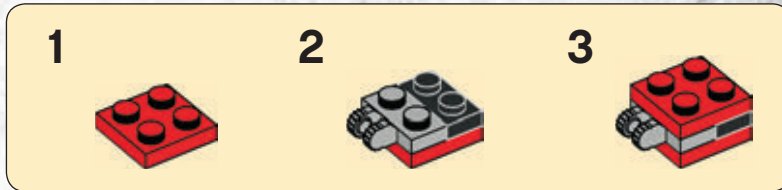



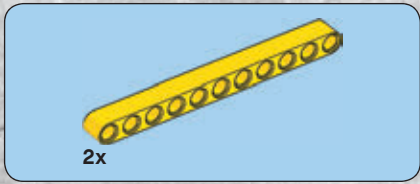

30

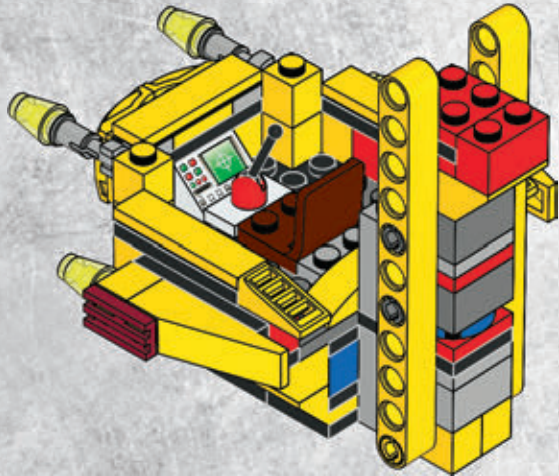

28



31

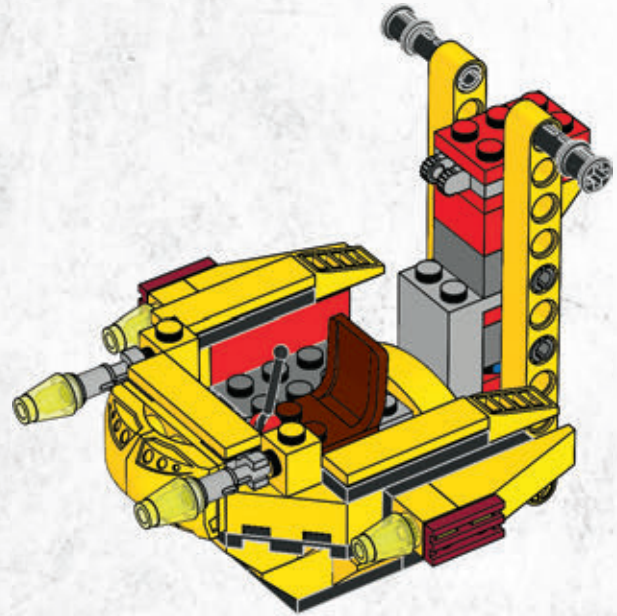



# 32

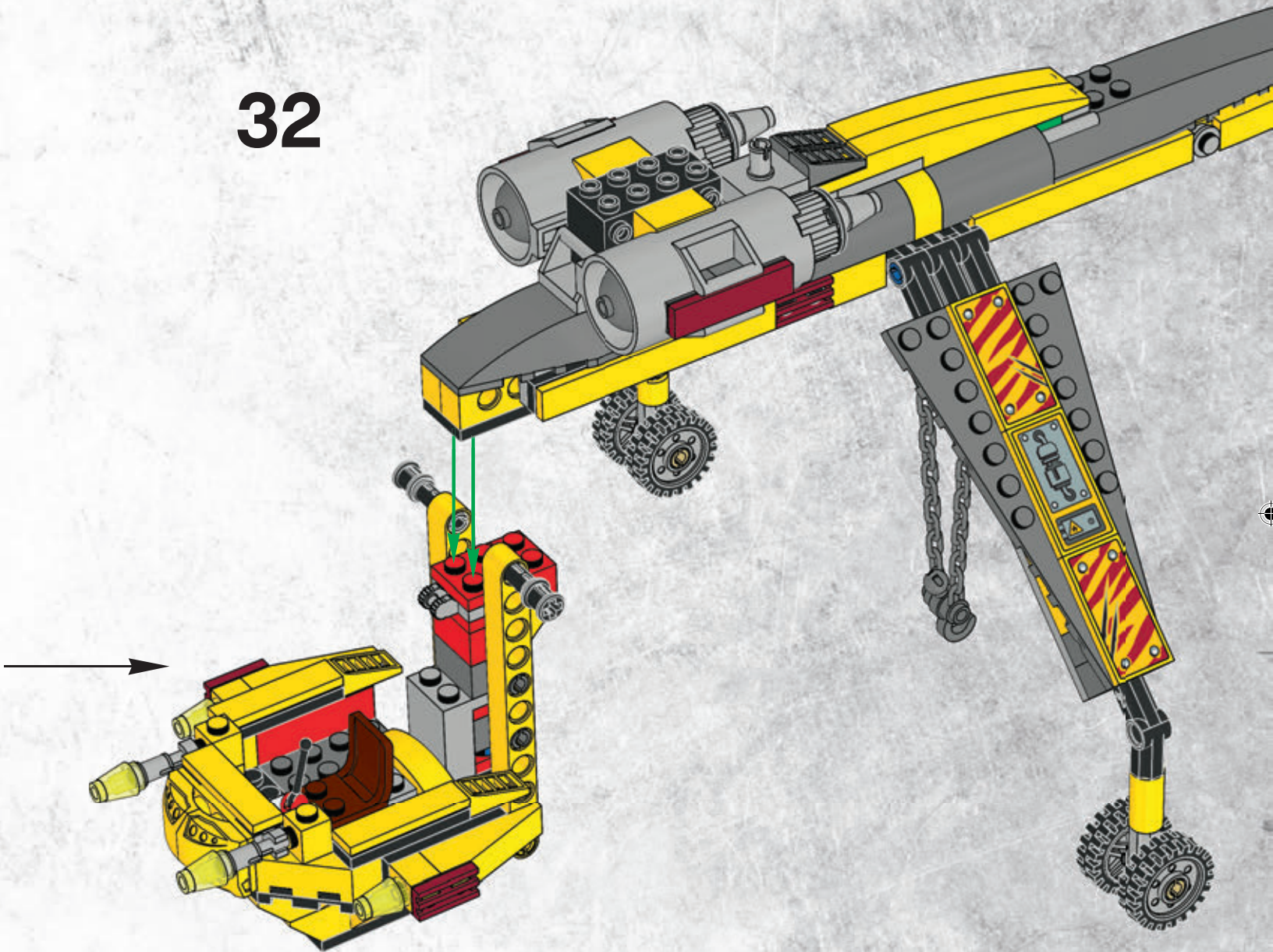



33

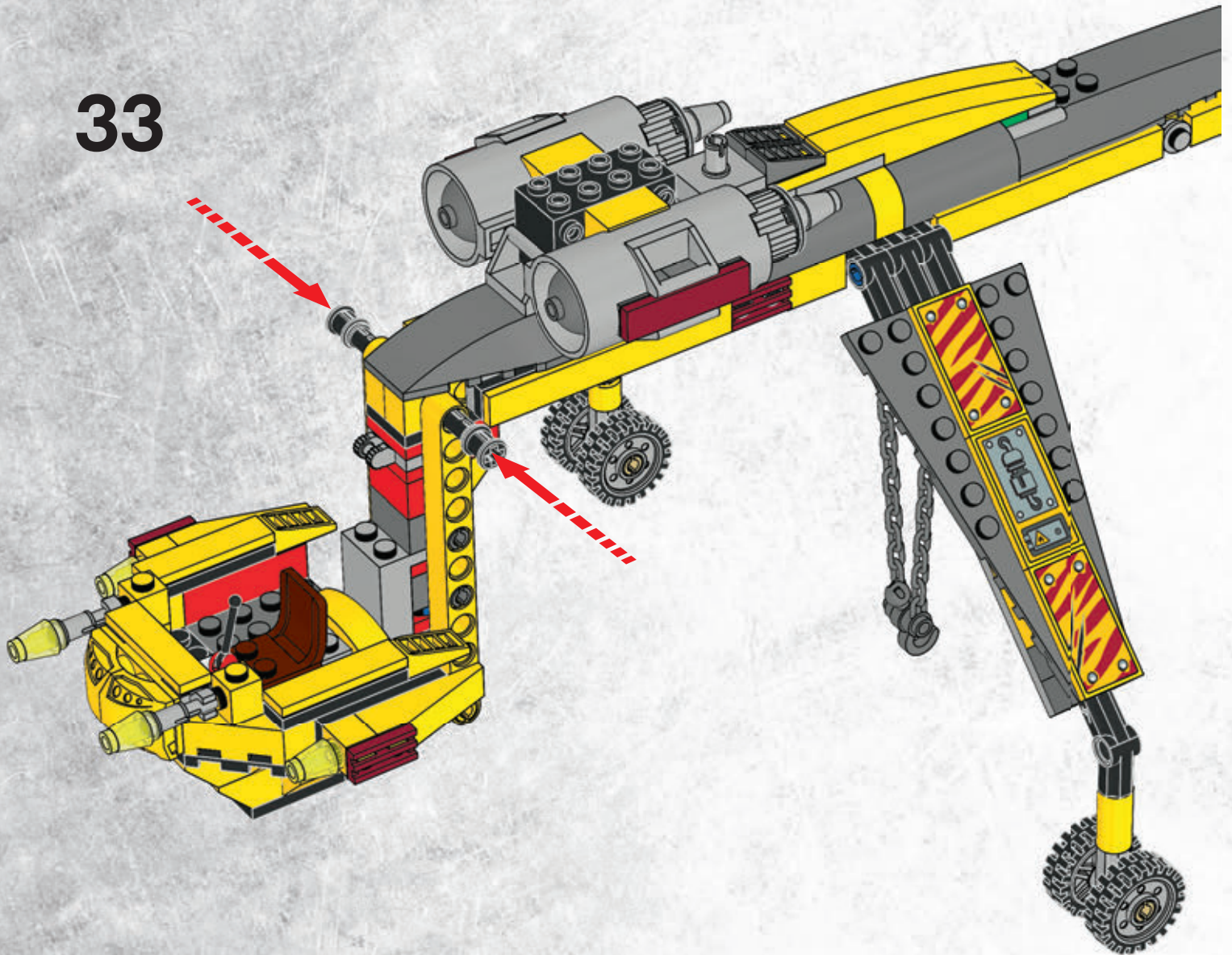



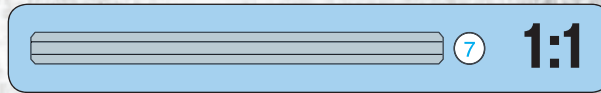
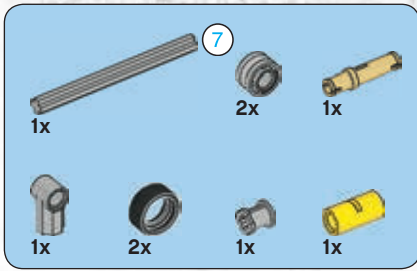

34

1

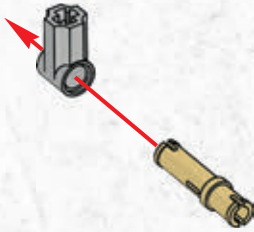

2

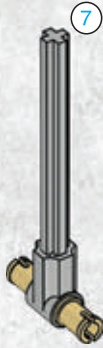

3



4

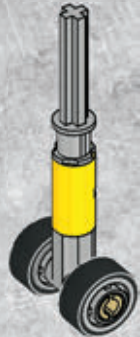



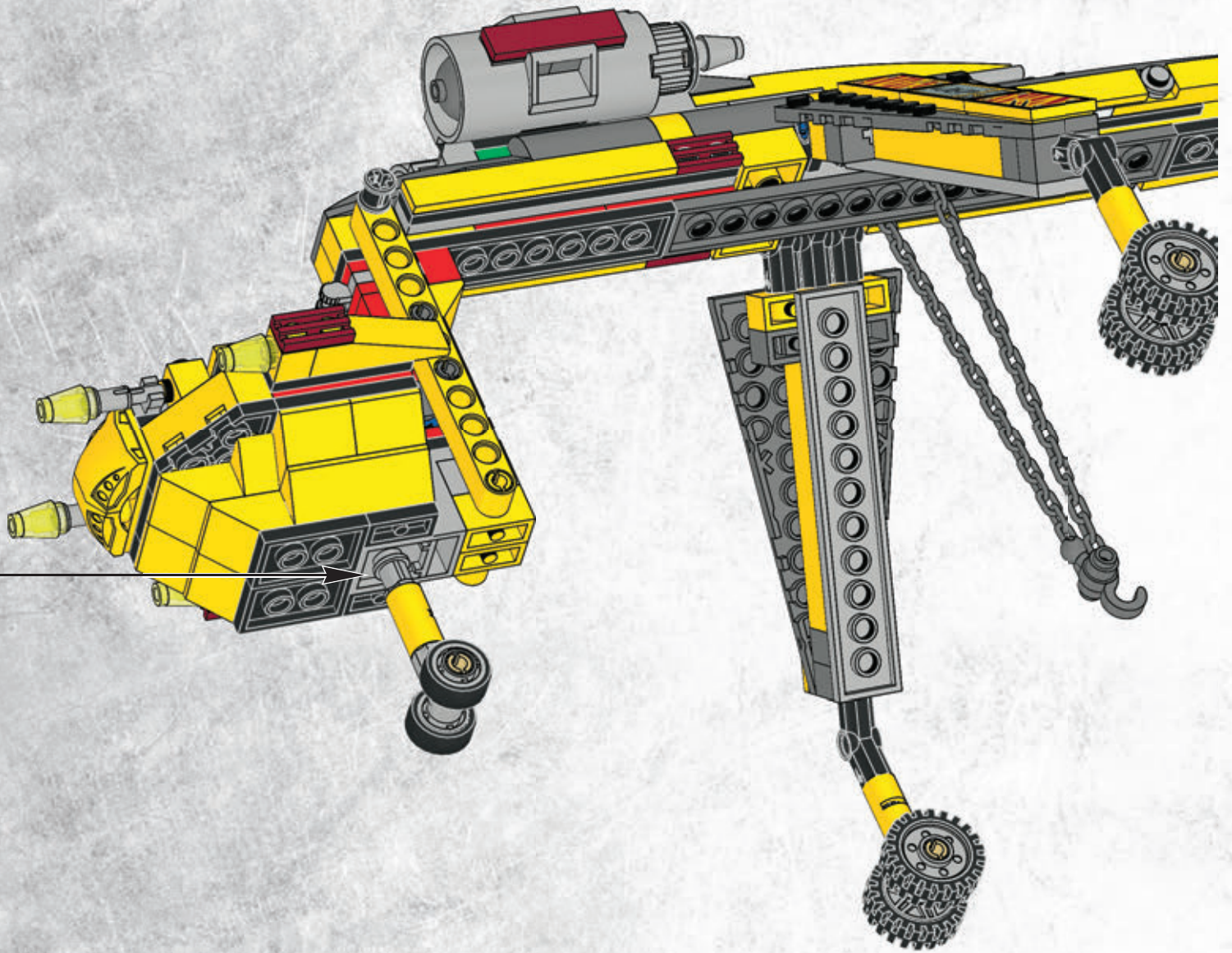



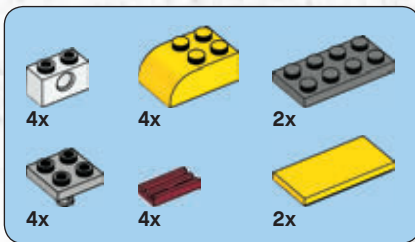
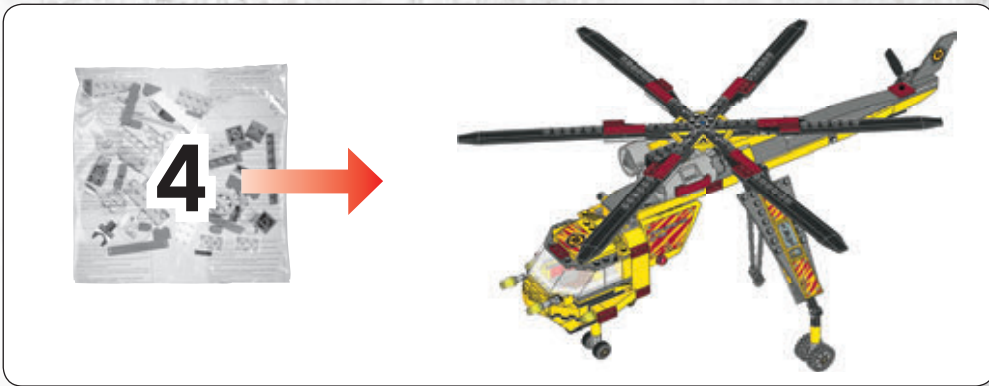

# 35

1

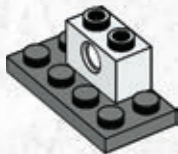

2



3

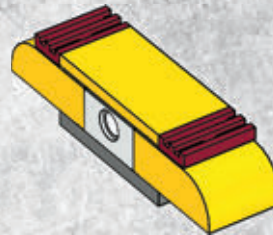

4

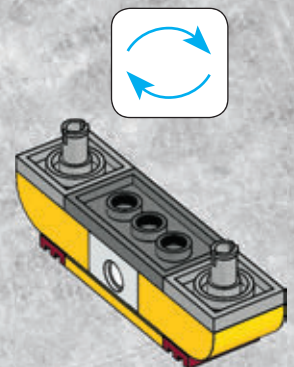

# 2x



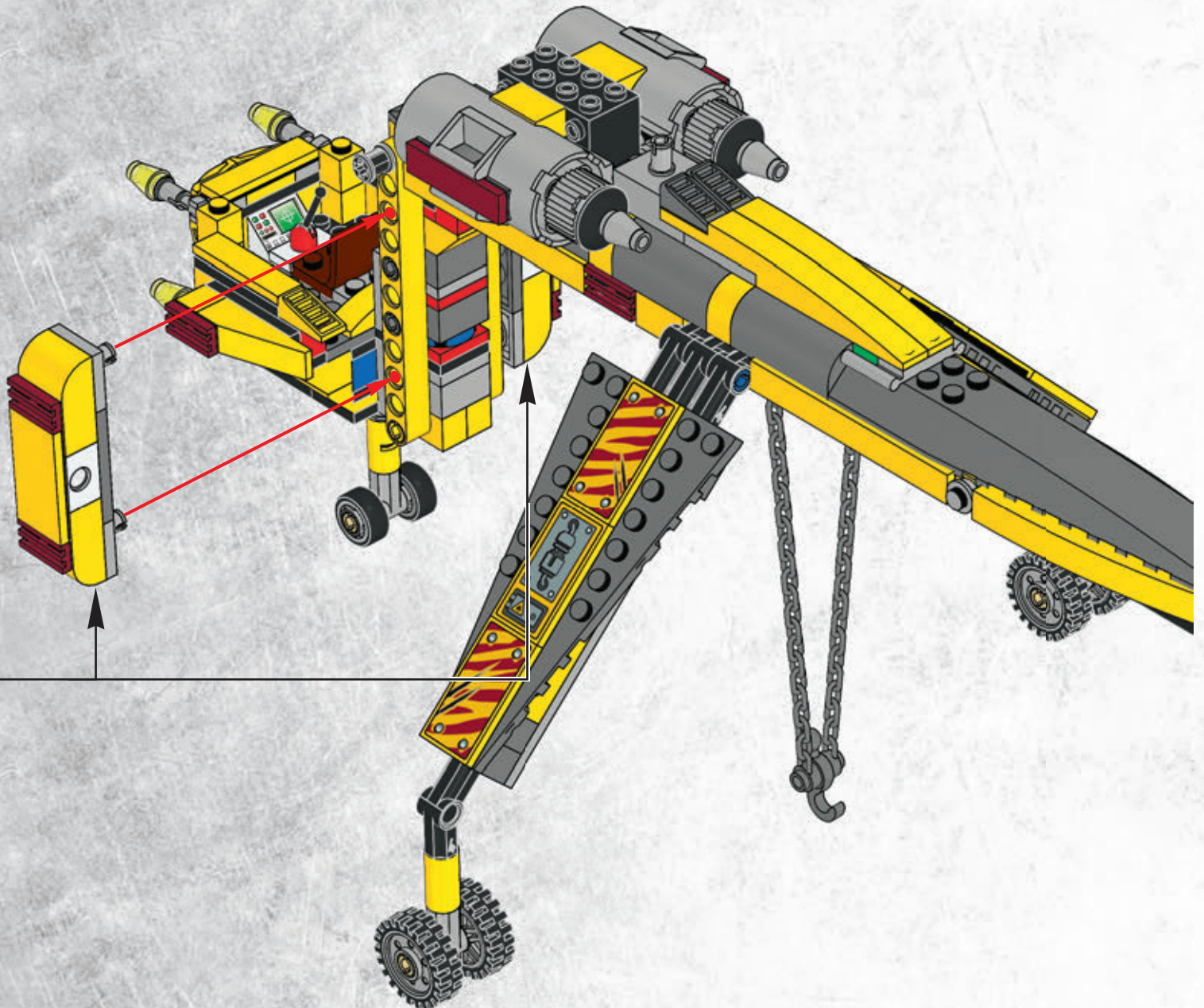



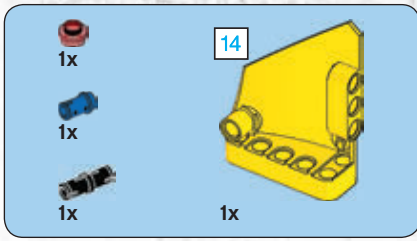

# 36

## 1

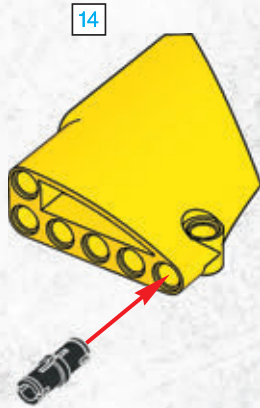

## 2



## 3





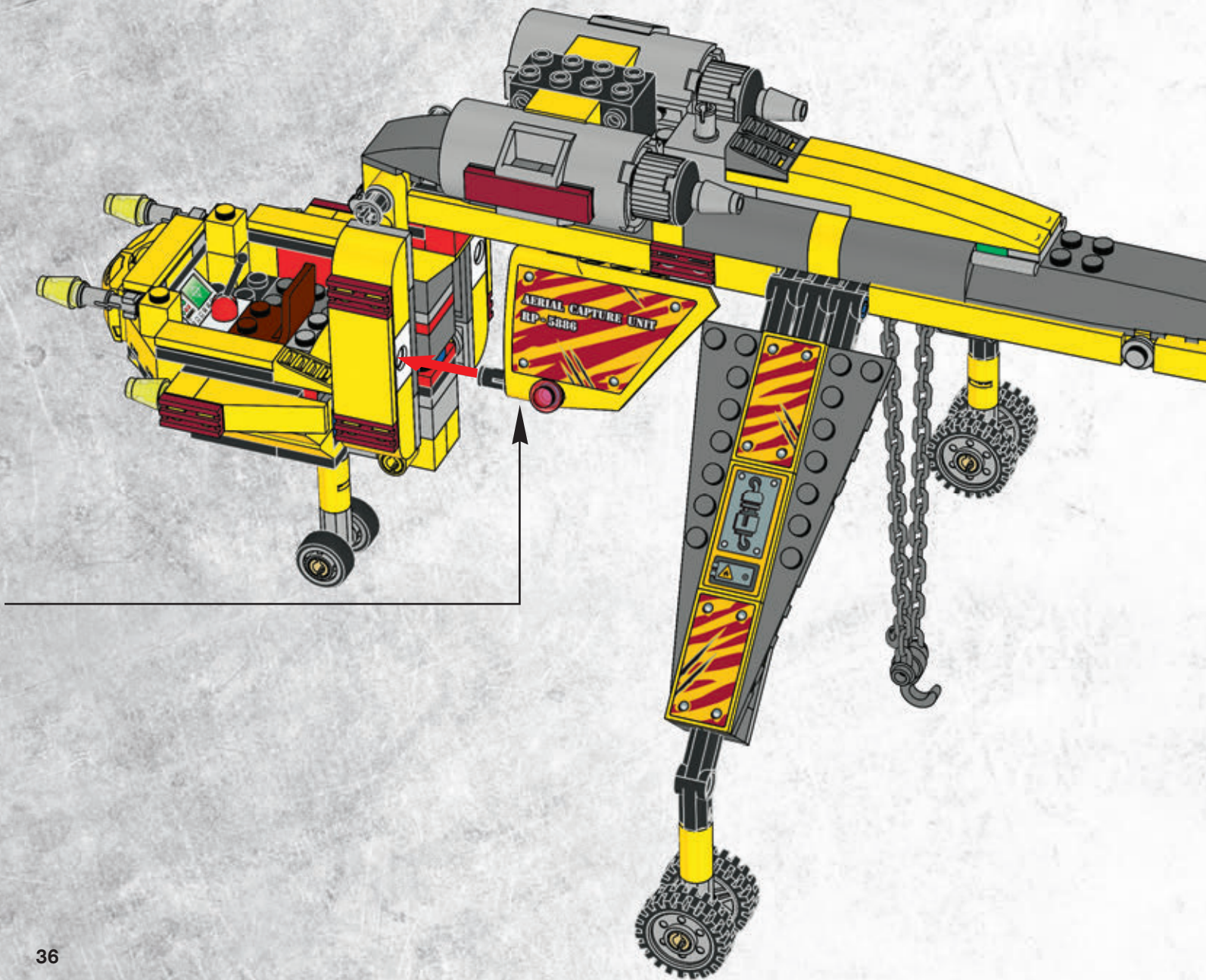



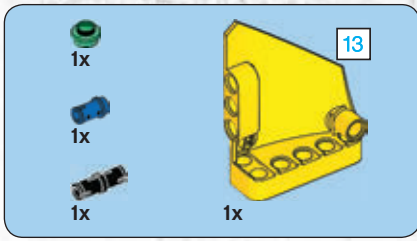

# 37

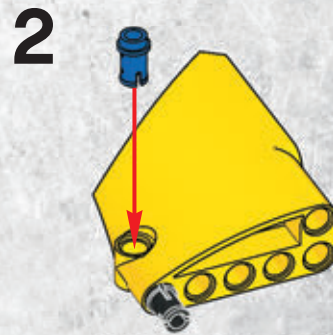
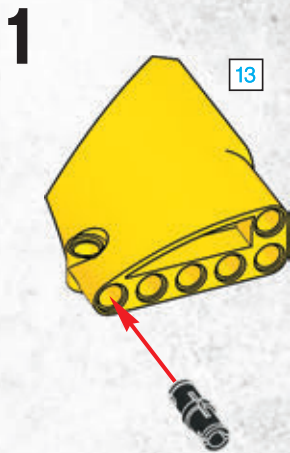



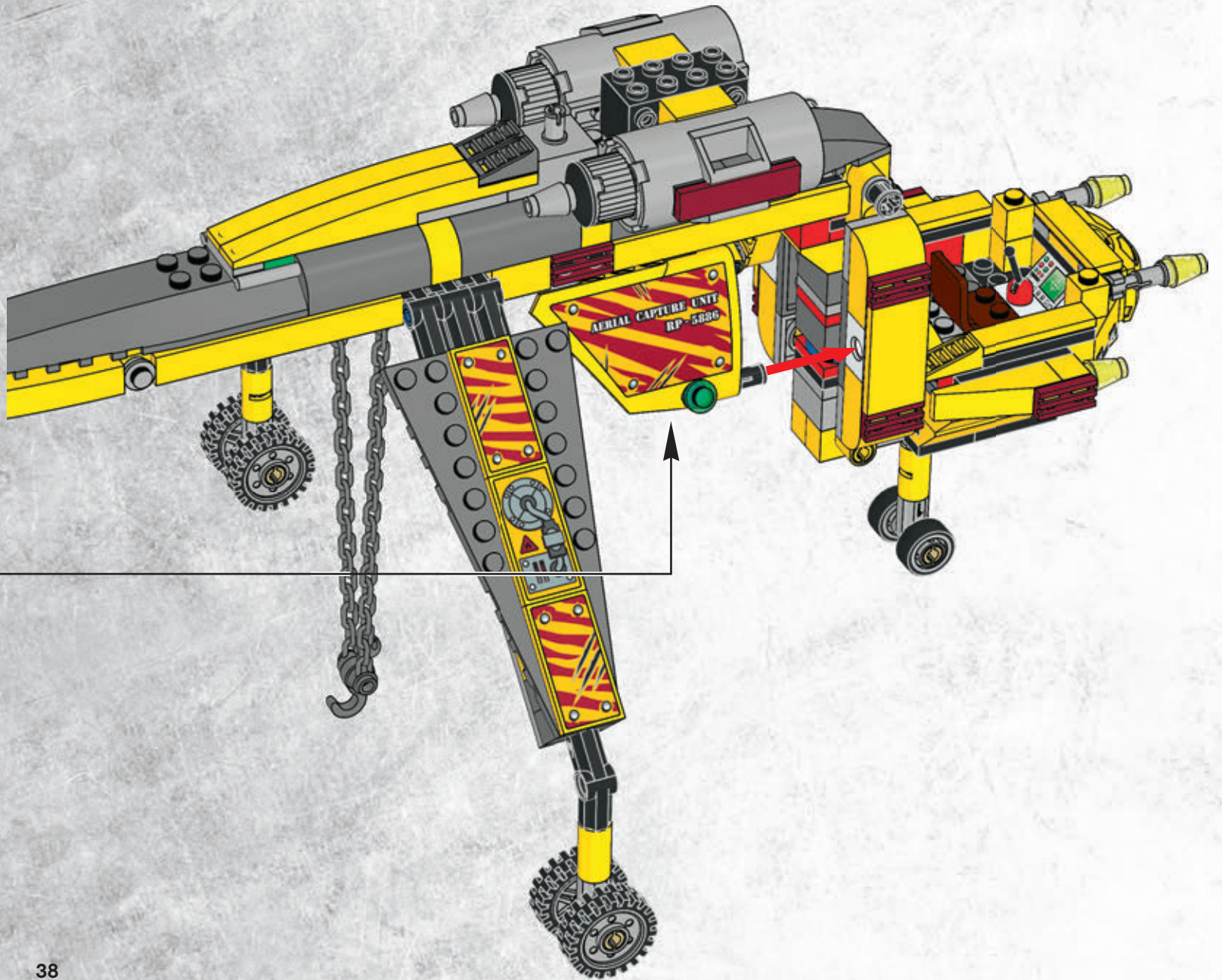



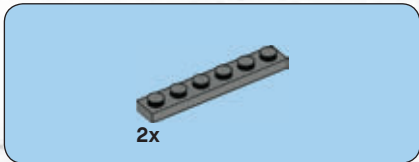

2x

1

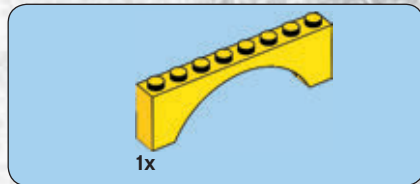
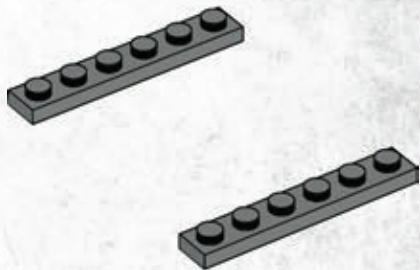

1x

2

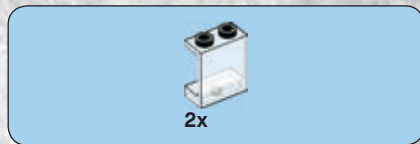
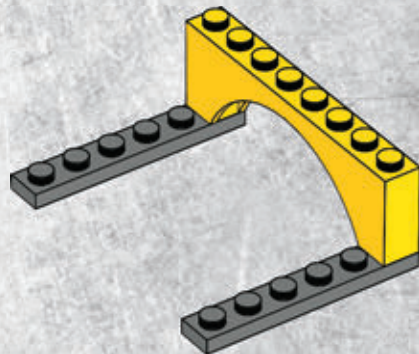

2x

3

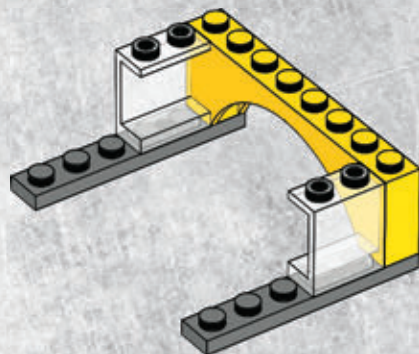



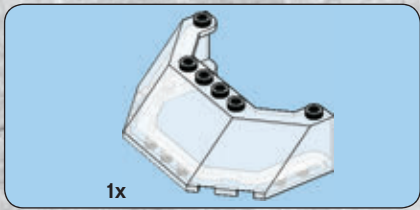

4

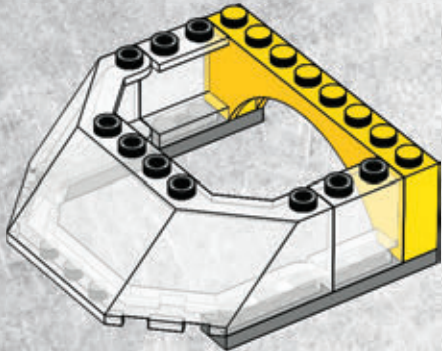

5

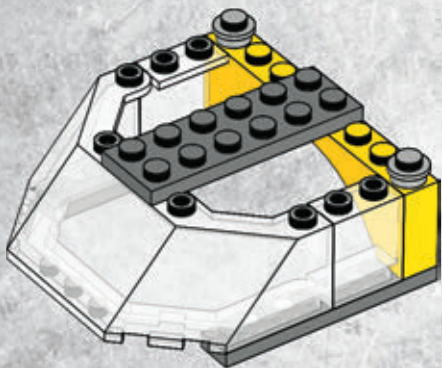

40

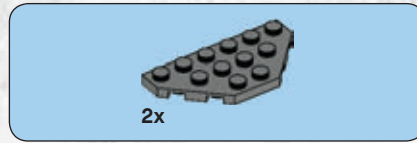

6

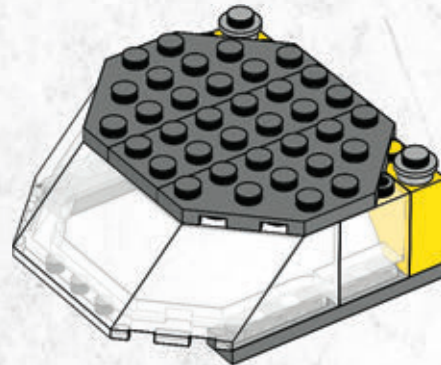

7

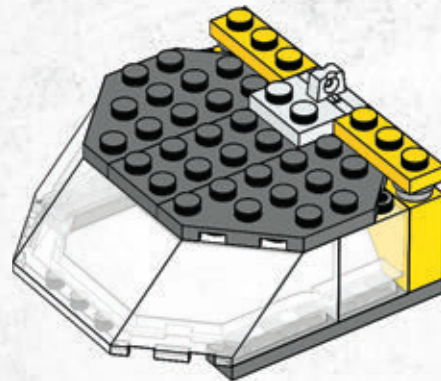



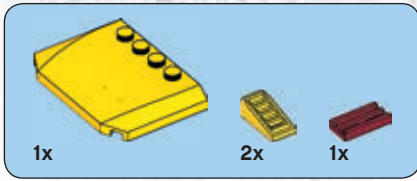

8

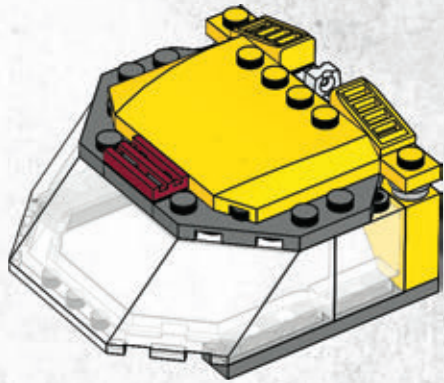

9

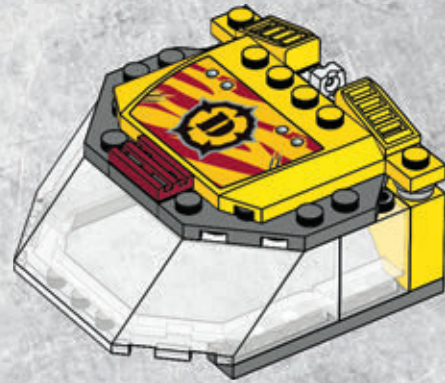



38

CLICK!

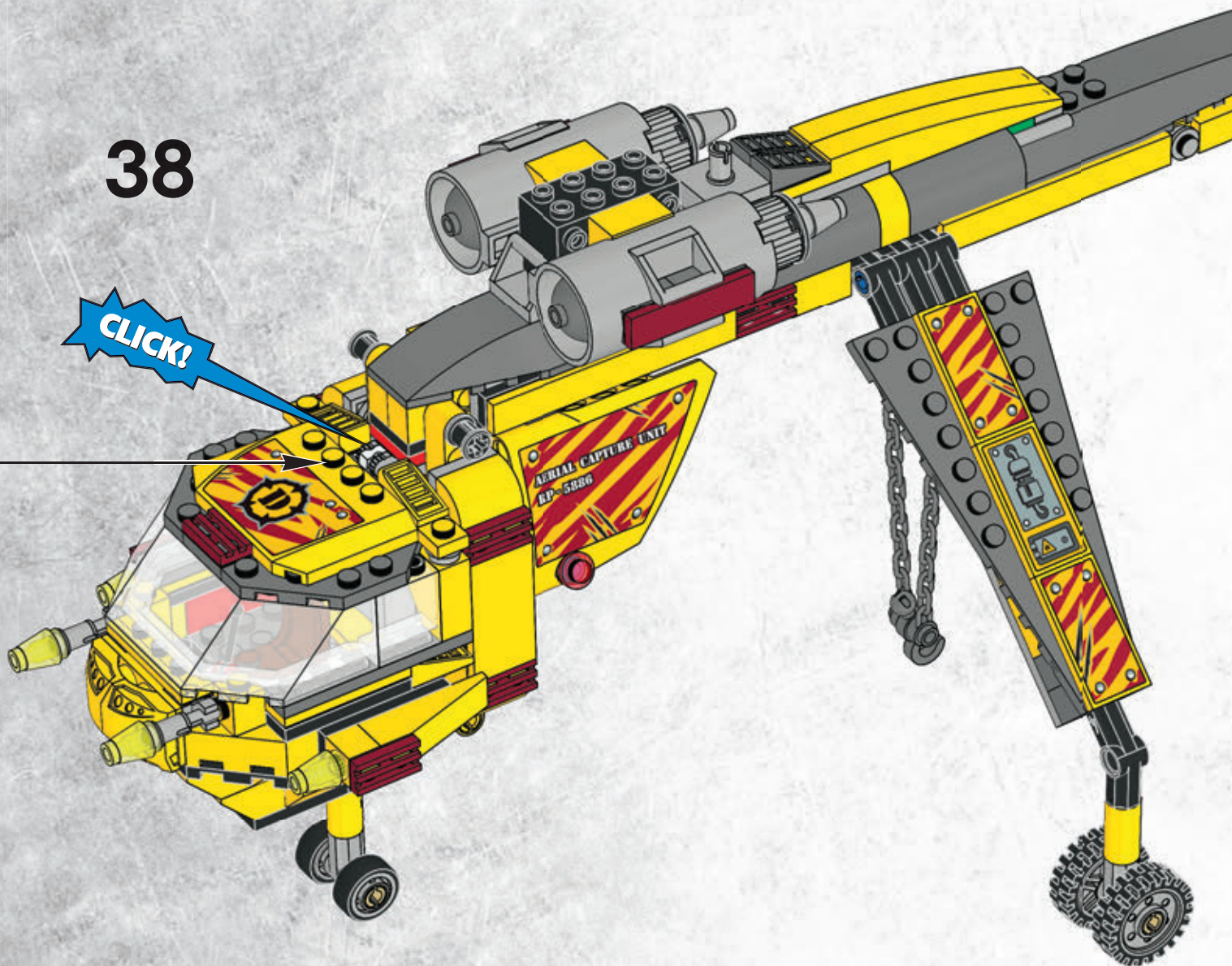



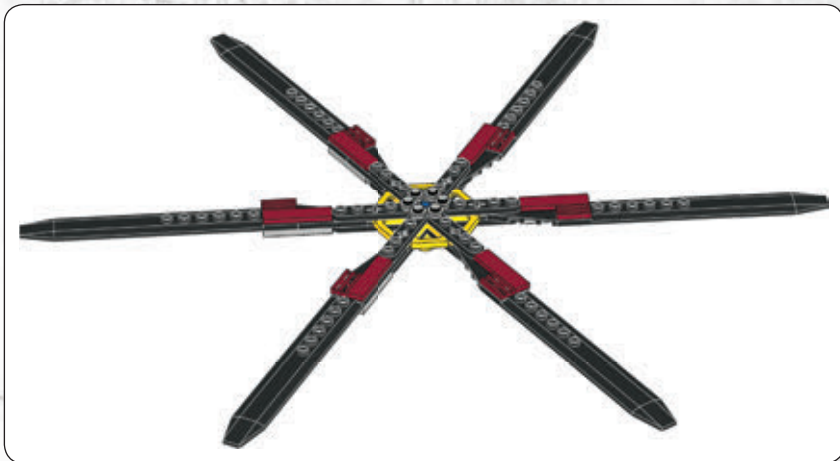

1

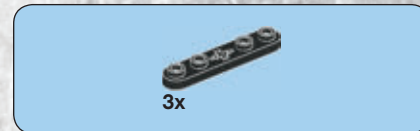

2





3



4

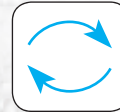



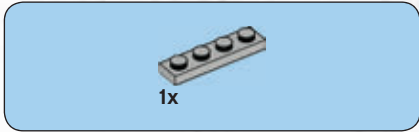
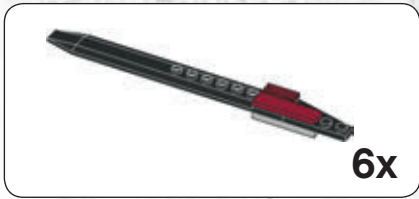

1

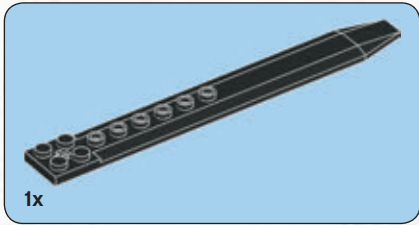

2



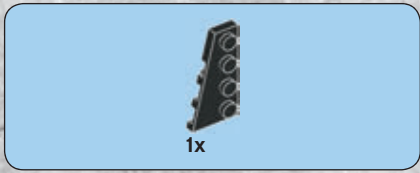

3

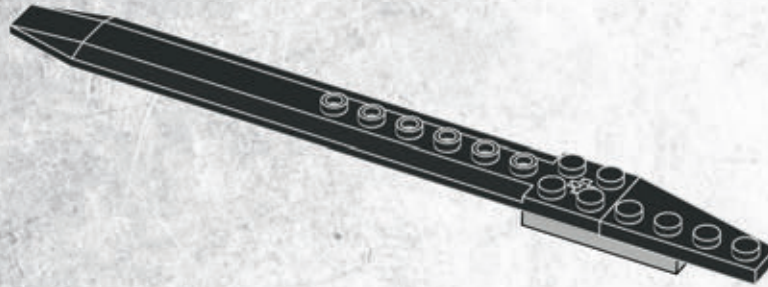

4



6x



5

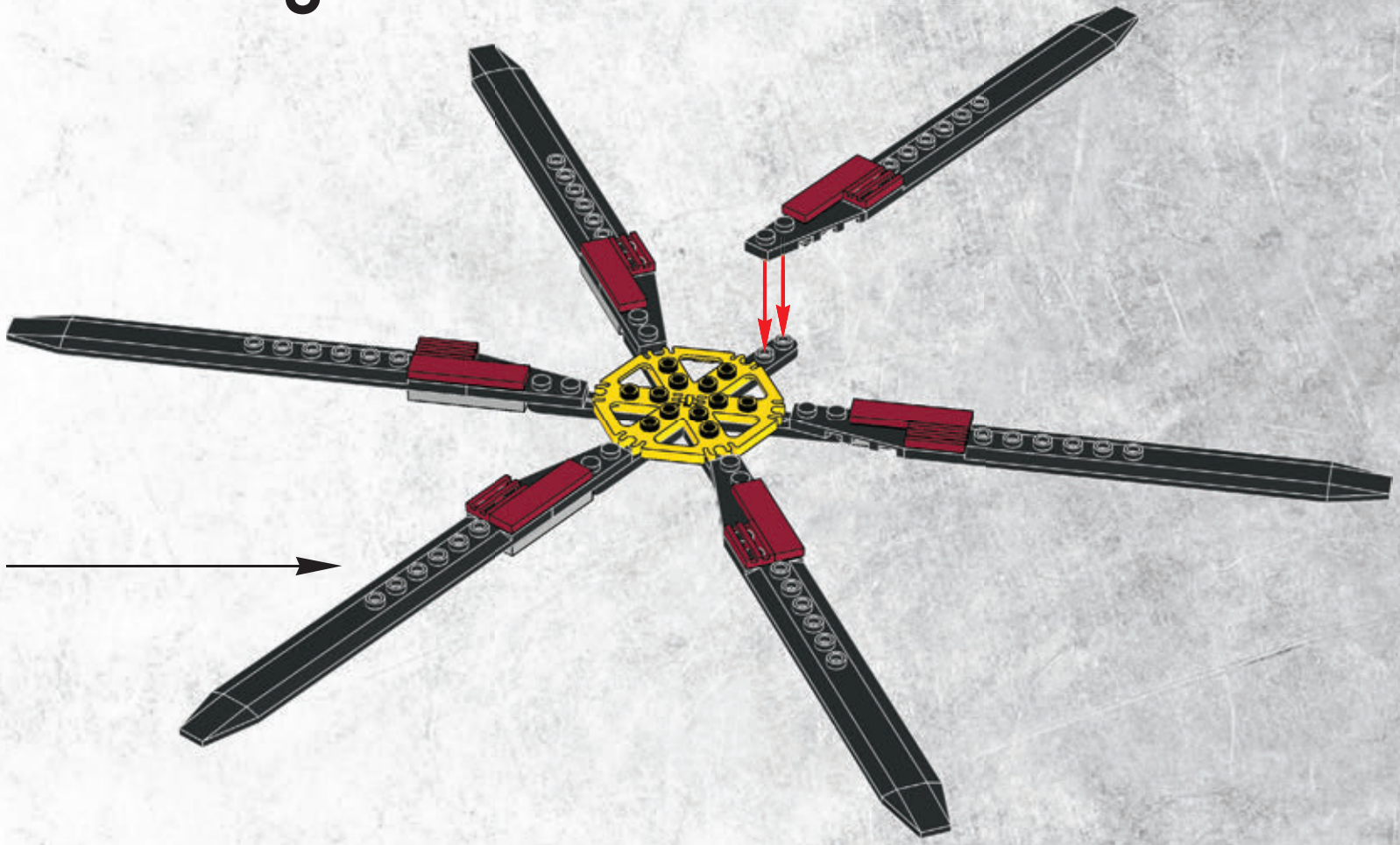





6x

6

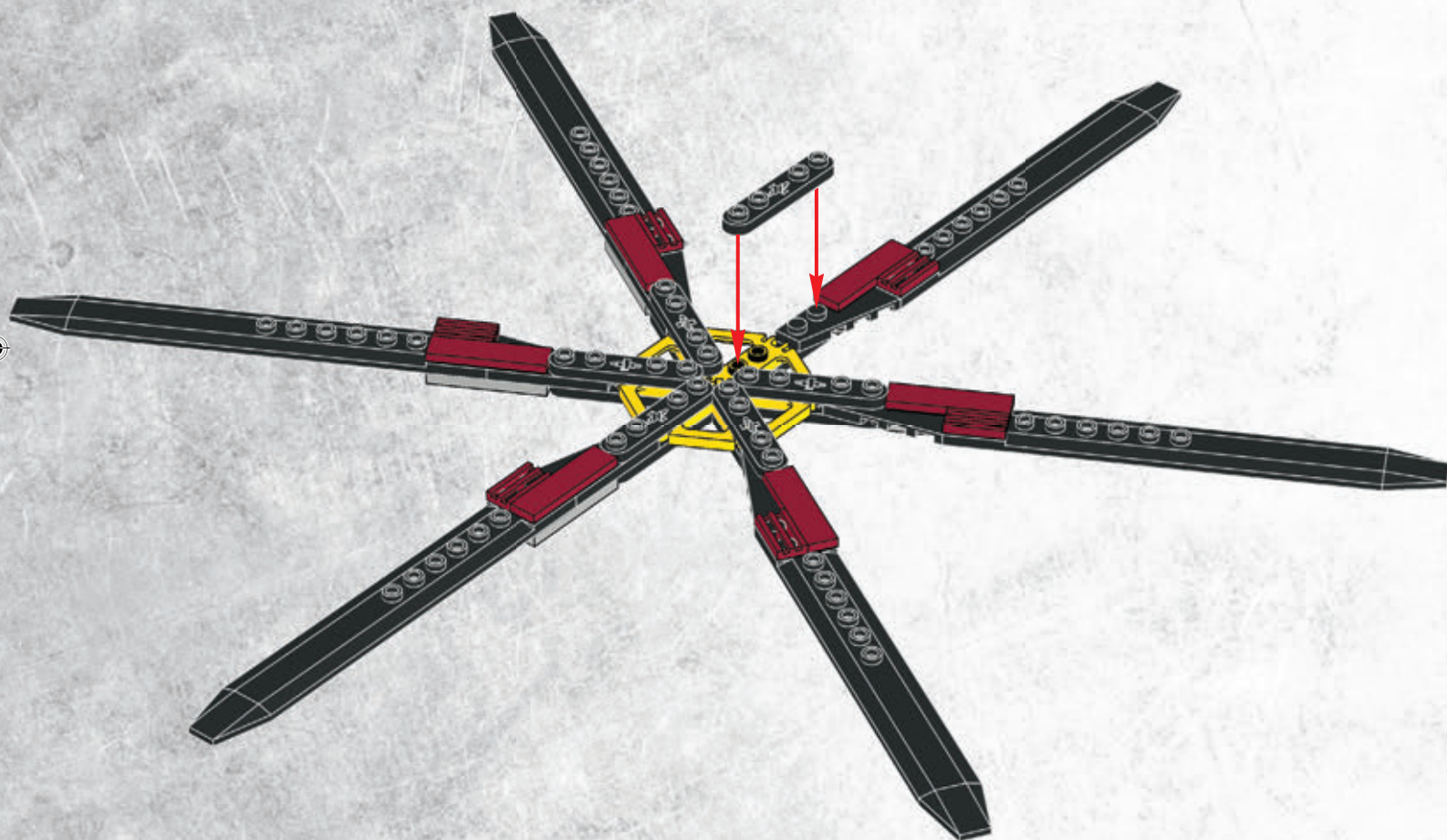



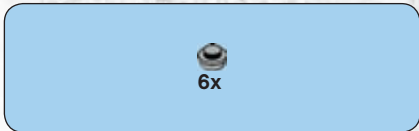

7

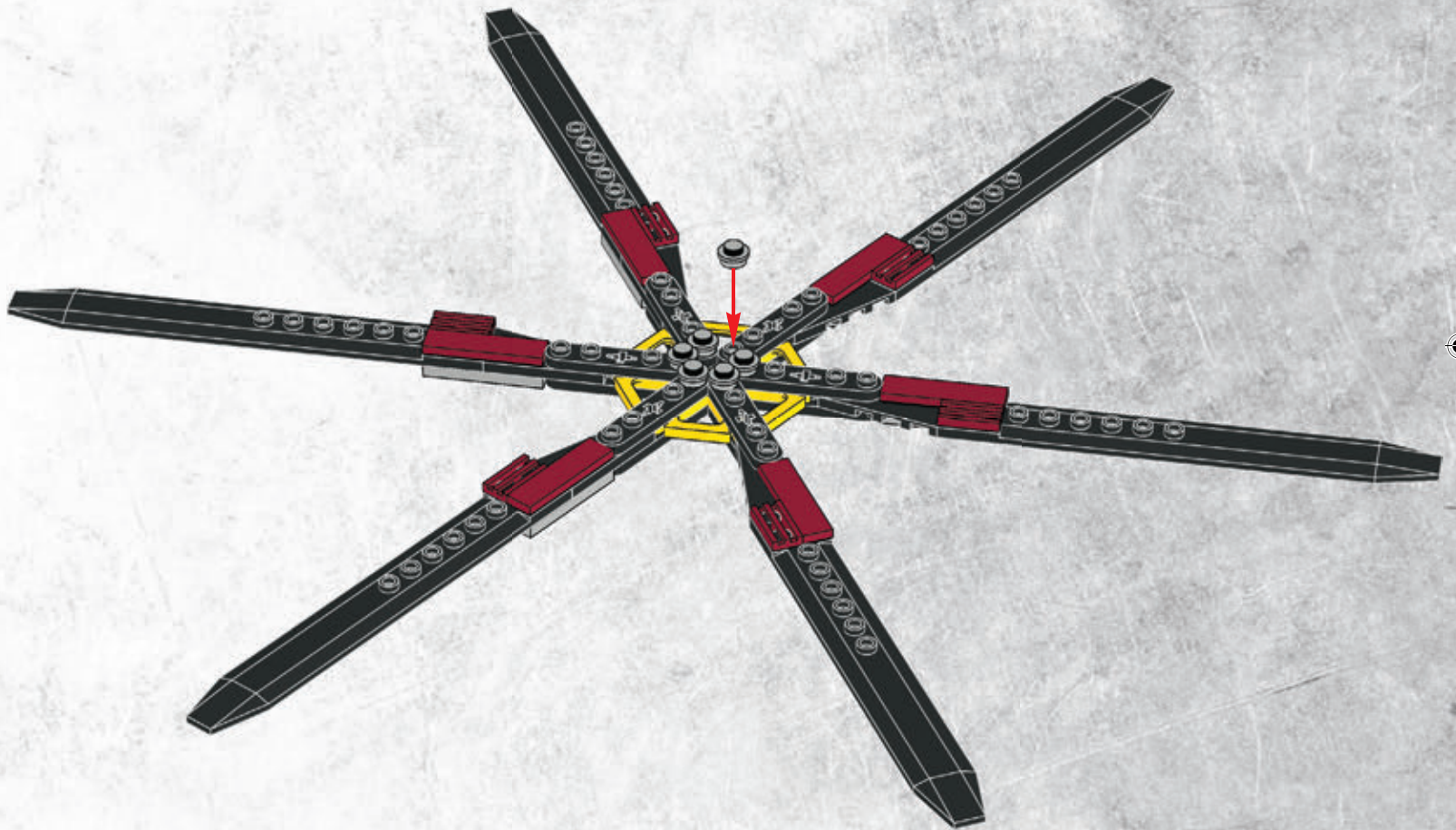





8

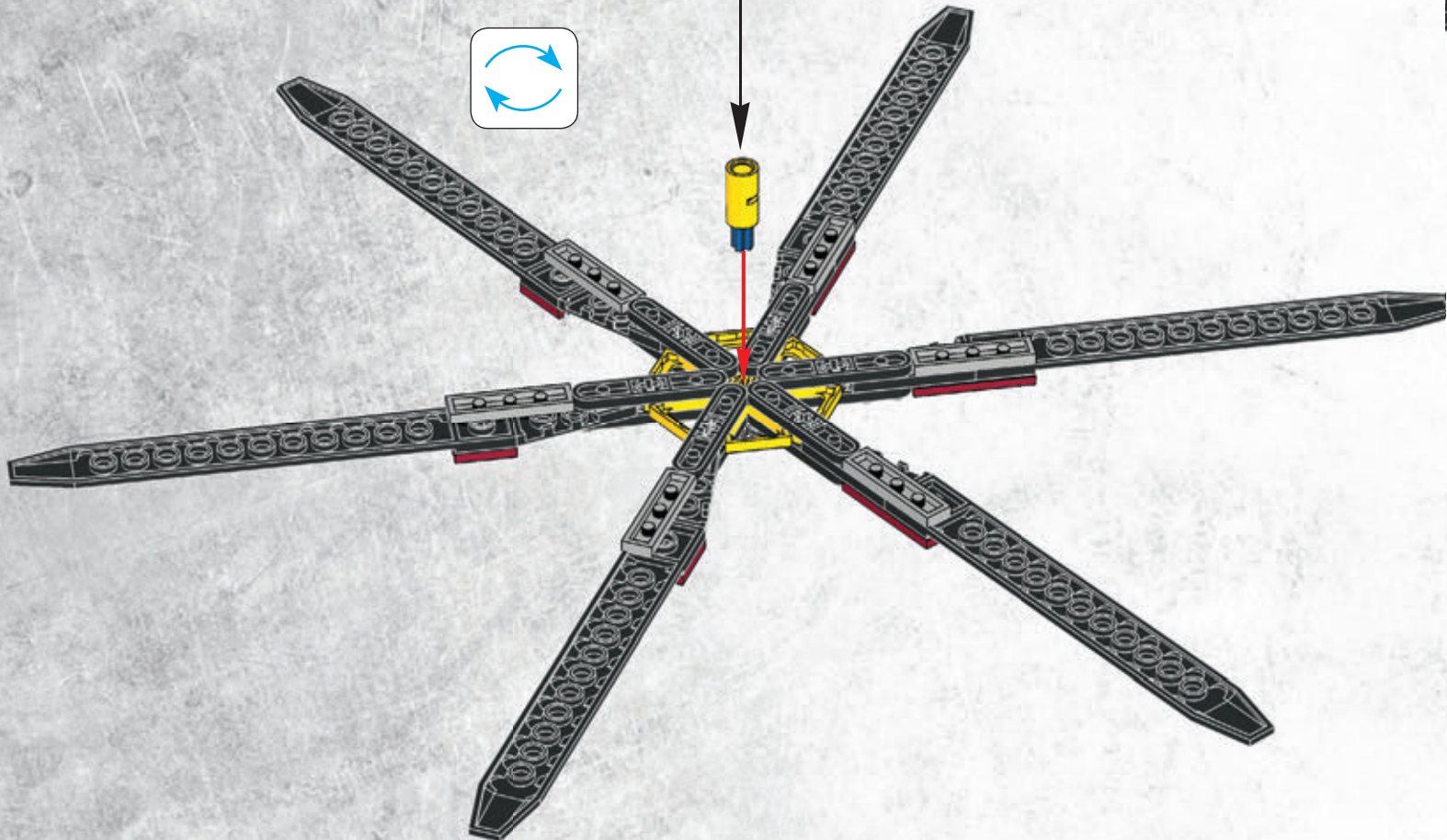
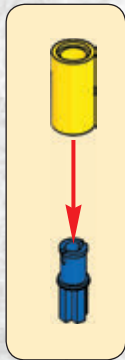



39









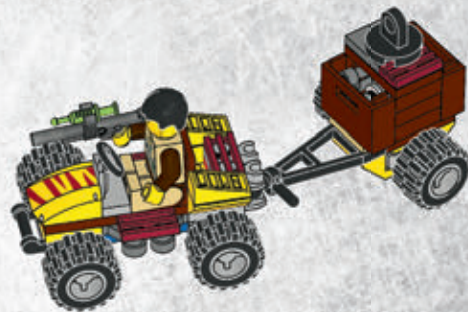





1x  
4659022



4x  
370001



1x  
4195659



2x  
609101



2x  
366601



1x  
379401



1x  
4613762



1x  
4185177



1x  
4659007



3x  
4514554



2x  
300421



10x  
4157223



1x  
614321



4x  
302321



4x  
302221

**54**



1x  
74335



2x  
301023



2x  
379523



3x  
403223



4x  
4143005



9x  
4206482



2x  
4514553



1x  
4656484



2x  
300324



1x  
300124



3x  
4639693



4x  
4624985



2x  
245824



2x  
4656702



4x  
370124



4x  
4504381



2x  
366524



9x  
366024



2x  
4656699



2x  
4277159



1x  
4549996



4x  
4188357



4x  
621524



1x  
4613151



2x  
4160408



1x  
4501536



4x  
4551620



2x  
302224



2x  
362324



1x  
303424



4x  
4515367



1x  
4613344



1x  
4657288



3x  
243124



8x  
4560181



4x  
4189400



1x  
4654328



1x  
4263142



6x  
4540384



2x  
4185269



1x  
4655887



2x  
4174709



1x  
4558801



1x  
4558818



4x  
4526983



1x  
4494850



1x  
306226



4x  
4294690



3x  
302326



2x  
302126



11x  
371026



6x  
447726



3x  
383226

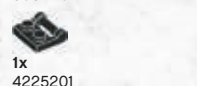

1x  
4225201



1x  
244426



12x  
4114689



1x  
4274405

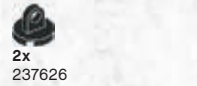

6x  
4161332

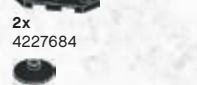

2x  
237626

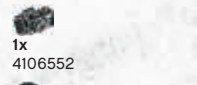

2x  
4227684

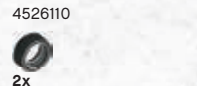

2x  
474026



1x  
4106552



1x  
4526110



2x  
4246901



6x  
4568644



4x  
4541455



1x  
4142731



1x  
4289538



8x  
4121610



2x  
4121715



2x  
4140801



2x  
370526



5x  
303428



1x  
4656316



1x  
4656307





1x  
4656310

1x  
3005740

2x  
486440

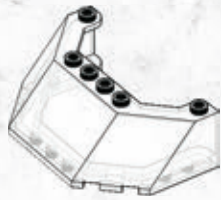

1x  
4656705

1x  
3005741

1x  
3005748

4x  
4567334

2x  
4654583

2x  
4566927

1x  
4613761

28x  
4541506

8x  
4539060

5x  
4211189



2x  
4211206



1x  
4211185



1x  
4507049



1x  
4211387



1x  
4211666



2x  
4258455

2x  
4529241

2x  
4650645



2x  
4645089

4x  
4211541

2x  
4211398

4x  
4211396

6x  
4211445

2x  
4251149



2x  
4211360

2x  
4541978

2x  
4594238

1x  
4515341

2x  
4211568

4x  
4535738

4x  
4237084

1x  
4530469

1x  
4211464

12x  
4211525

5x  
4211357

6x  
4211764

4x  
4499259

3x  
4211569

1x  
4226995

2x  
4520320

3x  
4211550

1x  
4211622

2x  
4211758

1x  
4211807

6x  
4211815

1x  
4211805

2x  
421095

8x  
4210935

2x  
4211024

2x  
4161674

6x  
4210968

1x  
4180486

5x  
4211065

2x  
4211056

1x  
4211002

4x  
4211119

2x  
4217558

2x  
4586562

2x  
4209014

2x  
4596895

2x  
4210984

1x  
4210645

1x  
4211051



1x  
4500562

1x  
4212529

2x  
4540386

1x  
4260406

1x  
4210796

2x  
4516456

1x  
4645408

1x  
4656301

1x  
4645409



1x  
4656491



2x  
4654423



1x  
4656496

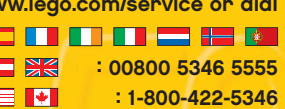
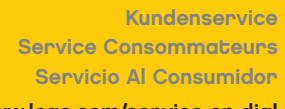
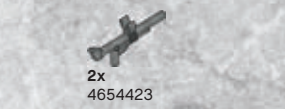

Customer Service  
Kundenservice  
Service Consommateurs  
Servicio Al Consumidor  
[www.lego.com/service](http://www.lego.com/service) or dial



: 00800 5346 5555

: 1-800-422-5346

















[www.LEGOclub.com](http://www.LEGOclub.com)



LEGO® Club Email

**LEGO club**™

**FREE! GRATIS! GRATUIT!**



LEGO® Club Magazine

**SIGN UP ONLINE!**

**[www.LEGOclub.com](http://www.LEGOclub.com)**



**00800 5346 5555\***



**1-866-534-6258 • 1-877-518-5346**

US & Canada only

Canada seulement

- \* Freephone. Mobile charges may apply.
- \* Numéro sans frais. Des frais peuvent s'appliquer avec les téléphones cellulaires.
- \* Gebührenfrei, Kosten für Anrufe aus Mobilfunknetzen können abweichen.
- \* Gratis telefoonnummer vanaf vaste lijn.
- \* Det är ett gratis nummer, när du ringer fra fasttelefon.
- \* Det är gratis, när du ringer från en fast telefon.
- \* Numéro sans frais. Des frais peuvent s'appliquer avec les téléphones portables.

BI115





# WIN!

Go to [www.LEGOsurvey.com/product](http://www.LEGOsurvey.com/product) to fill out a survey for a chance to win a cool LEGO® Product.

No purchase necessary.

Open to all residents where not prohibited.



[www.LEGO.com](http://www.LEGO.com)

## [www.LEGOsurvey.com/product](http://www.LEGOsurvey.com/product)

### GEWINNE! WIN!

Nimm an der Umfrage auf [www.LEGOsurvey.com/product](http://www.LEGOsurvey.com/product) teil und hab die Chance ein cooles LEGO® Produkt zu gewinnen!

Die Teilnahme am Gewinnspiel führt zu keinerlei Kaufverpflichtungen. Teilnahme in allen nicht ausgeschlossenen Ländern möglich.

Ga naar [www.LEGOsurvey.com/product](http://www.LEGOsurvey.com/product), vul een enquêteformulier in en maak kans op een cool LEGO® product.

Geen aankoopverplichting. Iedereen mag deelnemen, uitgezonderd ingezetenden van landen waar een enquêteverbod geldt.

### GAGNE! 当てよう!

Visite [www.LEGOsurvey.com/product](http://www.LEGOsurvey.com/product) pour répondre à un questionnaire et avoir une chance de gagner un produit LEGO® très cool!

Aucune obligation d'achat. Ouvert à tous les résidents des pays autorisés.

[www.LEGOsurvey.com/product](http://www.LEGOsurvey.com/product) にアクセスして、アンケートにご記入ください。当選者にはレゴ®製品を差し上げます。

お買い上げの必要はありません。

禁止されていない限り、すべての皆様にご利用いただけます。

6002941

LEGO and the LEGO logo are trademarks of the LEGO Group. ©2012 The LEGO Group.