



STAR WARS

TM

7931



1

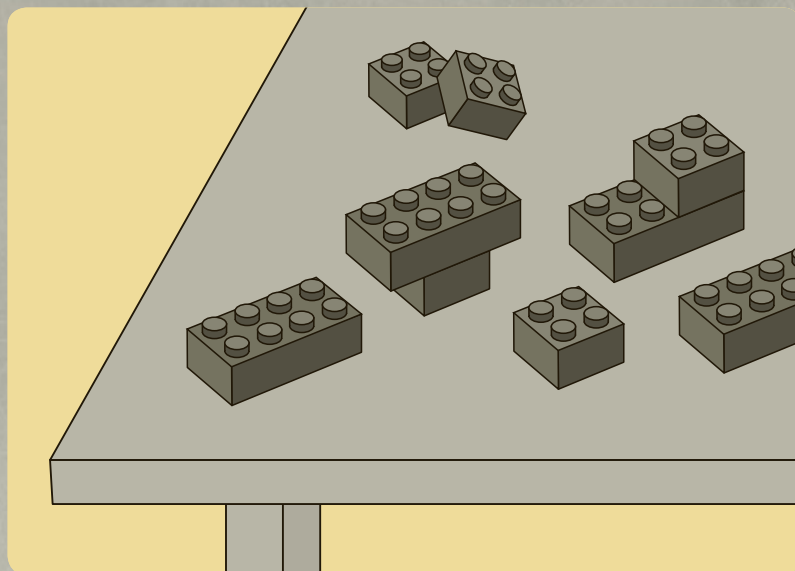
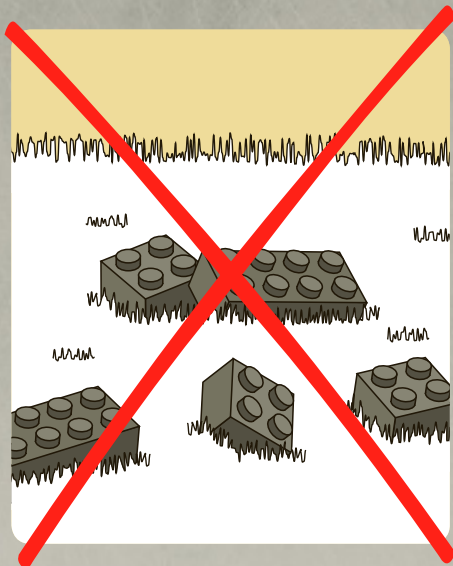

2

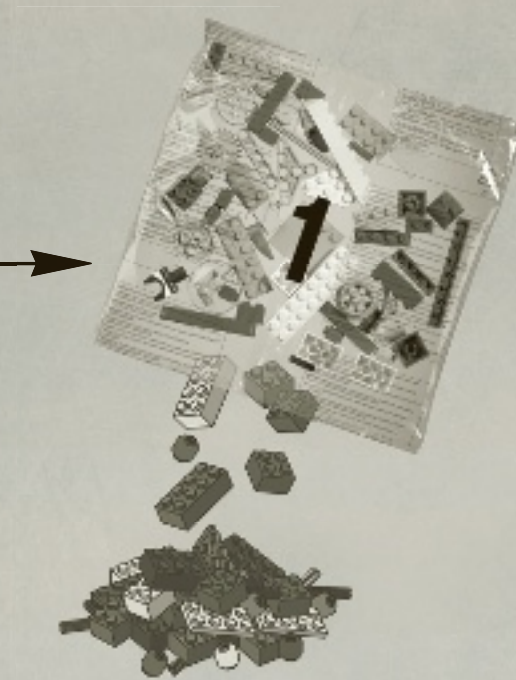



1

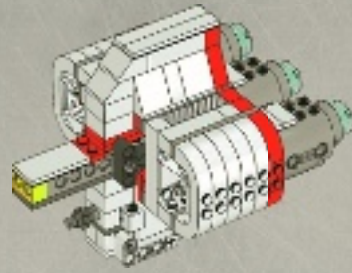
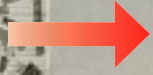

2

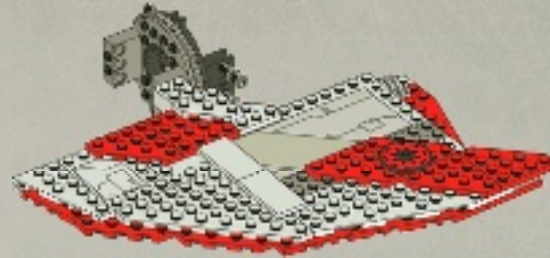

3

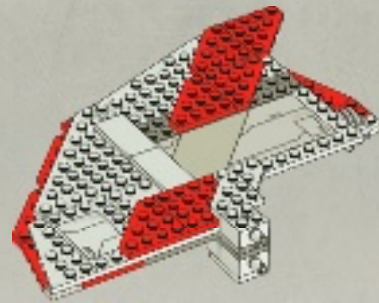

4



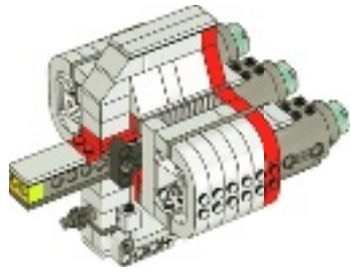

1

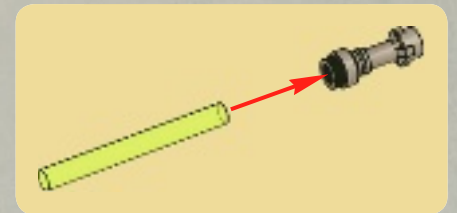
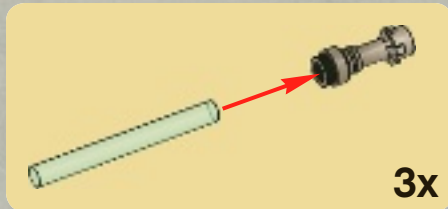
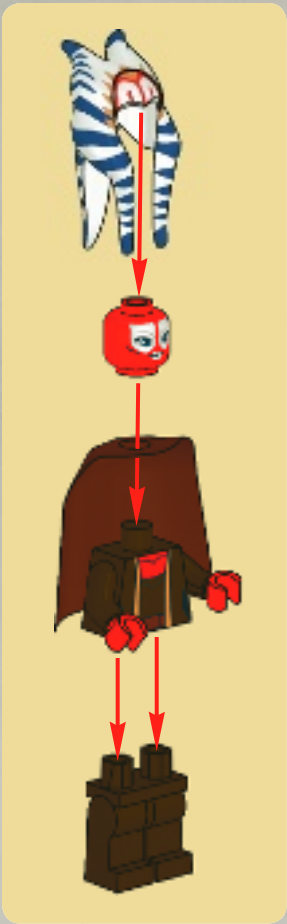



1x

1



1x



1x

2

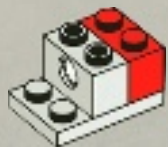

1x

4

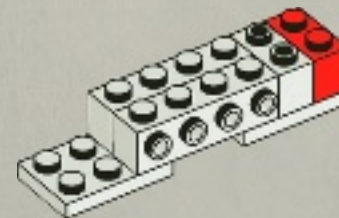

2x

3

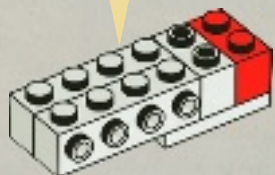

2x

5

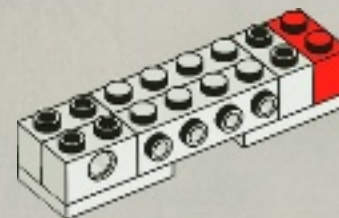

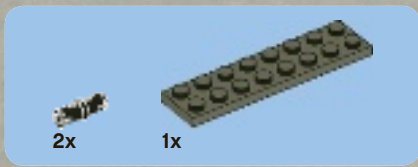

6

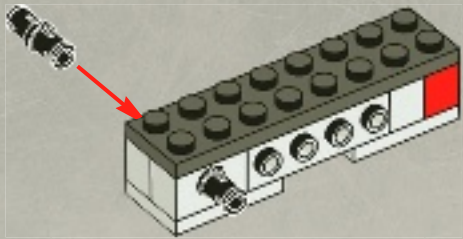

7

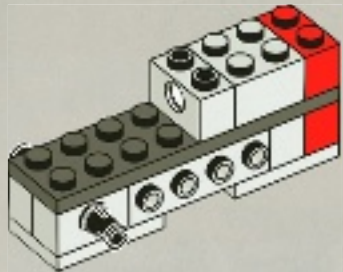

8

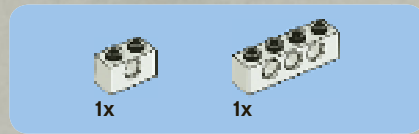
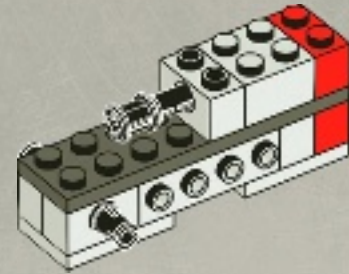

9

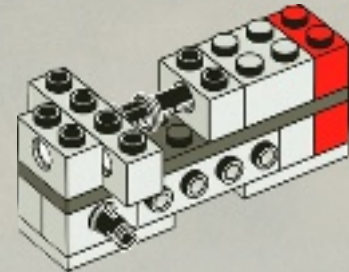

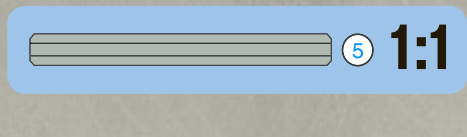
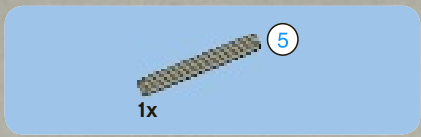

10

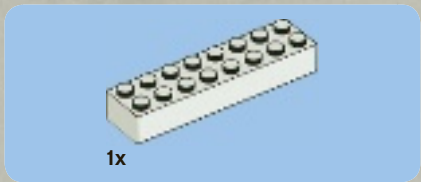
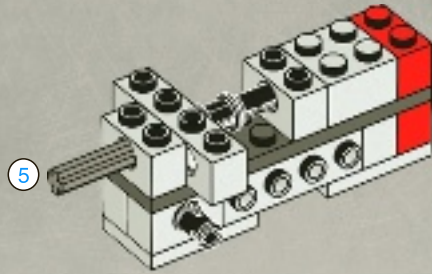

11

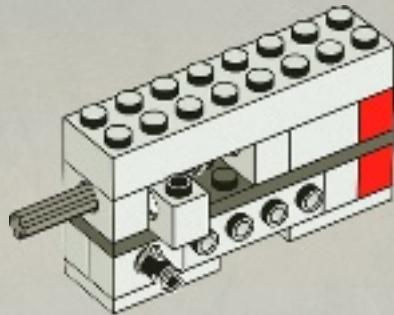

12

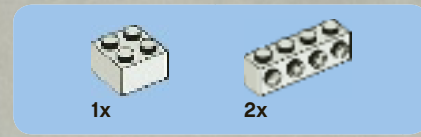
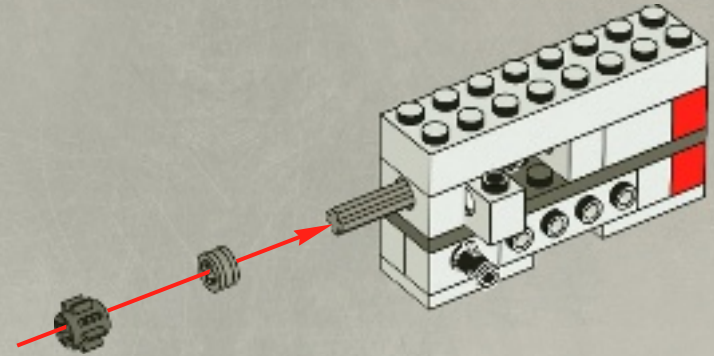

13

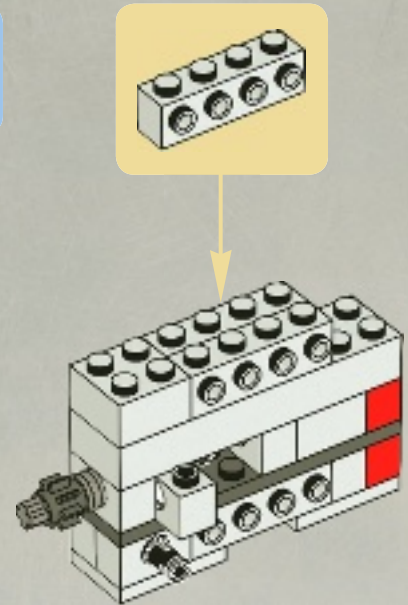



14

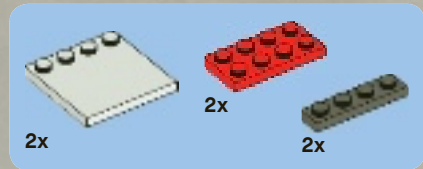
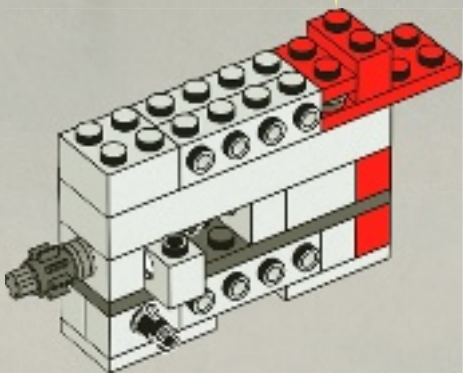
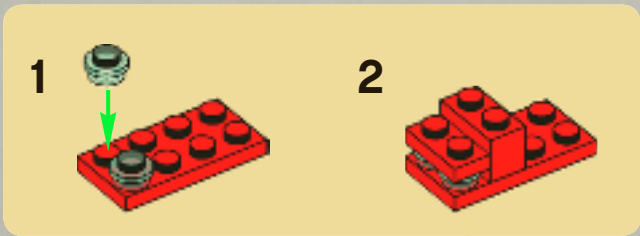

15

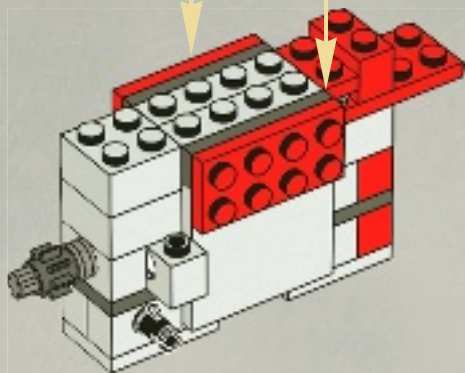
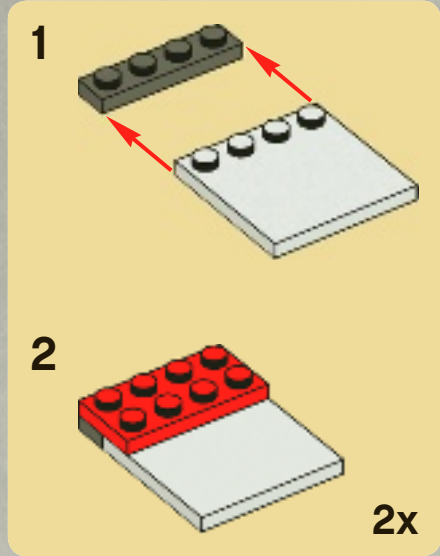



16

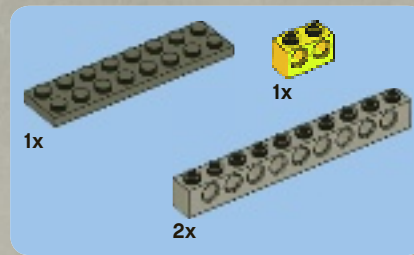
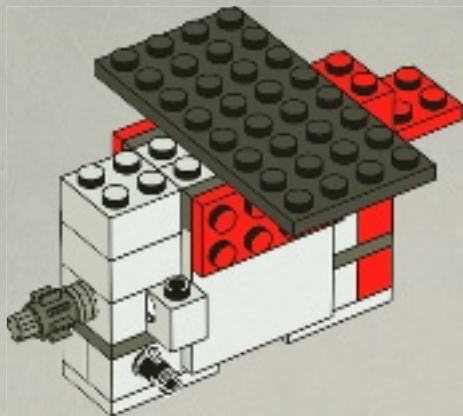

17

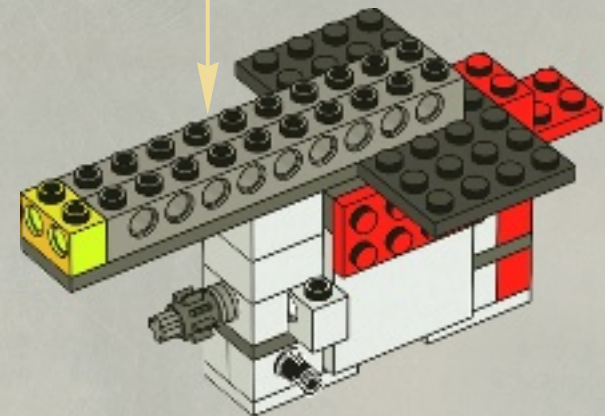
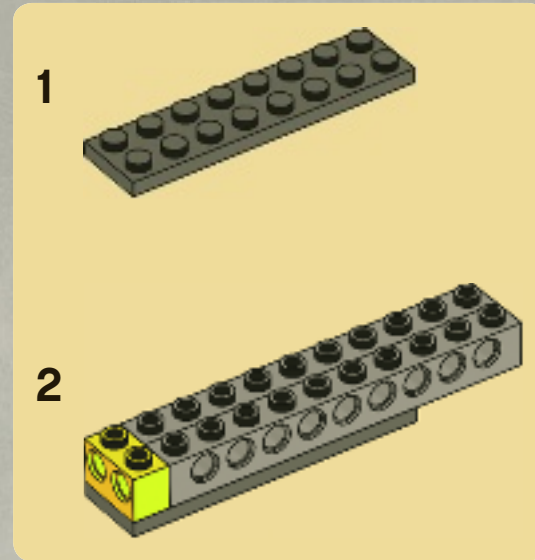

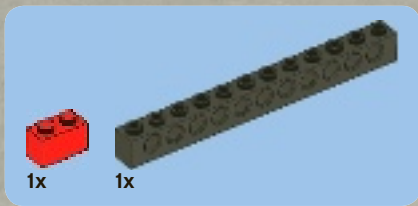

18

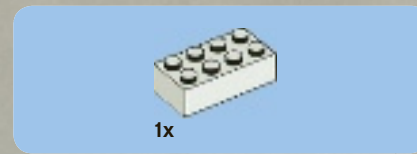
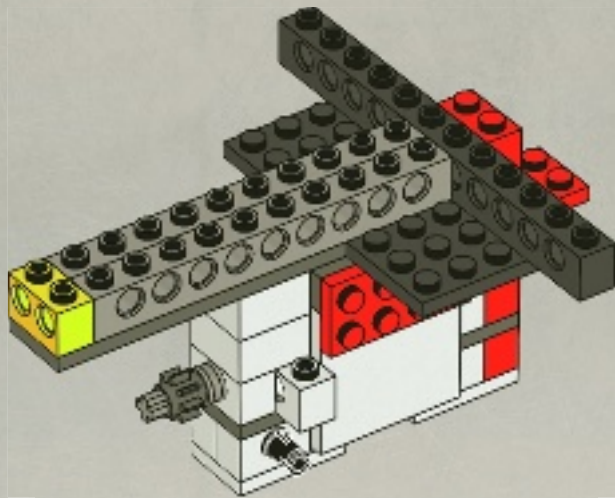

19

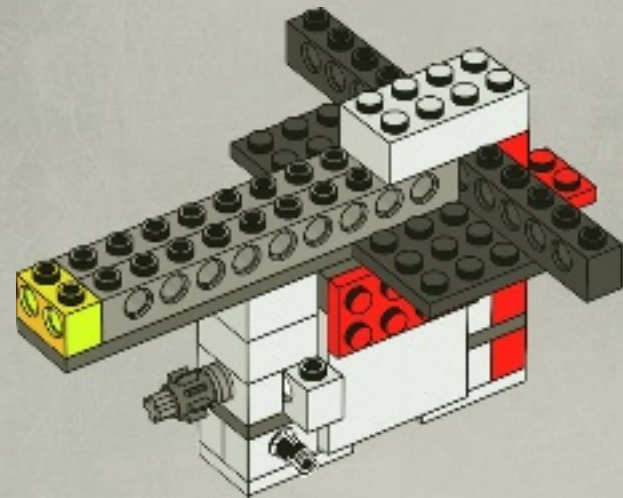



1x



1x



1x

20

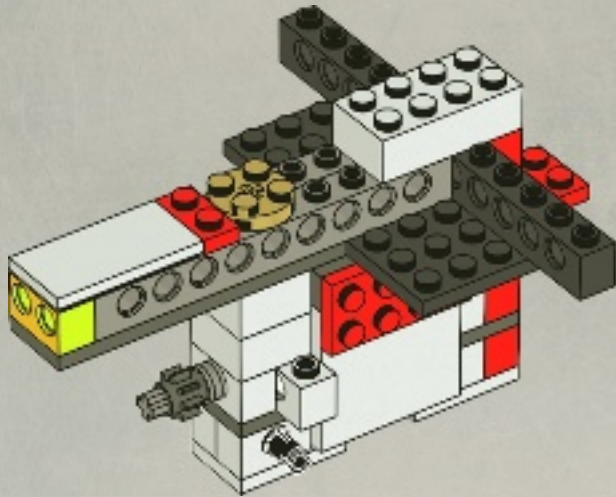

4x

2x

21

1

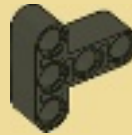

2



2x

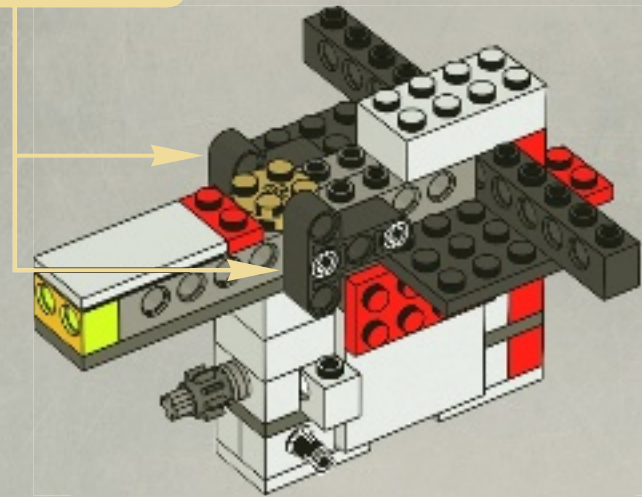

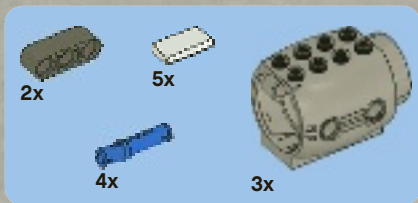

22

1

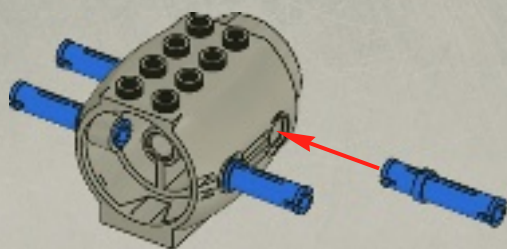

2

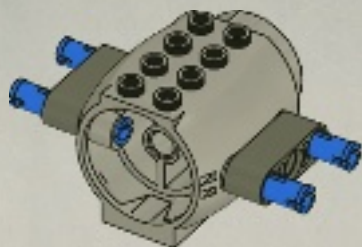

3

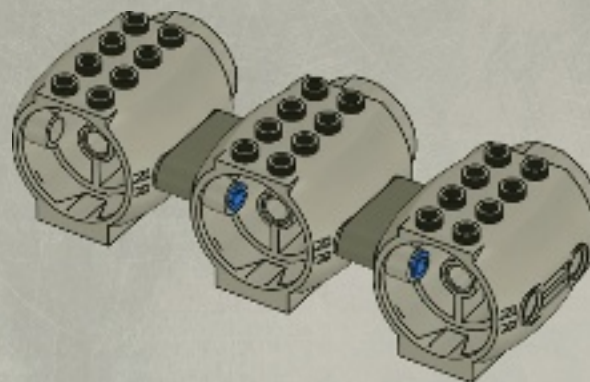

4

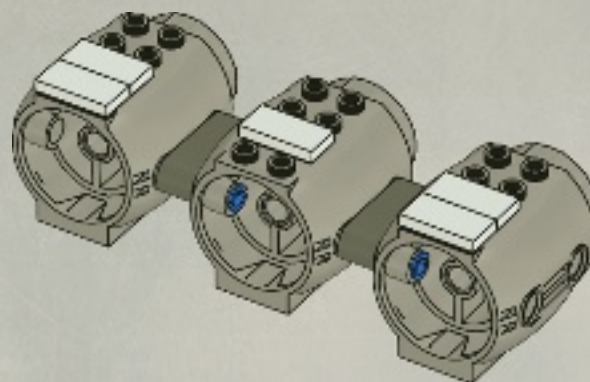

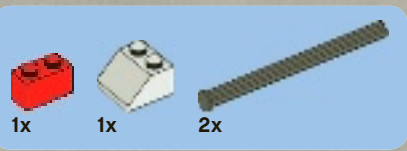

23

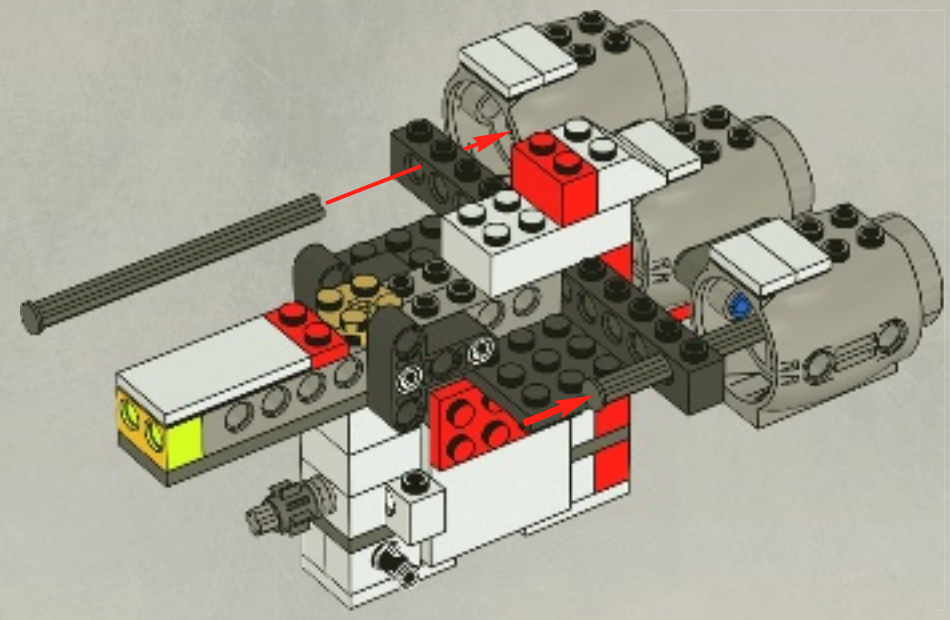
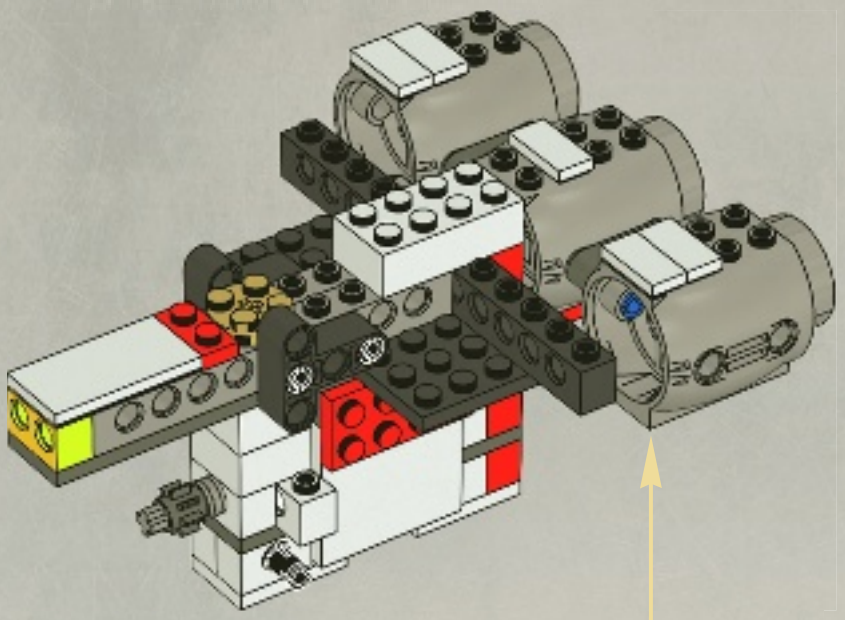



2x

24

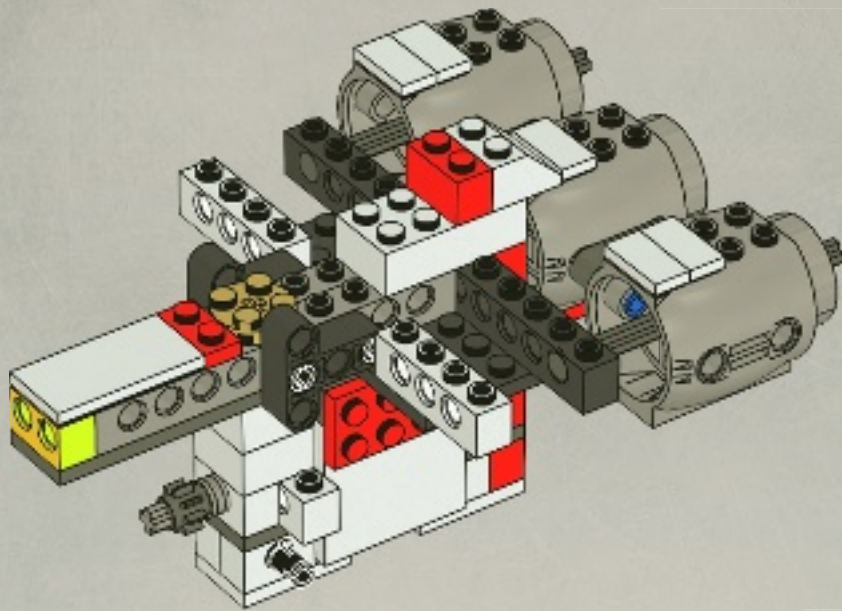

2x



1x

25

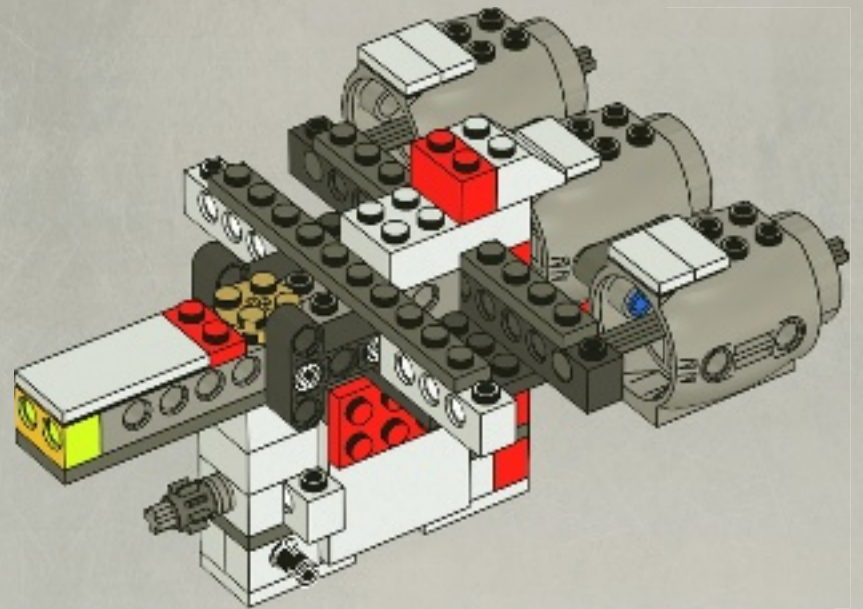



2x



2x

26

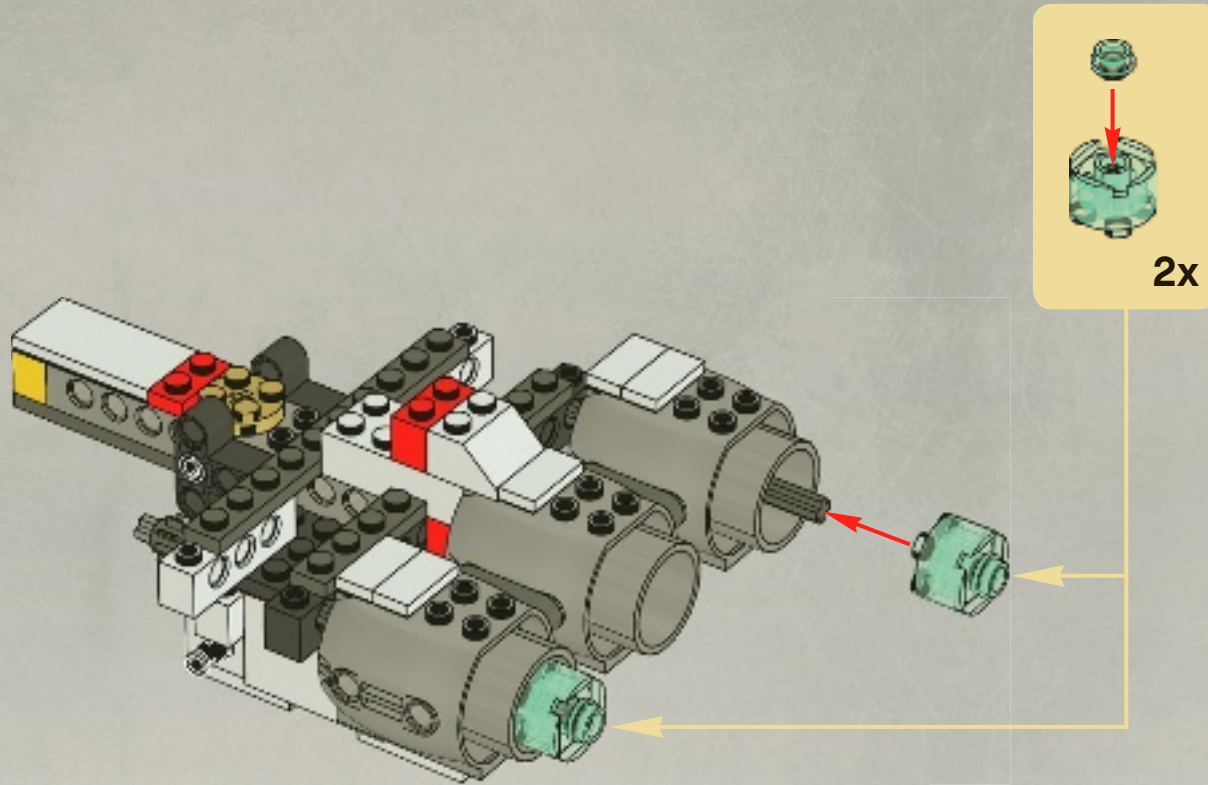

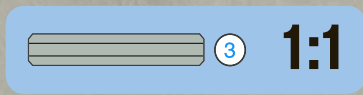
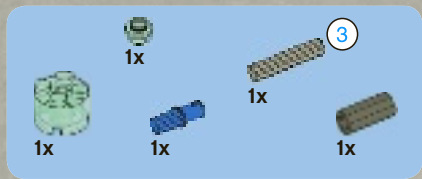

27

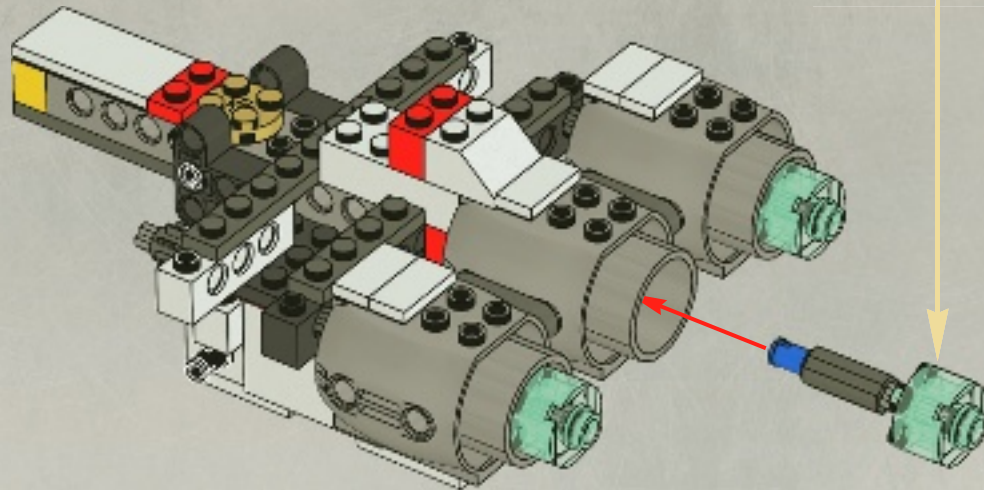
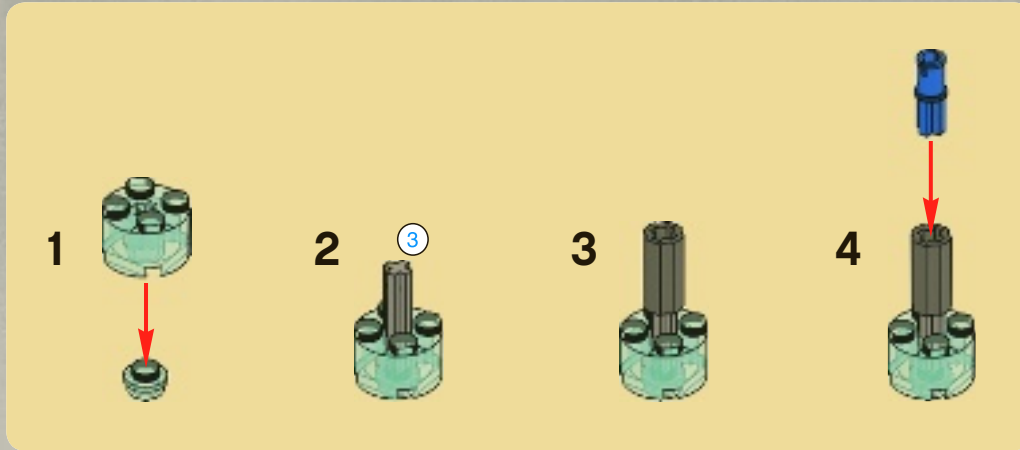



28

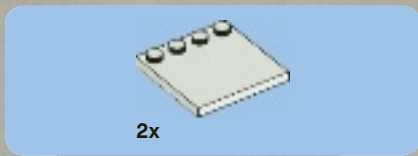
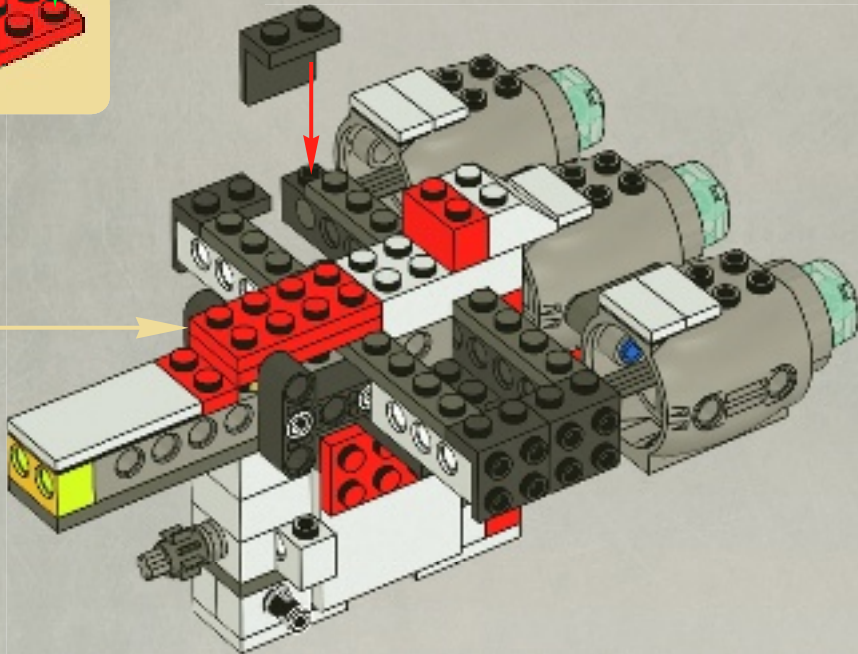
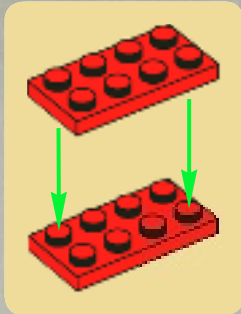

29

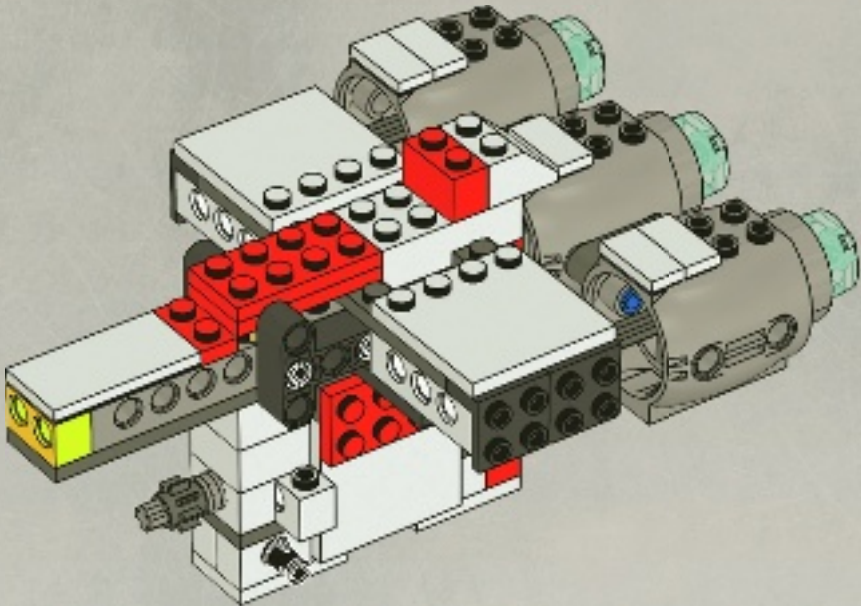

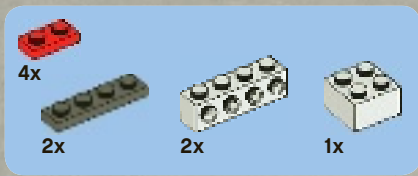

30

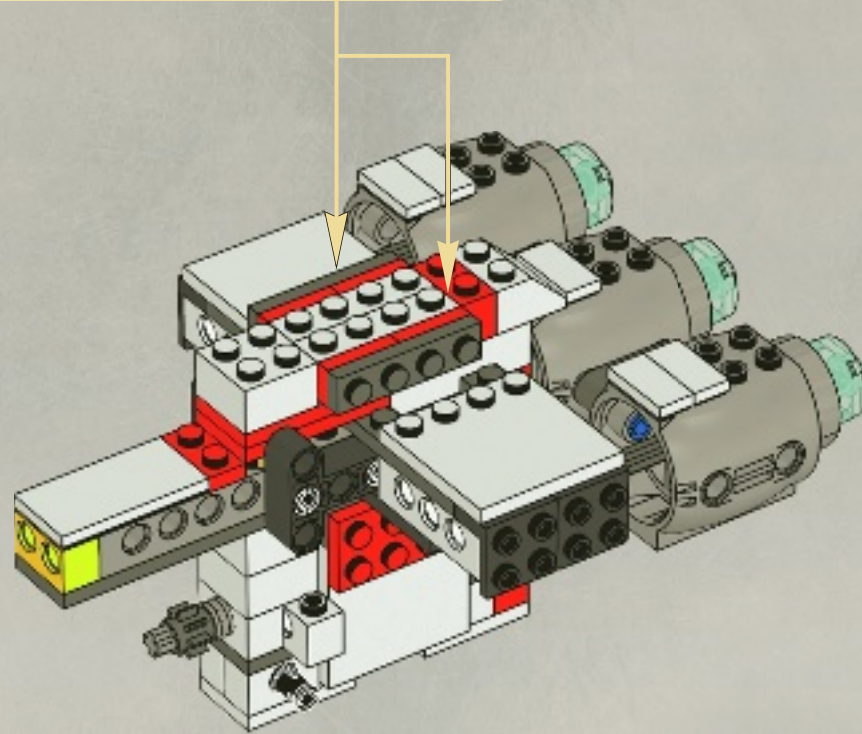



1

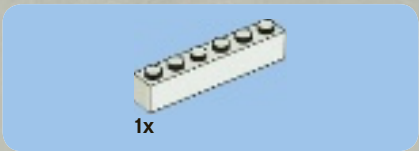
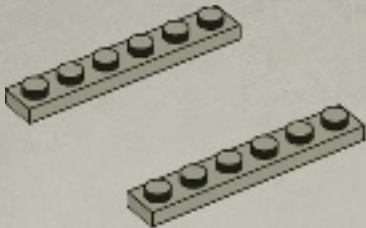

2

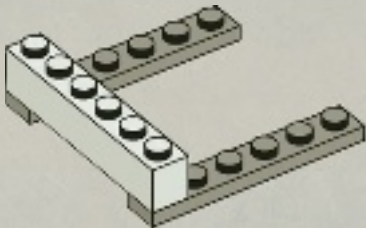

3

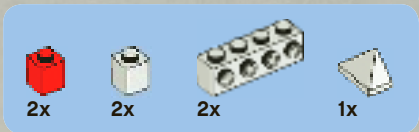
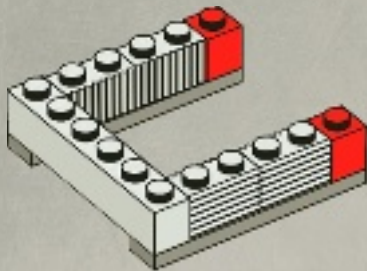

4

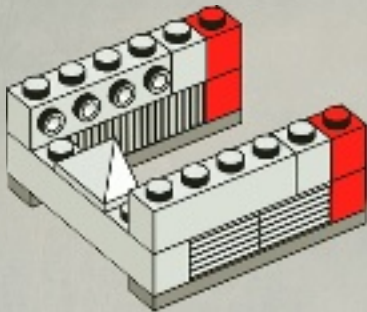



2x

5

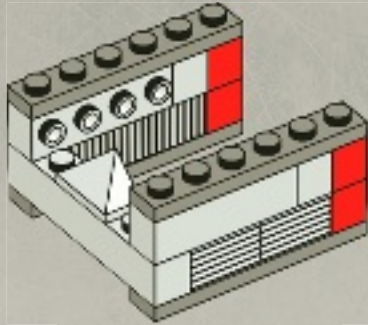

5x

6

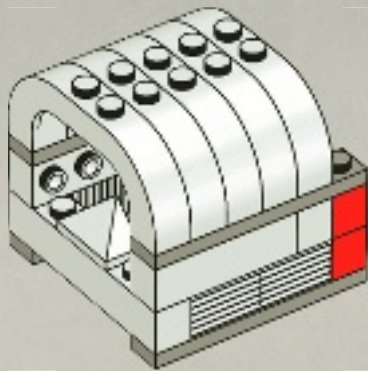

1x



2x

7

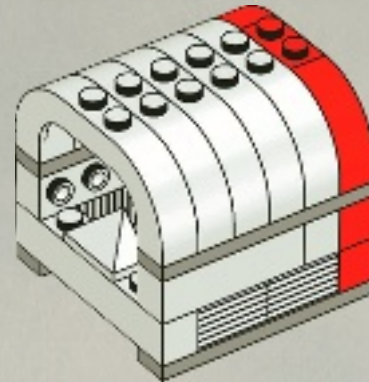
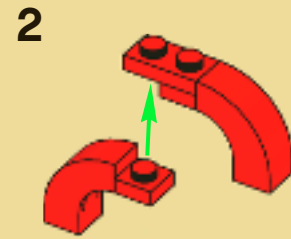



8



9

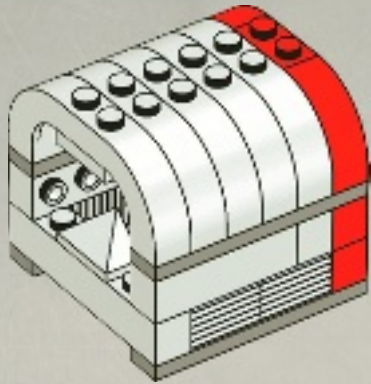

2x

31

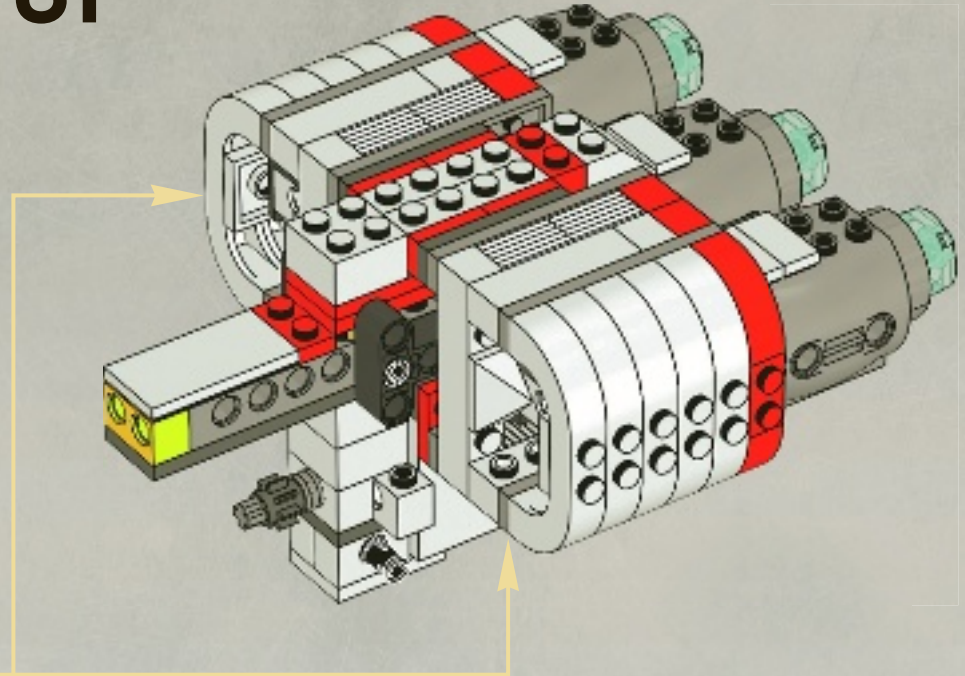



32

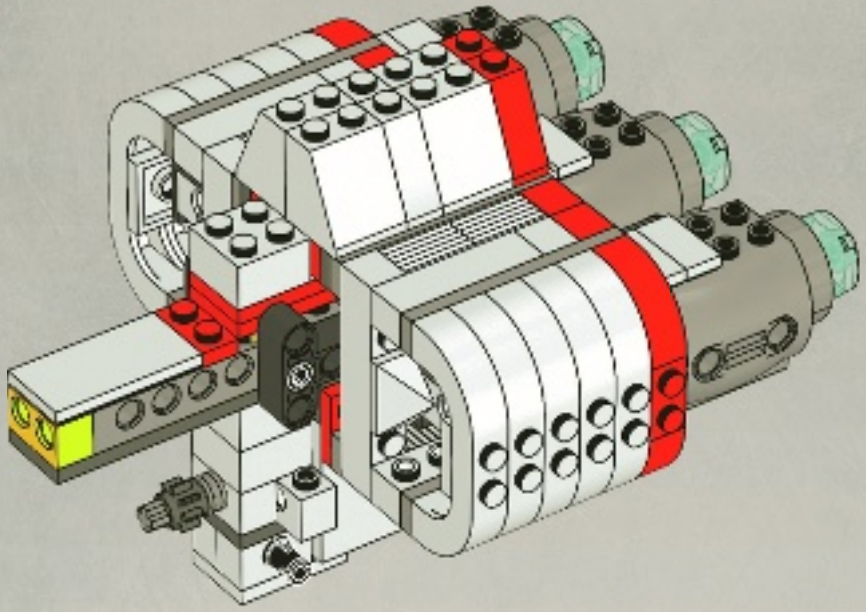

33

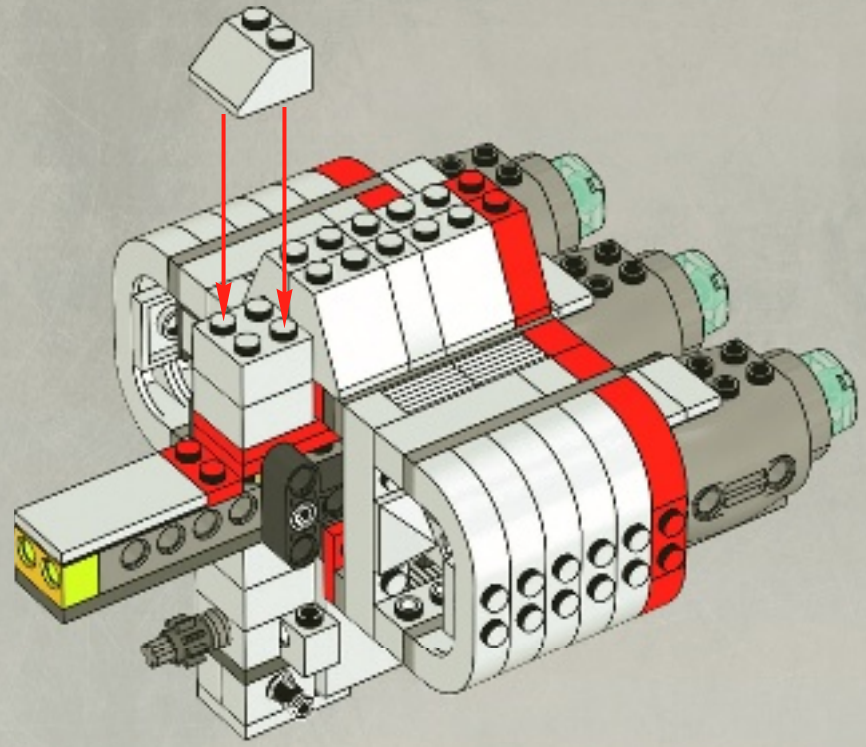

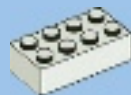

1x



1x



1x

34

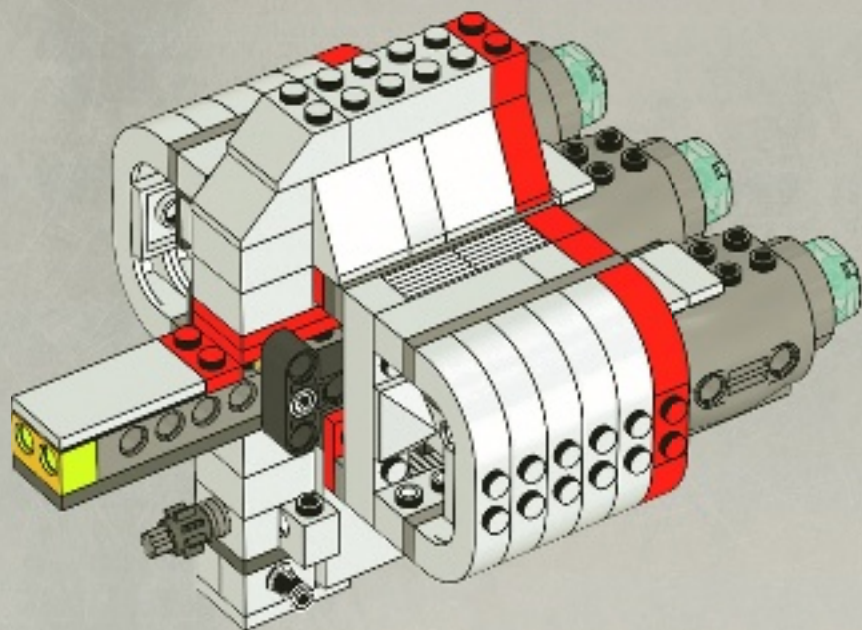

2x

35

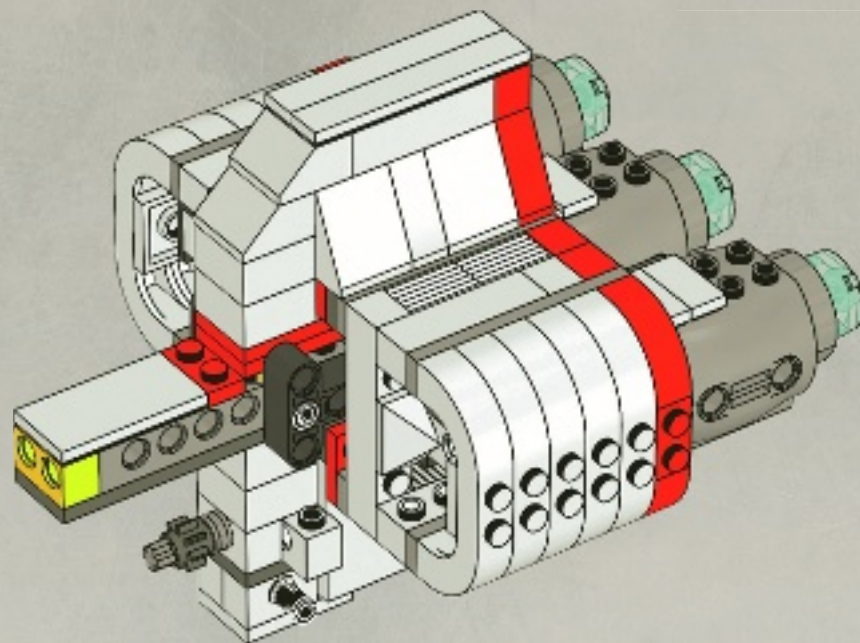

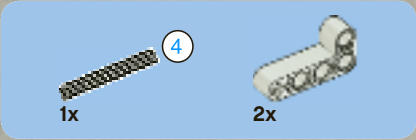

36

- 1
- 2

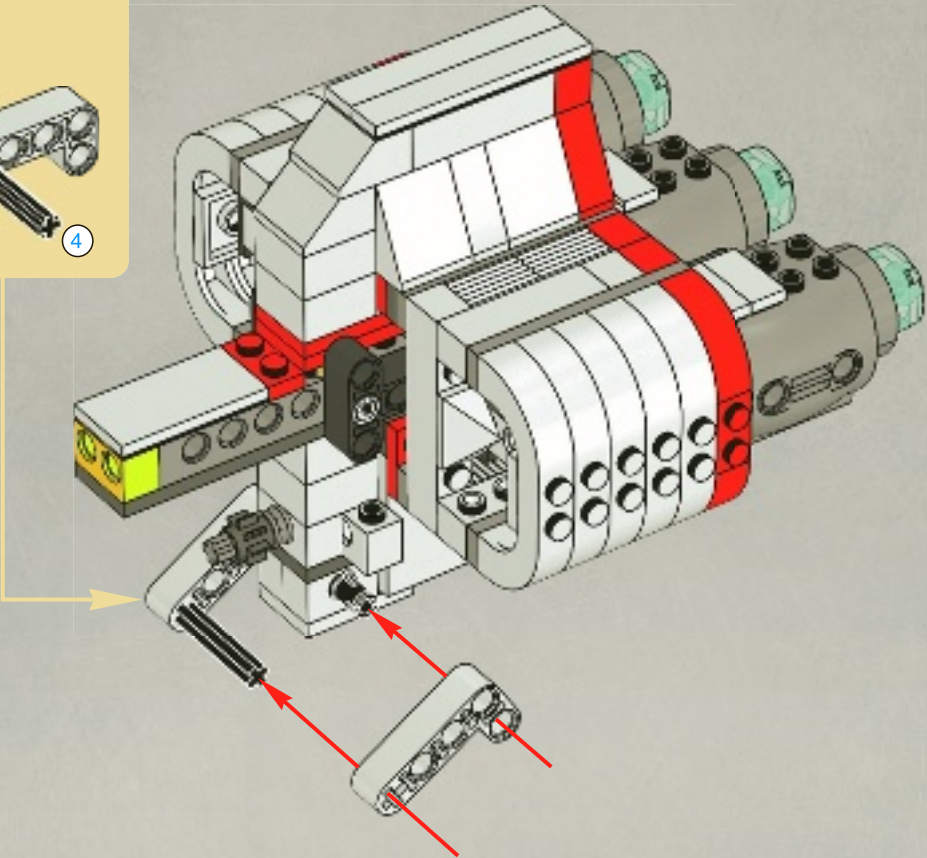

37

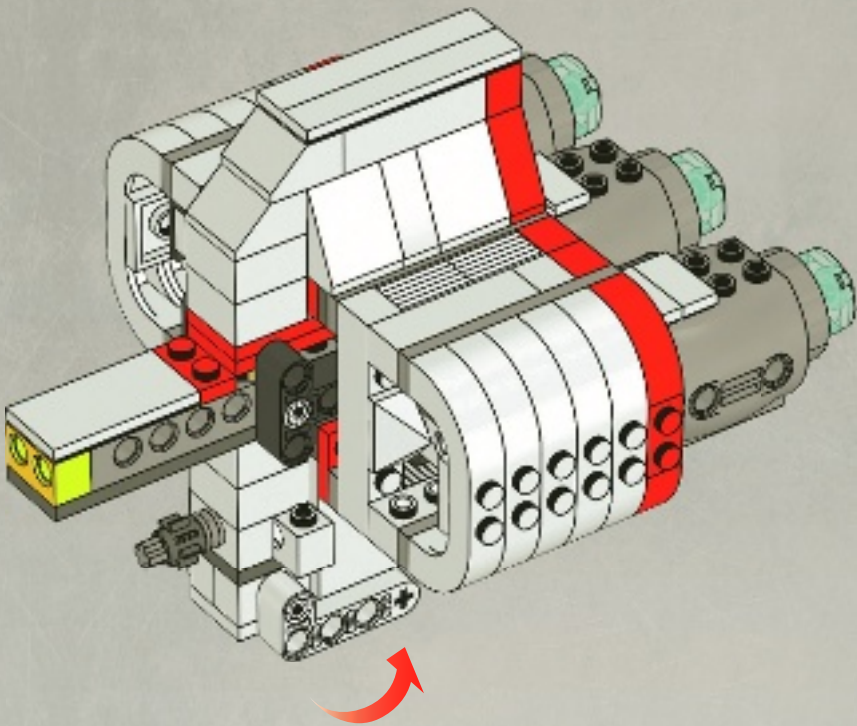

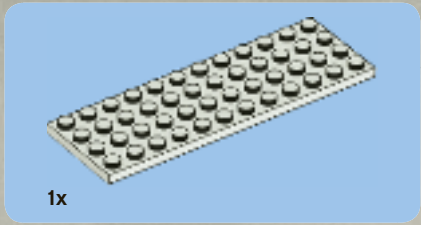
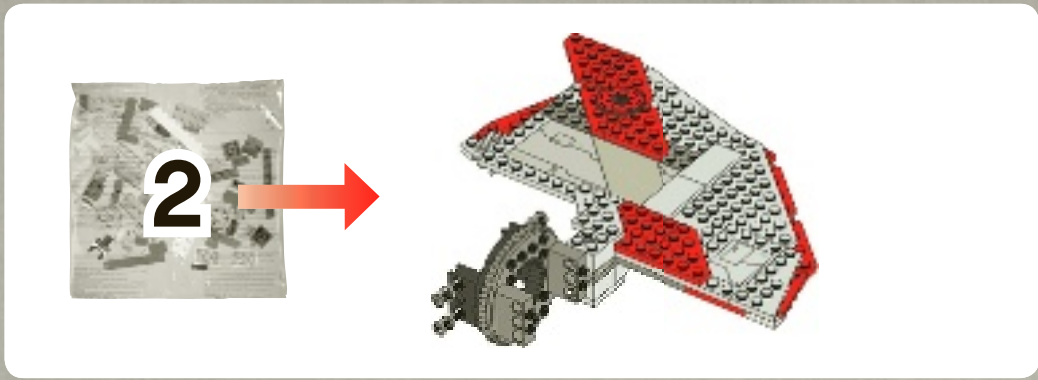

1

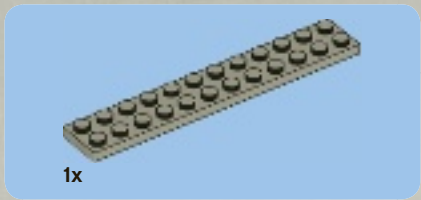
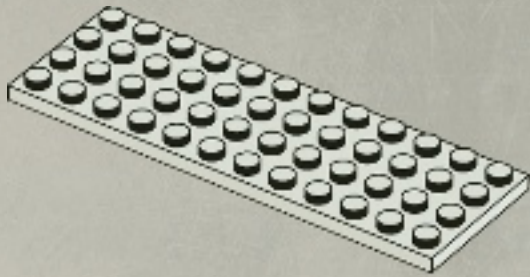

2

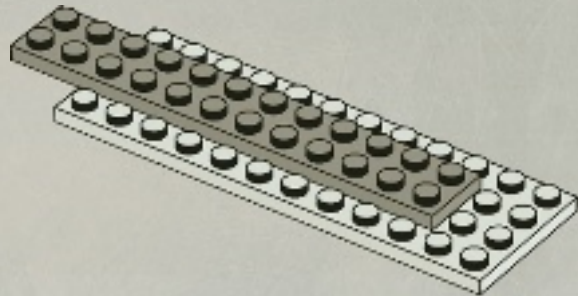

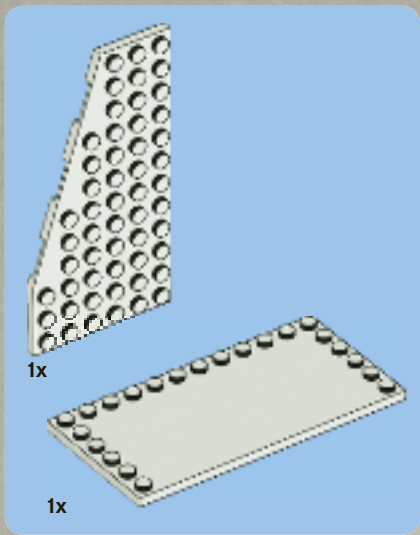

3

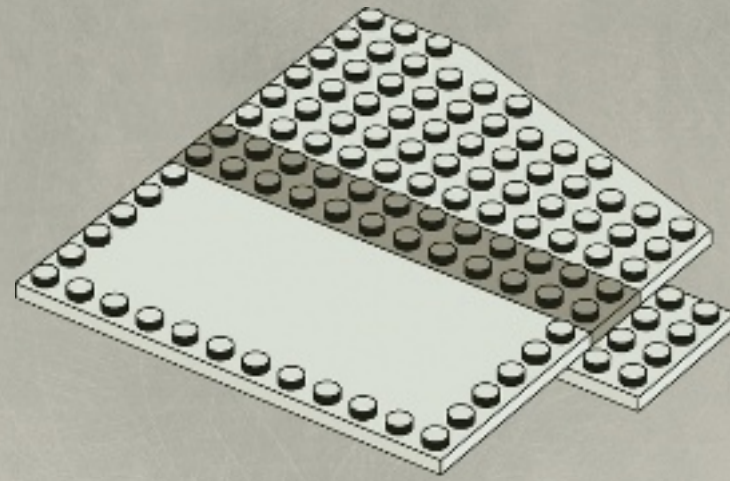

4

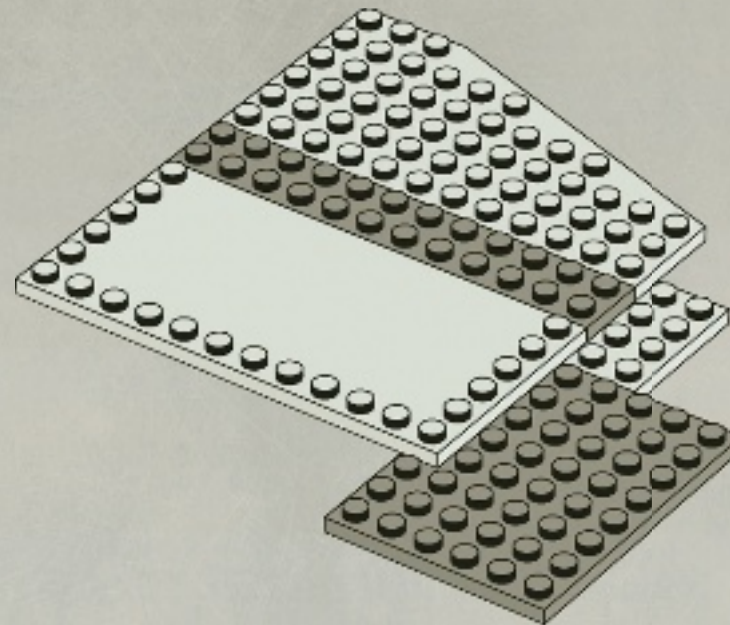

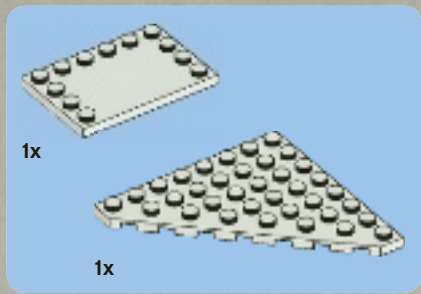

5

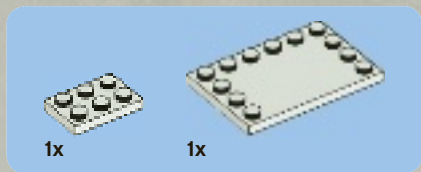
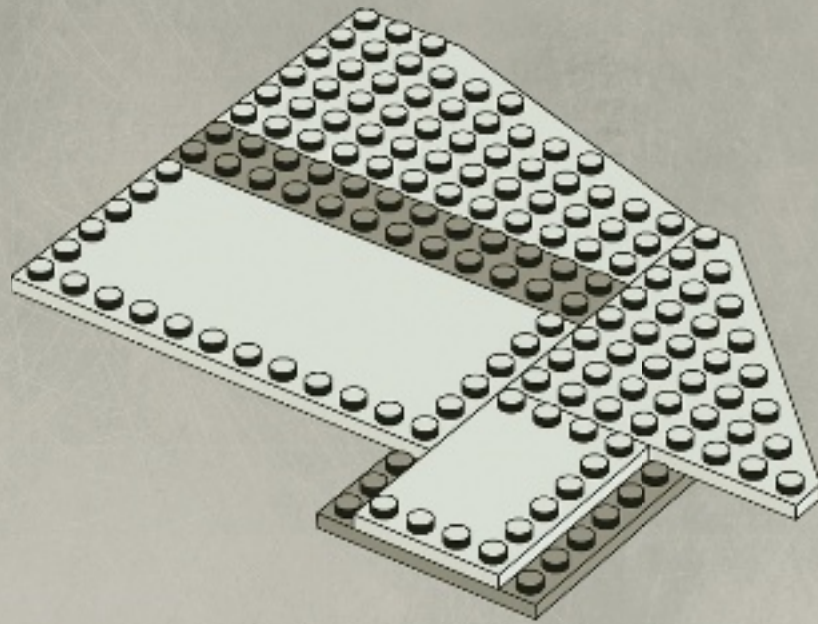

6

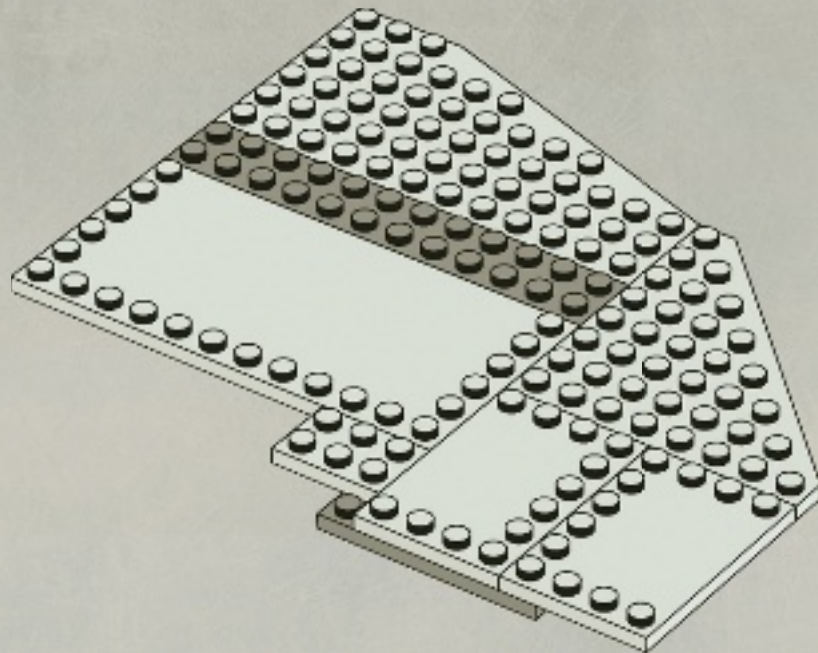

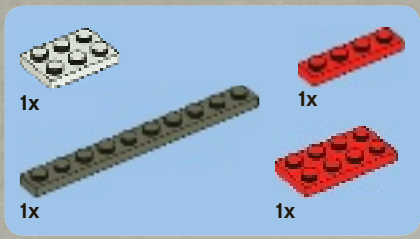

7

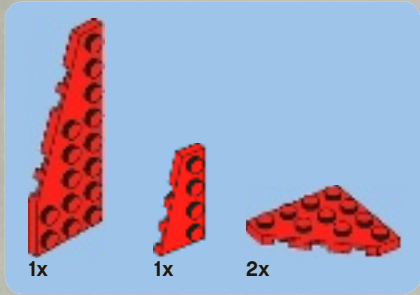
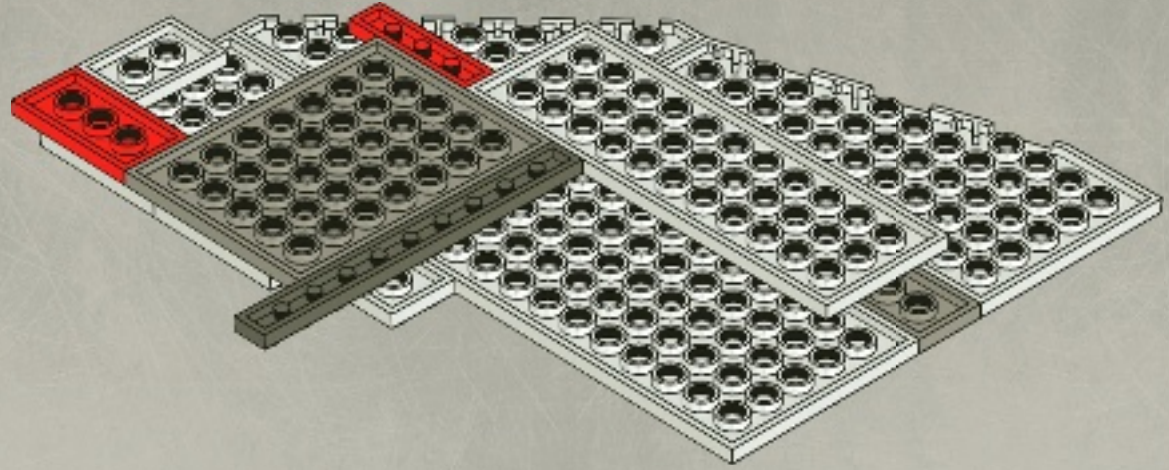

8

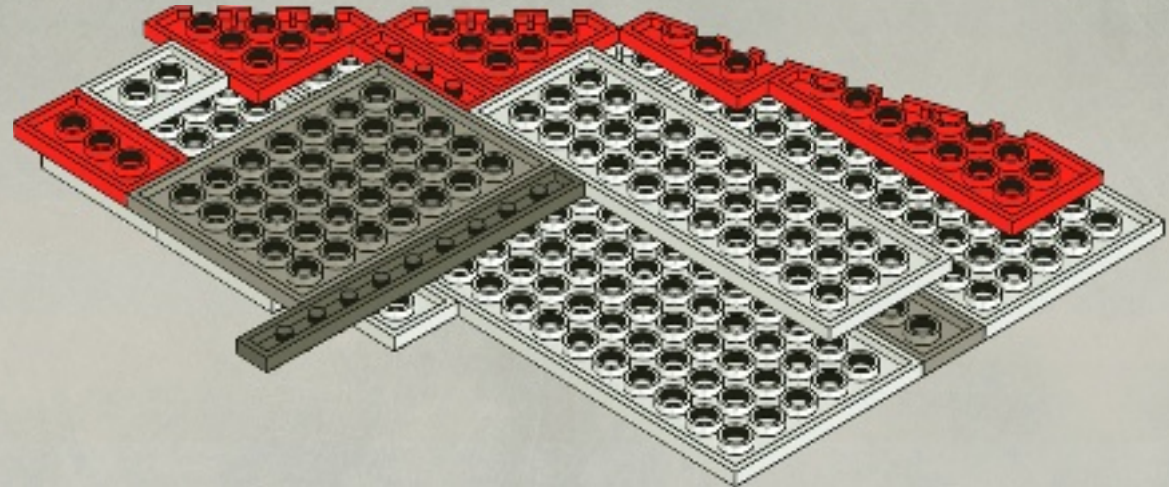

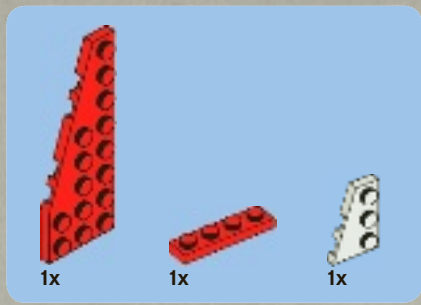

9

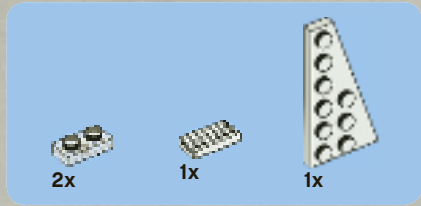
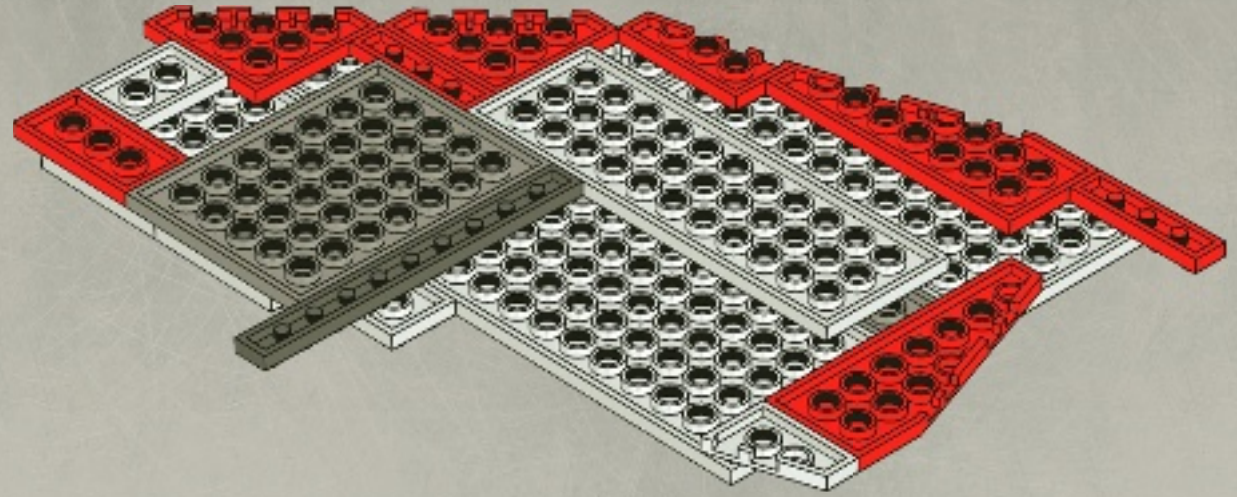

10

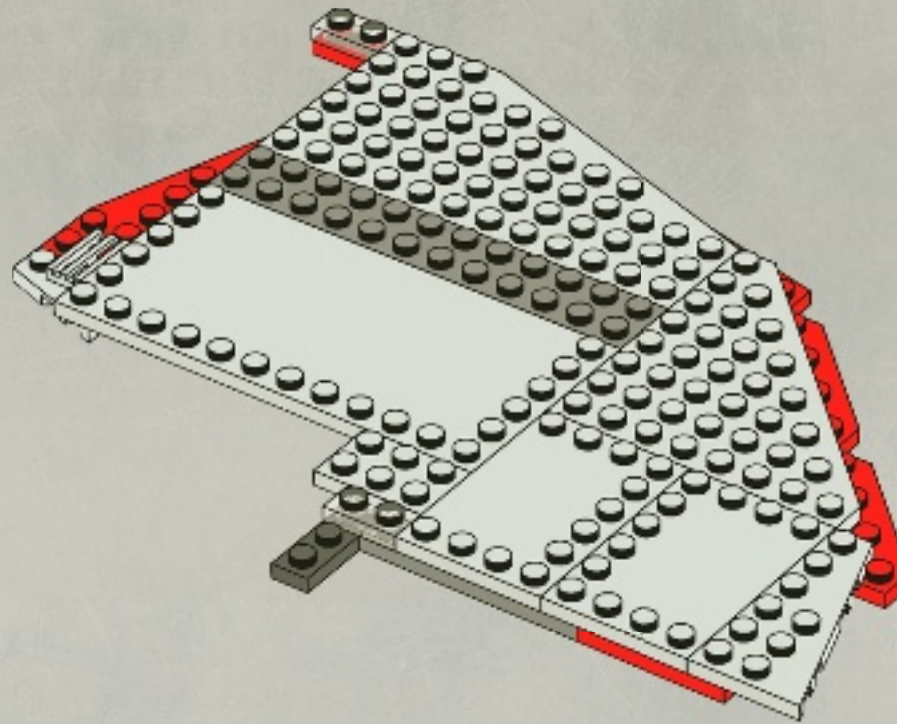

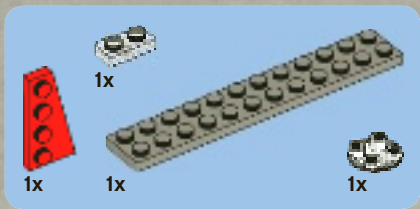

11

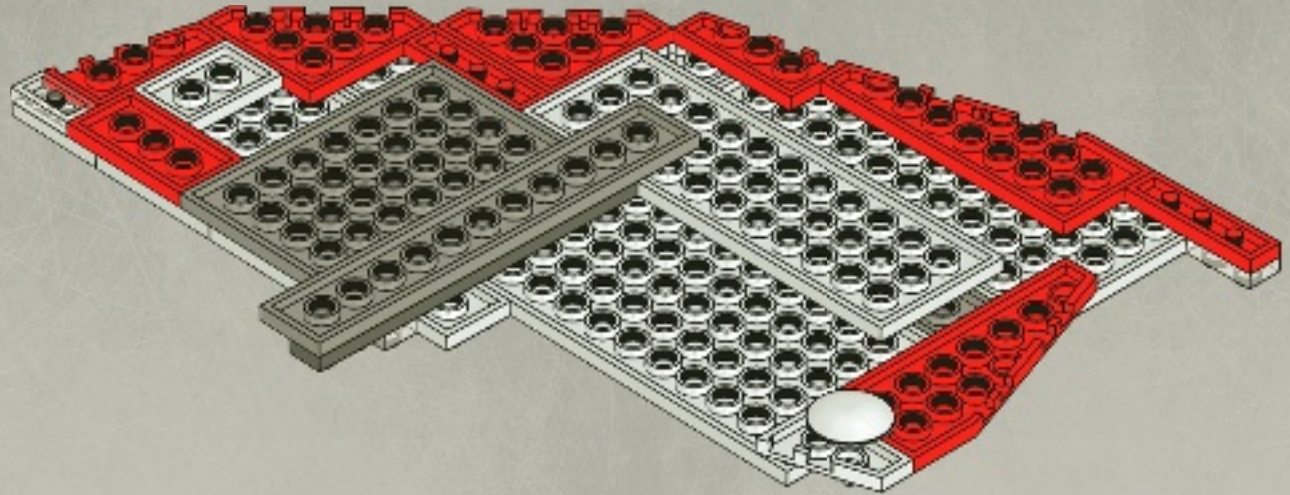

12

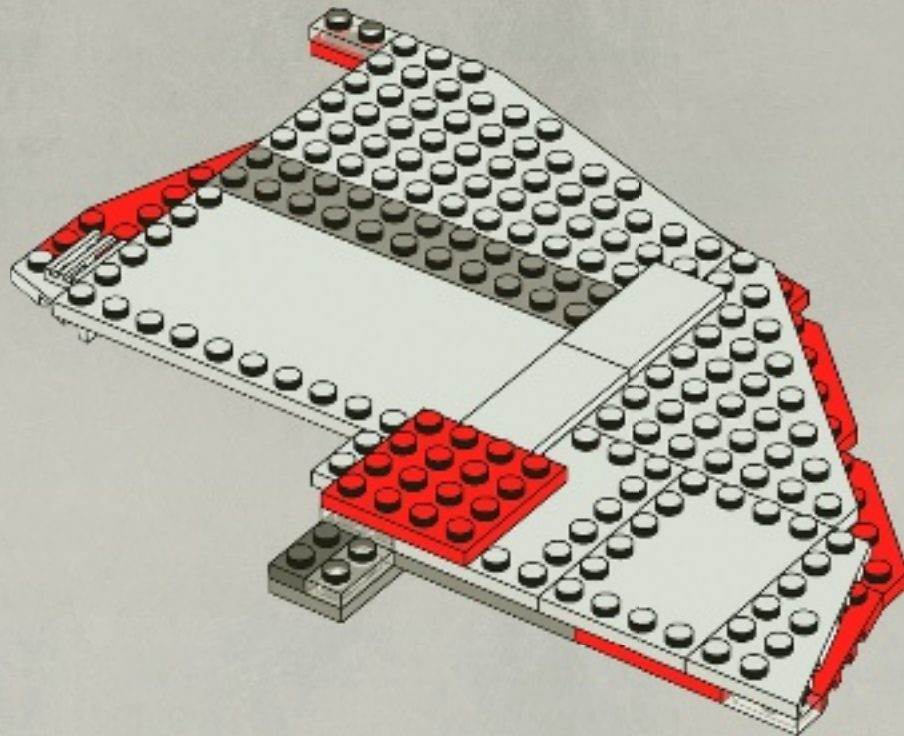



1x



3x

13

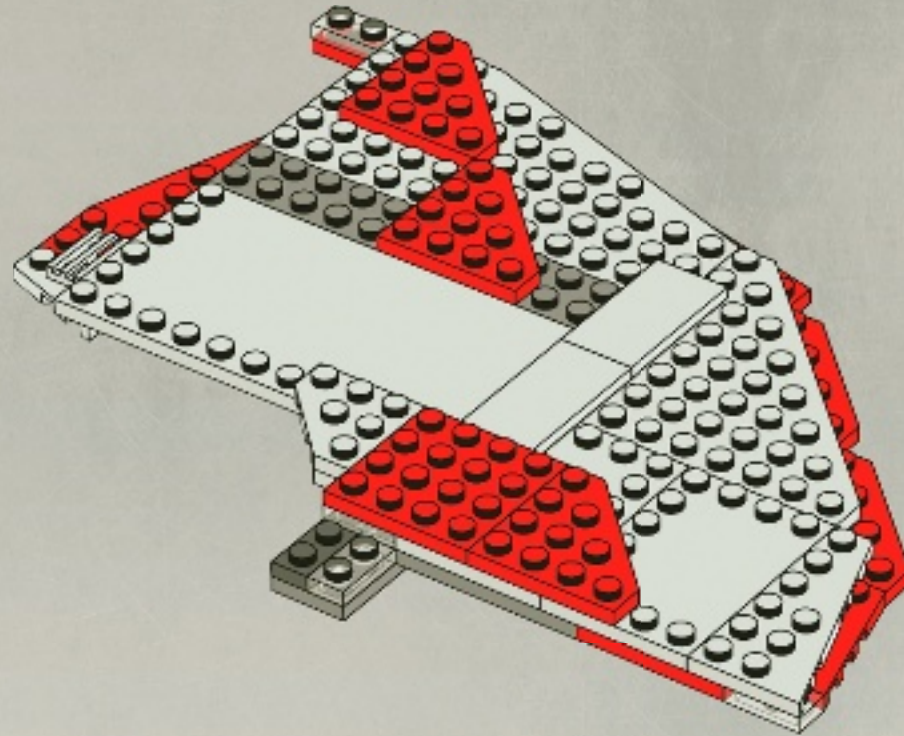



1x



2x

14

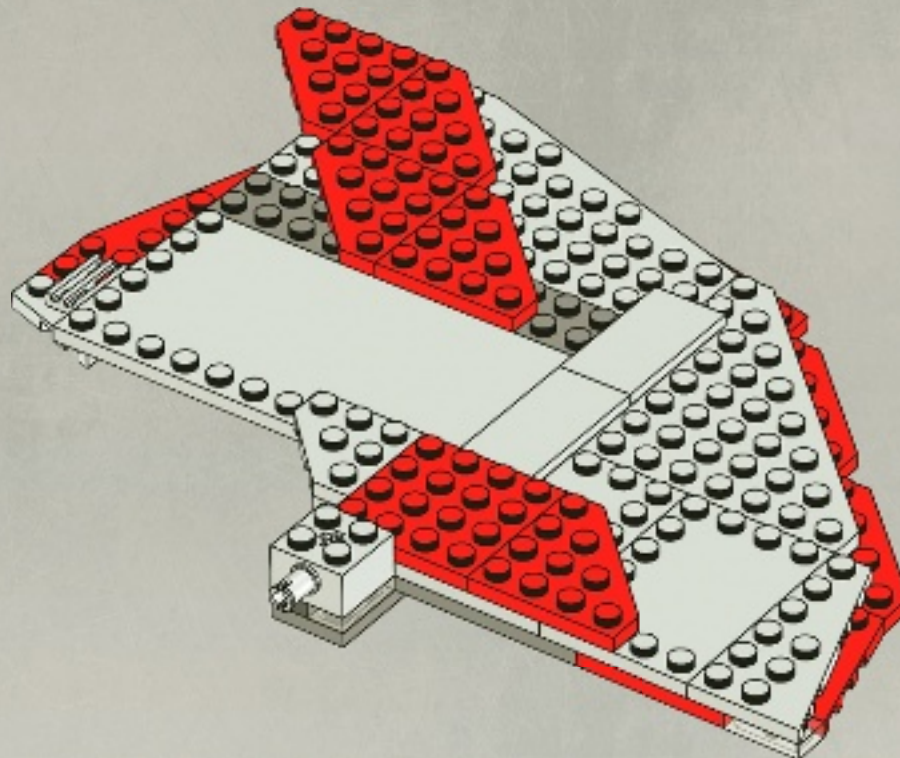



15

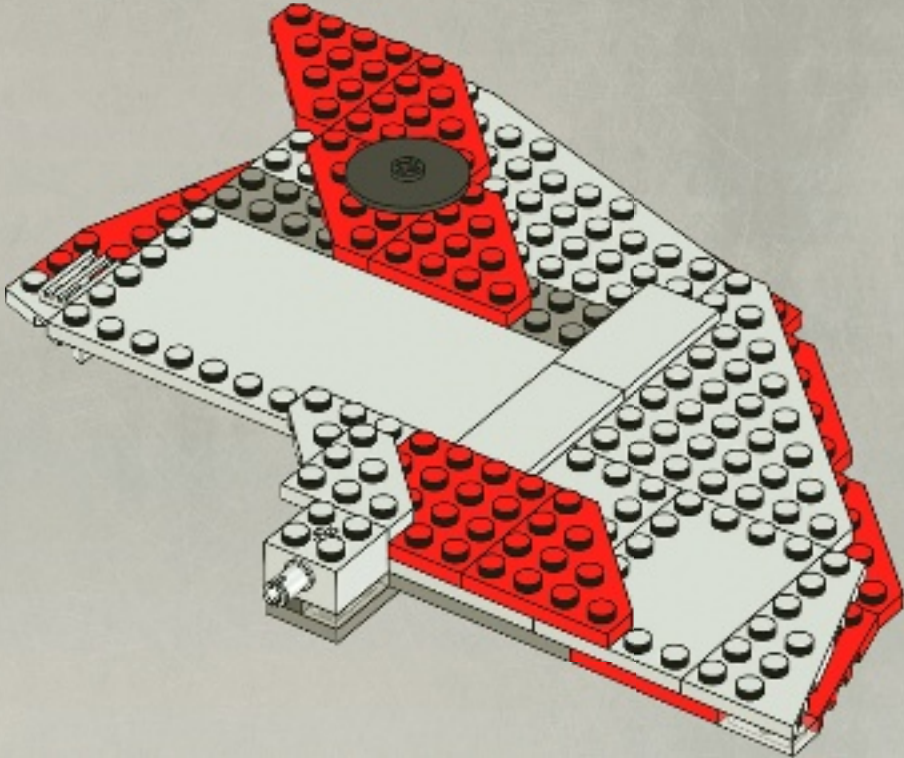



1x



1x



16

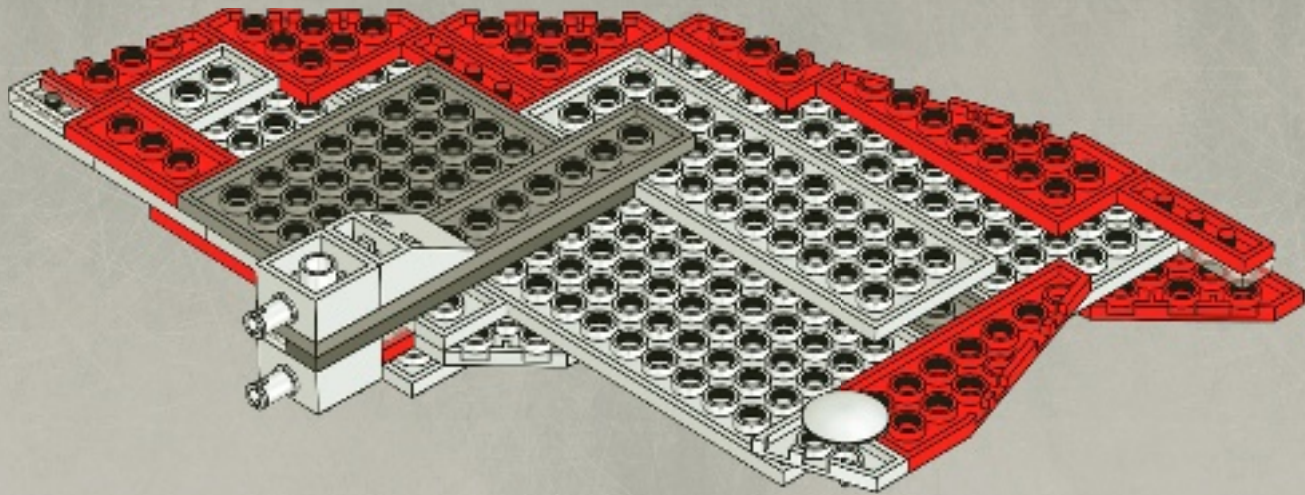

1x

17

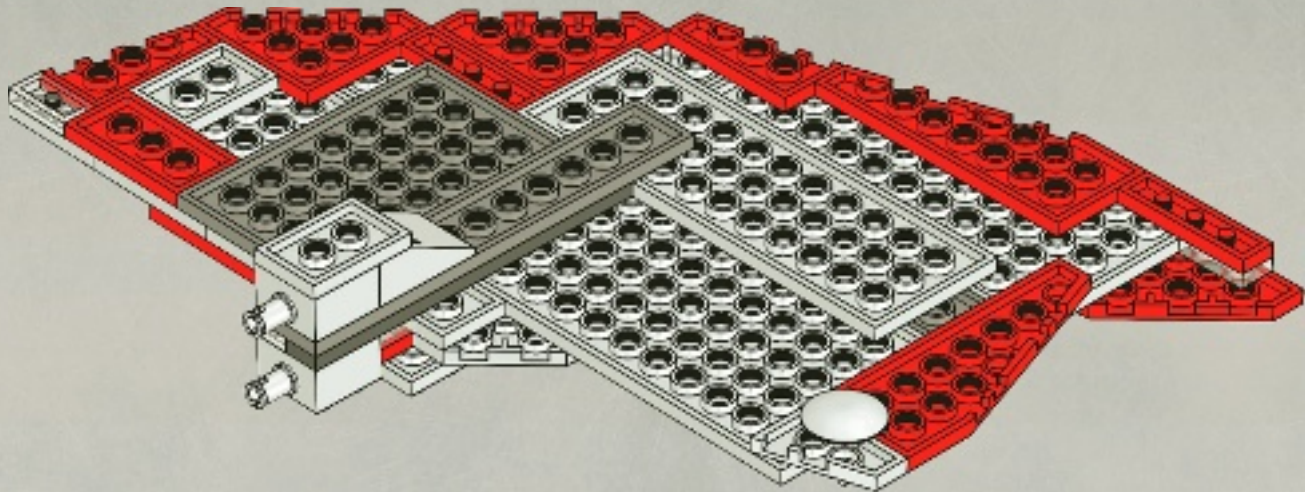

18

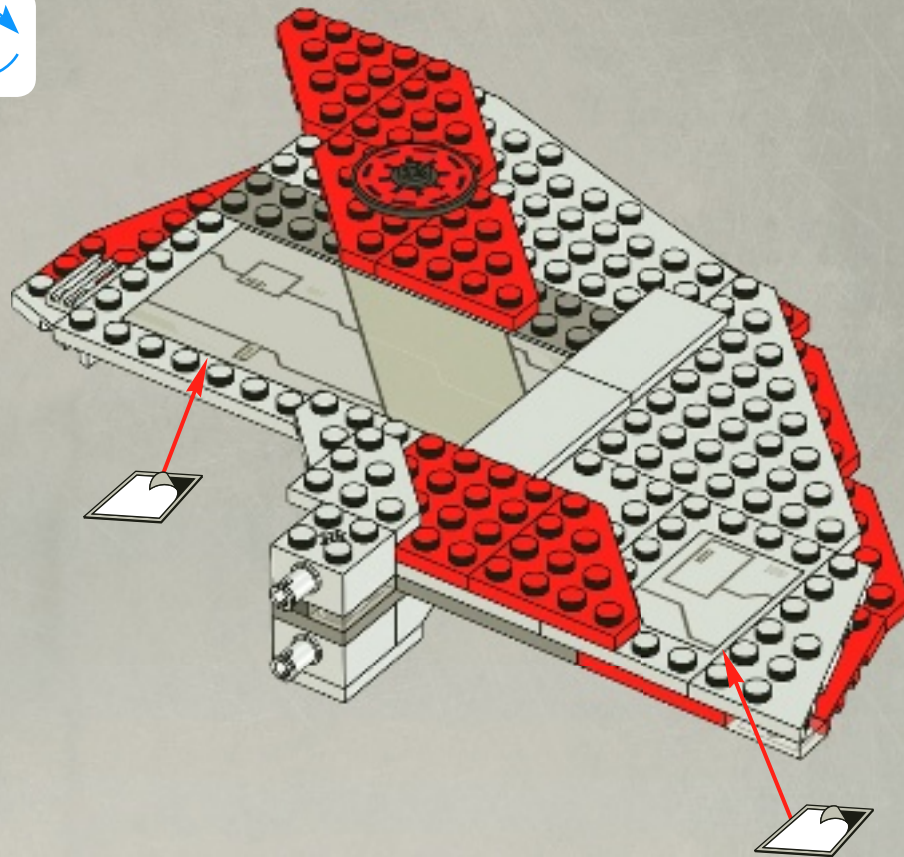

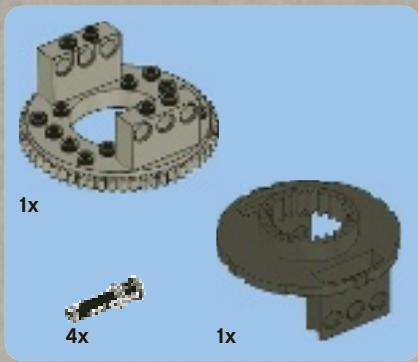

19

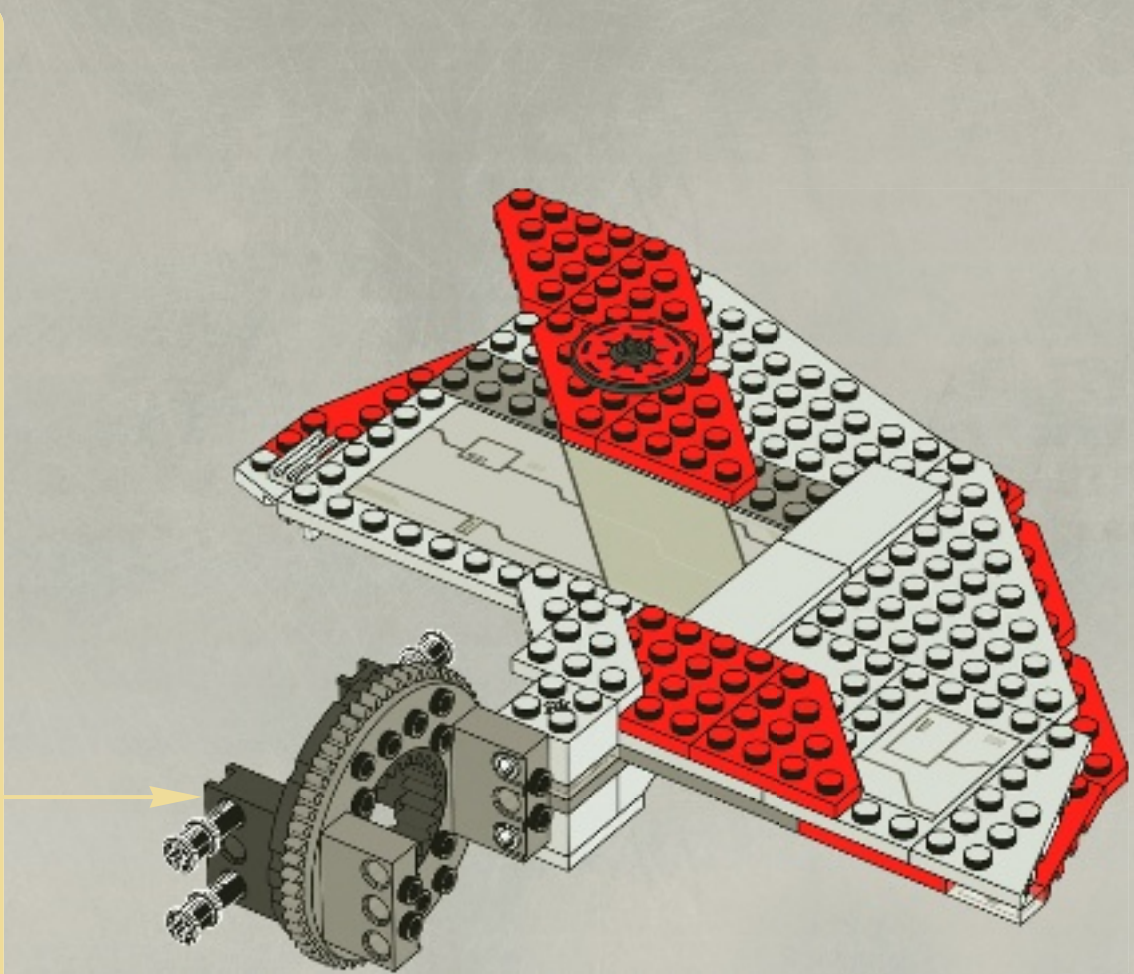
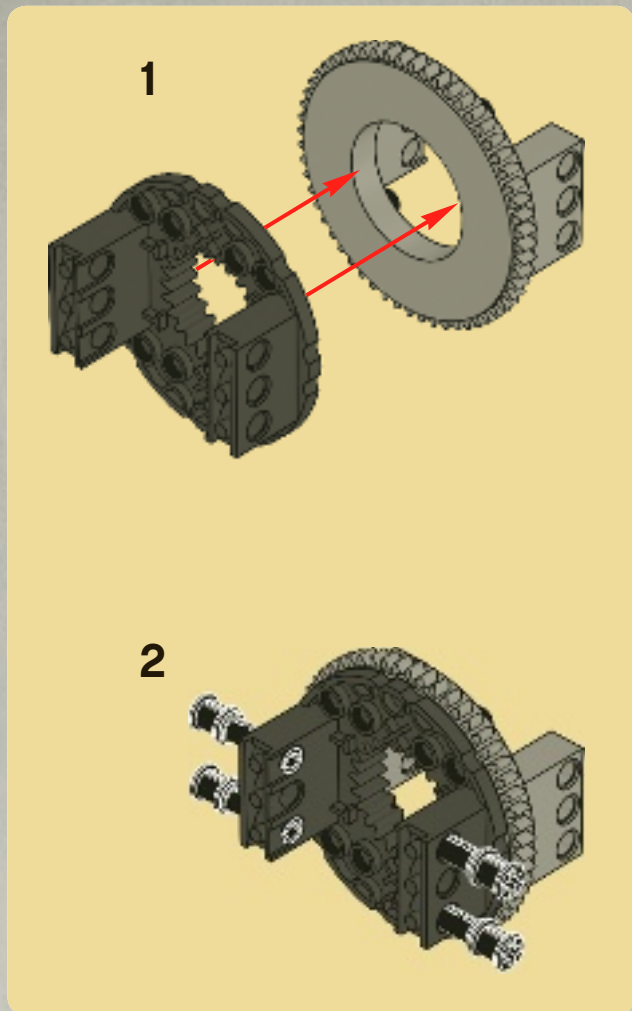

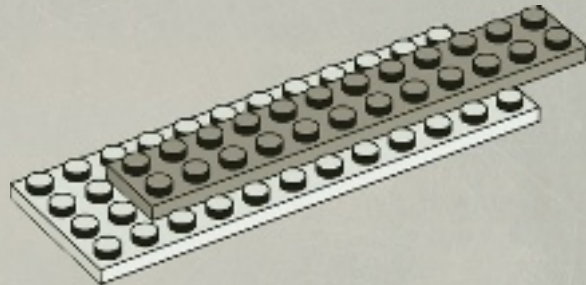
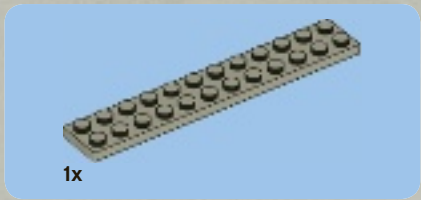
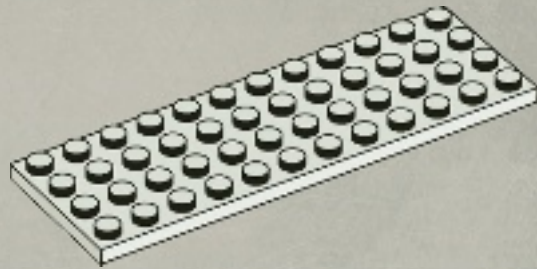
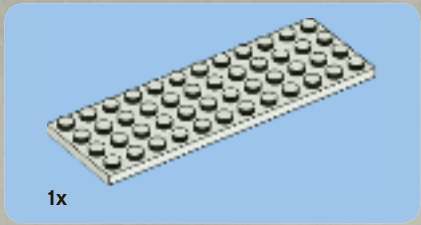
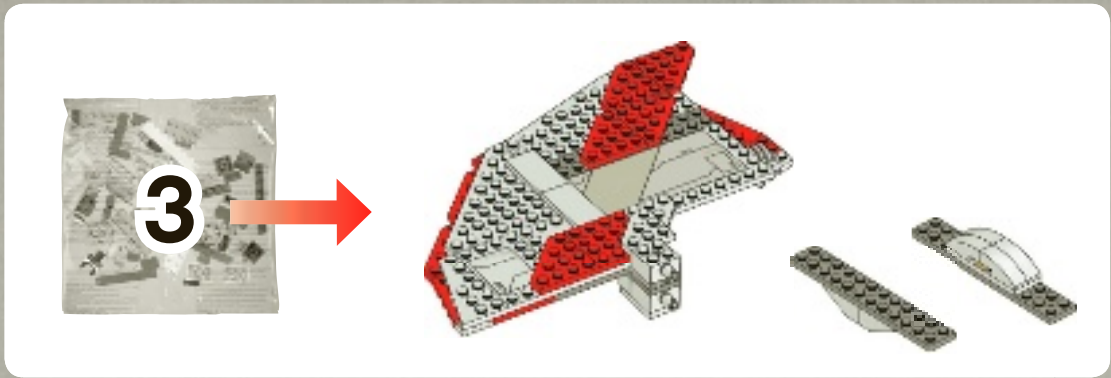

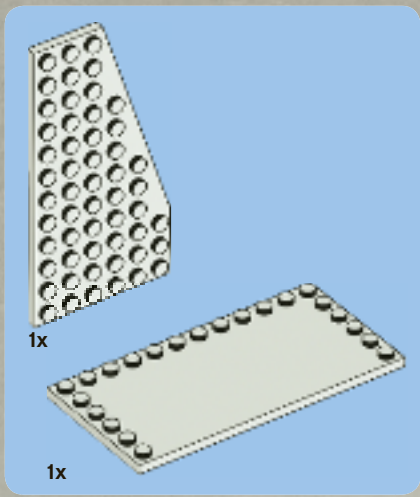

3

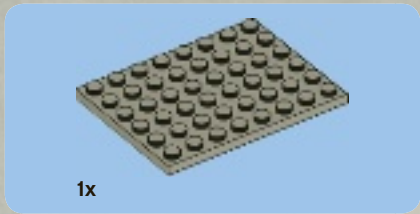
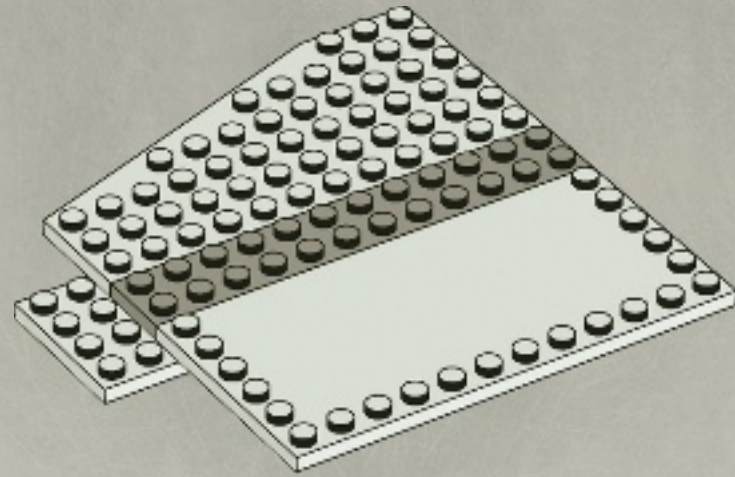

4

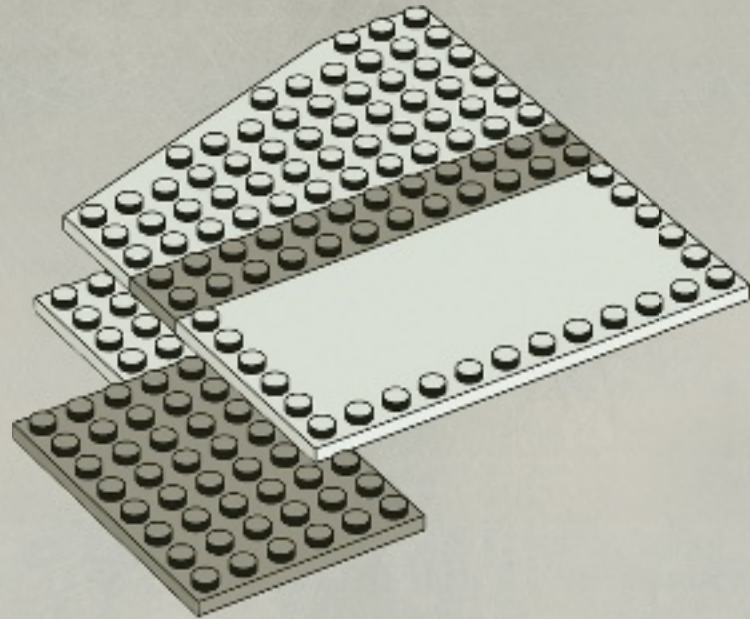

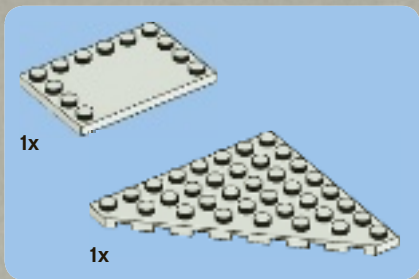

5

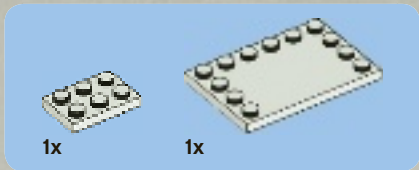
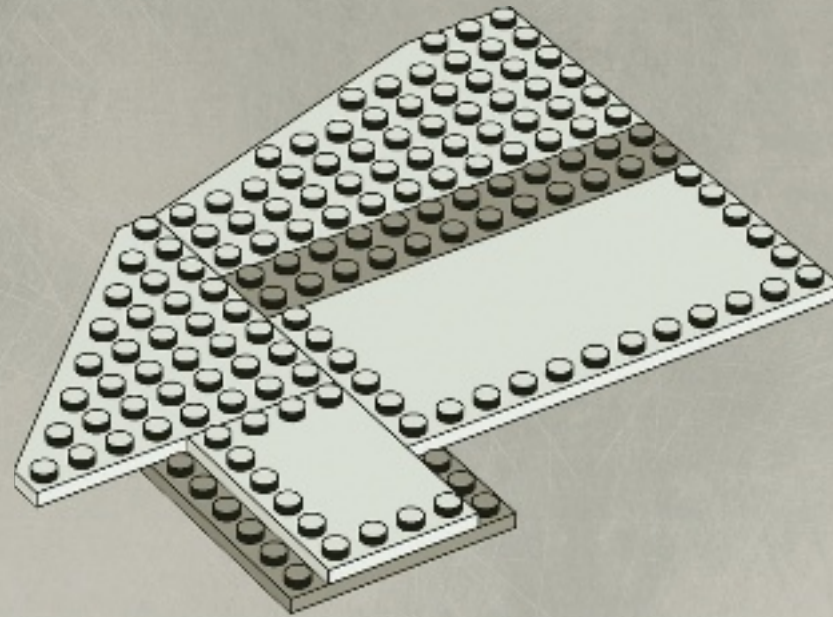

6

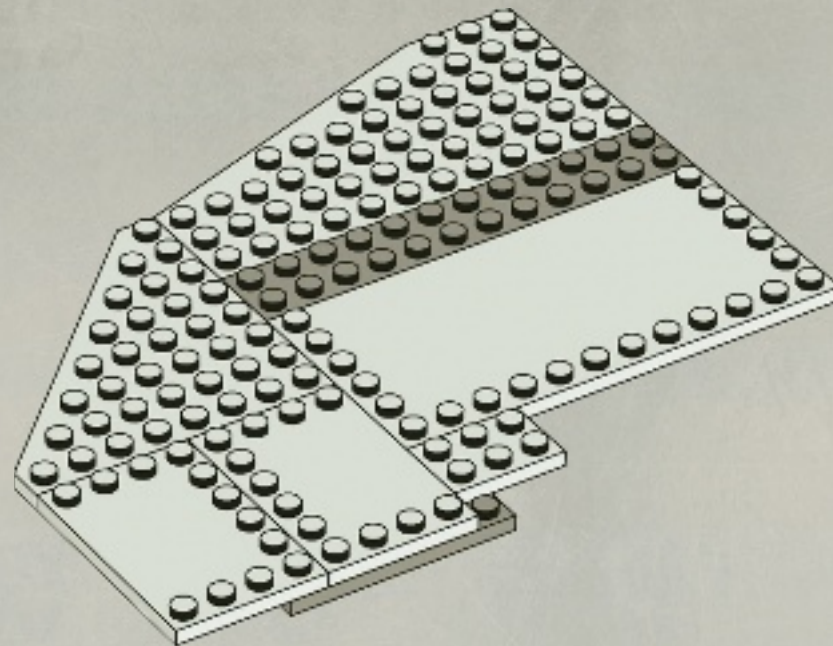

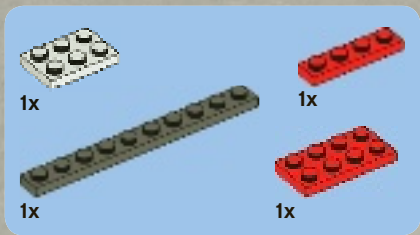

7

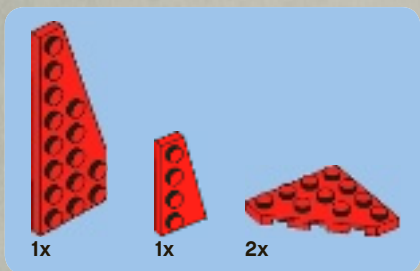
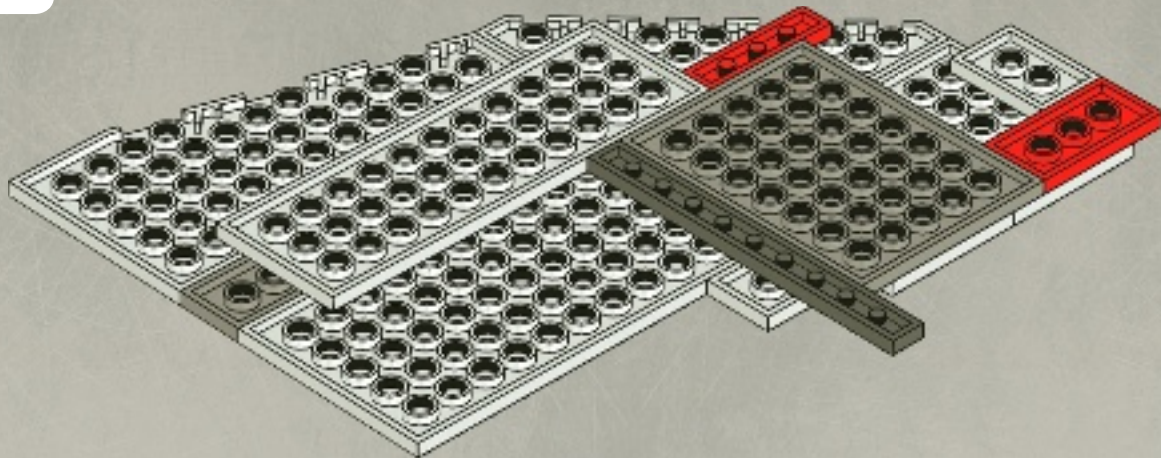

8

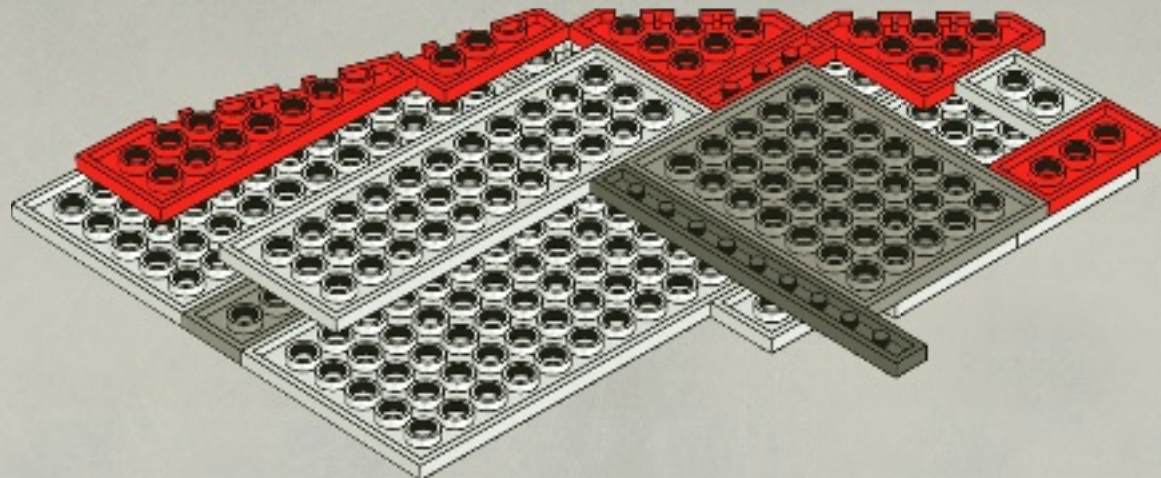

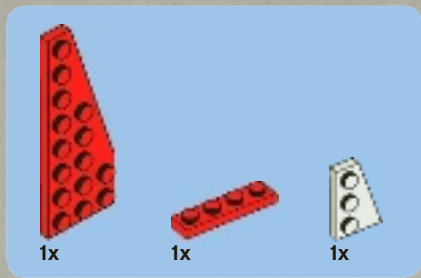

9

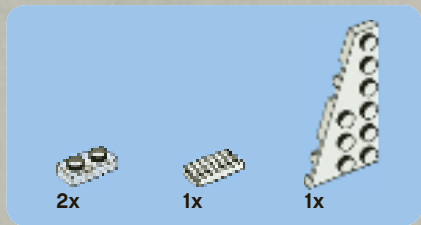
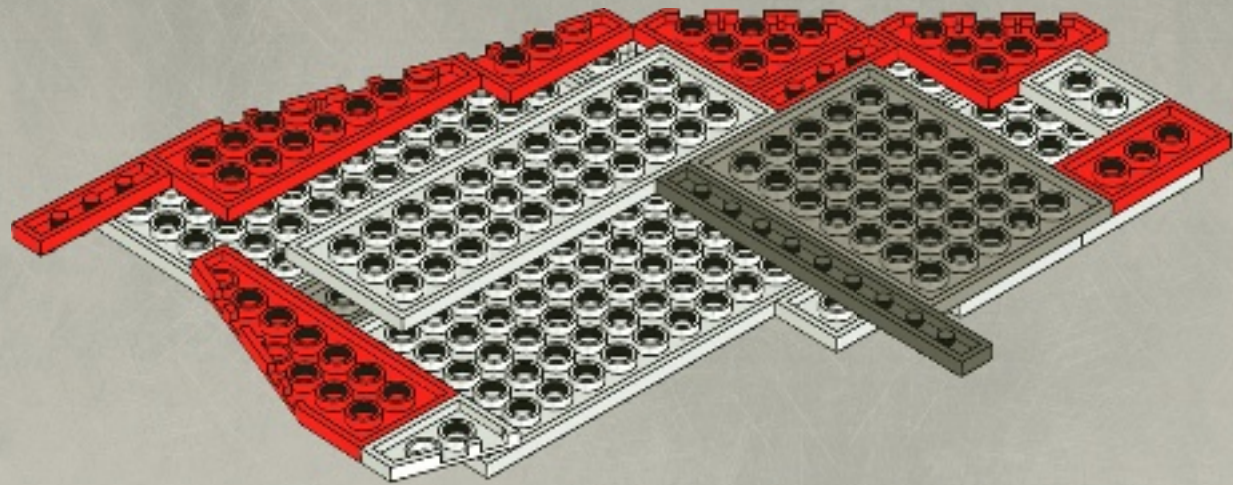

10

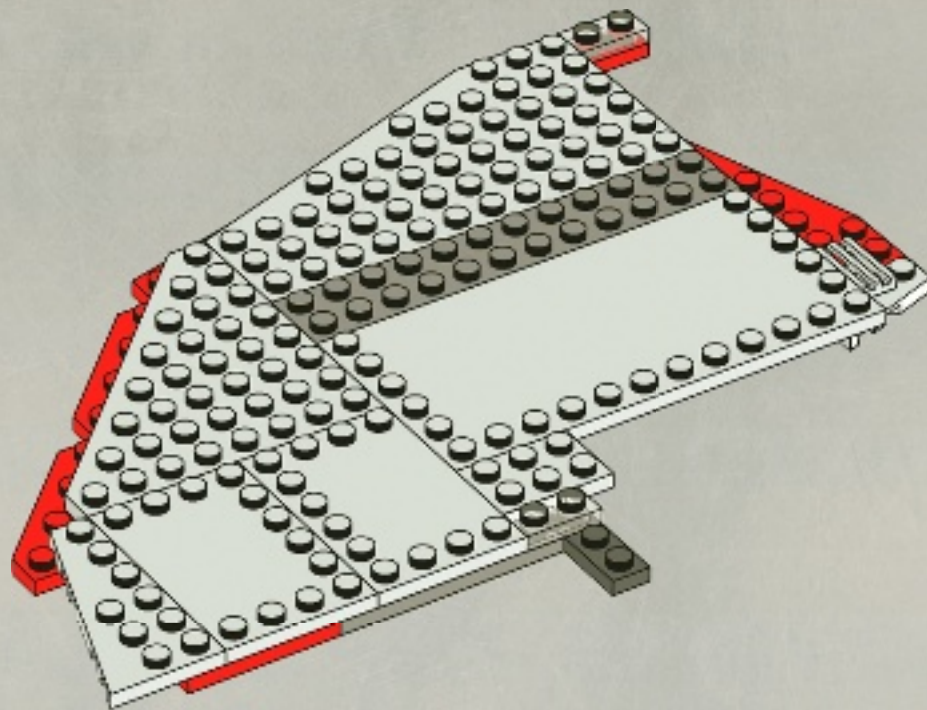

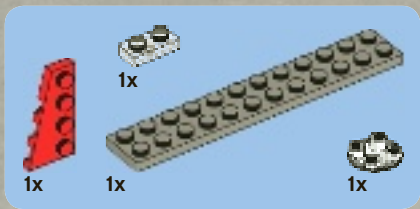

11

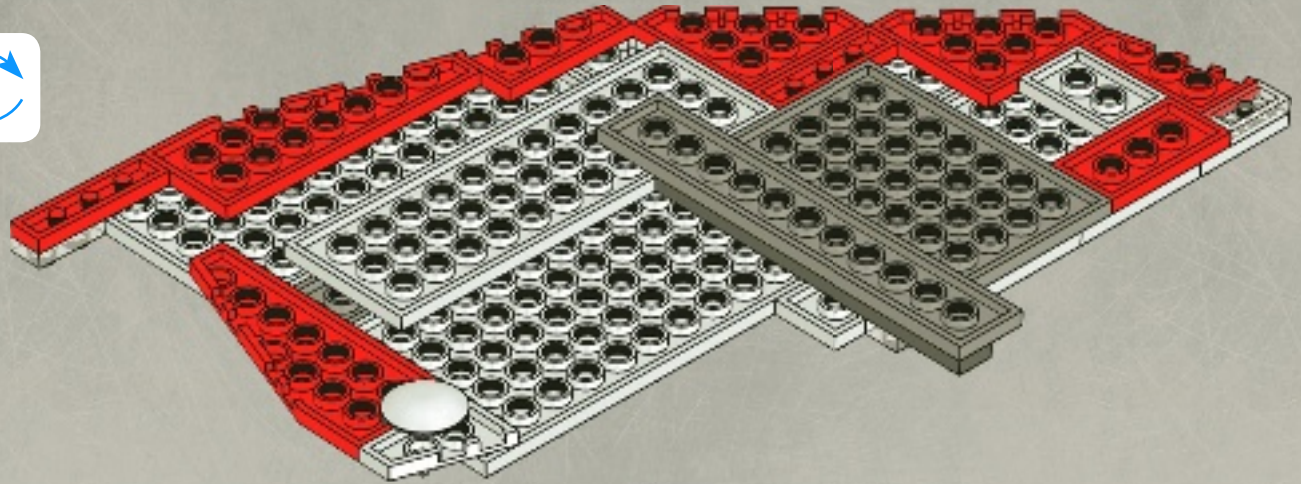

12

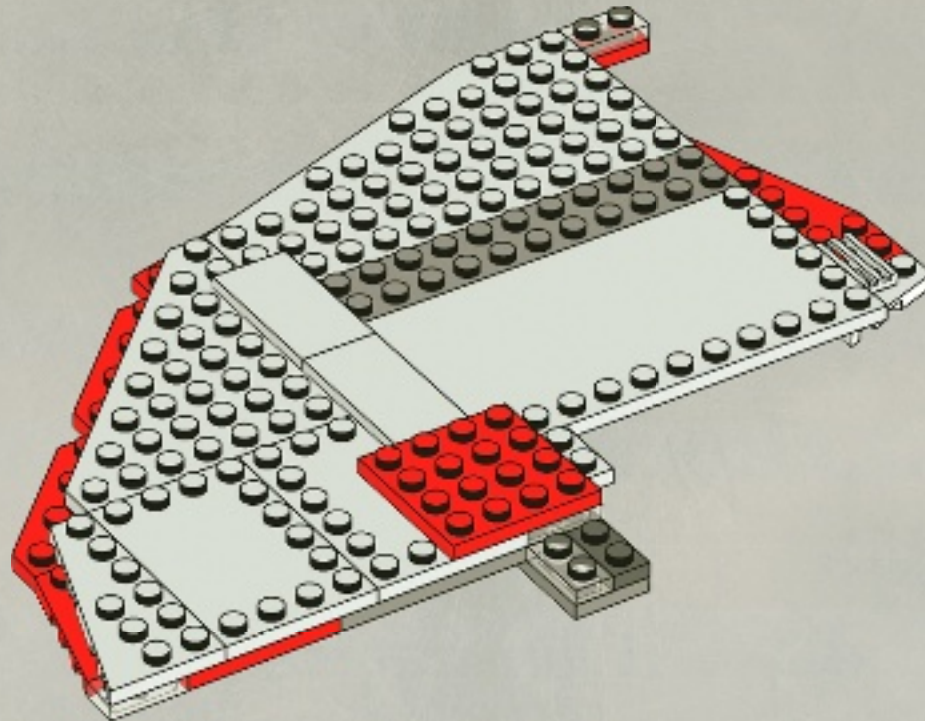



1x



3x

13

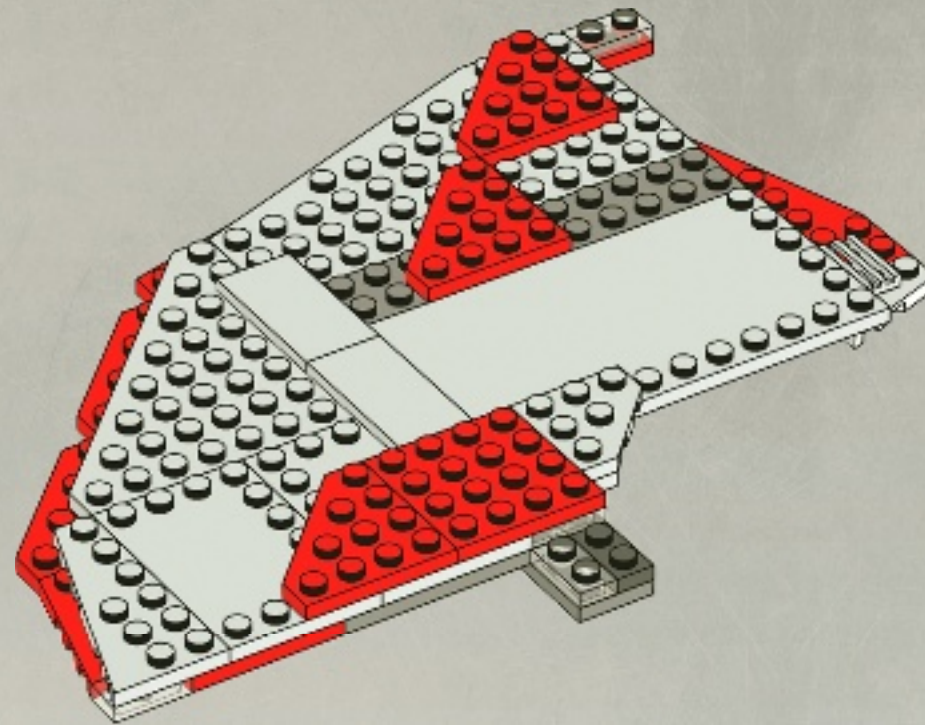



2x

14

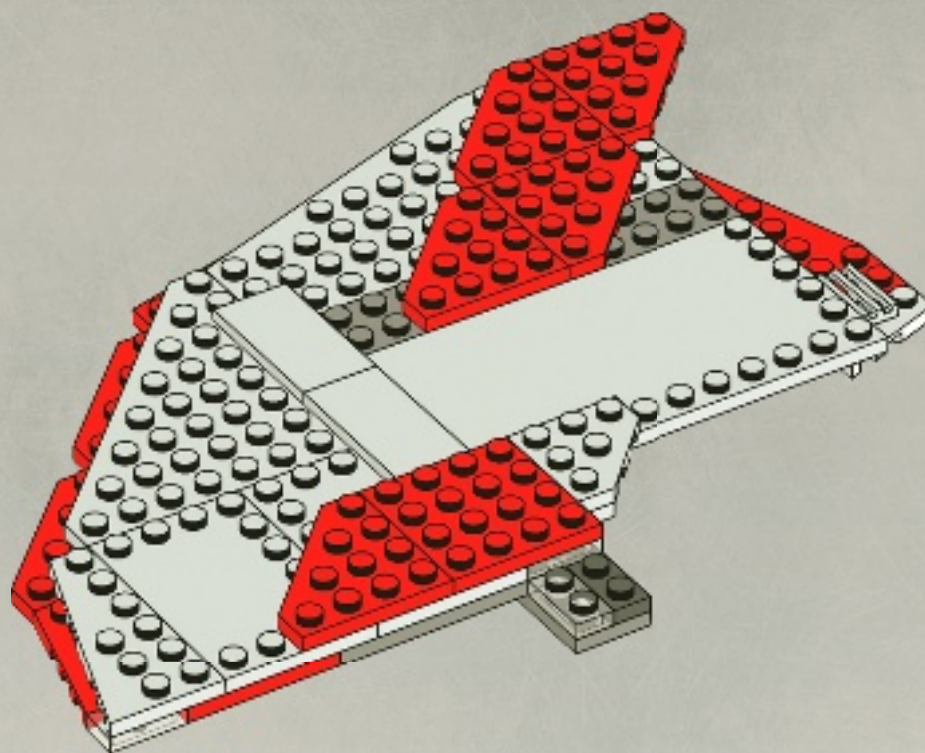



1x



1x

15

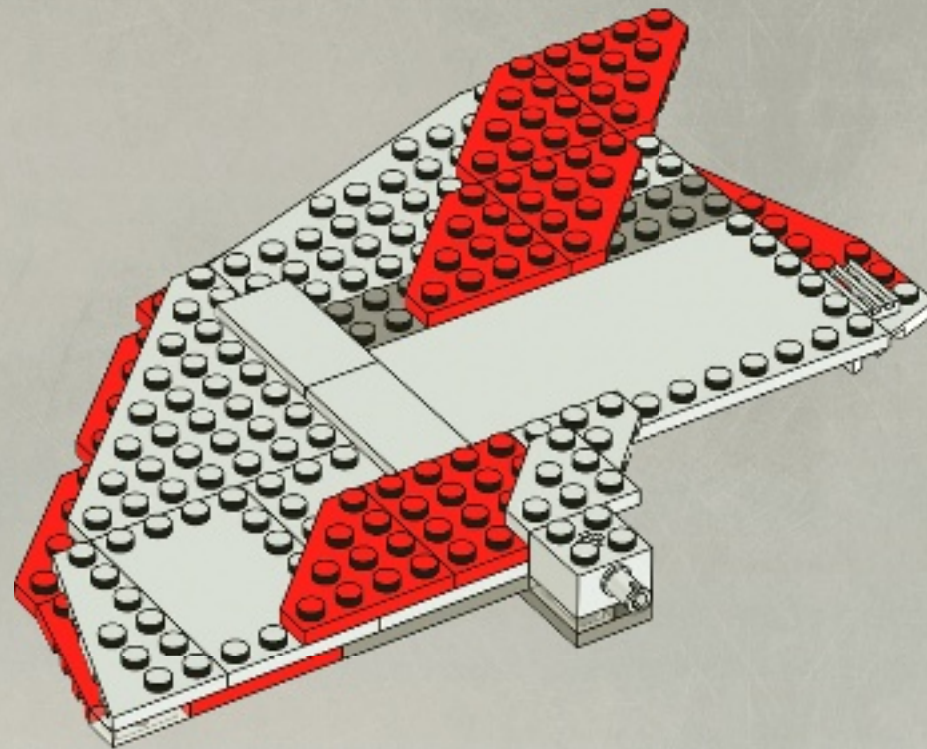



1x



1x



16

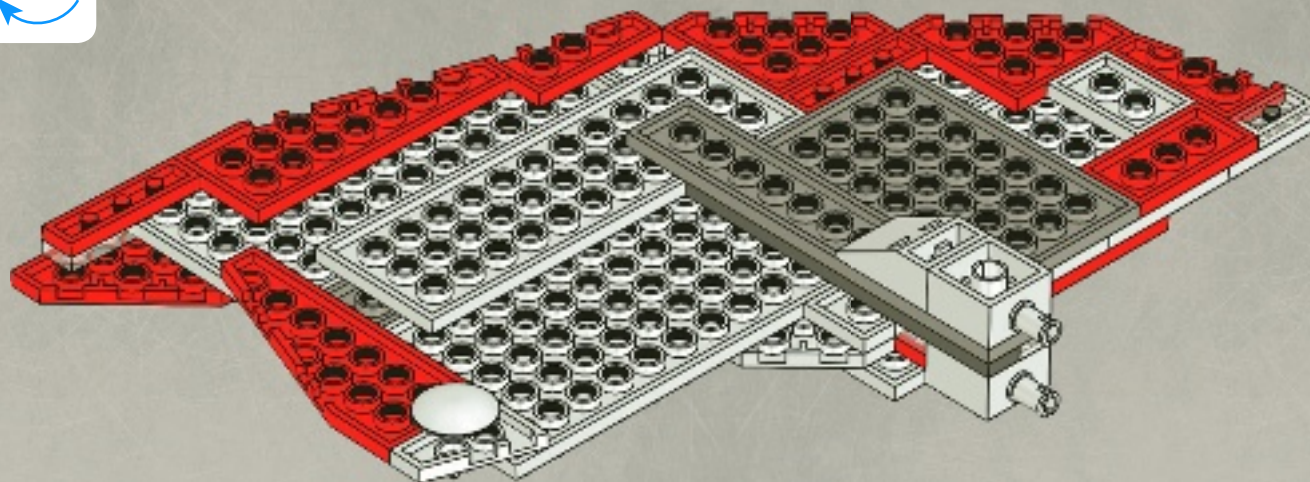

1x

17

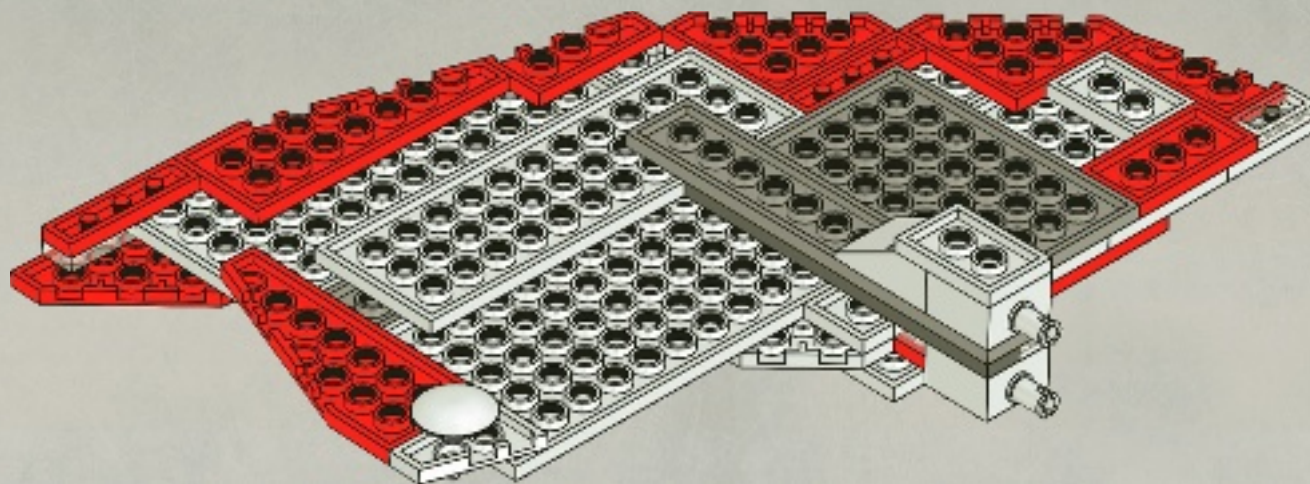

18

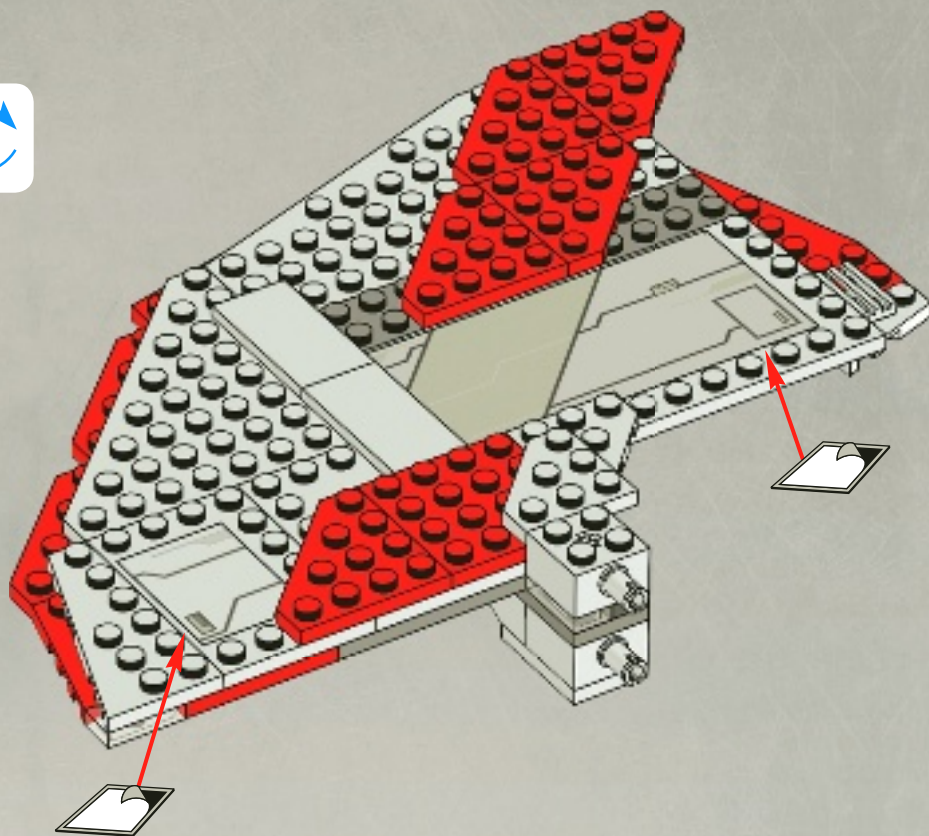

19

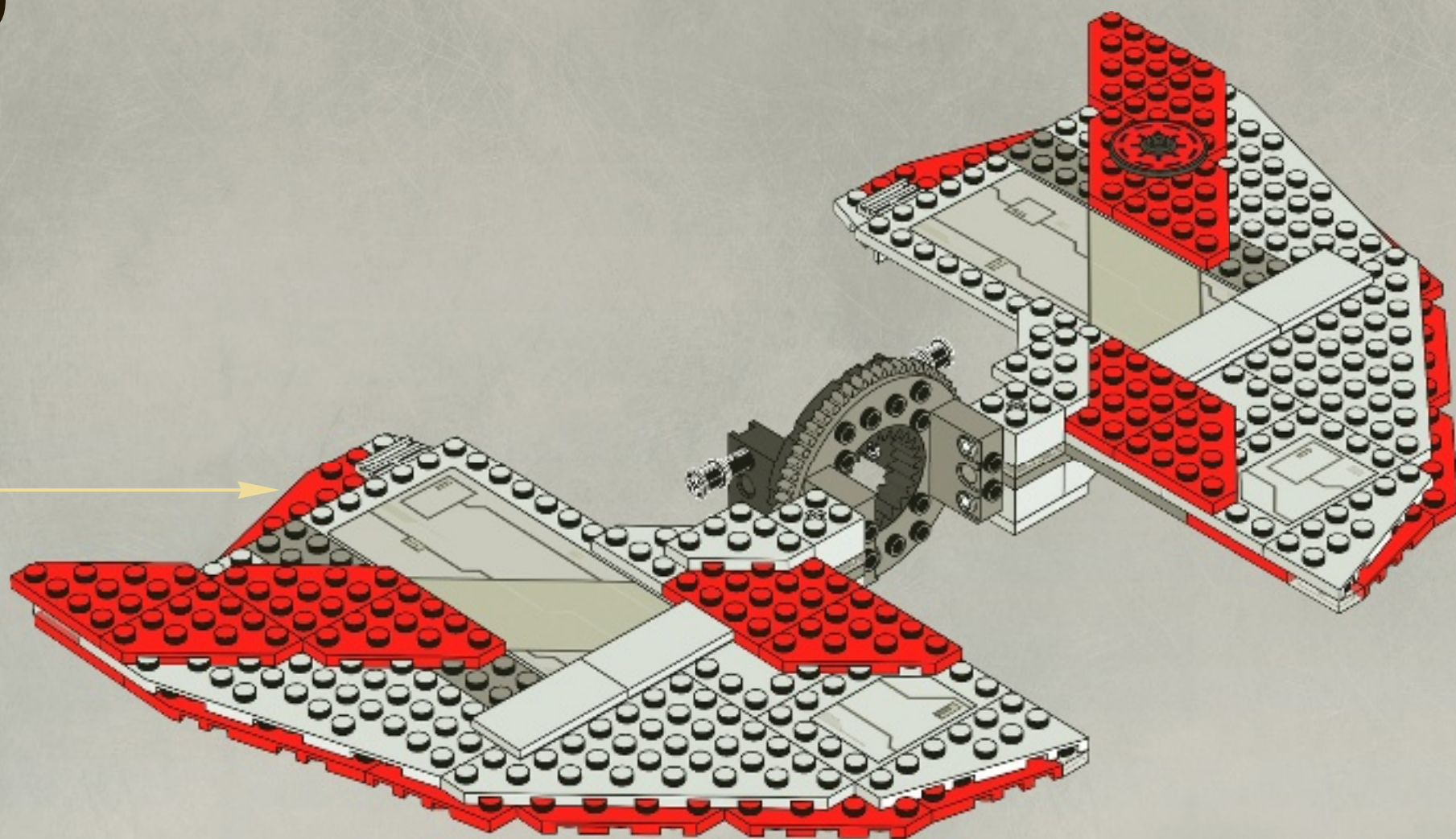

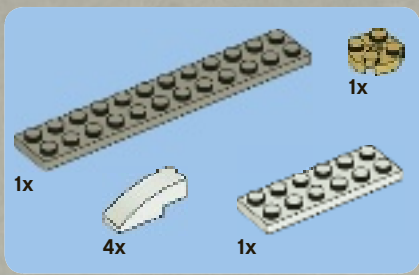

20

1

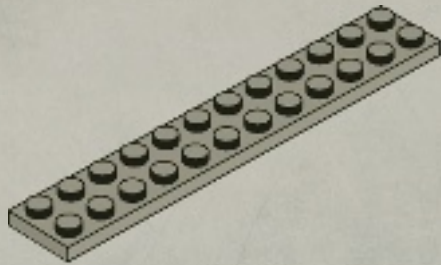

2

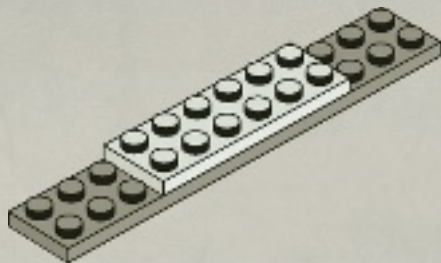

3

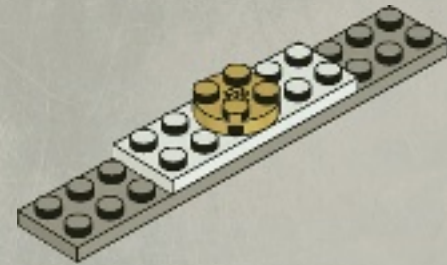

4

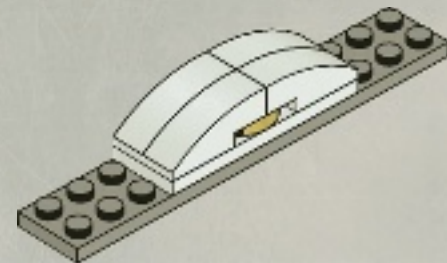

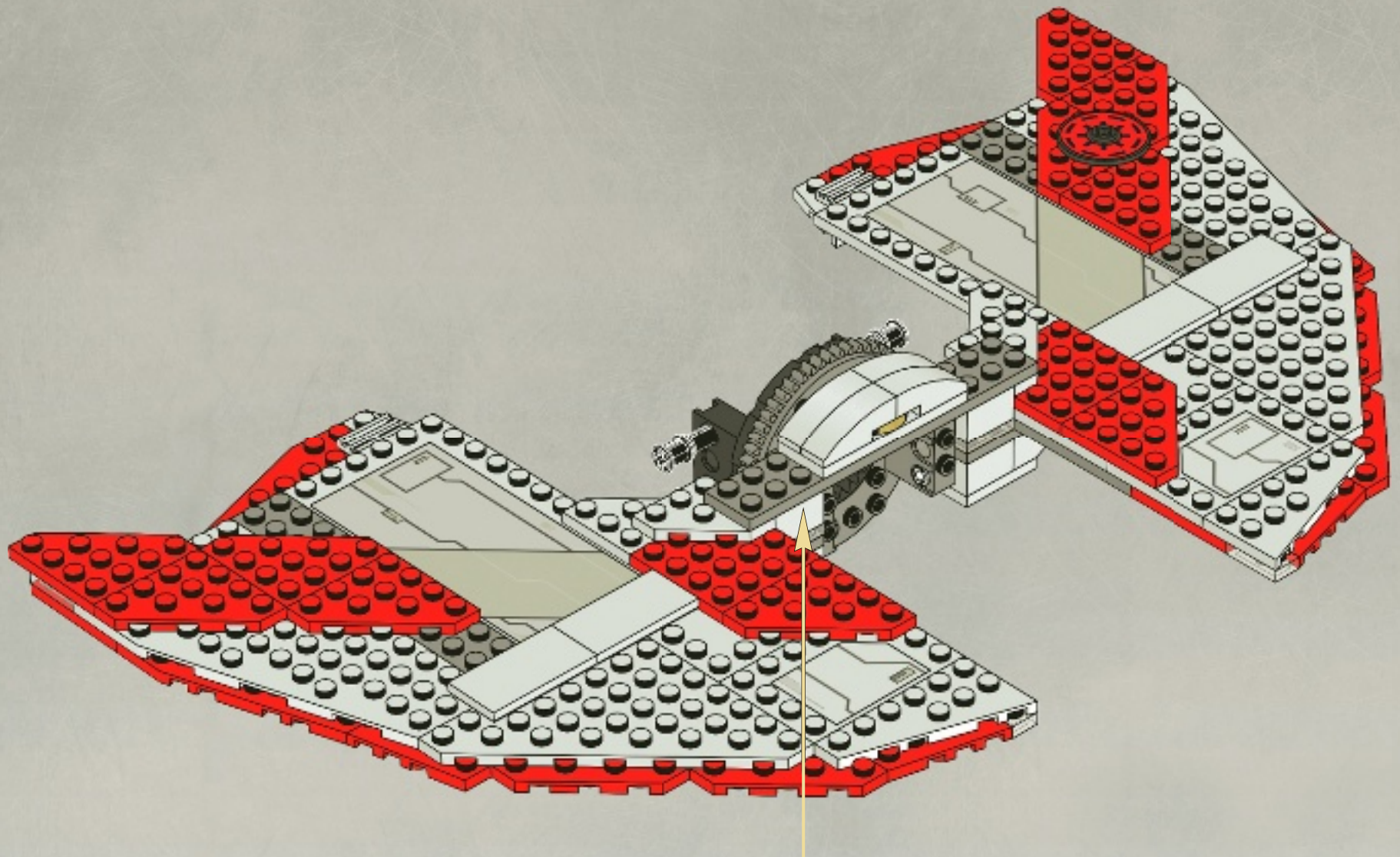

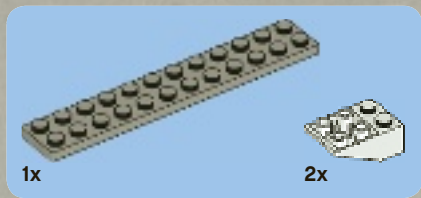

21

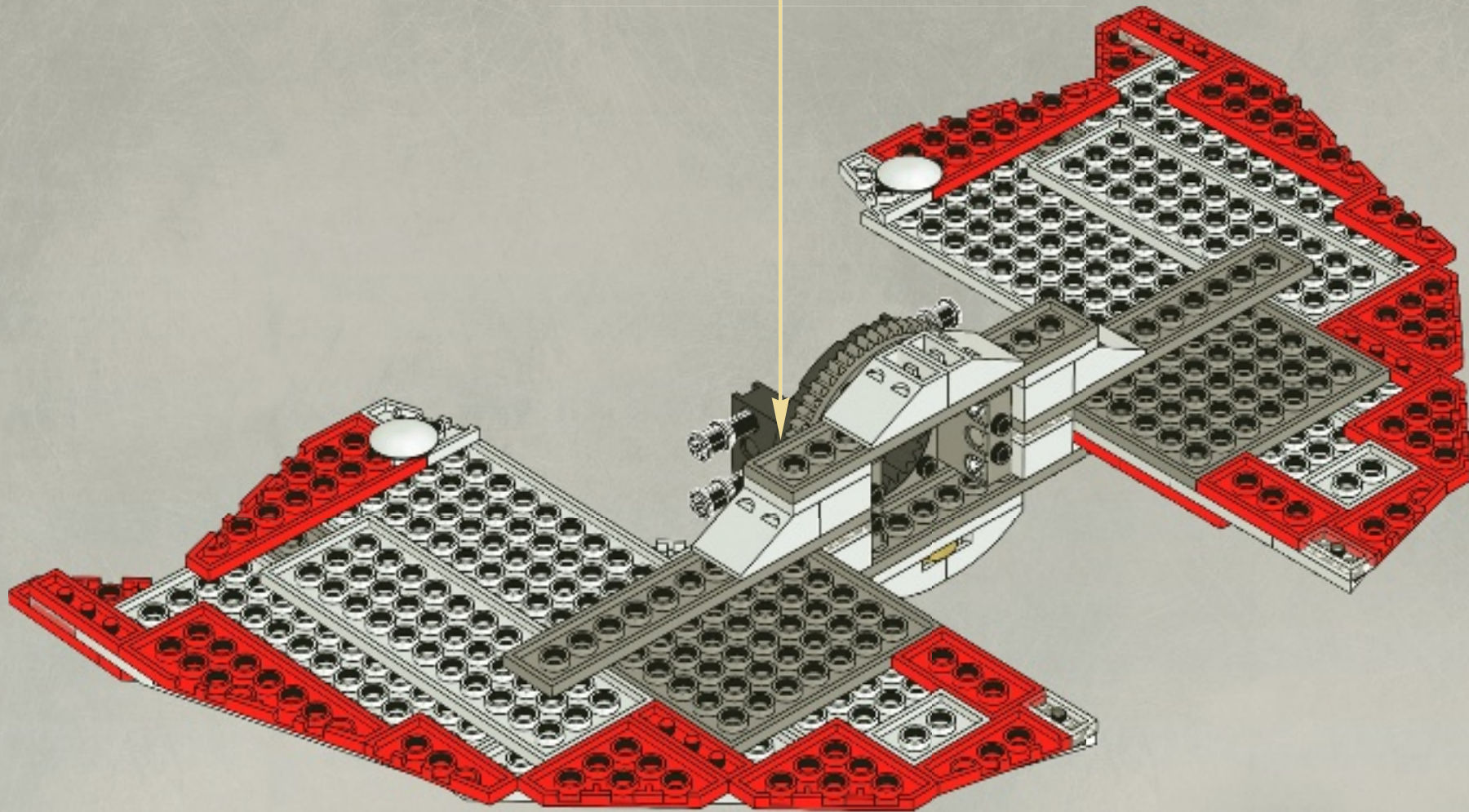
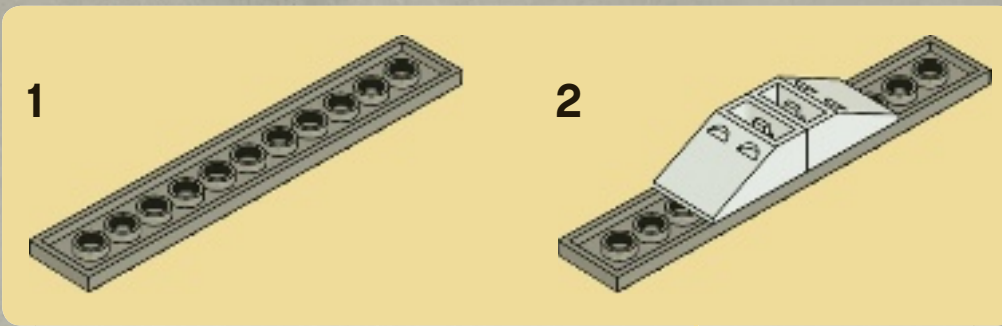

22

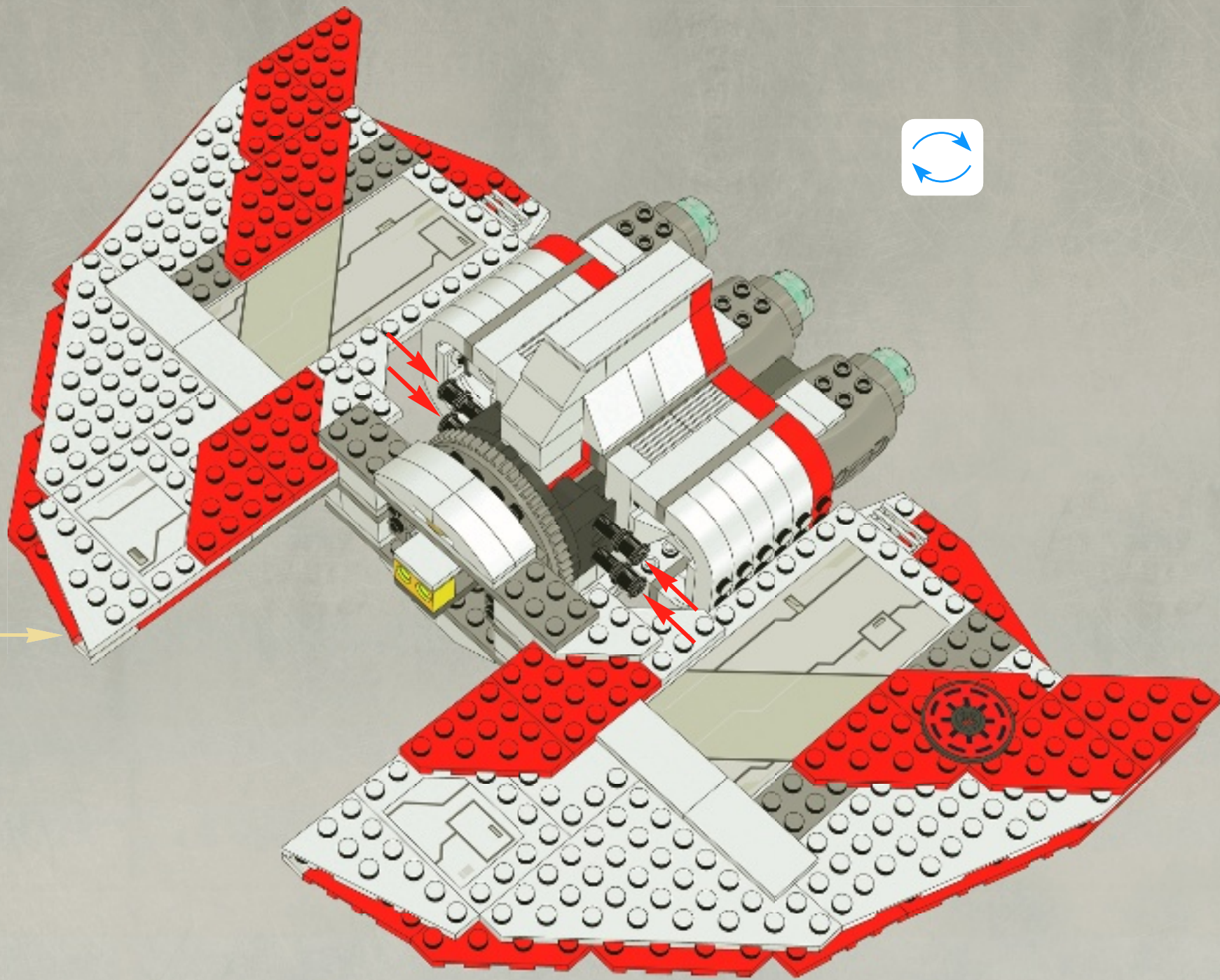

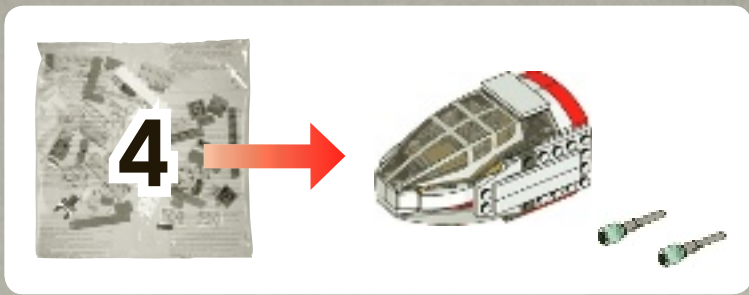

1



2

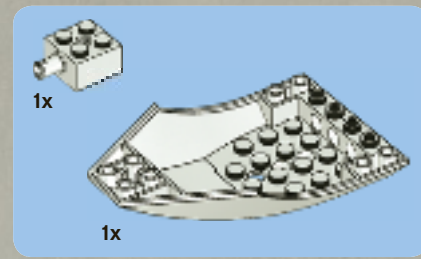
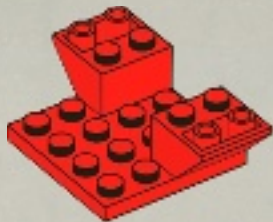

3

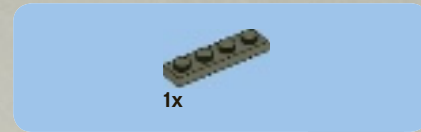
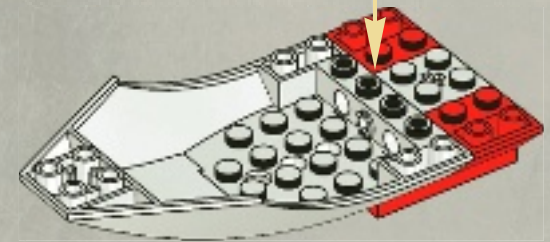
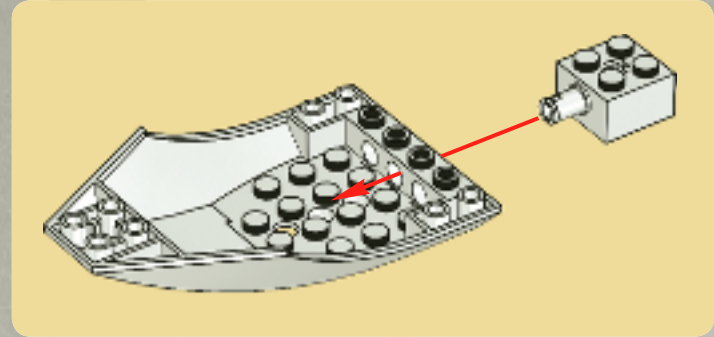

4

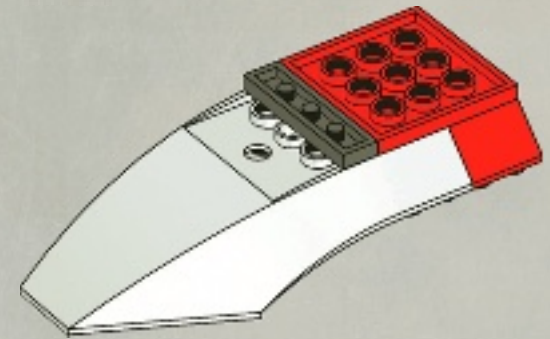



5

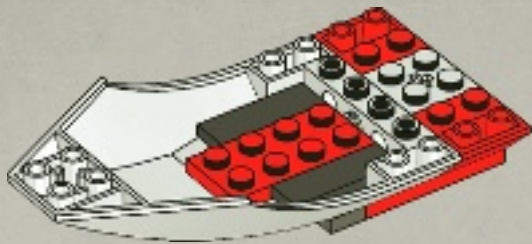

7

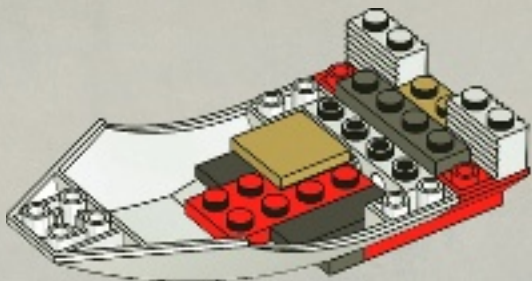

6

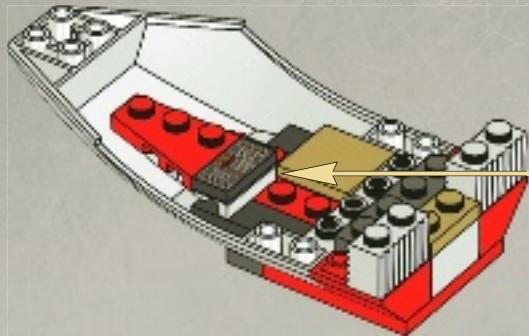

8

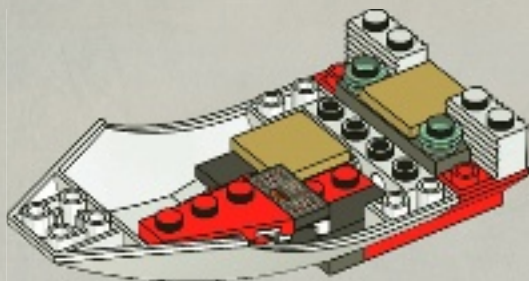



9

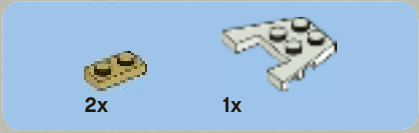
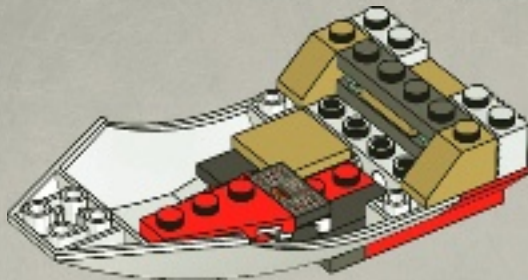

10

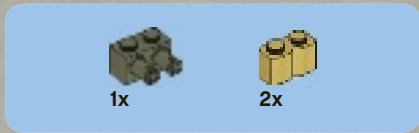
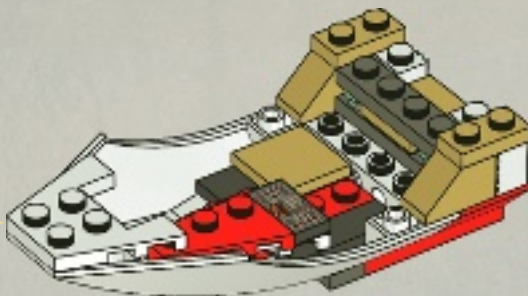

11

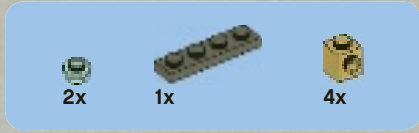
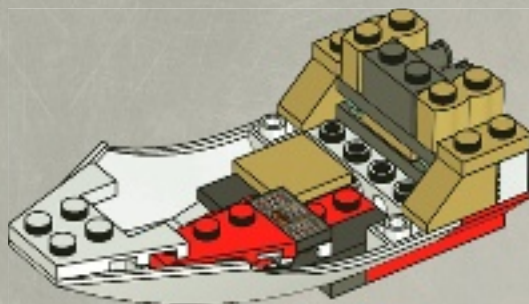

12

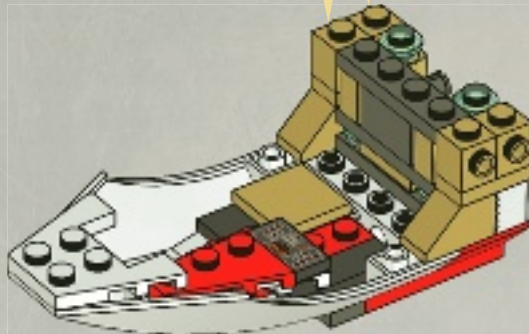



2x

13

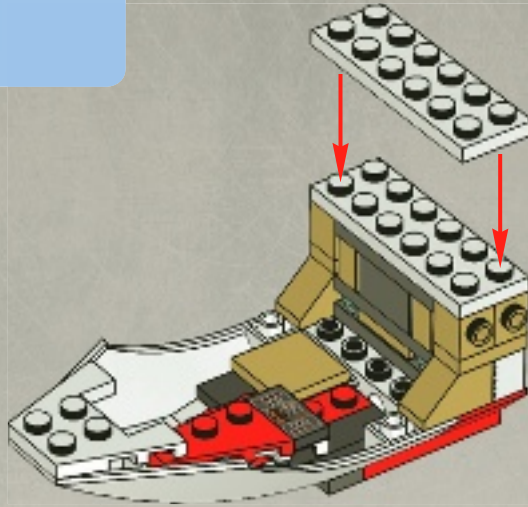

1x

15

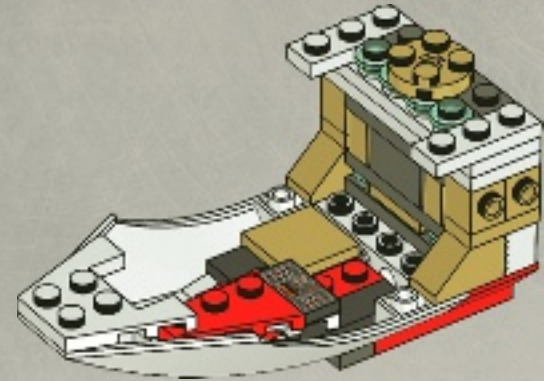

2x



4x



1x

14

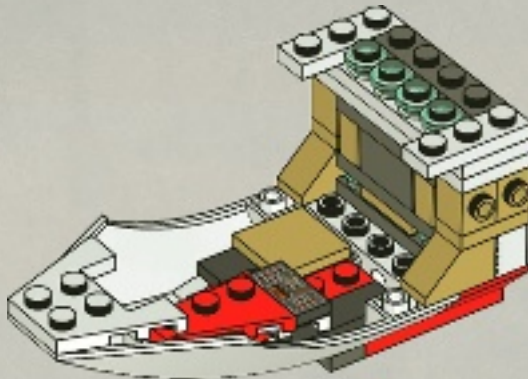

2x



2x

16

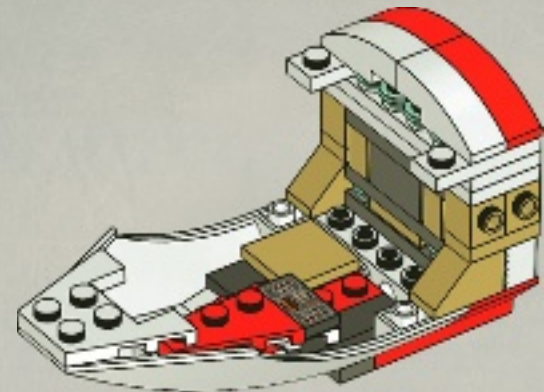

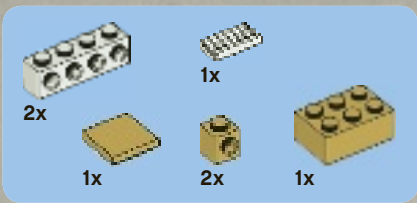

17

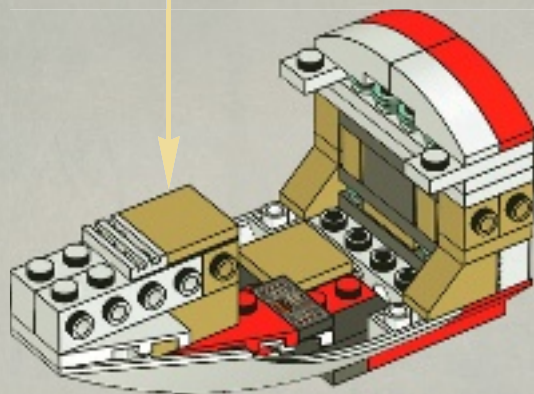
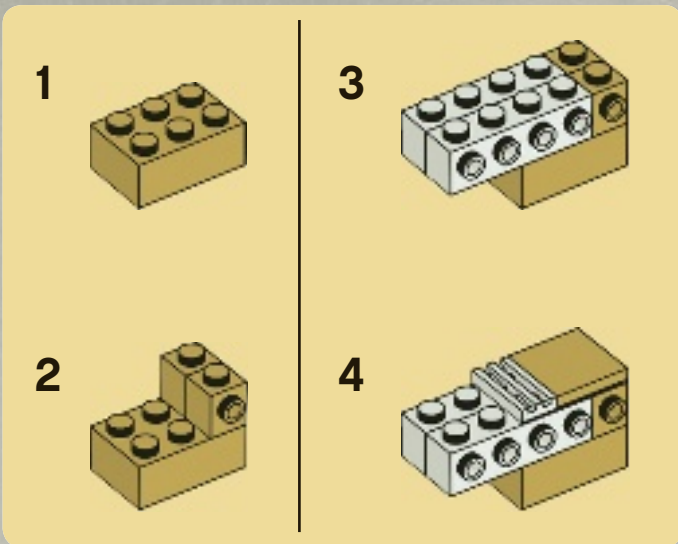

18

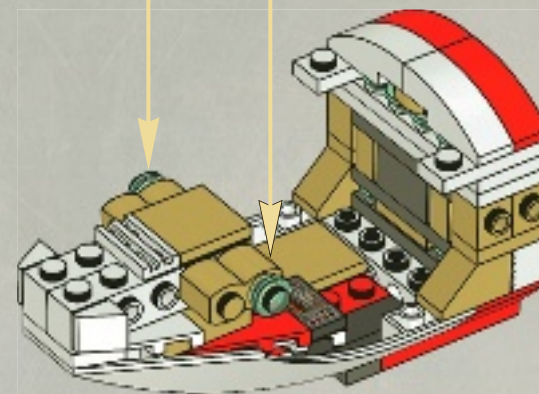
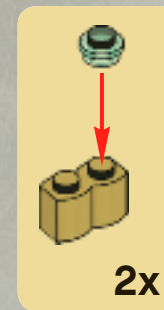

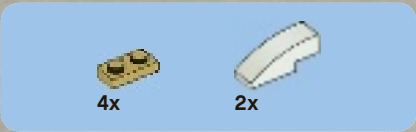

19

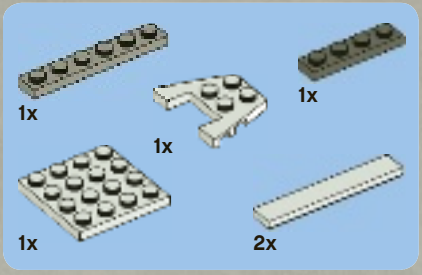
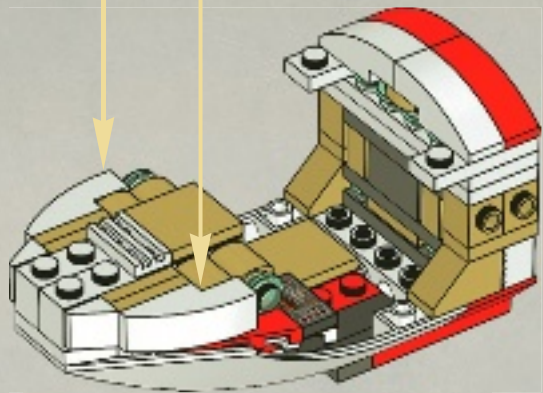
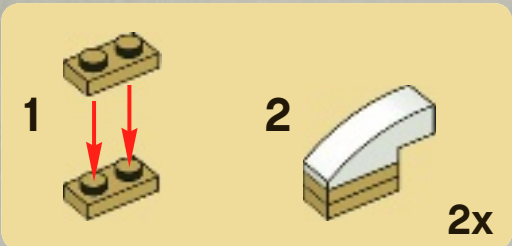

20

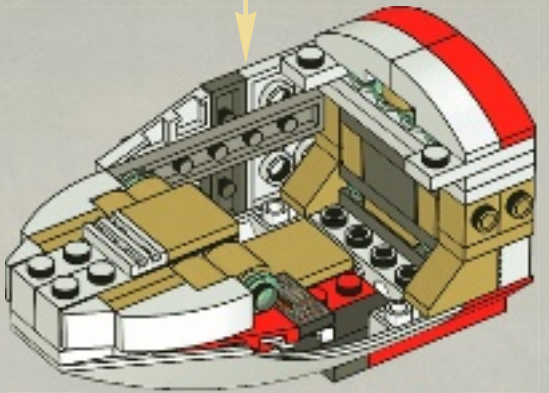
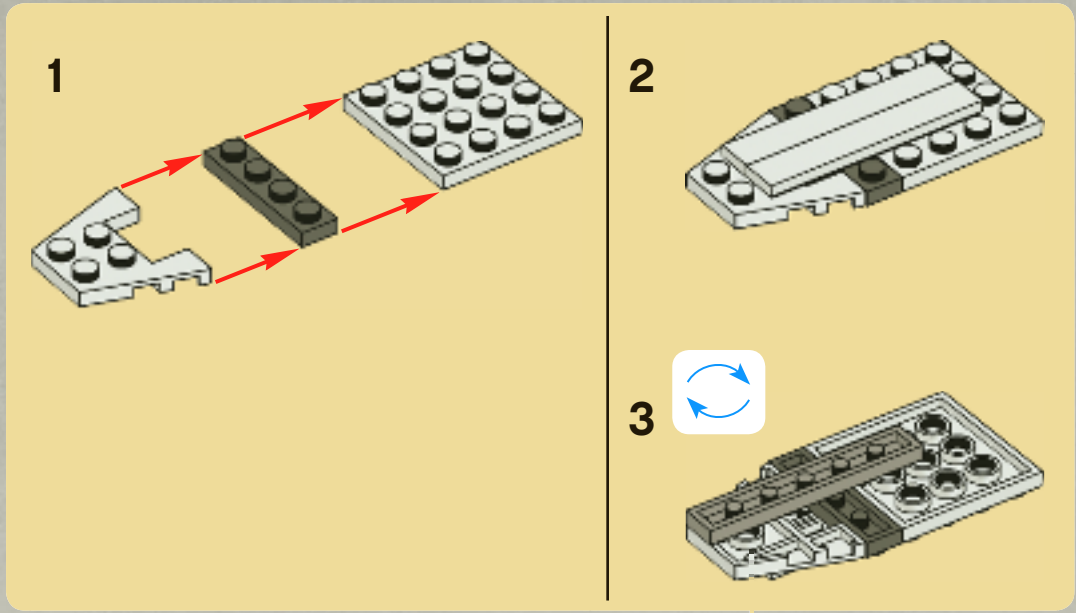

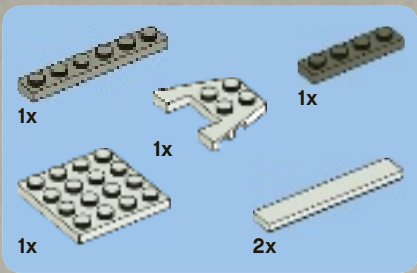

21

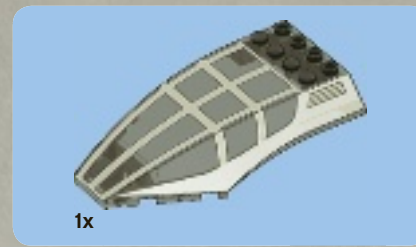
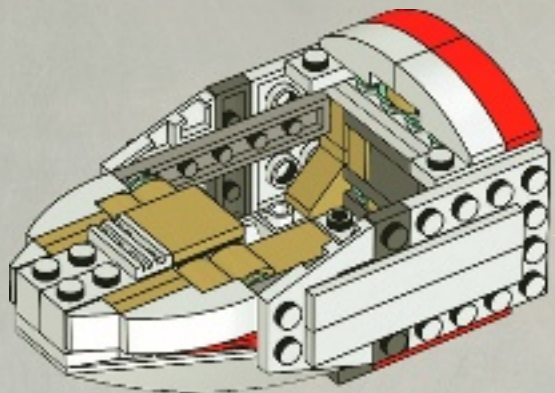
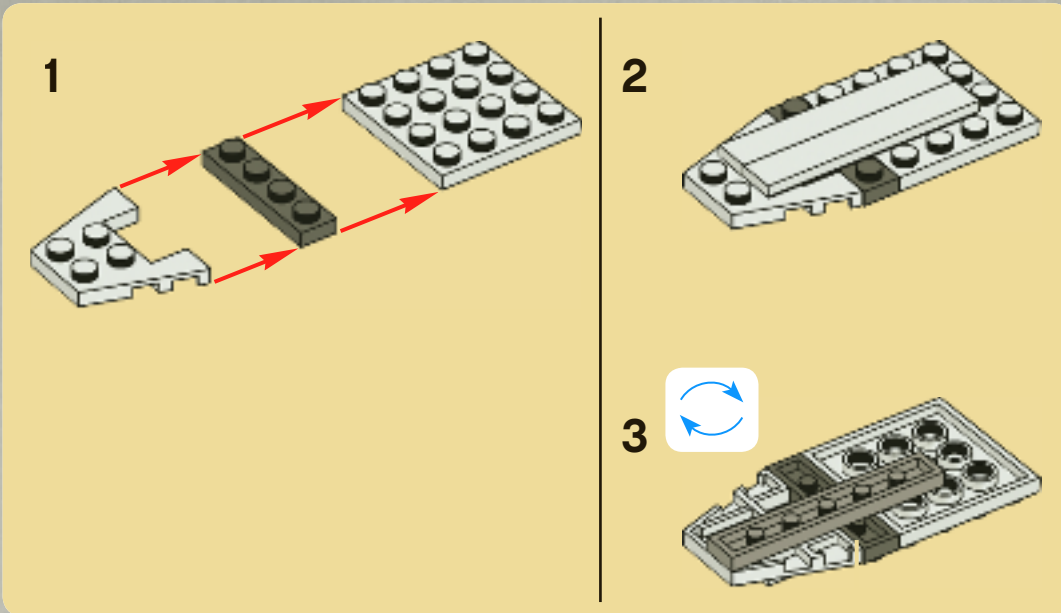

22

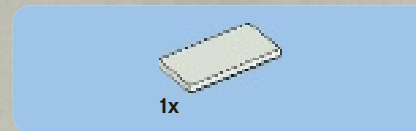
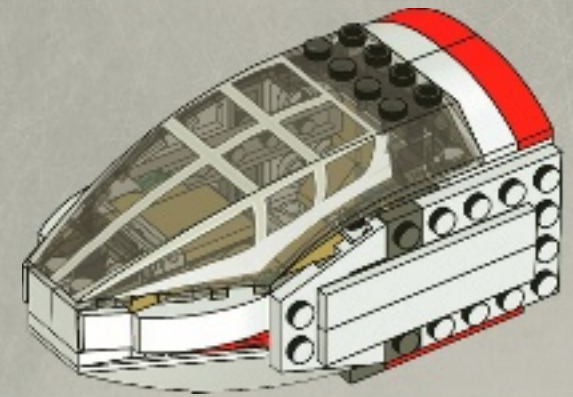

23

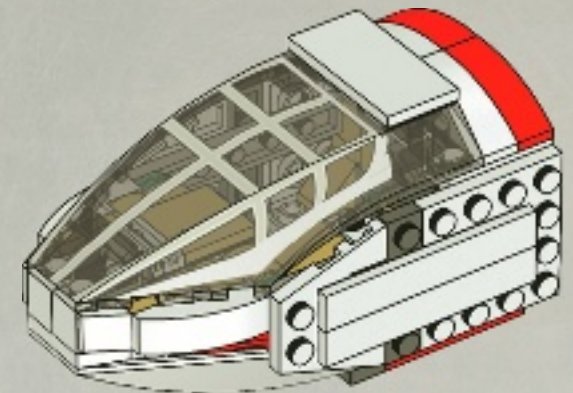

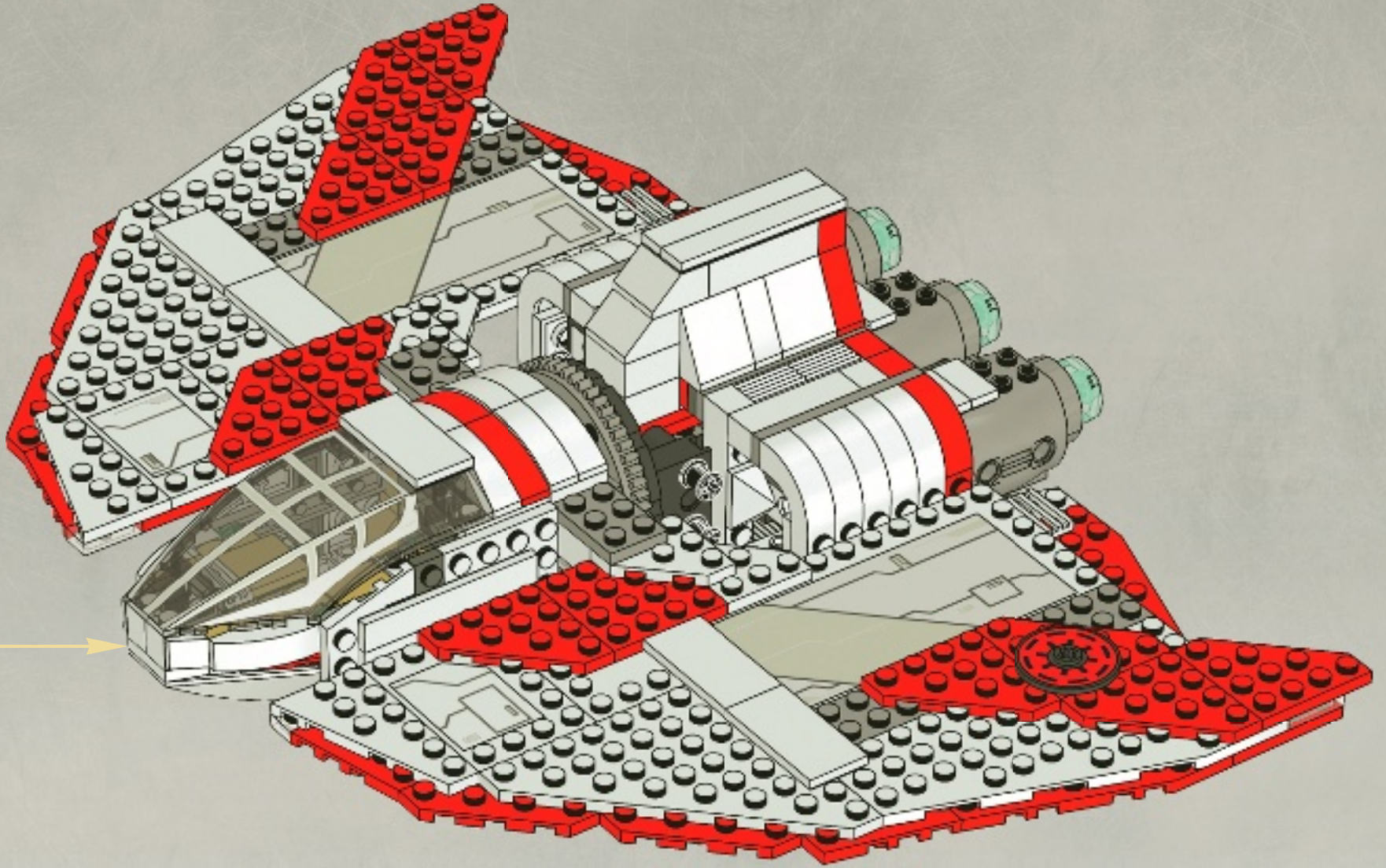

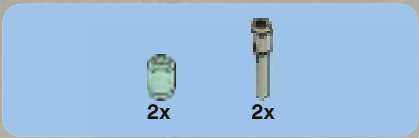

25

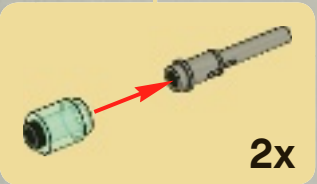
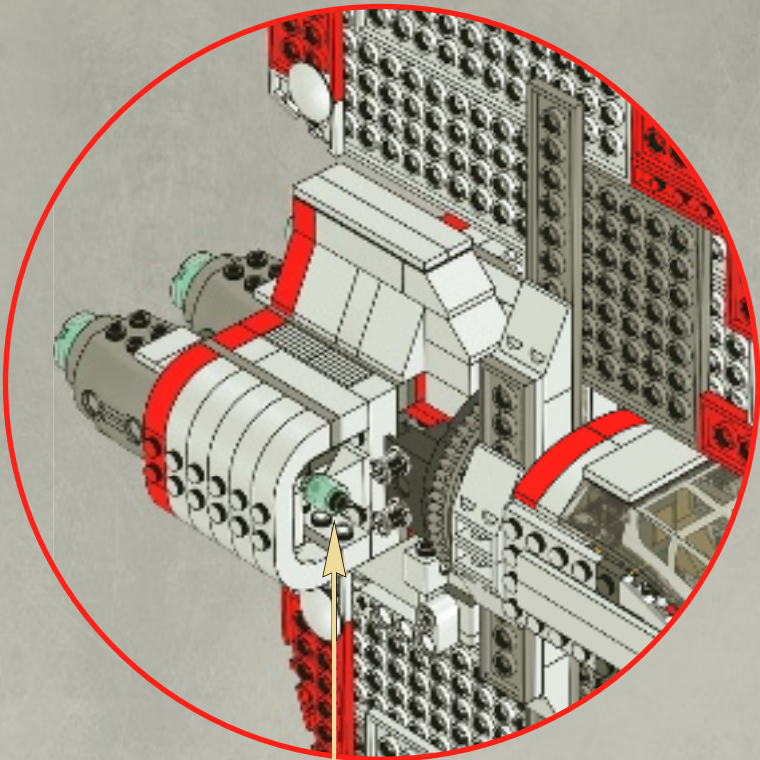
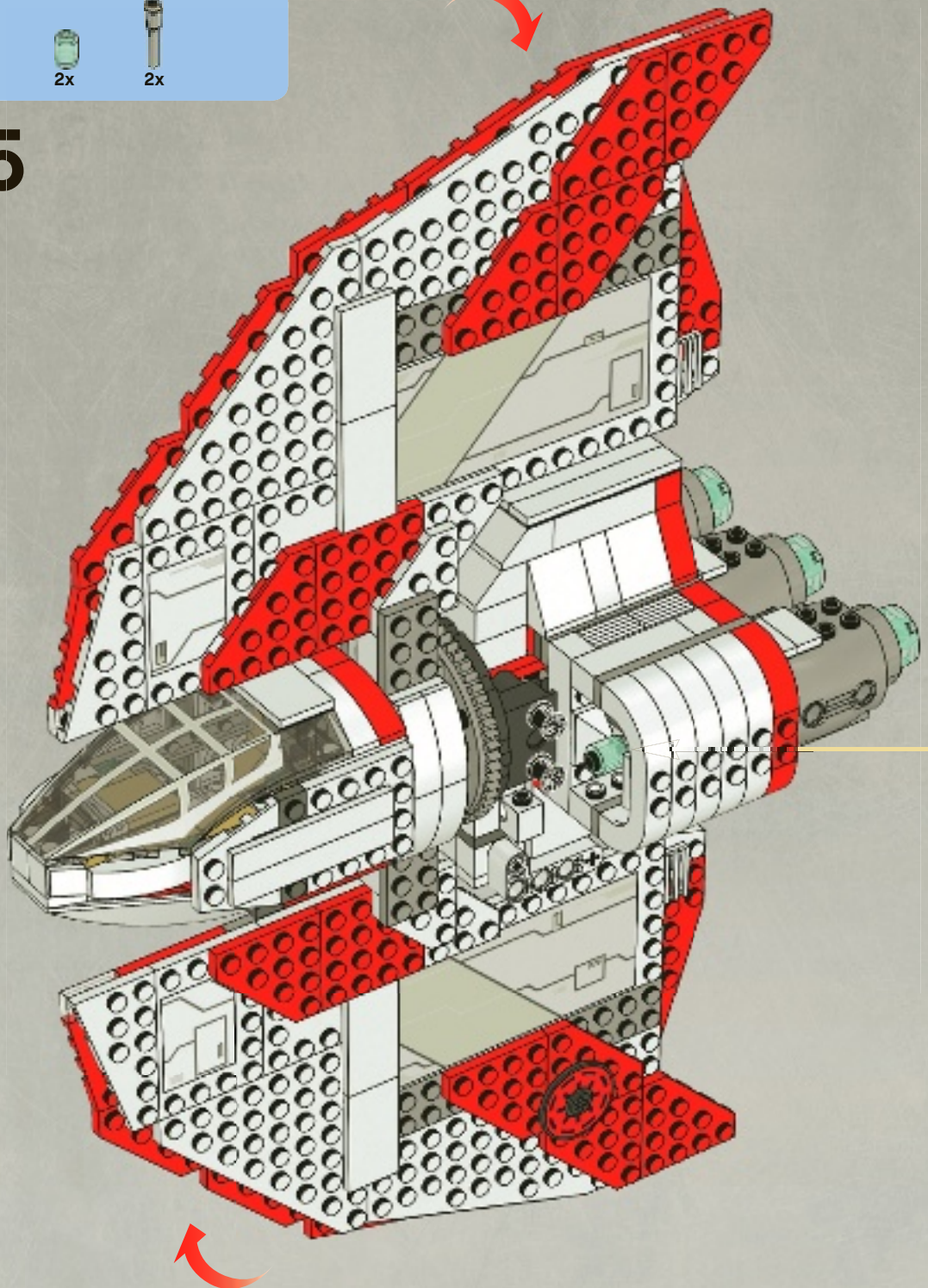

26

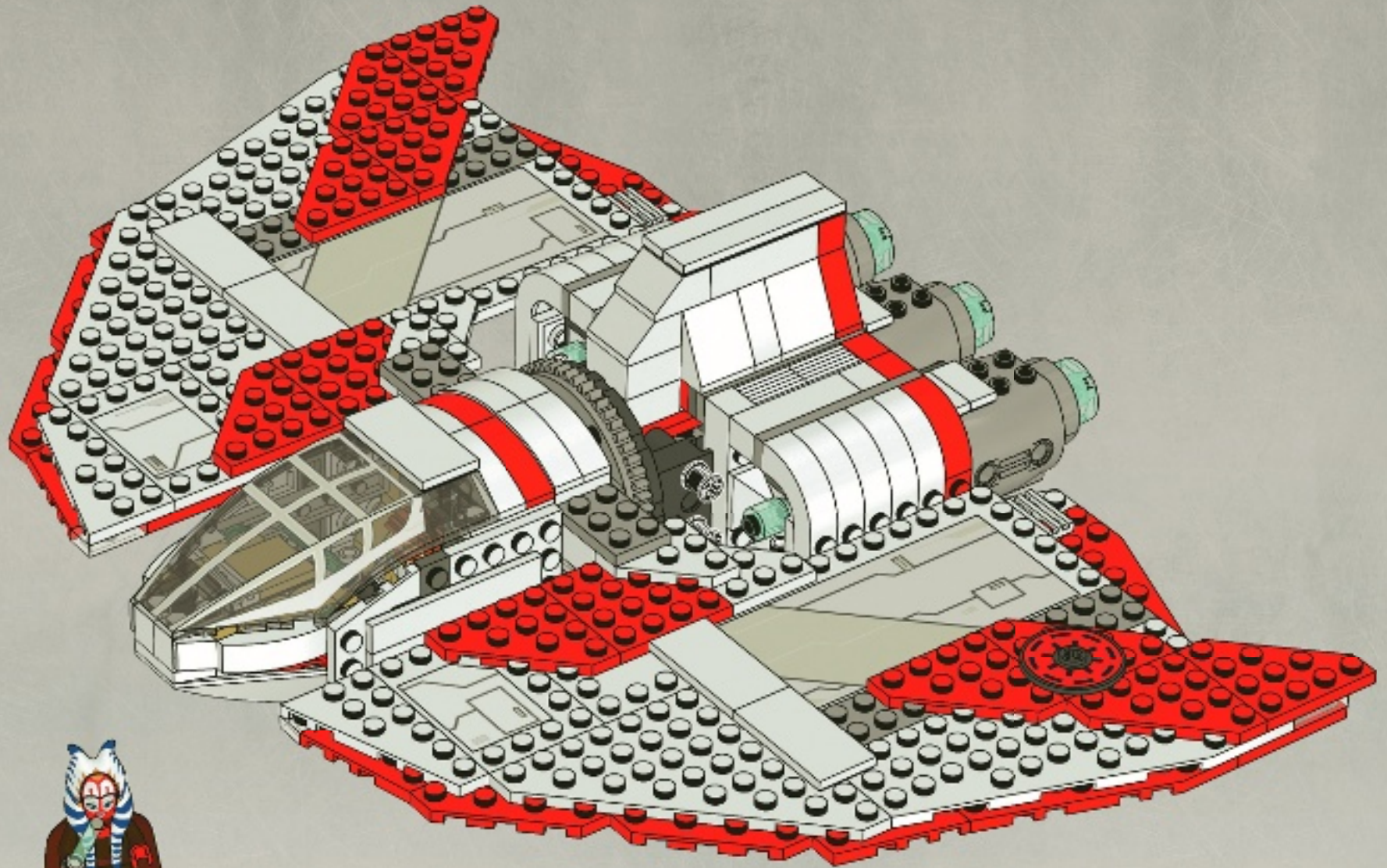

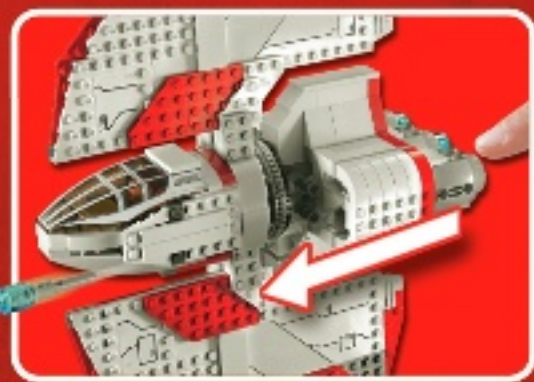



STAR WARS

TM





7913



7914



7915



7968



7969



7929



7930



7931



www.LEGOclub.com



LEGO® Club Email



LEGO® Club Magazine

LEGO club™

FREE! GRATIS! GRATUIT!

SIGN UP ONLINE!

www.LEGOclub.com

VISIT THE WORLD'S
BIGGEST LEGO® SHOP!
www.LEGOshop.com

GO TO
www.LEGOclub.com

00800 5346 5555*

1-866-534-6258 • 1-877-518-5346

US & Canada only

Canada seulement



- * Freephone. Mobile charges may apply.
- * Numéro sans frais. Des frais peuvent s'appliquer avec les téléphones cellulaires.
- * Gebührenfrei, Kosten für Anrufe aus Mobilfunknetzen können abweichen.
- * Gratis telefoonnummer vanaf vaste lijn.
- * Det er et gratis nummer, når du ringer fra fasttelefon.
- * Det är gratis, när du ringer från en fast telefon.
- * Numéro sans frais. Des frais peuvent s'appliquer avec les téléphones portables.



WIN!

Go to www.LEGOsurvey.com/product to fill out a survey for a chance to win a cool LEGO® Product. No purchase necessary. Open to all residents where not prohibited.

 www.LEGO.com



www.LEGOsurvey.com/product

GEWINNE!

Nimm an der Umfrage auf www.LEGOsurvey.com/product LEGO teil und hab die Chance ein cooles LEGO® Produkt zu gewinnen!

Die Teilnahme am Gewinnspiel führt zu keinerlei Kaufverpflichtungen. Teilnahme in allen nicht ausgeschlossenen Ländern möglich.

WIN!

Ga naar www.LEGOsurvey.com/product, vul een enquêteformulier in en maak kans op een cool LEGO® product.

Geen aankoopverplichting. Iedereen mag deelnemen, uitgezonderd ingezetenden van landen waar een enquêteverbod geldt.

GAGNE!

Visite www.LEGOsurvey.com/product pour répondre à un questionnaire et avoir une chance de gagner un produit LEGO® très cool!

Aucune obligation d'achat. Ouvert à tous les résidents des pays autorisés.

当てよう!

www.LEGOsurvey.com/product にアクセスして、アンケートにご記入ください。当選者にはレゴ®製品を差し上げます。

お買い上げの必要はありません。禁止されていない限り、すべての皆様にご利用いただけます。