

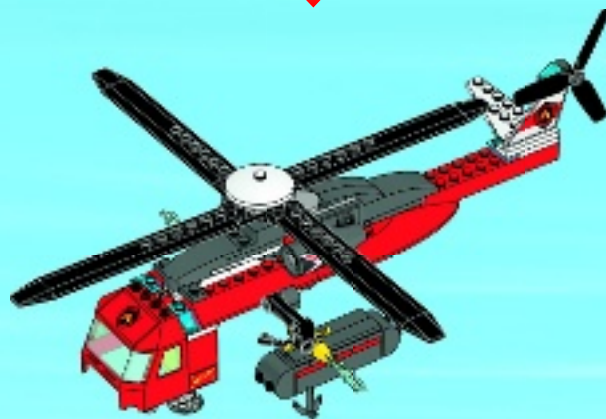

60010

CITY

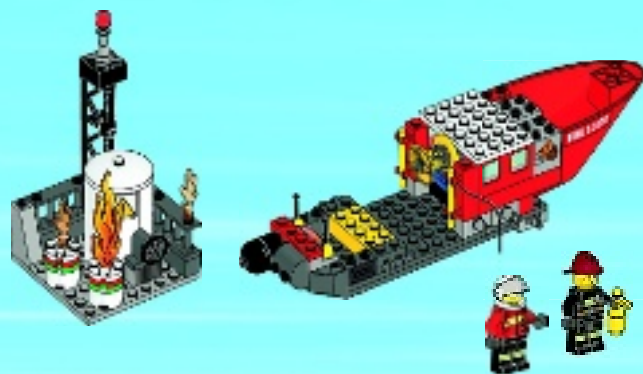



1



2



3



4



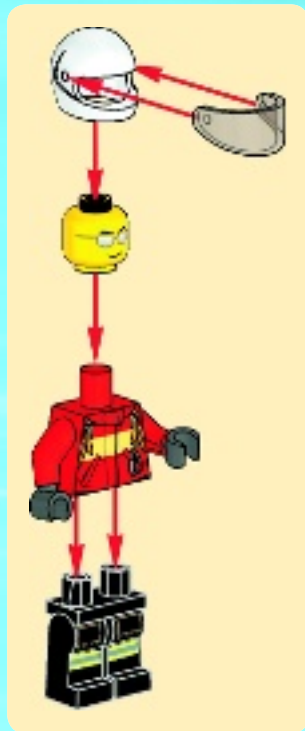

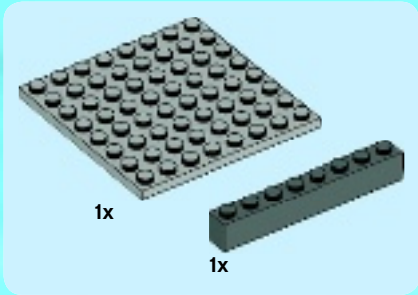

1

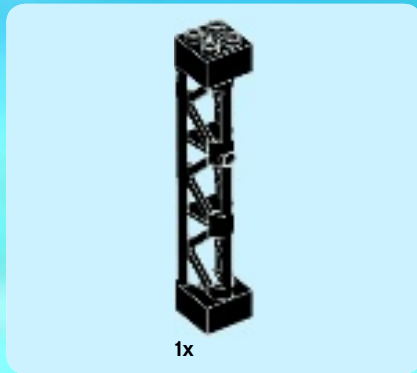
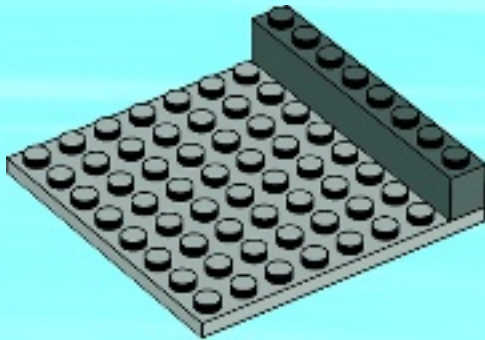

2

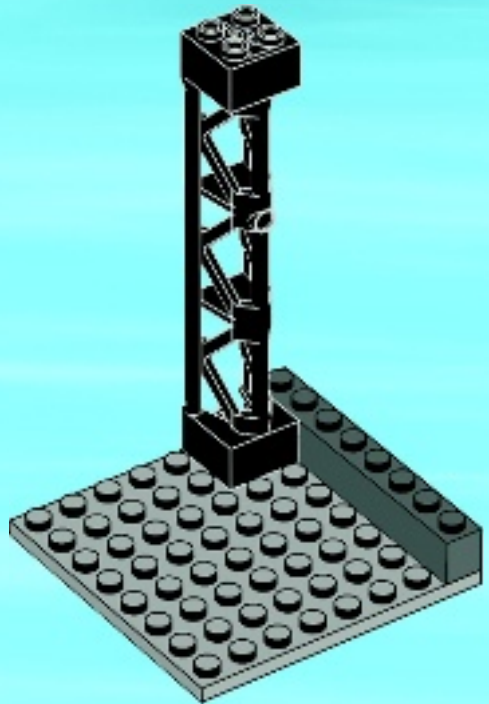



1x



1x

3

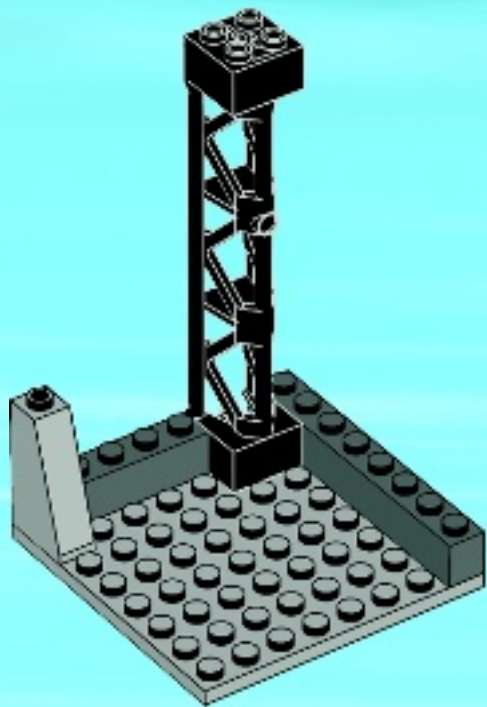

3x

4

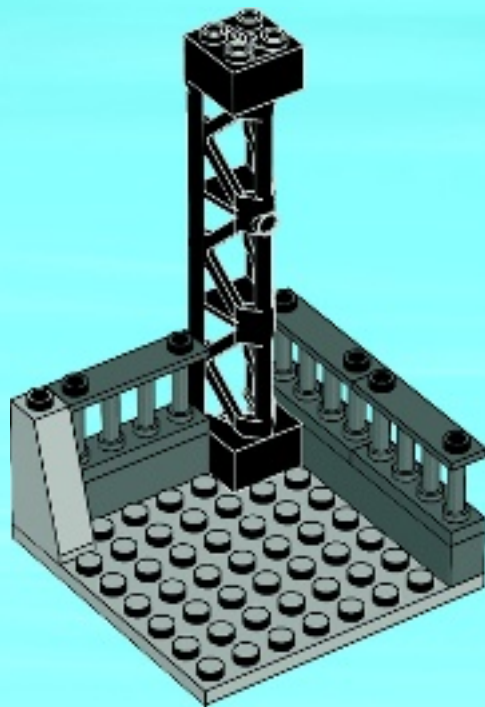



1x



1x

5

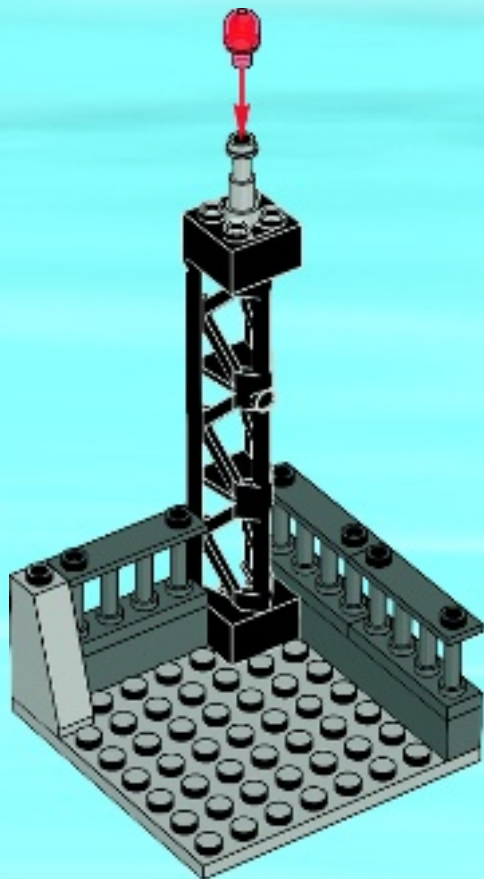

1x

6

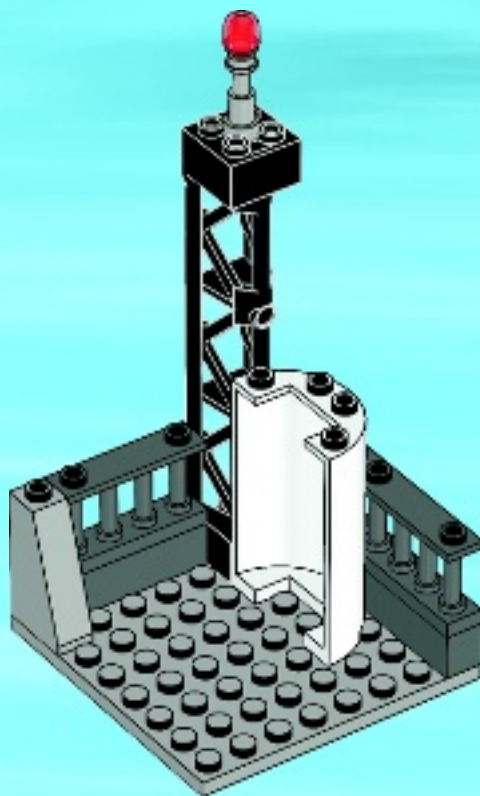



1x

7

1



2

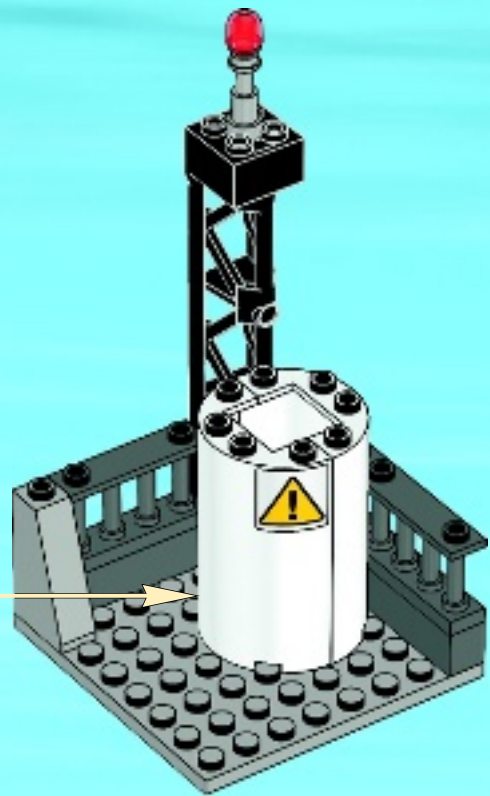

8



1x

8

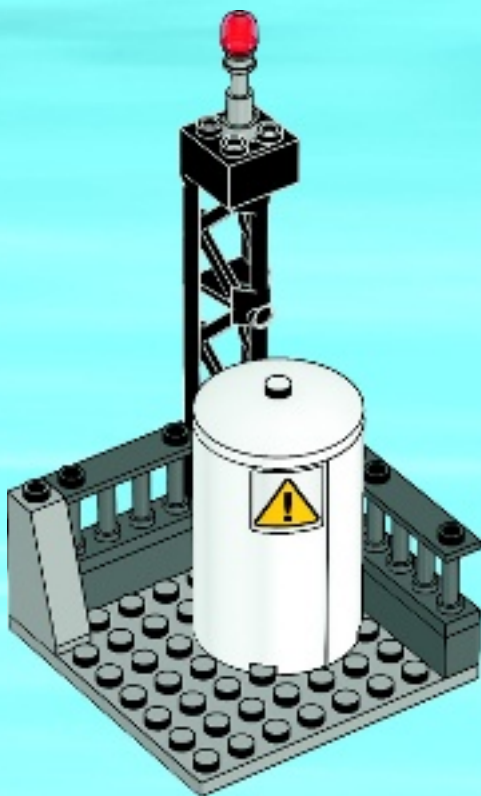

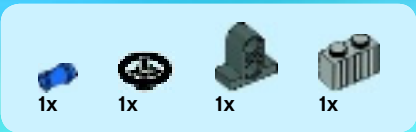

9

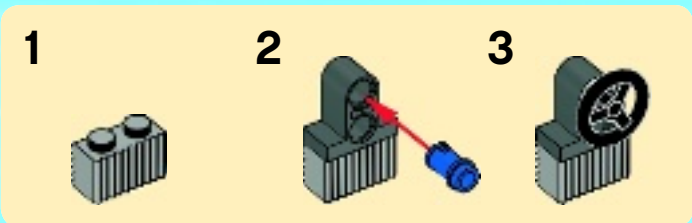



2x



2x



2x



2x

10

1



2



3



2x

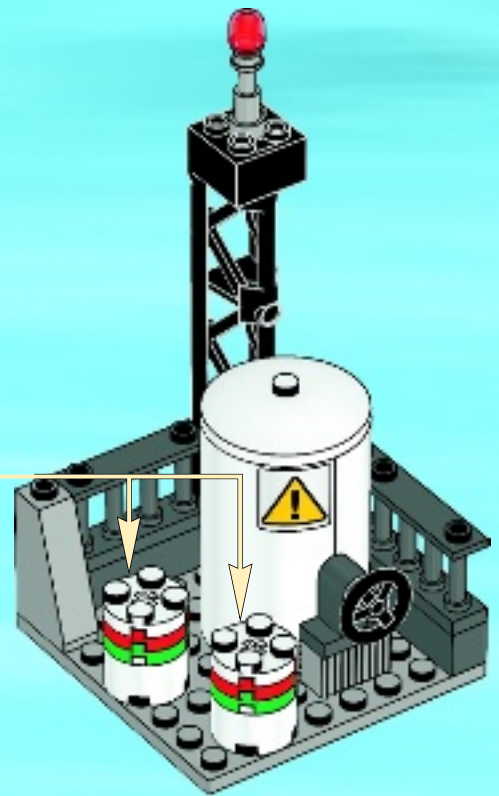

2x



1x



11



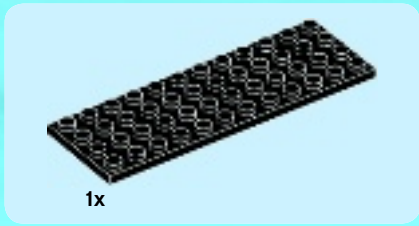

1x

1

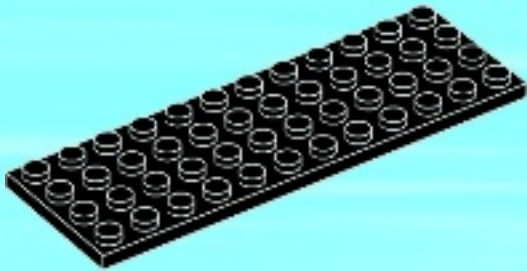

2x

2

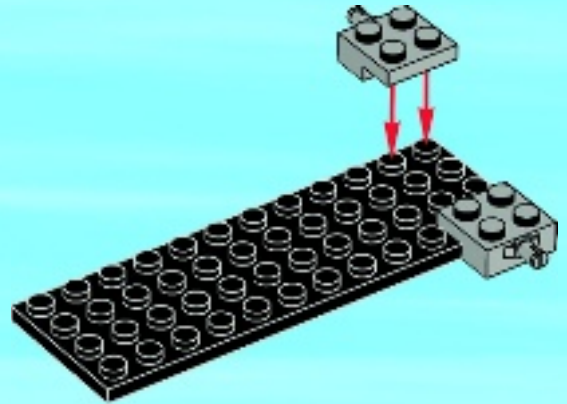



1x

3

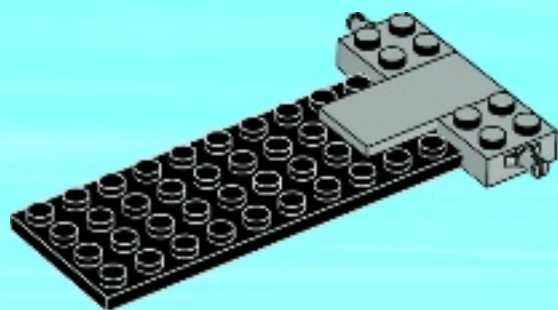

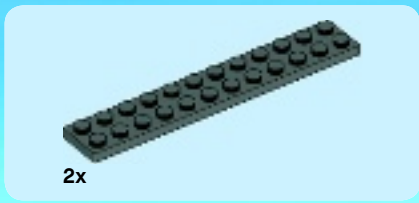

4

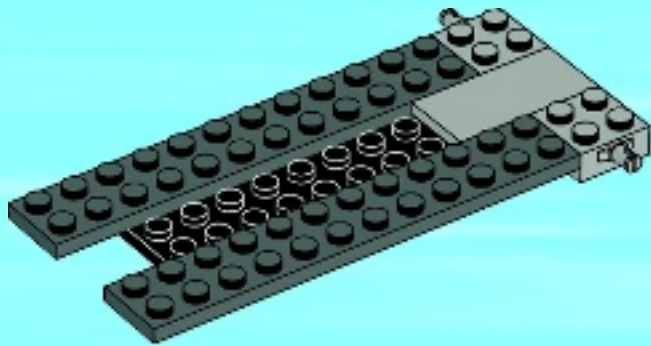

5

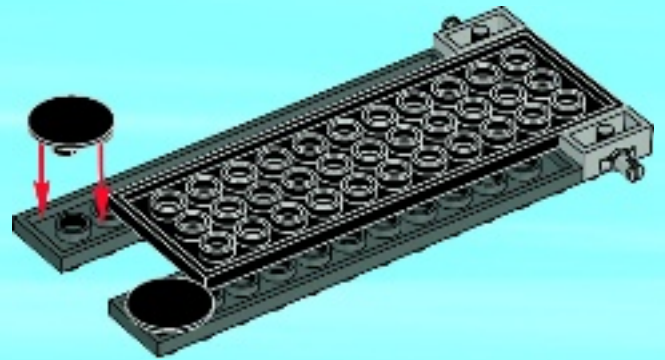



1x

6

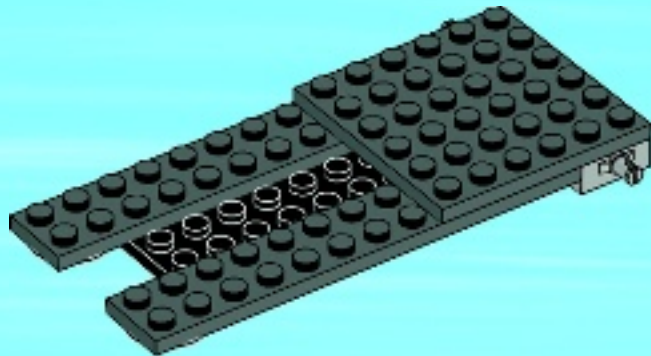



4x

7

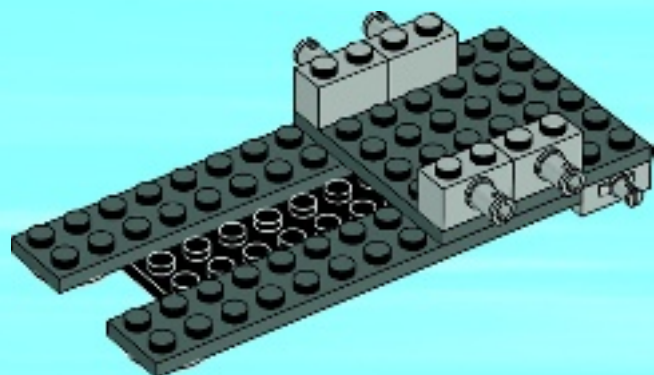

2x



1x

8

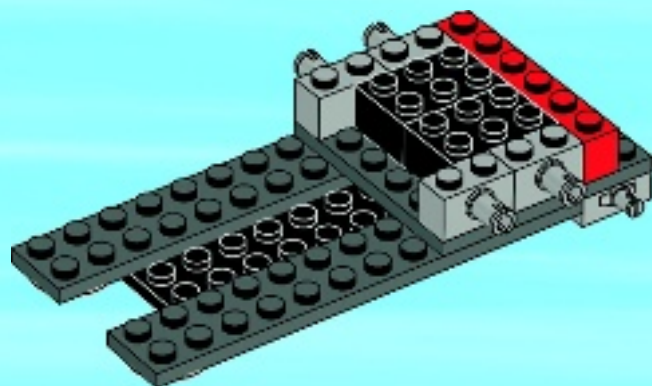

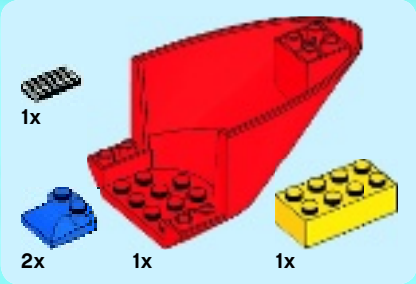

9

1

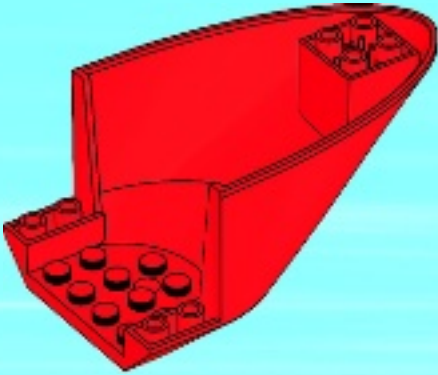

2



2x

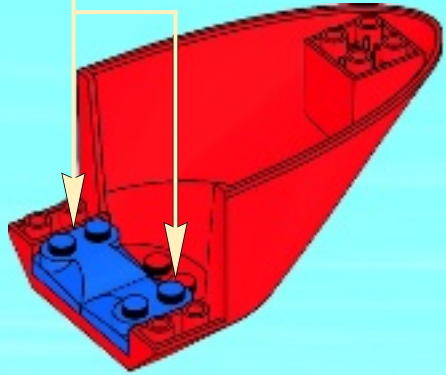

3

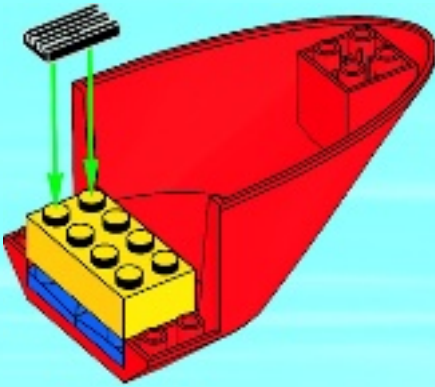

4



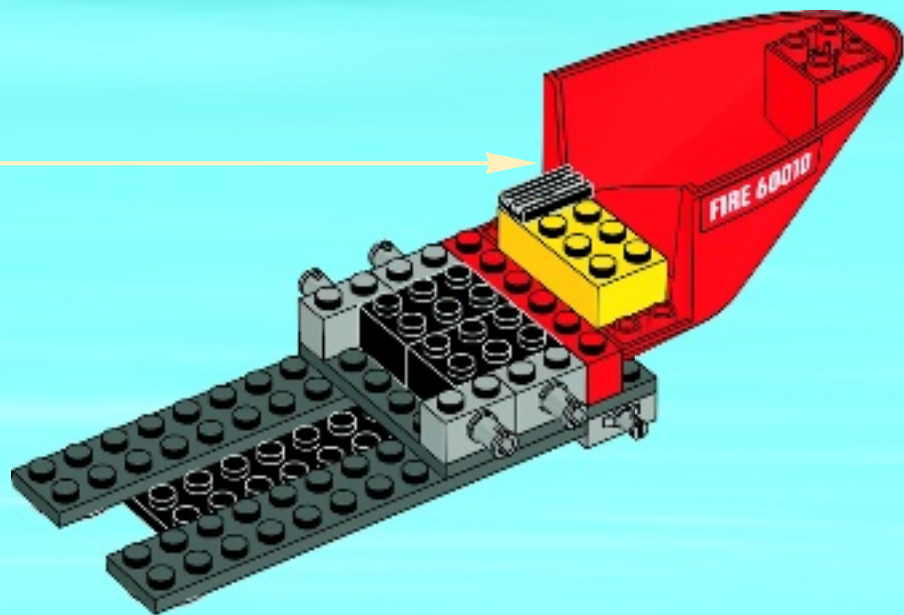



2x

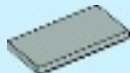

1x

10

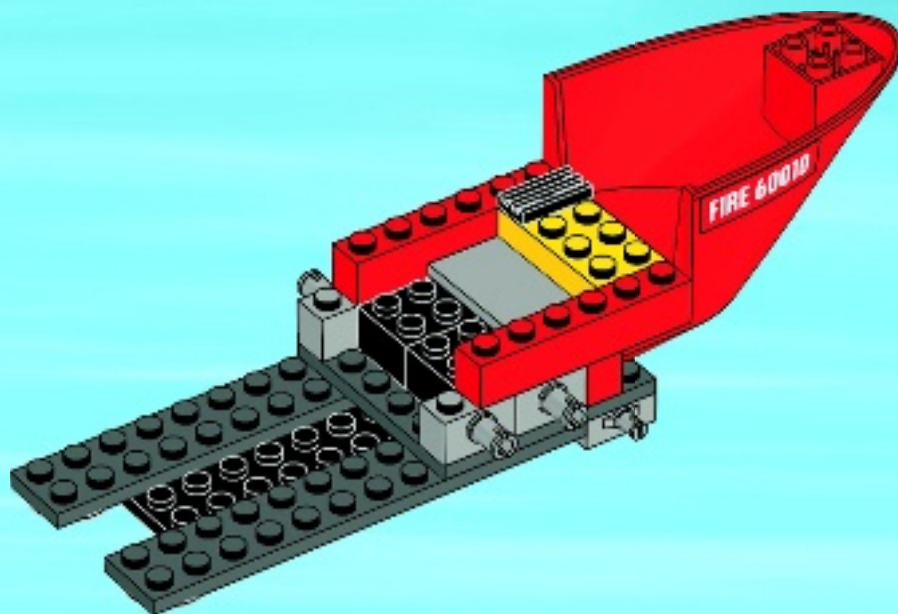



2x

11



2x

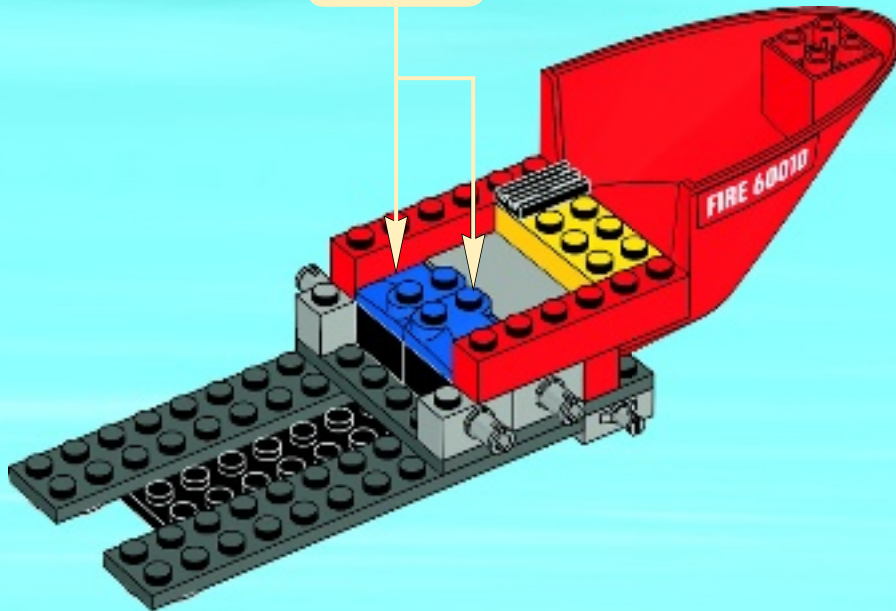



1x



1x

12

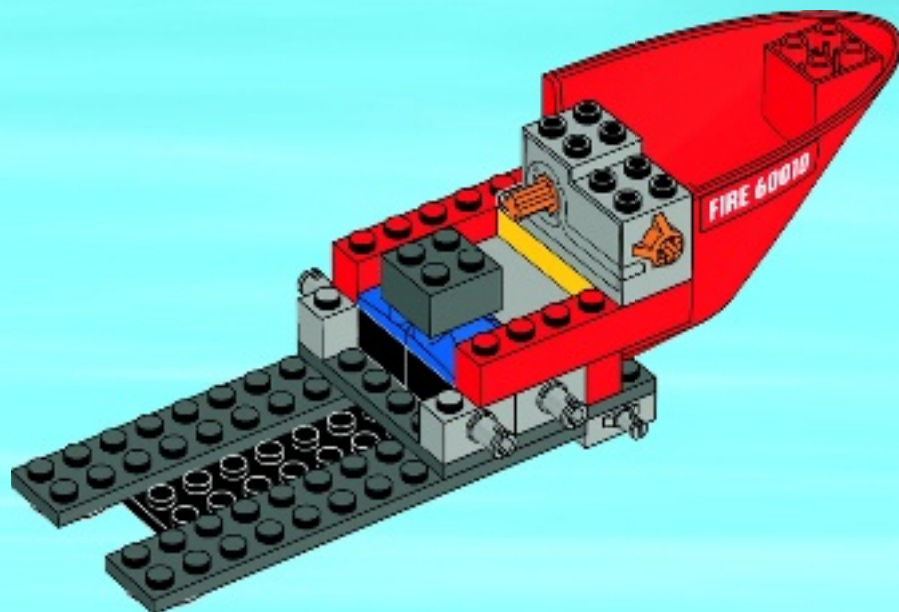



1x

13

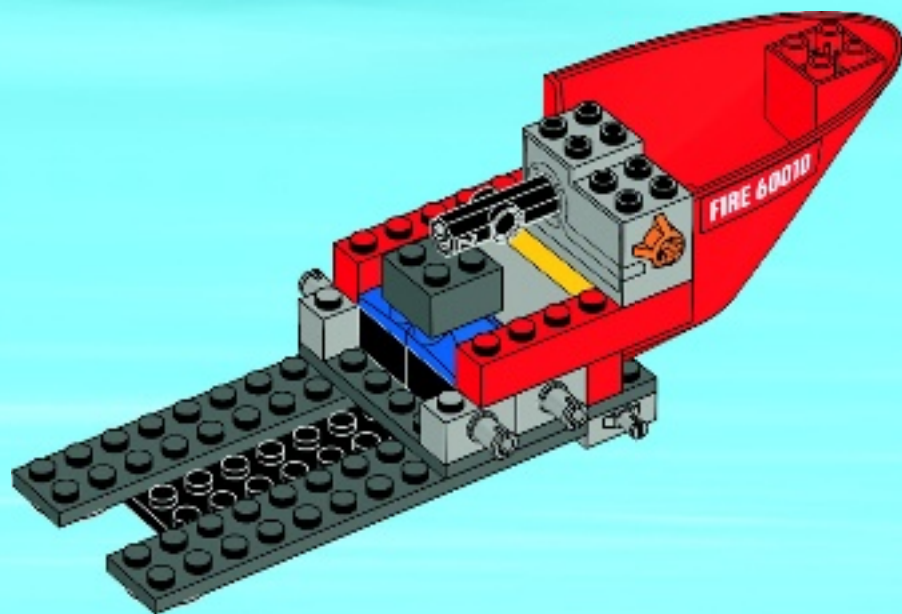



1x



1x

14

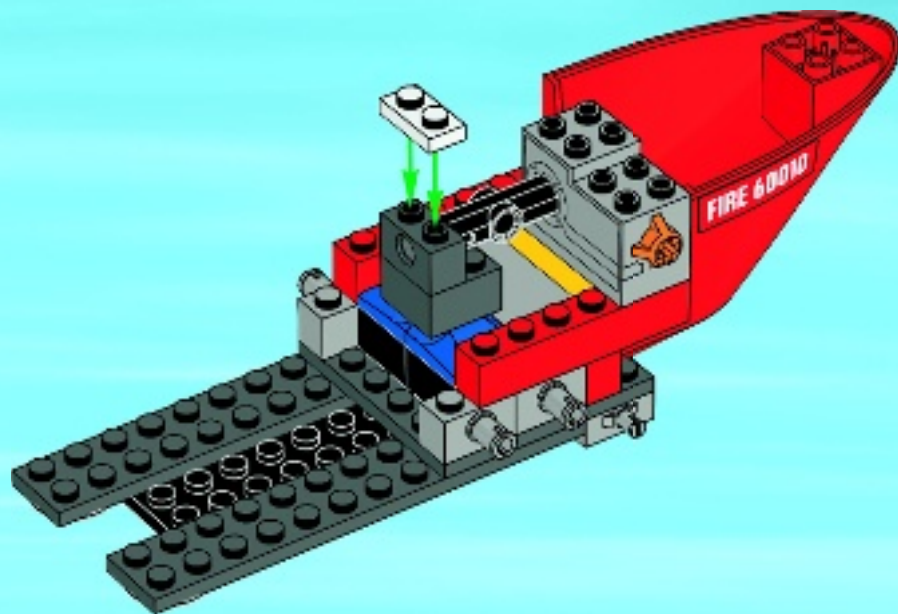



15

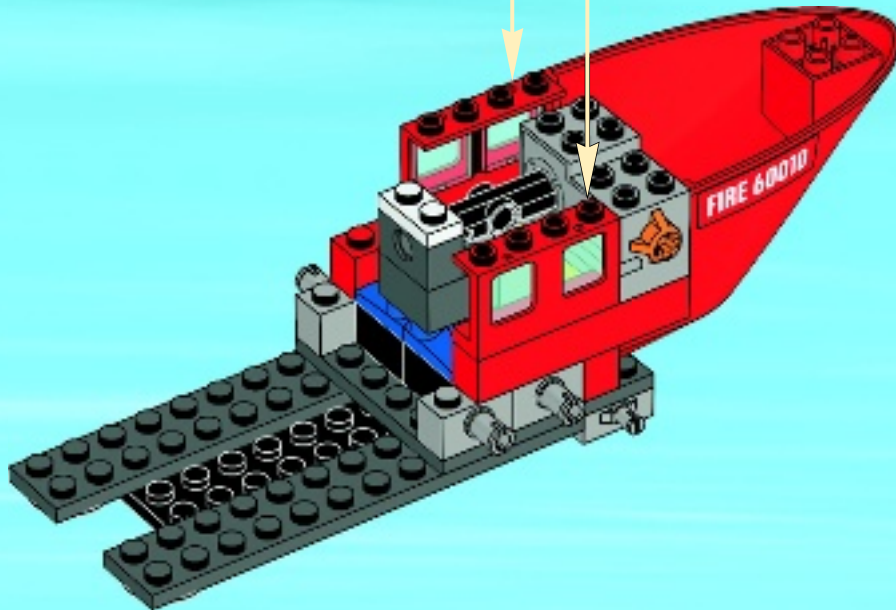
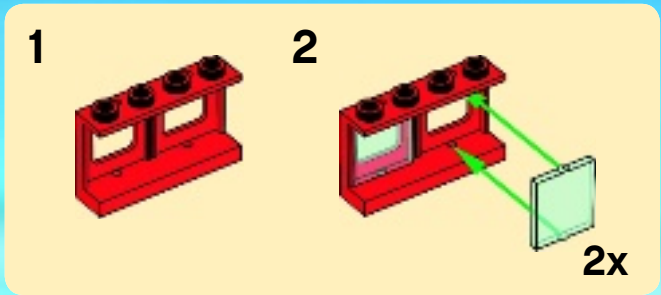



1x



1x

16

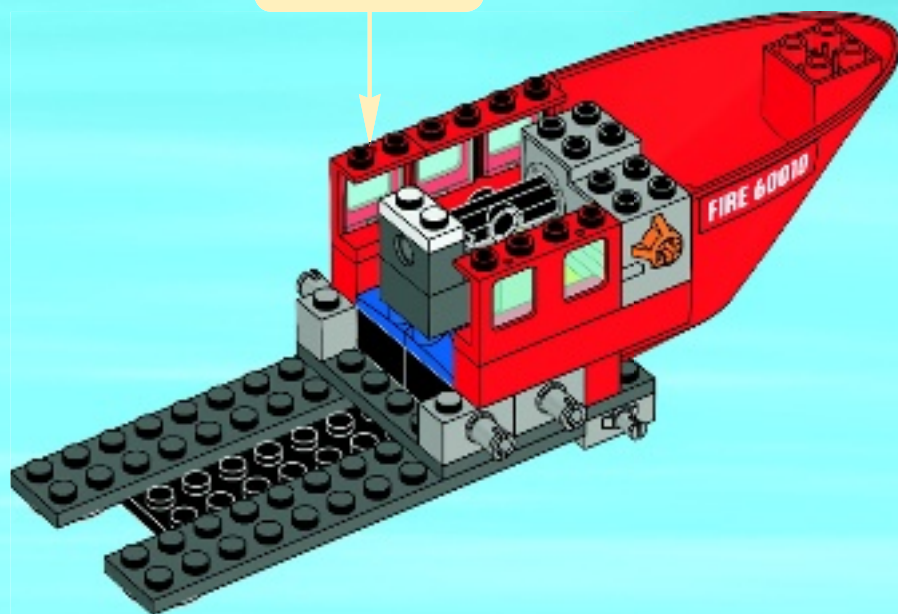
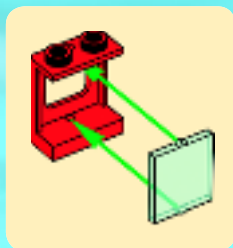



1x

17

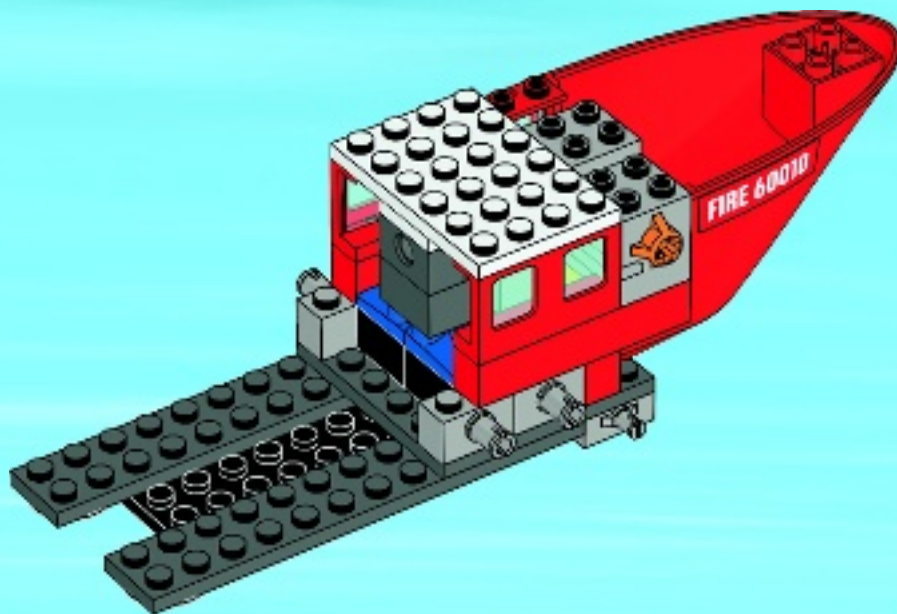

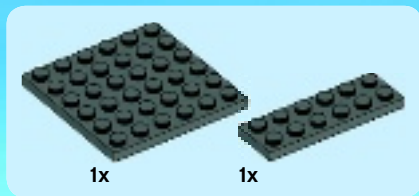

18

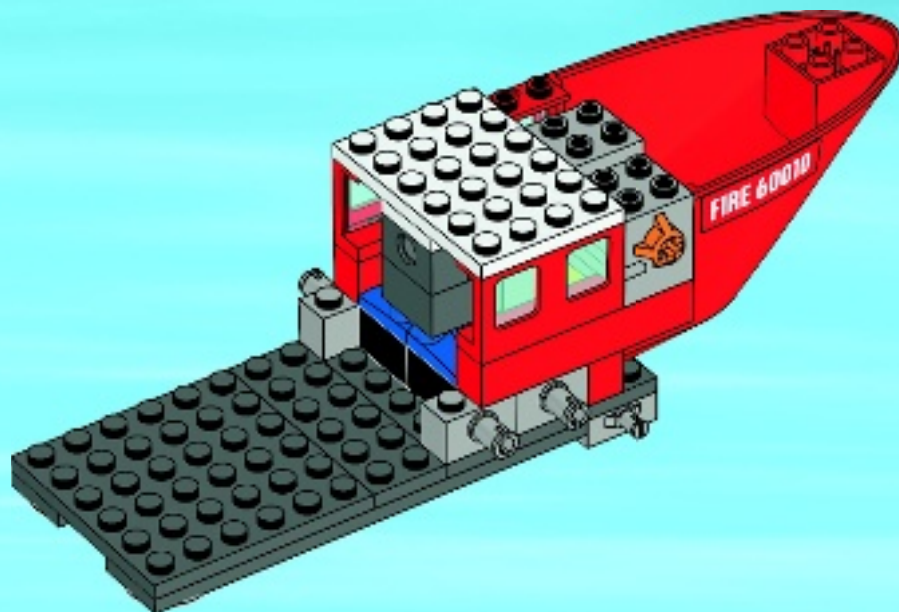



2x

19

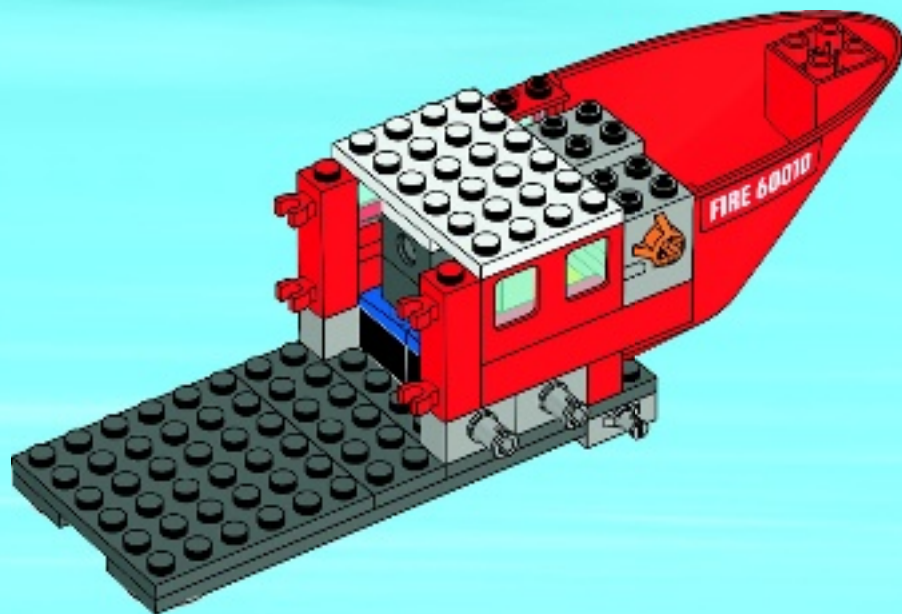

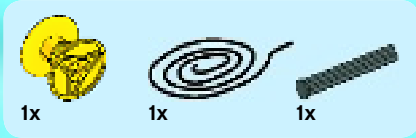
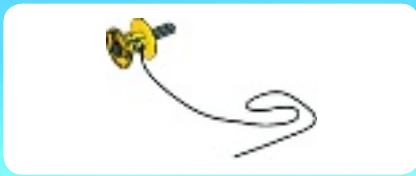

20

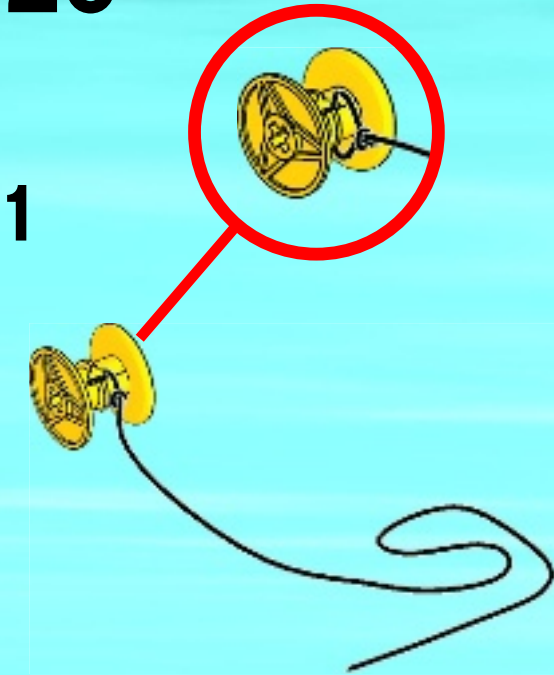

2

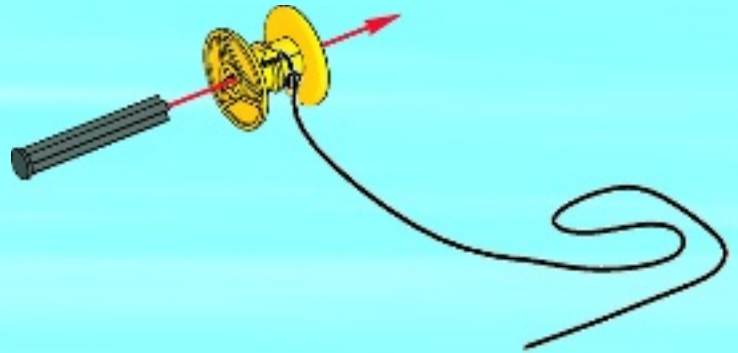

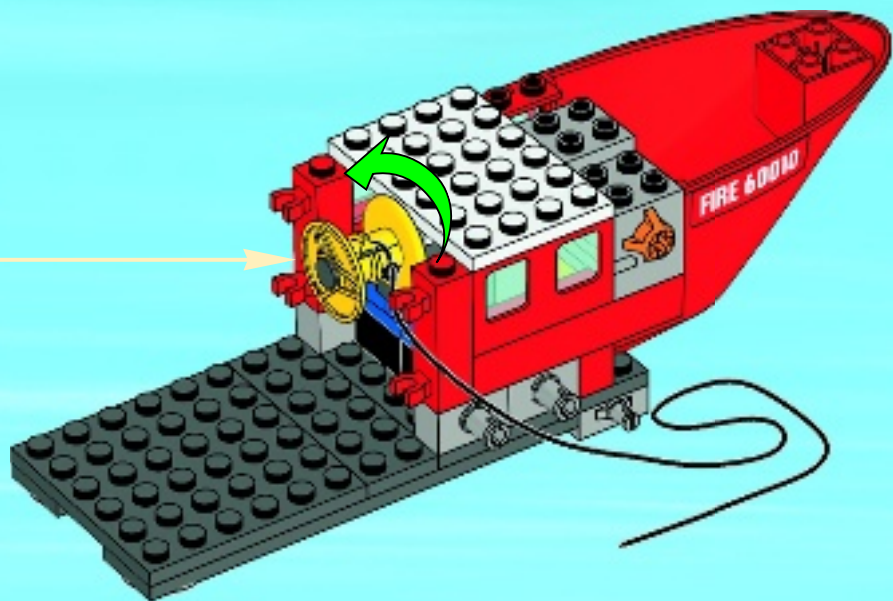

21

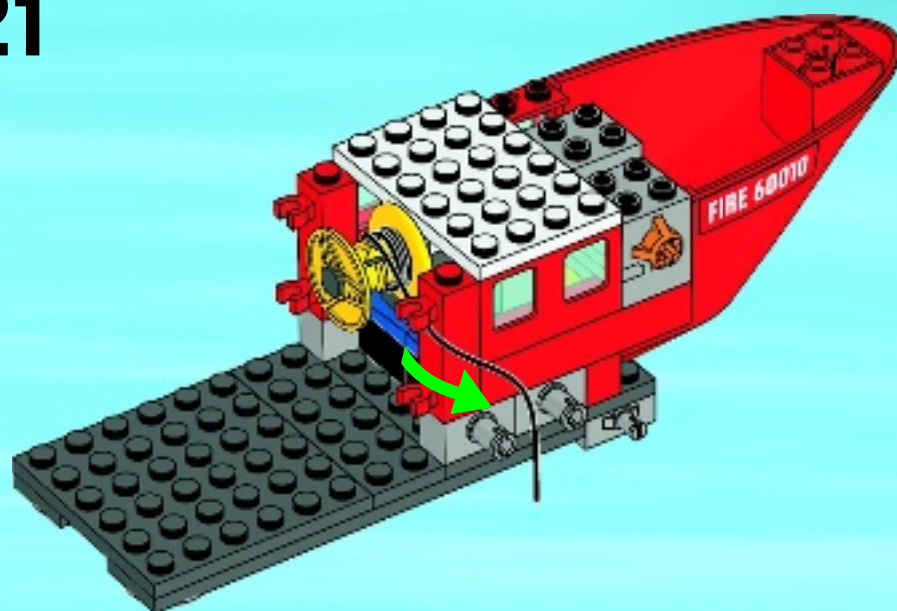



2x

22

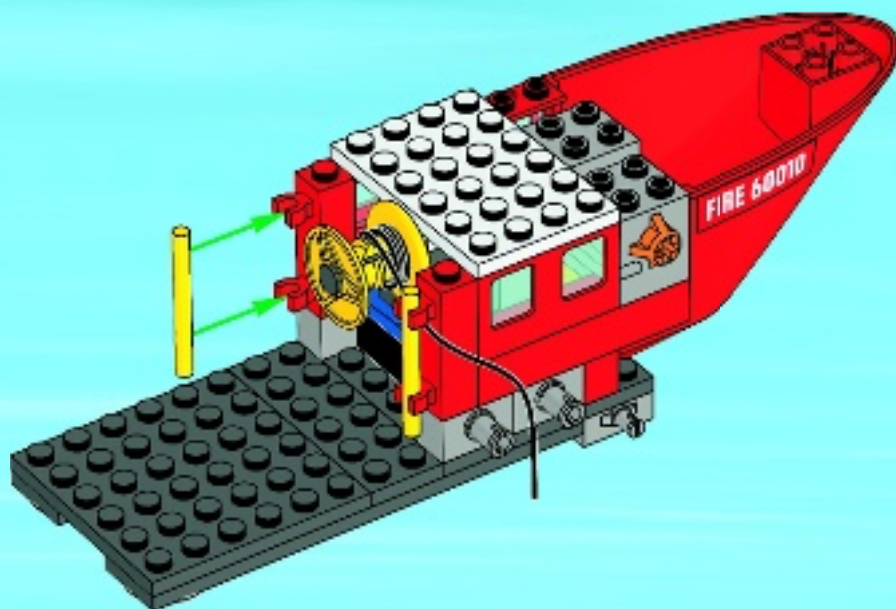

1x

23

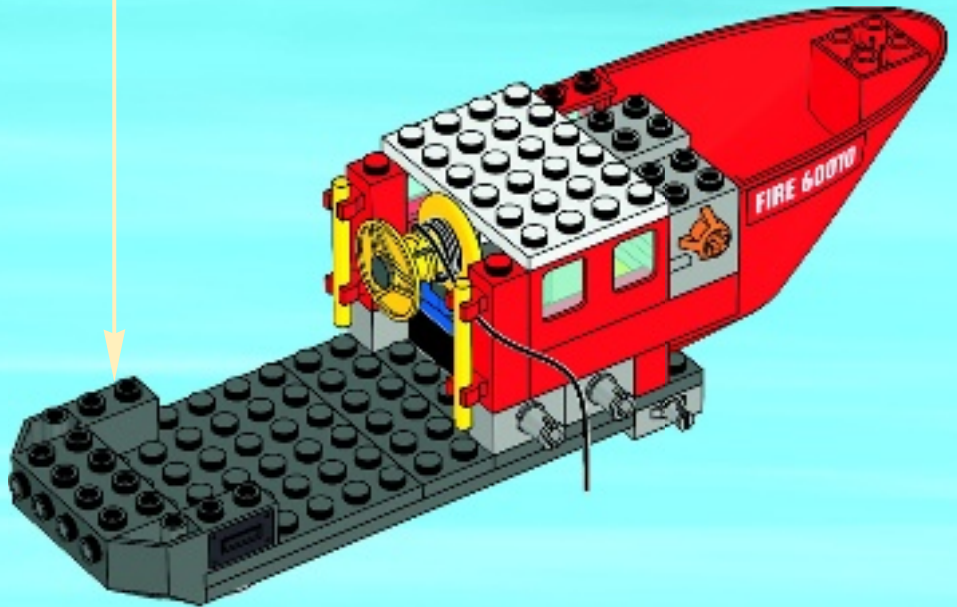
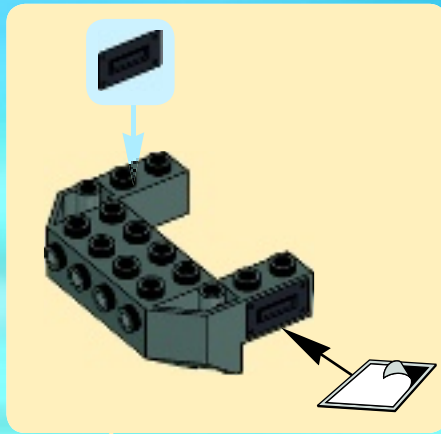

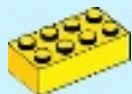

1x



2x

24

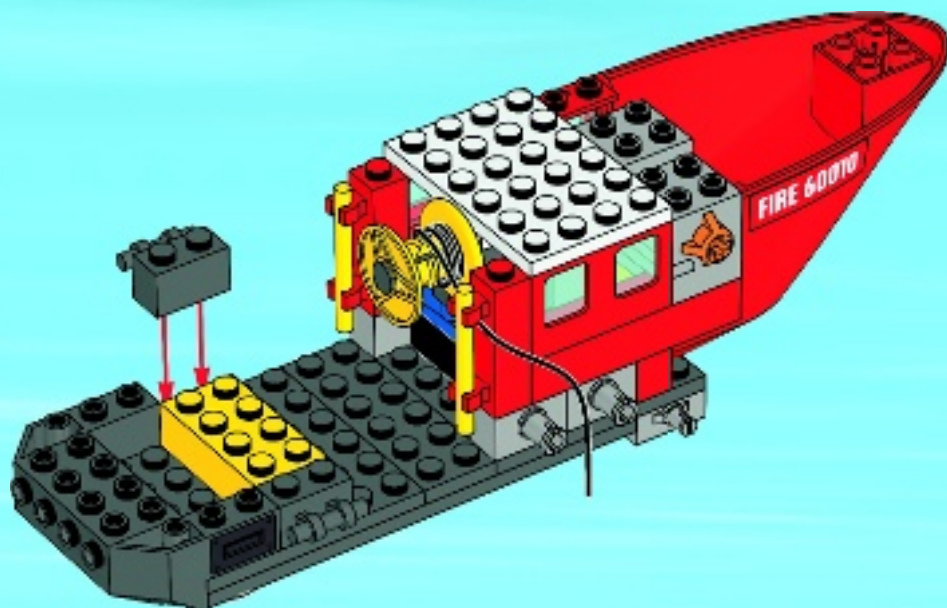



2x

25

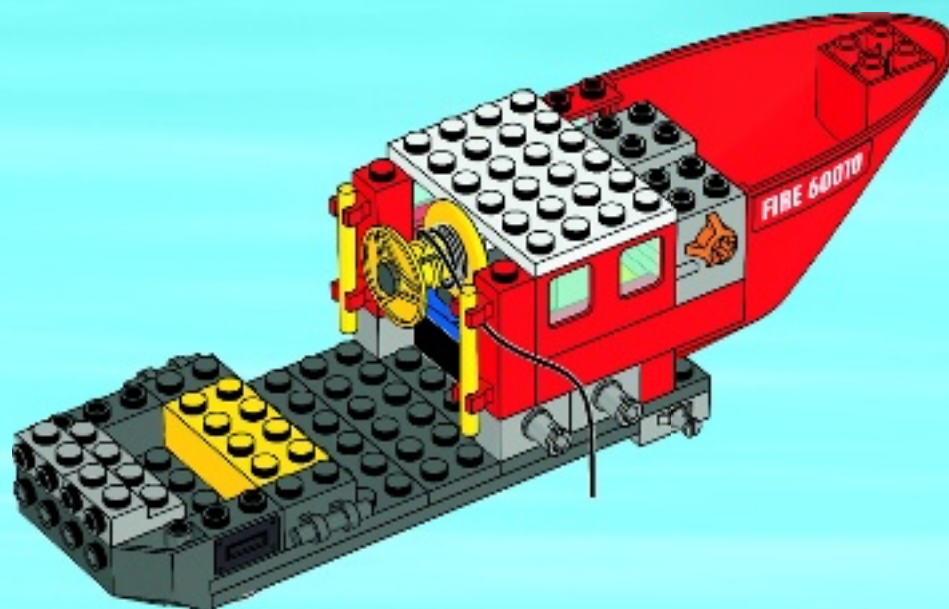



1x



1x

26

1



2

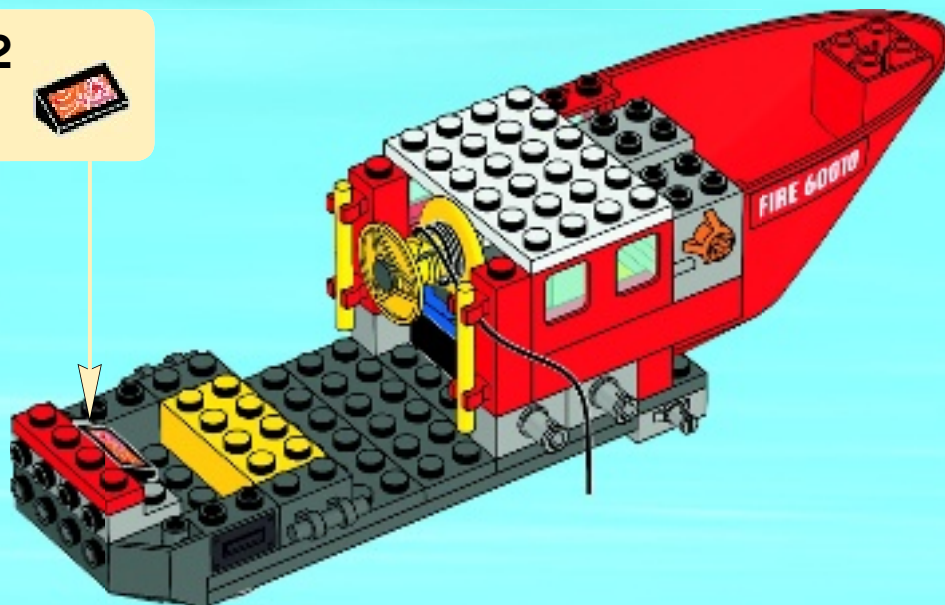



1x



1x



1x

27

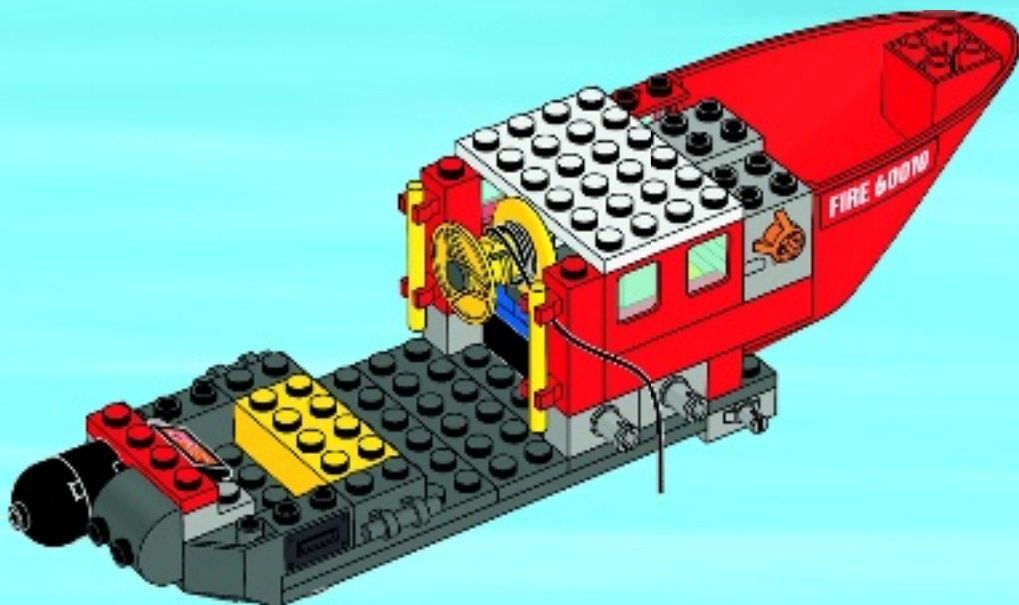
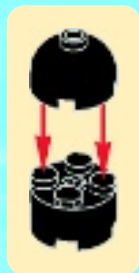



2x

28

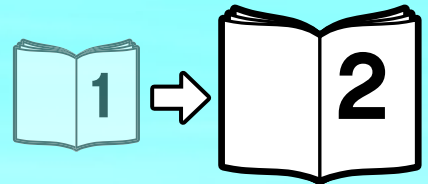
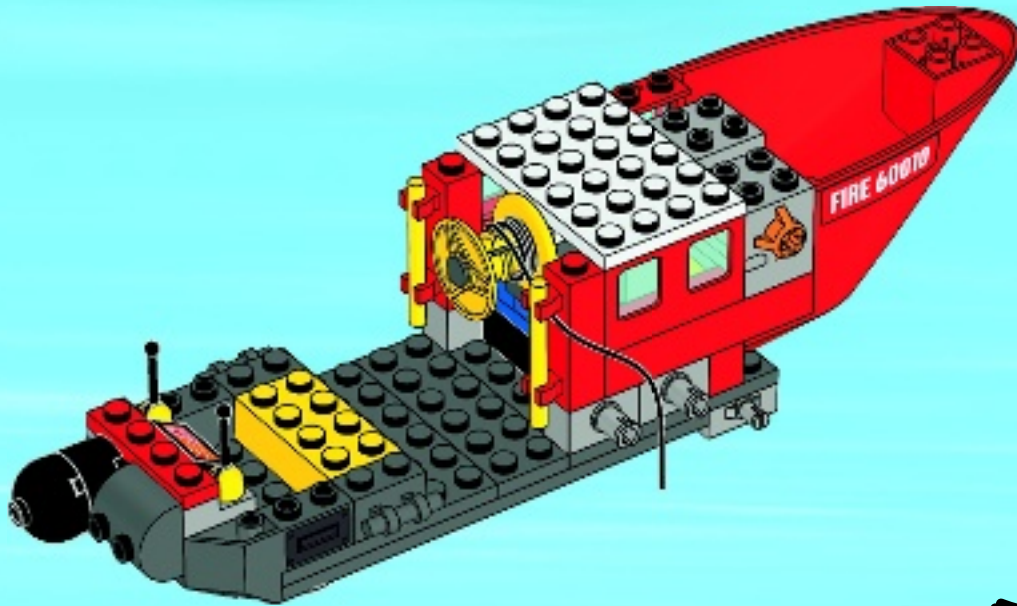



CITY

60010



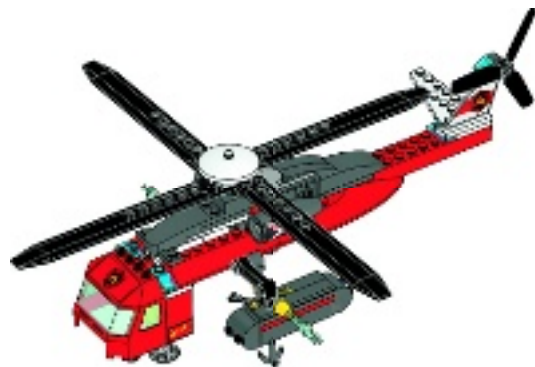

2x

29

1



2

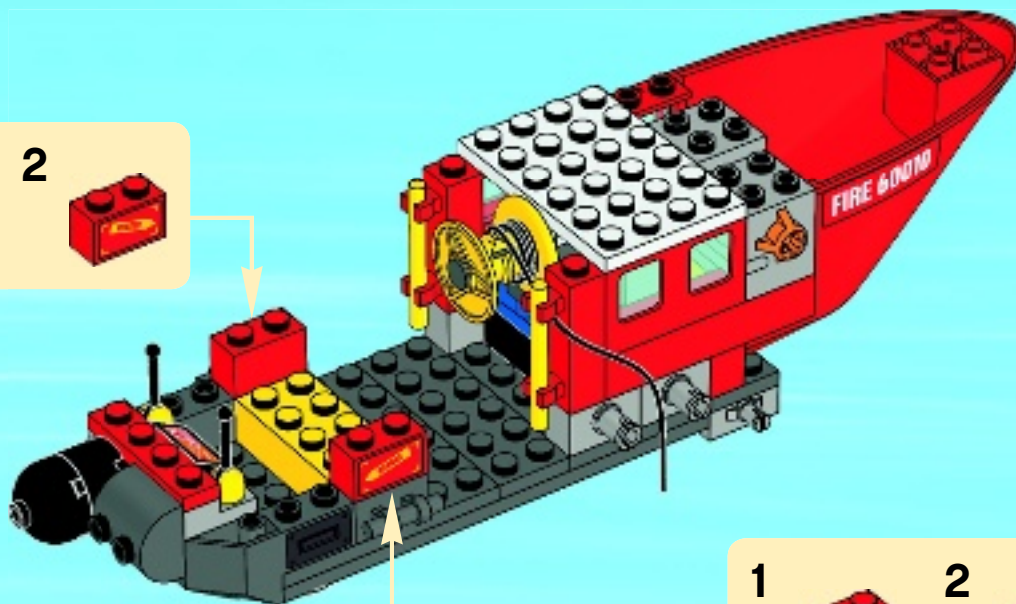

1



2





1x

30

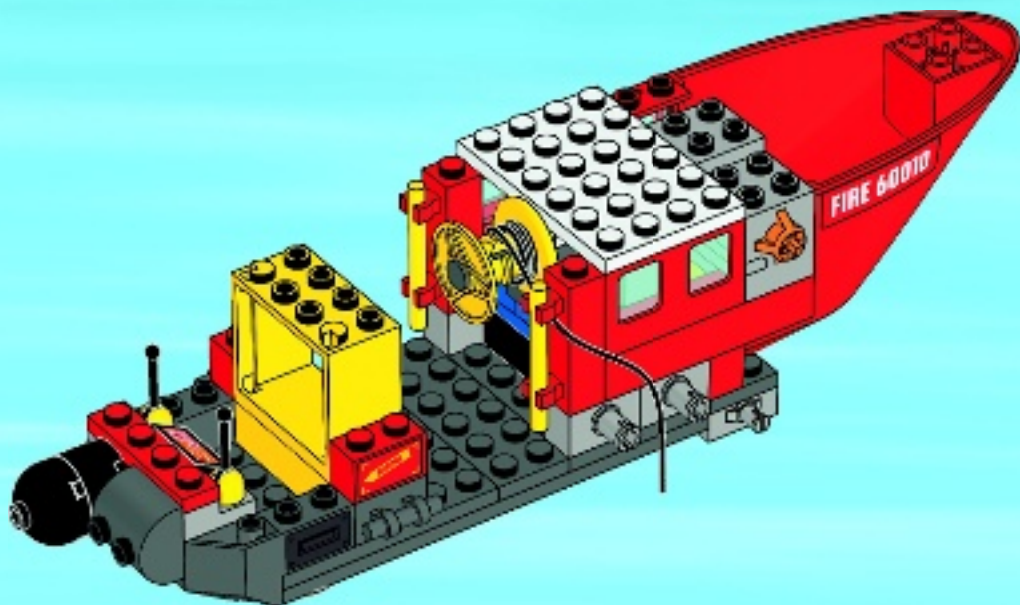



2x

31

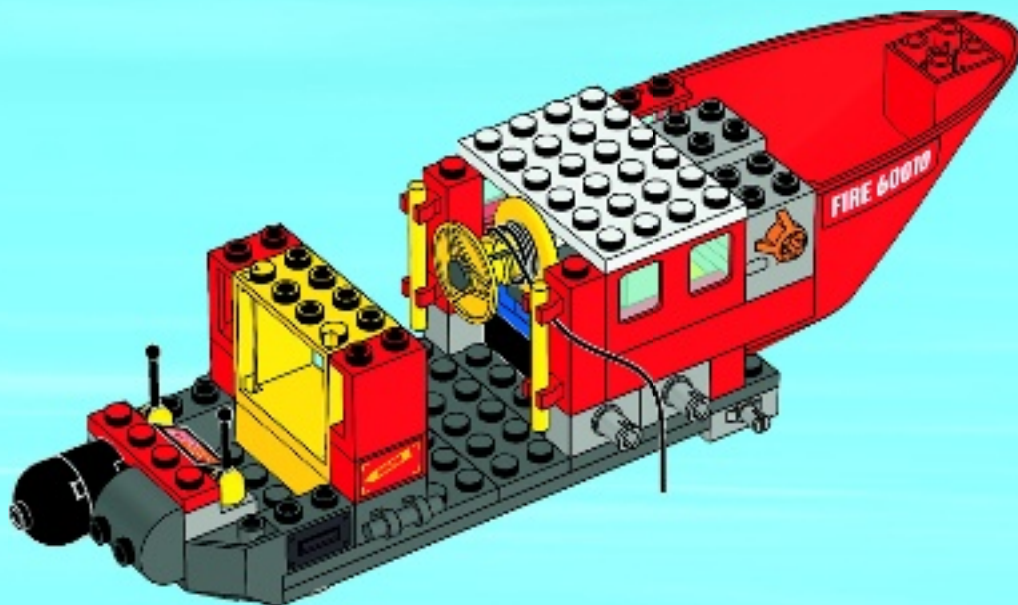



2x

32

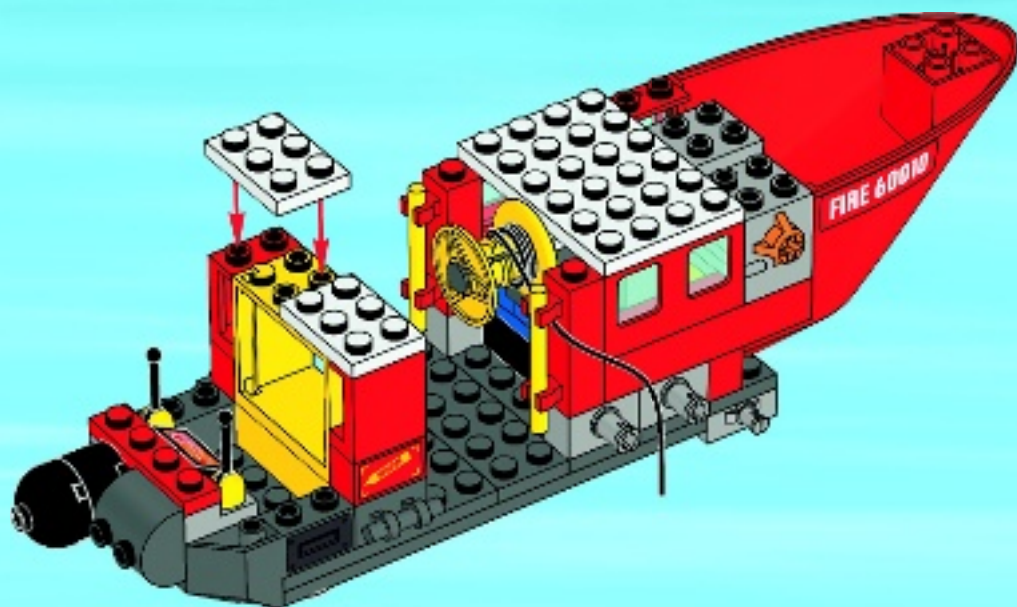



2x



1x

33

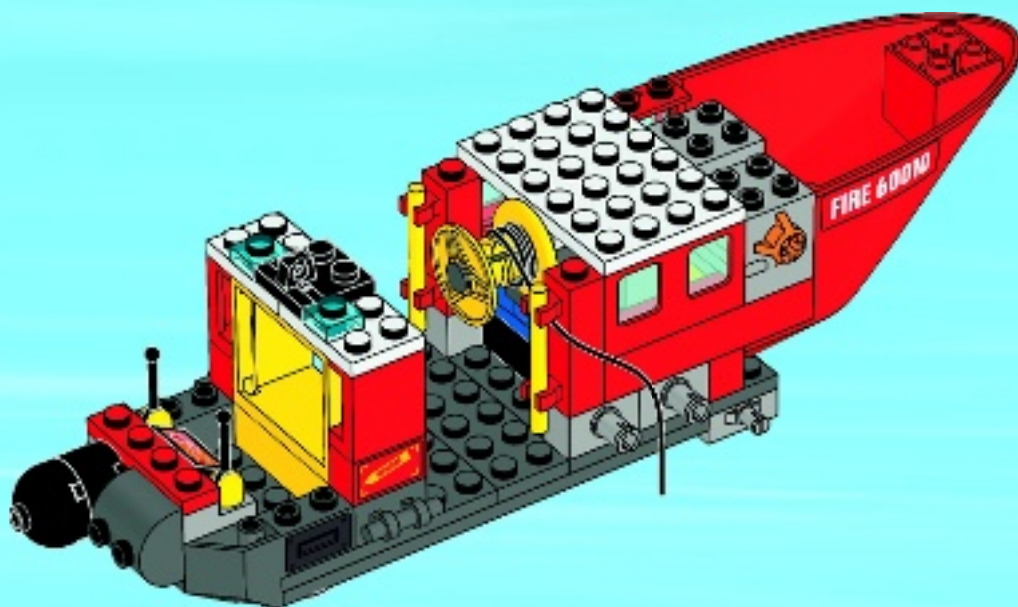



1x



2x

34

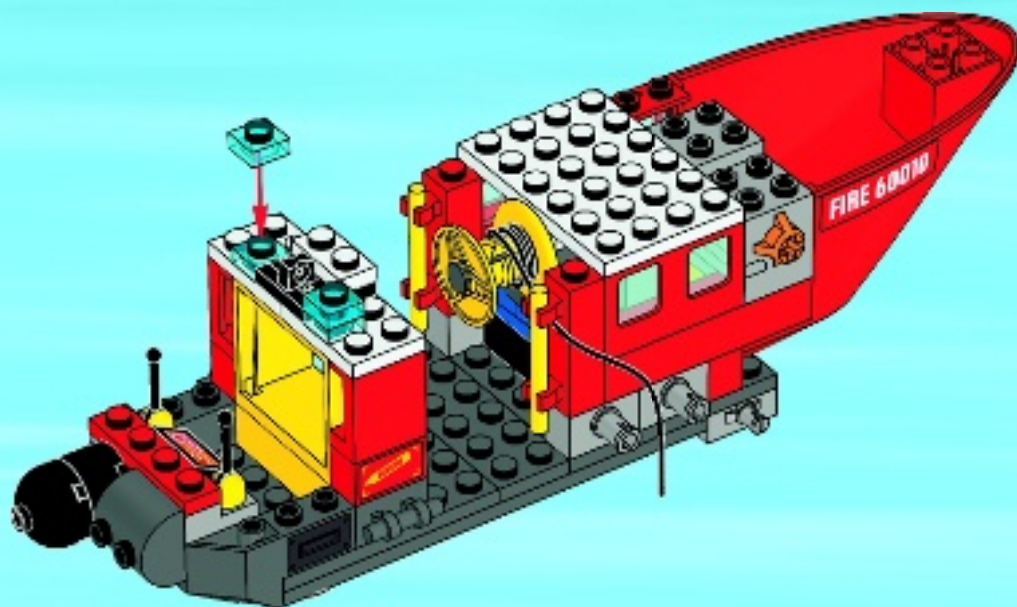



2x

35

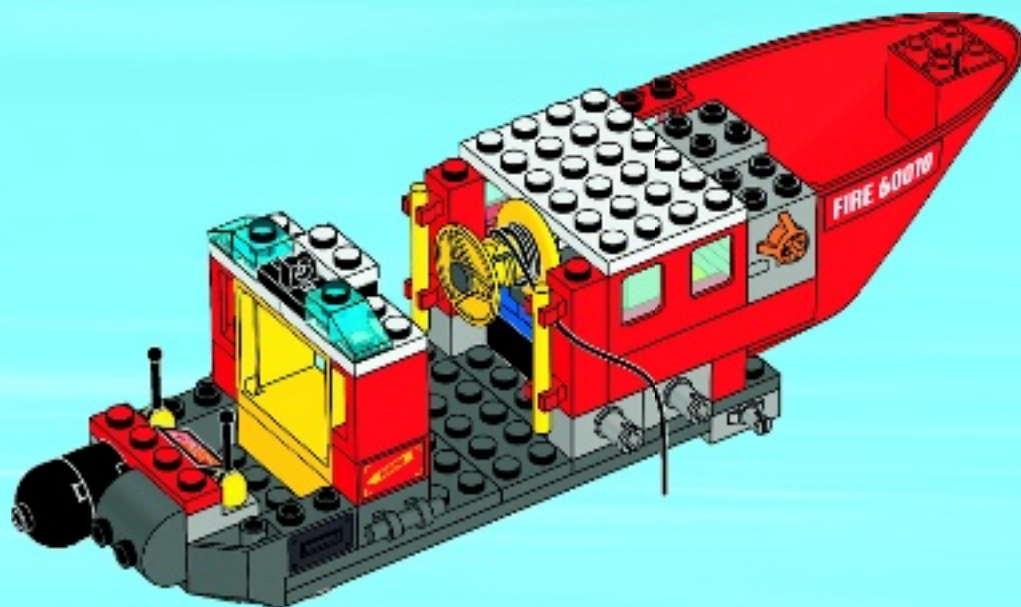

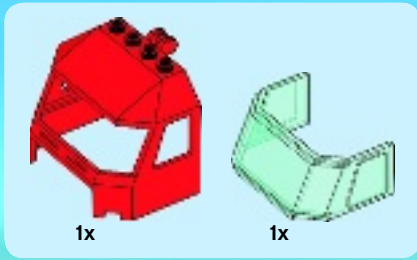

36

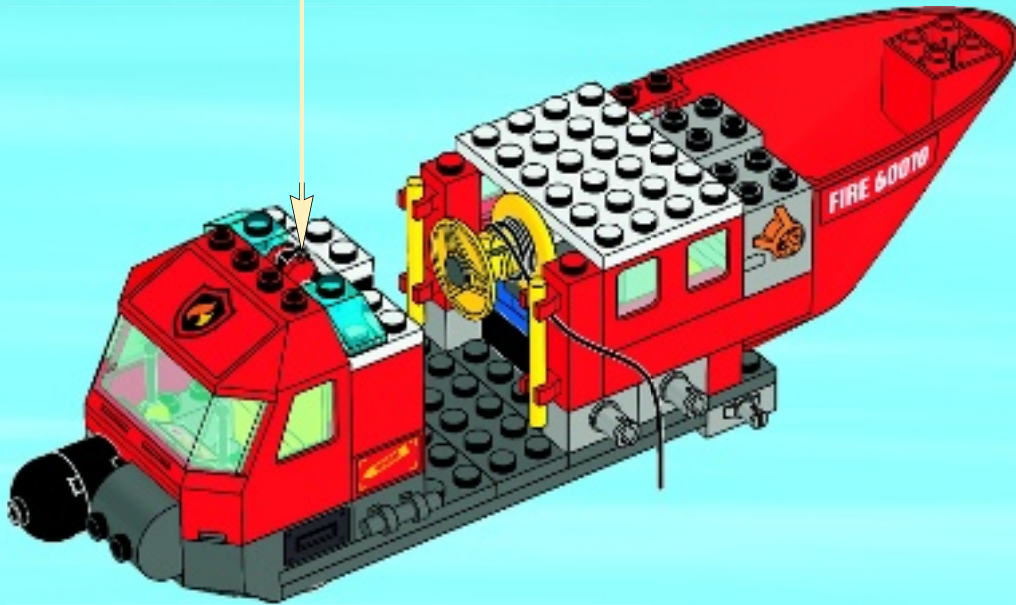
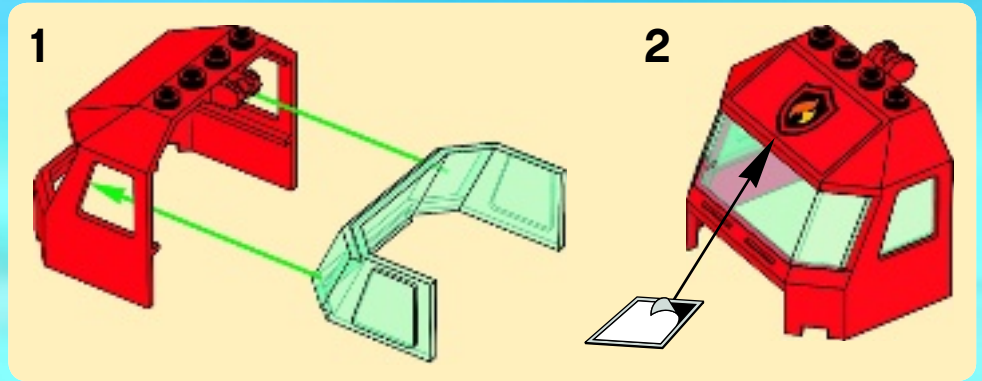



1x



1x

37

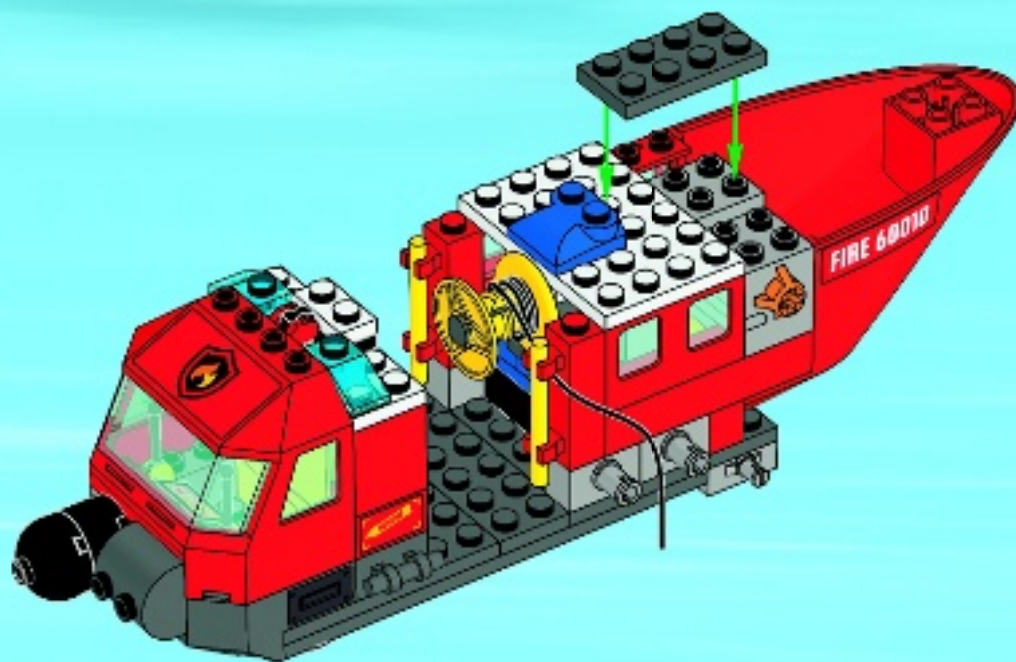



2x

38

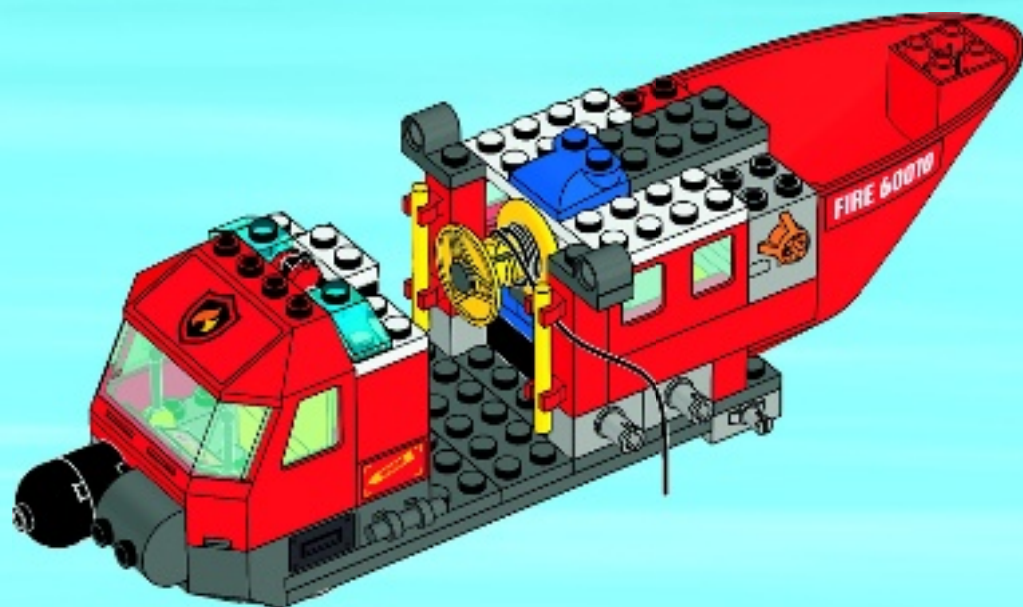

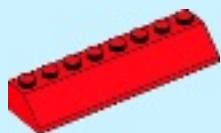

2x

39

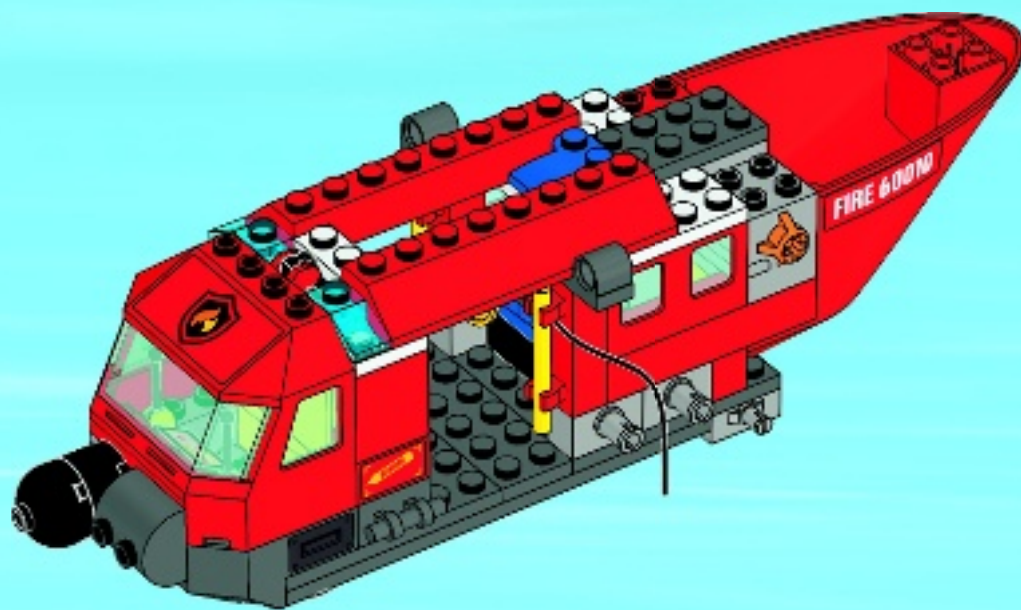



4x

40

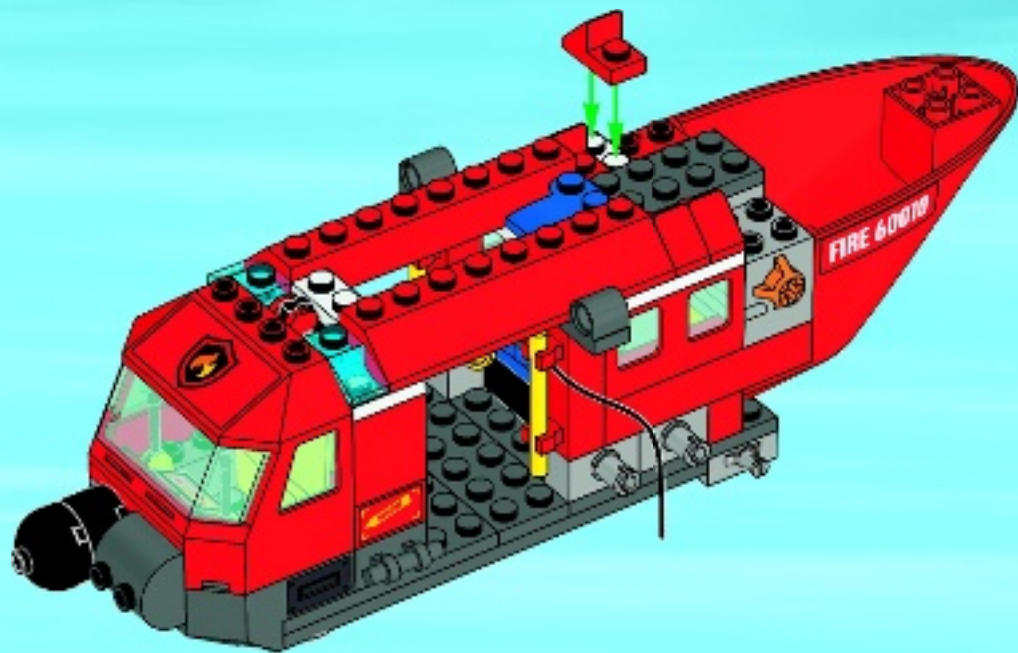



2x



1x

41

1



2

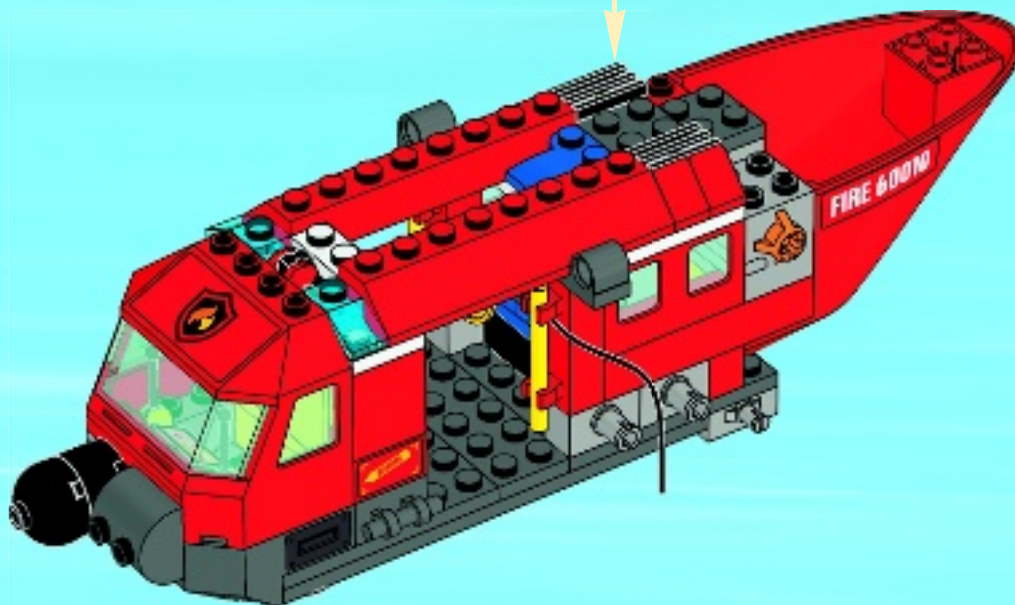

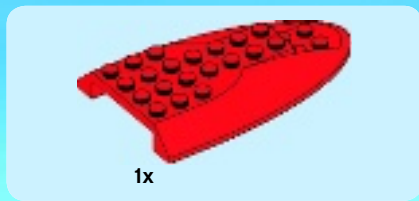

42

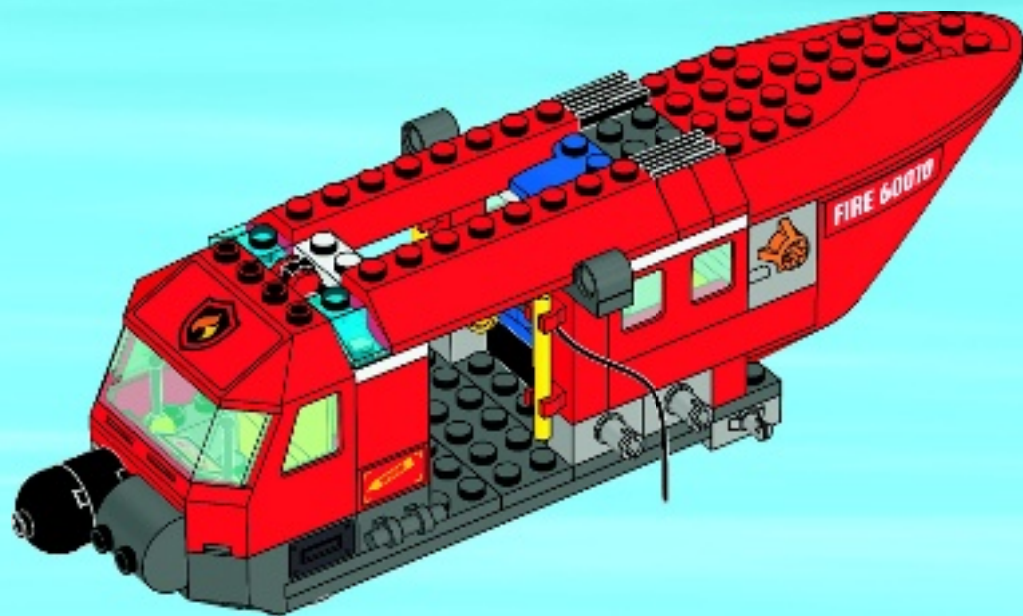



1x



1x

43

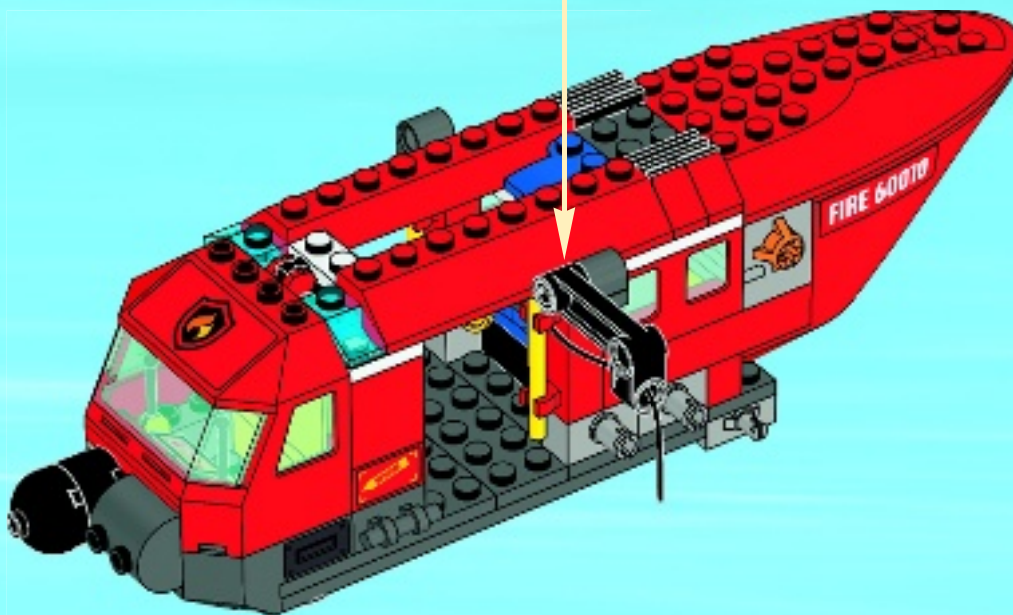
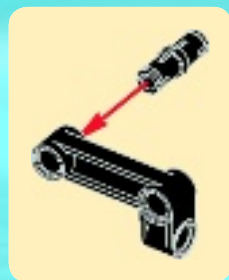



1x

44

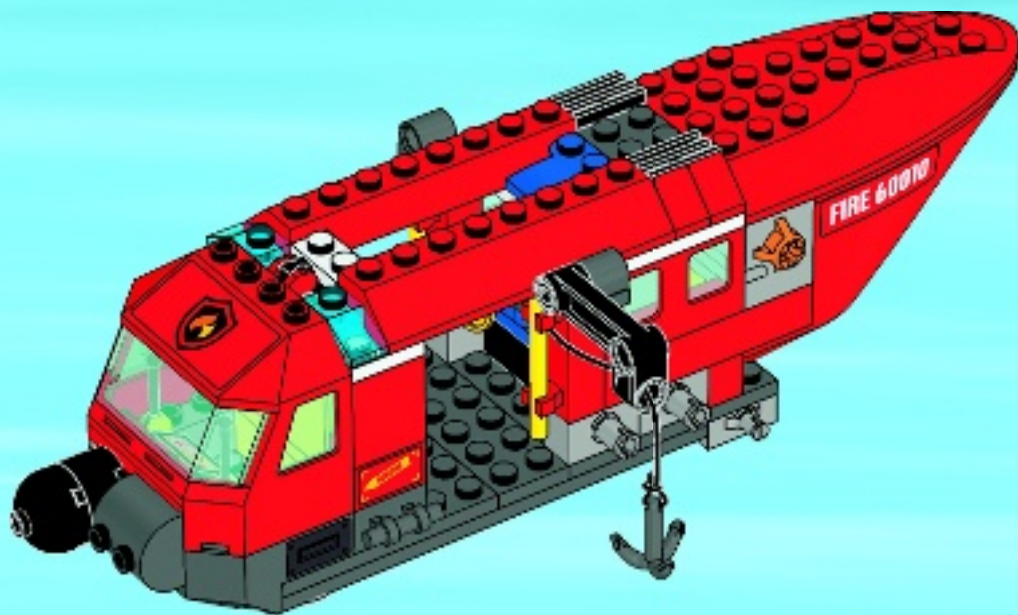
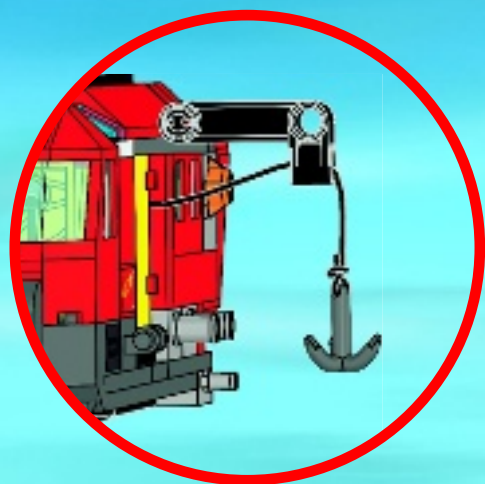

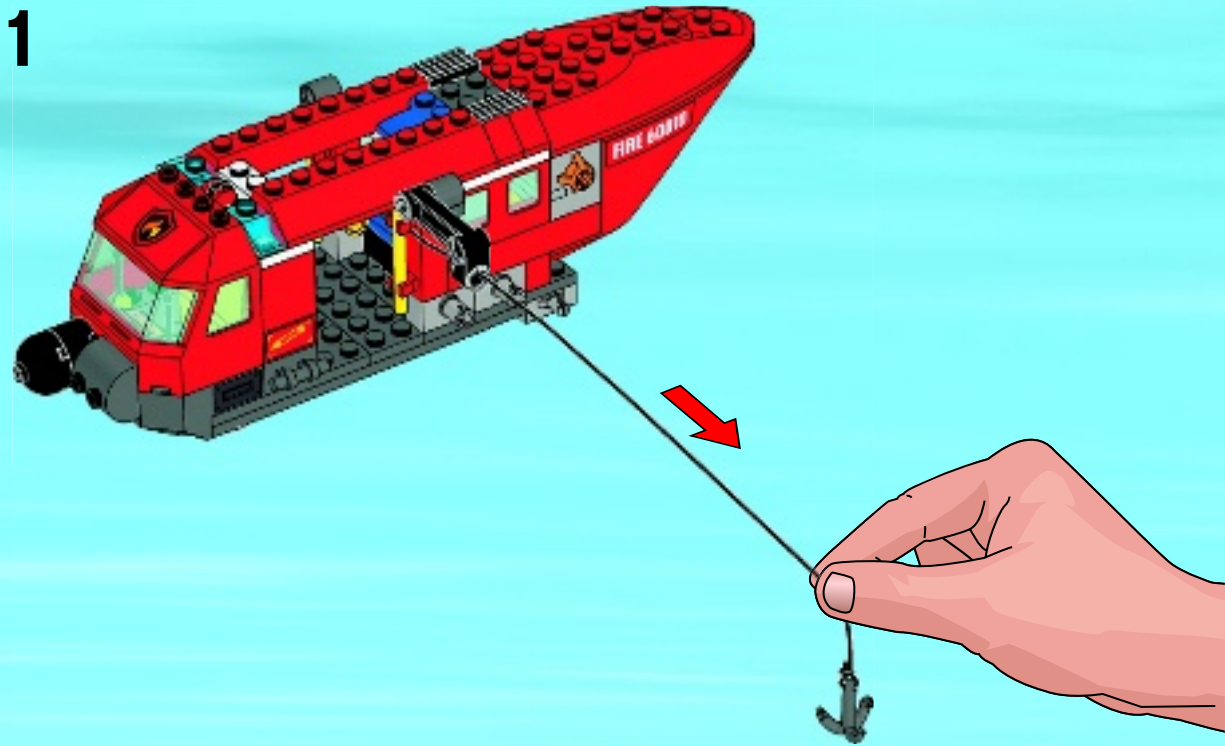

2

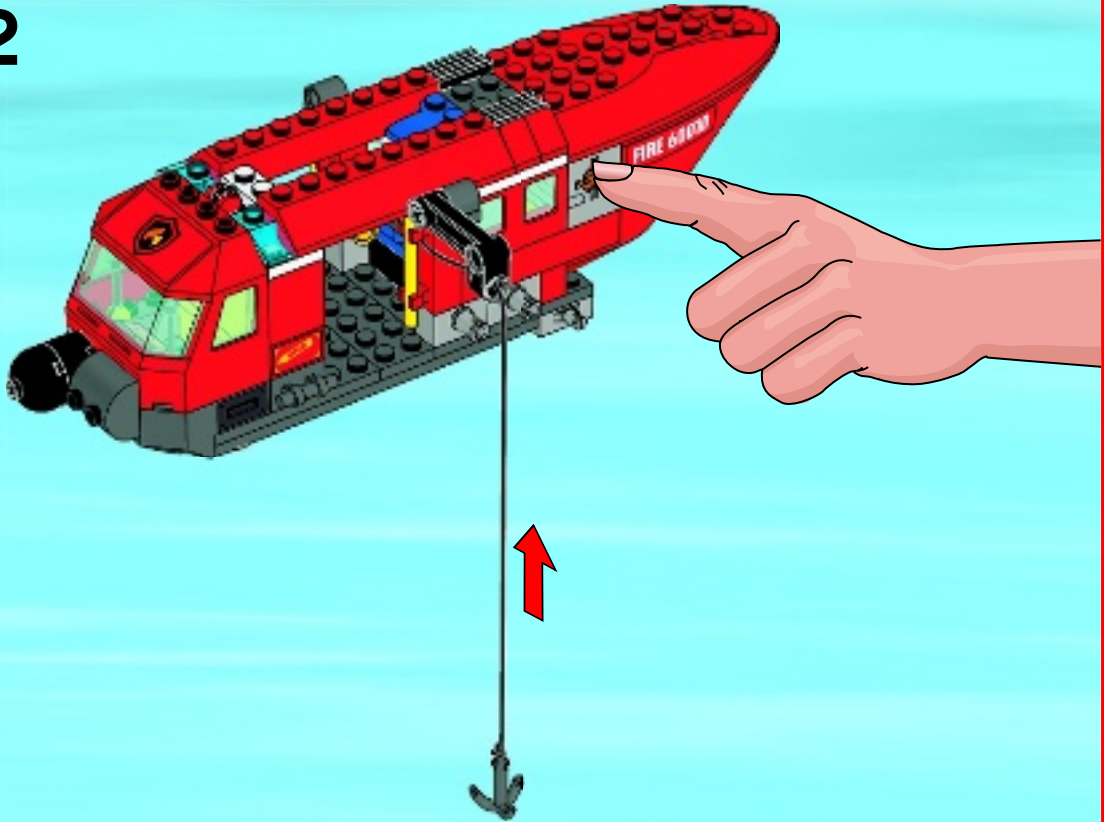



1x



1x

45

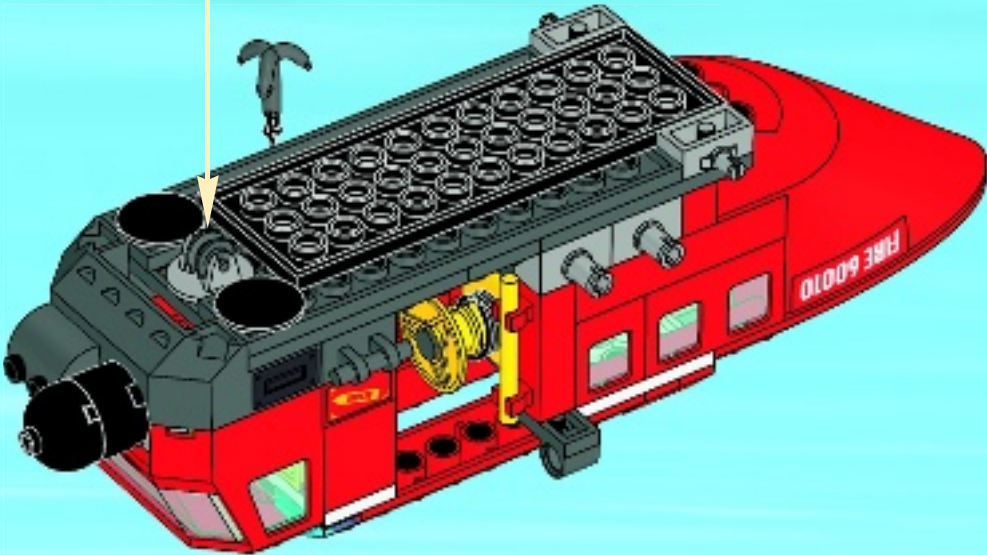
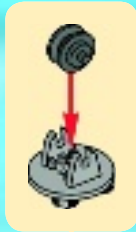



2x

46

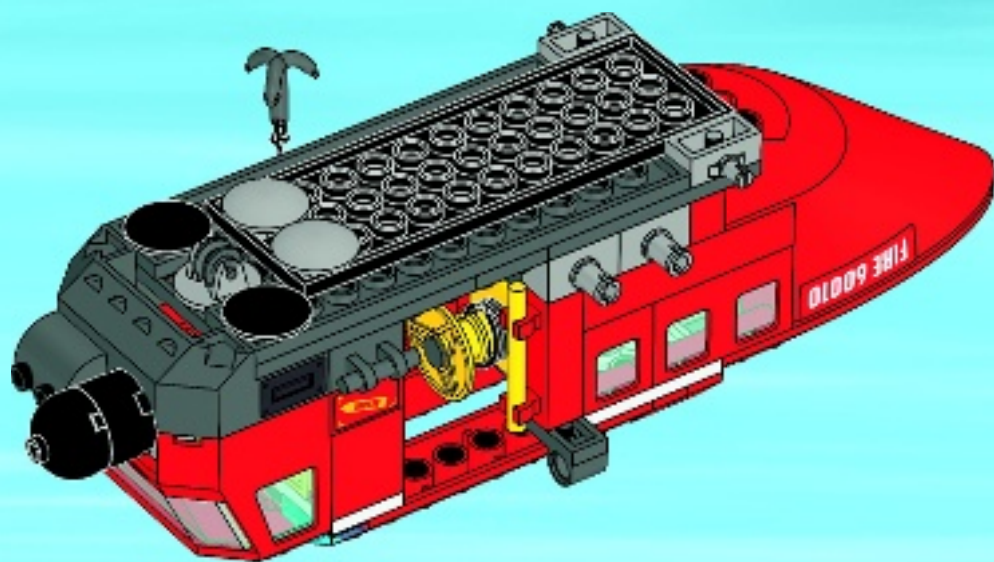



2x



2x

47



2x

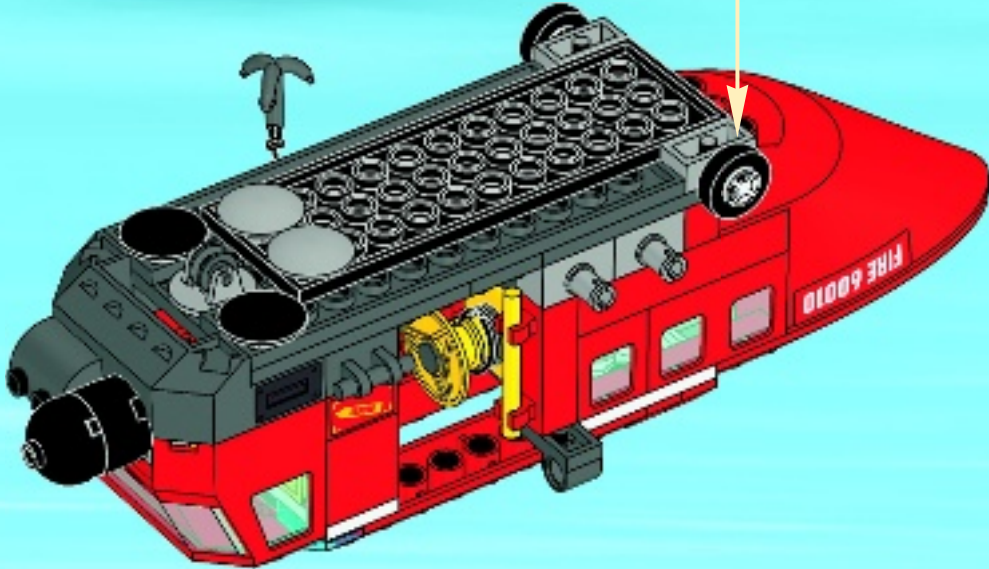

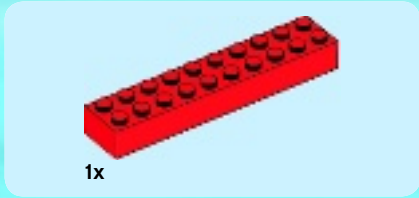

1

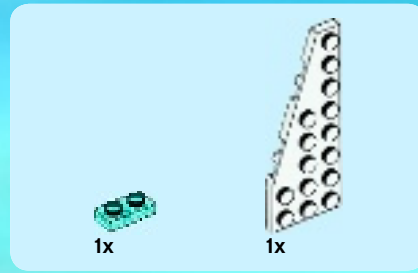
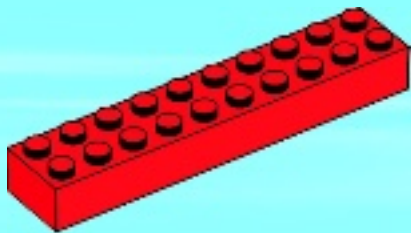

2

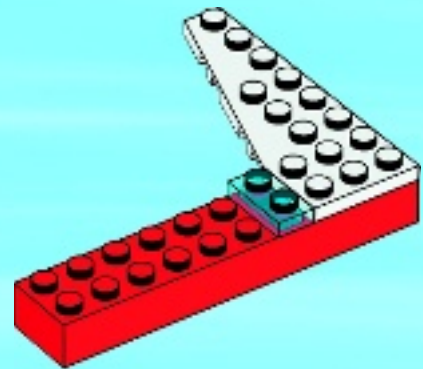



1x

3

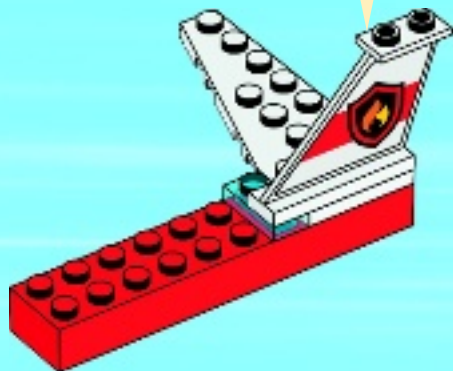
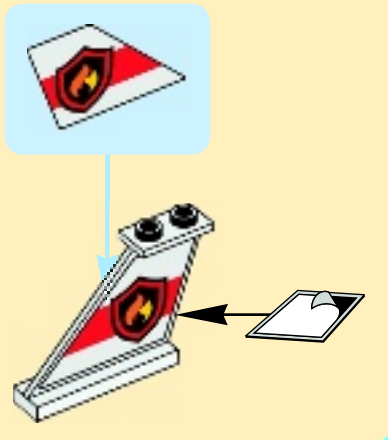

1x

4

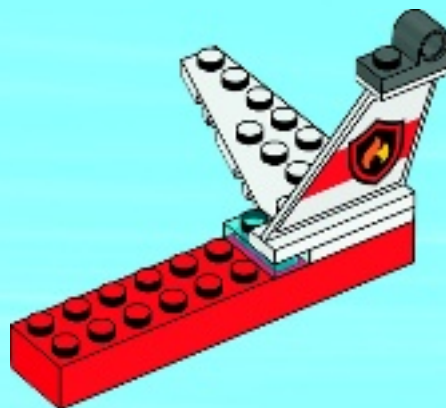



1x



1x

5

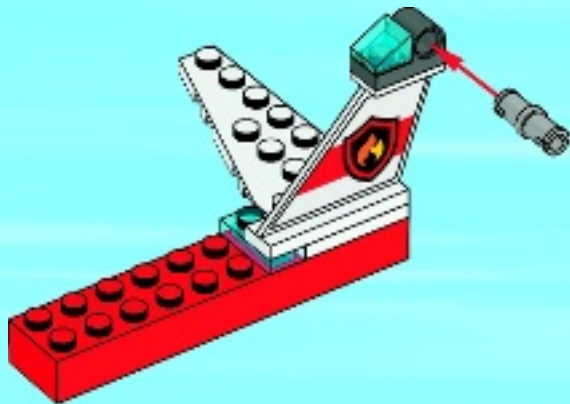

1x

6



48

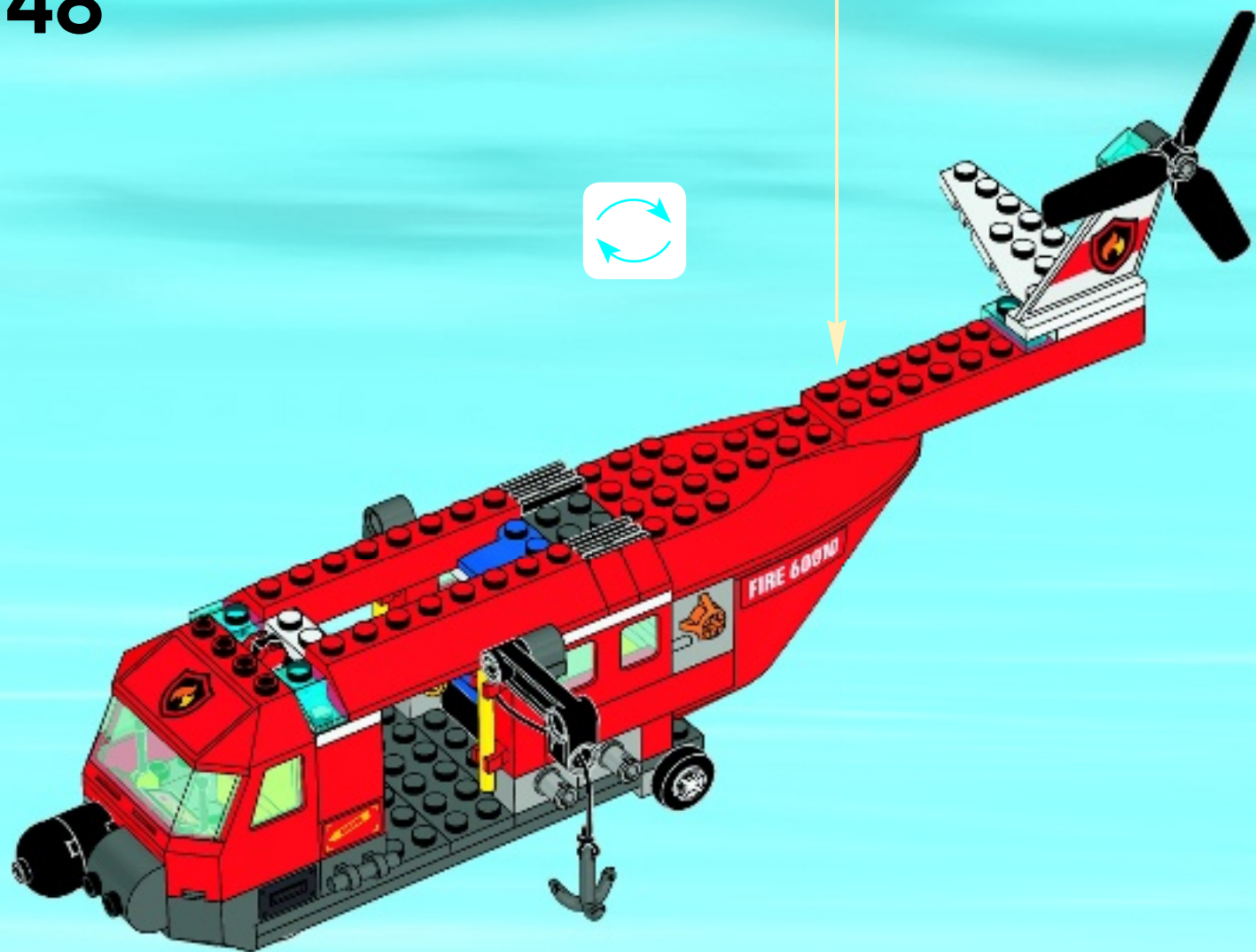



1x



1x

49





1x

50



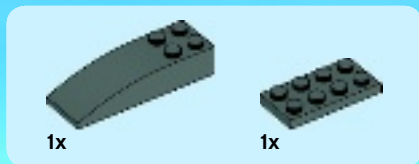

51

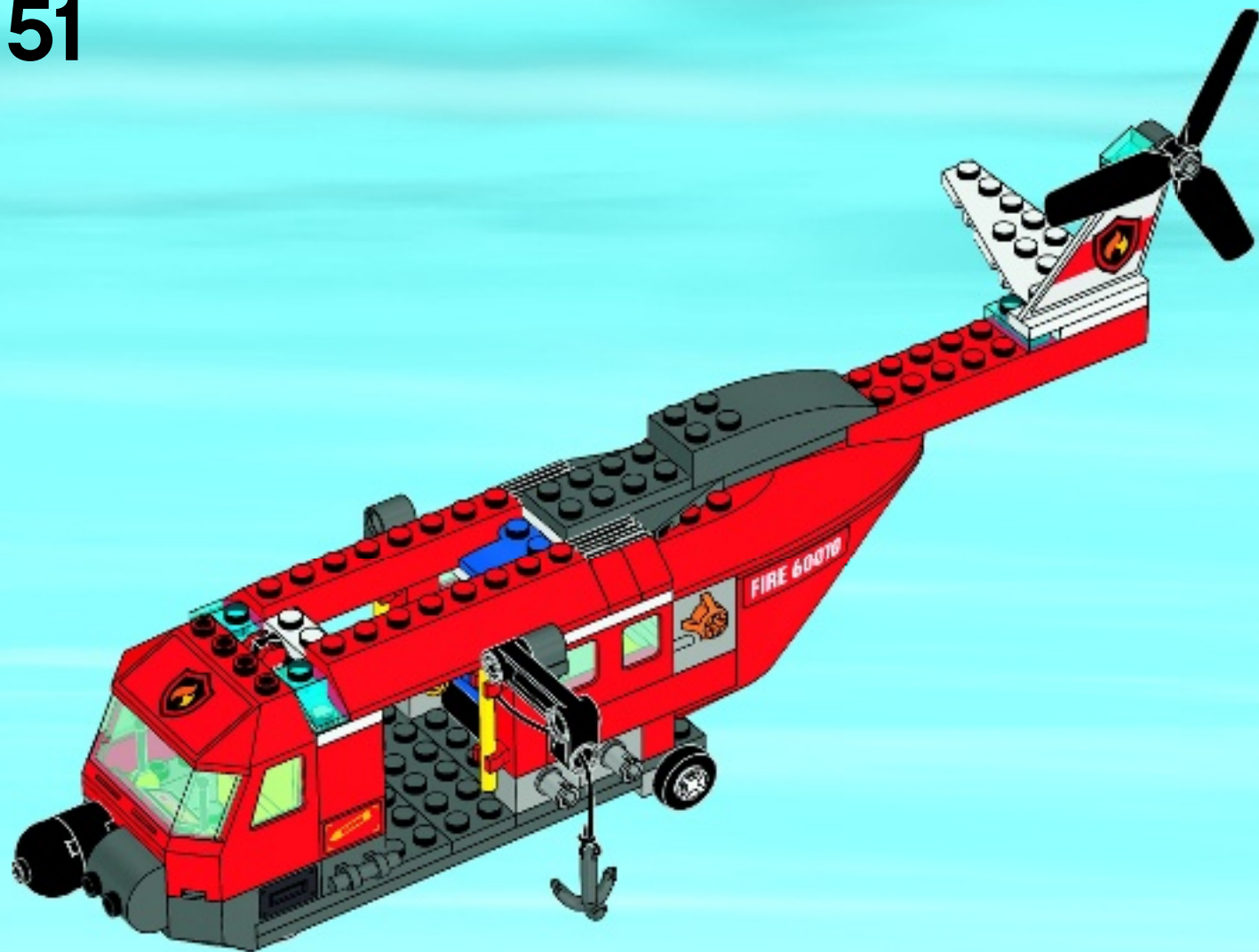



2x

52

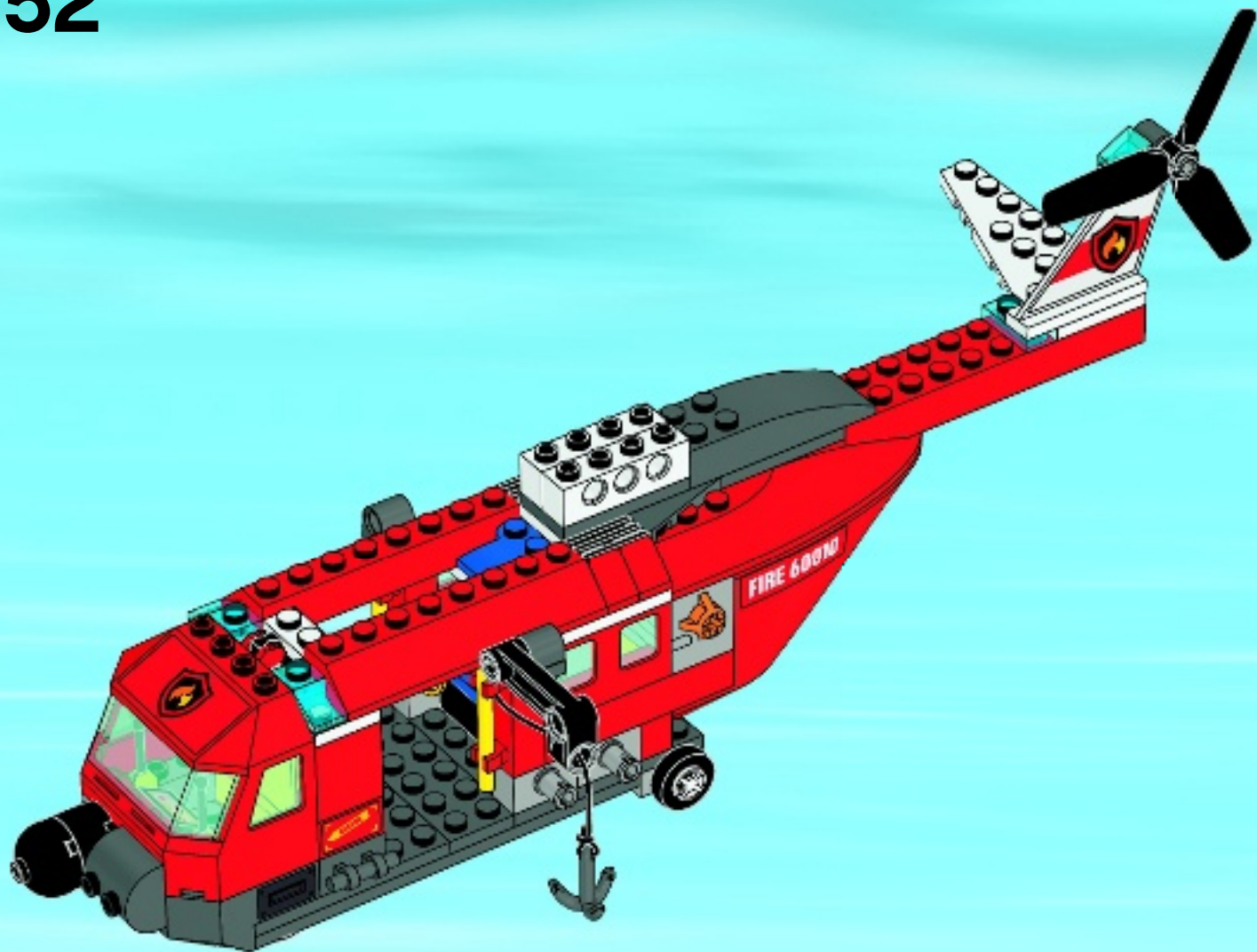



1x

53

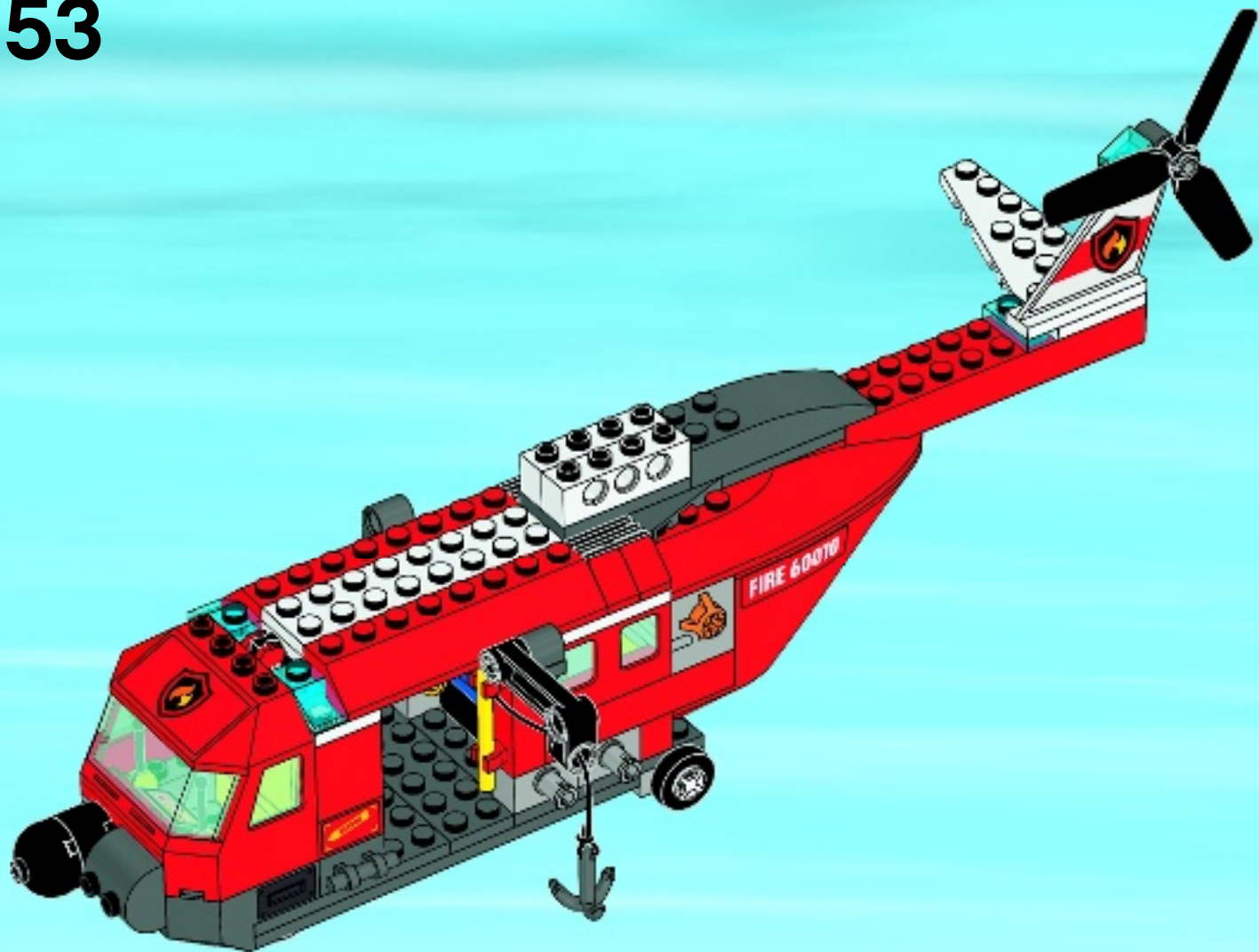



1x

54

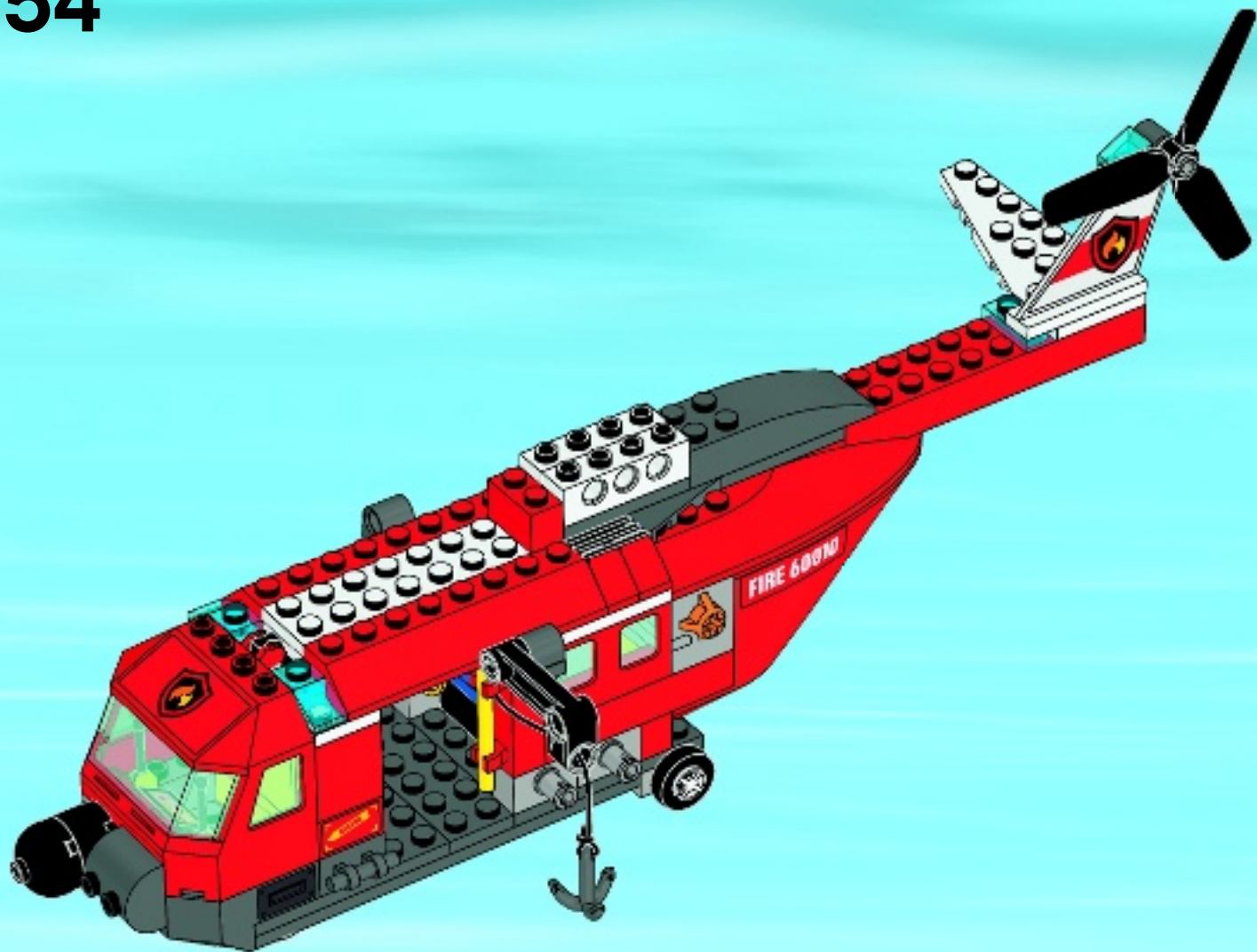



1x



1x

55

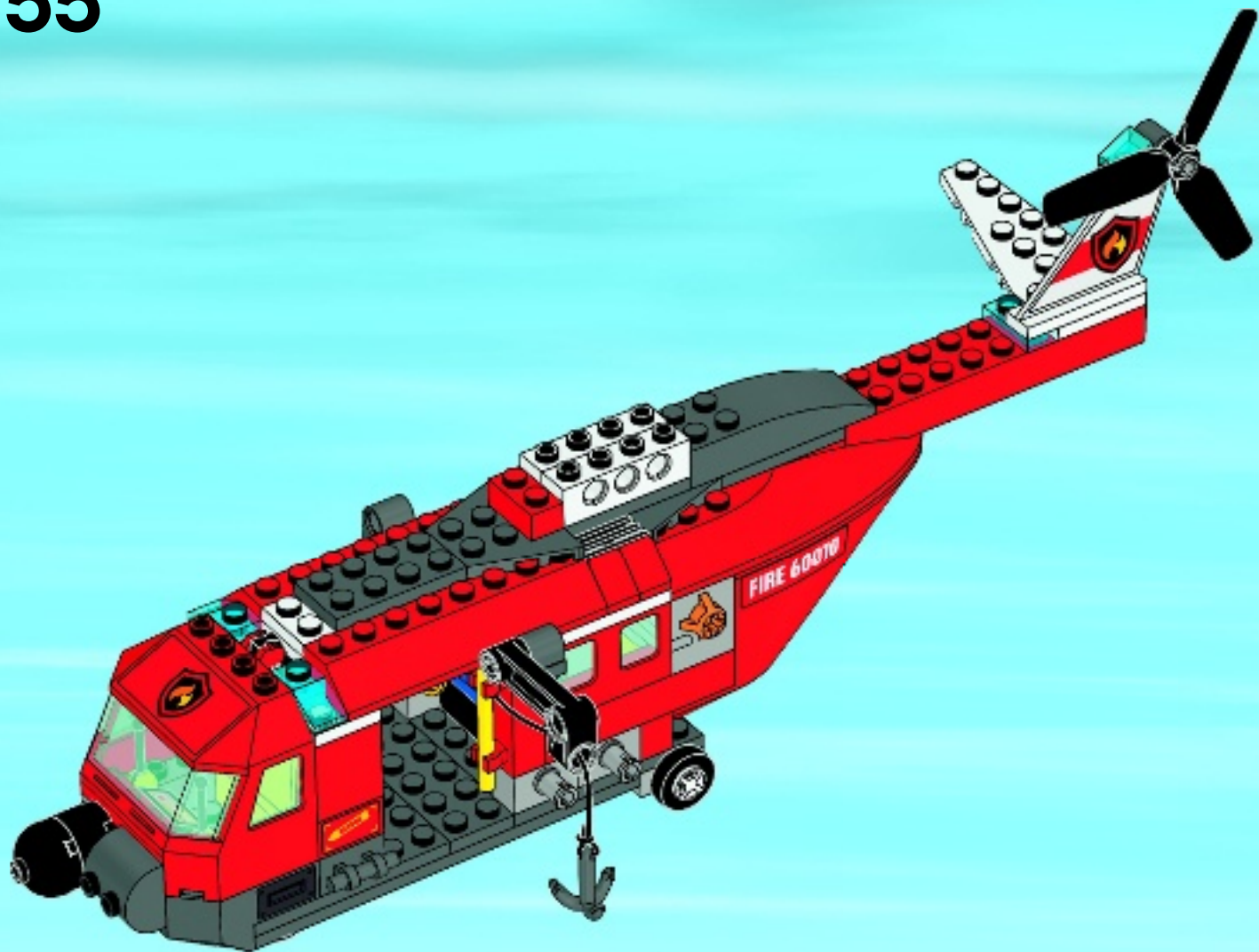



1x

56

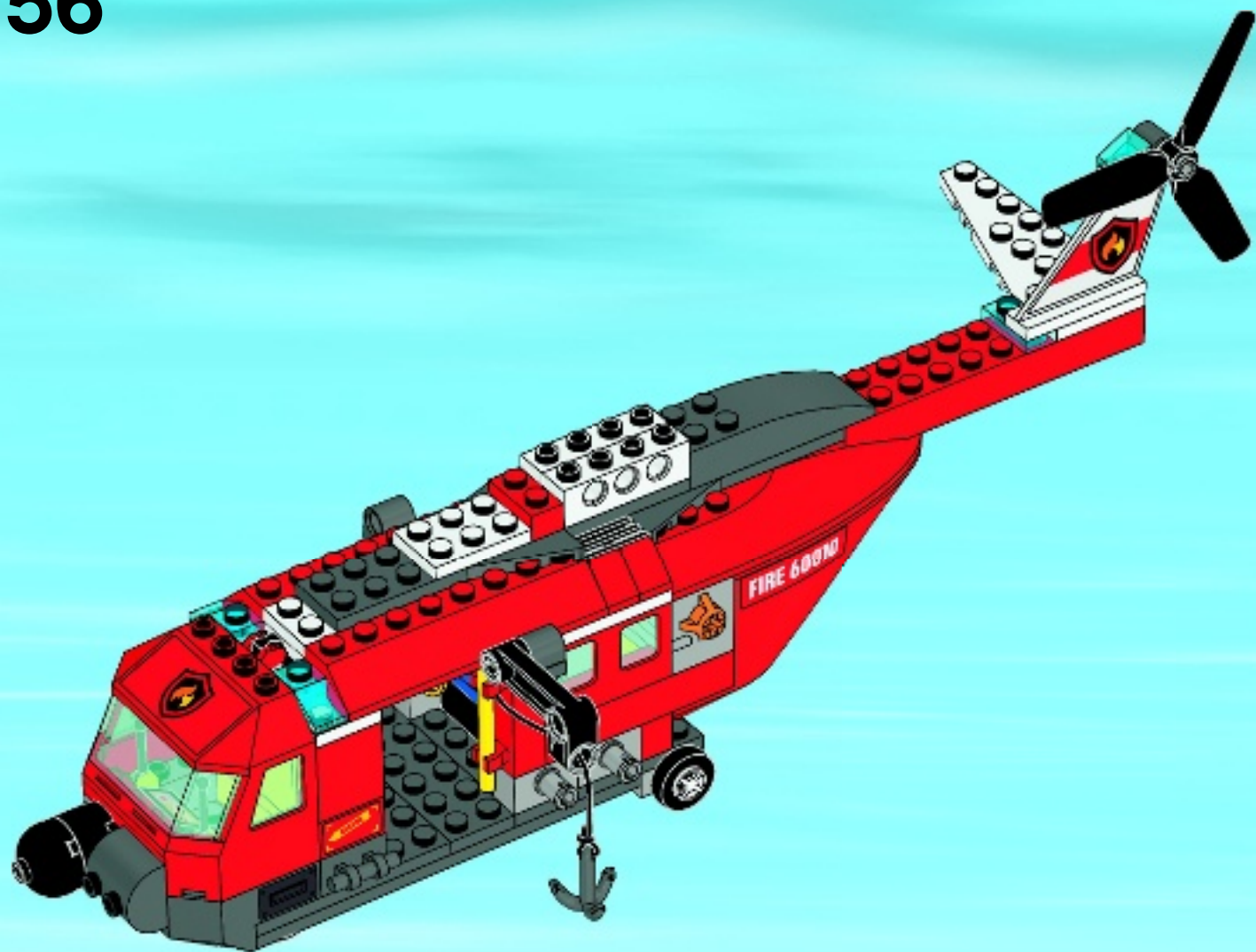



2x

57

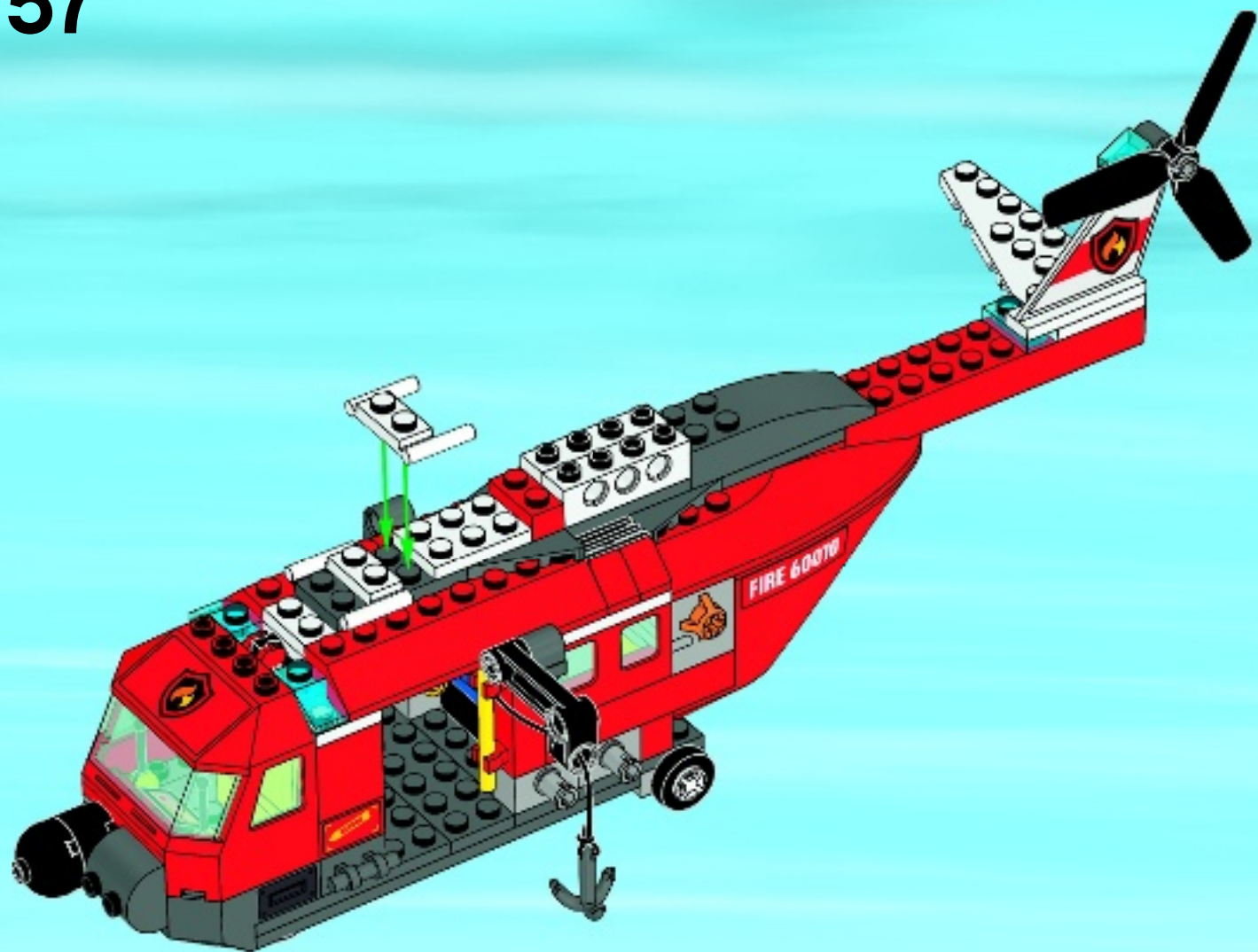



1x

58

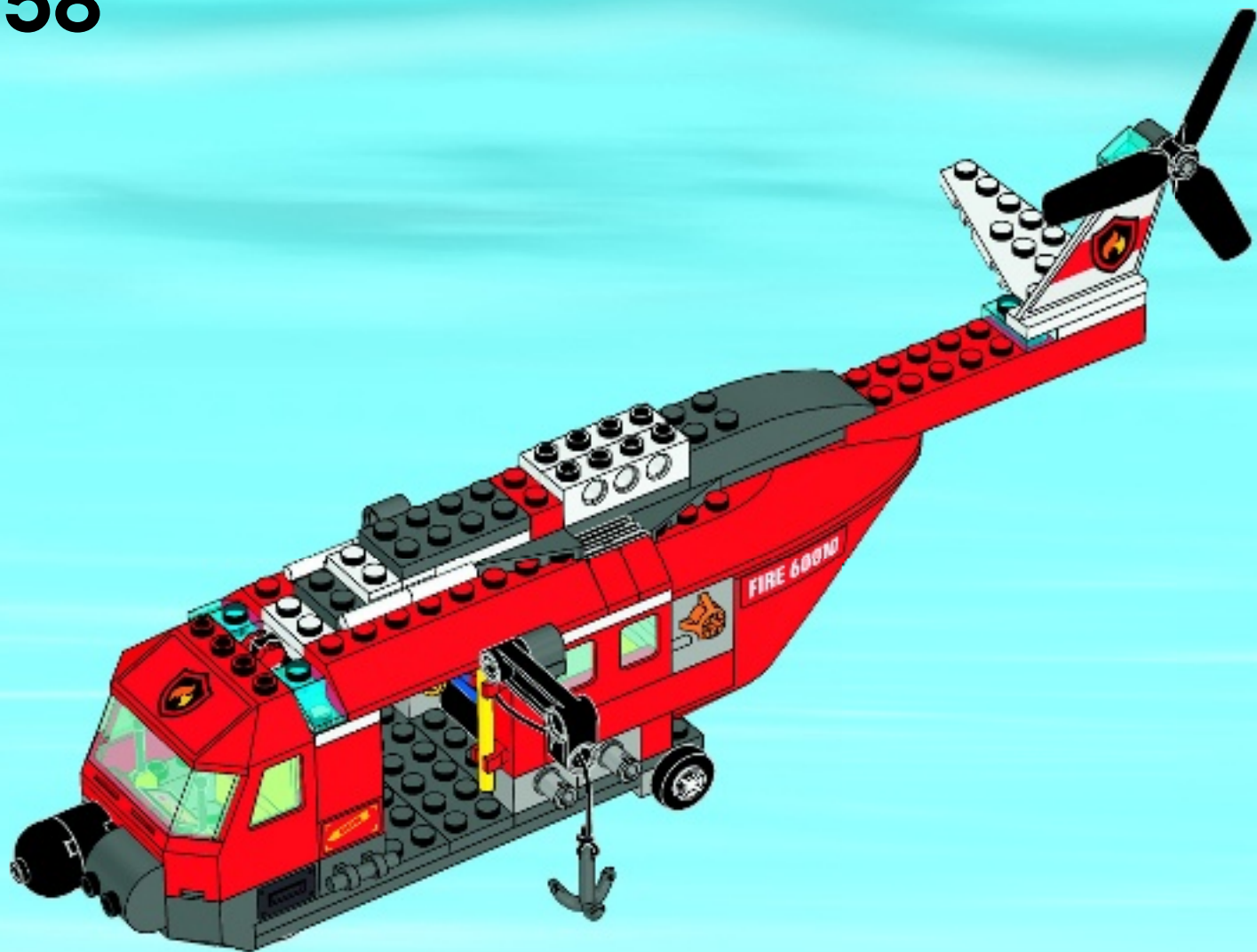



1x

59





1x



1x

60





2x

61





1x



1x

62



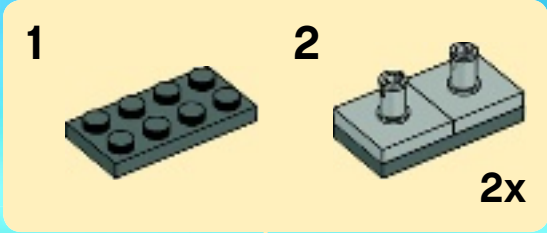

63

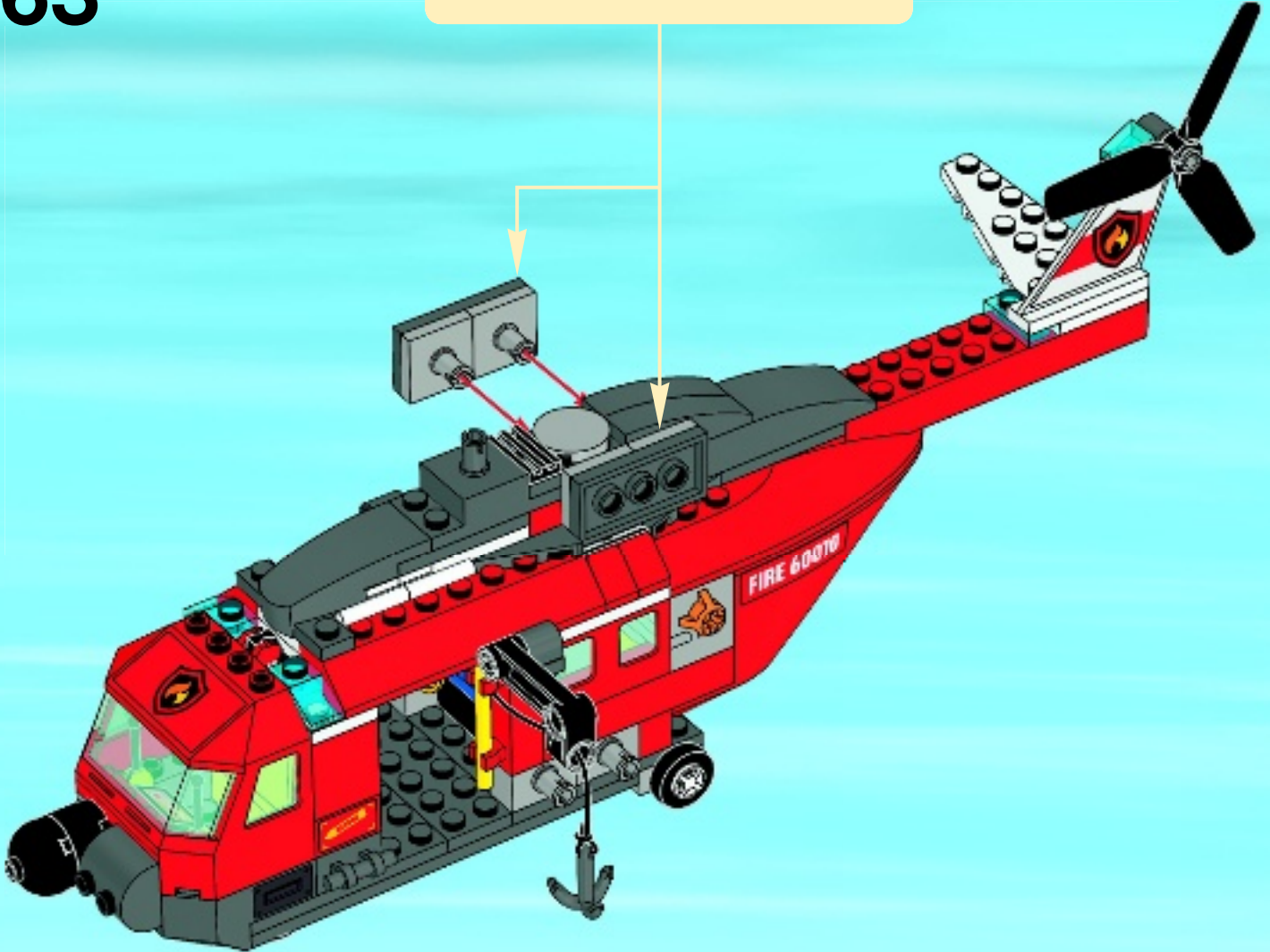

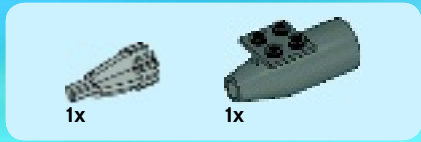

64

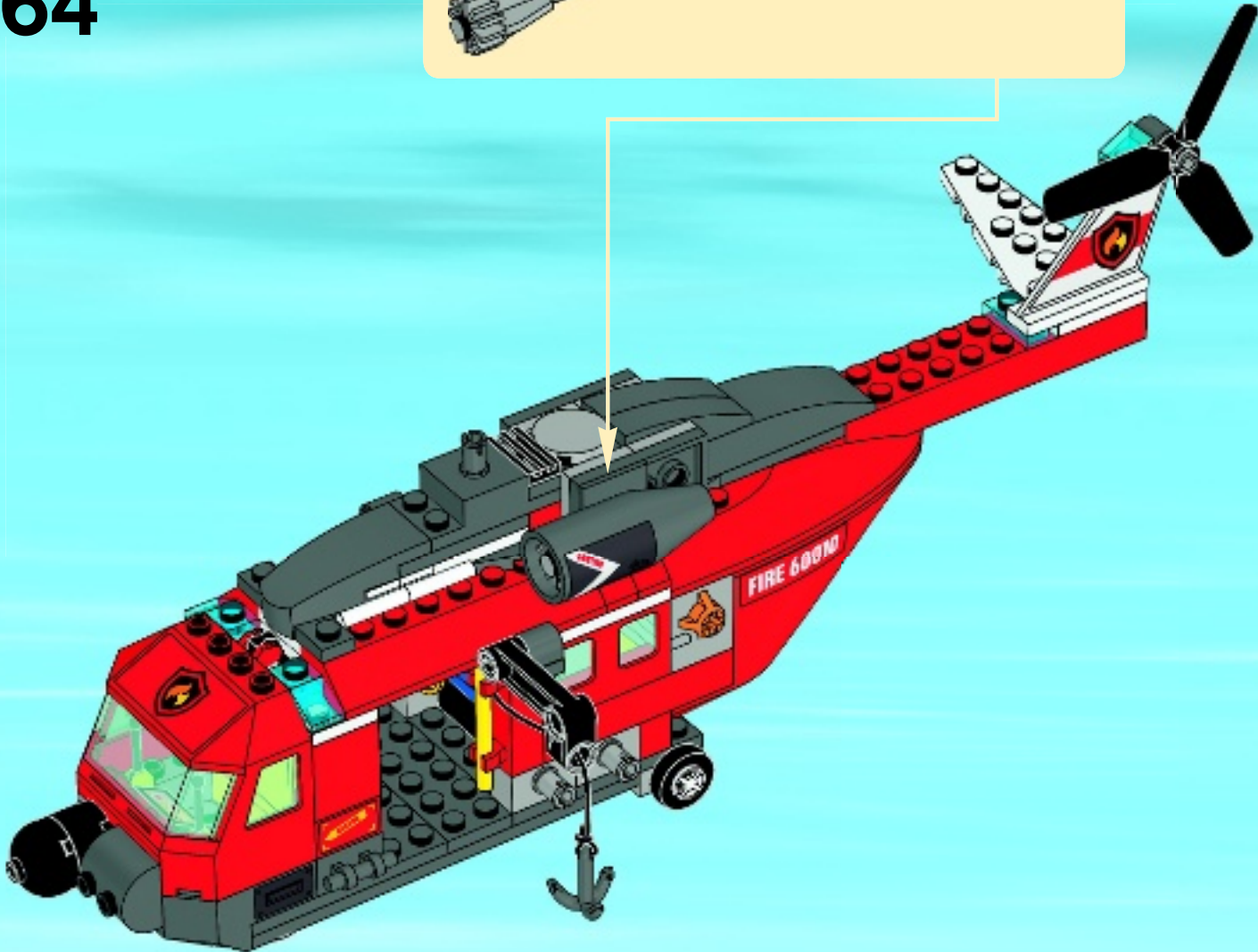
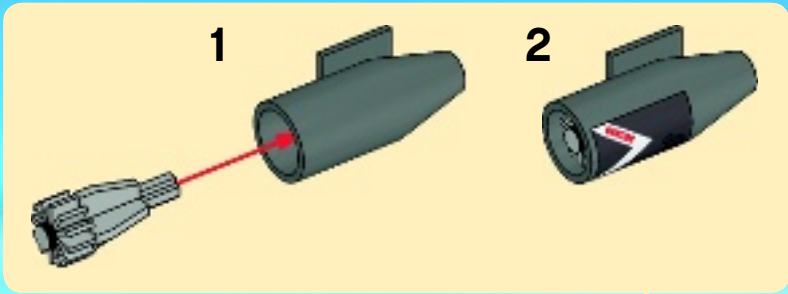



1x



1x

65



1

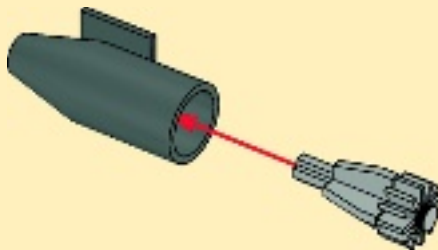

2

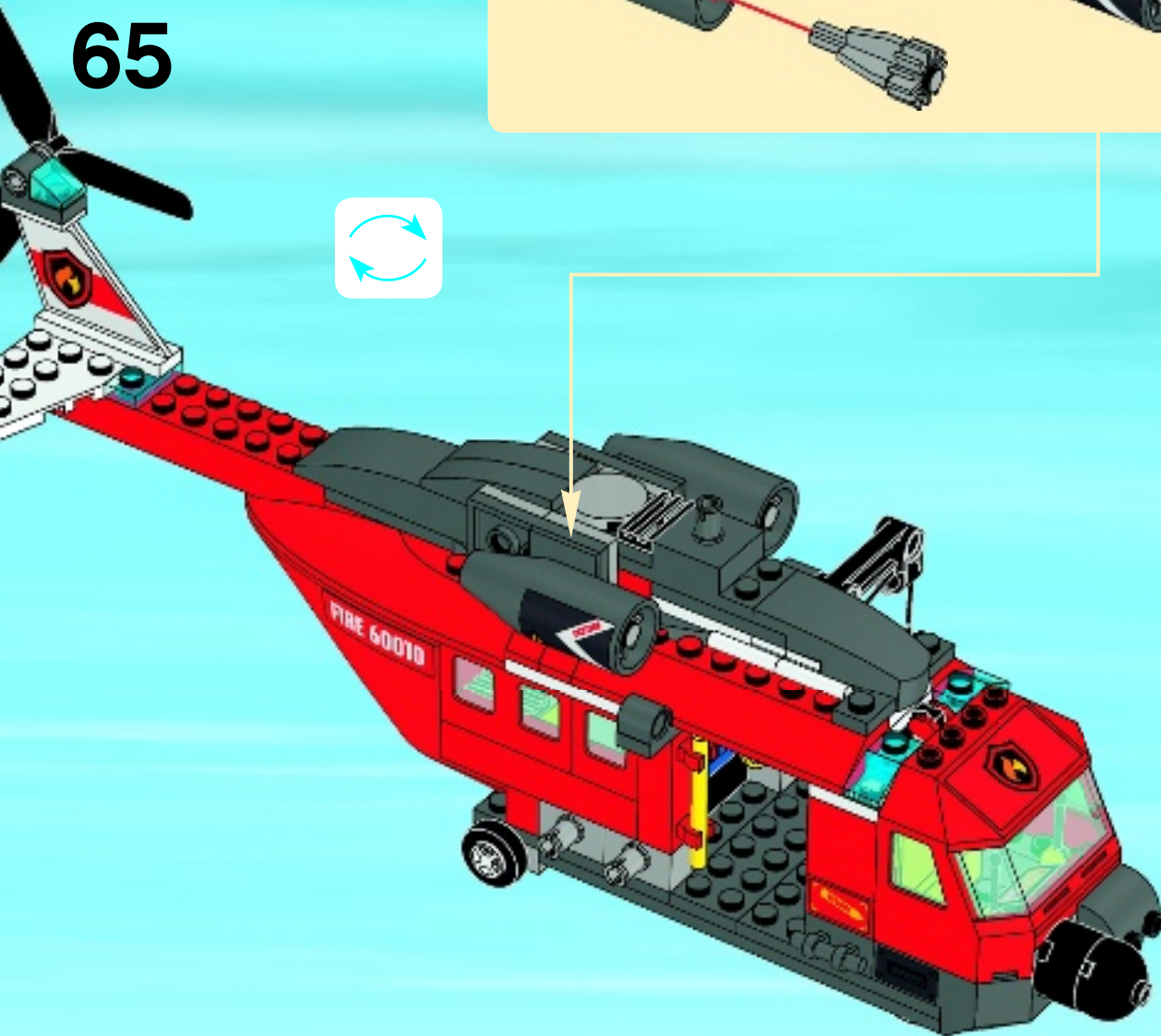



1x



1x

66

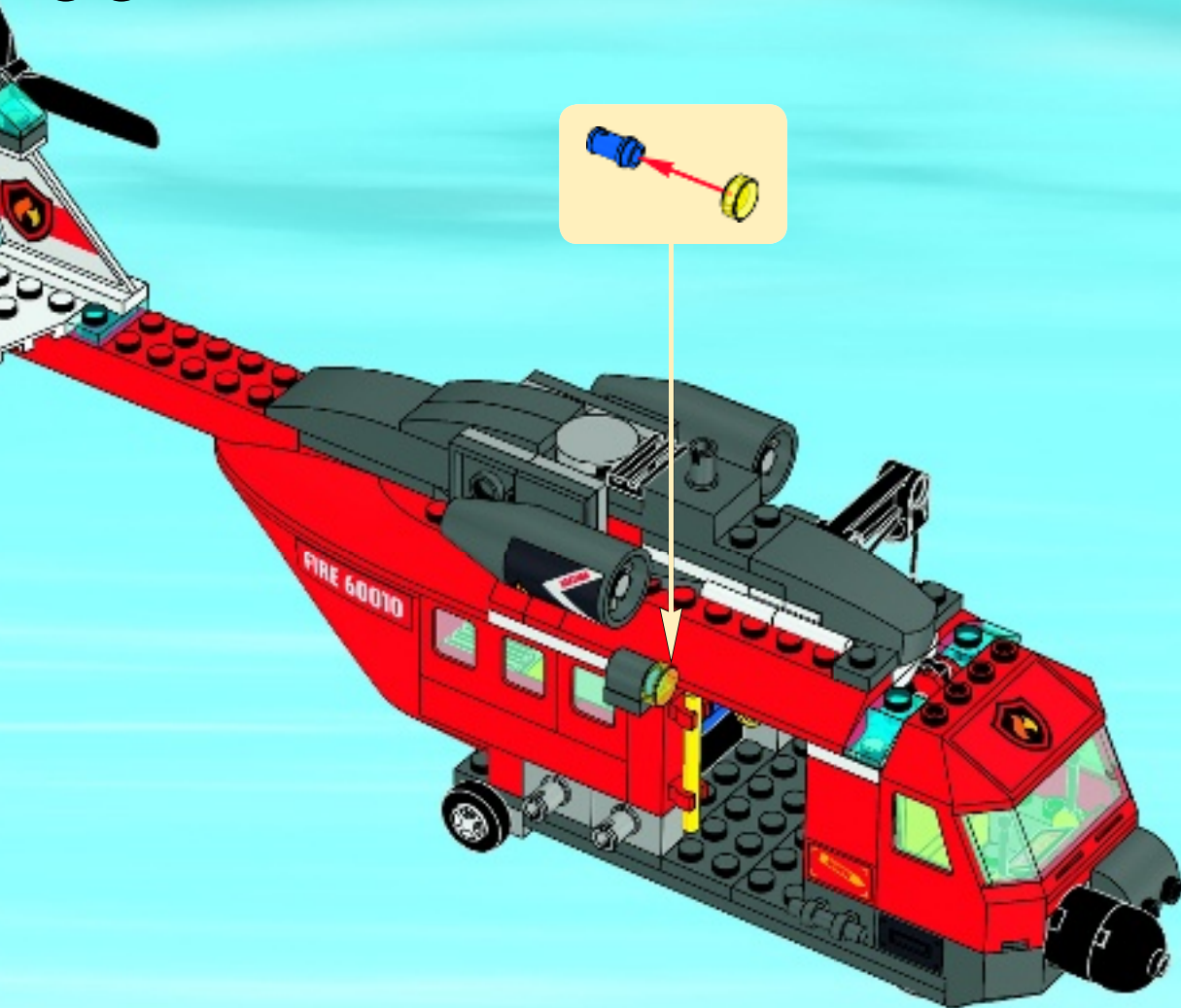



1x

1

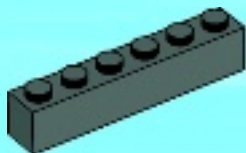

2x

2





1x

3

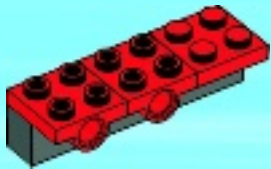

1x



2x

4

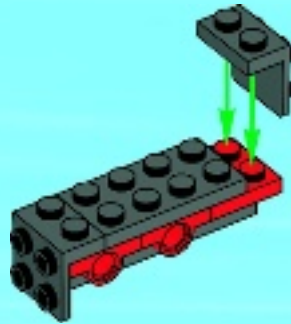



2x

5

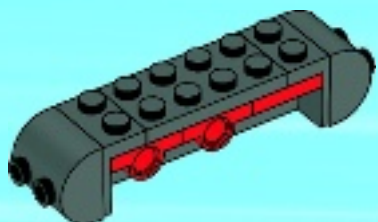

2x

6

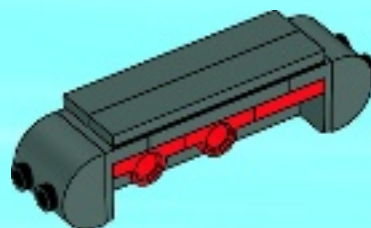

67



1x



1x



1x



1x



1x

68

1



2

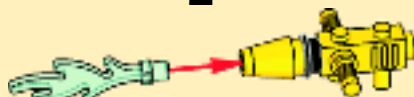

3

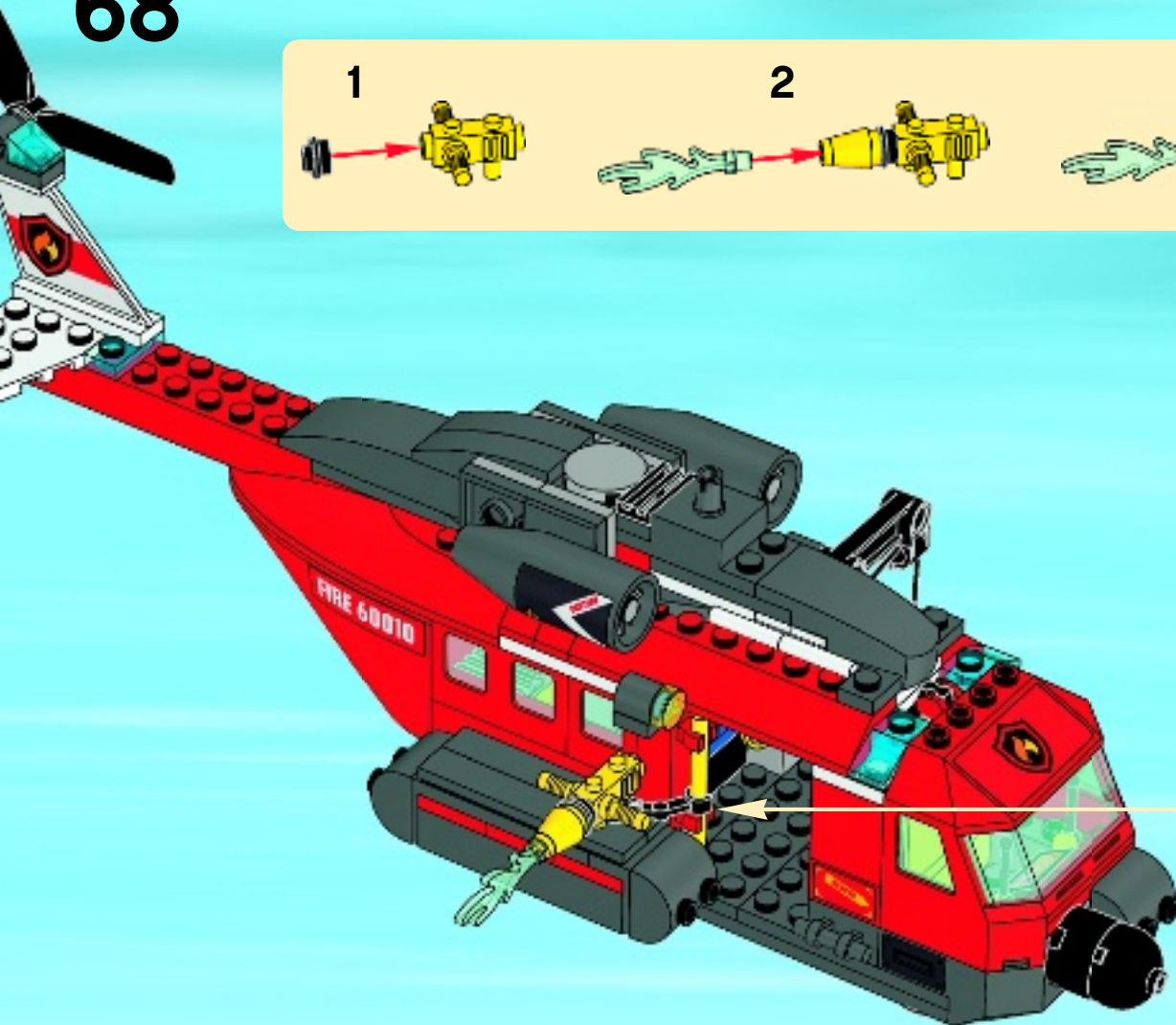



1x

1

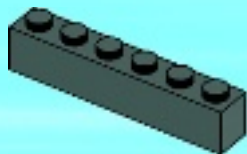

2x

2

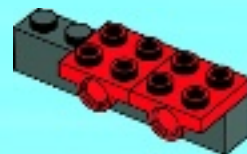



1x

3

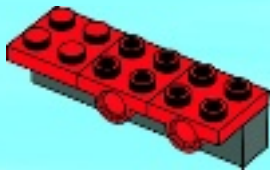

1x



2x

4

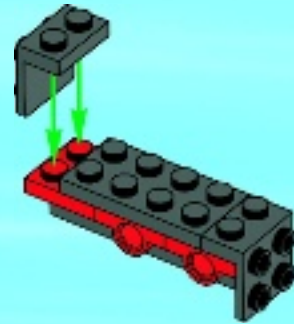



2x

5



2x

6

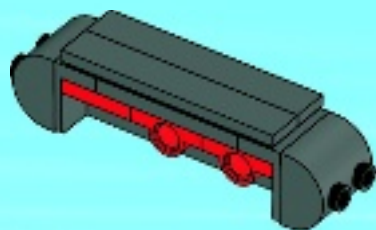

69



1x



1x



1x



1x



1x

70

1



2



3

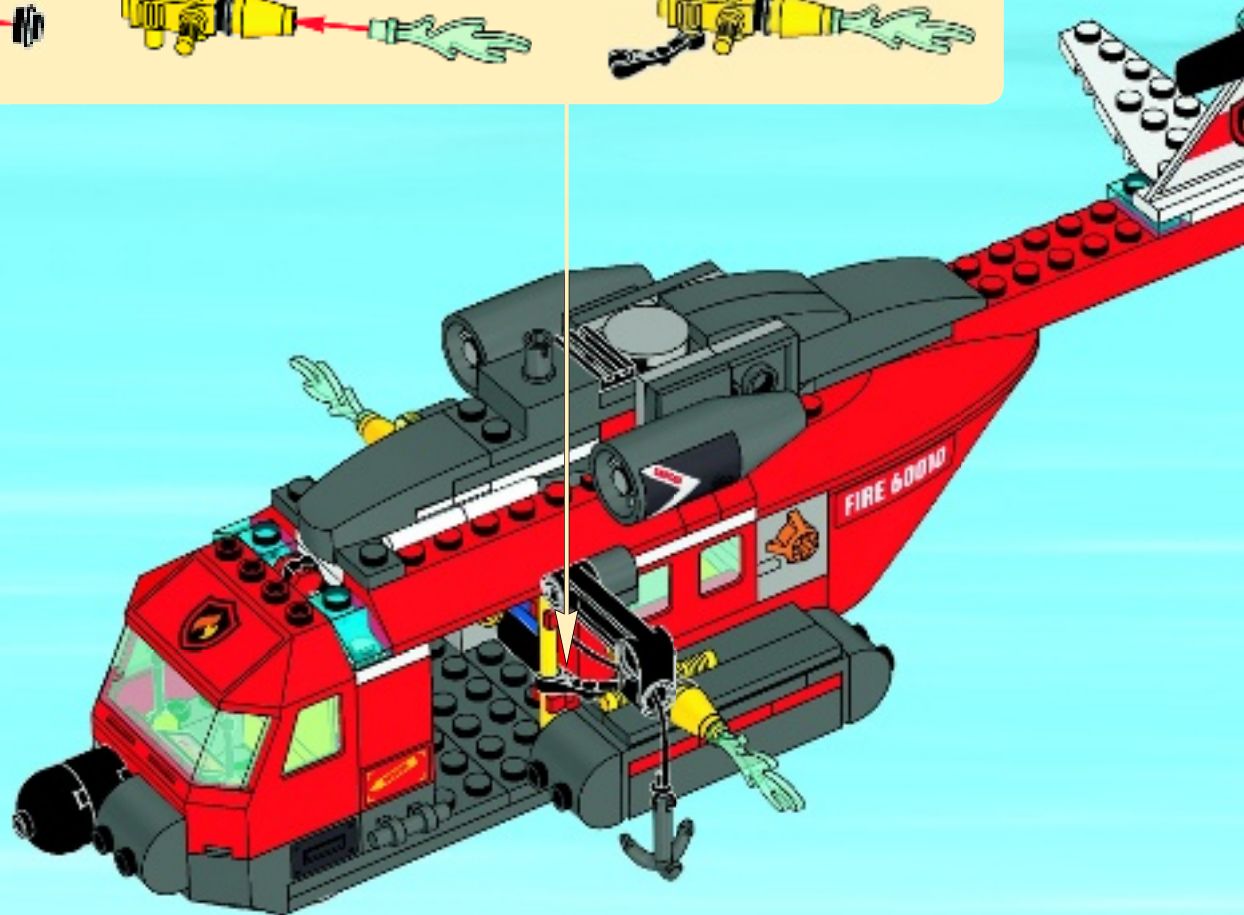



1





2

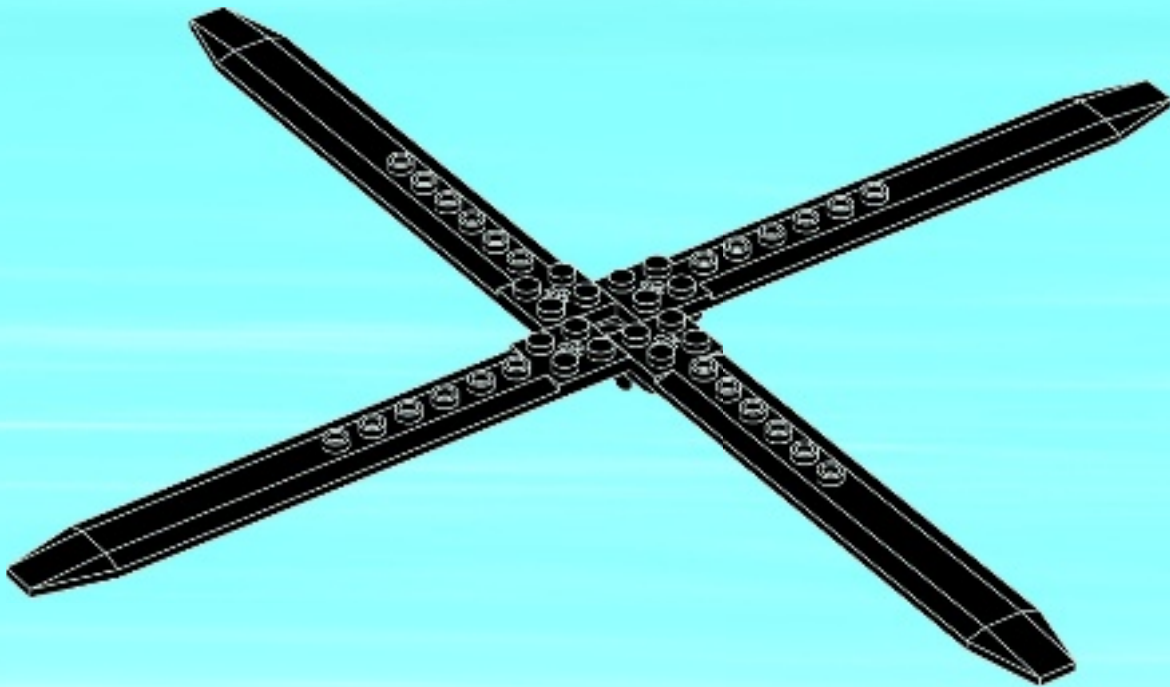
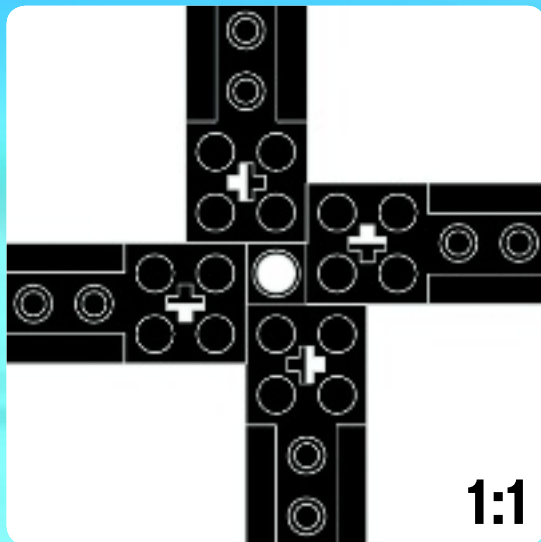



1x



1x

3

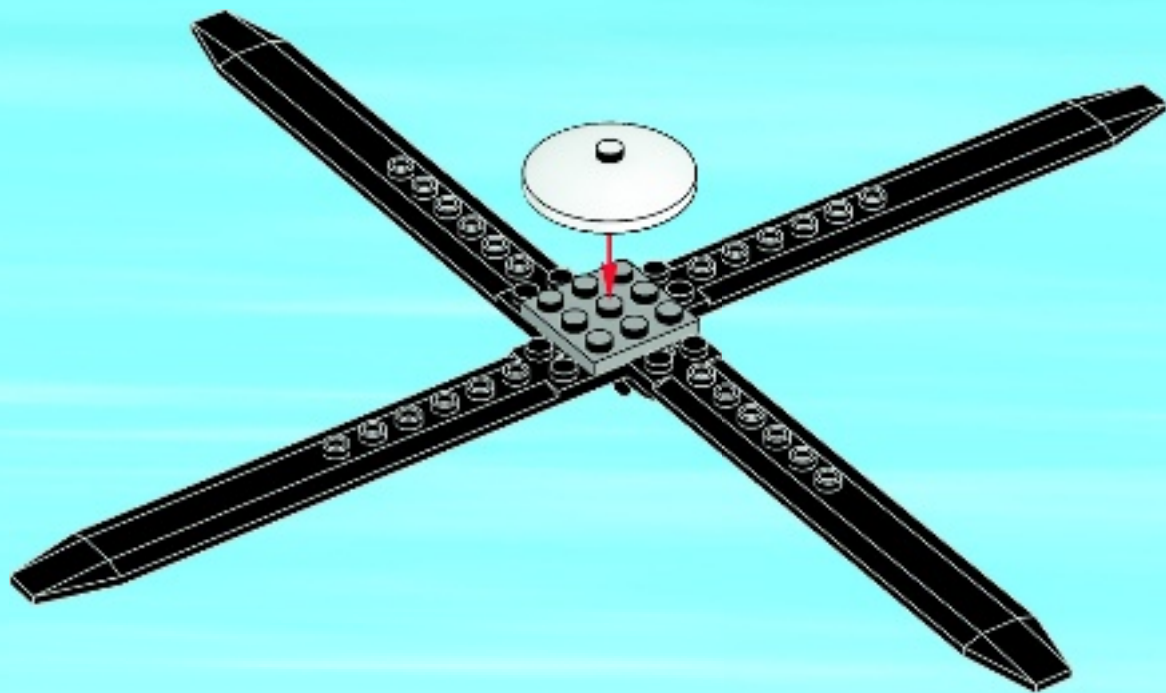

71

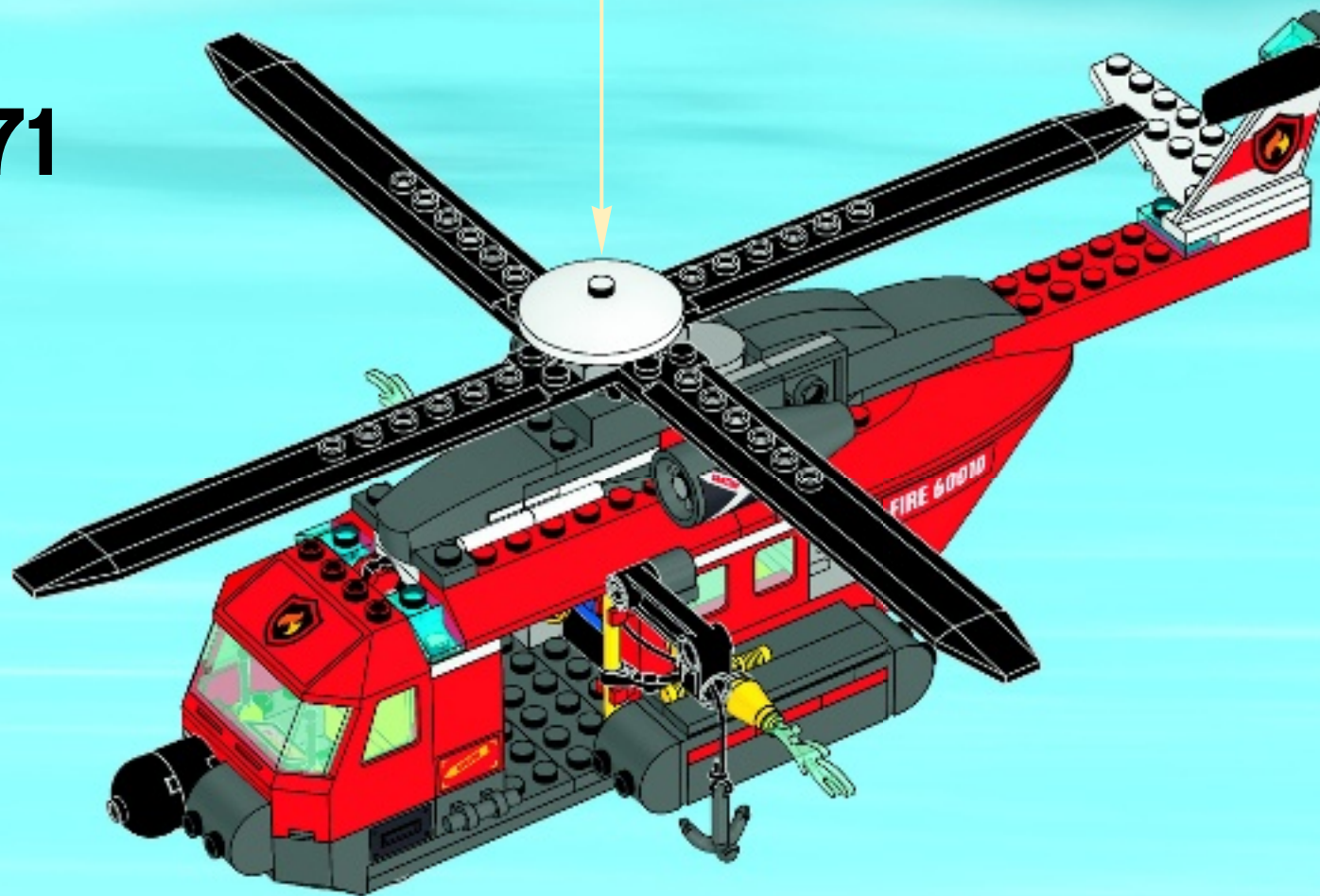

72

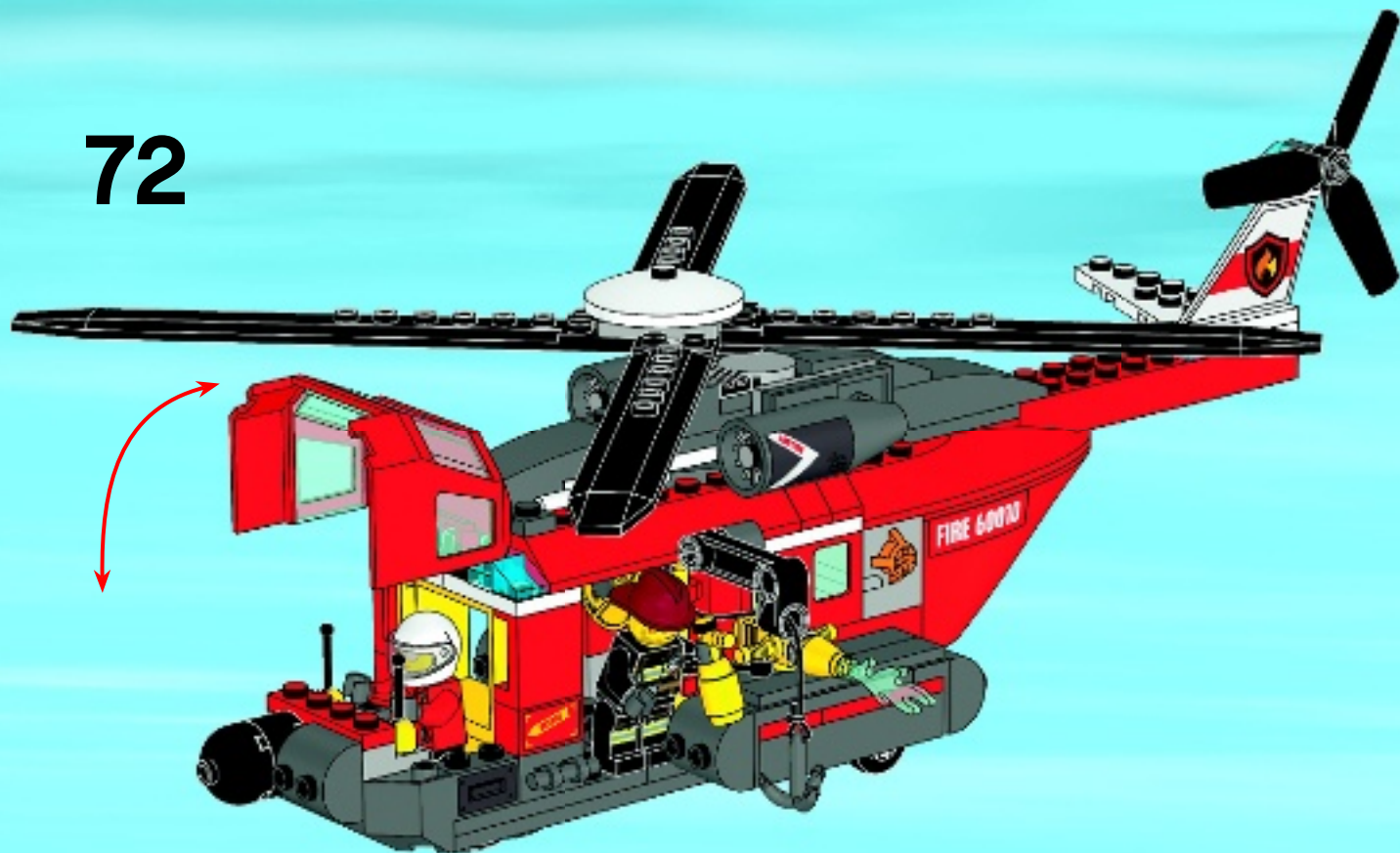

LEGO CITY



60004



60003



60002



60001



60000



CITY

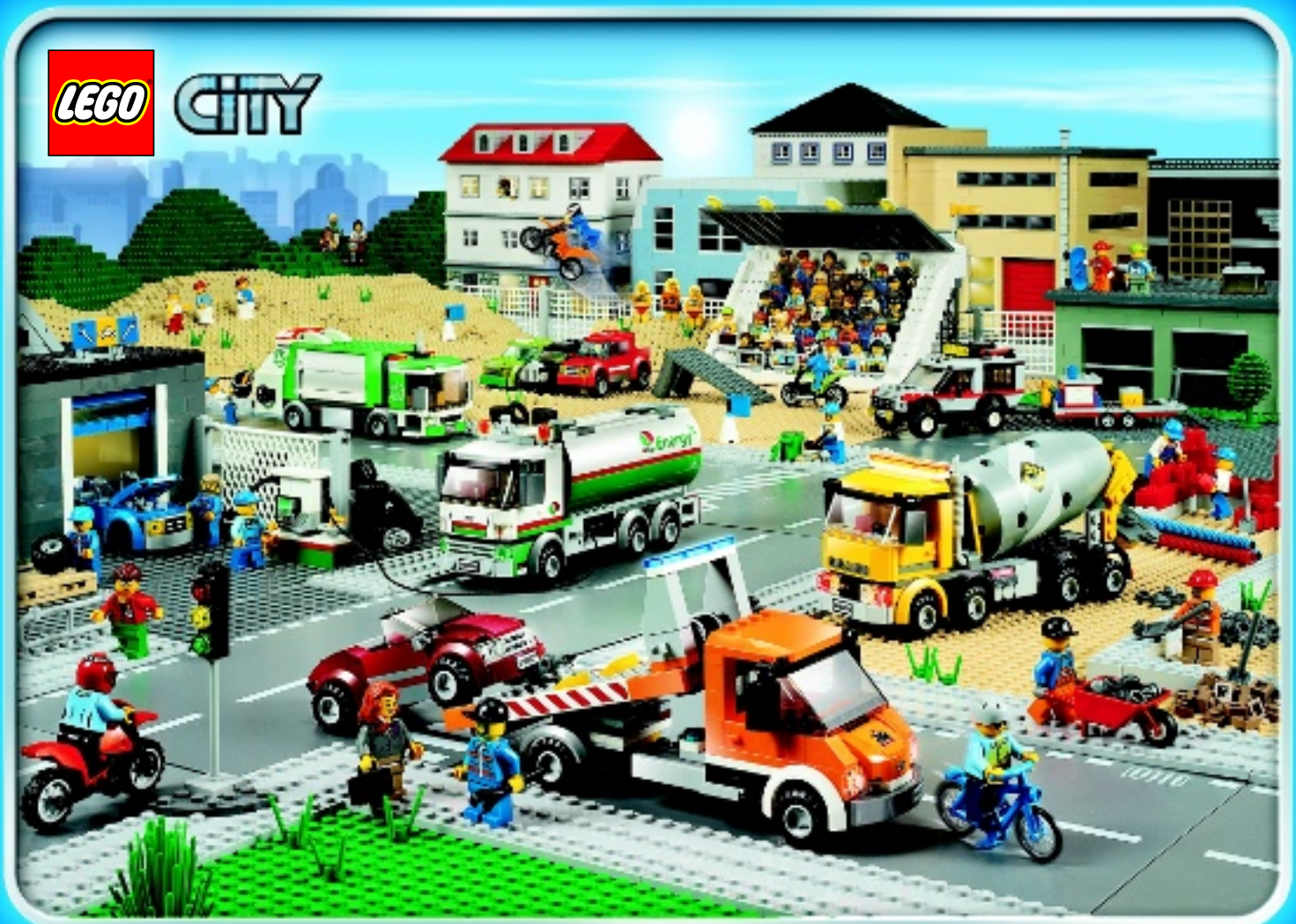

60016



60017



60018



4432



4433



2x
614301



2x
370101



2x
302301



4x
302101



1x
303201



1x
303401



2x
383901



2x
403201



1x
4256097



2x
396001



1x
4298609



2x
4549276



2x
462401



1x
234001



3x
300421



3x
300921

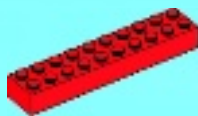

1x
4617857



2x
4563682



4x
4603263



2x
4550322



2x
302221



2x
403221



4x
6014616



1x
371021



2x
4570470



1x
4507686



2x
4567872



1x
6032091



1x
4565426

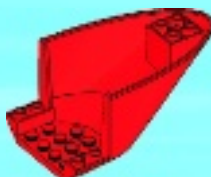

1x
4652486



1x
6025393



5x
4496366



2x
4143005



2x
300124



1x
306224



2x
4525464



1x
4520844



1x
4256320



2x
74156



2x
4193511



1x
4613418



1x
6022320



2x
4215263



1x
4297401



2x
300226



1x
4216660



1x
614326



1x
4548180



4x
241226



2x
614126



2x
4278359



1x
4613759



2x
6018684



1x
6018492



2x
4223247



2x
4516843



1x
4153044



1x
302926



4x
4527604



1x
247926



1x
4142731



1x
4667463



1x
4584350



1x
6019986



1x
4107783



1x
4121715



2x
403228



1x
4497943



1x
4163306

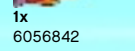

1x
6056842

5x
6023948

2x
4155537

1x
6025394

1x
4260426

3x
4244366

4x
4266417

1x
4650500

1x
4650879

2x
4261397

1x
4211383

4x
4211364

1x
6030500

1x
4211494

1x
6015347

2x
4560183

1x
4166618

4x
4211365

2x
4654577

1x
6052200

2x
4278273

1x
4657366

1x
4211373

2x
6018081

2x
4211825

1x
4211807

1x
4239373

1x
4211060

1x
4211103

2x
4211100

1x
4211099

2x
4211128

1x
4211111

5x
4211093

2x
6042955

1x
4210873

11x
4211065

4x
4210651

1x
4211002

2x
4211134

2x
4211067

3x
6019987

1x
4210763

4x
6048854

1x
4211079

2x
4596895

3x
4256495

1x
6005463

1x
4652462

1x
4581526

2x
4579639

1x
4560177

Customer Service
Kundenservice
Service Consommateurs
Servicio Al Consumidor

LEGO.com/service or dial

🇪🇸 🇩🇪 🇫🇷 🇮🇹 🇯🇵 🇮🇸 🇩🇰 🇸🇪
🇨🇦 🇩🇪 🇫🇷 🇮🇹 🇯🇵 🇮🇸 🇩🇰 🇸🇪
: 00800 5346 5555
: 1-800-422-5346

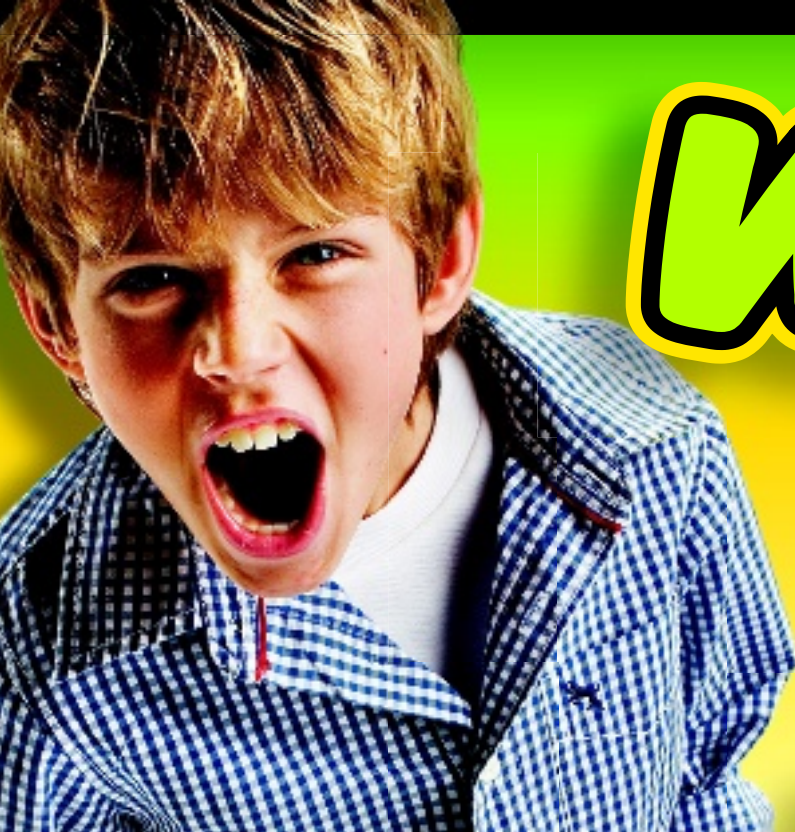

WIN!

Go to www.LEGOsurvey.com/product to fill out a survey for a chance to win a cool LEGO® Product.

No purchase necessary.

Open to all residents where not prohibited.



LEGO.com



www.LEGOsurvey.com/product

GEWINNE! WIN!

Nimm an der Umfrage auf www.LEGOsurvey.com/product teil und hab die Chance ein cooles LEGO® Produkt zu gewinnen!

Die Teilnahme am Gewinnspiel führt zu keinerlei Kaufverpflichtungen. Teilnahme in allen nicht ausgeschlossenen Ländern möglich.

Ga naar www.LEGOsurvey.com/product, vul een enquêteformulier in en maak kans op een cool LEGO® product.

Geen aankoopverplichting. Iedereen mag deelnemen, uitgezonderd ingezetenden van landen waar een enquêteverbod geldt.

GAGNE! 当てよう!

Visite www.LEGOsurvey.com/product pour répondre à un questionnaire et avoir une chance de gagner un produit LEGO® très cool!

Aucune obligation d'achat. Ouvert à tous les résidents des pays autorisés.

www.LEGOsurvey.com/product にアクセスして、アンケートにご記入ください。当選者にはレゴ®製品を差し上げます。

お買い上げの必要はありません

禁止されていない限り、すべての皆様にご利用いただけます。