



LEGENDS OF  
**CHIMA**™

70114



1



2

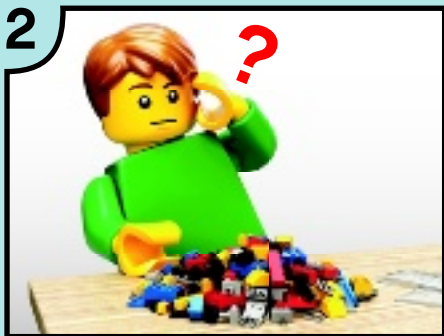

3



4





**1**

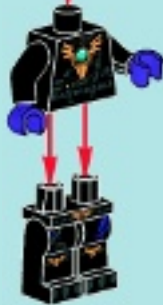

**2**

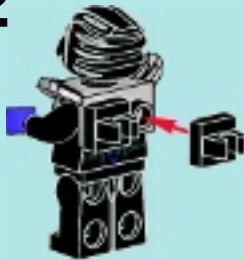

**3**



4



4

1



2



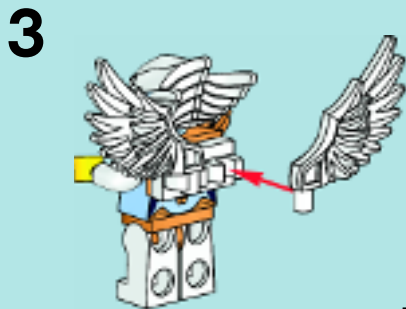
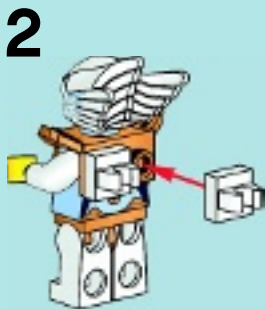

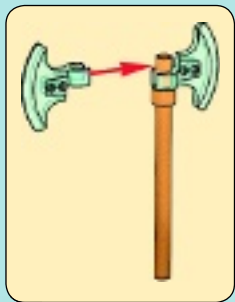

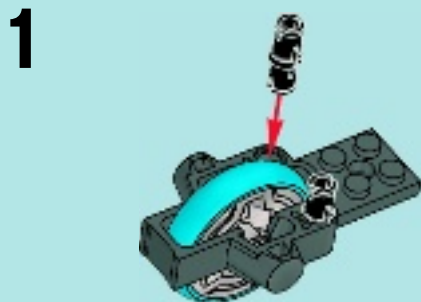

**2**





1x

3



8





4

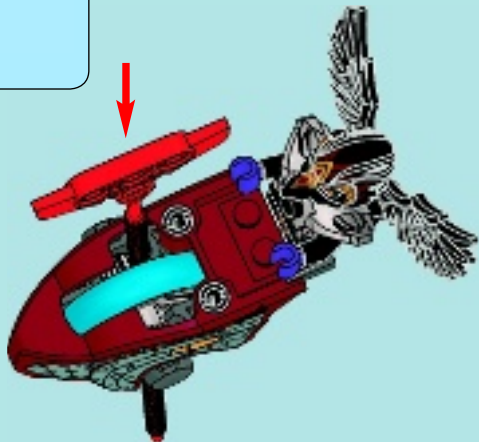





1



2



3

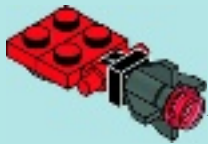

4

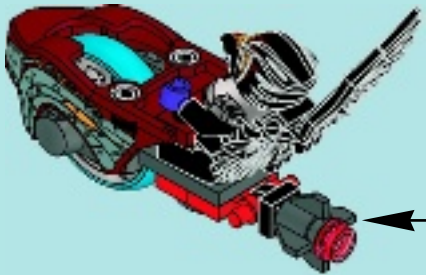

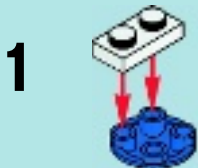

3

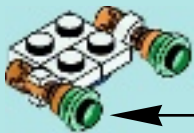

4

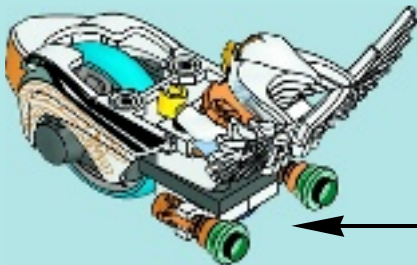

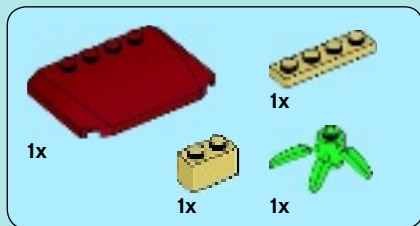

1



2

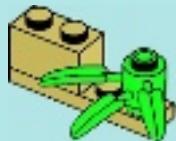

3



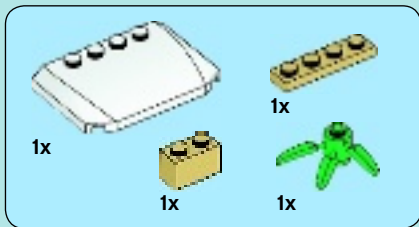

**1**



**2**

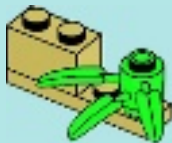

**3**



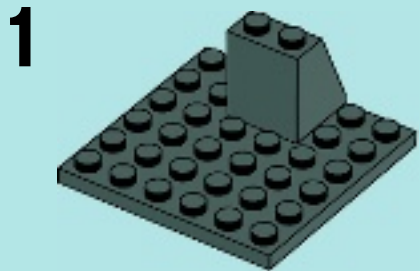

**2**

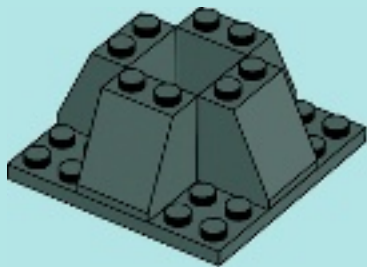



2x



2x

3

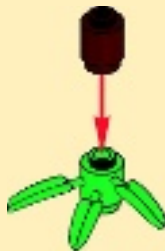
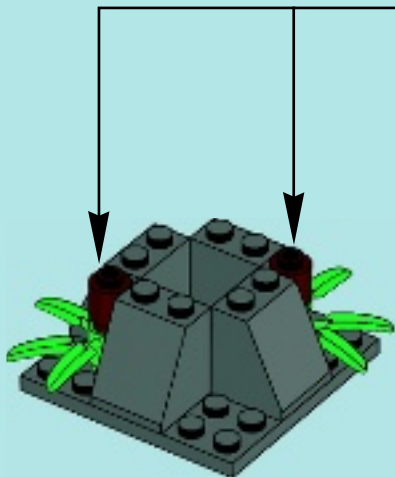

2x





1x

4

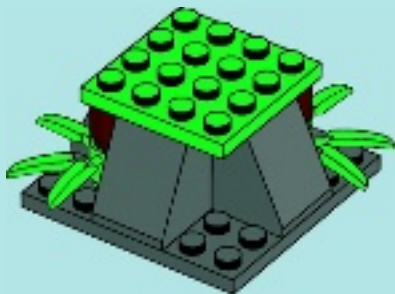



1x



2x

5



18



1x

6

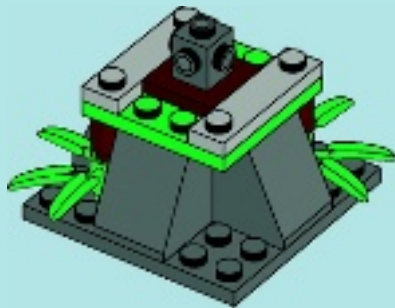



4x

7





2x



2x



4x



4x

# 8



1

2



2x

1



2



2x

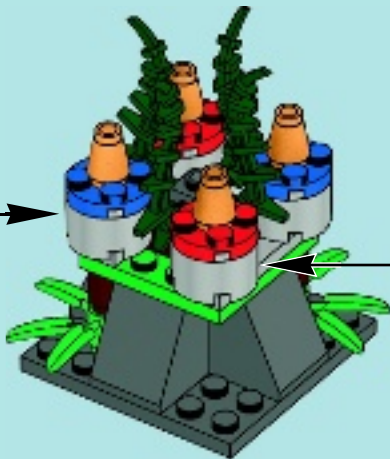

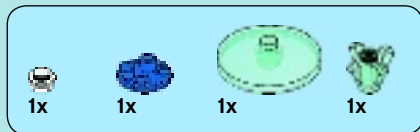

# 9

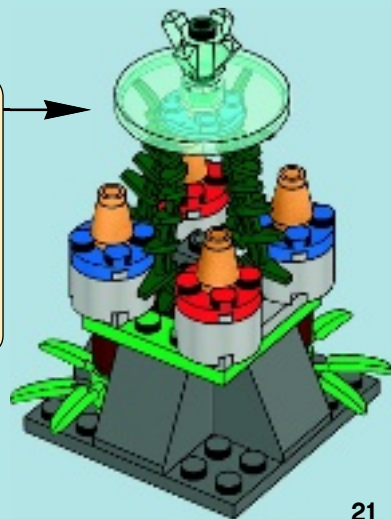
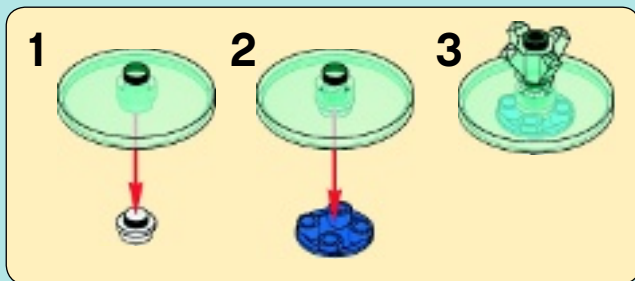



1x  
302301



2x  
6030716



2x  
4538353



1x  
614101



1x  
6023872



1x  
6022293



2x  
6018302



1x  
4261565



1x  
6024178



2x  
4109995



2x  
4113233



1x  
302321



1x  
4140585



2x  
403221



2x  
403223



2x  
4278276



3x  
6030718



1x  
6023799



1x  
6022560



1x  
6022505



1x  
6022288



1x  
6015884



2x  
6018304



4x  
4121715



1x  
4243821



4x  
4114348



2x  
3005741



1x  
4293877



2x  
4163917



13x  
6019570



2x  
4586291



4x  
4294148



1x  
4650155



1x  
6022662



2x  
4211183



1x  
4565394



4x  
4211526



2x  
4599498



1x  
4211628



1x  
4640844



1x  
4616840



1x  
4210700



4x  
4234534



1x  
4211134



1x  
4600437



1x  
4278274



1x  
4212352



2x  
6021353



1x  
6022550



1x  
6022500



4x  
4529247



2x  
4600270



3x  
6003147



1x  
6019984



1x  
6029660



1x  
6028415



1x  
6018012

**Customer Service**

**Kundenservice**

**Service Consommateurs**

**Servicio Al Consumidor**

**LEGO.com/service or dial**



**: 00800 5346 5555**

**: 1-800-422-5346**







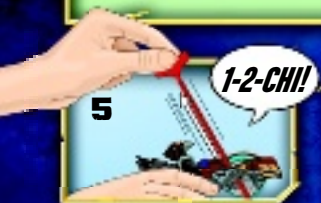

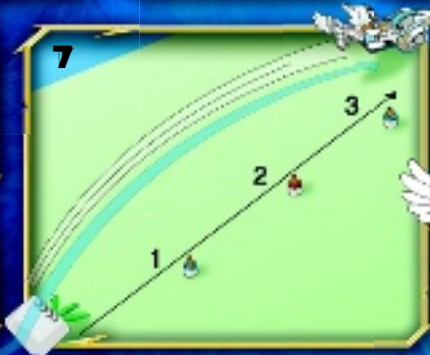

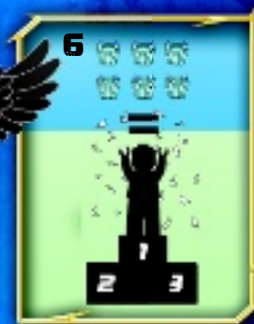



1. **Tribe** 2. **Battle Powers:**

- 👁️ Instinct 🏃 Speed 🛡️ Courage 🦍 Strength
3. **CHI Bonus:** When you flip a card, you may pay 1 CHI crystal to add the CHI bonus to any connected battle power.



1. **Stamm** 2. **Kräfte:**

- 👁️ Instinkt 🏃 Geschwindigkeit 🛡️ Mut 🦍 Stärke
3. **CHI-Bonus:** Wenn du eine Karte aufdeckst, kannst du einen CHI-Kristall zahlen, um den CHI-Bonus zu erhalten. Dieser Bonus gilt nur für eine mit dem CHI verbundene Kraft.



1. **Tribu** 2. **Pouvoirs:**

- 👁️ Instinct 🏃 Vitesse 🛡️ Courage 🦍 Force
3. **Bonus CHI :** Quand tu retournes une carte, tu peux ajouter des points Bonus à tout pouvoir relié au CHI, contre le don d'un cristal CHI.



1. **Tribù** 2. **Poteri :**

- 👁️ Istinto 🏃 Velocità 🛡️ Coraggio 🦍 Forza
3. **Bonus :** Quando scopri una carta, puoi pagare 1 cristallo CHI per aggiungere un CHI bonus al potere scelto per la battaglia.



1. **Stam** 2. **Krachten:**

- 👁️ Instinct 🏃 Snelheid 🛡️ Moed 🦍 Spierkracht
3. **CHI bonus:** Als je een kaart omdraait, mag je 1 CHI kristal betalen om de CHI bonus toe te voegen aan een daarmee verbonden kracht



1. **Tribu** 2. **Poderes de combate:**

- 👁️ Instinto 🏃 Velocidad 🛡️ Valentía 🦍 Fuerza
3. **Bonificación de CHI:** Al dar la vuelta a una carta, puedes pagar 1 cristal de CHI para asignar la bonificación de CHI a cualquier poder de combate conectado.



1. **Stamme** 2. **Kampevner:**

- 👁️ Instinkt 🏃 Hastighed 🛡️ Mod 🦍 Styrke
3. **CHI-bonus:** Når du vender et kort, kan du betale én CHI-krystal for at føje CHI-bonussen til en forbundet kampevne.



1. **Heimo** 2. **Taisteluvoimat:**

- 👁️ Vaisto 🏃 Nopeus 🛡️ Rohkeus 🦍 Voima
3. **CHI-bonus:** Kun käännät kortin, sinun on maksettava 1 CHI-kristalli lisätäksesi CHI-bonusen johonkin kytketyistä taisteluvoimista.



1. **Stam** 2. **Stridskrafter:**

- 👁️ Instinkt 🏃 Snabbhet 🛡️ Mod 🦍 Styrka
3. **CHI-bonus:** När du vänder på ett kort kan du betala 1 CHI-kristall för att addera CHI-bonusen till en av de anslutna stridskrafterna.



1. **Tribo** 2. **Poderes de combate:**

- 👁️ Instinto 🏃 Velocidade 🛡️ Coragem 🦍 Força
3. **Bónus CHI:** Quando viras uma carta, podes pagar 1 cristal CHI para acrescentares o bónus CHI a qualquer poder de combate associado.



1. **Φυλή** 2. **Πολεμικές Ικανότητες:**

- 👁️ Ενστικτό 🏃 Ταχύτητα 🛡️ Θάρρος 🦍 Δύναμη
3. **Έξτρα Βαθμίοι CHI:** Όταν γυρίζεις μια κάρτα, μπορείς να δώσεις 1 κρύσταλλο CHI για να προσθέσεις τους έξτρα βαθμούς CHI σε οποιαδήποτε πολεμική ικανότητα συνδέεται με αυτούς.



1. **種族**

2. **バトルパワー:** 🦍 本能 🏃 スピード 🛡️ 勇氣 🦍 強さ
3. **子のボーナス:** カードを取って表を向けた時に、子のクリスタルを1個使えば、子のボーナスの絵とつながっているバトルパワーに子のボーナスを追加できる。



1. **部落** 2. **战斗能量:**

- 👁️ 本能 🏃 速度 🛡️ 勇气 🦍 力量
3. **奖励真气:** 翻开卡片时，你可以消费一个真气水晶，将相应真气添加到任何相连的战斗能量中。



1. **족족 2. 배틀 파워:**  
 직감 스피드 용기 힘
3. **키보너스:** 카드한장을 뒤집고키 크리스탈 1개를 지불하면 관련된배틀 파워에키보너스를추가할수 있습니다.



1. **Klan 2. Боевые способности:**  
 Интуиция Скорость Храбрость Сила
3. **Чи-бонус:** Когда ты переворачиваешь карточку, ты можешь использовать 1 Чи-кристалл и получить возможность добавить Чи-бонус к любой соответствующей боевой способности.



1. **Plemię 2. Moce bitewne:**  
 Instynkt Szybkość Odwaga Siła
3. **Bonus CHI:** Gdy odkryjesz kartę, możesz zapłacić 1 kryształ CHI, aby dodać bonus CHI do dowolnej połączonej błyskawicą mocy bitewnej.



1. **Kmen 2. Bojové schopnosti:**  
 Instinkt Rychlost Odvaha Síla
3. **CHI bonus:** Když otočíš kartu, můžeš zaplatit 1 CHI krystal, a tím navýšit jednu z bojových schopností označených bleskem o CHI bonus.



1. **Kmeň 2. Bojové schopnosti:**  
 Instinkt Rýchlosť Odvaha Síla
3. **CHI bonus:** Keď otočíš kartu, môžeš zaplatiť 1 CHI kryštál, a tým pridať CHI bonus na všetky bojové sily zvýraznené s bleskom.



1. **Törzs 2. Harckészségek:**  
 Megézés Gyorsaság Bátorság Erő
3. **CHI bónusz:** Ha felútsz egy kártyát, bármelyik csatolt harckészséghez vásárolhatsz 1 CHI kristállyal CHI bónuszt.



1. **Клан 2. Бойові сили:**  
 Інстинкт Швидкість Хоробрість Міць
3. **Чи-бонус:** Коли ти перевертаєш картку, тобі може випасти 1 Чи-кристал ти можеш віддати 1 Чи-кристал і ти матимеш змогу додати Чи-бонус до будь-якої відповідної бойової сили.



1. **Pleme 2. Borbene moći:**  
 Instinkt Brzina Hrabrost Snaga
3. **CHI nagrada:** Kada okreneš kartu, možeš platiti 1 CHI kristal kako bi dodao CHI nagradu bilo kojoj borbenoj moći.



1. **Племе 2. Борбене моћи:**  
 Инстинкт Брзина Храброст Снага
3. **Чи бонус:** Када обрнеш картицу, мораш платити 1 чи кристал да би додао чи бонус својој борбеној моћи.



1. **Pleme 2. Војне моћи:**  
 Nagon Hitrost Pogum Moč
3. **Chi Bonus:** Ko obrneš karto, lahko plačaš 1 CHI kristal, da bi kateri koli povezani bojni moči dodal CHI bonus.



1. **Trib 2. Puteri de luptă:**  
 Instinct Viteză Curaj Putere
3. **Bonus CHI:** Când întorci o carte, poți plăti 1 cristal CHI pentru a adăuga bonusul CHI la oricare putere de luptă asociată.



1. **Племе 2. Бойни сили:**  
 Инстинкт Скорост Кураж Сила
3. **CHI бонус:** Когато обърнете карта, можете да платите 1 кристал CHI, за да добавите бонуса CHI към която и да е свързана бойна сила.



1. **Çifts 2. Çiņas spēki:**  
 Instinkts Atrums Drosmē Izturība
3. **Çi bonus.** Paņemot kārti, vari samaksāt vienu 1 Çi kristālu, lai pievienotu Çi bonusu jebkuram saistītajam çiņas spēkam.



1. **Höim 2. Lahinguvõimed:**  
 Instinkt Kiirus Vaprus Tugevus
3. **CHI boonus:** Kaarti ümber pöörates võid mis tahes lahinguvõimele CHI boonuse lisamiseks maksta ühe CHI kristalli.



1. **Gentis 2. Kovos galios:**  
 Instinktas Greitis Draša Jėga
3. **Çi premija:** Apvertęs kortelę gali sumokėti 1 Çi kristalą, kad pridėtum Çi premiją prie bet kurios kovos galios.



1. **Kabile 2. Savaş güçleri:**  
 İlgüdü Hız Cesaret Güç
3. **CHI bonusu:** Bir kart çevirdiğinizde, bağlı herhangi bir savaş gücüne CHI bonusu eklemek için 1 CHI kristali ödeyebilirsiniz.



## HOW TO PLAY

1. Compete with your Speedorz. 2. The winner flips a card and chooses a battle power. 3. The other player flips a card. Compare the chosen power on both cards. 4. The player with the highest power wins 2 CHI crystals. 5. The first player to get 6 CHI crystals wins the battle.

CHI power: When you flip a card, you may pay 1 CHI crystal to add the CHI bonus to any connected battle power.



## SPIELANLEITUNG

1. Tretet mit euren Speedorz im Wettkampf gegeneinander an. 2. Der Gewinner deckt eine Karte auf und wählt eine Kraft aus. 3. Der andere Spieler deckt eine Karte auf. Vergleicht die gewählten Kräfte der beiden Karten. 4. Der Spieler mit der höheren Kraft gewinnt 2 CHI-Kristalle. 5. Gewonnen hat der Spieler, der als Erster 6 Kristalle gesammelt hat.

CHI-Bonus: Wenn du eine Karte aufdeckst, kannst du einen CHI-Kristall zahlen, um den CHI-Bonus zu erhalten. Dieser Bonus gilt nur für eine mit dem CHI verbundene Kraft.



## COMMENT JOUER

1. Relève le défi Speedorz. 2. Le gagnant retourne une carte et choisit un pouvoir pour combattre. 3. L'autre joueur retourne une carte. Tu peux maintenant comparer le pouvoir choisi sur les deux cartes. 4. Le joueur avec le pouvoir le plus élevé gagne deux cristaux CHI. 5. Le premier joueur à obtenir 6 cristaux CHI gagne le combat.

Bonus CHI : Quand tu retournes une carte, tu peux ajouter des points Bonus à tout pouvoir relié au CHI, contre le don d'un cristal CHI.



## REGOLE DEL GIOCO

1. Sfidatevi con gli Speedorz. 2. Il vincitore scopre una carta e sceglie un potere. 3. L'altro giocatore scopre una carta. Confrontate il potere scelto su entrambe le carte. 4. Il giocatore con il potere più alto vince 2 cristalli CHI. 5. Il primo giocatore che conquista 6 cristalli CHI vince la battaglia.

Bonus CHI: Quando scopri una carta, puoi pagare 1 cristallo CHI per aggiungere un CHI bonus al potere scelto per la battaglia.



## ZO SPEEL JE HET SPEL

1. Hou een wedstrijd met je Speedorz. 2. De winnaar draait een kaart om en kiest een kracht. 3. Dan draait de andere speler een kaart om. Vergelijk de gekozen kracht van de 2 kaarten. 4. De speler met de hoogste kracht wint 2 CHI kristallen. 5. De speler die als eerste 6 CHI kristallen verzamelt, wint het gevecht.

CHI bonus: Als je een kaart omdraait, mag je 1 CHI kristal betalen om de CHI bonus toe te voegen aan een daarmee verbonden kracht.



## CÓMO SE JUEGA

1. Compíte con tu Speedorz. 2. El ganador da la vuelta a una carta y elige un poder de combate. 3. El otro jugador da la vuelta a una carta. Ambas cartas se comparan en relación con el poder elegido. 4. El jugador que posea más poder gana 2 cristales de CHI. 5. El primer jugador en conseguir 6 cristales de CHI gana el combate.

Bonificación de CHI: Al dar la vuelta a una carta, puedes pagar 1 cristal de CHI para asignar la bonificación de CHI a cualquier poder de combate conectado.



## SÅDAN SPILLER DU

1. Konkurrer med jeres Speedorz. 2. Vinderen vender et kort og vælger en kampevne. 3. Den anden spiller vender et kort. Sammenlign den valgte evne på de to kort. 4. Spilleren med det højeste tal vinder to CHI-krystaller. 5. Den første spiller, der får seks CHI-krystaller, vinder kampen.

CHI-bonus: Når du vender et kort, kan du betale én CHI-kristal for at føje CHI-bonusen til en forbundet kampevne.



## PELIOHJEET

1. Kilpaile Speedorzisi kanssa. 2. Voittaja kääntää kortin ja valitsee taisteluvoiman. 3. Muut pelaajat kääntävät kortin. Vertaa molempien korttien valittua voimaa. 4. Pelaaja, jonka voima on suurempi, voittaa 2 CHI-kristallia. 5. Taistelun voittaa ensimmäisenä 6 CHI-kristallia kerännyt pelaaja.

CHI-bonus: Kun käännät kortin, sinun on maksettava 1 CHI-kristalli lisätäksesi CHI-bonusen johonkin kytketyistä taisteluvoimista.



## SÅ HÄR GÅR DET TILL

1. Tävla med era Speedorz. 2. Vinnaren vänder på ett kort och väljer en stridskraft. 3. Den andra spelaren vänder på ett kort. Jämför den valda stridskraften på båda korten. 4. Spelaren med högst kraft vinner 2 CHI-kristaller. 5. Den första spelare som får 6 CHI-kristaller vinner striden.

CHI-bonus: När du vänder på ett kort kan du betala 1 CHI-kristall för att addera CHI-bonusen till en av de anslutna stridskrafterna.



## COMO JOGAR

1. Compete com o teu Speedorz. 2. O vencedor vira uma carta e escolhe um poder de combate. 3. O outro jogador vira uma carta. Compara o poder escolhido em ambas as cartas. 4. O jogador com o poder mais elevado ganha 2 cristais CHI. 5. O primeiro jogador a obter 6 cristais CHI ganha o combate.

Bonus CHI: Quando viras uma carta, podes pagar 1 cristal CHI para acrescentares o bonus CHI a qualquer poder de combate associado.



## ΠΩΣ ΠΑΙΖΕΤΑΙ

1. Ξεκινήστε την αναμέτρηση με τα Speedorz σας. 2. Ο νικητής γυρίζει μια κάρτα και διαλέγει πολεμική ικανότητα. 3. Ο άλλος παίκτης γυρίζει μια κάρτα. Συγκρίνετε την ικανότητα που διαλέξατε στις δύο κάρτες. 4. Ο παίκτης με τη μεγαλύτερη ικανότητα κερδίζει 2 κρυστάλλους CHI. 5. Ο πρώτος παίκτης που συγκεντρώνει 6 κρυστάλλους CHI κερδίζει τη μάχη. Έξτρα Βαθμίοι CHI: Όταν γυρίσει μια κάρτα, μπορείς να δώσεις 1 κρυστάλλο CHI για να προσθέσεις τους έξτρα βαθμούς CHI σε οποιαδήποτε πολεμική ικανότητα συνδέεται με αυτούς.



## 遊び方

1.スピードーズで勝負する。2.勝者はカードを1枚取って表を向ける。そして、バトルパワーを選ぶ。3.相手もカードを1枚取って表を向ける。お互いのカードの選ばれたバトルパワーを比べる。4.パワーが高い方がチのクリスタルを2個ゲットできる。5.先にチのクリスタルを6個手に入れた方が勝者となる。チのボーナス: カードを取って表を向けた時に、チのクリスタルを1個使えば、チのボーナスの絵とつながっているバトルパワーにチのボーナスを追加できる。



## 玩法

1. 迎接挑战。2. 赢家翻开一张卡片, 选择战斗能量。3. 另一名玩家也翻开一张卡片。比较两张卡片上的能量。4. 卡片能量最高的玩家可以赢得两个真气水晶。5. 首先积累到6个真气水晶的玩家赢得战斗。奖励真气: 翻开卡片时, 你可以消费一个真气水晶, 将相应真气添加到任何相连的战斗能量中。



## 플레이 방법

1. 먼저 스피드 게임 배틀을 진행해 주세요. 2. 이긴 쪽이 카드 한 장을 뒤집어 배틀 파워를 선택 합니다. 3. 상대방이 카드 한 장을 뒤집어 각자의 카드에서 선택한 배틀 파워 수치를 비교 합니다. 4. 높은 파워 수치가 나온 쪽이 키 크리스탈 2개를 획득 합니다. 5. 키 크리스탈 6개를 먼저 획득한 쪽이 배틀에서 승리하게 됩니다. 키 보너스: 카드 한 장을 뒤집을 때에, 키 크리스탈 1개를 먼저 지불하면, 선택한 배틀 파워에 키 보너스를 추가할 수 있습니다.



## ПРАВИЛА ИГРЫ

1. Сразитесь в прохождении препятствий на Чимациклах. 2. Победитель переворачивает карточку и называет любую боевую способность. 3. Другой игрок должен перевернуть свою карточку. Сравните выбранные победителем способности на ваших карточках. 4. Игрок с самой сильной способностью получает Чи-кристалл. 5. Побеждает игрок, который первым получит 6 Чи-кристаллов. Чи-бонус: когда ты переворачиваешь карточку, ты можешь использовать 1 Чи-кристалл и получить возможность прибавить баллы к той боевой способности, которая соединена молнией с Чи-бонусом на твоей карточке.



## ZASADY GRY

1. Walcz swoimi pojazdami Speedorz. 2. Zwycięzca odkrywa kartę i wybiera moc bitewną. 3. Drugi gracz odkrywa kartę. Porównaj wybraną moc na obu kartach. 4. Gracz z najwyższą mocą zdobywa 2 kryształy CHI. 5. Bitwę wygrywa gracz, który jako pierwszy zdobędzie 6 kryształów CHI. Bonus CHI: Gdy odkryjesz kartę, możesz zapłacić 1 kryształ CHI, aby dodać bonus CHI do dowolnej połączony błyskawicą mocy bitewnej.



## PRÁVIDLA HRY

1. Pušť se do boje se svým Speedorzem. 2. Vítěz otočí kartu a zvolí si bojovou schopnost. 3. Druhý hráč otočí kartu. Hráči si porovnají vybranou bojovou schopnost na svých kartách. 4. Hráč s vyšší bojovou schopností vyhrává 2 CHI krystaly. 5. Hru vyhrává hráč, který jako první nasbírá 6 CHI krystalů. CHI bonus: Když otočíš kartu, můžeš zaplatit 1 CHI krystal, a tím navýšit jednu z bojových schopností označených bleskem o CHI bonus.



## PRÁVIDLÁ HRY

1. Pušť sa do boja so svojím Speedorz. 2. Víťaz otočí kartu a zvolí si bojovú schopnosť. 3. Druhý hráč otočí kartu. Porovnajte zvolenú bojovú schopnosť na oboch kartách. 4. Hráč s vyššou bojovou schopnosťou vyhráva 2 CHI kryštály. 5. Hru vyhráva hráč, ktorý ako prvý nazbiera 6 CHI kryštálov. CHI bonus: Keď otočíš kartu, môžeš zaplatiť 1 CHI kryštál, a tým pridať CHI bonus na všetky bojové sily zvýraznené s bleskom.



## JÁTEKSZABÁLY

1. Versenyezz a Speedorzoddal. 2. A nyertes felüt egy kártyát és harcokészséget választ. 3. A másik játékos felüt egy kártyát. Hasonlítsd össze mindkét kártyán a kiválasztott harcokészség erejét. 4. A legerősebb lap 2 CHI kristályt nyer. 5. Akinek először lesz 6 CHI kristálya, az nyer. CHI bónusz: Ha felütsz egy kártyát, bármelyik csatolt harcokészséghez vásárolhatsz 1 CHI kristállyal CHI bónuszt.



## ПРАВИЛА ГРИ

1. Розіграйте завдання. 2. Переможець перевертає картку та обирає бойову силу. 3. Інший гравець перевертає картку. Порівняйте обрані сили на обох картках. 4. Гравець з максимальною силою отримує 2 Чи-кристали. 5. Перемагає гравець, який першим отримує 6 Чи-кристалів. Чи-бонус: Коли ти перевертаєш картку, тобі може випасти 1 Чи-кристал ти можеш віддати 1 Чи-кристал і ти матимеш змогу додати Чи-бонус до будь-якої відповідної бойової сили.



### KAKO SE IGRA

1. Odigraj izazov. 2. Pobjednik okreće kartu i odabire borbenu moć. 3. Drugi igrač okreće kartu. Usporedite odabrane moći na obje karte. 4. Igrač s najvećom moći osvaja 2 CHI kristala. 5. Prvi igrač koji osvoji 6 CHI kristala pobjeđuje u bitci. CHI nagrada: Kada okreneš kartu, možeš platiti 1 CHI kristal kako bi dodao CHI nagradu bilo kojoj borbenoj moći.



### KAKO IGRATI

1. Odiđajte takmičenje. 2. Pobjednik obrne karticu i bira borbenu moć. 3. Drugi igrač obrne karticu. Uredite izabranu moć na obe kartice. 4. Igrač sa najvećom moći osvaja 2 chi kristala. 5. Prvi igrač koji sakupi 6 chi kristala je pobjednik. Chi bonus: Kada obrneš karticu, moraš platiti 1 chi kristal da bi dodao chi bonus svojoj borbenoj moći.



### KAKO IGRATI

1. Tekmuj s svojim Speedorzom. 2. Zmagovalec obrne karto in si izbere bojno moć. 3. Drugi igralec obrne karto. Primerjajta izbrano bojno moć na kartah. 4. Igralec z večjo močjo dobi 2 CHI kristala. 5. Zmaga prvi igralec, ki dobi 6 CHI kristalov. CHI bonus: Ko obrneš karto, lahko plačaš 1 CHI kristal, da bi kateri koli povezani bojni moći dodal CHI bonus.



### CUM SE JOACĂ

1. Intră în competiție cu Speedorz-ul tău. 2. Câștigătorul întoarce o carte și alege o putere de luptă. 3. Celălalt jucător întoarce o carte. Comparați puterea aleasă pe cele două cărți. 4. Jucătorul cu cea mai mare putere câștigă 2 cristale CHI. 5. Primul jucător care obține 6 cristale CHI câștigă lupta. Bonus CHI: Când întorci o carte, poți plăti 1 cristal CHI pentru a adăuga bonusul CHI la oricare putere de luptă asociată.



### КАК СЕ ИГРАЕ

1. Състезавайте се със Speedorz. 2. Победителят обръща карта и избира бойна сила. 3. Другият играч обръща карта. Сравнете избраната сила и на двете карти. 4. Играчът с най-висока сила печели 2 кристала CHI. 5. Първият играч, който събере 6 кристала CHI, печели играта. CHI бонус: Когато обърнете карта, можете да платите 1 кристал CHI, за да добавите бонуса CHI към която и да е свързана бойна сила.



### KĀ SPĒLĒT

1. Sacentieties ar saviem Speedorz varoniem. 2. Uzvarētājs paceļ kārti un izvēlas cīņas spēku. 3. Otrs spēlētājs paceļ kārti. Salīdziniet izvēlēto spēku abās kārtīs. 4. Spēlētājs, kura spēks ir lielāks, iegūst 2 čī kristālus. 5. Spēlētājs, kurš pirmais iegūst 6 čī kristālus, ir uzvarējis cīņā. Čī bonuss. Paceļot kārti, vari samaksāt vienu 1 Čī kristālu, lai pievienotu Čī bonusu jebkuram saistītajam cīņas spēkam.



### MÄNGU KÄIK

1. Võistelge oma Speedorziga. 2. Võitja pöörab kaardi ümber ja valib lahinguvõime. 3. Teine mängija pöörab kaardi ümber. Võrrelge valitud võimet mõlemal kaardil. 4. Suurema võimega mängija saab kaks CHI kristalli. 5. Lahingu võidab mängija, kes kogub esimesena kuus CHI kristalli. CHI boonus: Kaarti ümber pöörates võid mis tahes lahinguvõimele CHI boonuse lisamiseks maksta ühe CHI kristalli.



### KAIP ŽAISTI

1. Rungtyniauk su savo Speedorz. 2. Laimėtojas apverčia kortelę ir pasirenka kovos galia. 3. Kitas žaidėjas apverčia kortelę. Palygink abiejose kortelėse nurodytas kovos galias. 4. Didesnę kovos galia turintis žaidėjas laimi du Či kristalus. 5. Kova laimi pirmasis 6 Či kristalus surinkęs žaidėjas. Či premija: Apvertęs kortelę gali sumokėti 1 Či kristalą, kad pridėtum Či premiją prie bet kurios kovos galios.



### NASIL OYNANIR

1. Speedorz ile yarışın. 2. Kazanan bir kart açar ve bir savaş gücü seçer. 3. Rakip oyuncu bir kart açar. Her iki kartta seçilen gücü karşılaştırın. 4. En yüksek güce sahip oyuncu 2 CHI kristali kazanır. 5. 6 CHI kristali kazanan ilk oyuncu savaş kazanır. CHI bonusu: Bir kart açıldığında, bagli herhangi bir savaş gücüne CHI bonusu eklemek için 1 CHI kristali ödeyebilirsiniz.



LEGO

LEGENDS OF  
CHIMA™

GORZAN



70109 70008

LAVAL



70115  
70010 70005

DEATH



70111

CRUGER

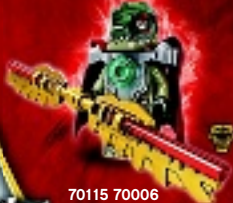

70115 70006  
70014 70010

RAWSON



70114 70006

SKINNET



70107

CRUG



70002  
70014 70112

WARRAN



70011 70009

GOV



70114  
70009 70003

LAGBHYA



70108 70010



LEGO.com/chima



**SCAN THE QR CODE**

SCANNE DEN QR-CODE · SCANNE LE QR CODE  
CAPTURA EL CÒDIGU QR · FAZ SCAN DO CÒDIGU QR  
OL VASD BE A QR KÓDÓT



70114



# club™

## Free\*! Gratuit!

\* Paid subscription in Australia and New Zealand.  
Abonnement payant en Australie et Nouvelle-Zélande



© 2013 The LEGO Group.



[LEGO.com/club](http://LEGO.com/club)



# WIN!

Go to [www.LEGOsurvey.com/product](http://www.LEGOsurvey.com/product) to fill out a survey for a chance to win a cool LEGO® Product.

No purchase necessary.

Open to all residents where not prohibited.



## [www.LEGOsurvey.com/product](http://www.LEGOsurvey.com/product)

### GEWINNE!

Nimm an der Umfrage auf [www.LEGOsurvey.com/product](http://www.LEGOsurvey.com/product) teil und hab die Chance ein cooles LEGO® Produkt zu gewinnen!

Die Teilnahme am Gewinnspiel führt zu keinerlei Kaufverpflichtungen. Teilnahme in allen nicht ausgeschlossenen Ländern möglich.

### WIN!

Ga naar [www.LEGOsurvey.com/product](http://www.LEGOsurvey.com/product), vul een enquêteformulier in en maak kans op een

cool LEGO® product. Geen aankoopverplichting. Iedereen mag deelnemen, uitgezonderd ingezetenden van landen waar een enquêteverbod geldt.

### GAGNE !

Visite [www.LEGOsurvey.com/product](http://www.LEGOsurvey.com/product) pour répondre à un questionnaire et avoir une chance de gagner un produit LEGO® très cool !

Aucune obligation d'achat. Ouvert à tous les résidents des pays autorisés.

### 当てよう!

[www.LEGOsurvey.com/product](http://www.LEGOsurvey.com/product) にアクセスして、アンケートにご記入ください。当選者にはレゴ®製品を差し上げます。

お買い上げの必要はありません。禁止されていない限り、すべての皆様にご利用いただけます。



6055440

LEGO, the LEGO logo and LEGENDS OF CHIMA are trademarks of the LEGO Group.  
©2013 The LEGO Group.