

60022



# CITY



1



2



3



4



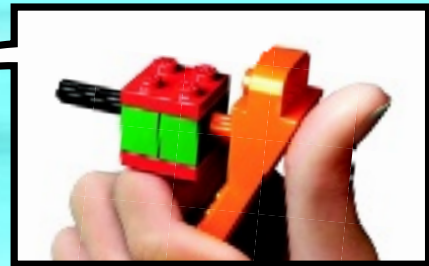
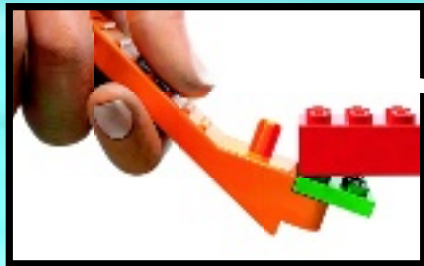

[LEGO.com/brickseparator](https://LEGO.com/brickseparator)

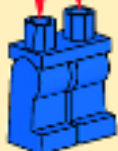





1x

1



2x

2

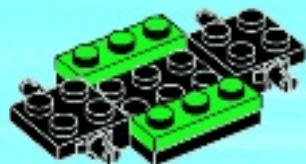



2x



1x

3

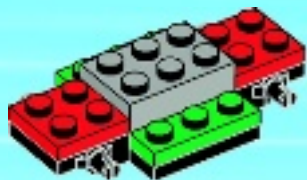

2x



2x

4





2x

5



1x



1x

6





1x

7



2x



1x



1x

8

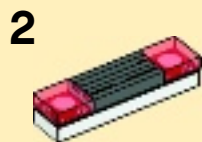
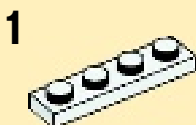



1x

9



1x

10

1

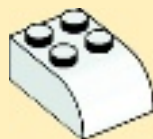

2

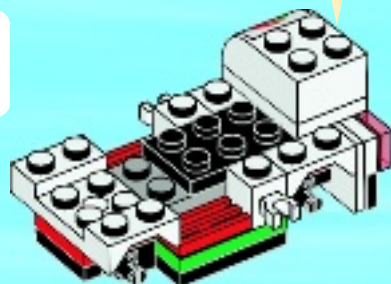





1x

11

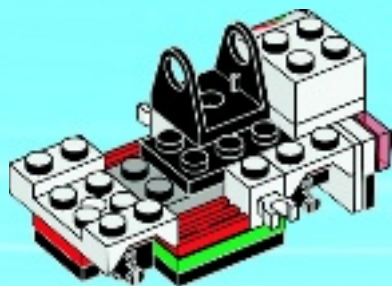

1x

12

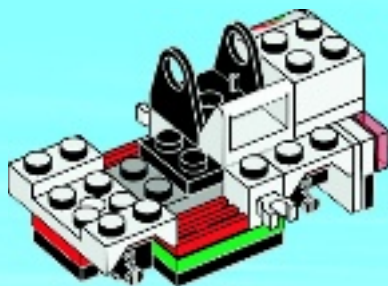



1x

13

1

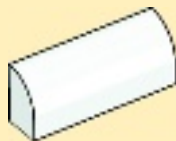

2





1x



1x

# 14

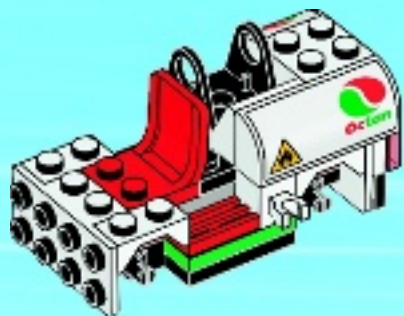

1x

# 15

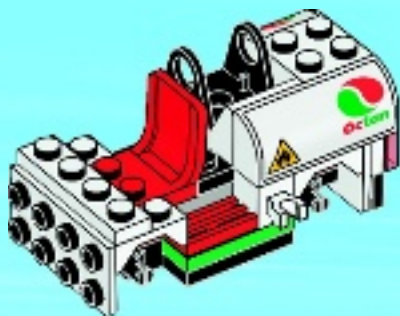

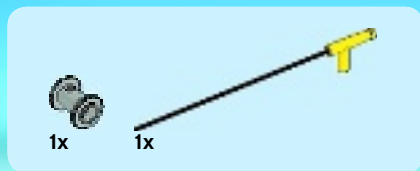

# 16



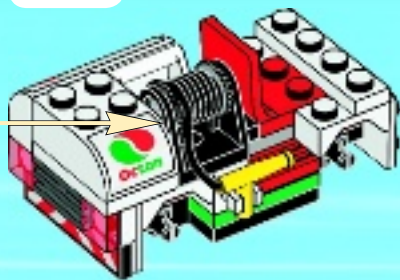

17

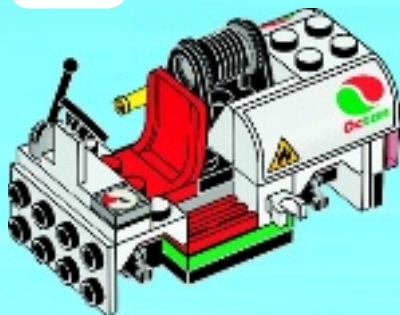





2x



1x



1x

# 18

1

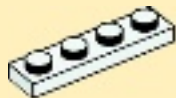

2

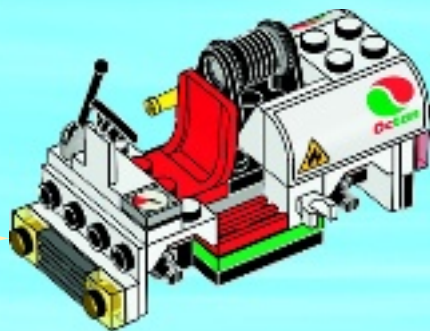
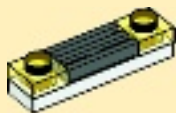



1x

# 19

1

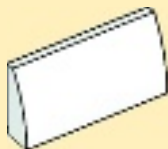

2

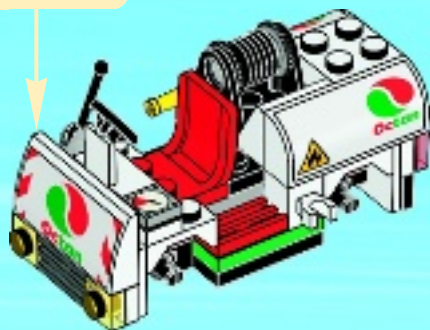



4x



4x

# 20

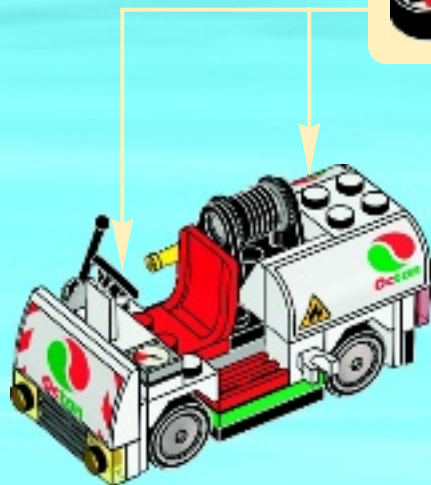
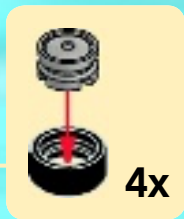

1x

# 21





1x

**1**





2x

2

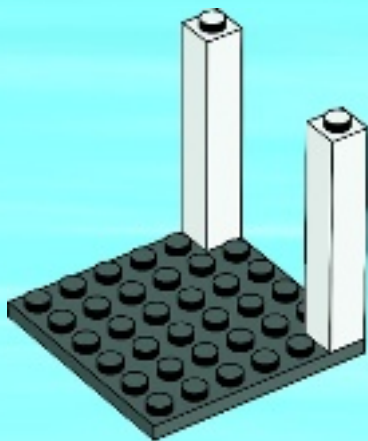

1x

3

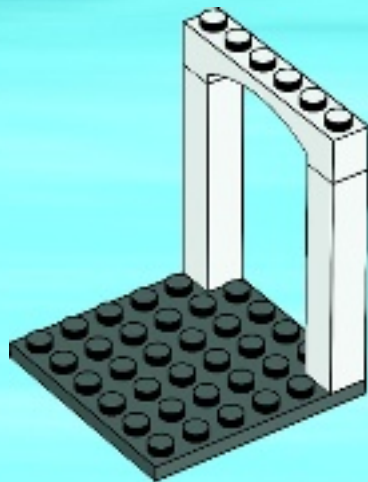





1x

4



1x

5

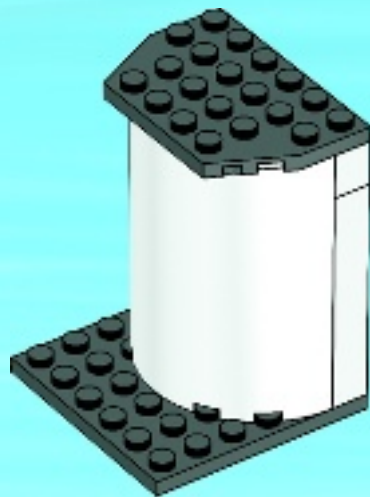

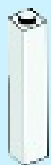

2x

6





1x

7

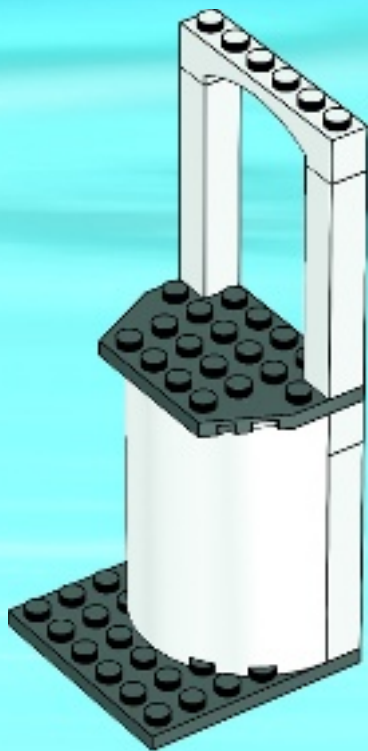



8









2x

9





2x



2x

10



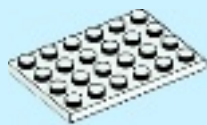

1x

1





1x



1x

2

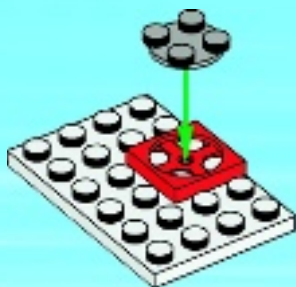



1x

3



2x

4

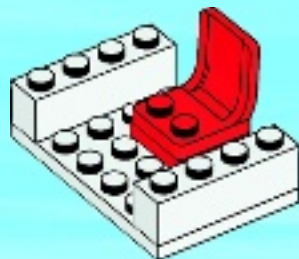



2x

5

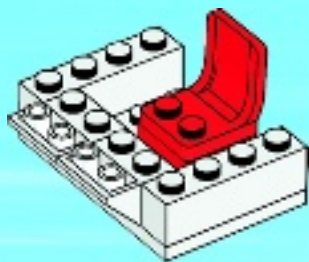



2x



1x

6

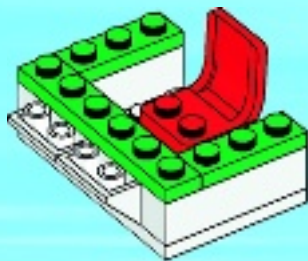

1x



1x

7

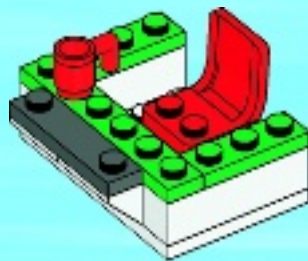



1x



8

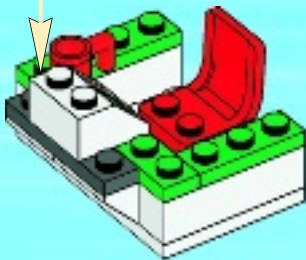



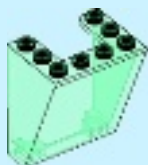

3x



1x

9

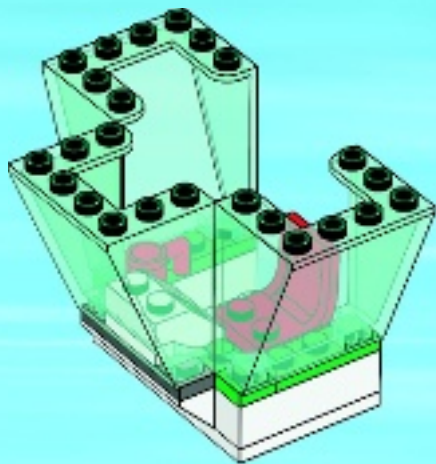

10

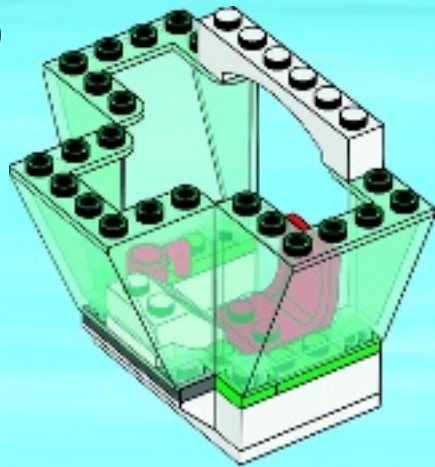



2x

11

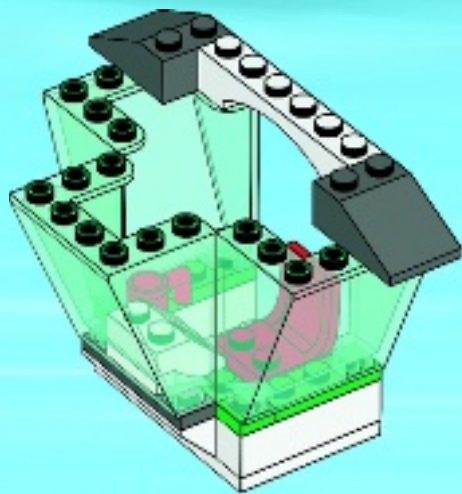



2x



2x



1x

12

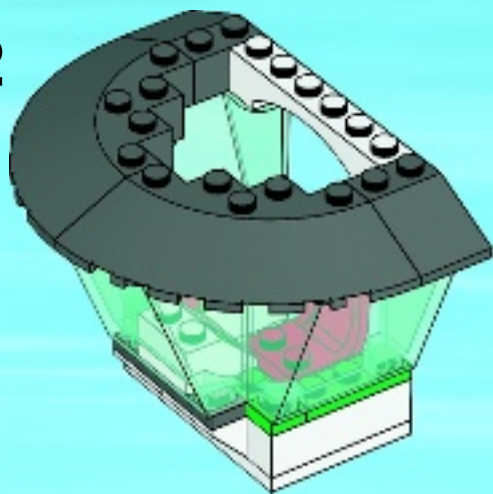

13

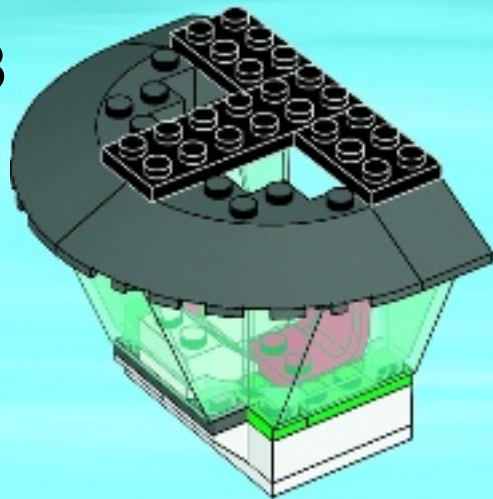



2x

1x



14



2x

15



11





1x



1x

12





1x

13







# 14

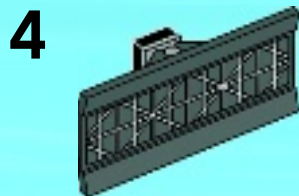
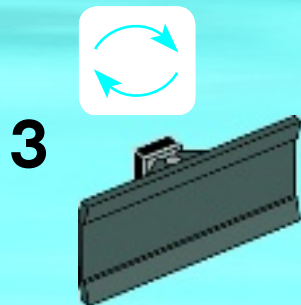
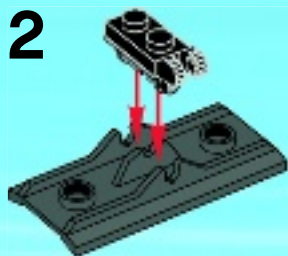







1x

15



**LEGO** CITY



60014



60013



60012



60011





CITY



60004



60003



60002



60001



60000



CITY

LEGO.com/city

**EXPLORE TONS OF GAMES,  
MOVIES AND FUN CHALLENGES**



Entdecken viele Spiele, Filme und spannende Herausforderungen

Découvrez de nombreux films, jeux et défis amusants

Explora abundantes juegos, películas y divertidos desafíos

Explore uma variedade de jogos, filmes e oportunidades de divertimento

Problez fel sok-sok játékot, filmet, és érdekes kihívást!





Nintendo®



**CITY**  
UNDERCOVER



LEGO® City: Undercover software ©2013 TT Games Publishing Ltd. ©2013 The LEGO Group. All rights reserved.

Wii U™



# club™

## Free\*! Gratuit!

\* Paid subscription in Australia and New Zealand.  
Abonnement payant en Australie et Nouvelle-Zélande



© 2013 The LEGO Group



[LEGO.com/club](http://LEGO.com/club)



# WIN!

Go to [www.LEGOsurvey.com/product](http://www.LEGOsurvey.com/product) to fill out a survey for a chance to win a cool LEGO® Product.

No purchase necessary.

Open to all residents where not prohibited.



## [www.LEGOsurvey.com/product](http://www.LEGOsurvey.com/product)

### GEWINNE!

Nimm an der Umfrage auf [www.LEGOsurvey.com/product](http://www.LEGOsurvey.com/product) teil und hab die Chance ein cooles LEGO® Produkt zu gewinnen!

Die Teilnahme am Gewinnspiel führt zu keinerlei Kaufverpflichtungen. Teilnahme in allen nicht ausgeschlossenen Ländern möglich.

### WIN!

Ga naar [www.LEGOsurvey.com/product](http://www.LEGOsurvey.com/product), vul een enquêteformulier in en maak kans op een cool LEGO® product.

Geen aankoopverplichting. Iedereen mag deelnemen, uitgezonderd ingezetenden van landen waar een enquêteverbod geldt.

### GAGNE!

Visite [www.LEGOsurvey.com/product](http://www.LEGOsurvey.com/product) pour répondre à un questionnaire et avoir une chance de gagner un produit LEGO® très cool!

Aucune obligation d'achat. Ouvert à tous les résidents des pays autorisés.

### 当てよう!

[www.LEGOsurvey.com/product](http://www.LEGOsurvey.com/product) にアクセスして、アンケートにご記入ください。当選者にはレゴ®製品を差し上げます。

お買い上げの必要はありません。禁止されていない限り、すべての皆様にご利用いただけます。



LEGO.com

6051105

LEGO and the LEGO logo are trademarks of the LEGO Group. ©2013 The LEGO Group.





# CITY

60022



2

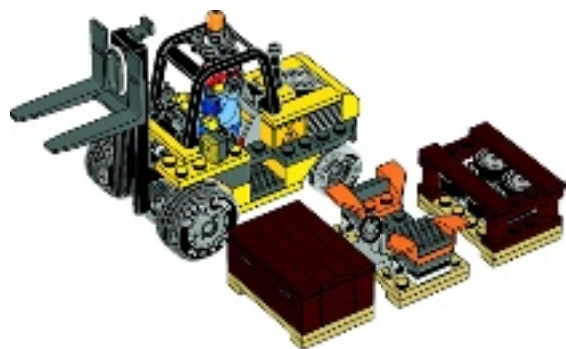

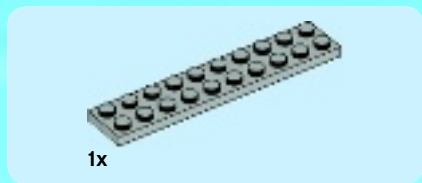
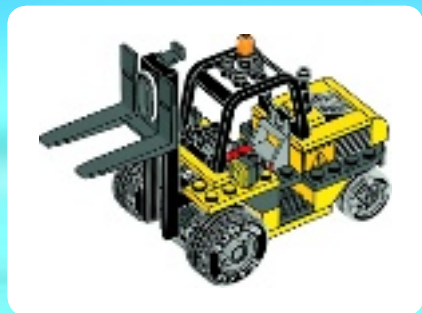

1

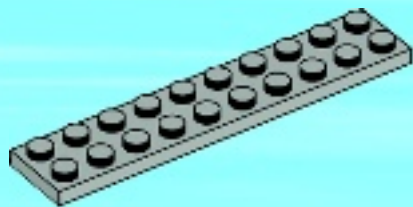

2

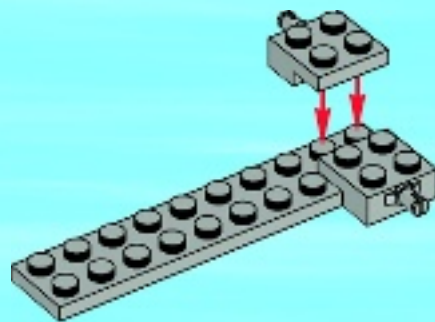



1x



2x

3

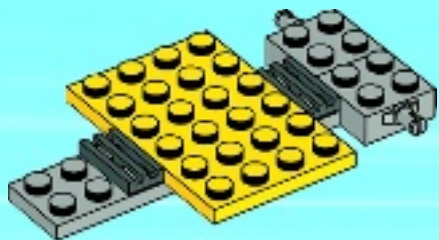

4



1x

4



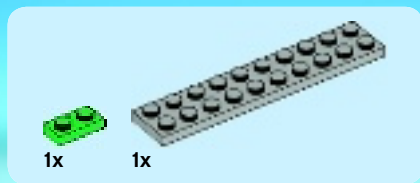

5

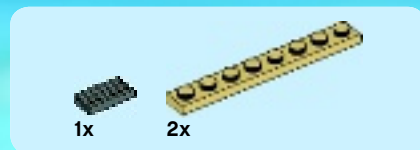
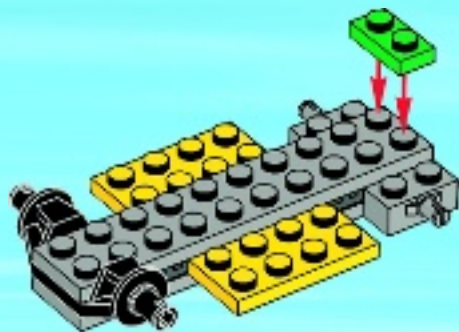

6

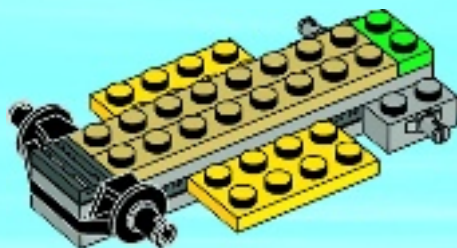



1x



1x

7

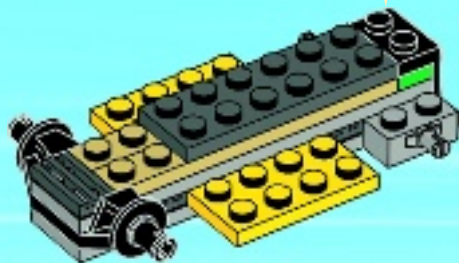

2x



2x

8

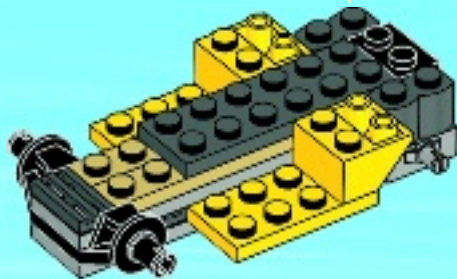





4x

9

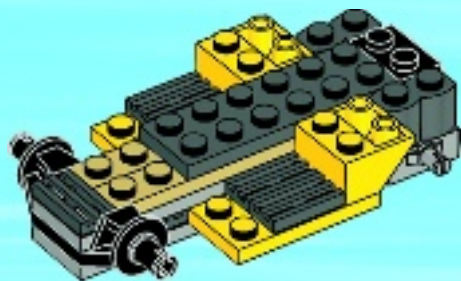

2x

10

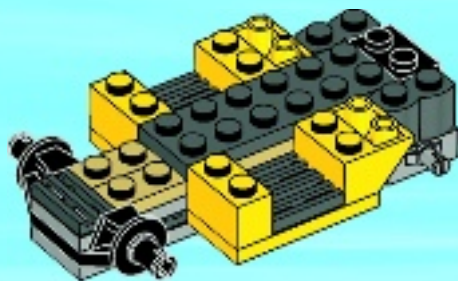



1x

# 11

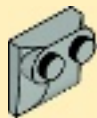

1x

# 12

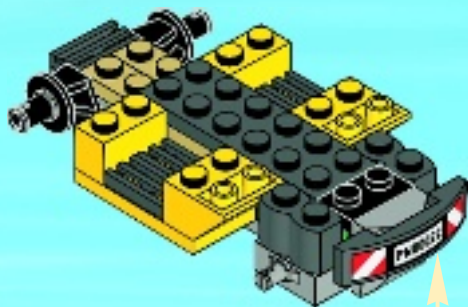

1



2







1x



2x

# 13

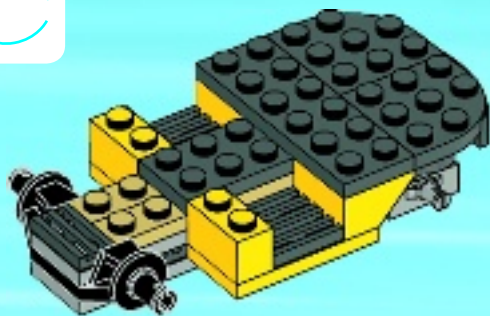

2x

# 14

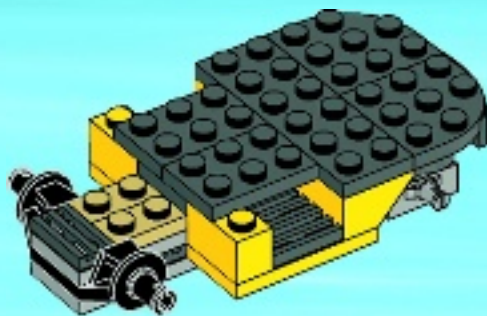



2x



1x

# 15

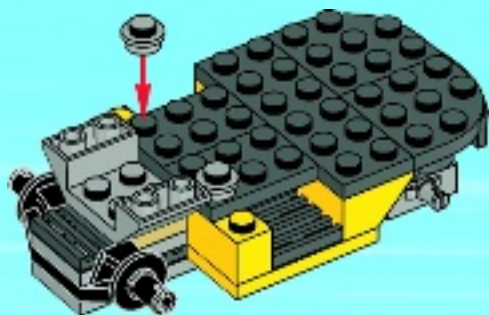

2x

# 16

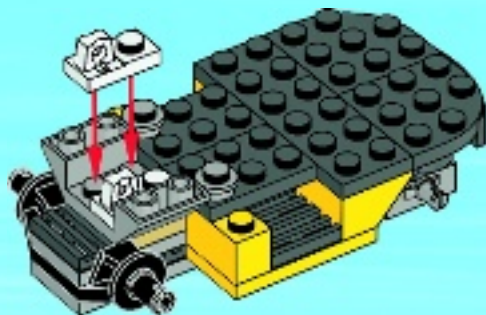



1x

# 17

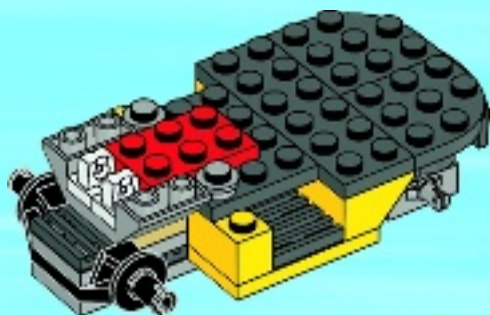

1x



1x

# 18

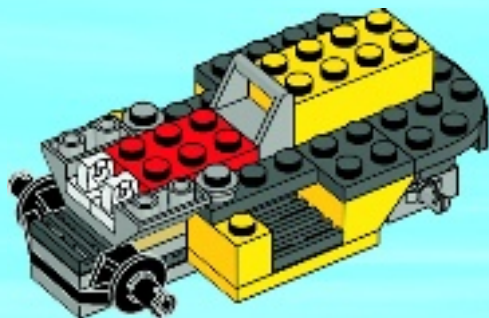



2x

19

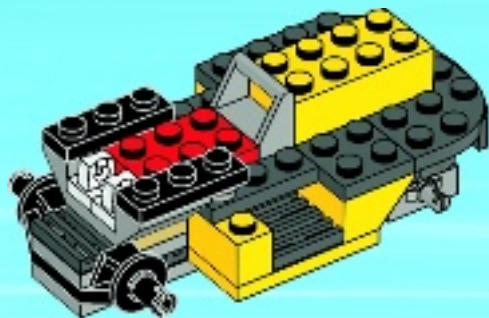

2x

20

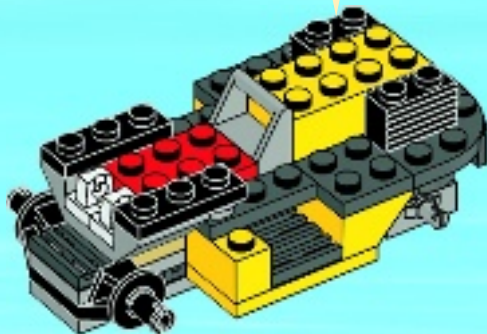



2x

# 21

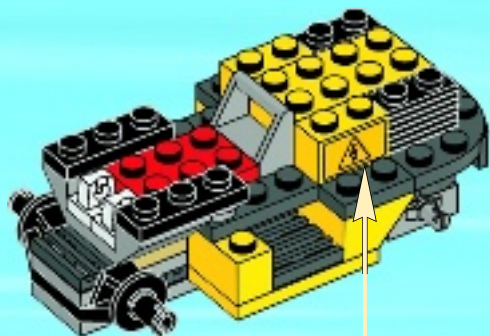

1

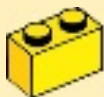

2



2x

# 22

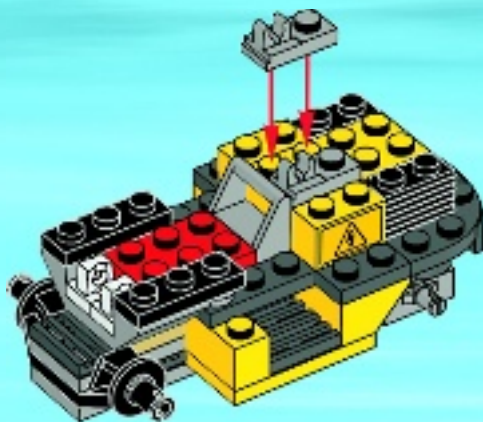



2x



1x

# 23

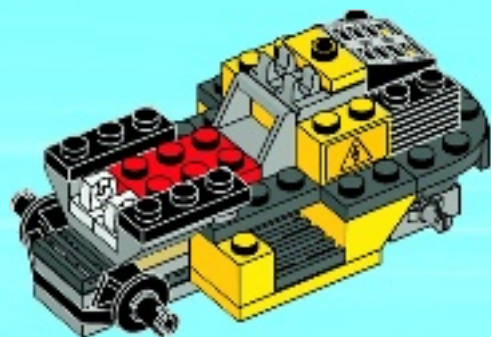

2x

# 24

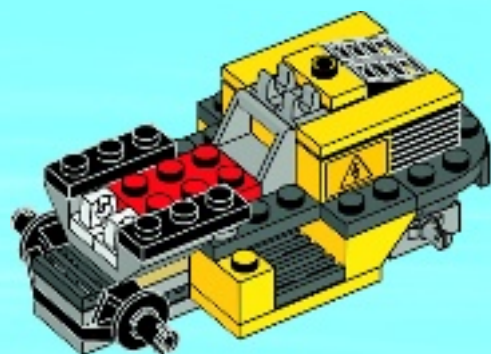





1x



1x

# 25

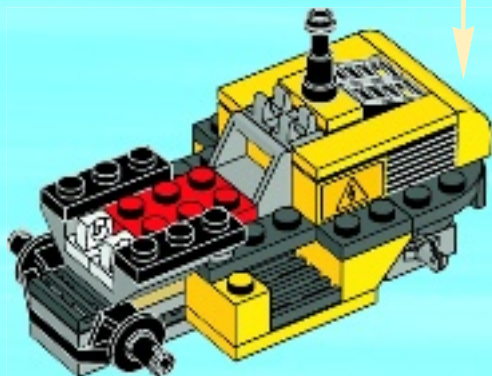
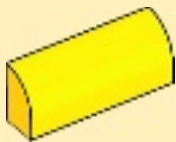

1x



2x

# 26

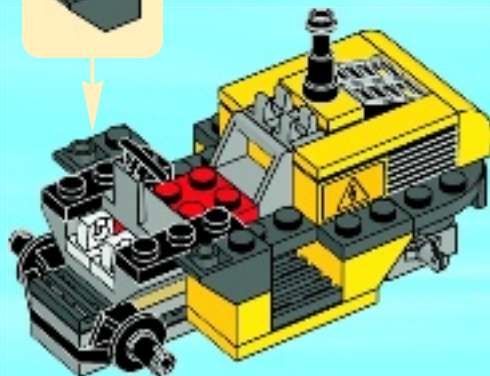



2x

27

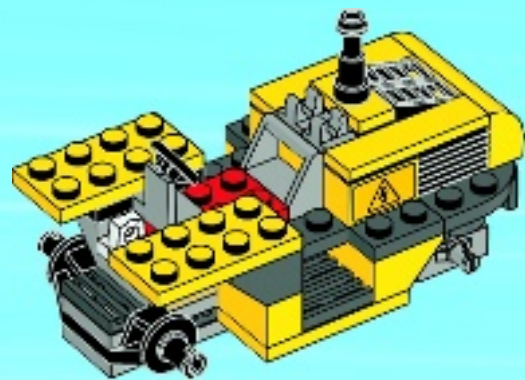

2x



1x

28

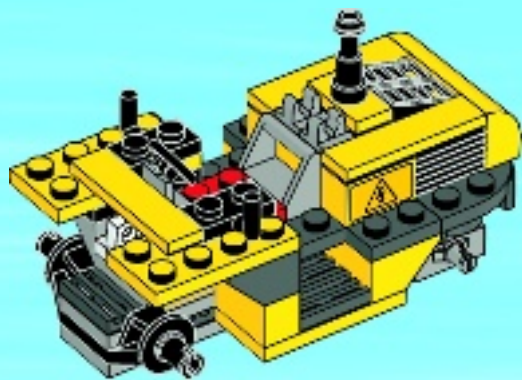





2x



2x

# 29



2x

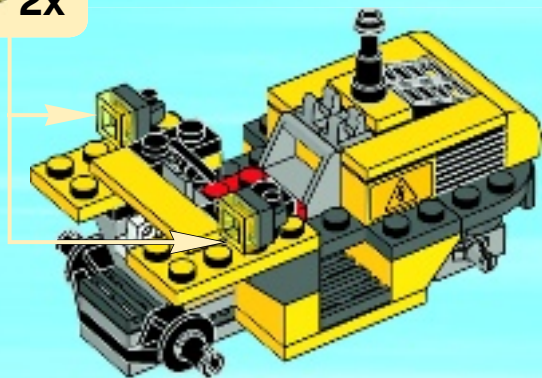

1x

# 30

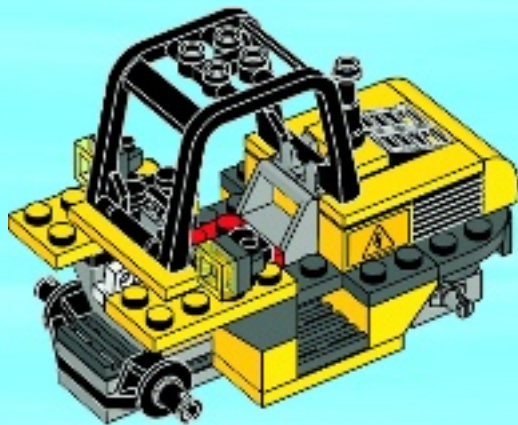



1x

# 31

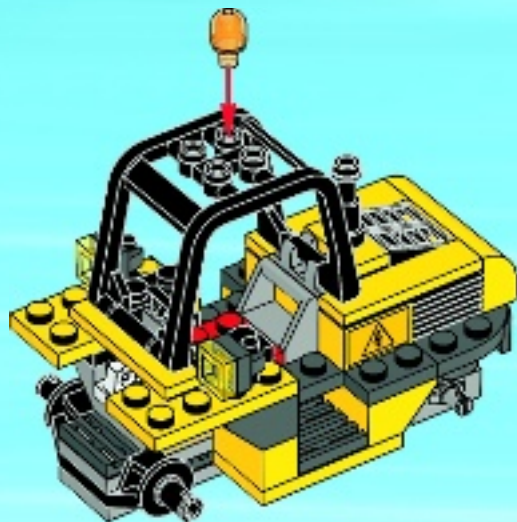

2x



2x

# 32



2x



2x



2x

# 33

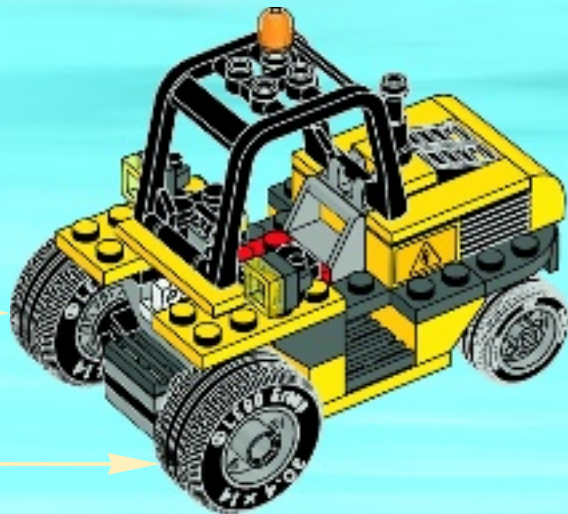



1x

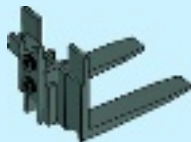

1x

1



34

**2**

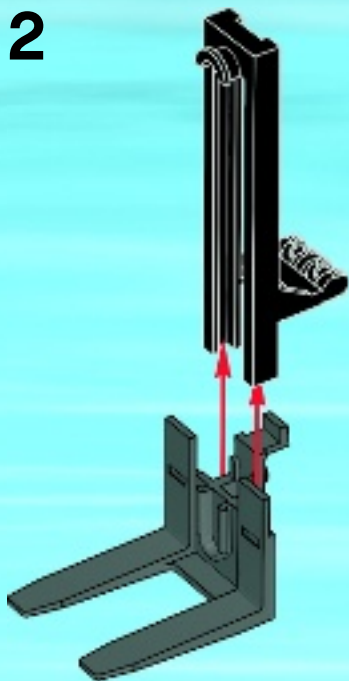

**3**

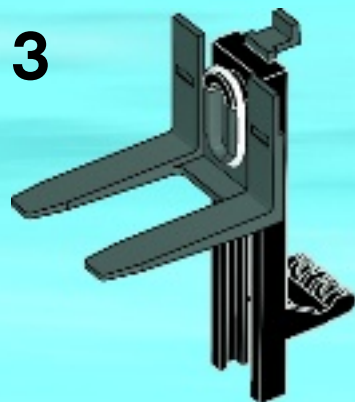

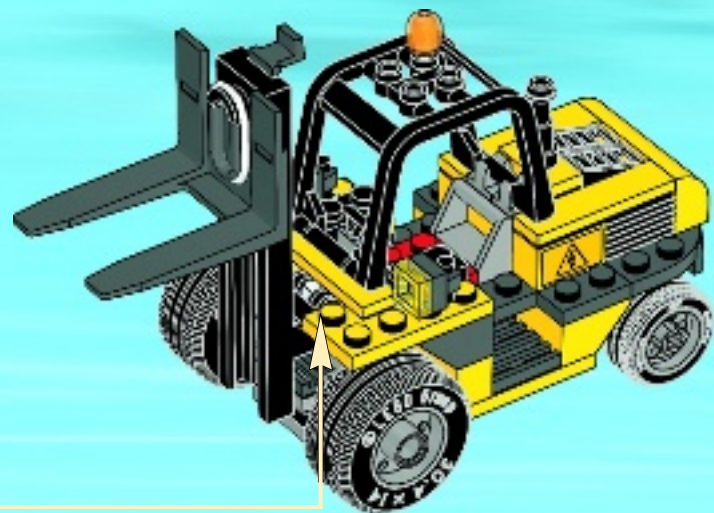

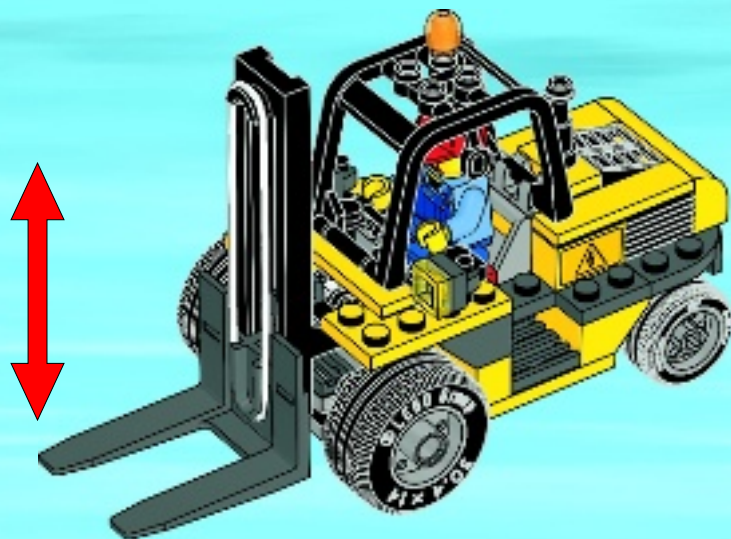





1x

1



2x

2

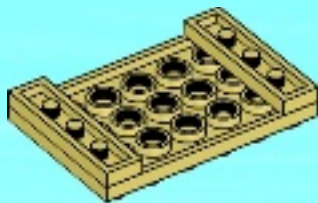





1x

3



2x



1x

4





1x

5



1x

6





4x

7



2x

8

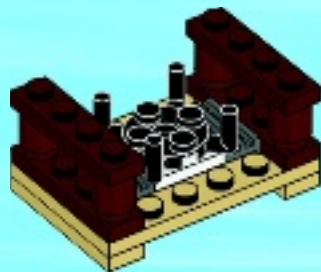



4x



4x

9

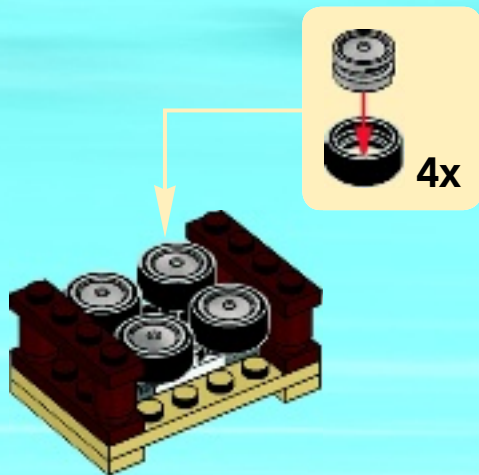

2x

10

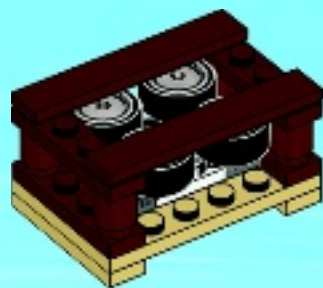



1x

1

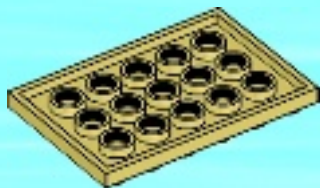

2x

2

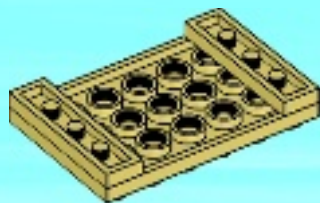



2x

3

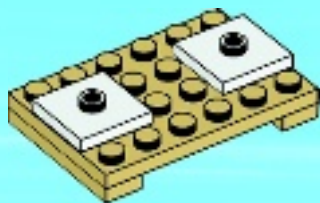

2x



1x



2x



2x



1x

4

1

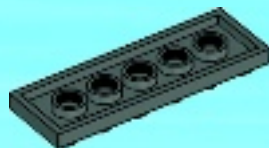

**2**

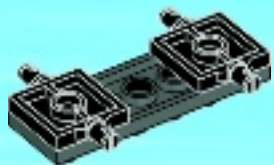

**3**

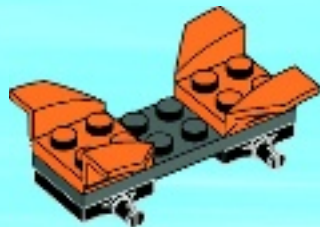



4



5





1x

5

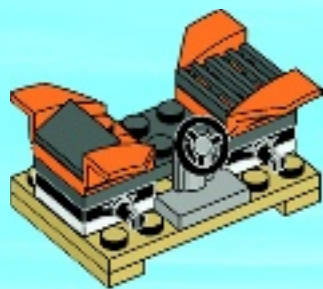
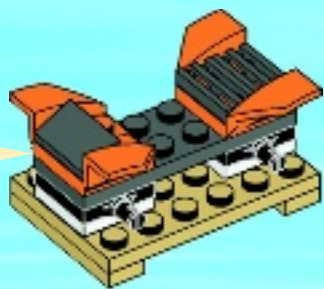

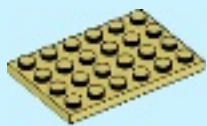

1x

1



2x

2

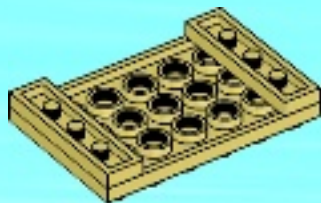



6x



2x



2x



2x

# 3

## 1



## 2



**3**

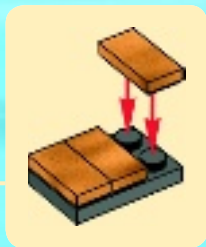

**4**



**2x**

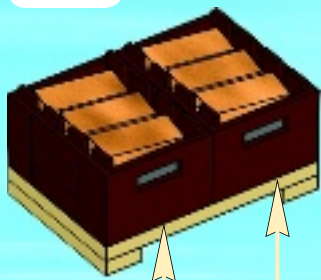

4



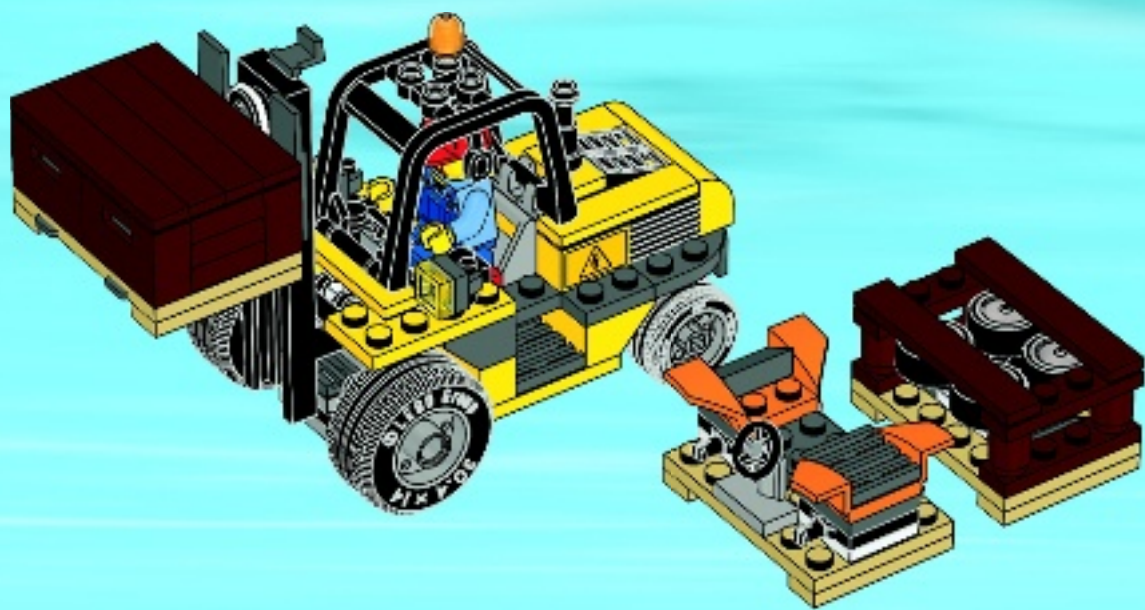



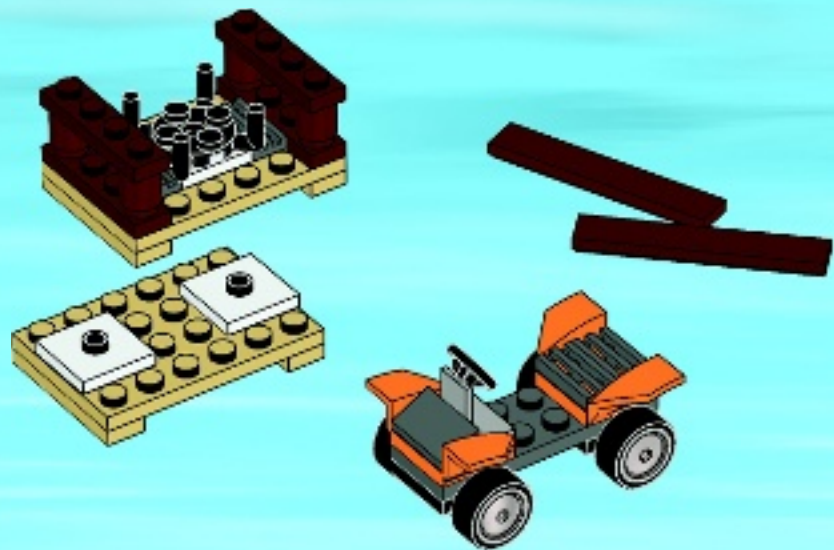

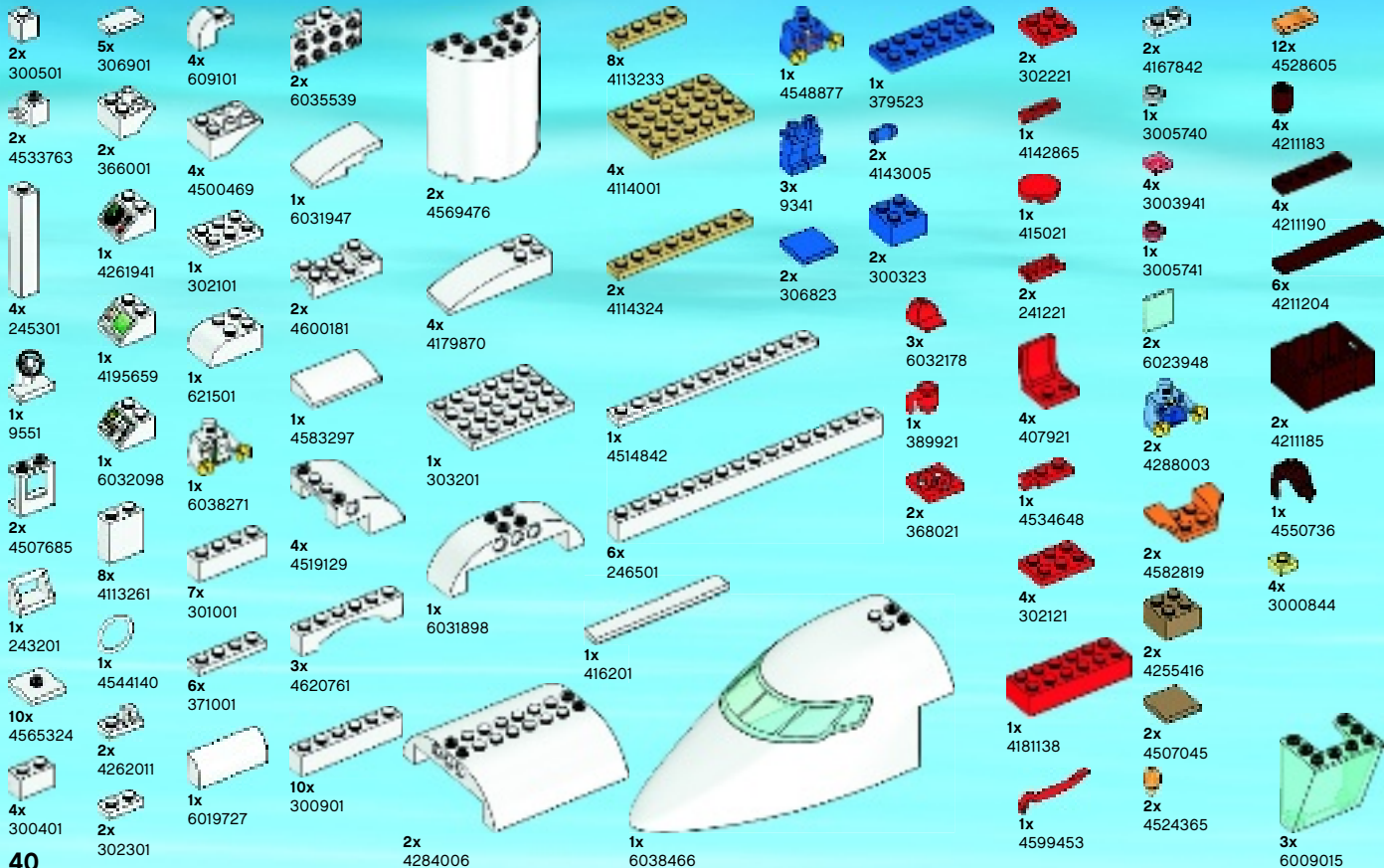

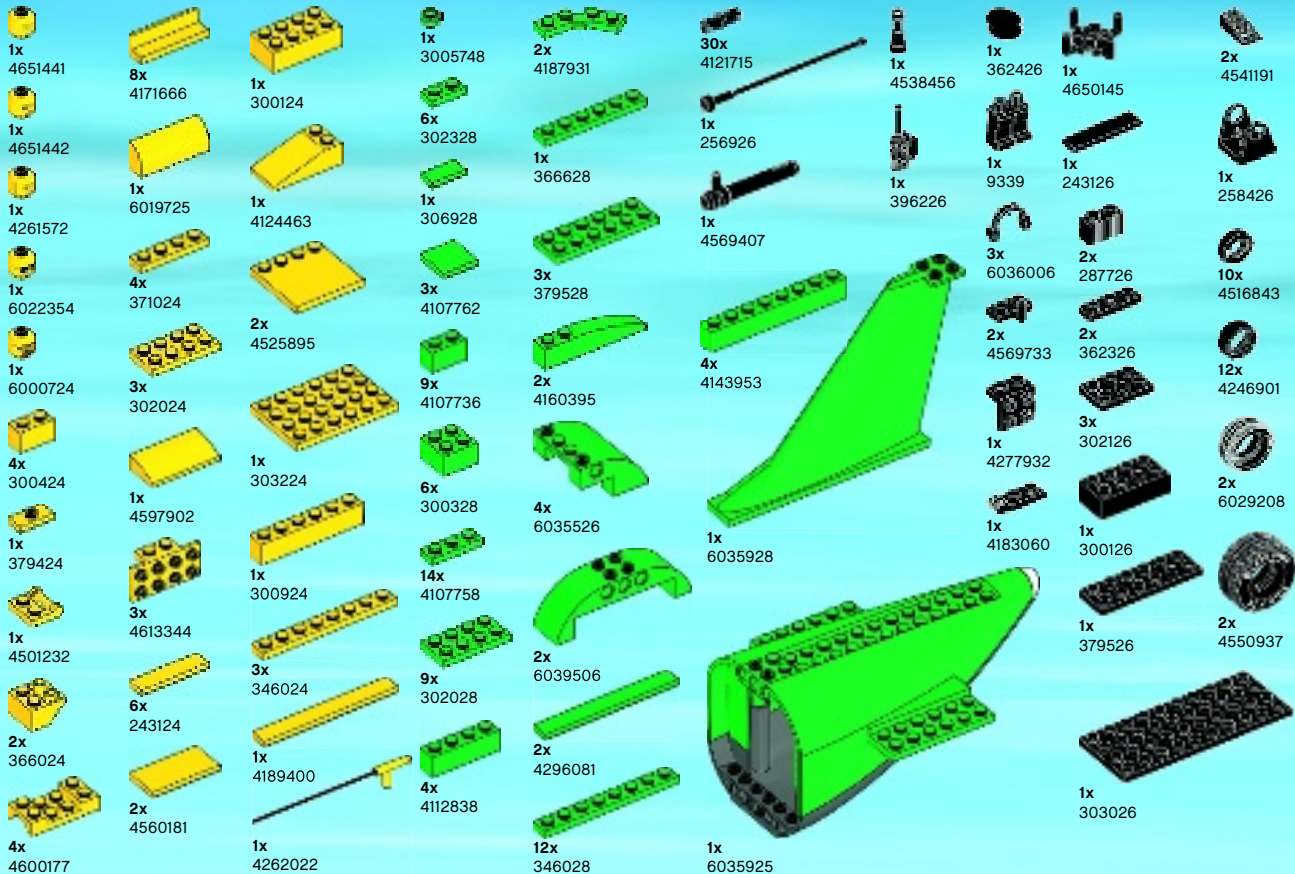



2x  
460026



1x  
6019987



2x  
4211095



1x  
4583879



5x  
4598769



2x  
4622338



1x  
6035530



1x  
4265794



1x  
4524930



1x  
4648256



3x  
6032175



1x  
4217725



2x  
6030710



1x  
4570666



1x  
4539429



1x  
6035531



1x  
4211114



1x  
244126



16x  
4210631



4x  
4211043



1x  
4243831

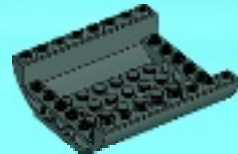

4x  
6035536



1x  
4539385



1x  
4271950



7x  
4211106



2x  
4222042

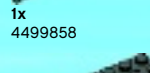

1x  
4499858



1x  
4597139



2x  
4567887



1x  
4560177



1x  
6003058



1x  
4210997



1x  
6035528



2x  
4211096



4x  
4295253



7x  
4211002



1x  
4211134



1x  
4550190



2x  
4211063



2x  
4212075



1x  
4521572



2x  
4565322

1x  
4251163



3x  
4211386



6x  
4211396



1x  
4211517



1x  
4211445



4x  
4211767



1x  
4565433



4x  
4211549



1x  
4514846

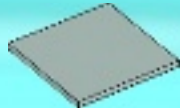

3x  
6014617

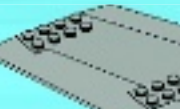

2x  
4211462



1x  
4211425



1x  
4211616



1x  
4211407

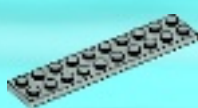

2x  
4211462



1x  
4211617



3x  
4211522



1x  
4227657



3x  
4226995

1x  
4638602



1x  
4519013



2x  
6029209



2x  
4299119



4x  
4211516



6x  
6018081



1x  
4650645



1x  
4278273



4x  
4593679



1x  
4494475



1x  
4211370



2x  
4540203



2x  
6004888



4x  
4211350



1x  
4565397



2x  
4598526



2x  
4654582



1x  
4211568



1x  
4666449



1x  
4211470



7x  
4211525



1x  
4255629



10x  
4211506



1x  
4221775



12x  
4624473



1x  
4211357



1x  
4211475



1x  
4654448

Customer Service

Kundenservice

Service Consommateurs

Servicio Al Consumidor

LEGO.com/service or dial



: 00800 5346 5555

: 1-800-422-5346







CITY



LEGO.com



60008



60007



60006

LEGO and the LEGO logo are trademarks of the LEGO Group.  
©2013 The LEGO Group. 6051107



60022

CITY









**1**

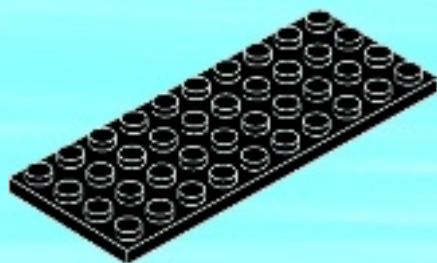



4x

2

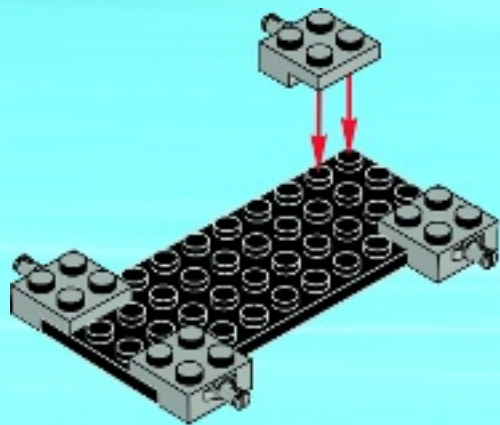

2x

3

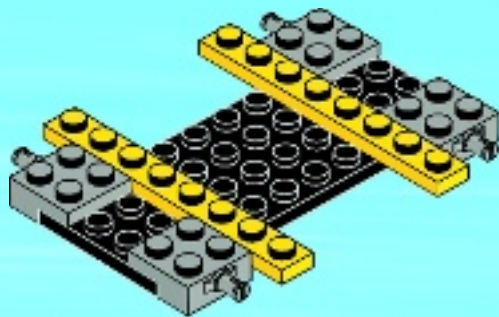



2x

4

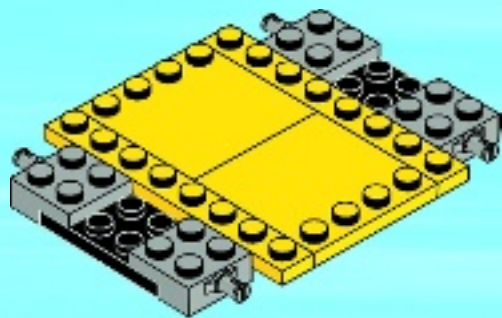

1x

5

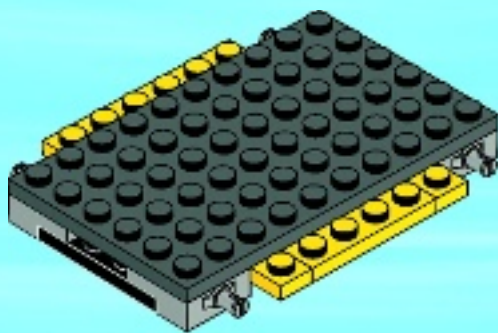



1x

6

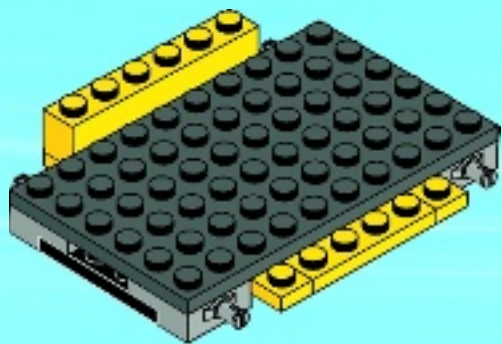

6



1x



1x

7

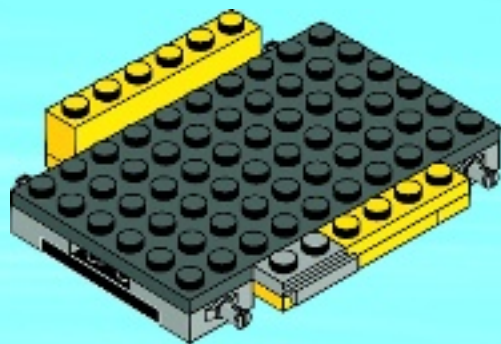



4x

8

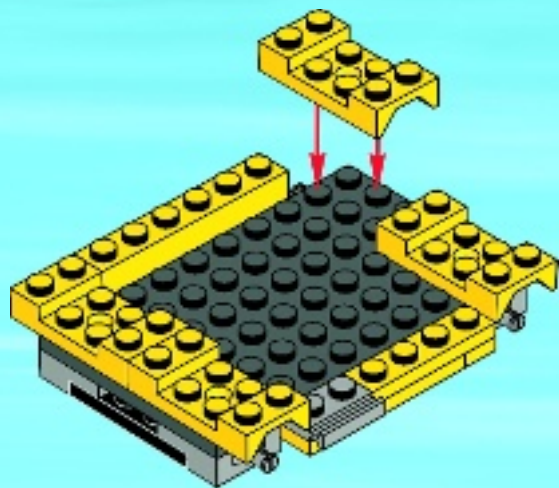

2x

9



2x

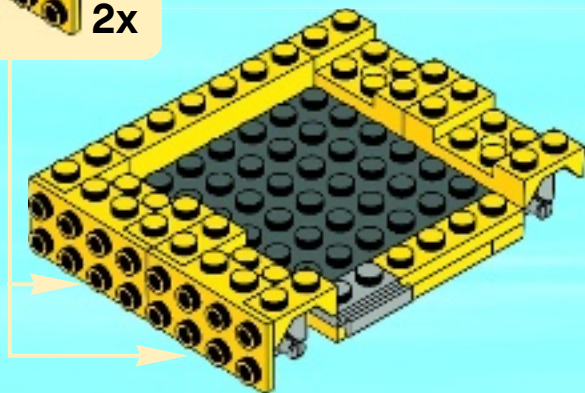



1x



1x

# 10

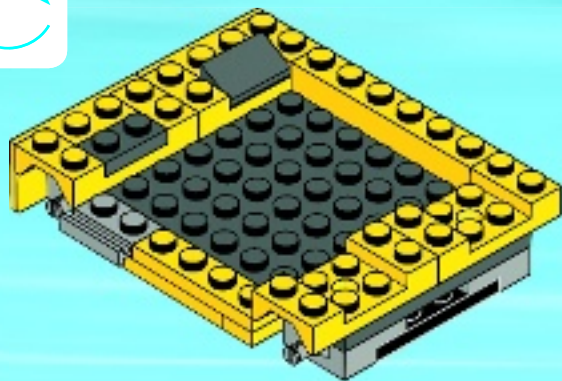

1x



1x

# 11

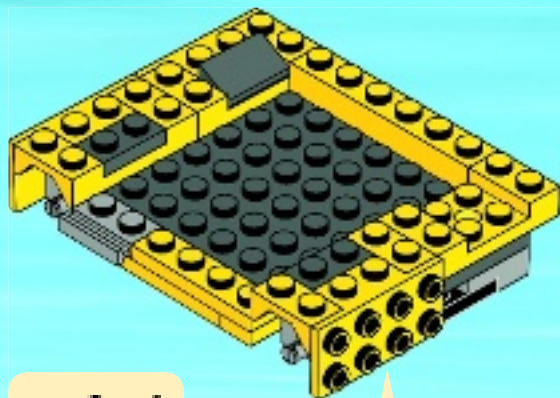





1x

# 12

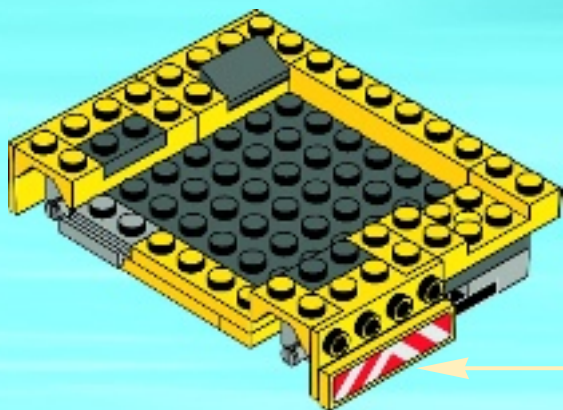

1

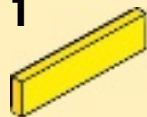

2





2x



1x



1x

# 13

1

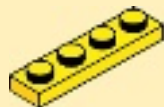

2

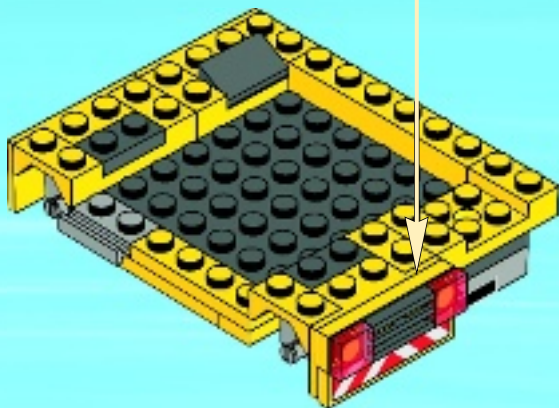
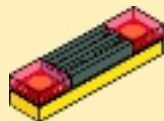



1x



1x

# 14

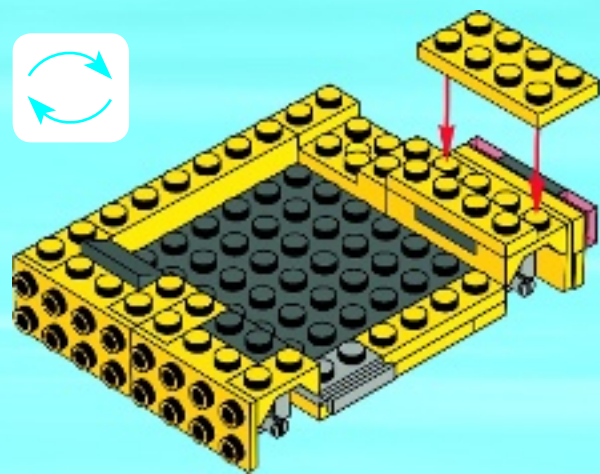

1x

# 15

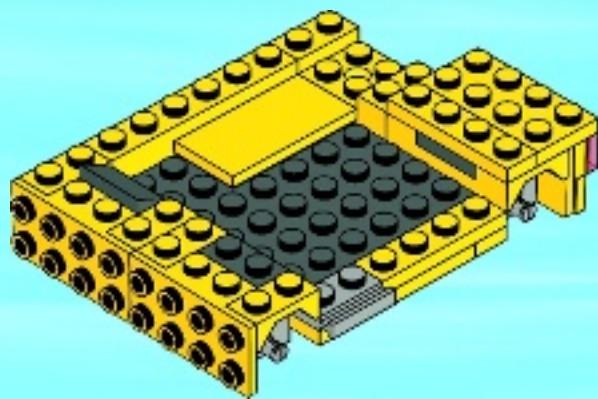



1x



1x

# 16

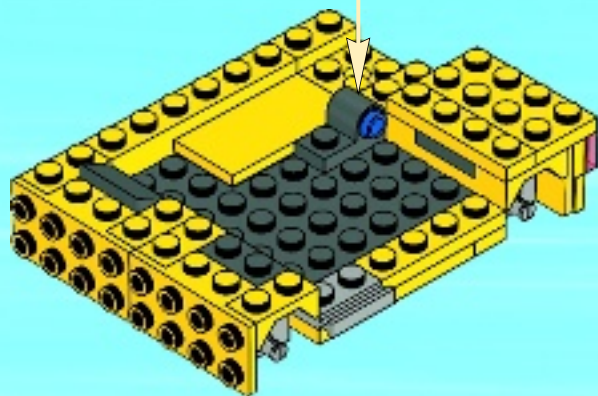
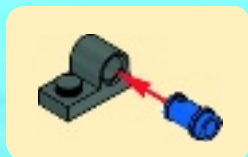

1x

# 17

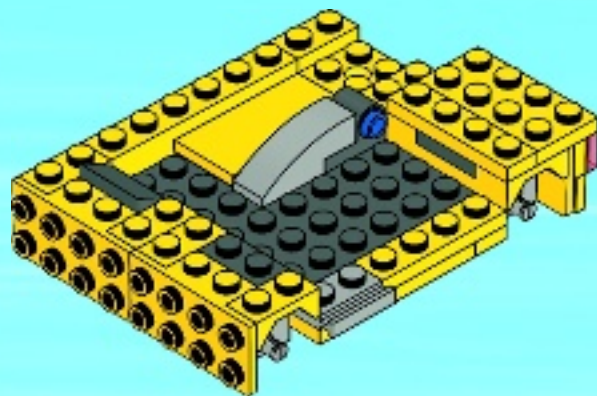

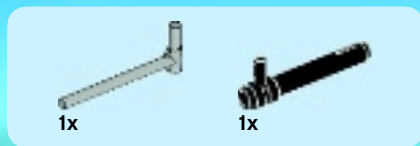

18

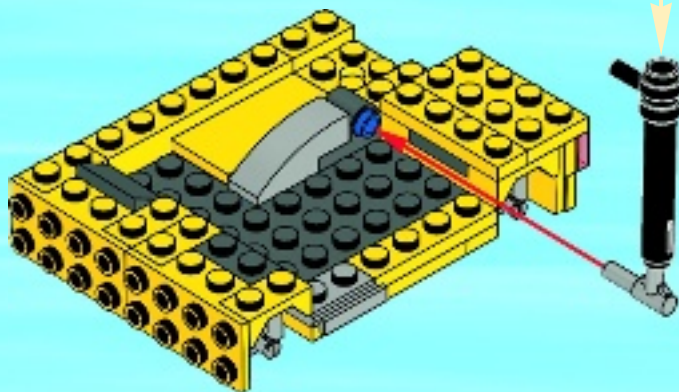
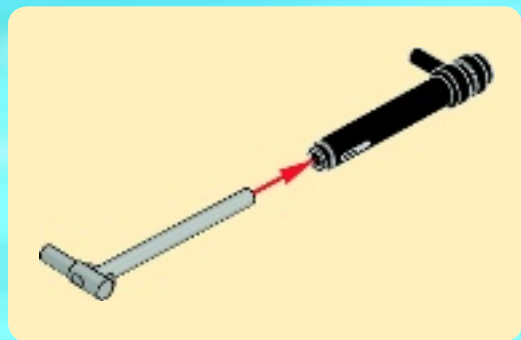



1x

19

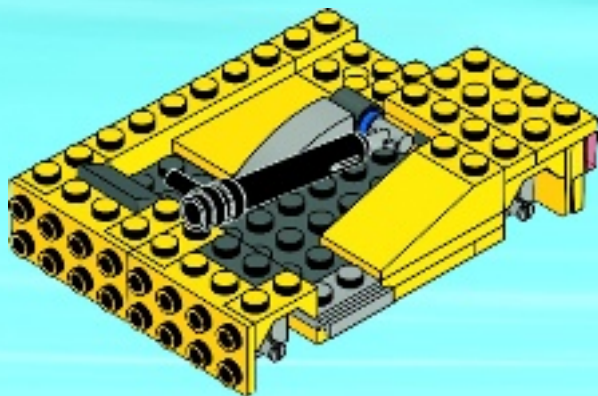

1x

20

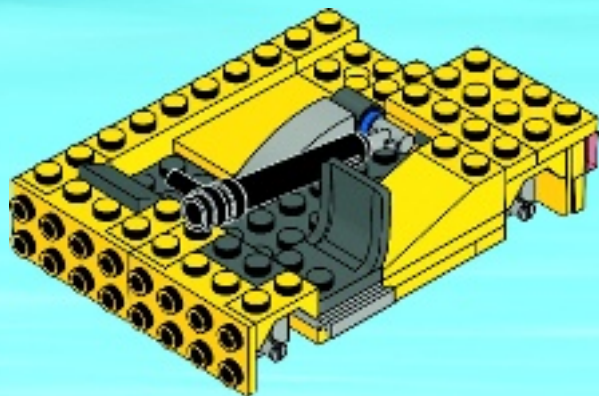





1x

21

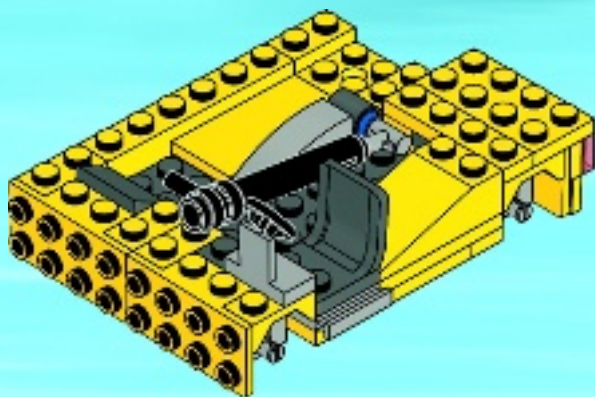





2x



2x



1x

# 22

1

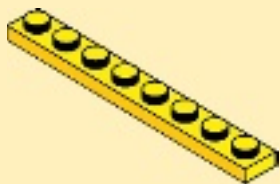

2

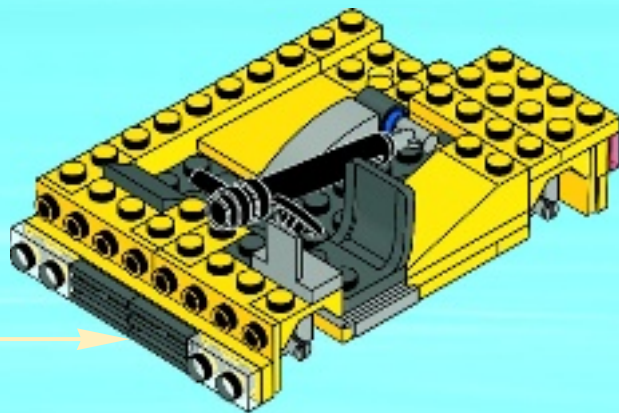
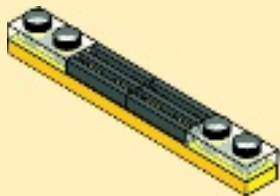



1x



1x

# 23

1

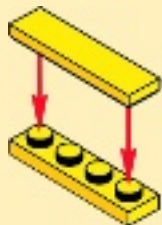

2

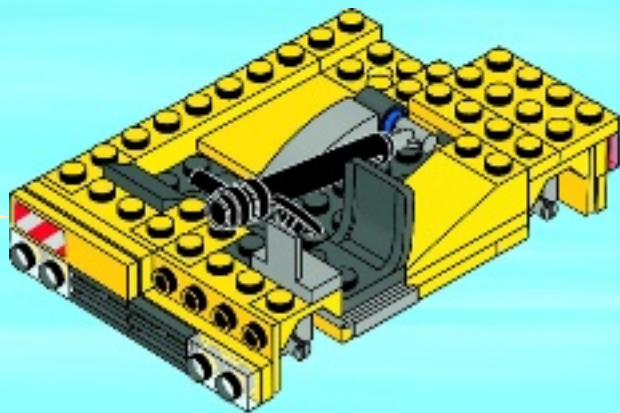
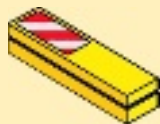

1x



1x

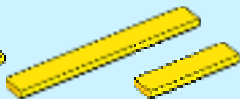

1x



# 24

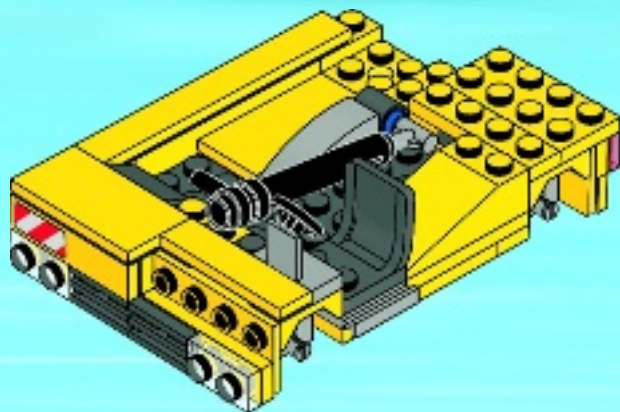



1x

# 25

1

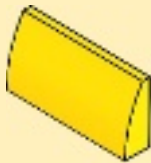

2

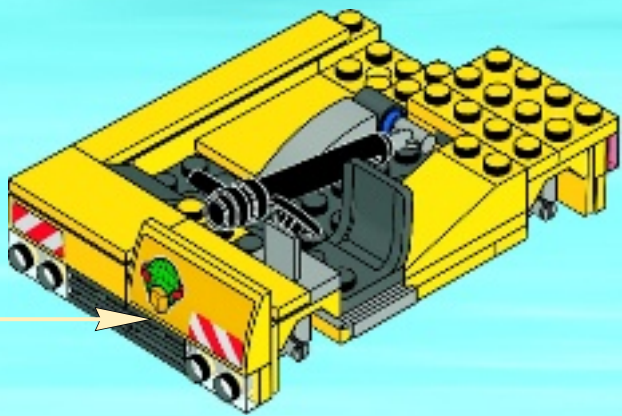



2x



1x

# 26

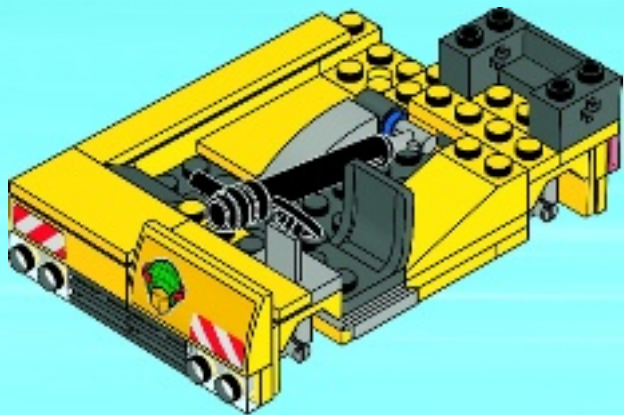

1x



1x

# 27

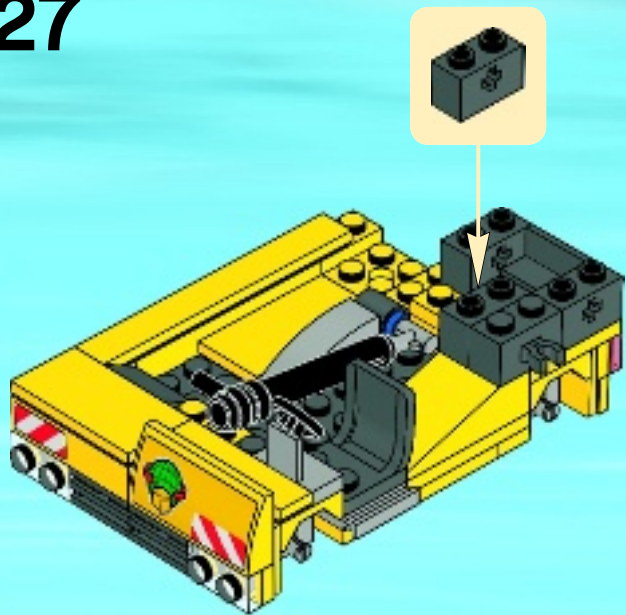



1x

28

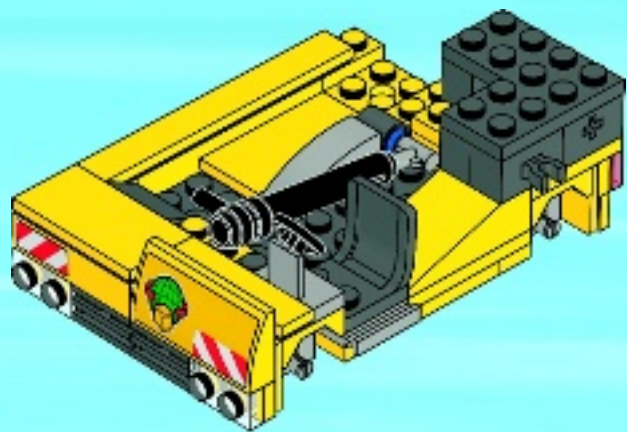

1x

29

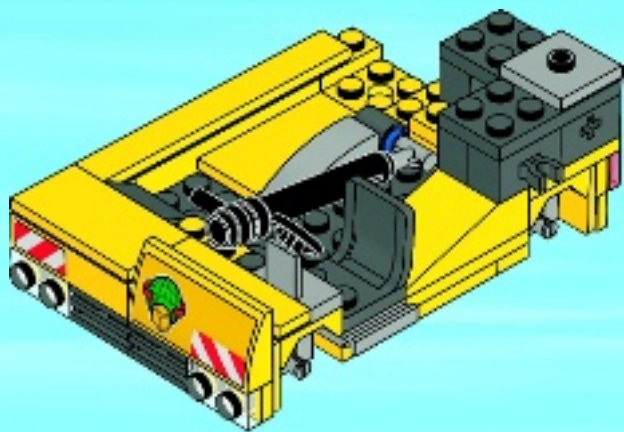





1x



1x

# 30

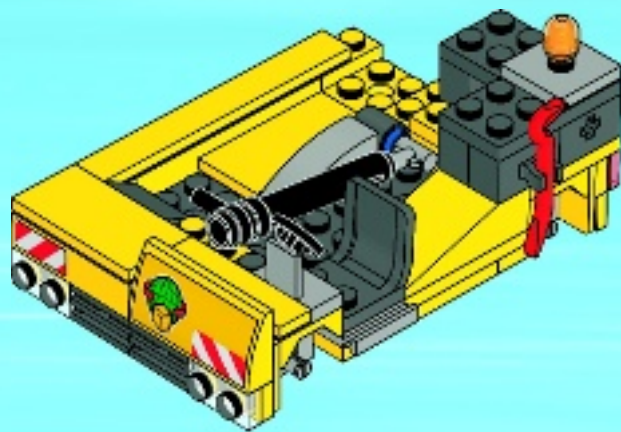





1x

1

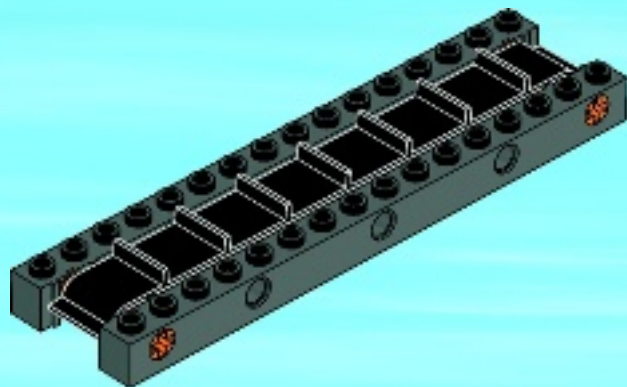



8x

2

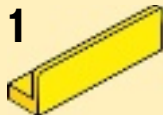
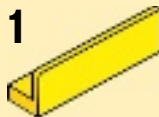
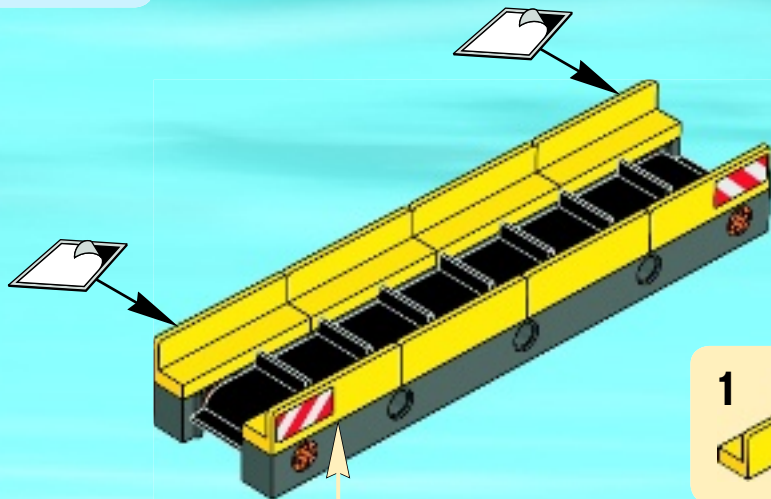



1x

3

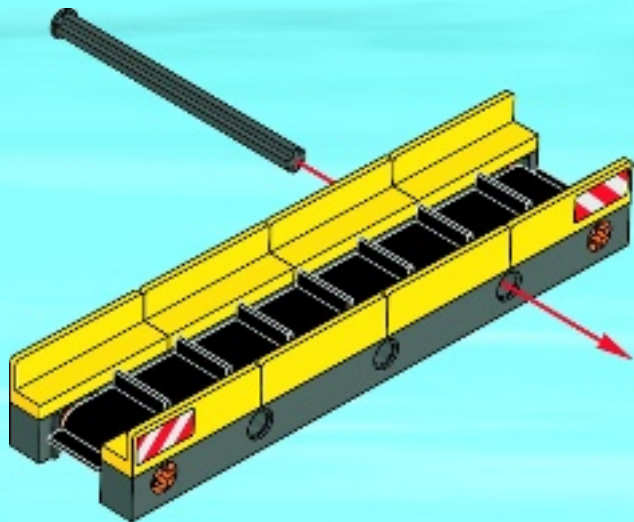

1x

4

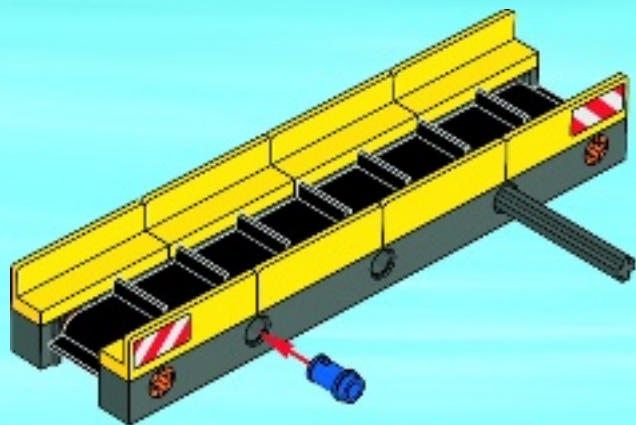

31

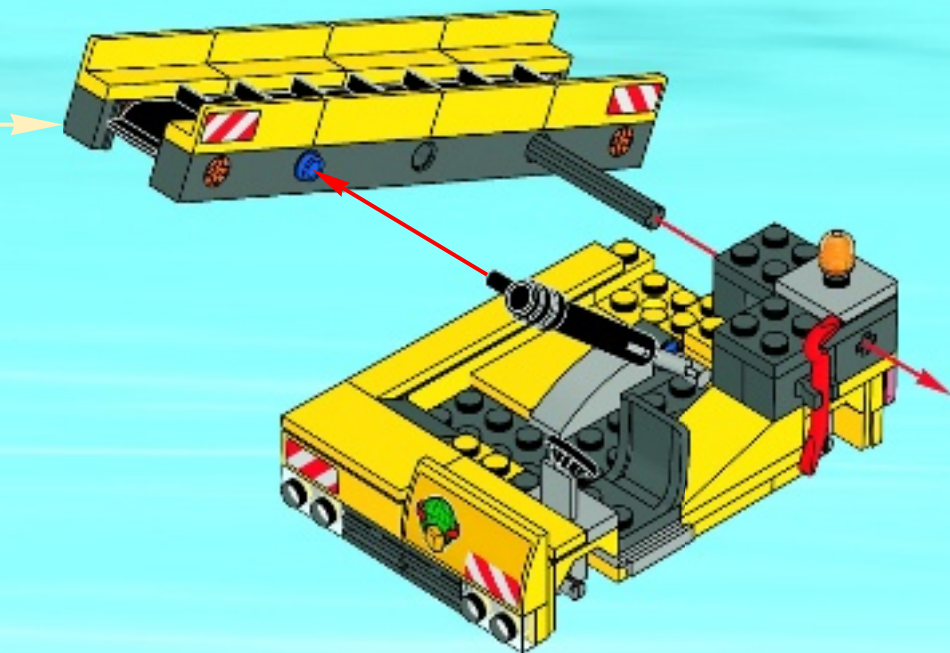



1x



1x



1x

# 32

1



2



3

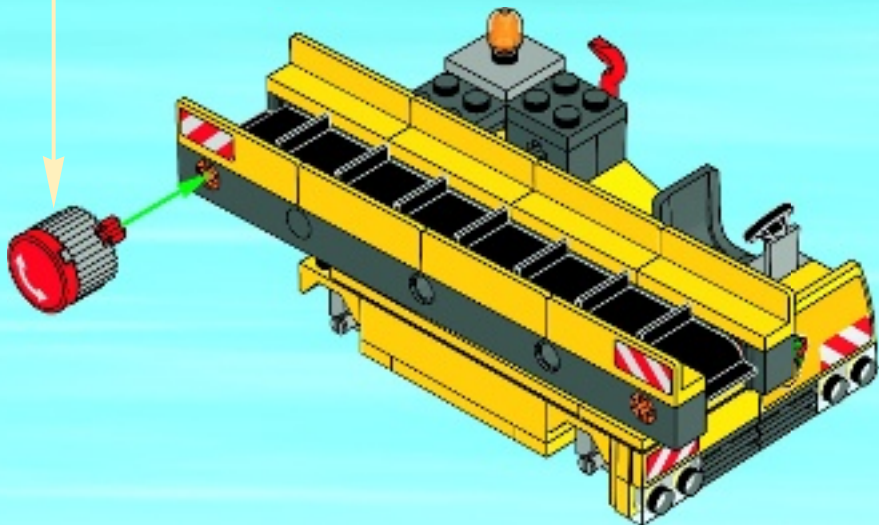



4x



4x

# 33



4x

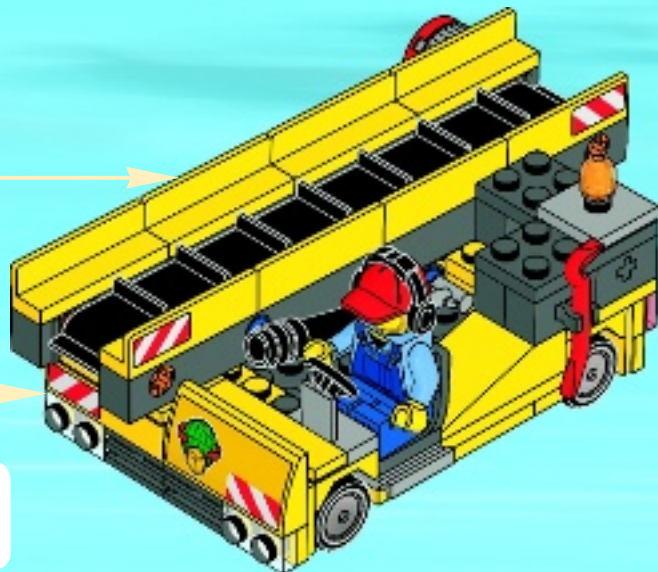



1x

1

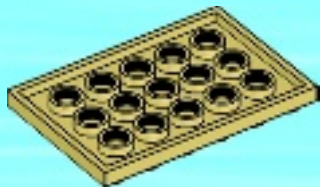

2x

2

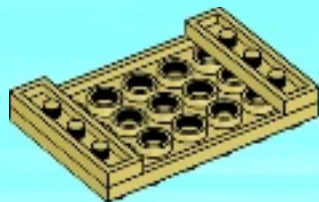





2x



2x

# 3

1



2



3



2x





2x



2x

4

1



2



3



2x

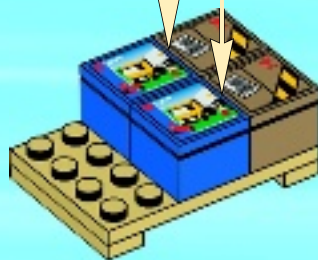



2x



2x

5

1

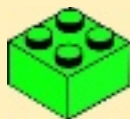

2

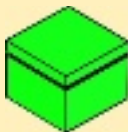

3



2x

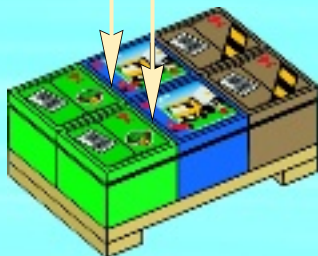

34

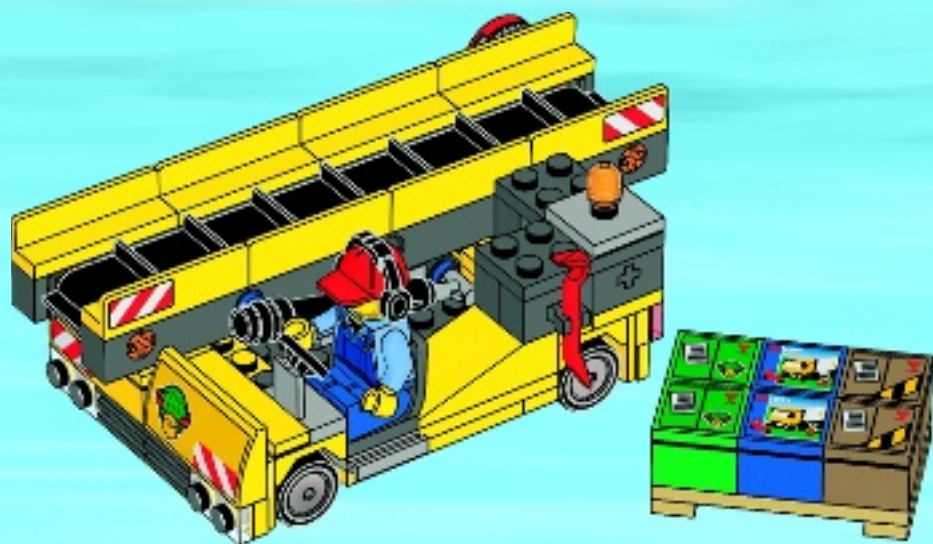

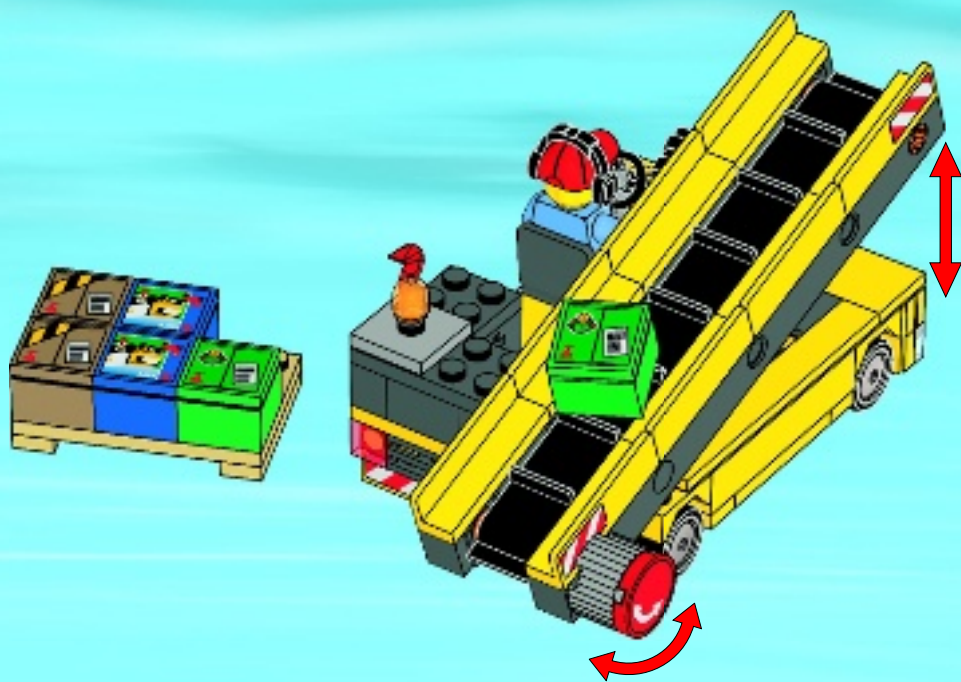



**LEGO**

**CITY**





# CITY



60022



60021



60020



60019

LEGO and the LEGO logo are trademarks of the LEGO Group. ©2014 The LEGO Group. 6084473





60022

# CITY





4

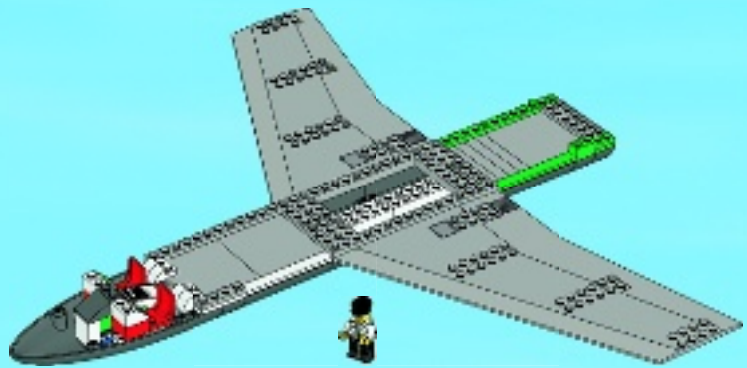

5

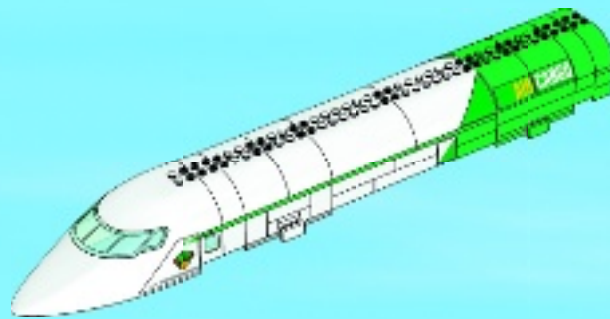

6

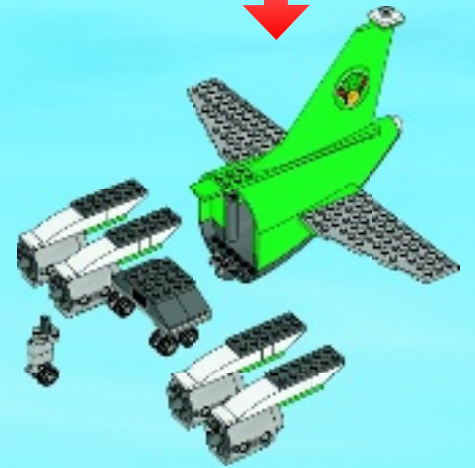



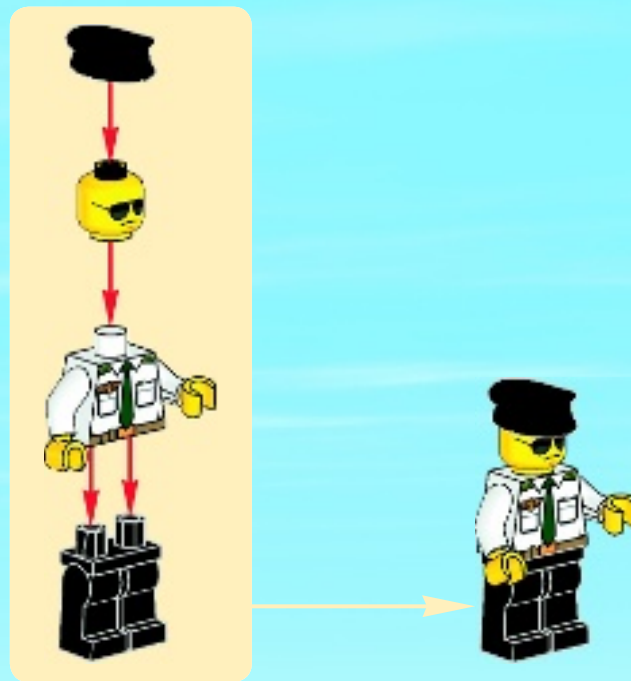
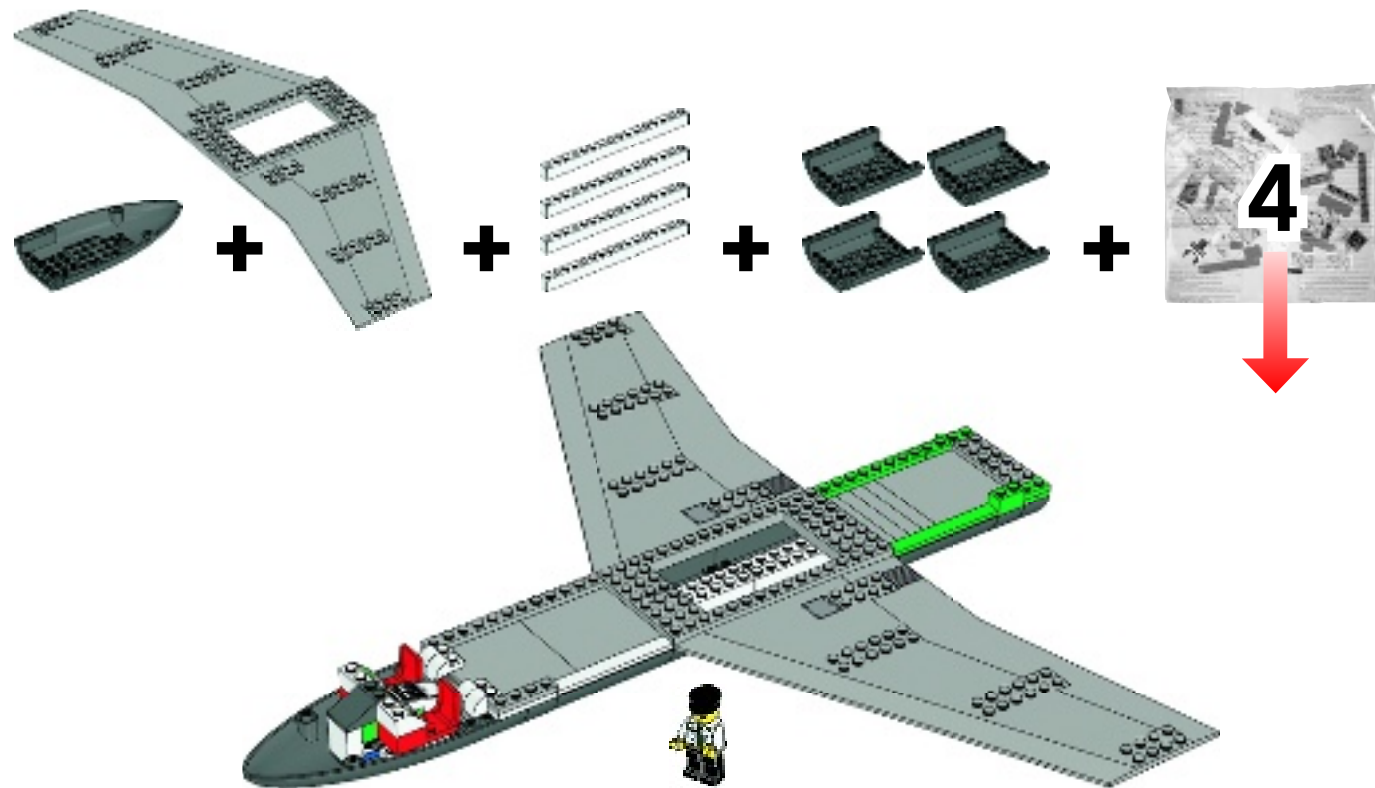

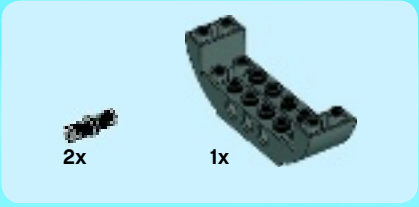

1

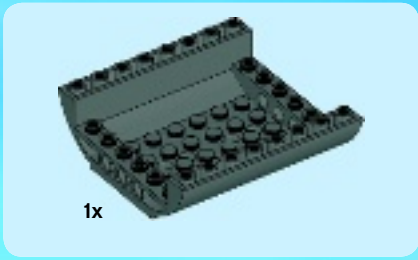
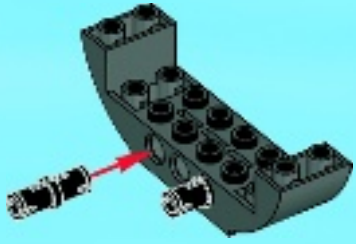

2

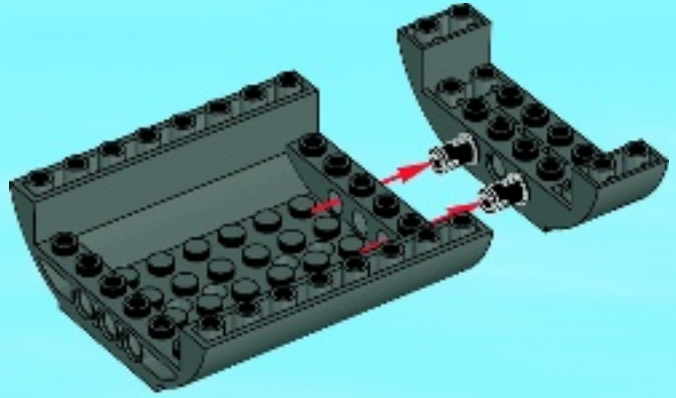

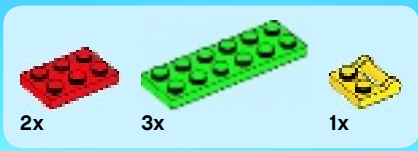

# 3

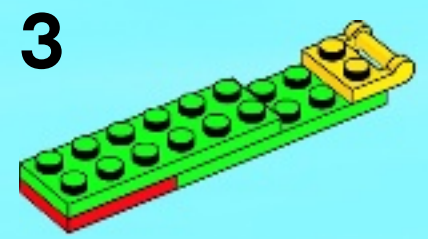
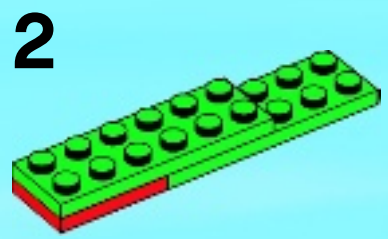
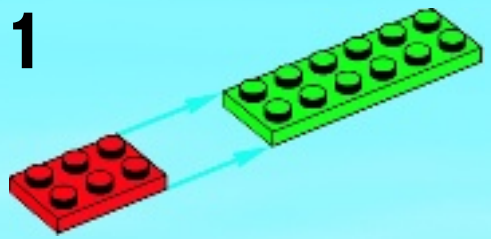

4

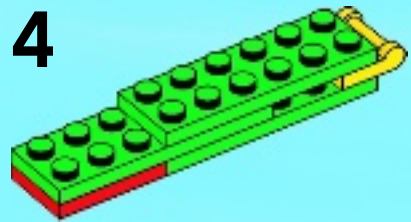

5

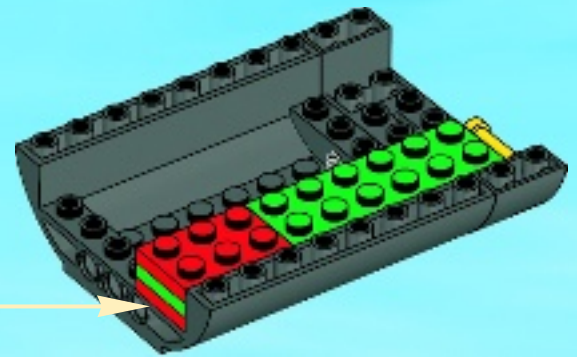
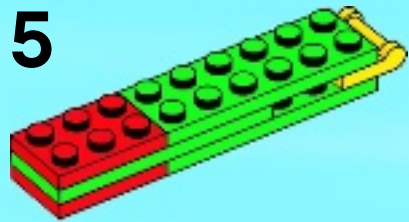



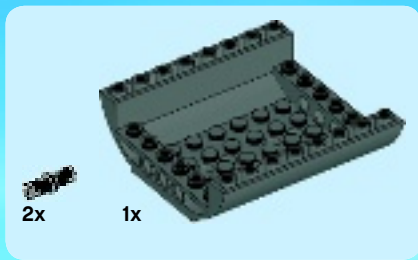

4

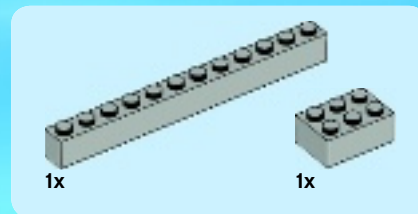
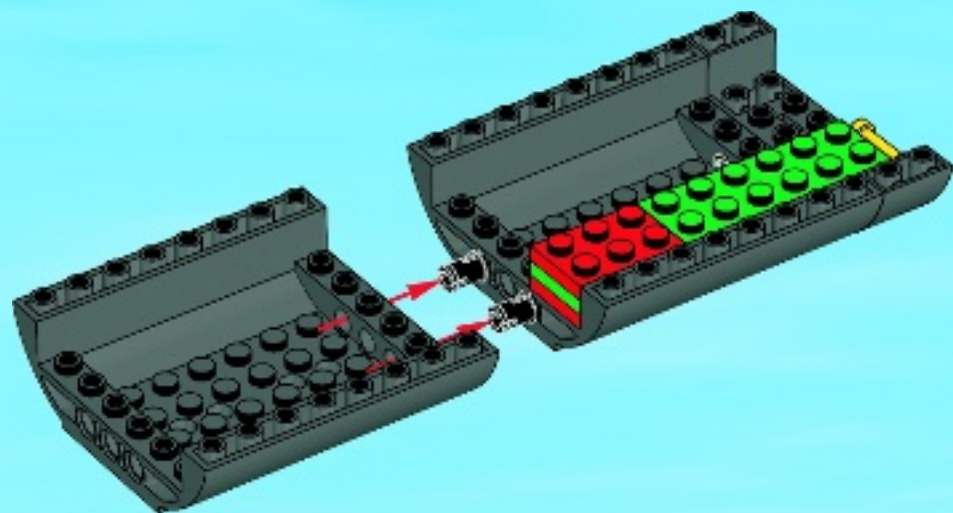

5

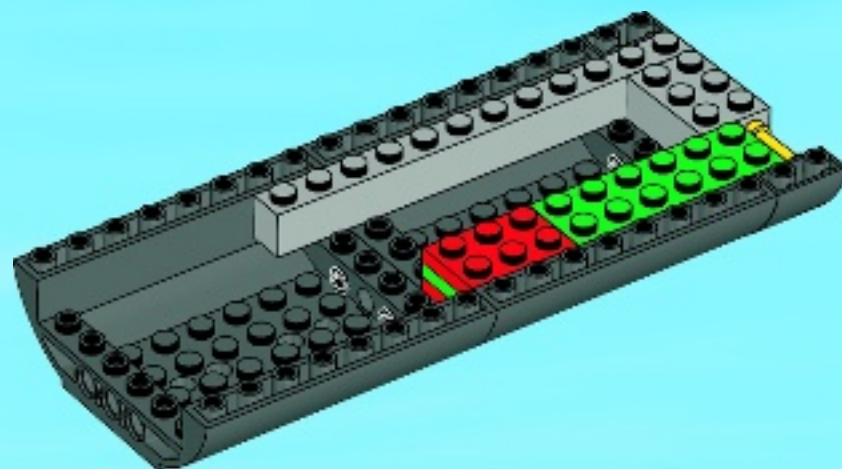

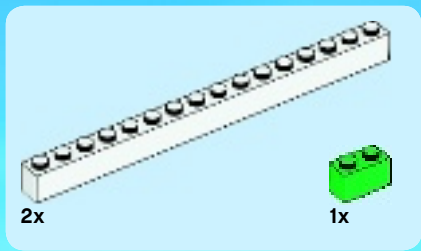

6

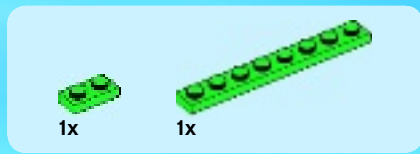
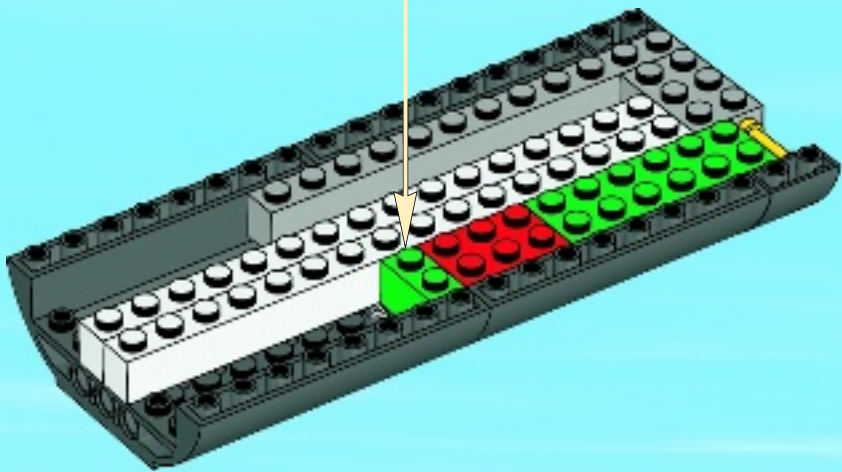
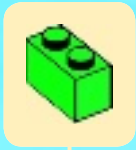

7

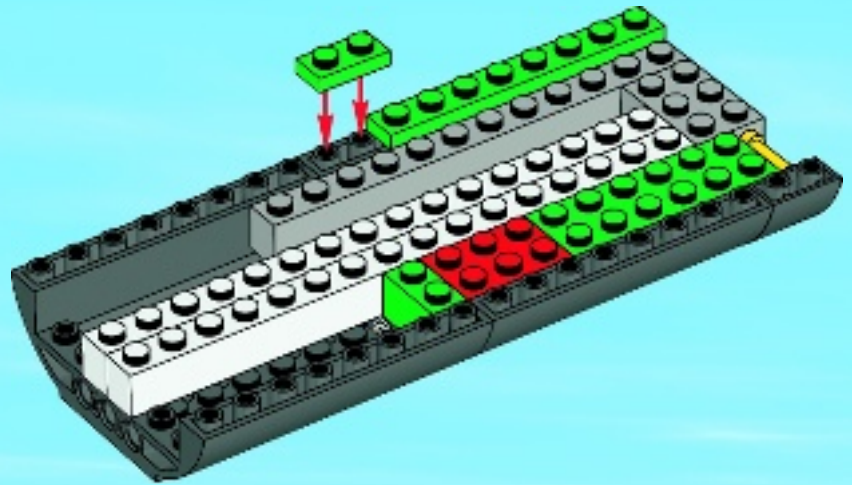

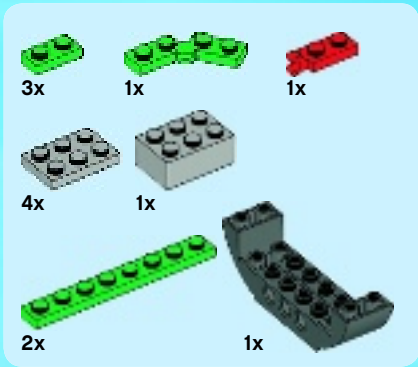

# 8

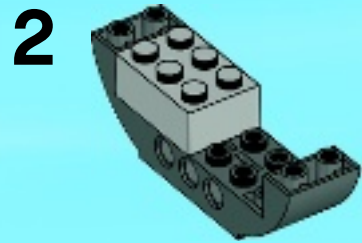
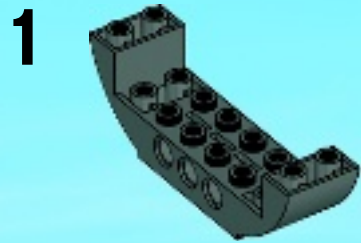

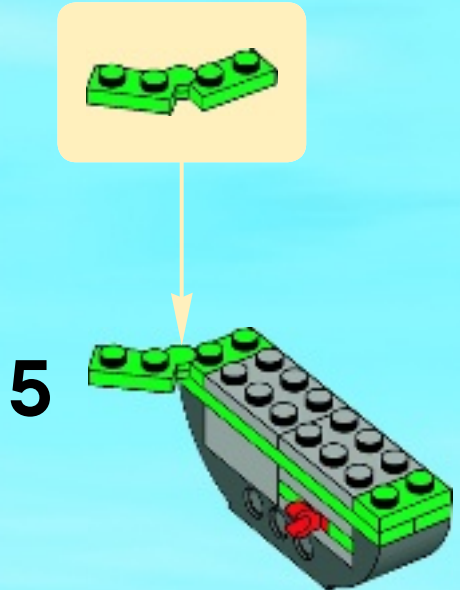
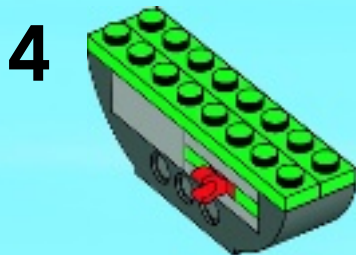
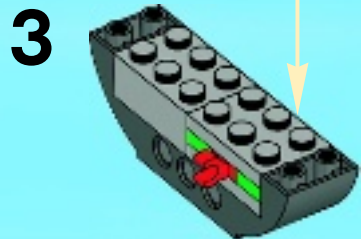
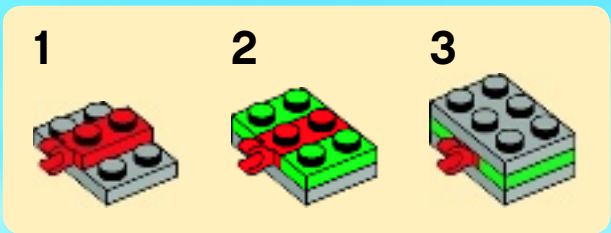



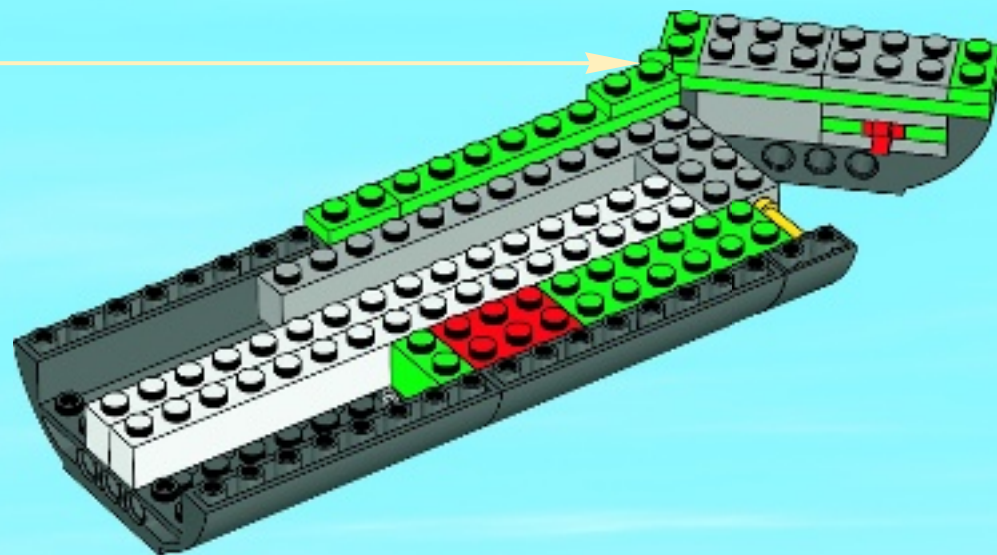

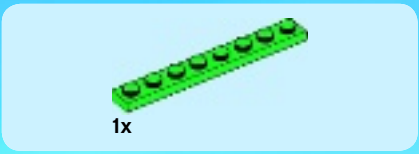

9

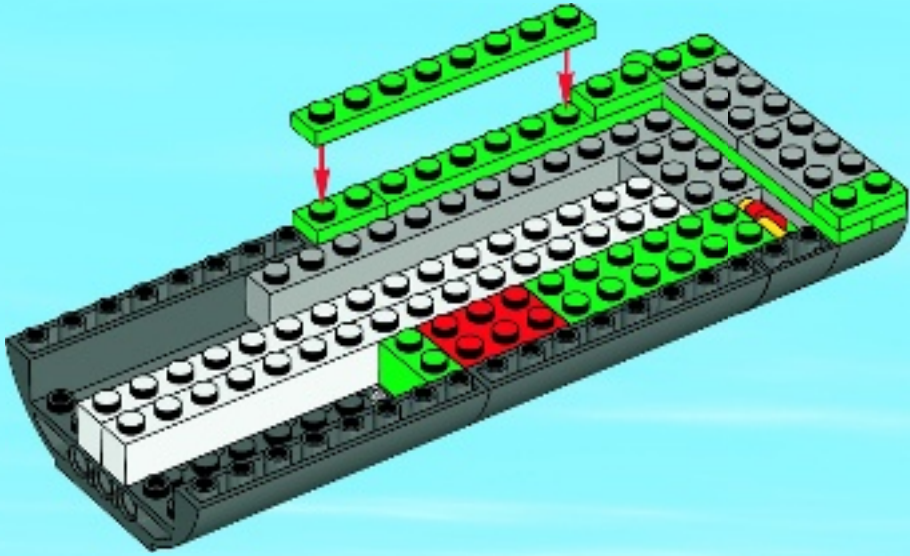



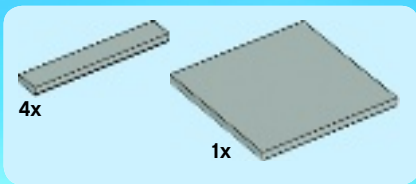

10

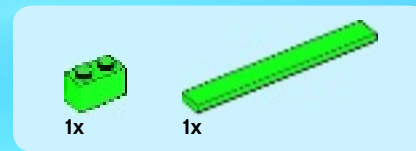
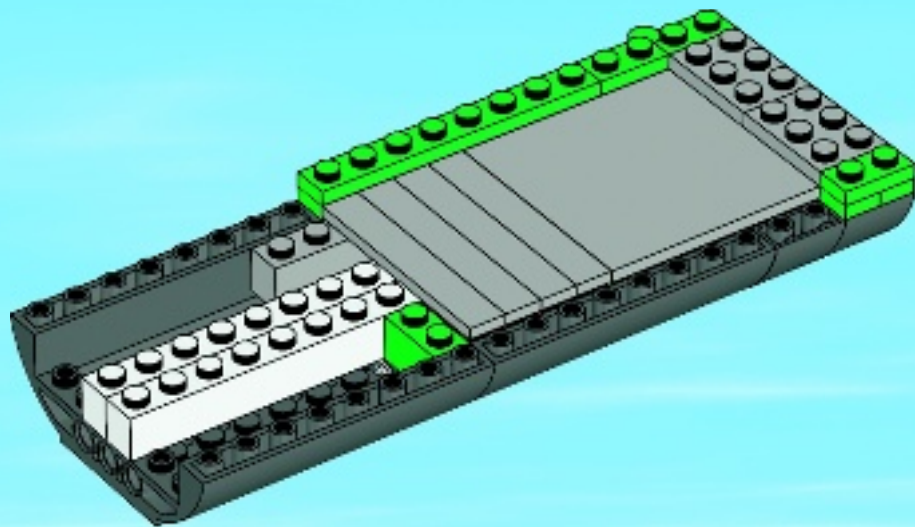

11

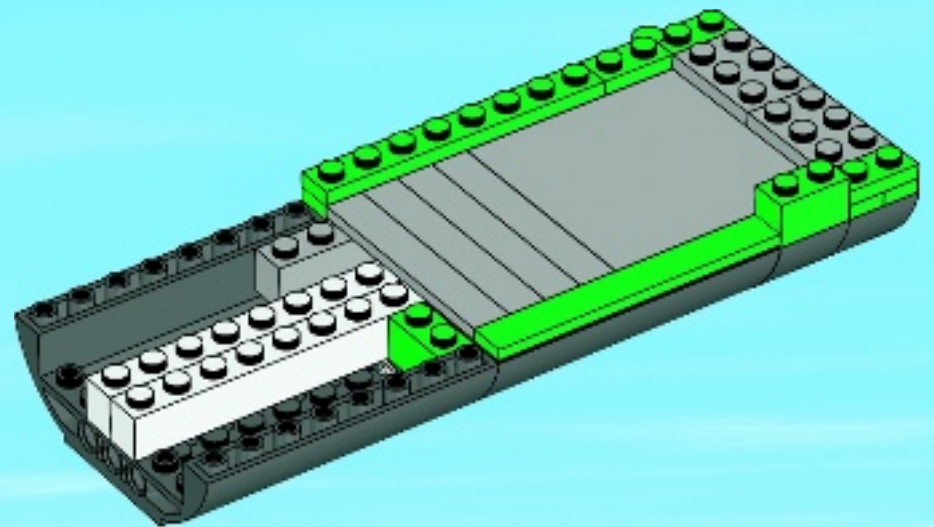

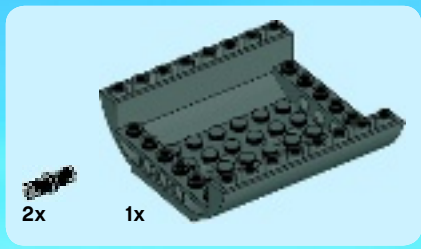

12

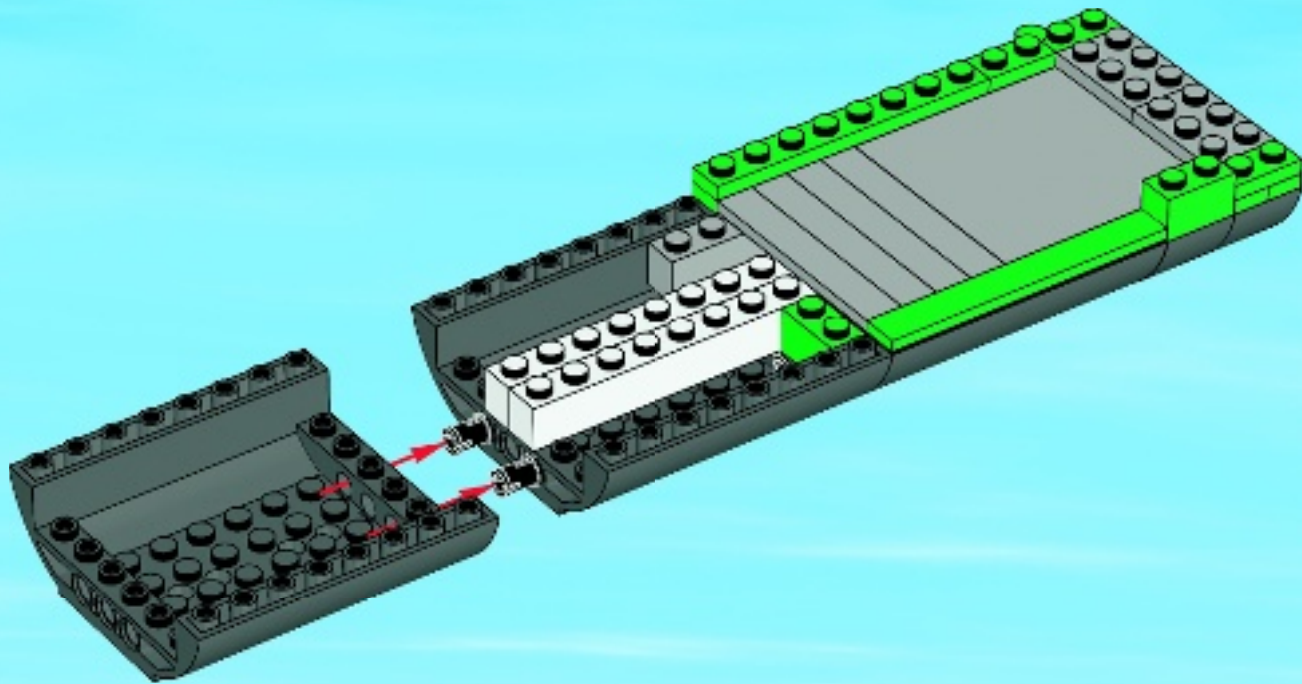



2x

# 13

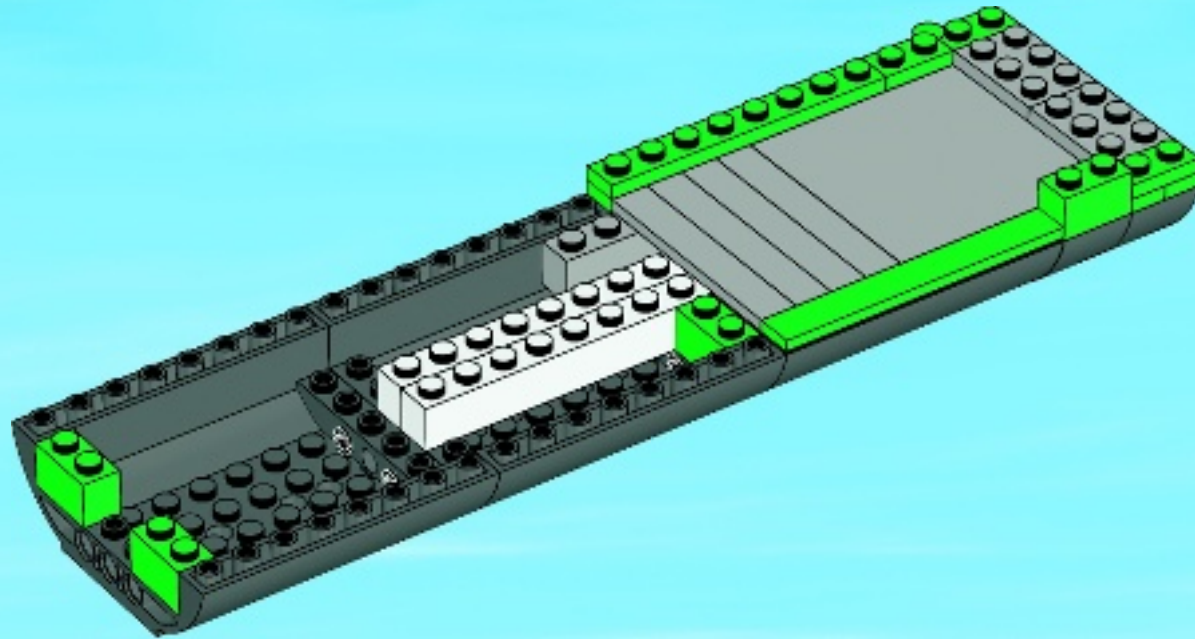

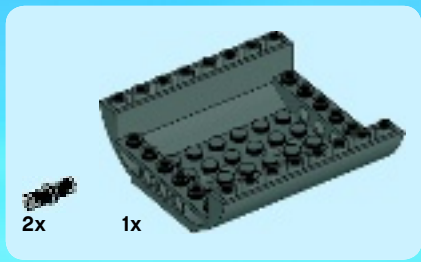

14

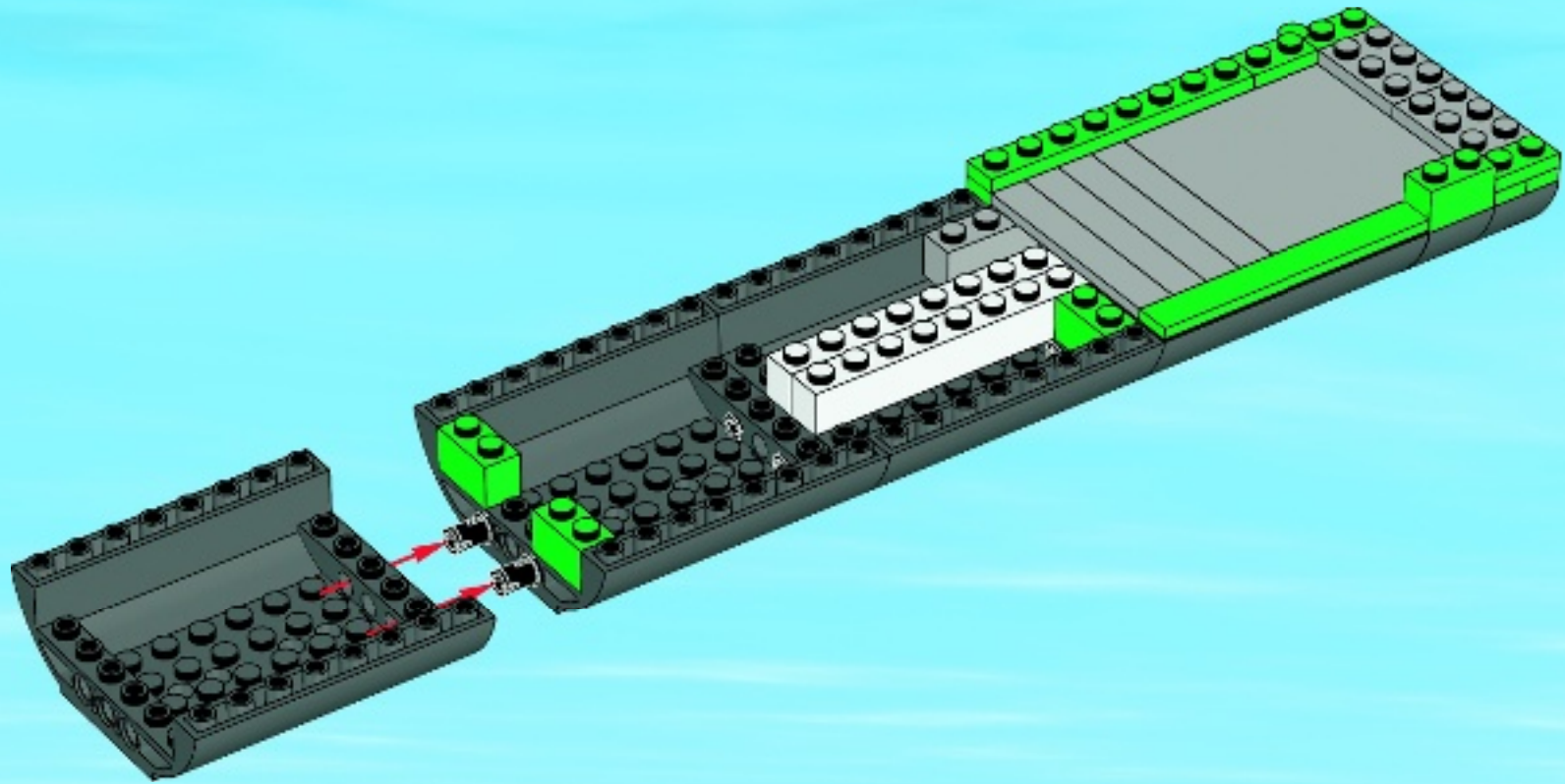



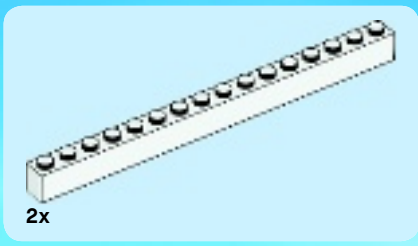

15

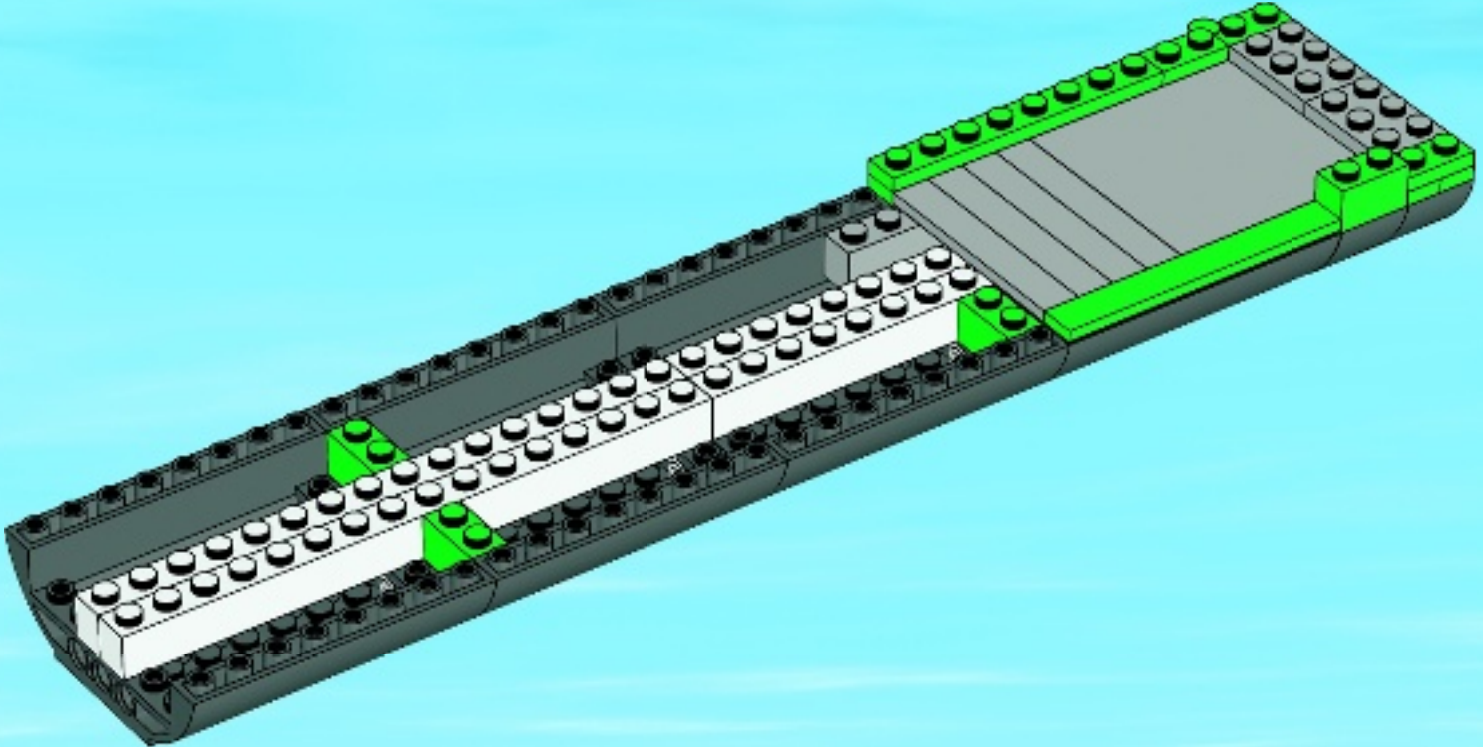

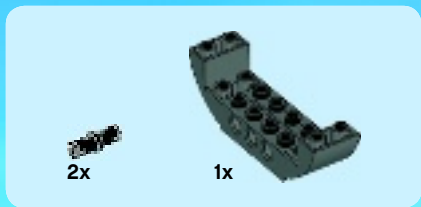

16

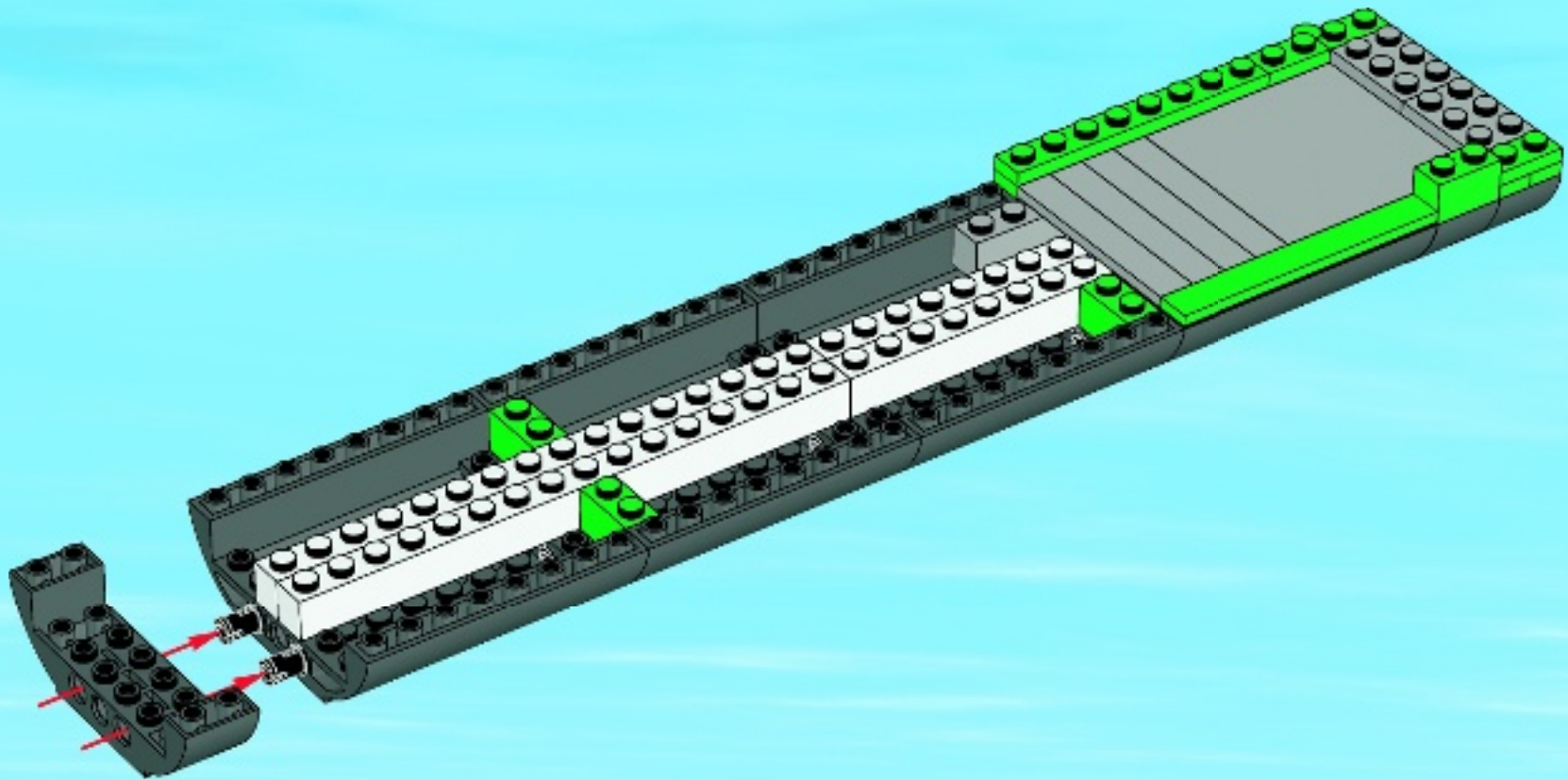





2x

17

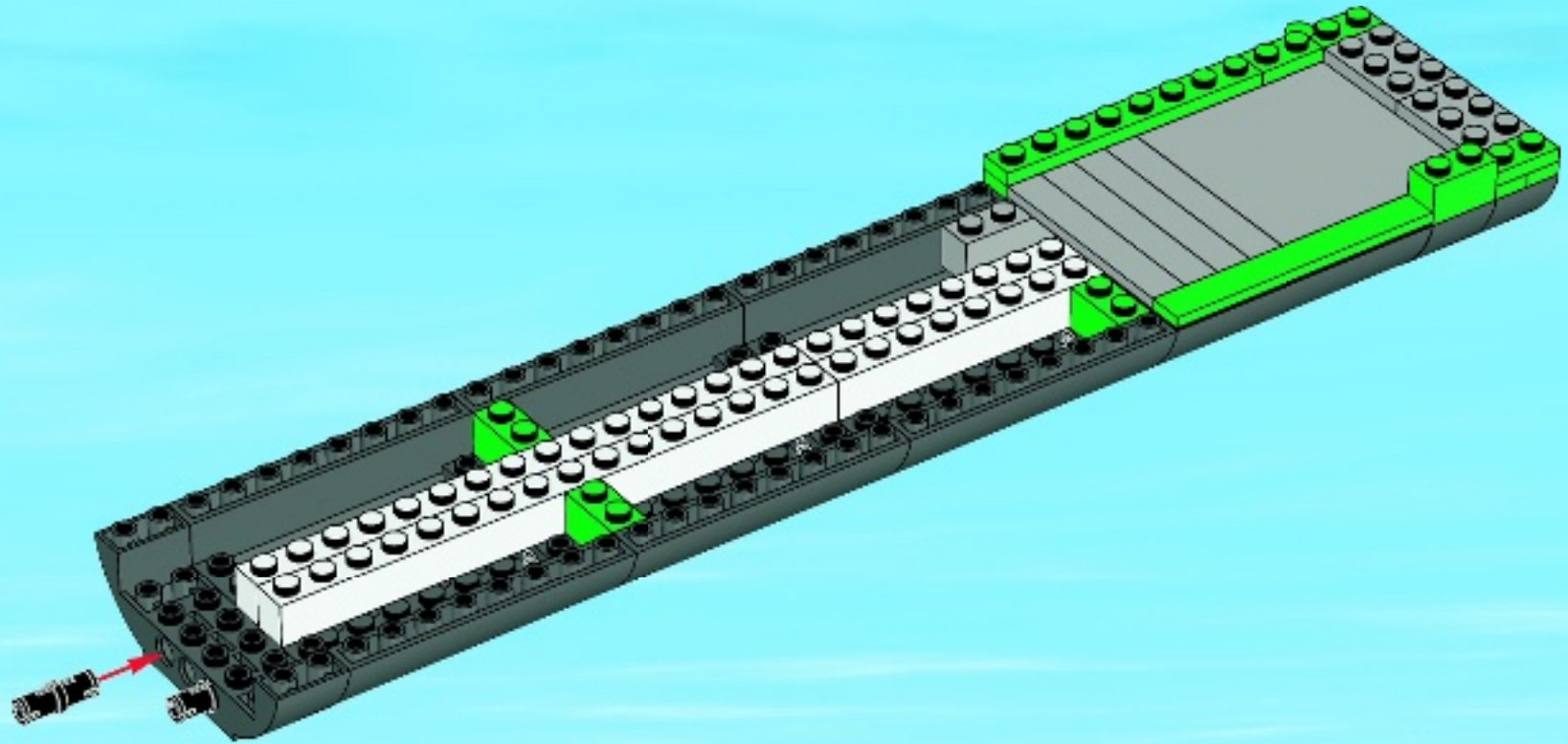



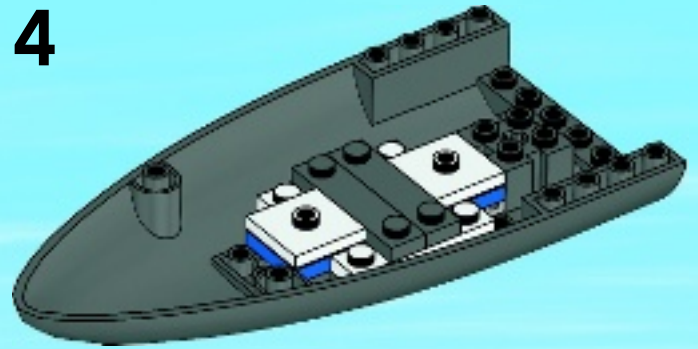
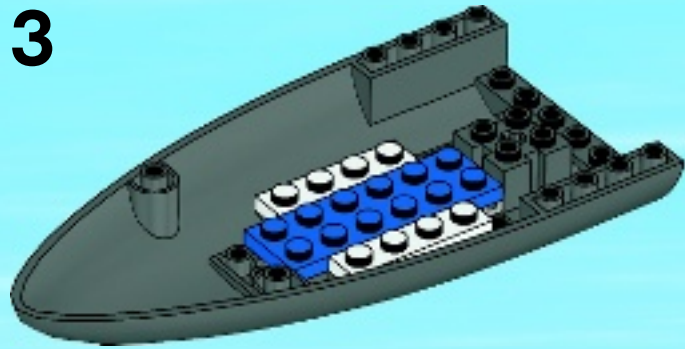

5

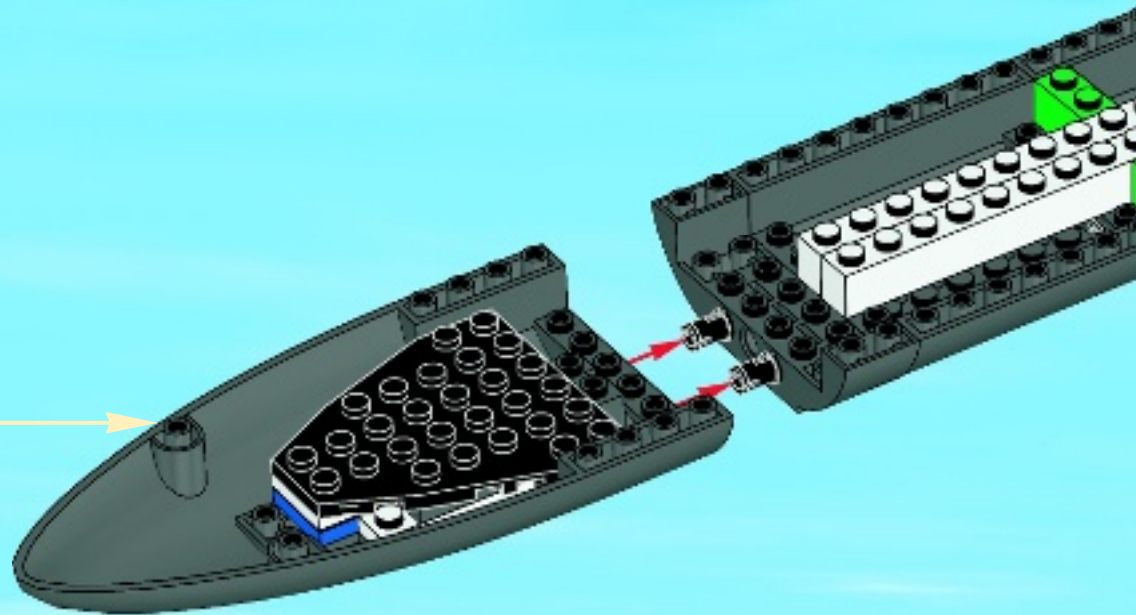
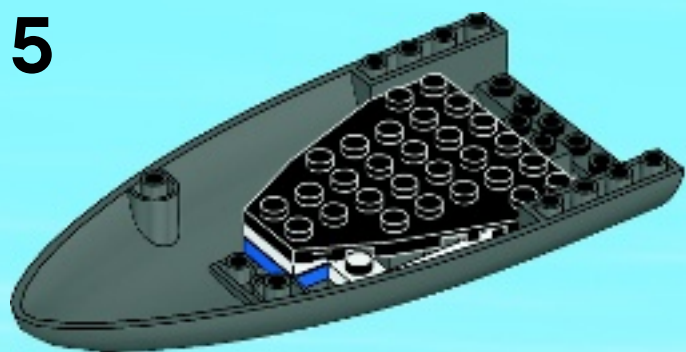



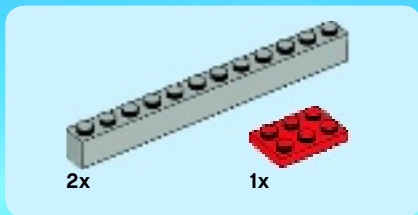

19

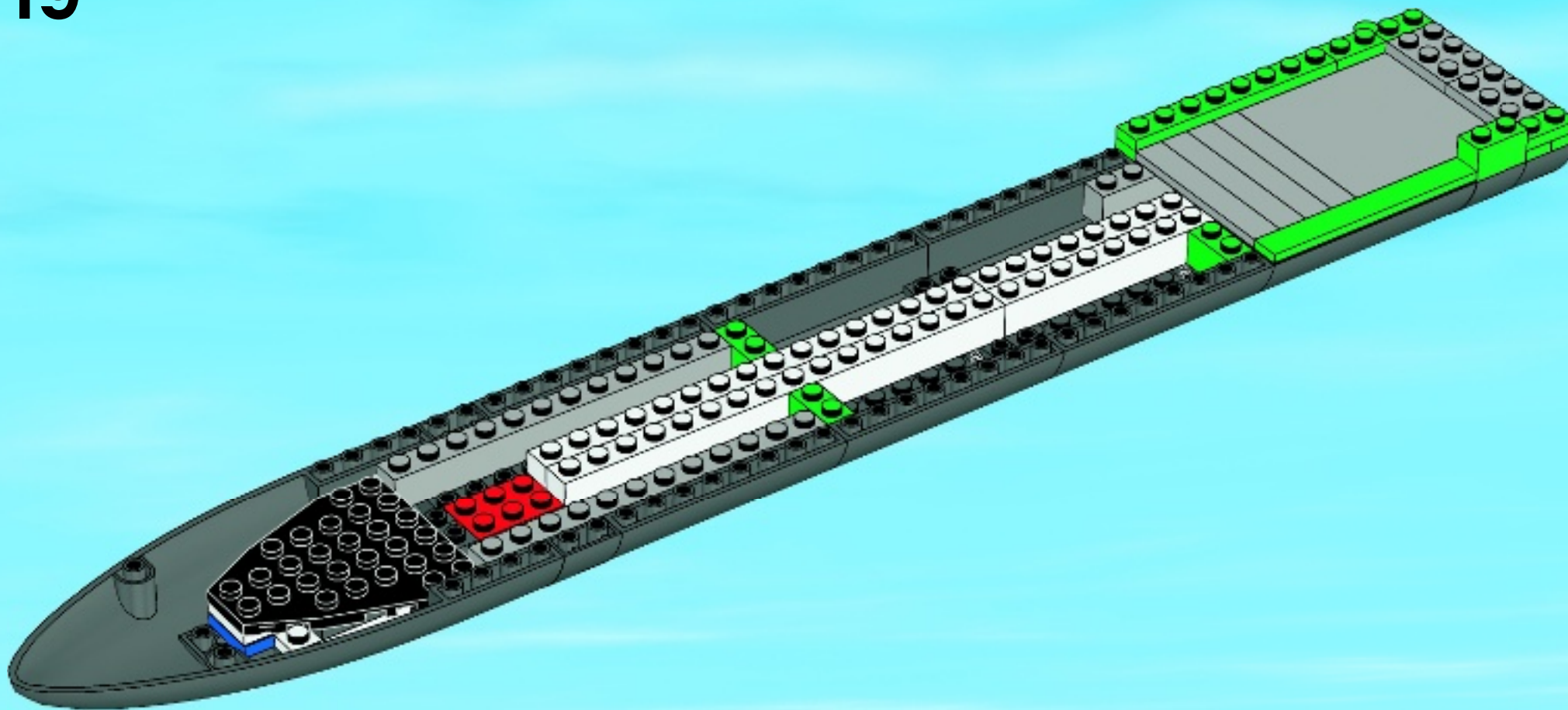



2x

# 20

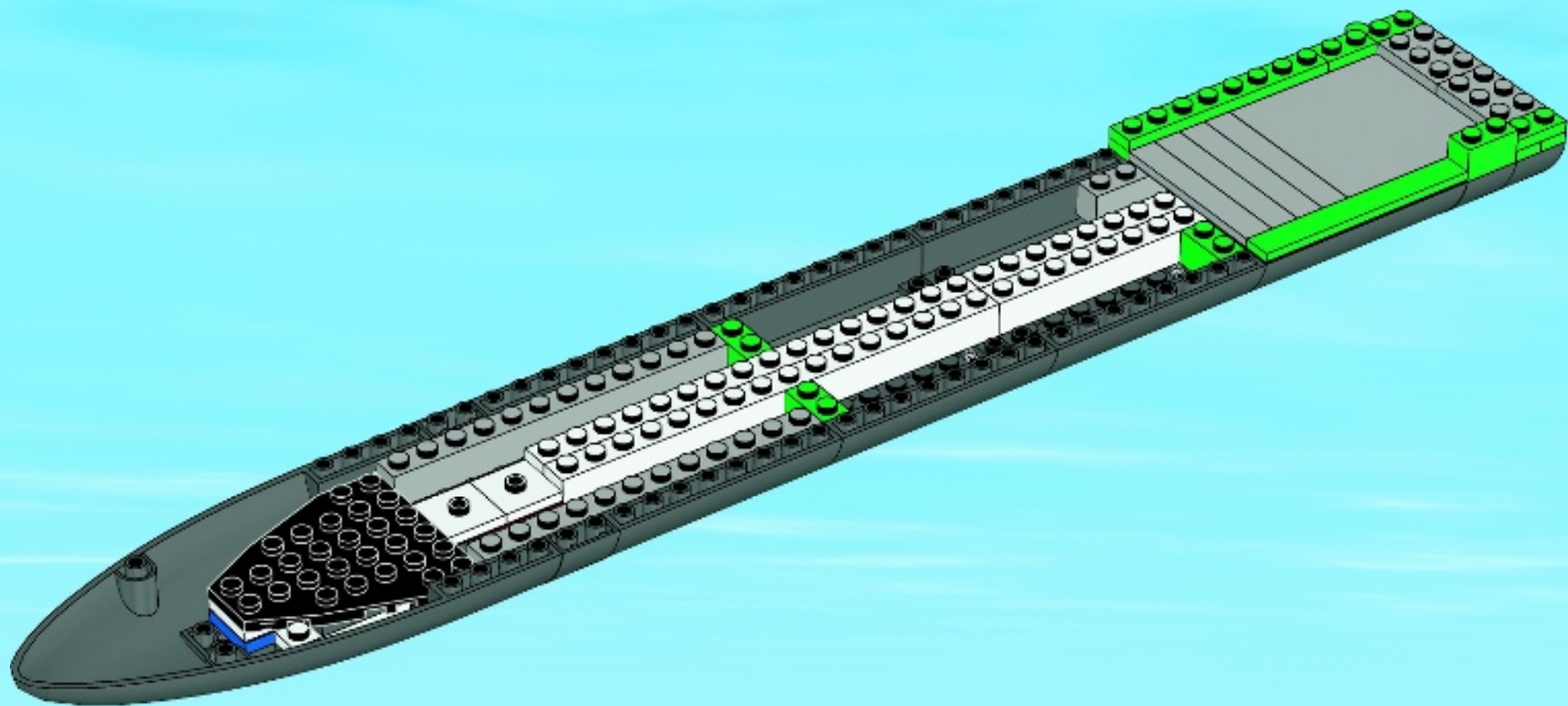



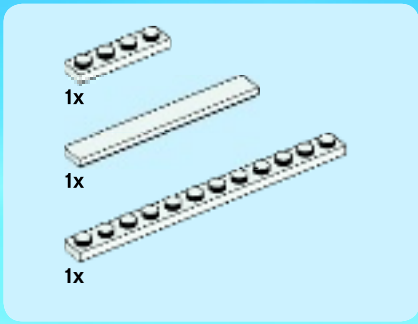

21

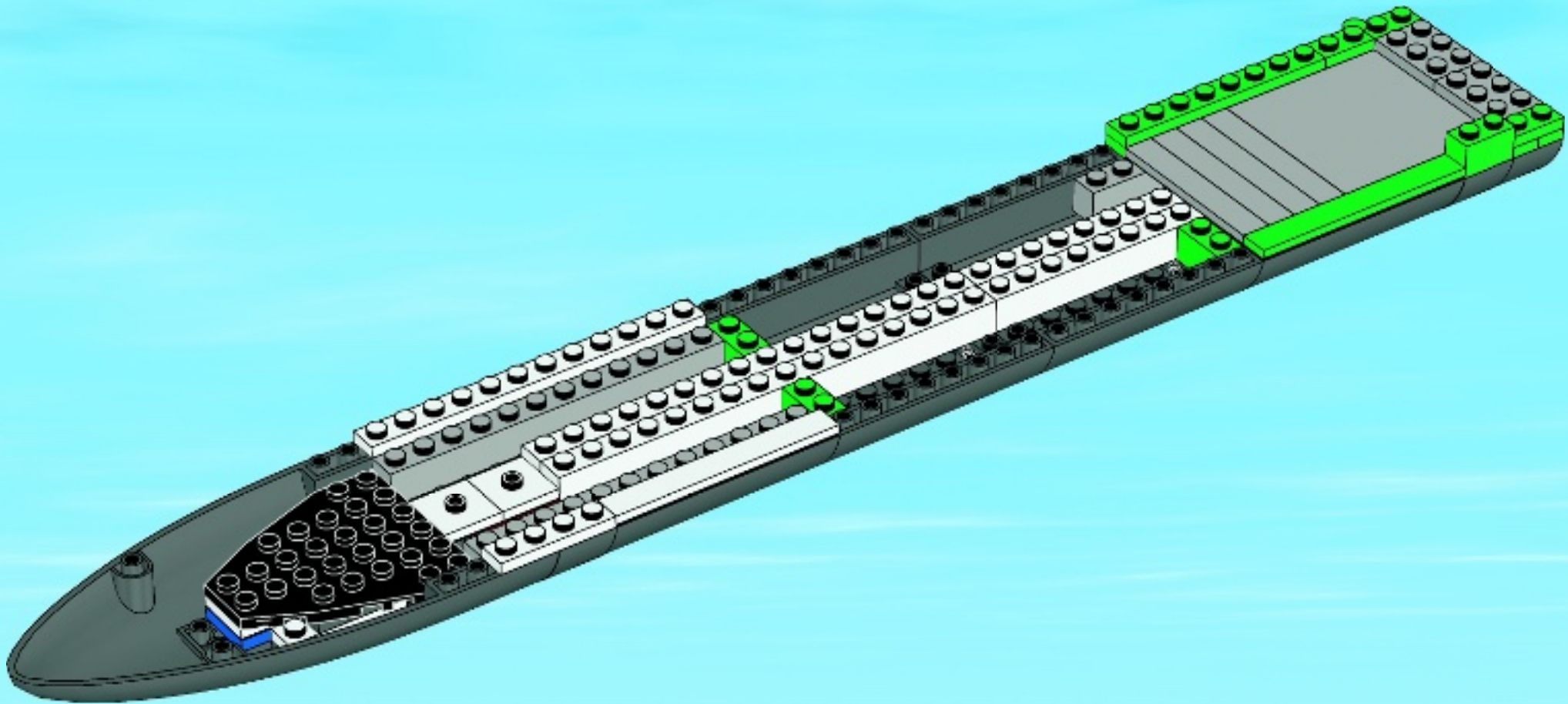

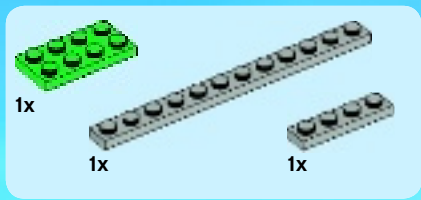

22

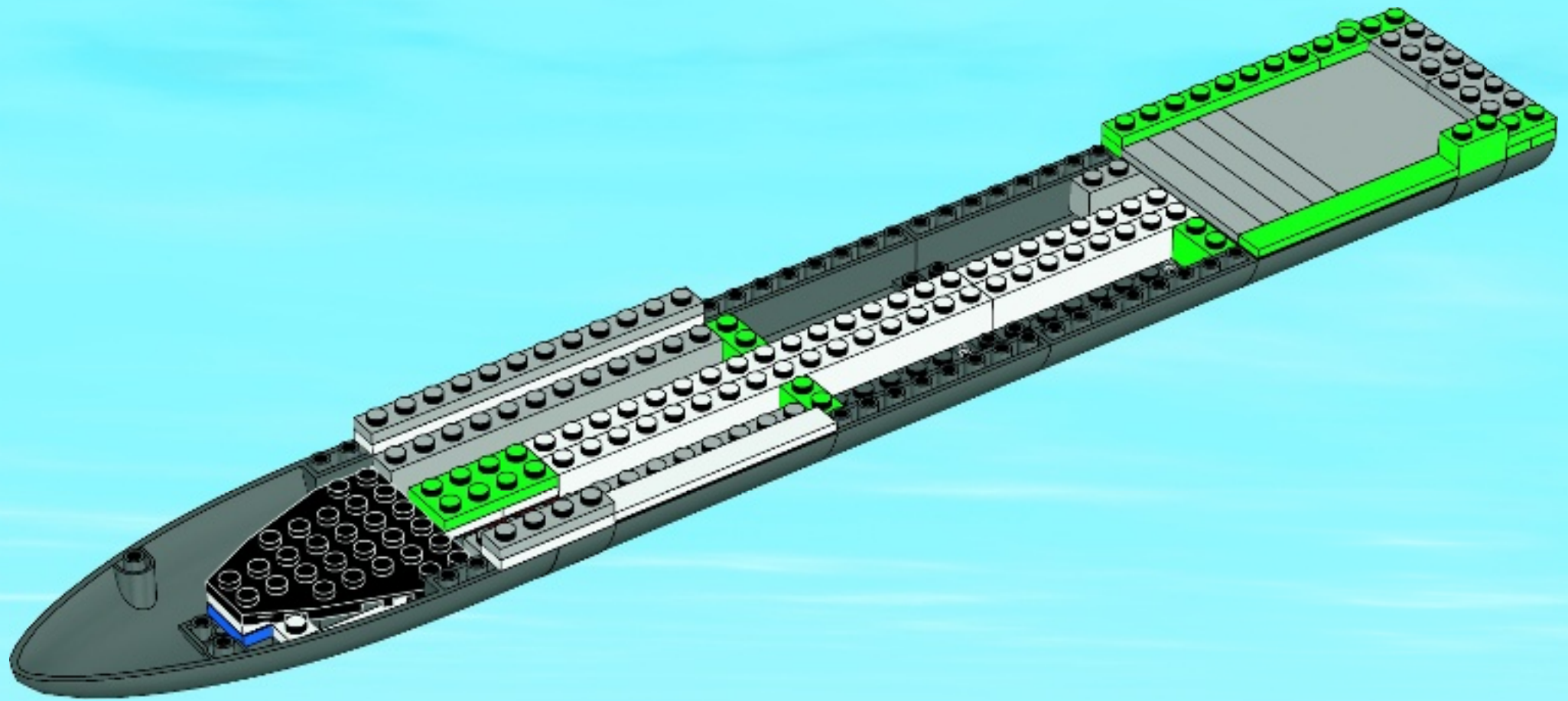

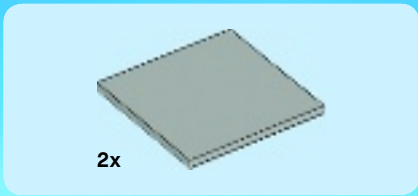

23

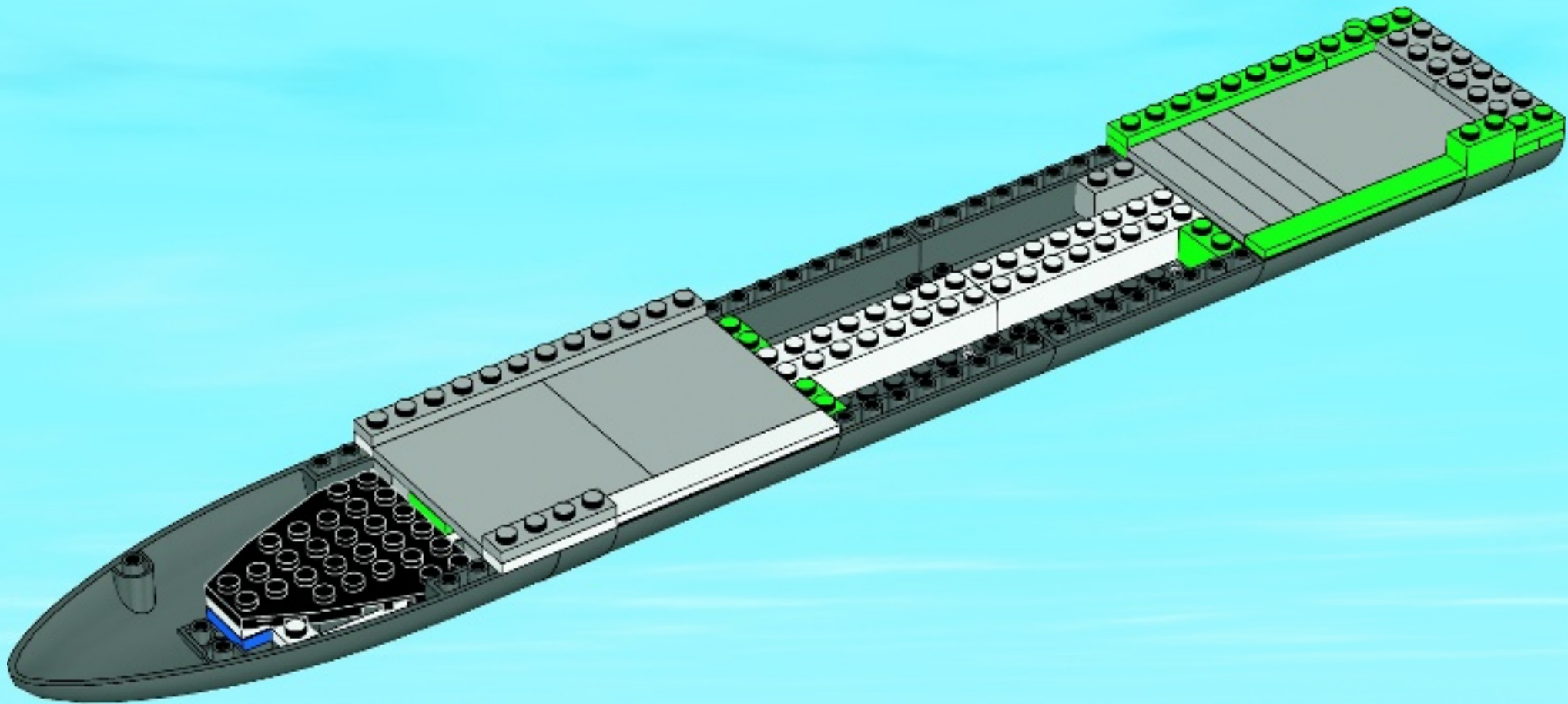





4x



1x

# 24

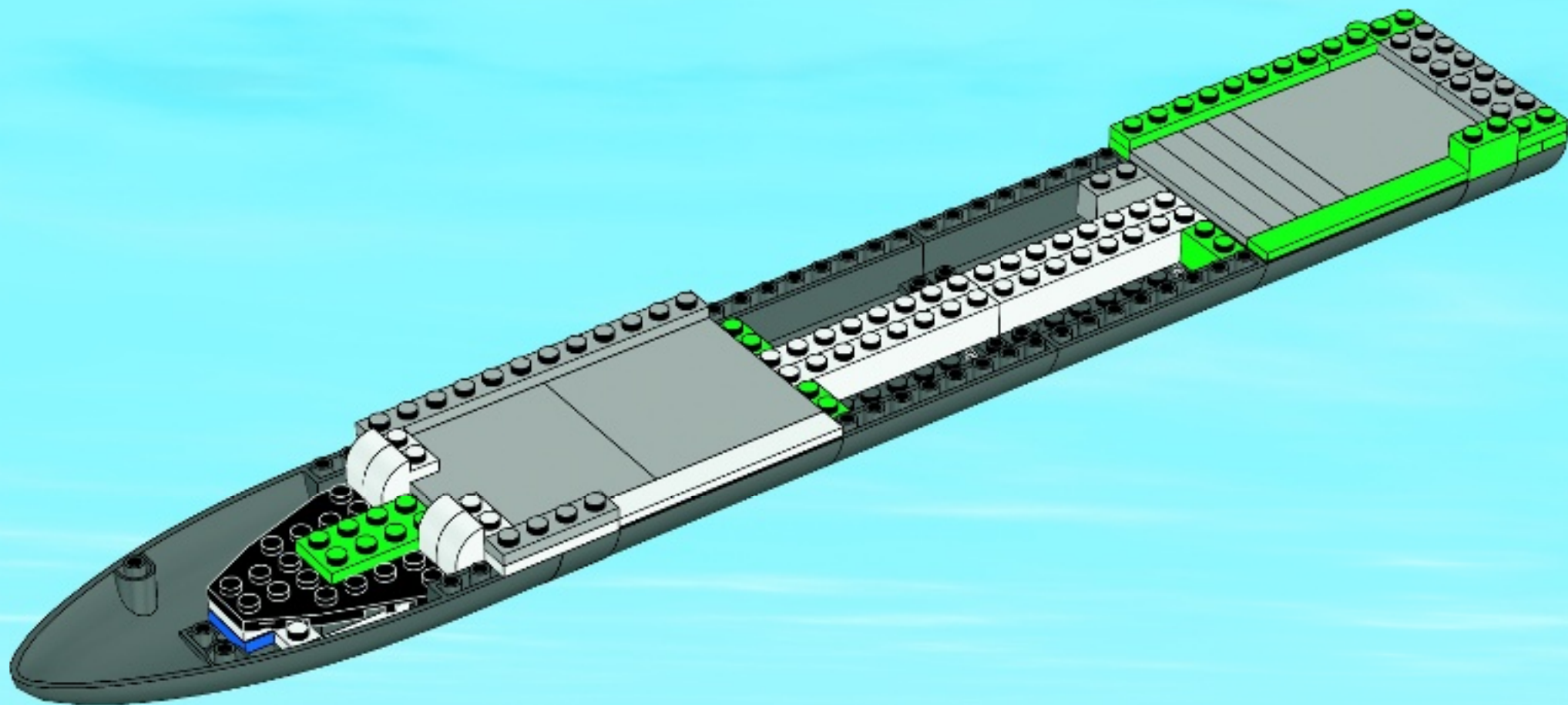



3x

25

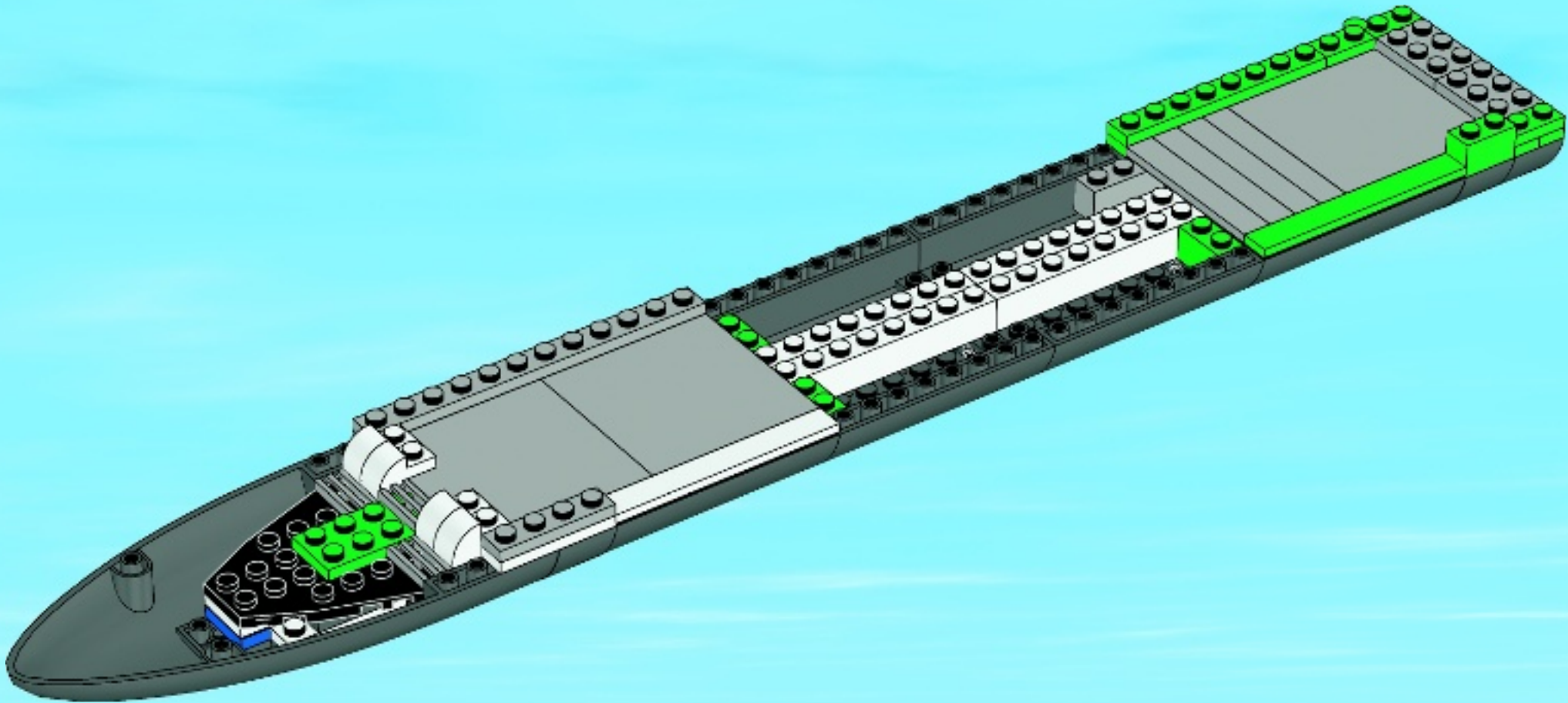



2x

# 26

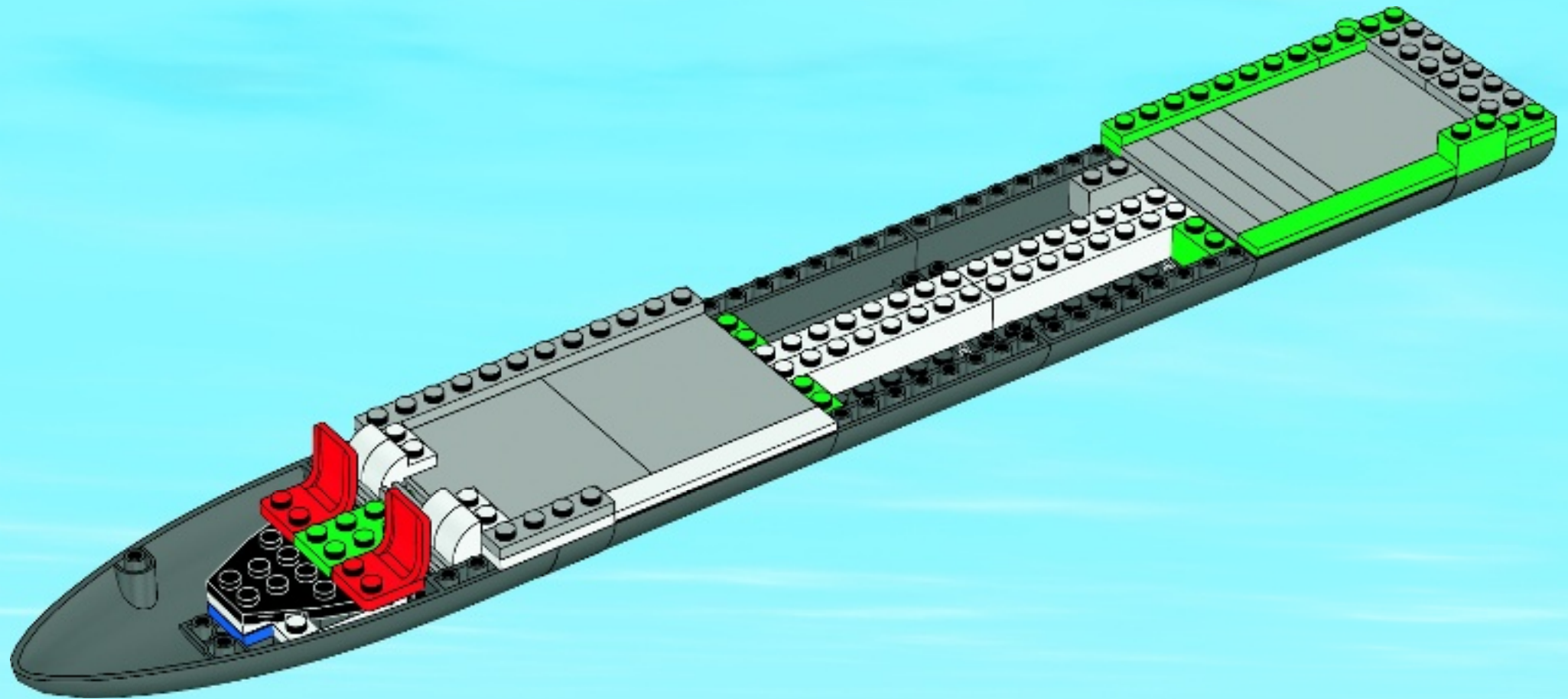



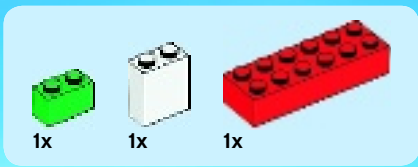

27

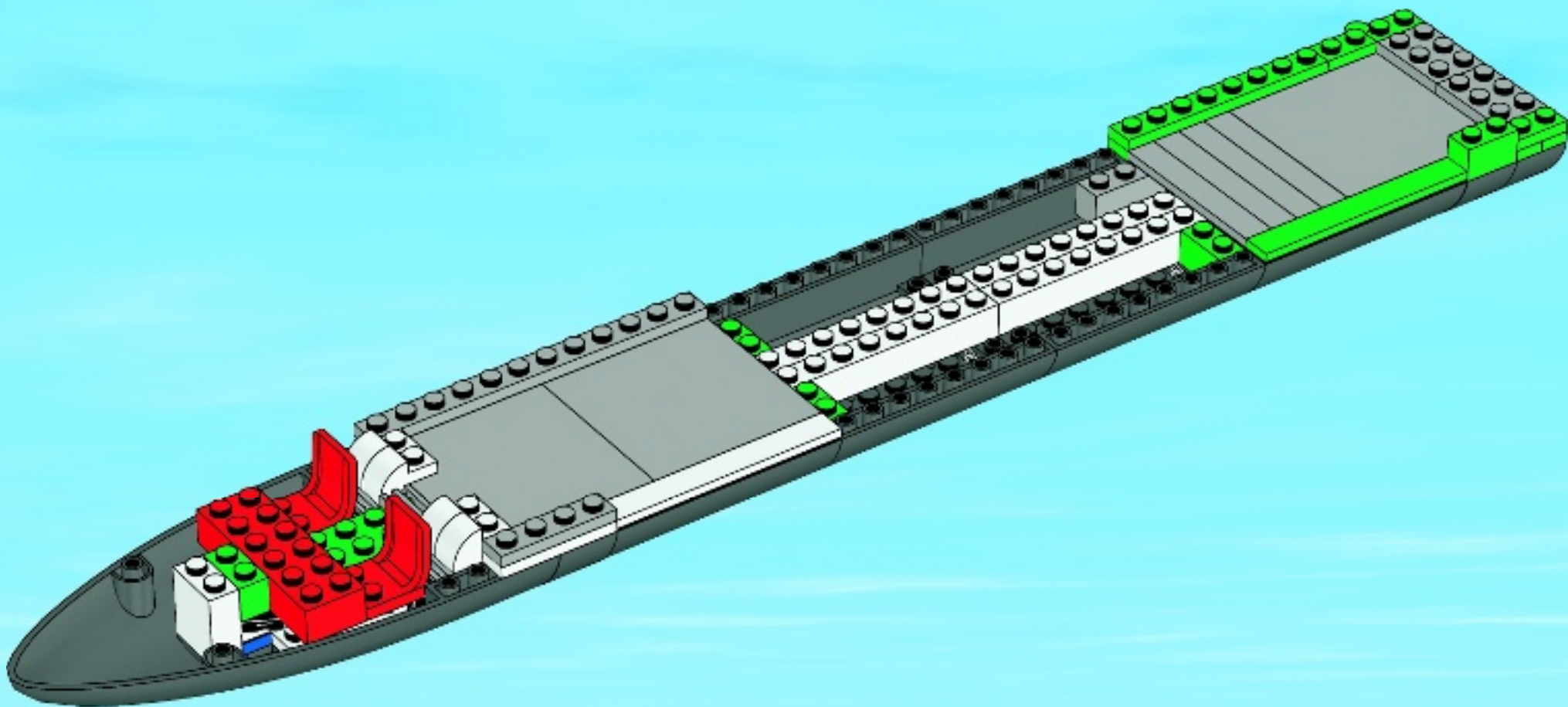



1x

# 28

1

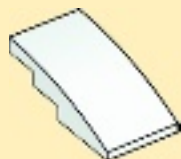

2

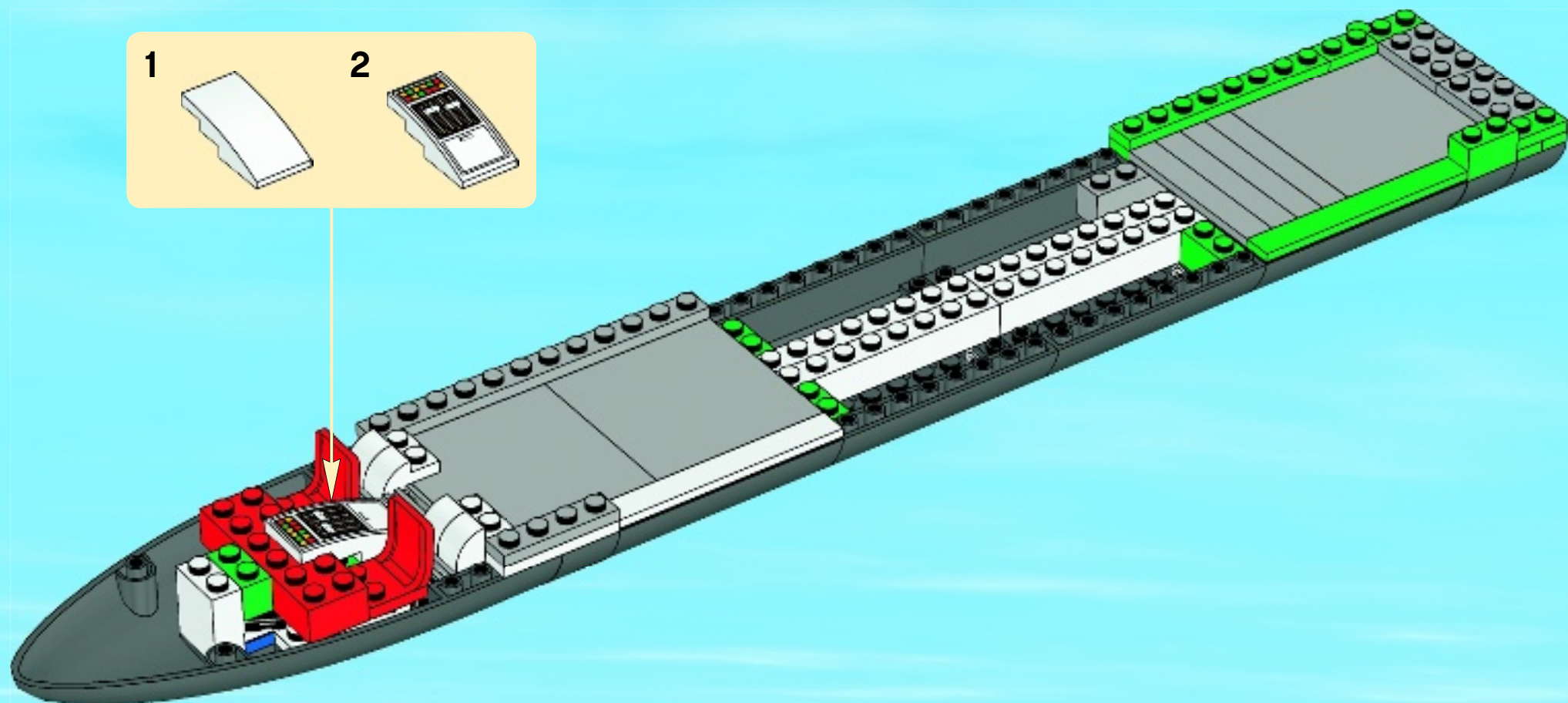



# 29

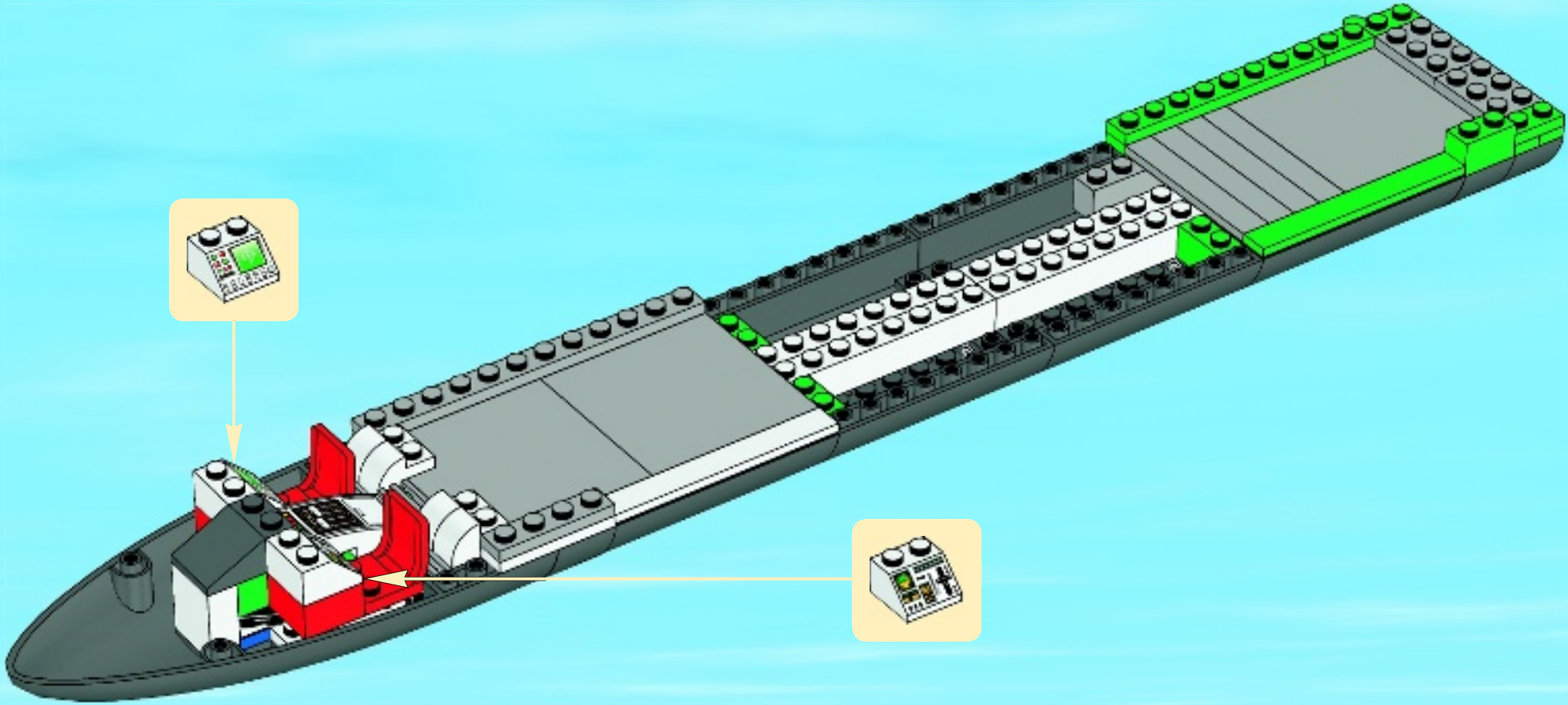



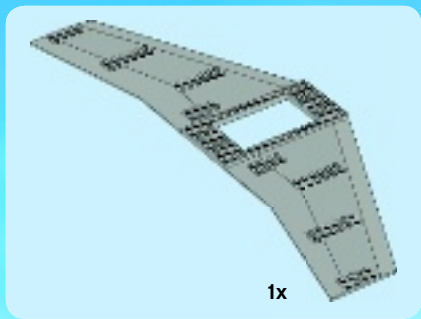

30

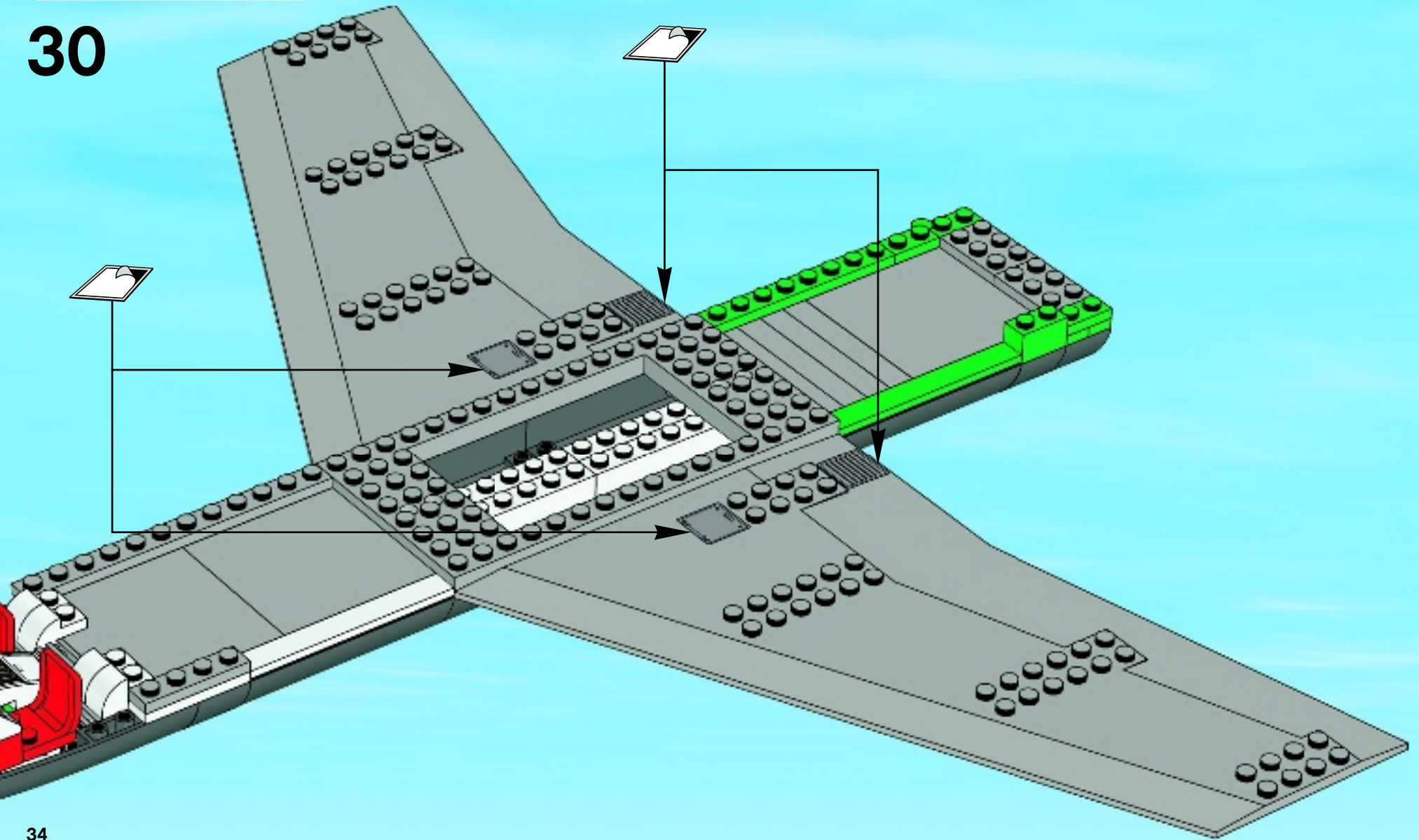

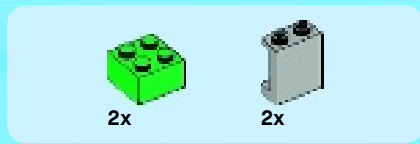
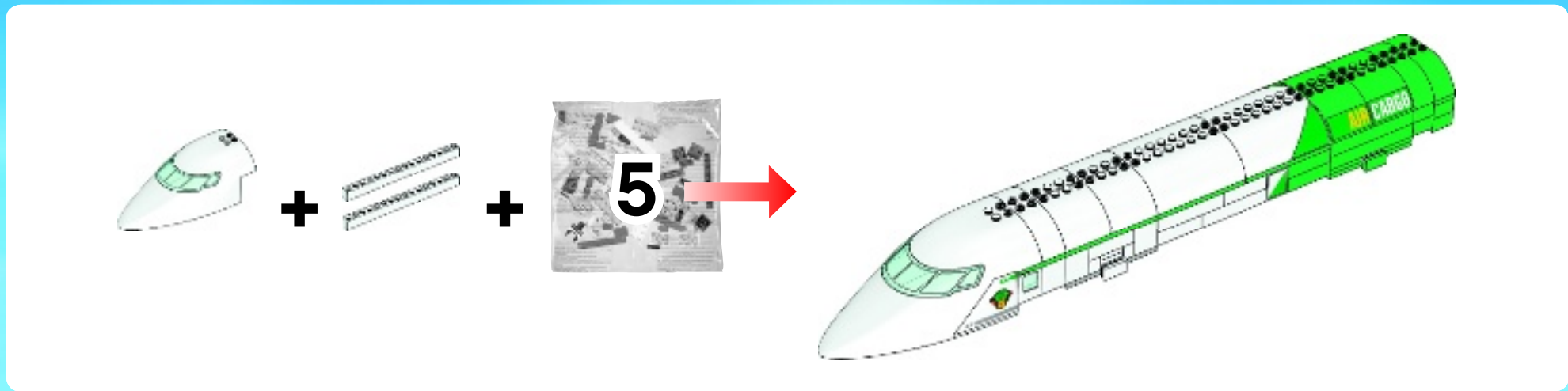

31

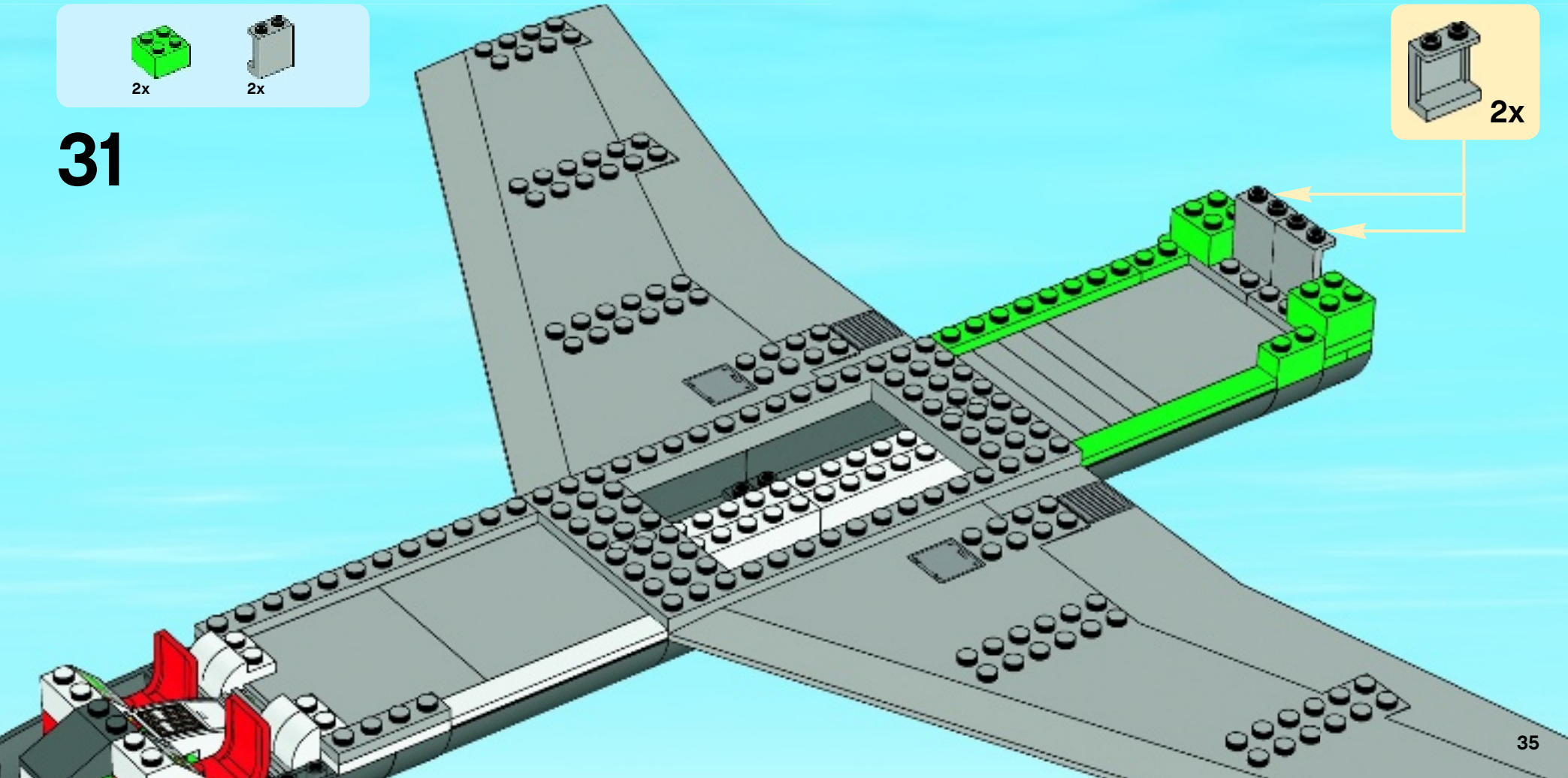
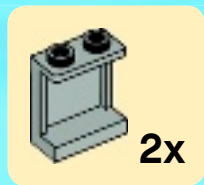





2x



2x

# 32

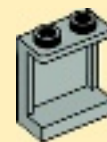

2x

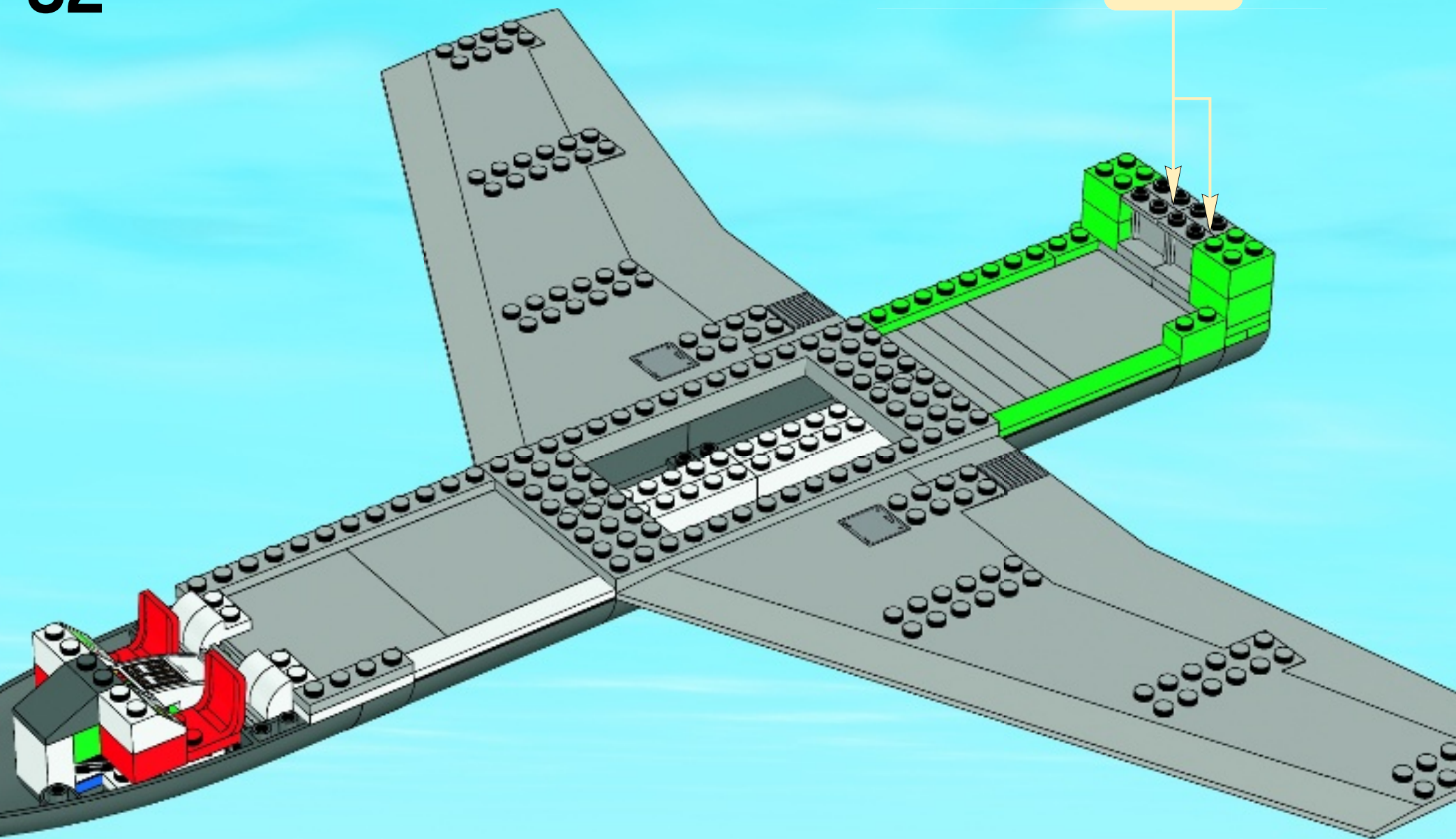



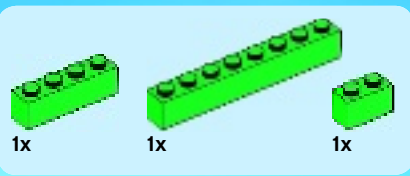

33

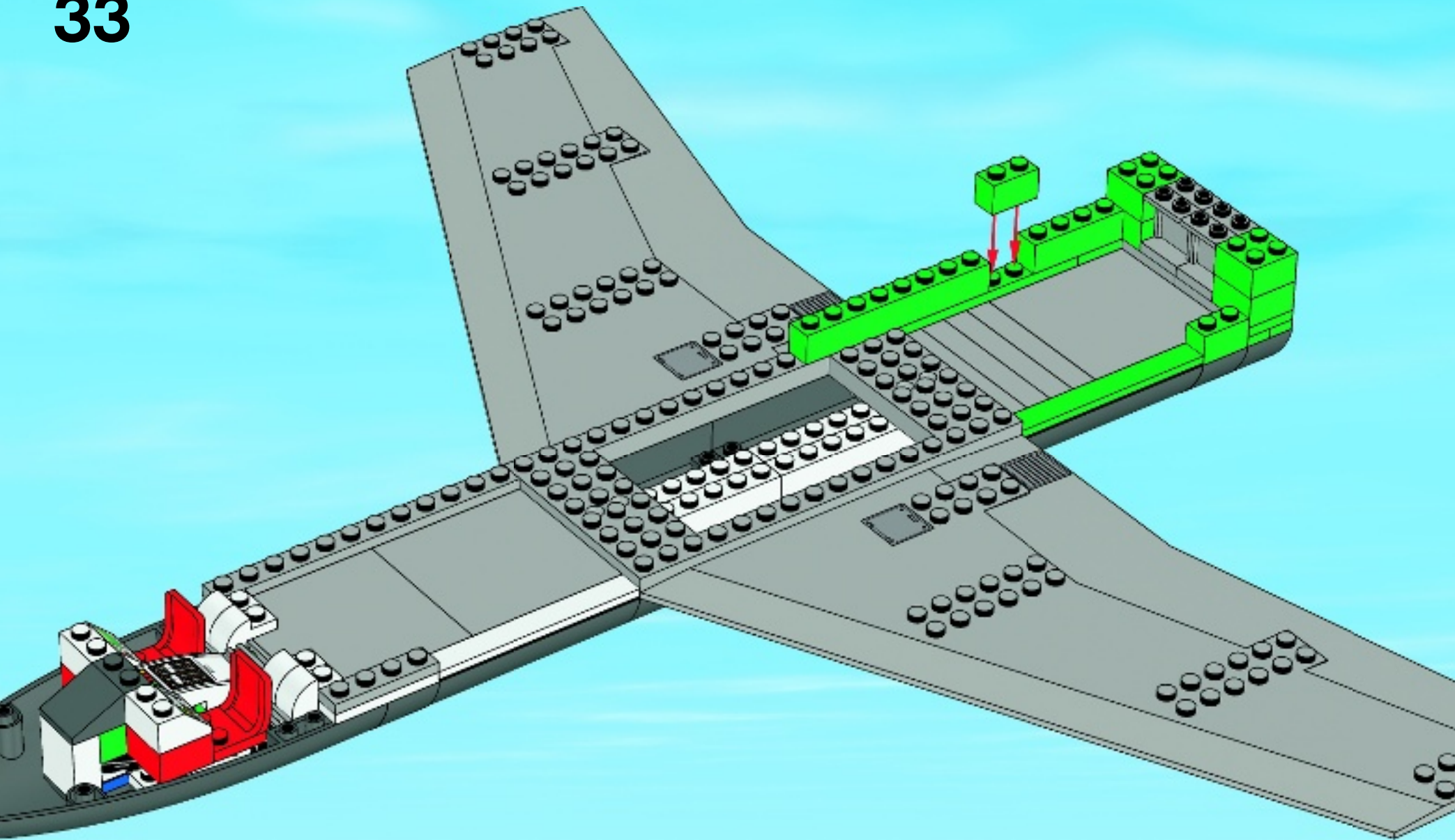

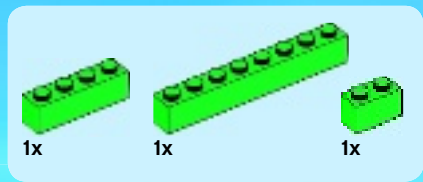

34

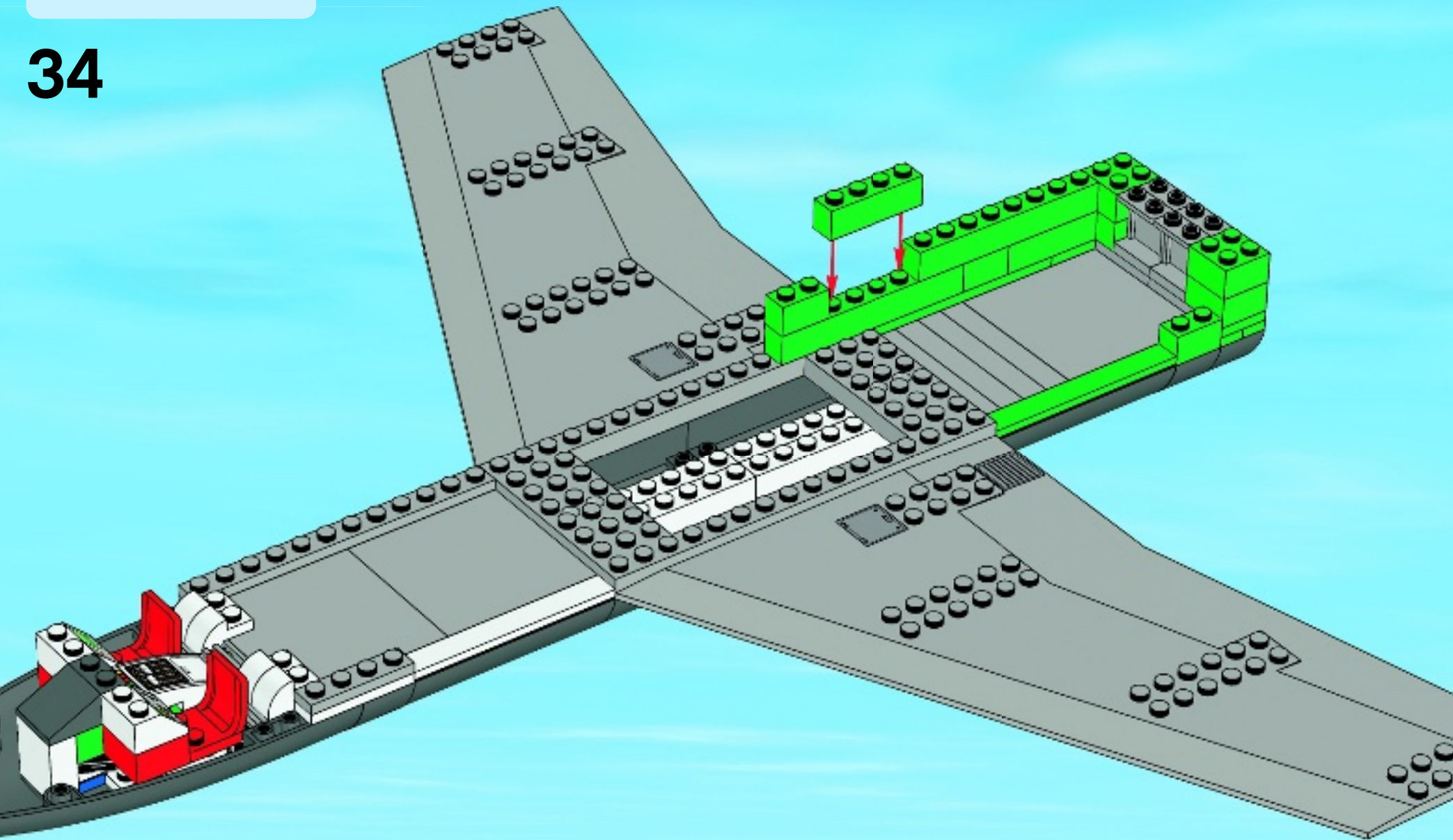



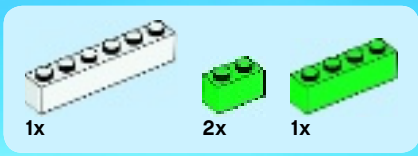

35

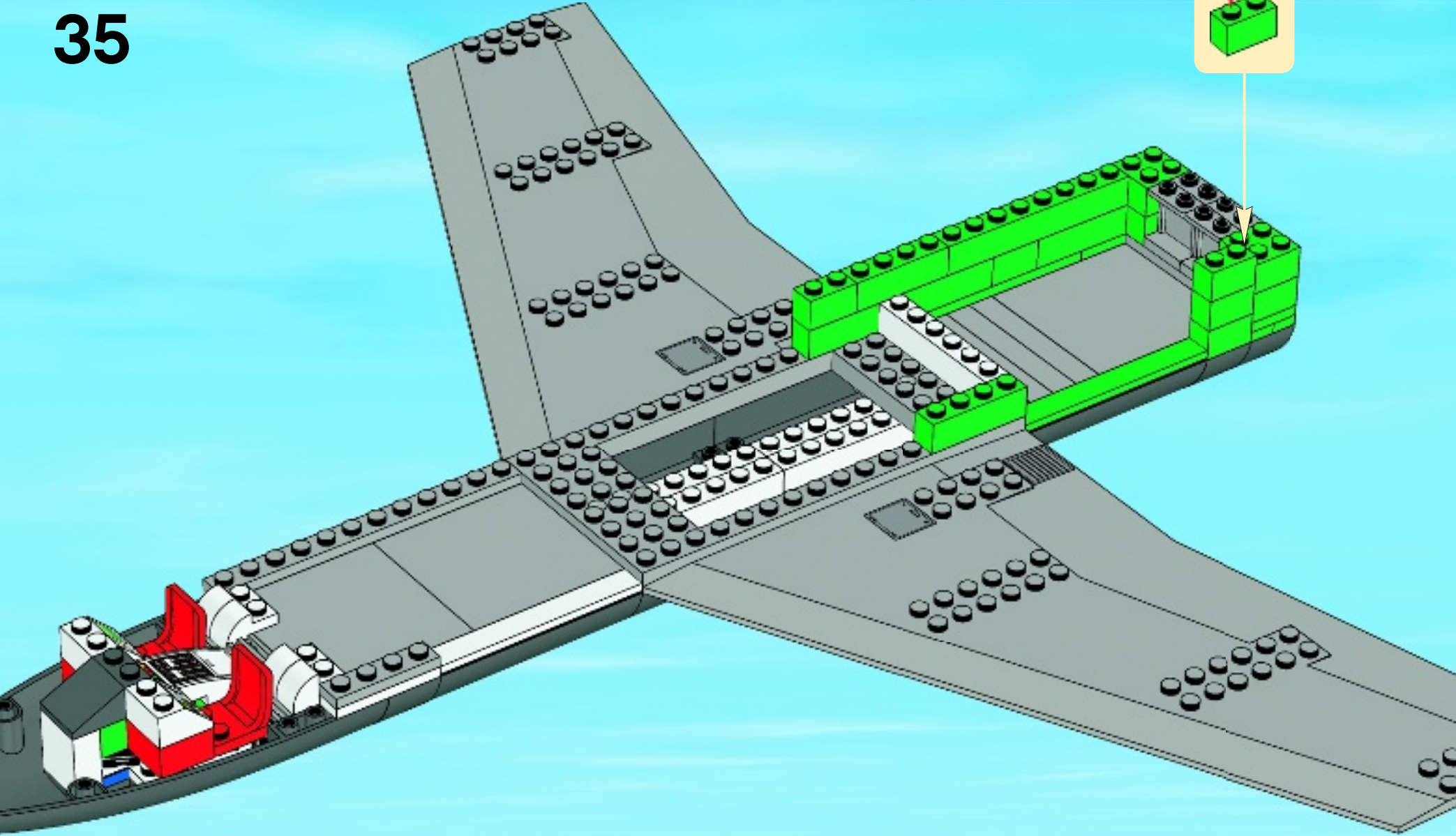
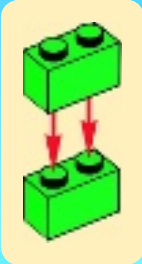

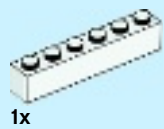

1x

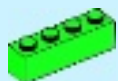

1x

# 36

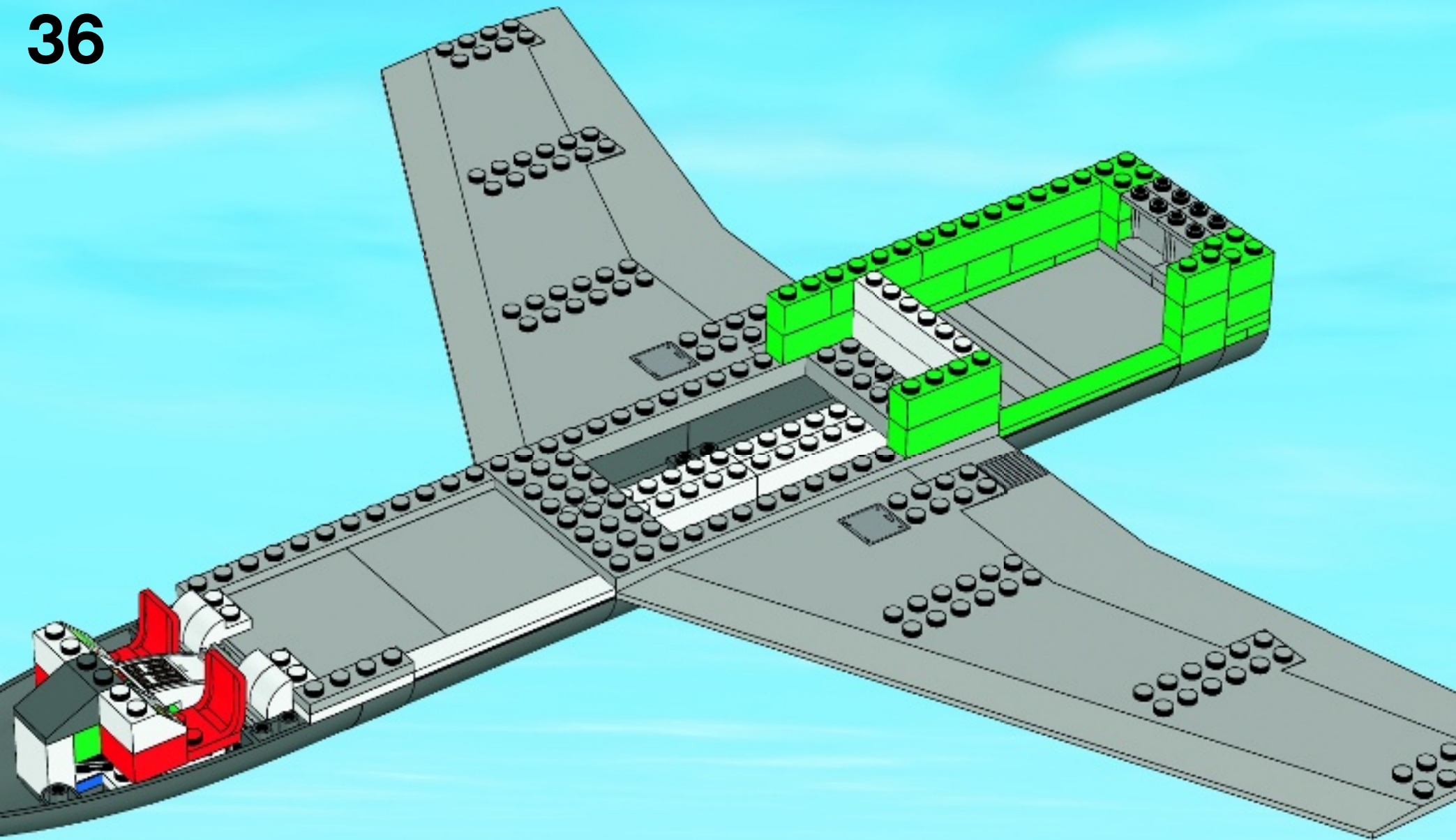





2x

# 37

1



2



1



2





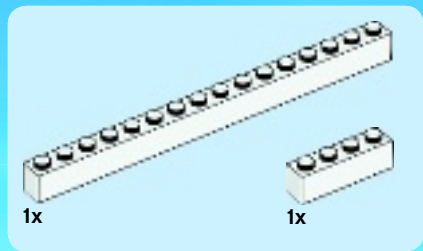

38

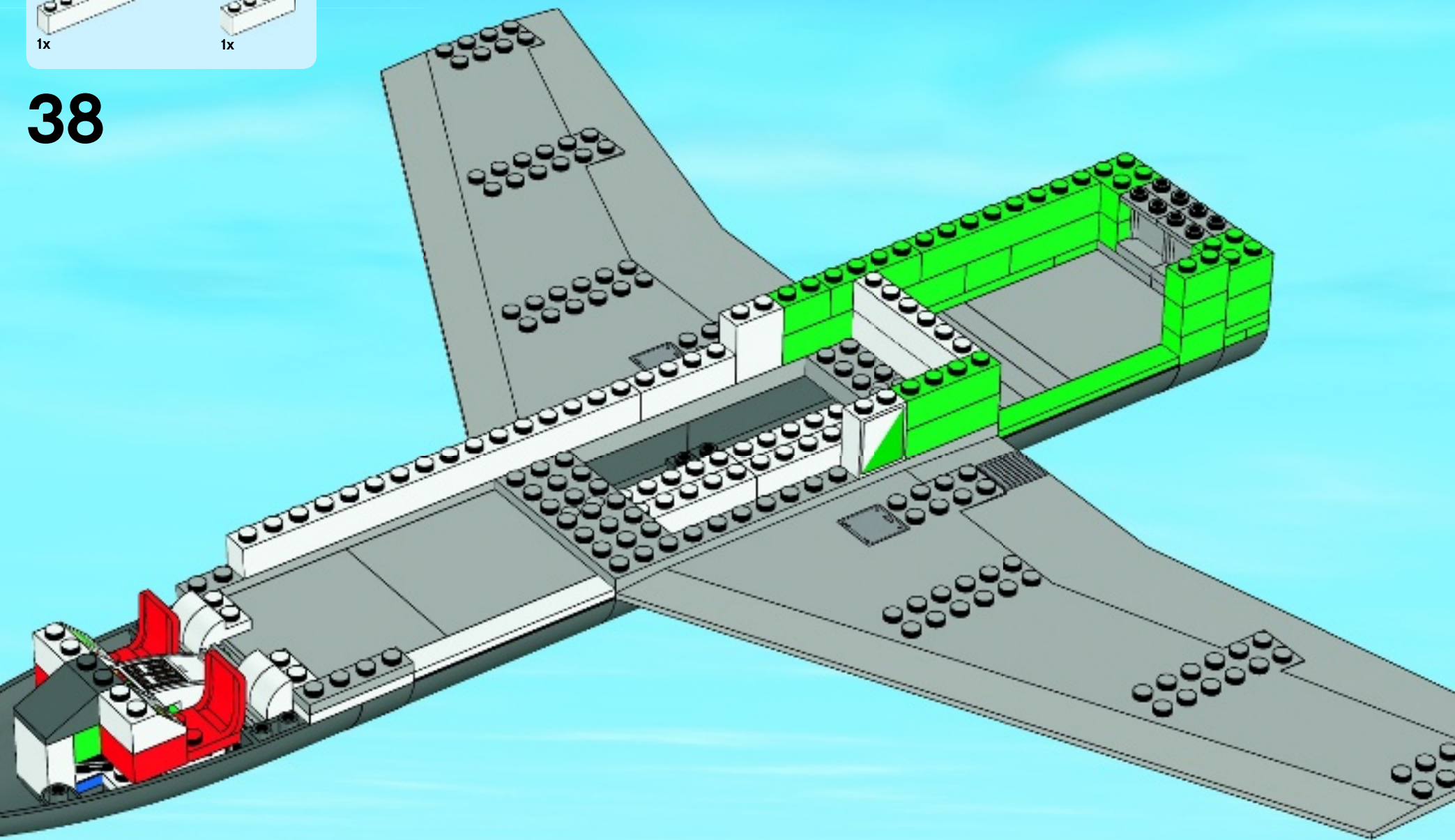

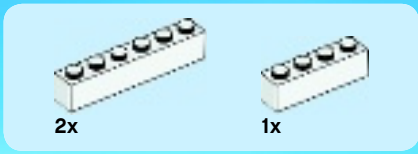

39

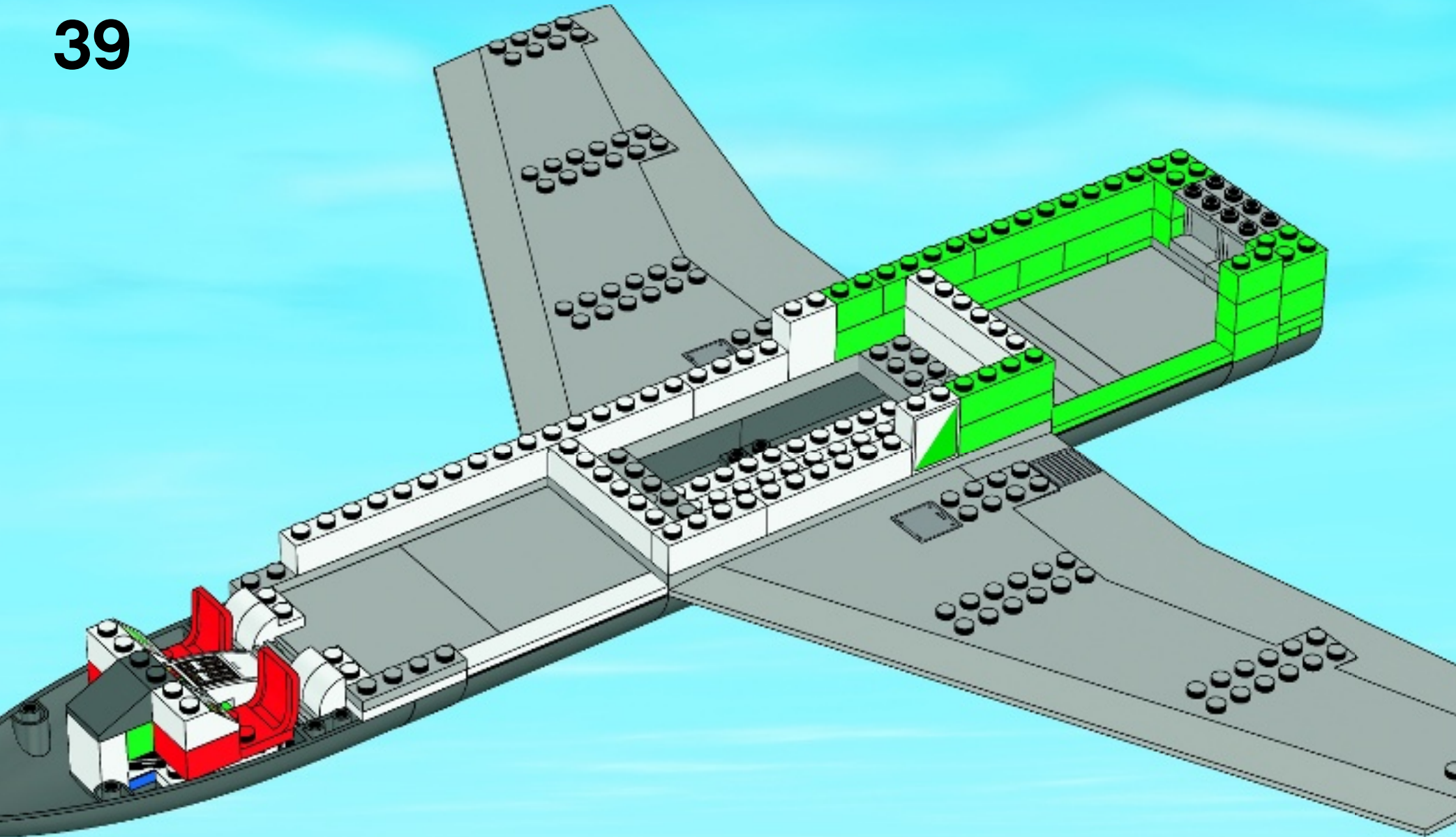



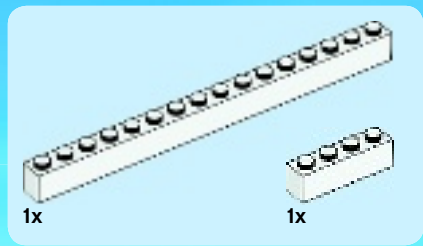

40

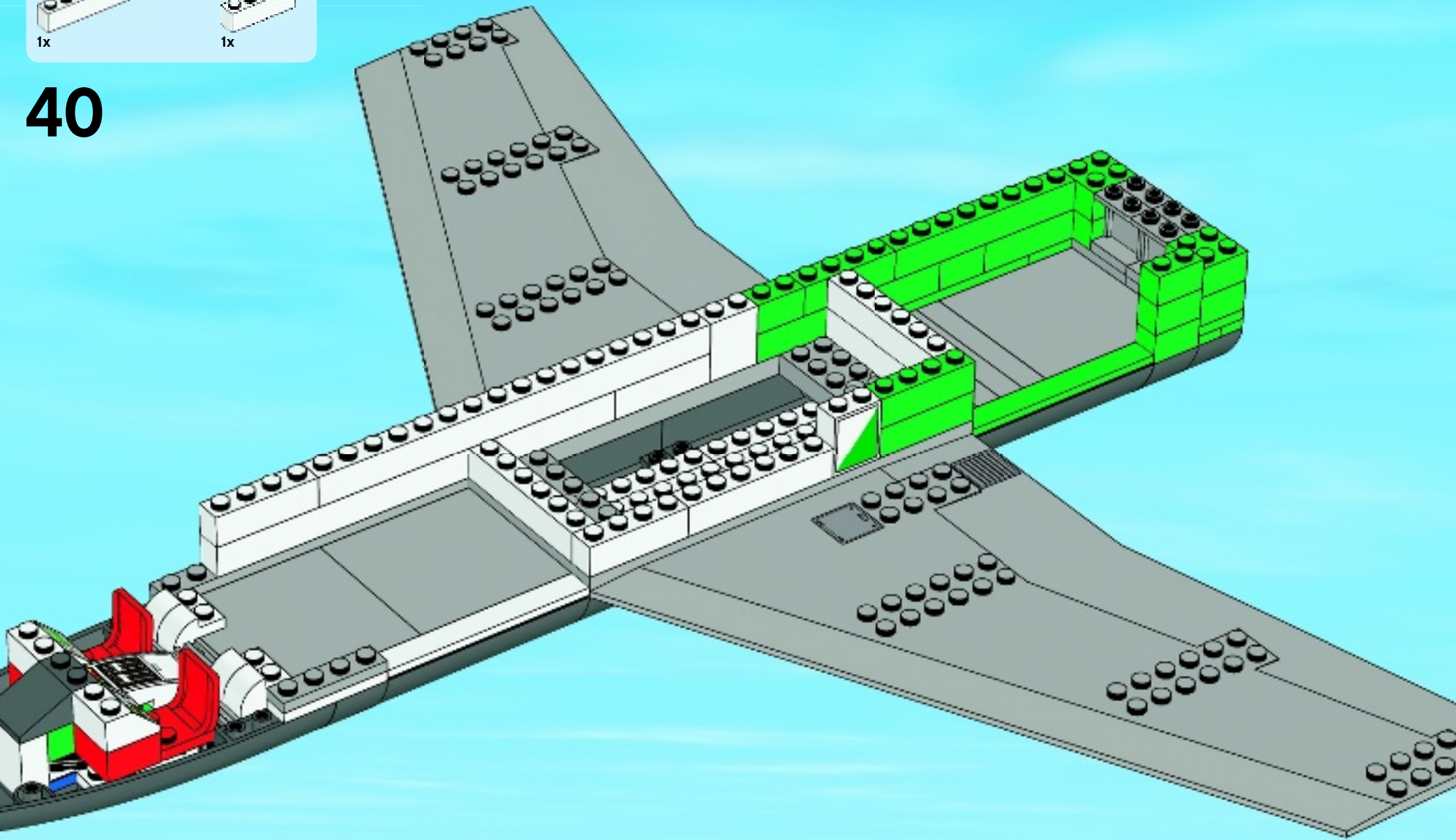

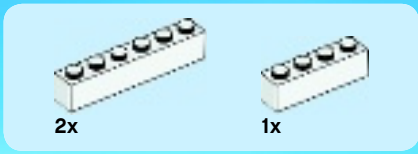

41

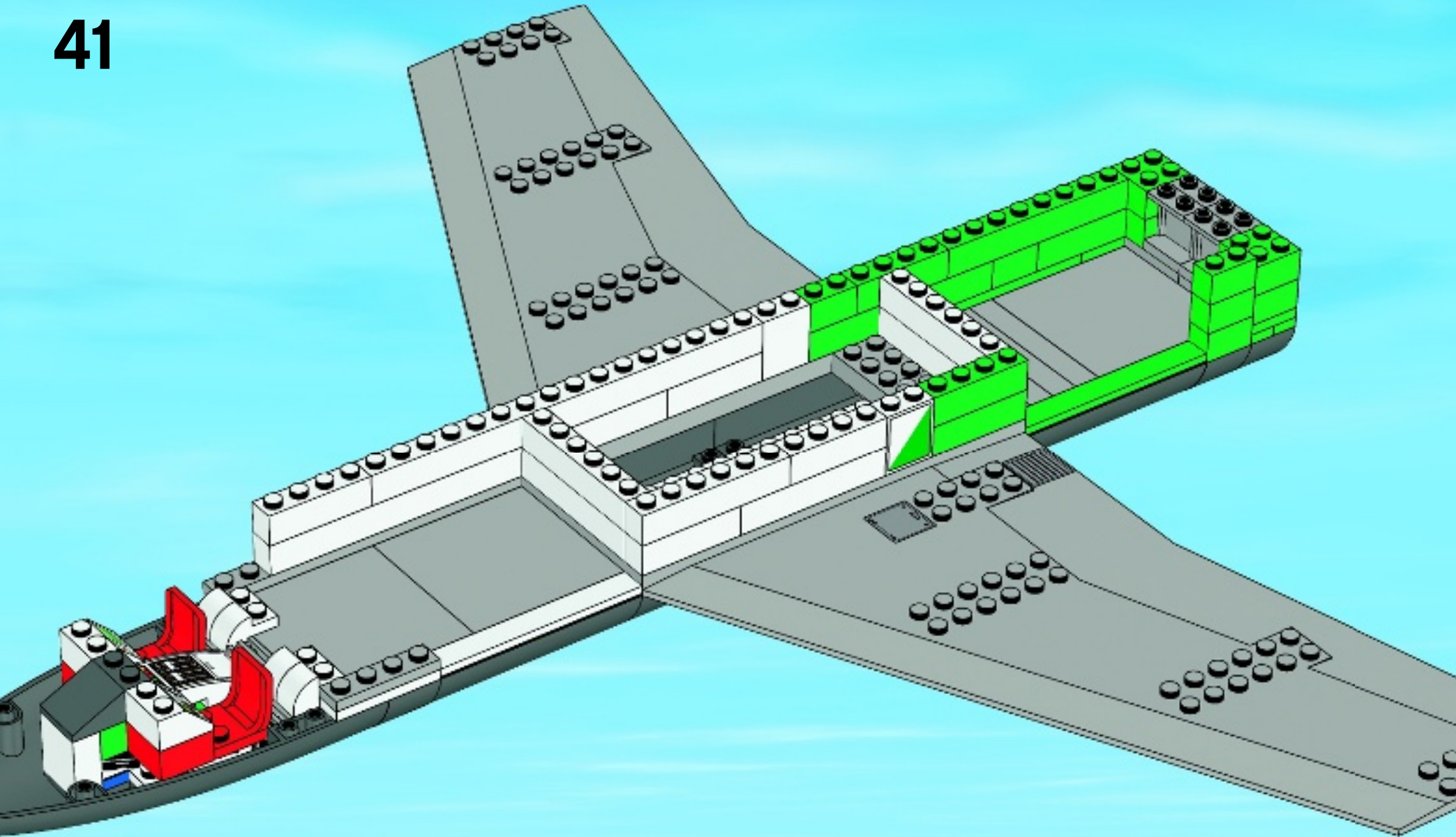



3x 2x 2x

42

2x

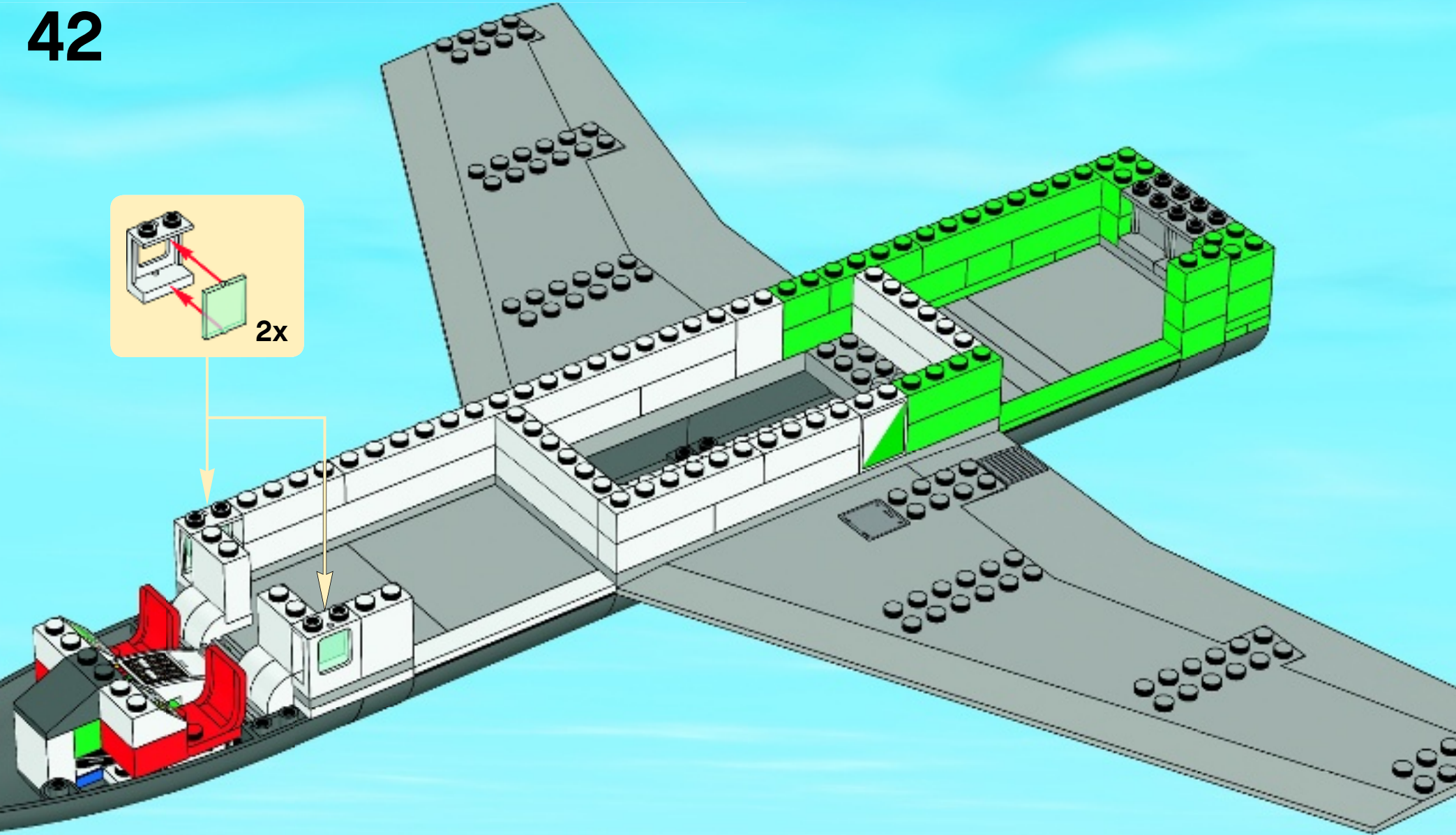



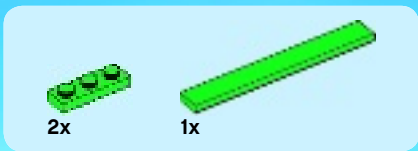

43

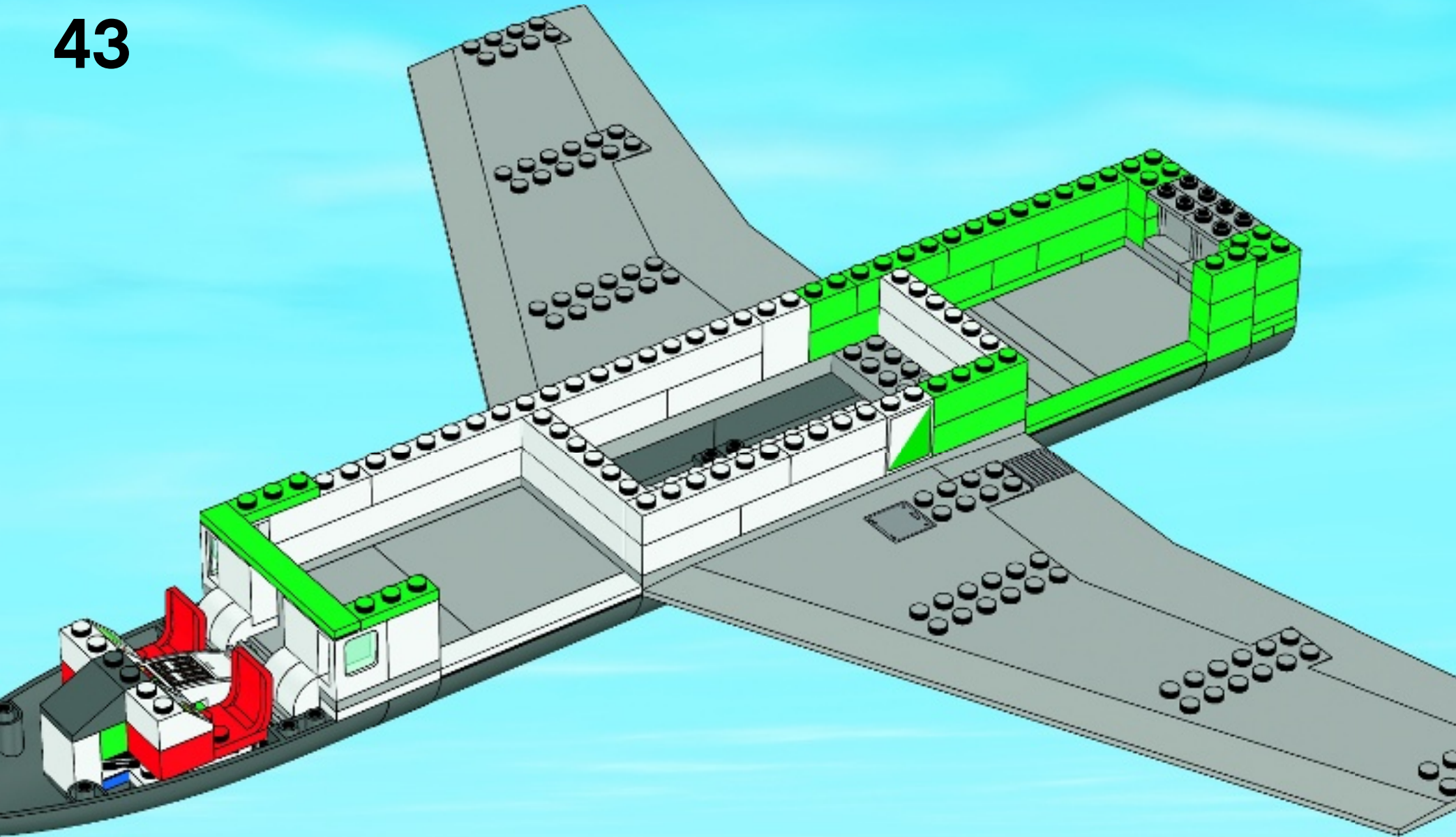

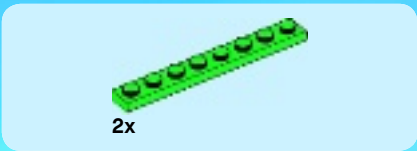

44

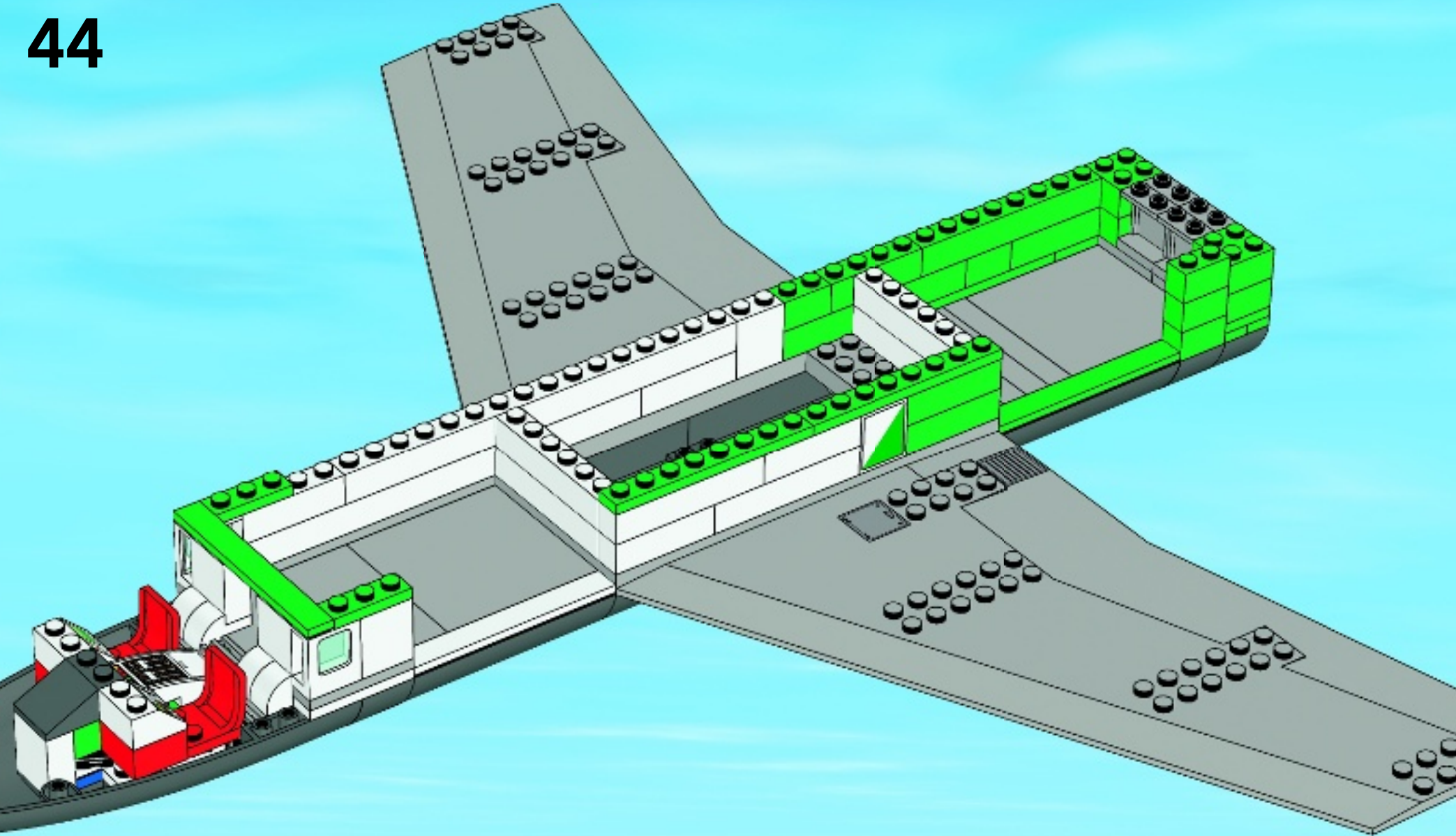





45

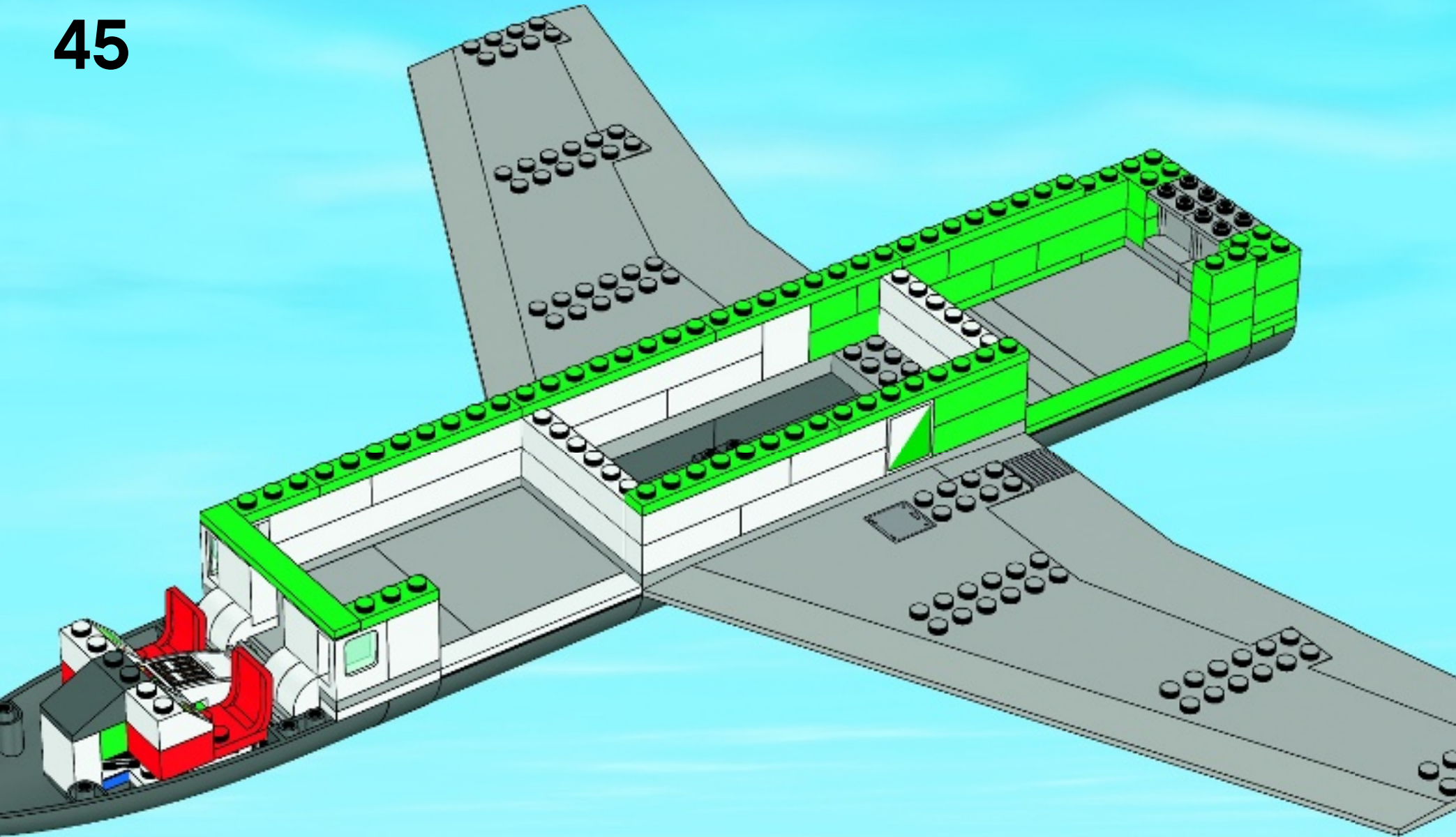



46

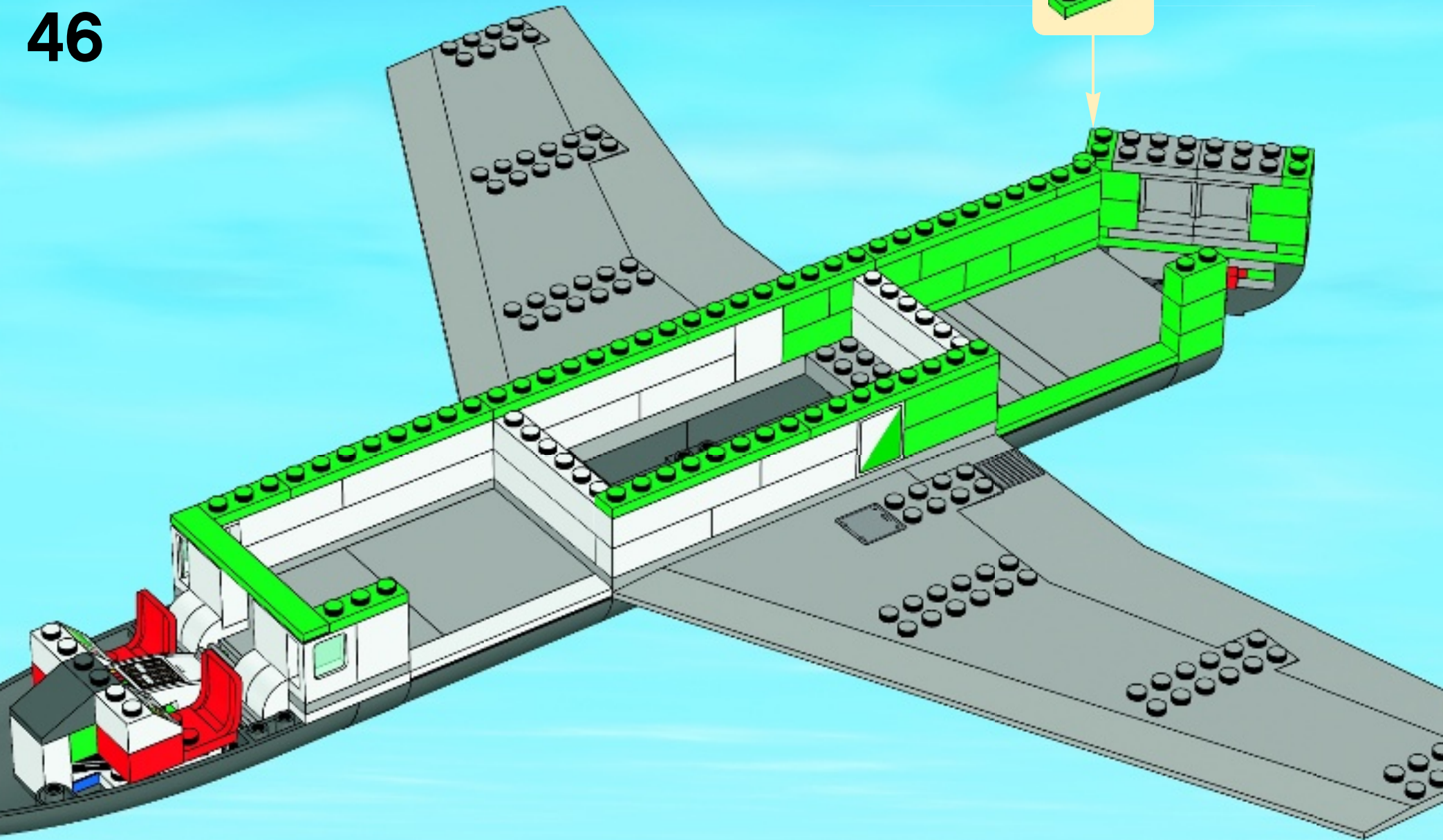
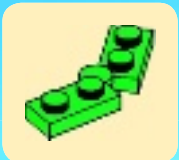





4x

47

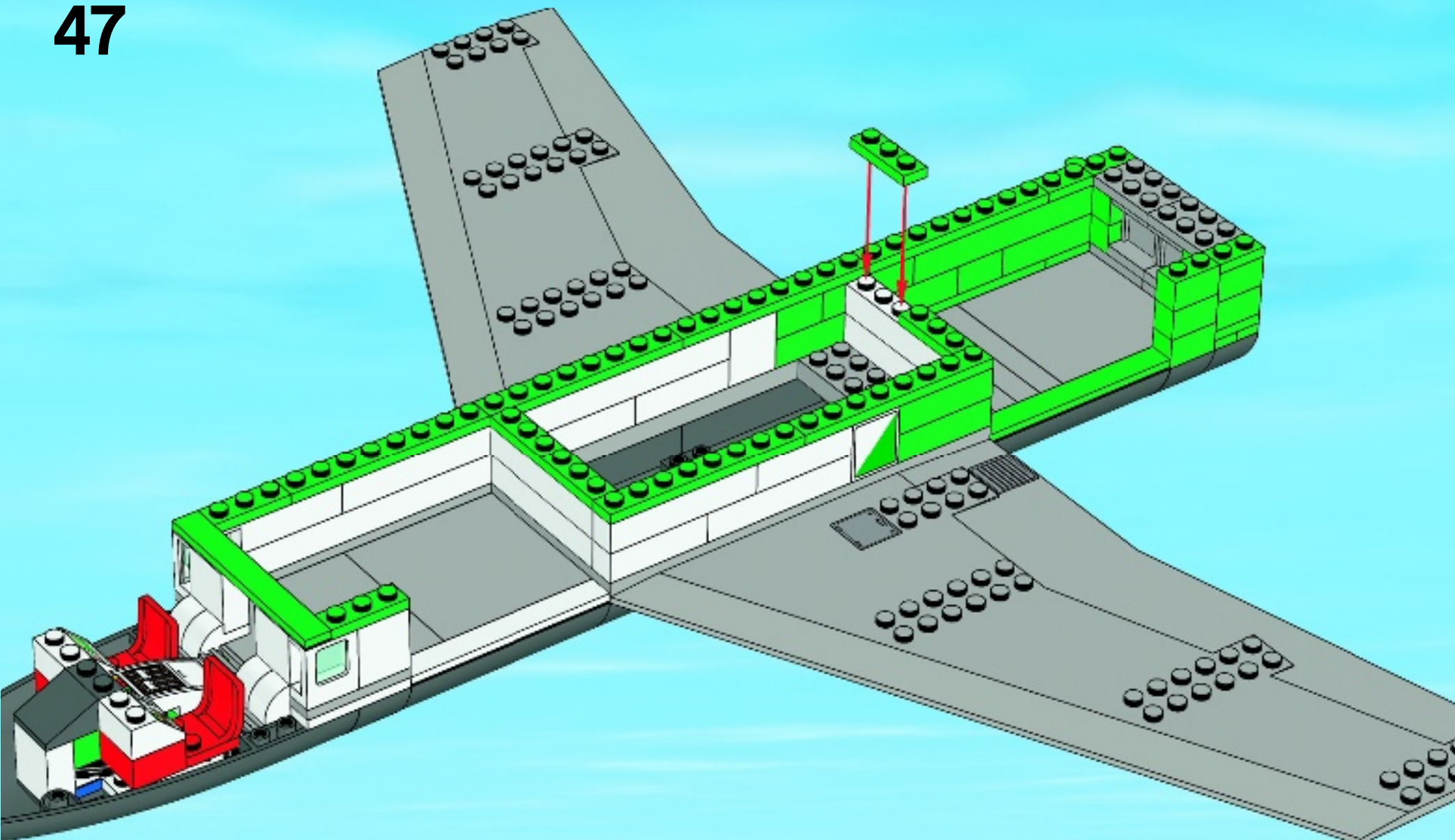





4x

48

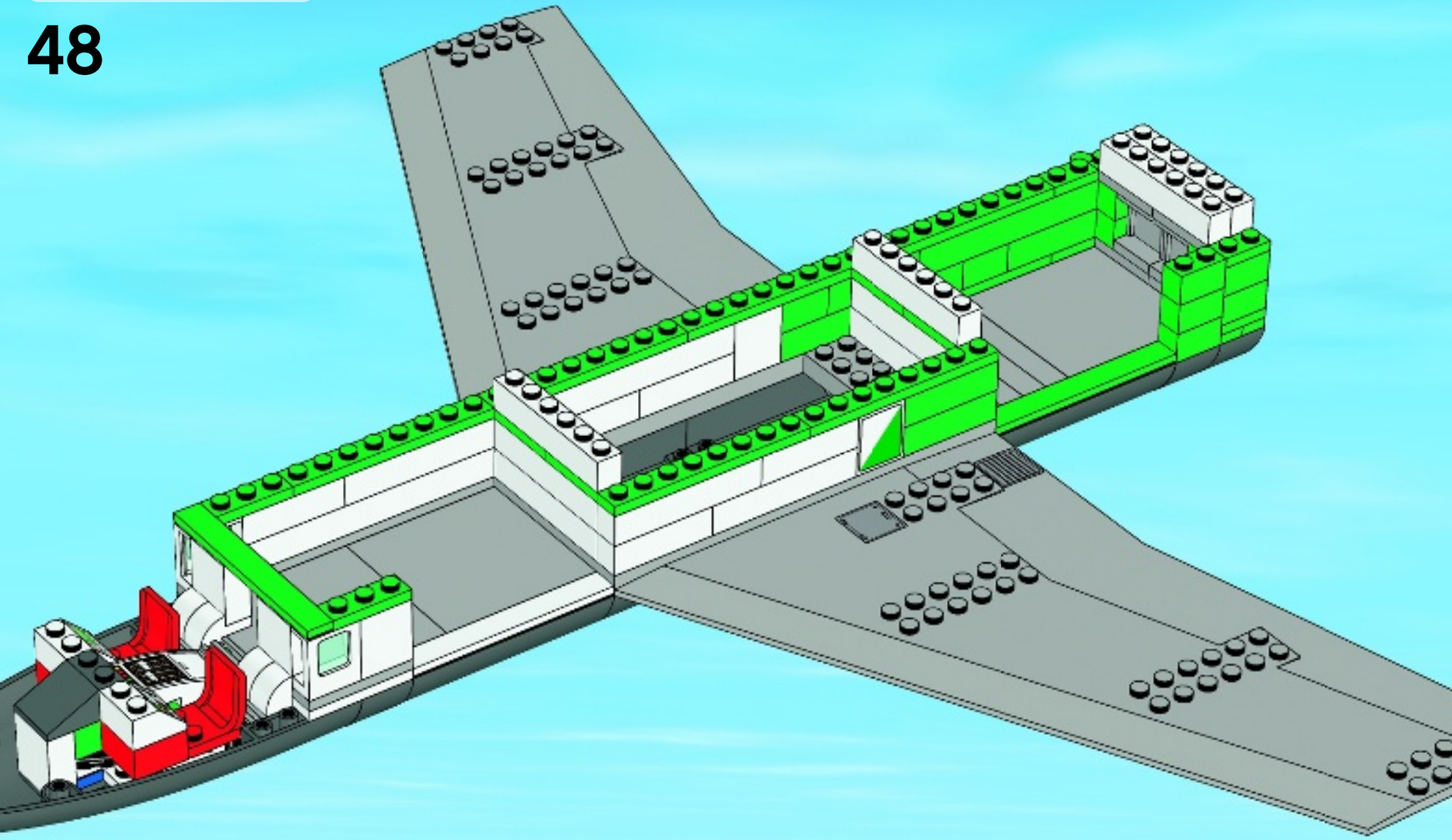



49

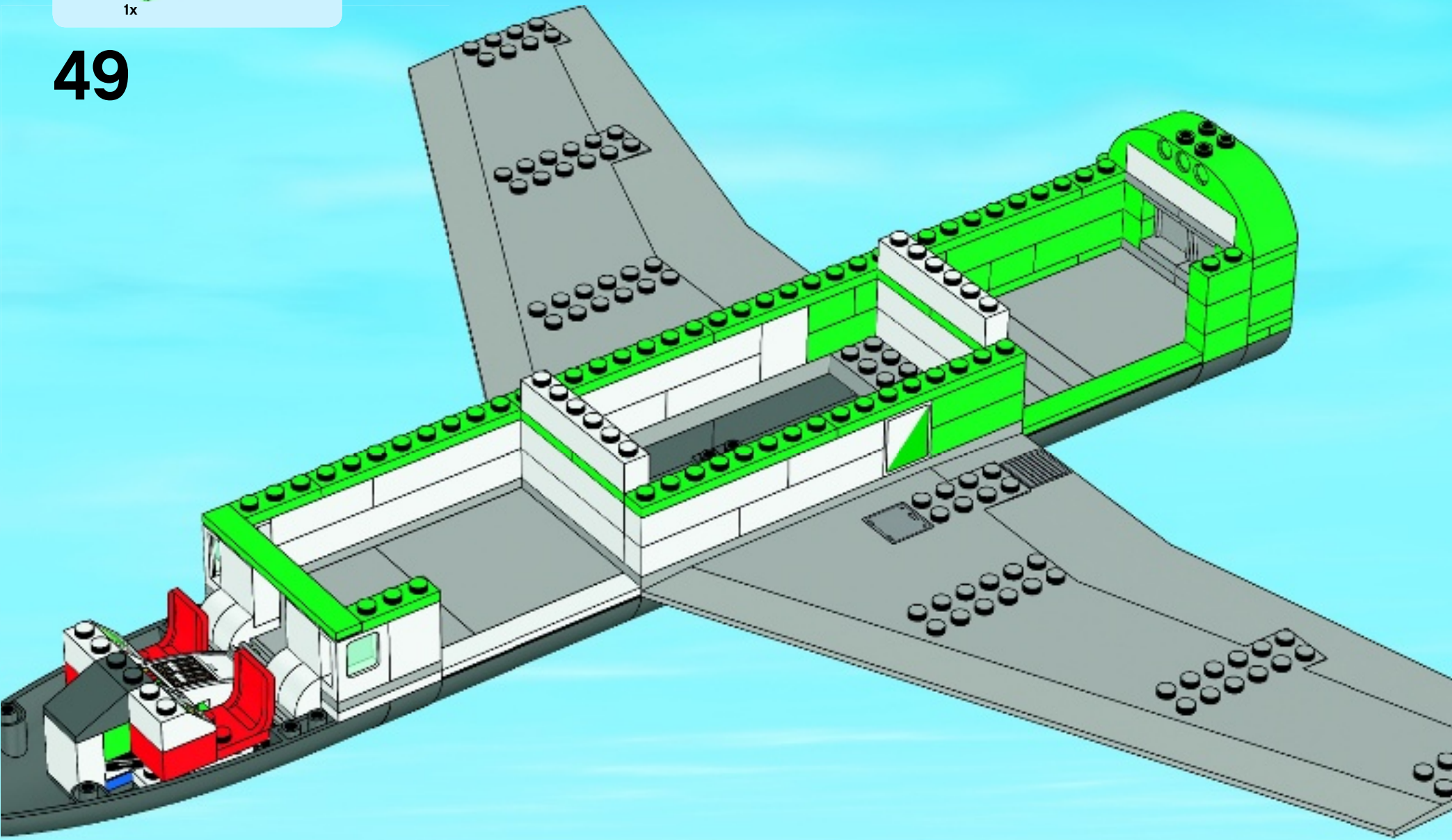

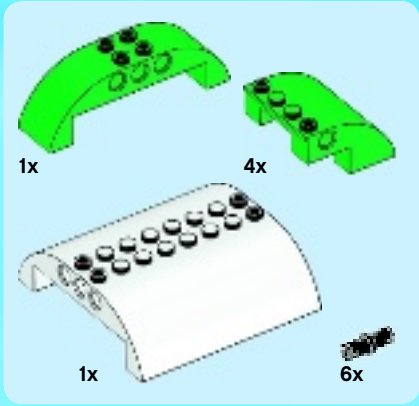
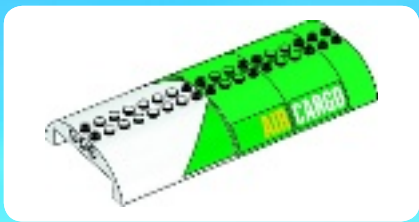

# 50

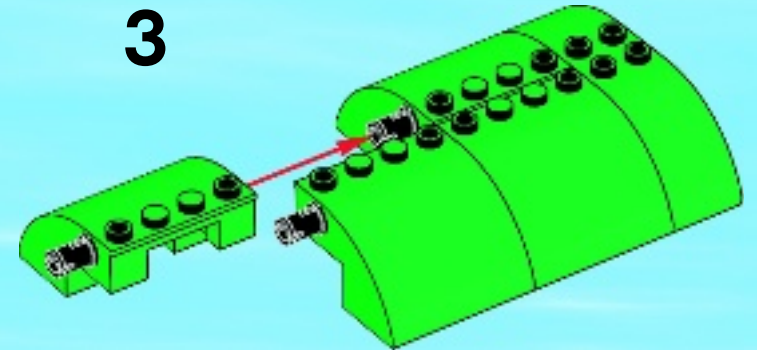
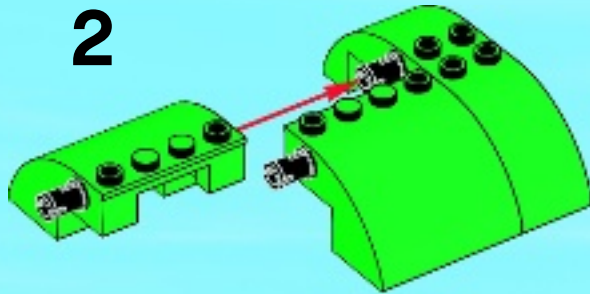



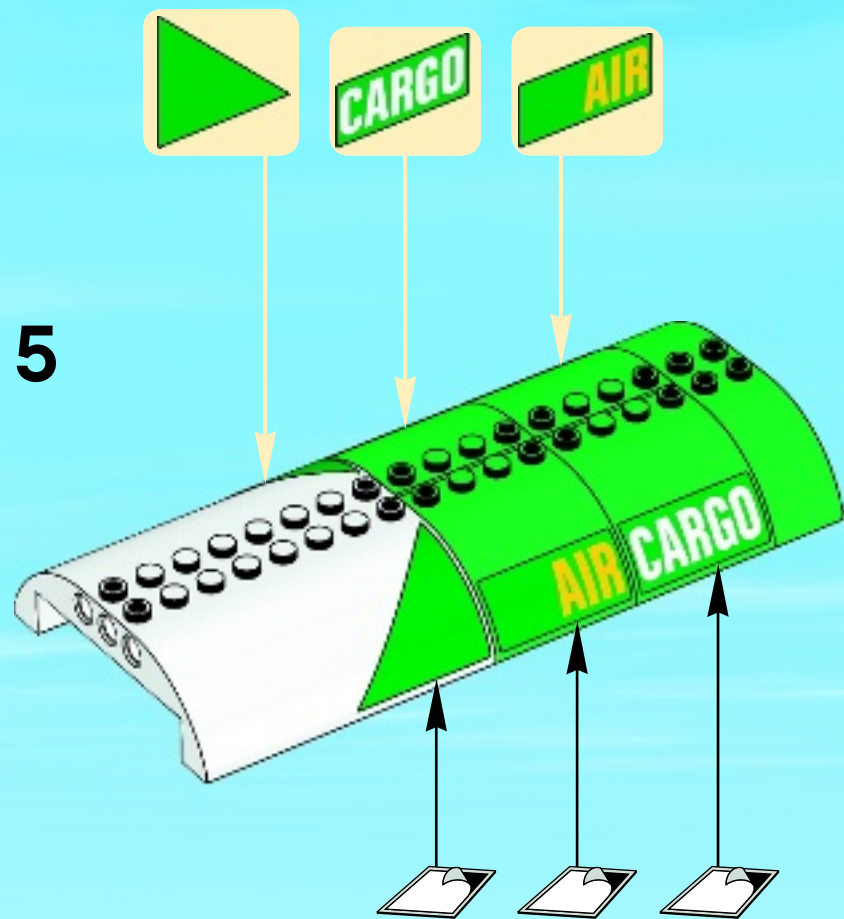
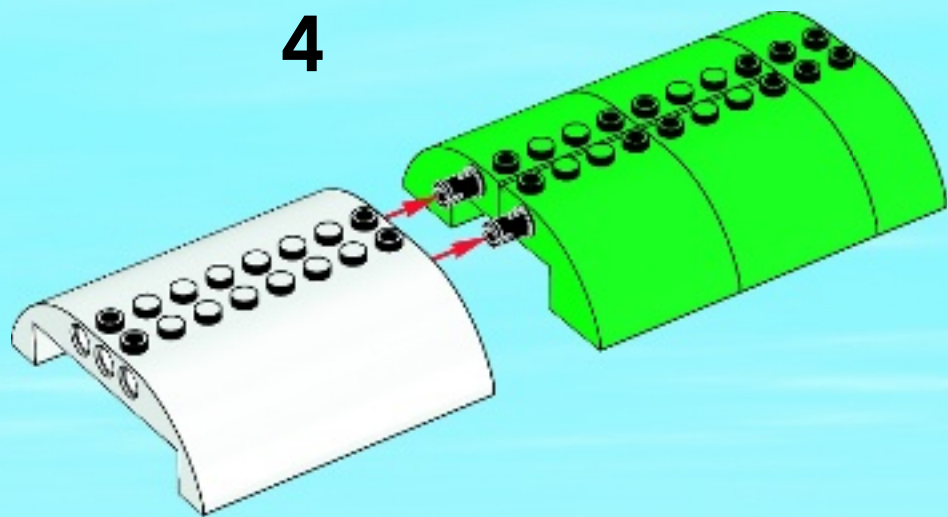

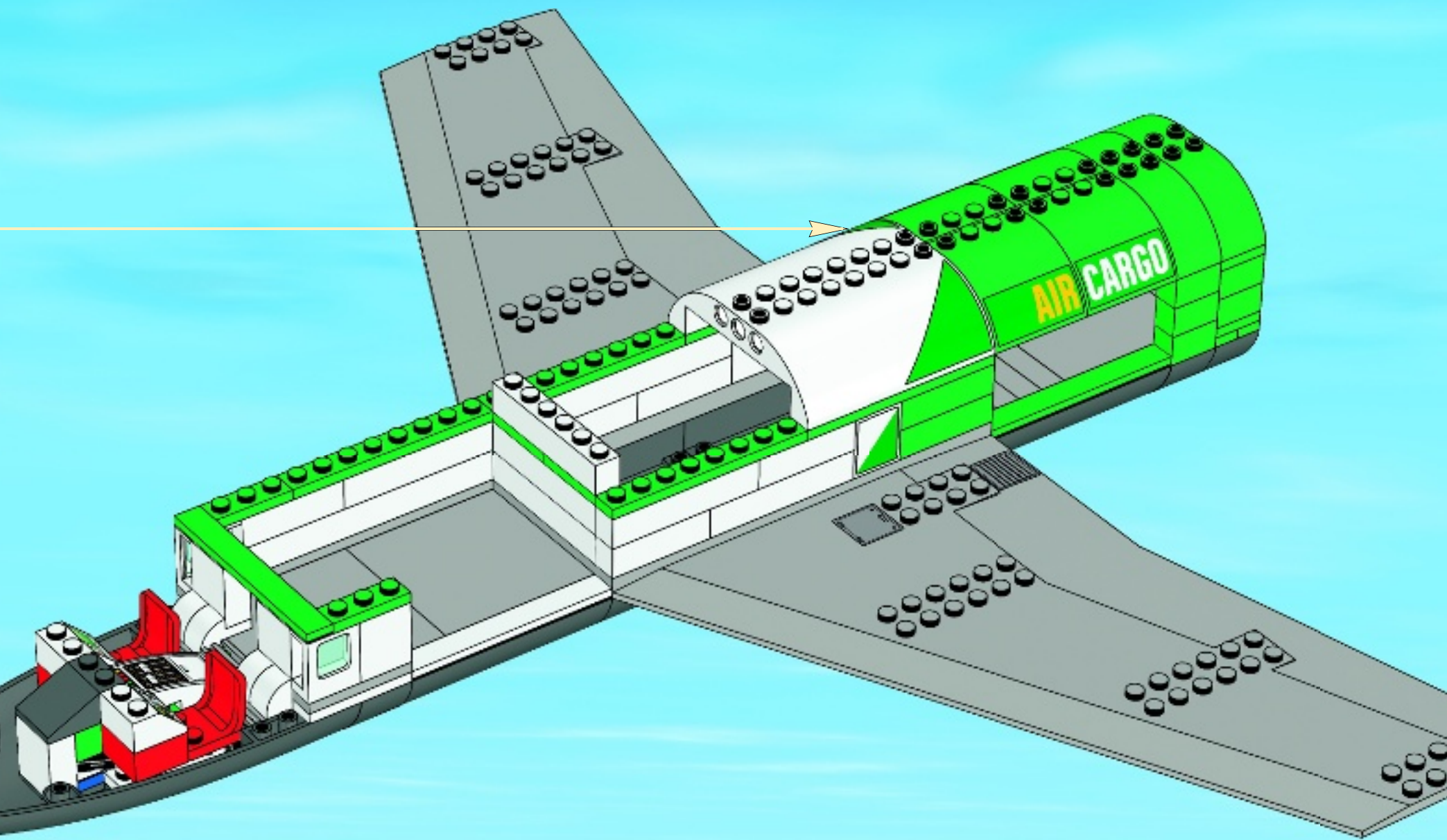



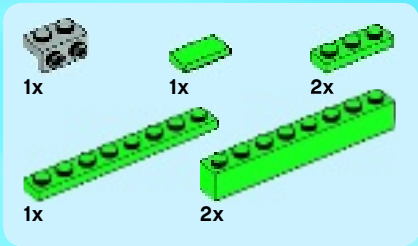
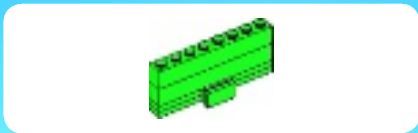

51

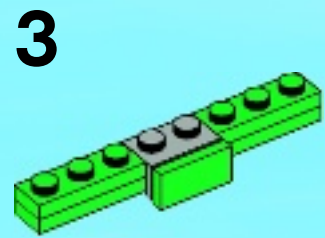
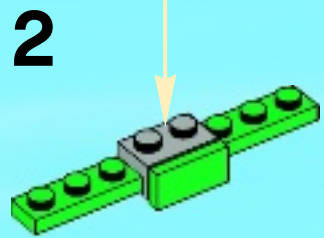
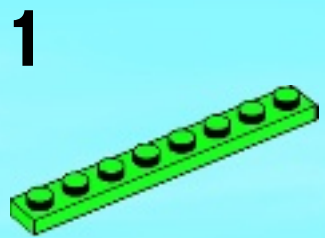
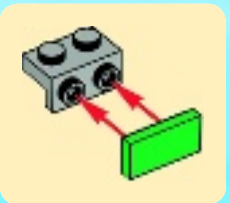

4

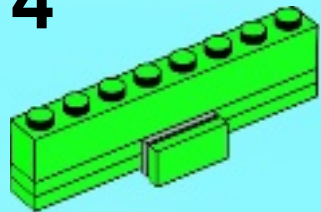

5

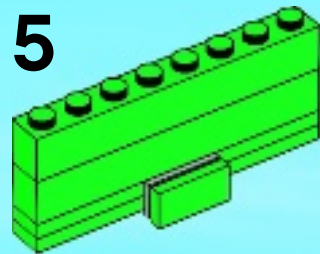

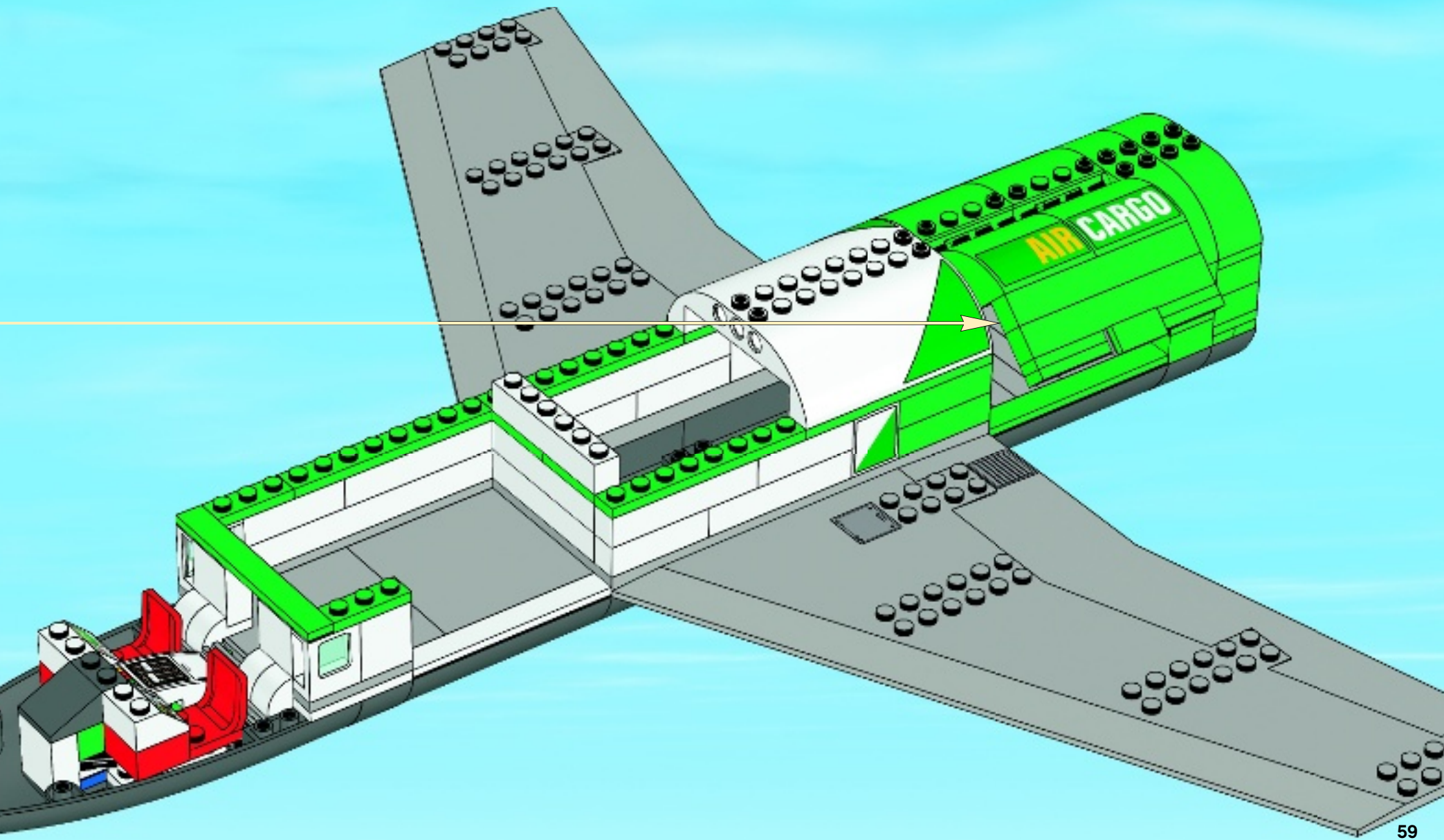

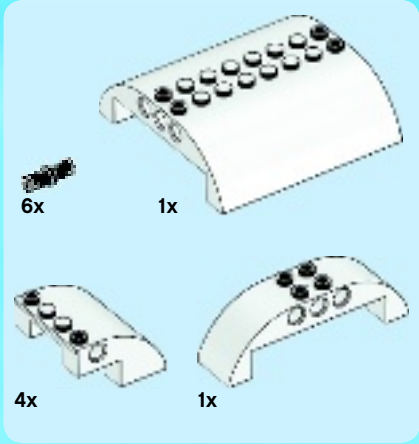

# 52

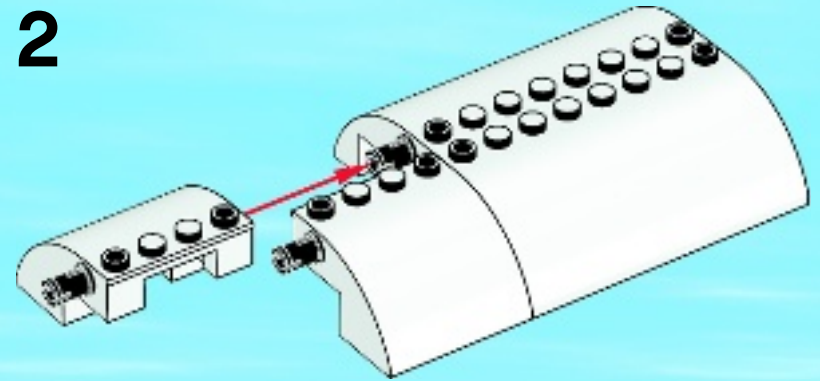
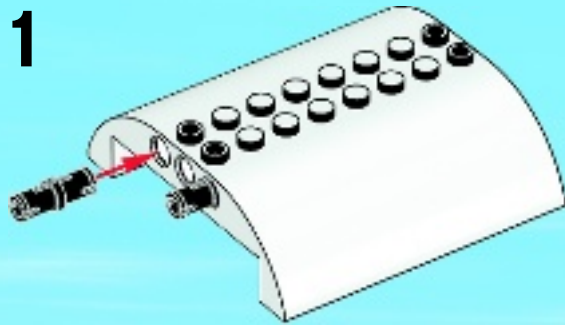



**3**

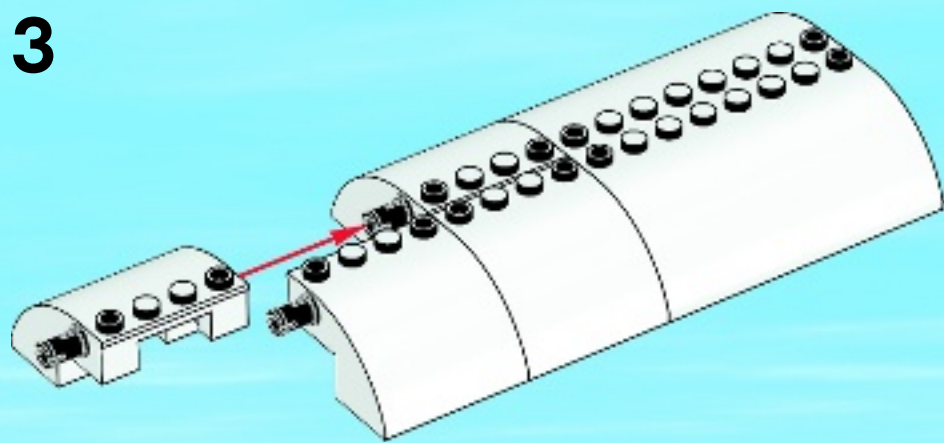

**4**

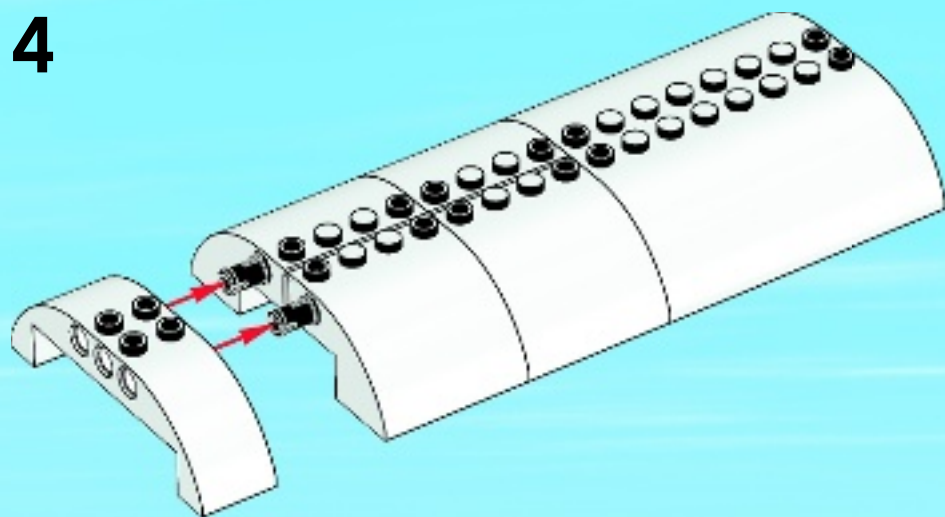



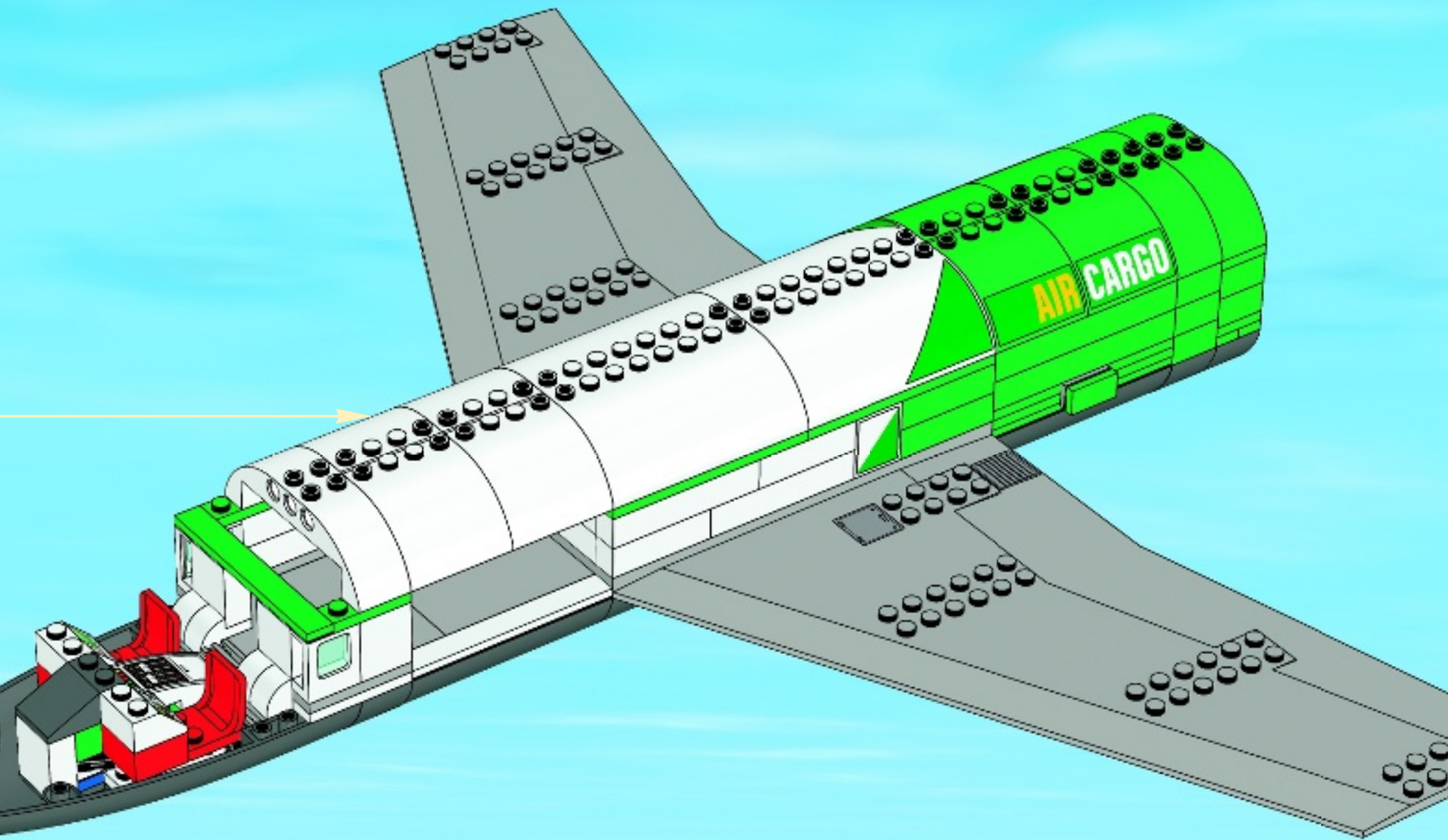

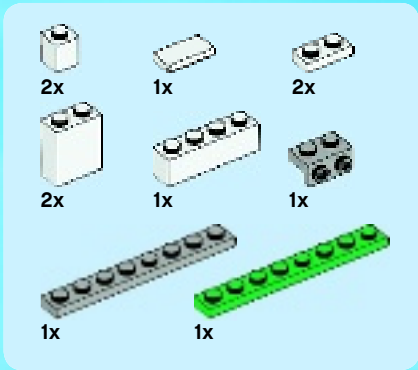

# 53

1

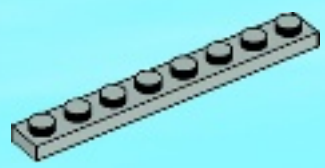

2

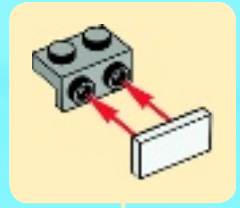
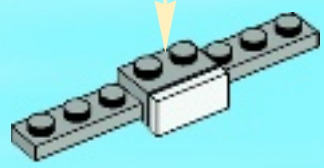

3

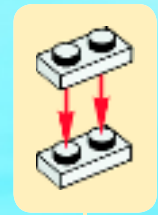
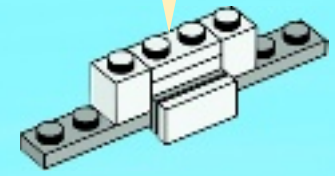

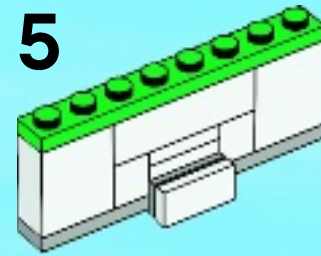
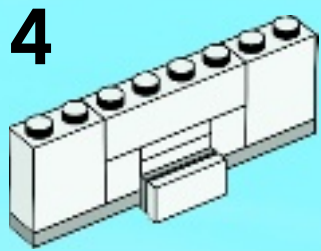



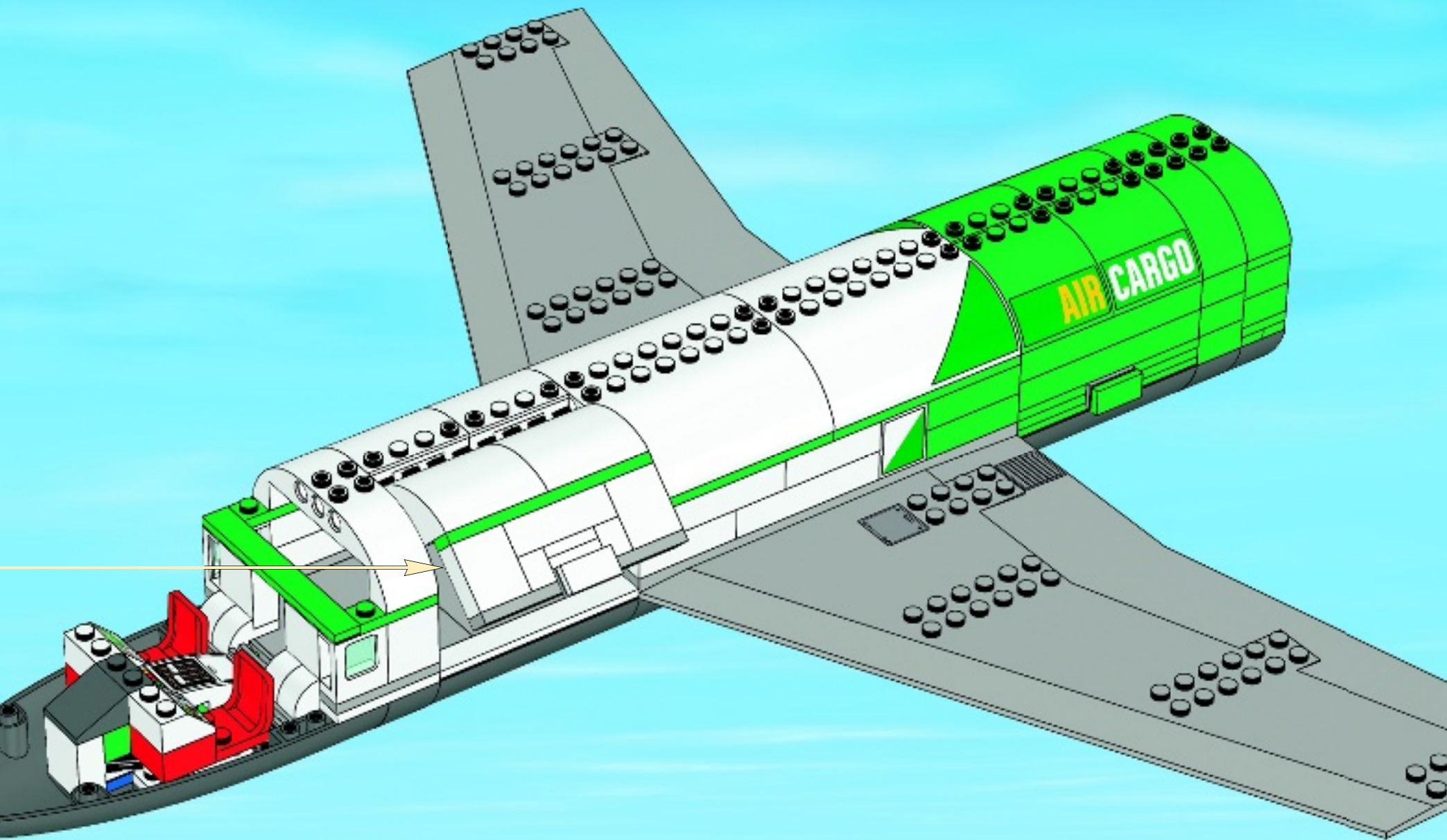

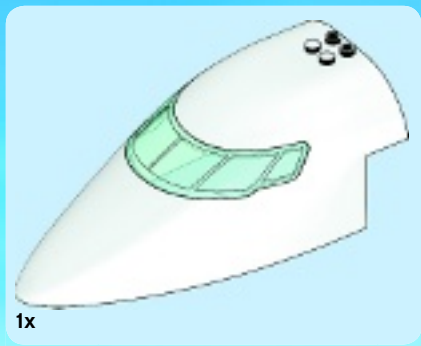

1x

54

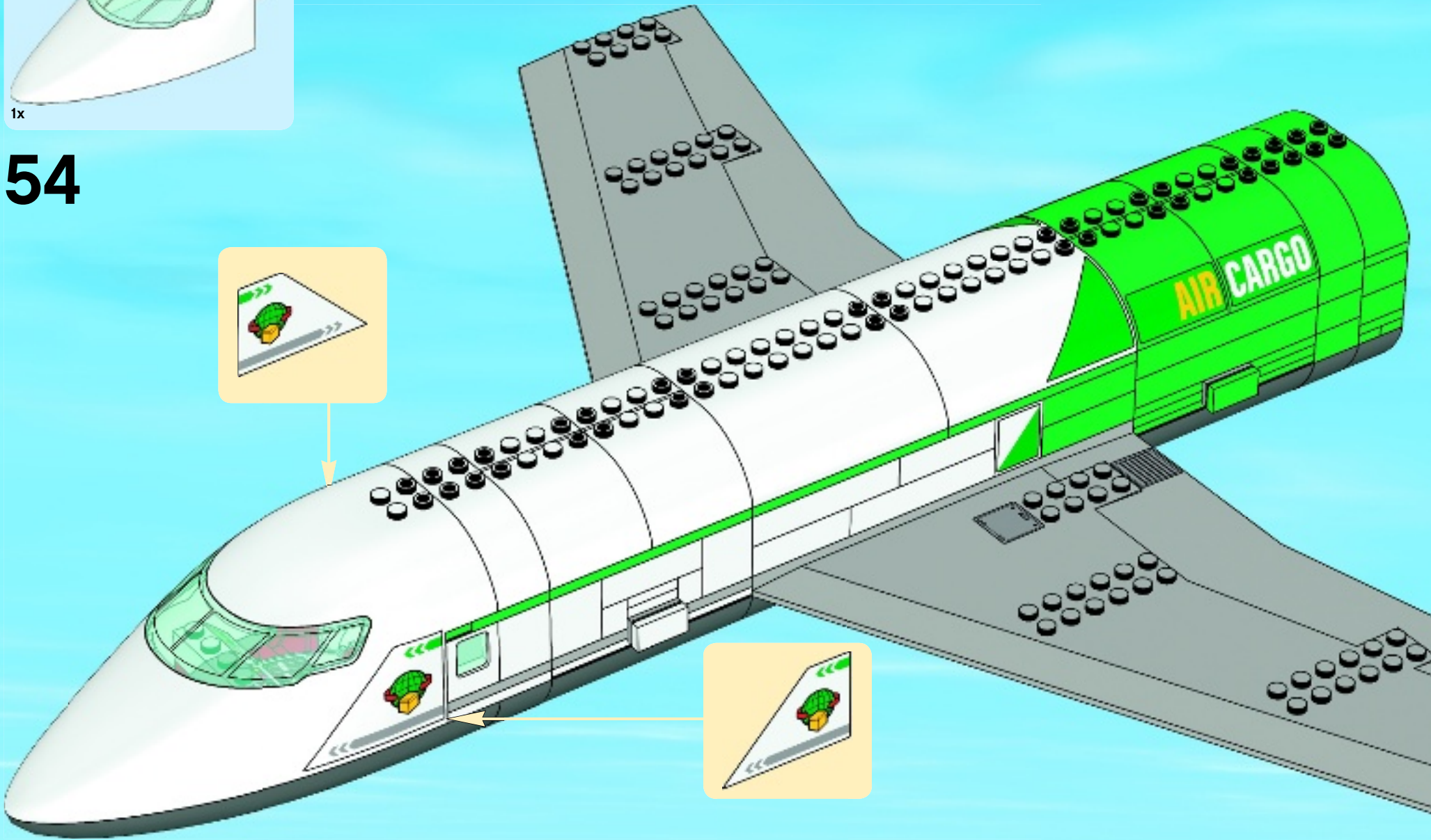



- 1x 
- 1x 
- 2x 

55

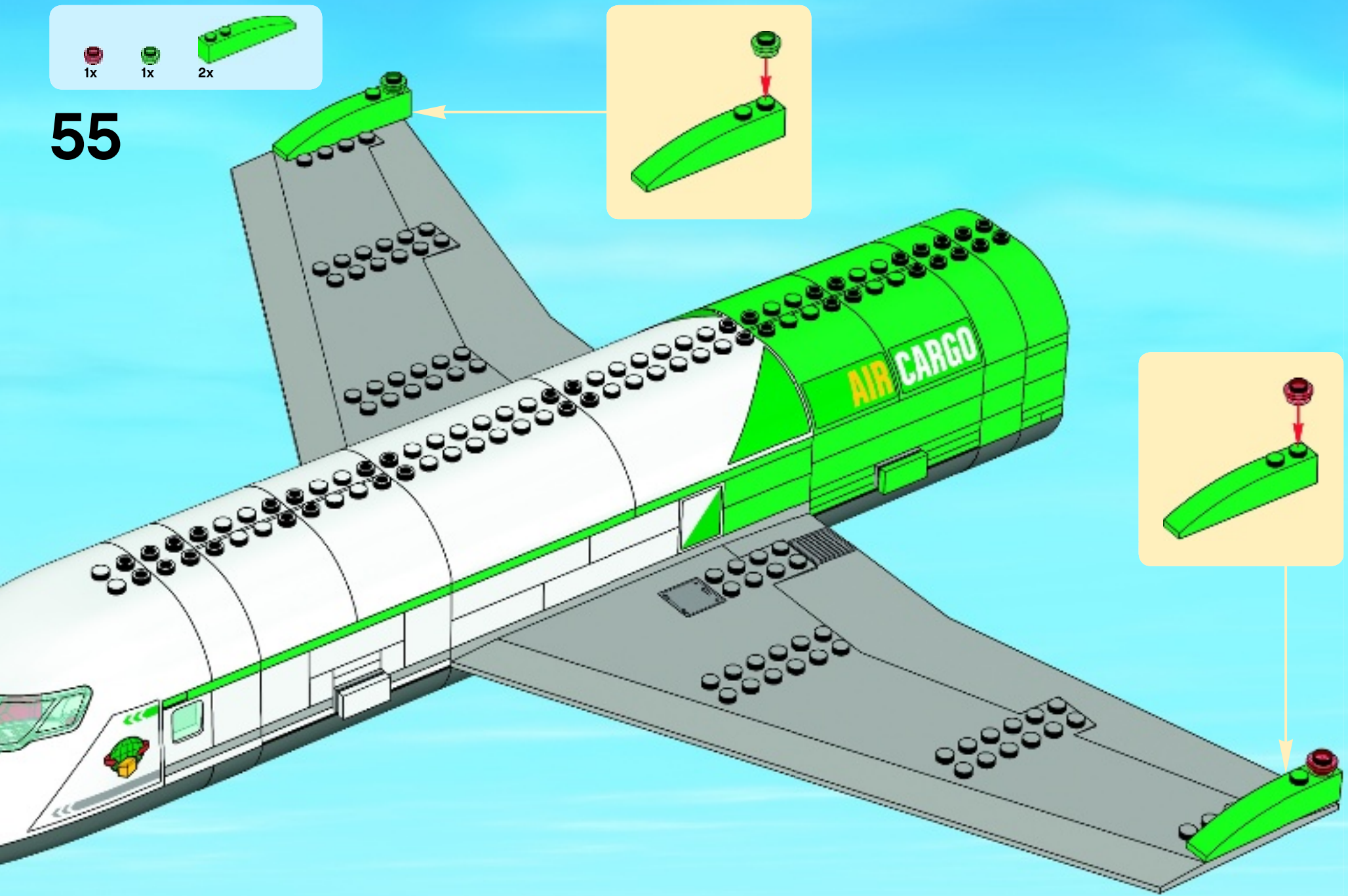

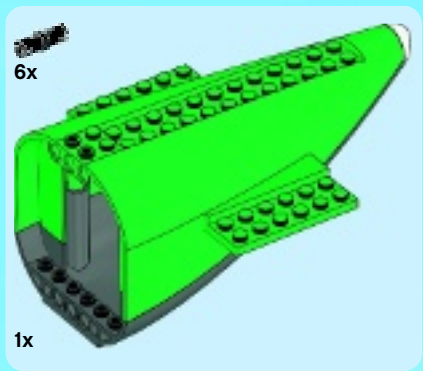
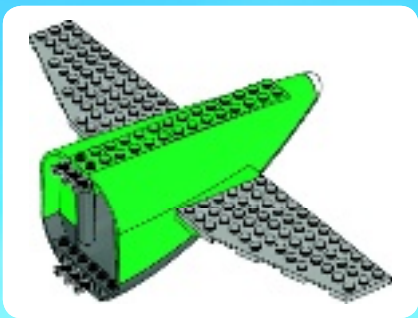
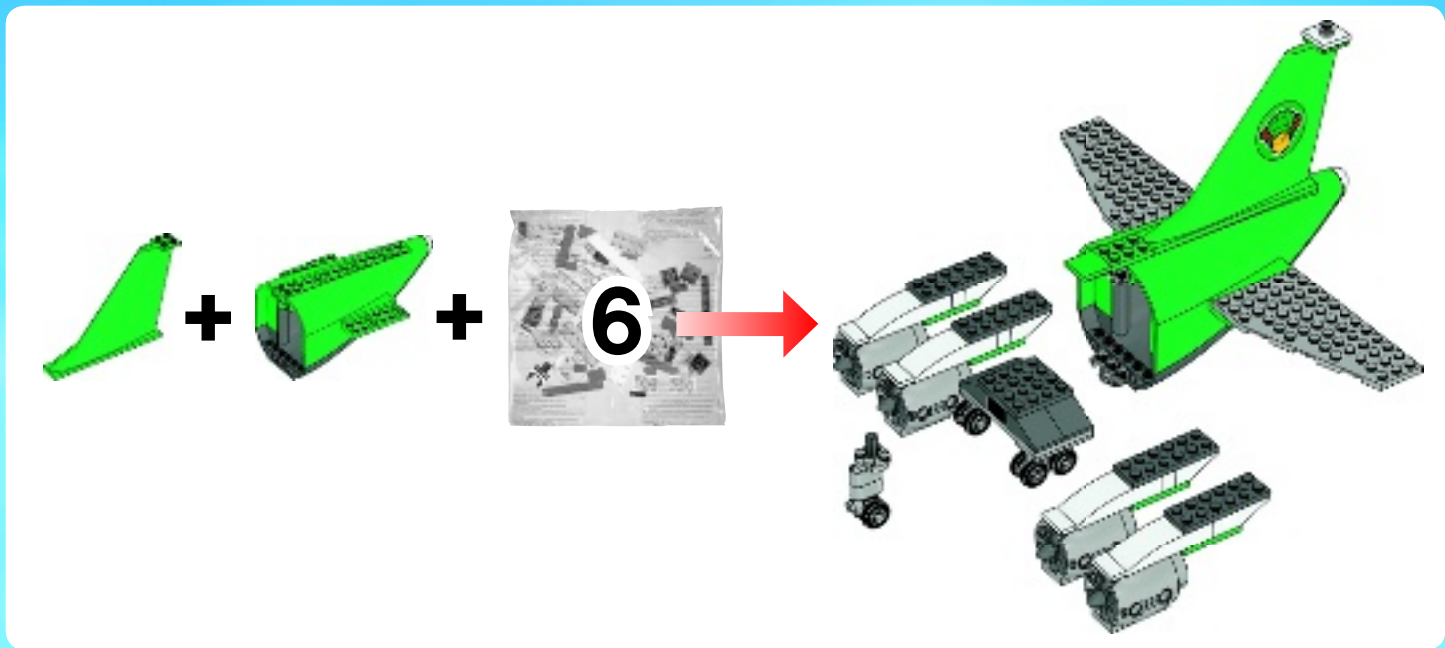

1

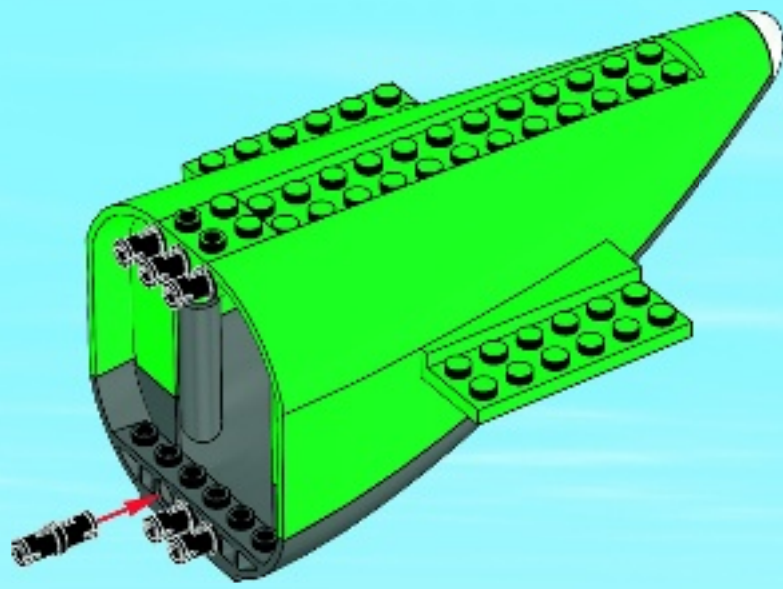



3x

2

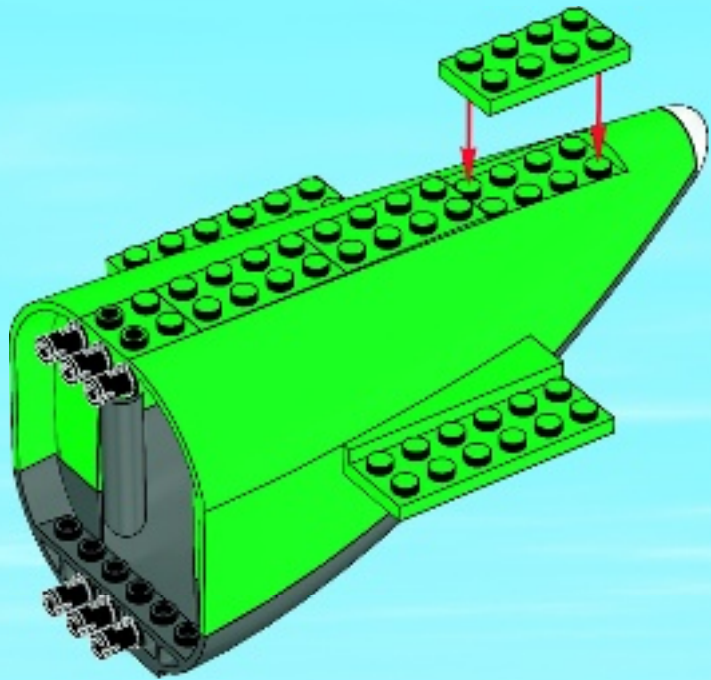

1x

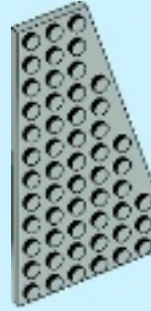

1x

3

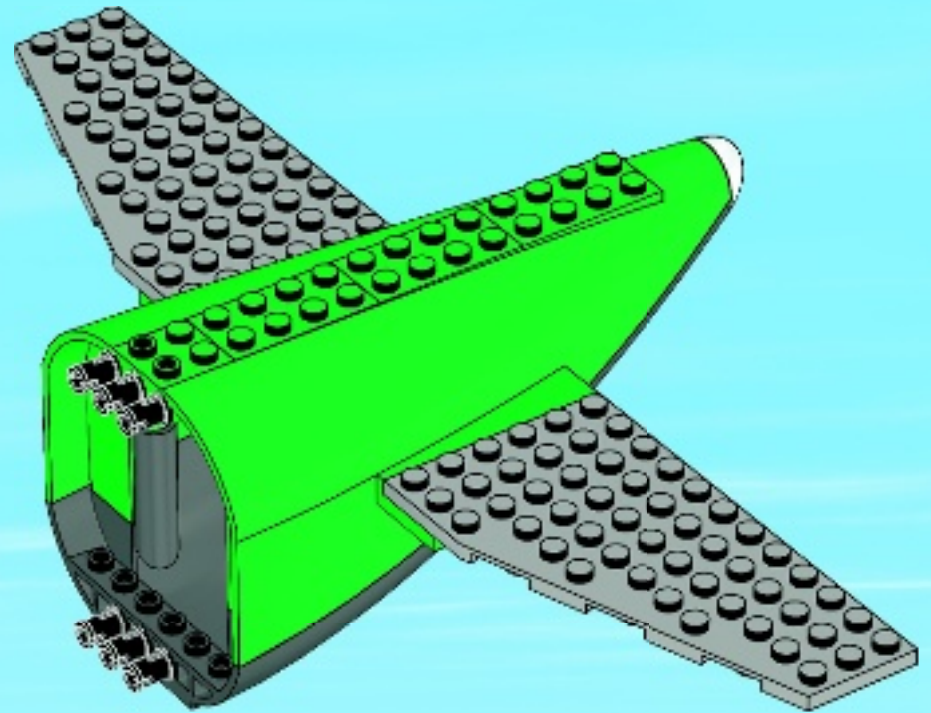



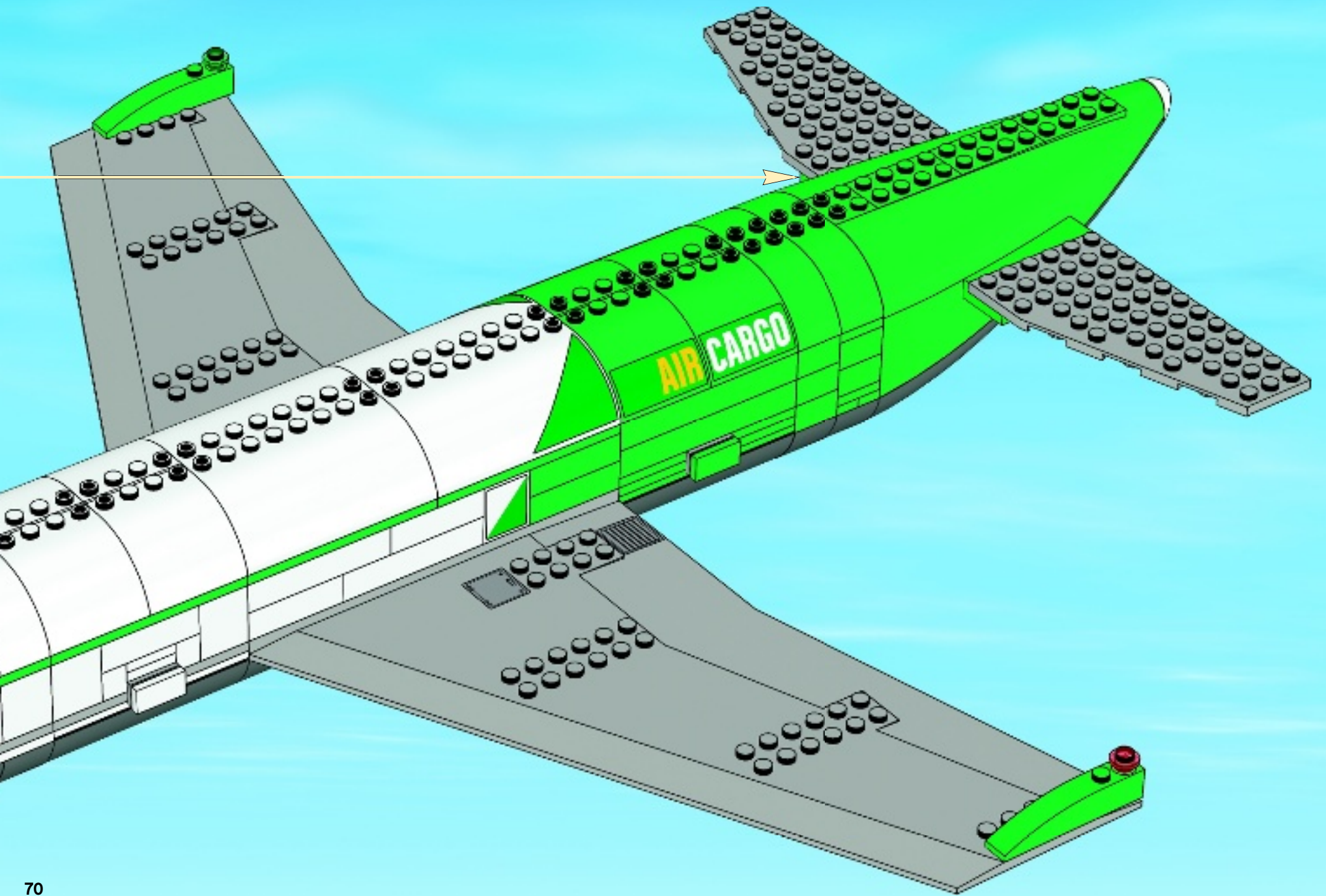



1x

57

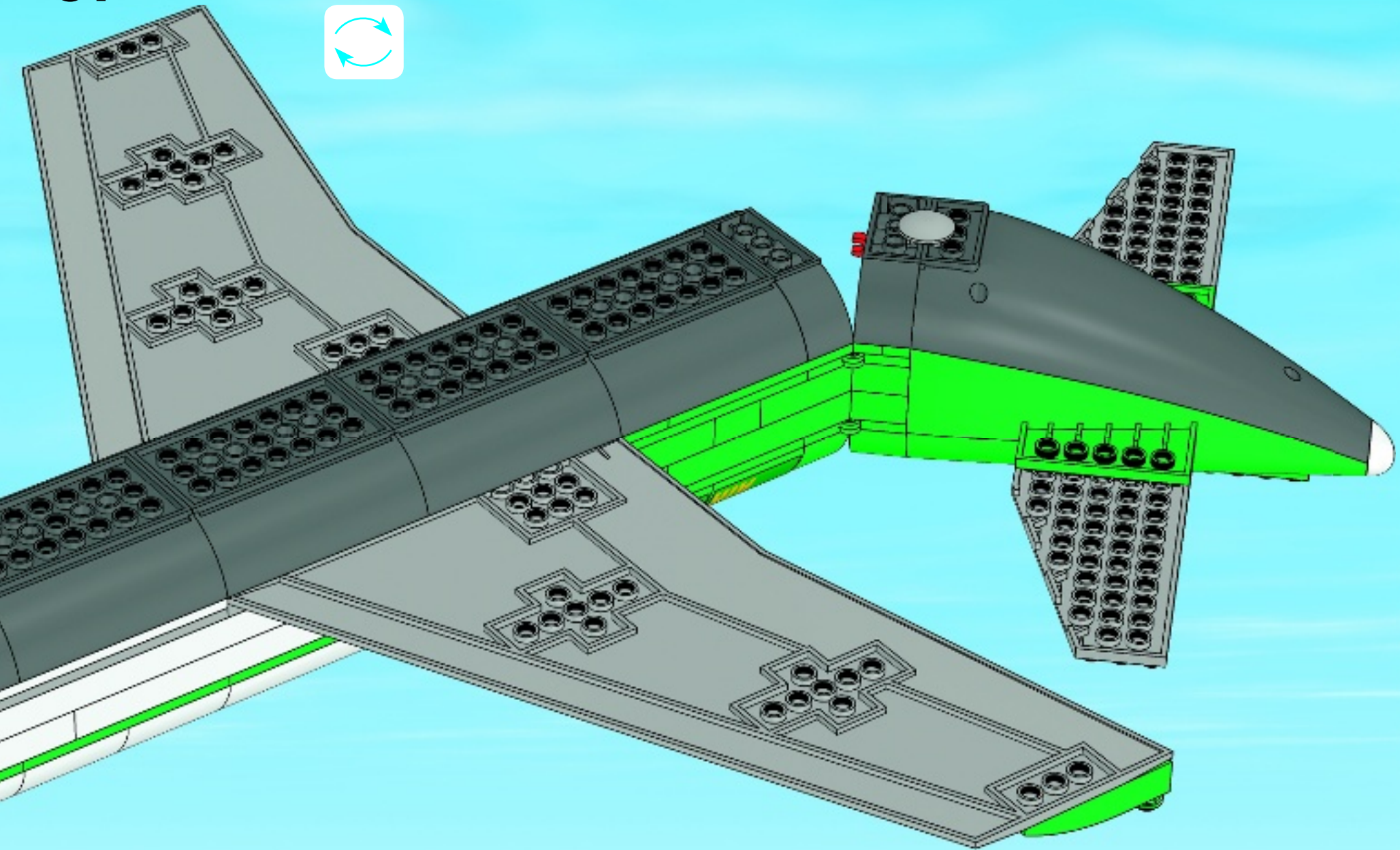



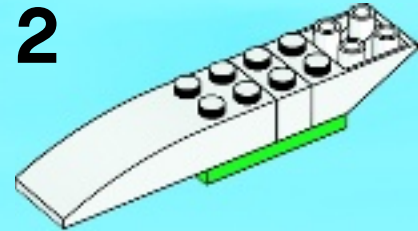
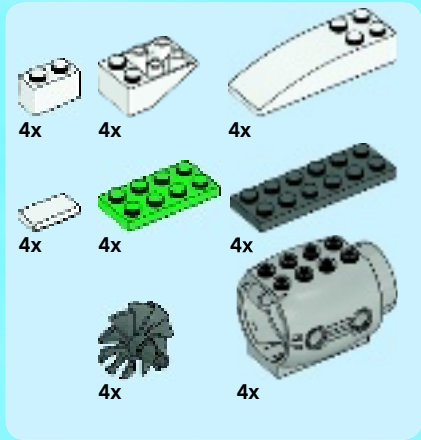
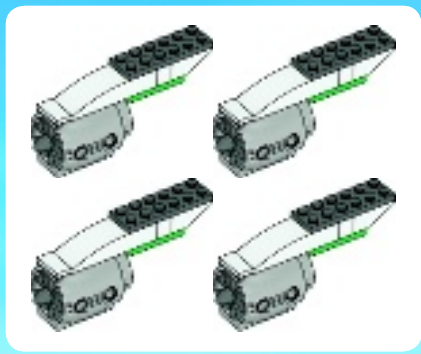

58

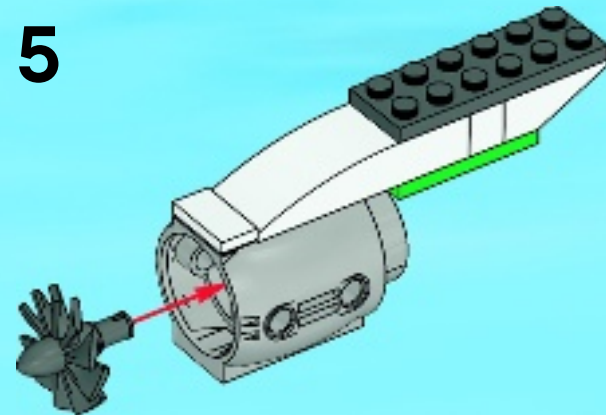
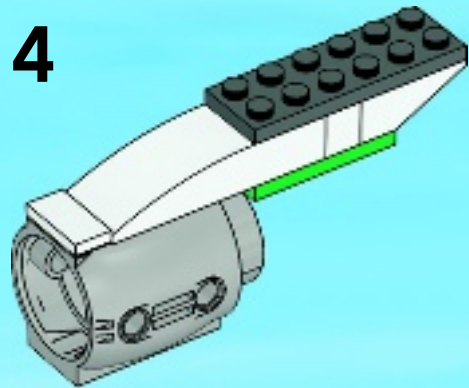
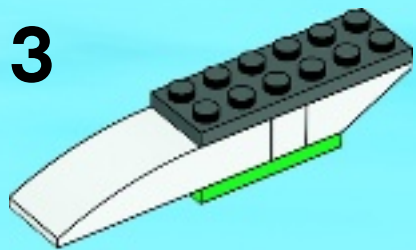

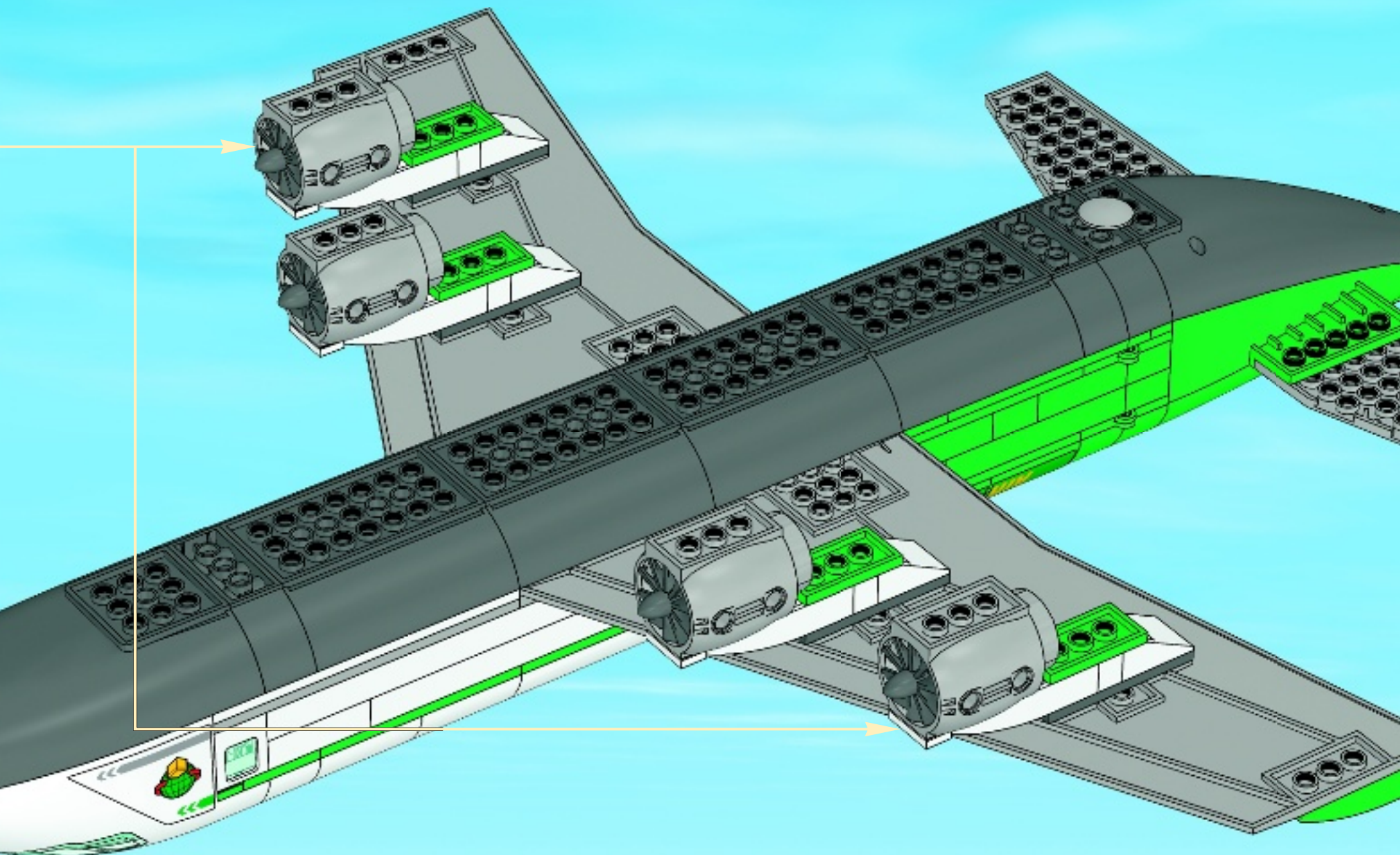



2x

2x

1x

1x

2x

1x

# 59

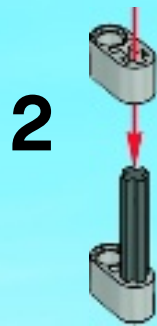
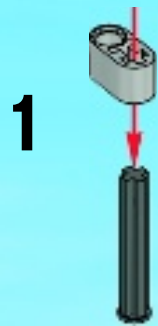

**3**

**4**



5

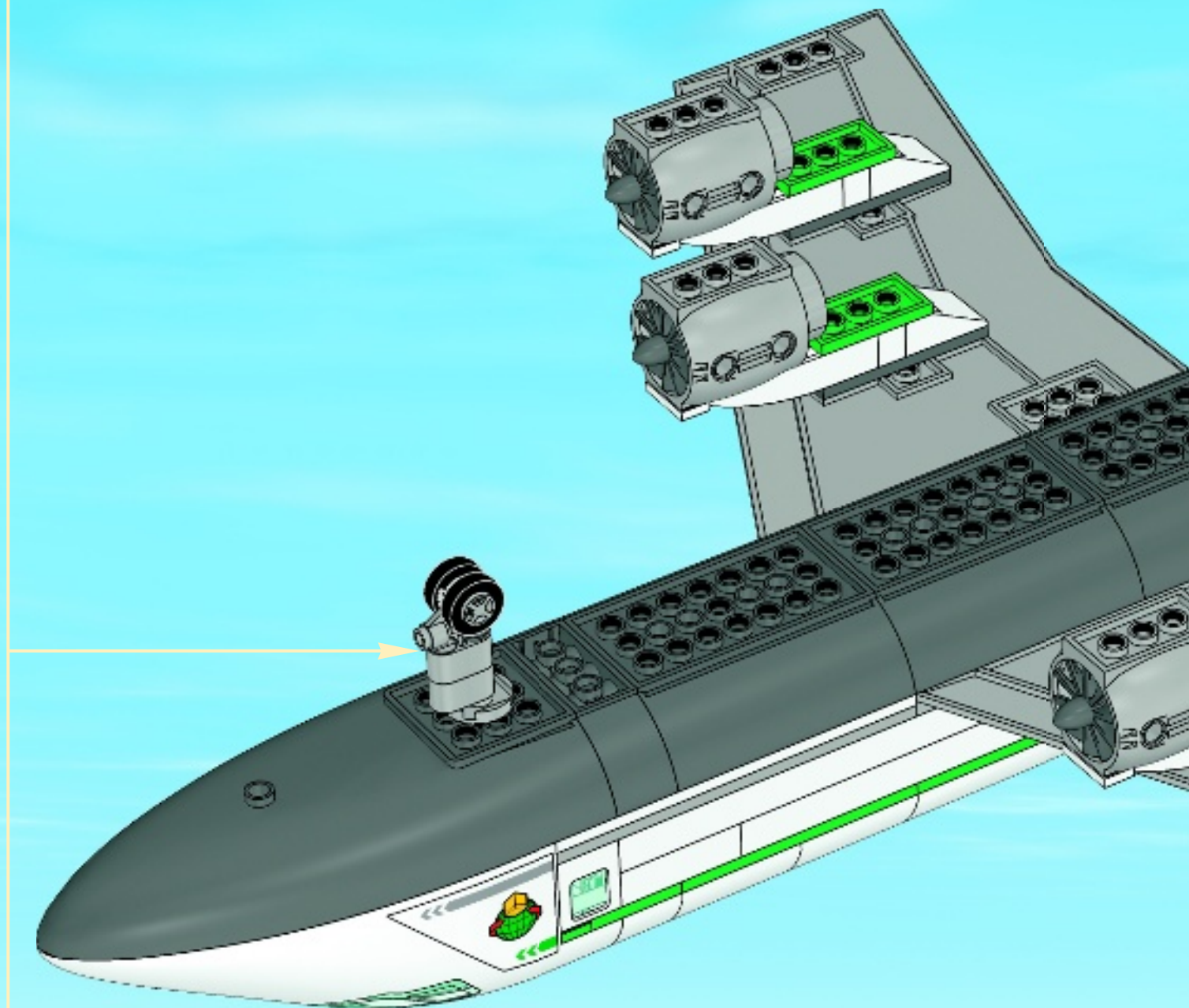
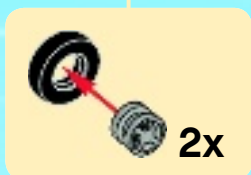



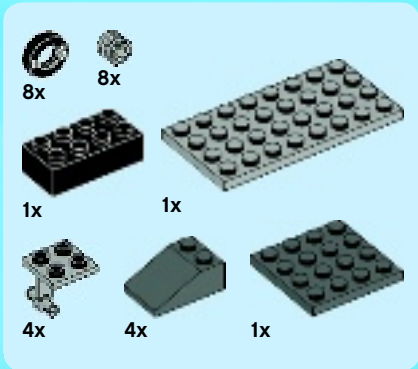

# 60

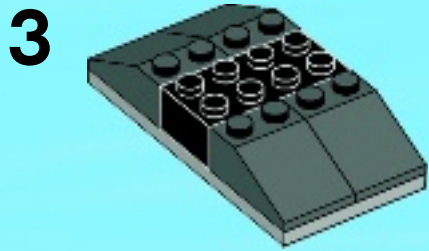
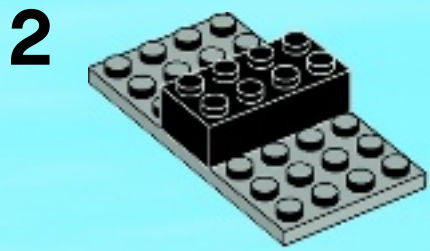

4



5

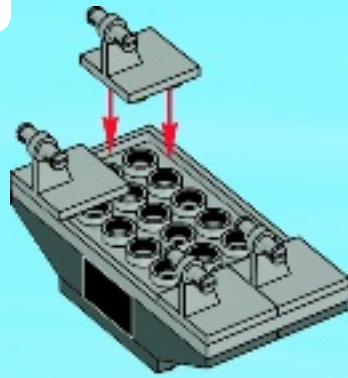

6

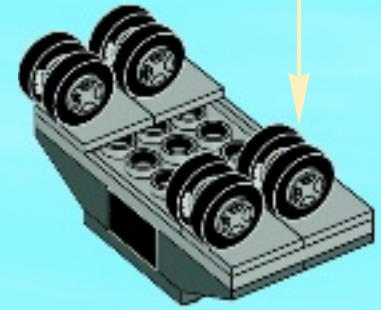
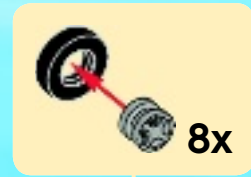

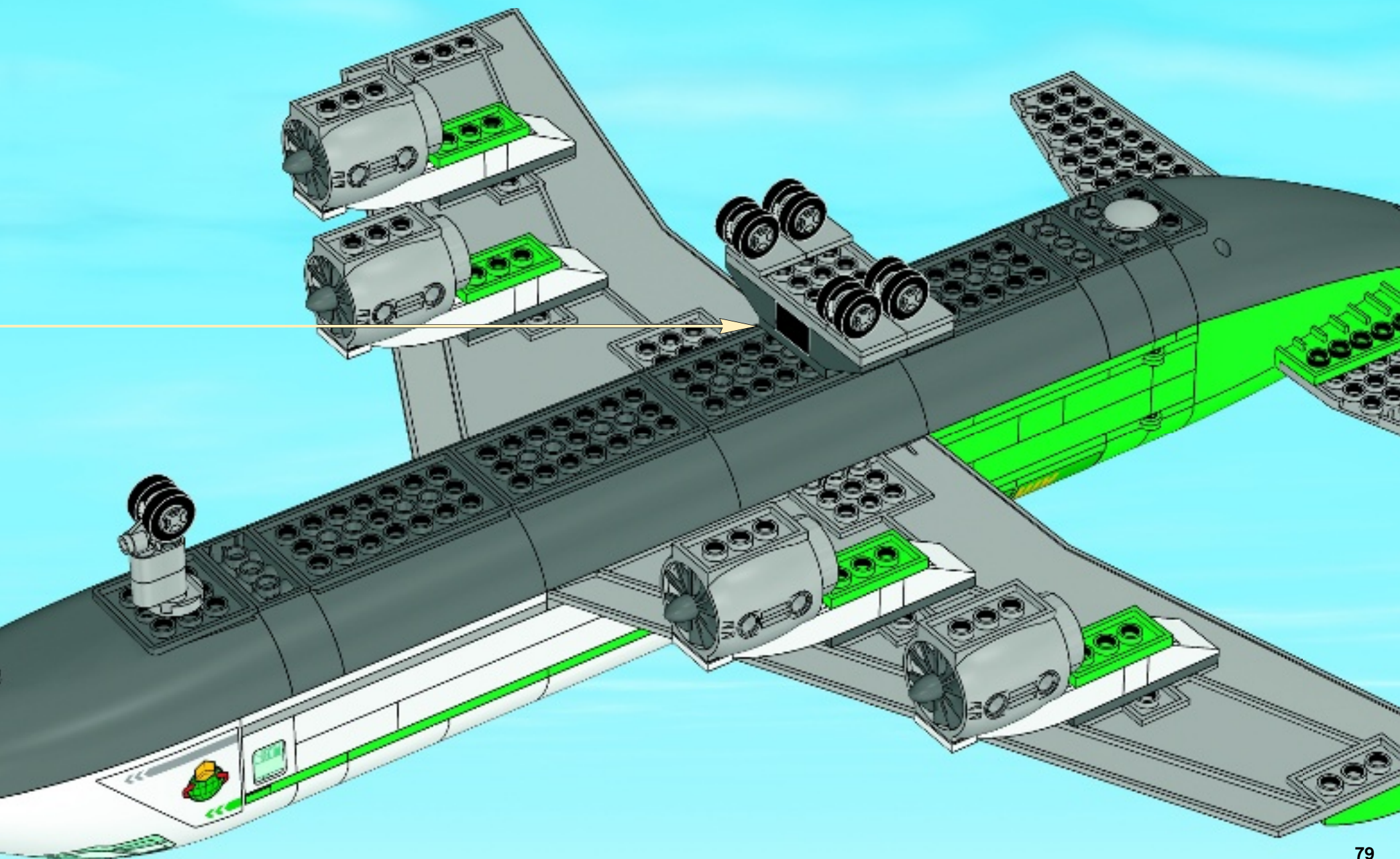



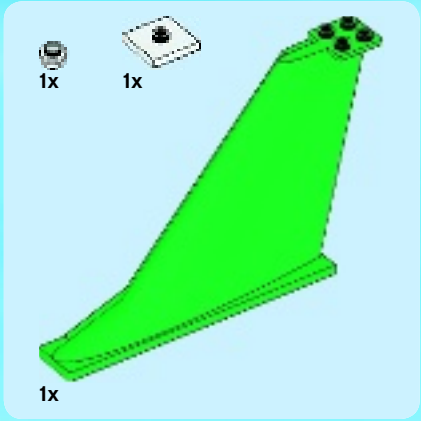
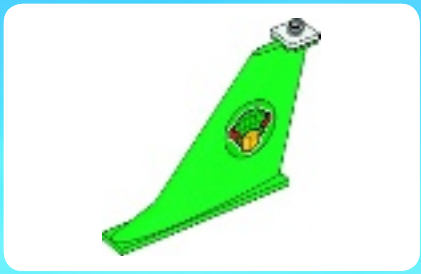

61

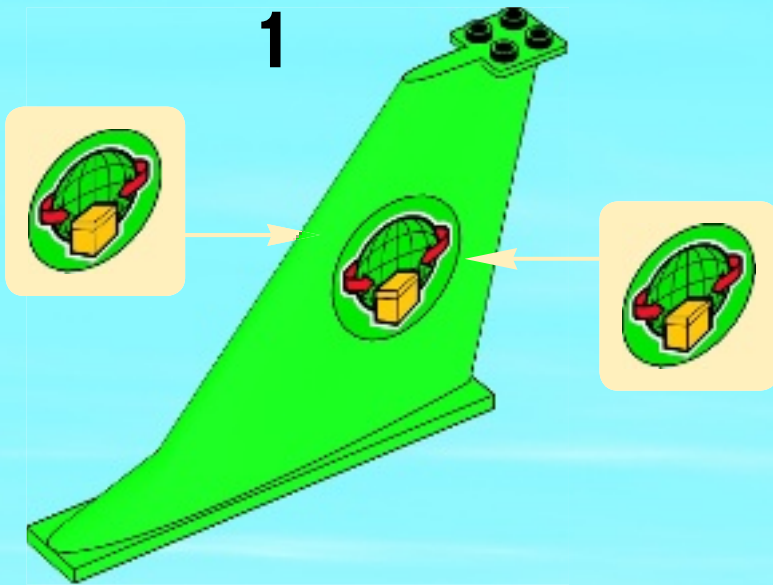

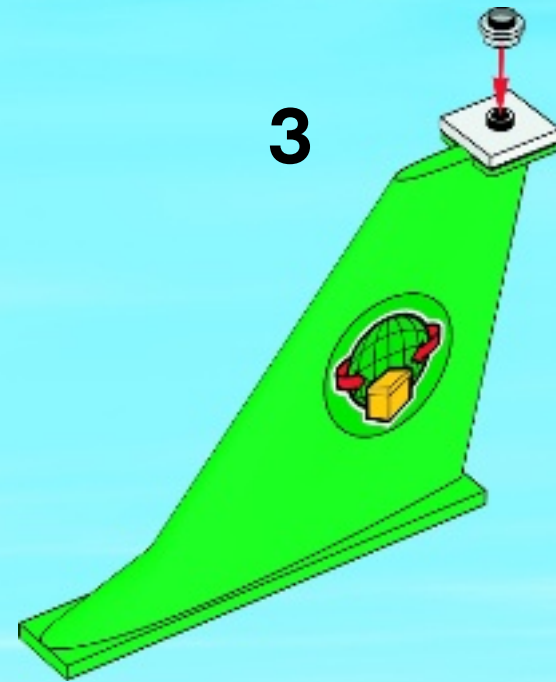
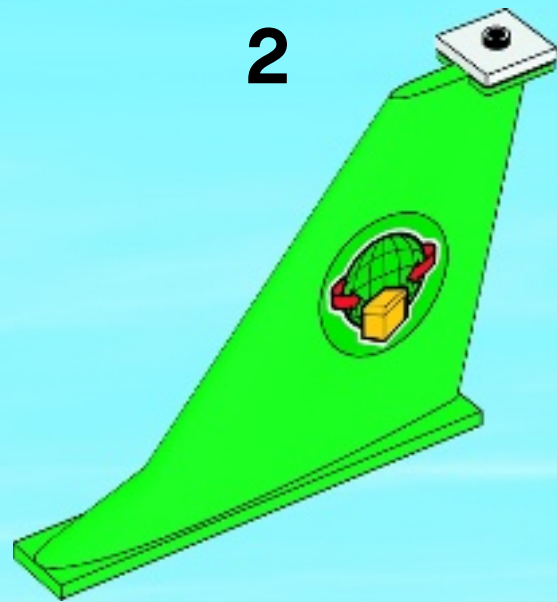



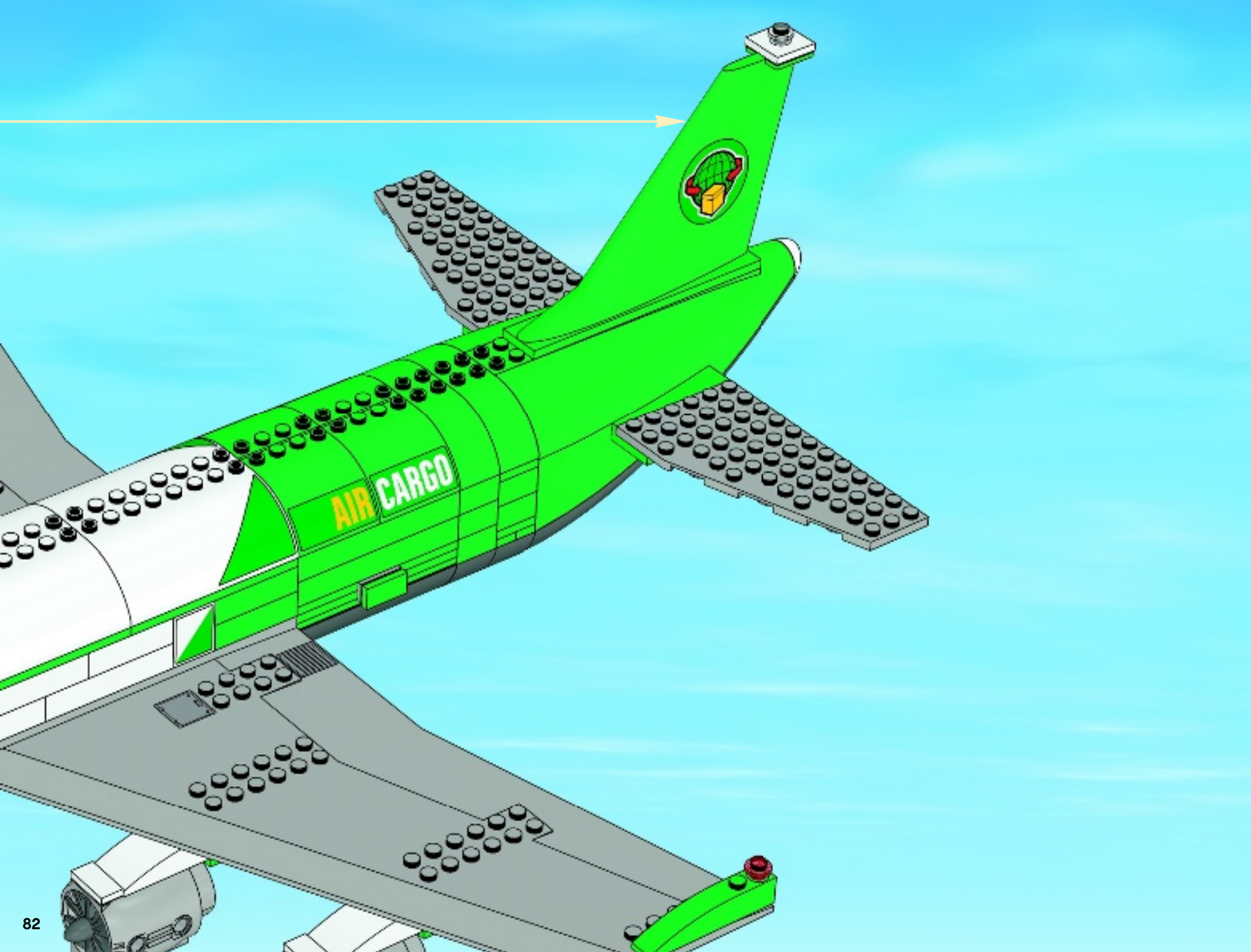



2x



1x

# 62





