



Architecture

21037

LEGO® House

Billund, Denmark



[LEGO.com/architecture/booklet](https://www.lego.com/architecture/booklet)

LEGO® House



"For my family and myself, the LEGO Group has always been much more than just a company and our products more than just products. I am very passionate about play and how children learn through playing with LEGO® bricks. This is essentially the LEGO idea and what the LEGO House is all about. It has been very exciting seeing this long-time dream of having one place where everyone can experience the LEGO idea come true."

Kjeld Kirk Kristiansen,
grandson of the founder and
current LEGO Group owner



Scan the QR code with your smartphone to see a video of Kjeld Kirk Kristiansen talking about the LEGO® House project

Home of the Brick



For many years, LEGO® employees and their guests enjoyed visiting the small museum the company had created in the converted house of the company's founder, Ole Kirk Kristiansen, in the heart of Billund.

All the visitors were thrilled to learn about the history of the company and experience the philosophy behind LEGO play, and many expressed the wish to be able to share this experience with a wider audience. It was this enthusiastic interest that sparked the dream of creating an actual LEGO experience center.

"The location here in Billund is important. We were founded here, and we want to help develop and create life in the town, making it attractive to both citizens and visitors."

Kjeld Kirk Kristiansen

From the very beginning, the ambition with LEGO® House was to create a unique and inspiring, hands-on and minds-on experience, where LEGO fans of all ages could learn all about the company and the endless play possibilities offered by LEGO bricks.

It was quickly agreed that the right location would be in the center of Billund. This is where the LEGO story started almost 90 years ago and the town still serves as the global headquarters of the LEGO Group. Then came the task of finding a partner who could design a distinctive building that would become an integral part of the LEGO House experience.



The original patent certificate for the LEGO® Brick from 1959.

Behind the Design

Bjarke Ingels, Founding Partner of BIG-Bjarke Ingels Group and architect of the LEGO® House, is not only a globally renowned architect, but also an enthusiastic LEGO fan. Before he and his team started working on the LEGO House project, they spent some time playing and building with LEGO bricks. They soon discovered that the systematic creativity of LEGO play often matched the way they approached an architectural task. They also found that the modularity of the LEGO brick inspired them in their work when designing the unique structure that would become the LEGO House.

"If BIG had been founded with the purpose of building only one single building, it would be the LEGO® House."

Bjarke Ingels





According to Ingels, the idea for the LEGO® House was to create “a cloud of interlocking LEGO bricks... a literal manifestation of the infinite possibilities of the LEGO brick.” 21 white bricks would be stacked on top of each other and be crowned by the Keystone, which would be inspired by the classic eight-knob LEGO brick.

These huge bricks will not only form internal spaces for LEGO House activities, but also create a covered public square and a series of interconnected terraces and playgrounds for people to investigate and enjoy. In this way, the LEGO House will be enjoyed both by fans who came to experience the LEGO story and by local citizens and visitors to the town of Billund.

"LEGO® House gives us the opportunity to show how children learn through LEGO play, and at the same time we tell the LEGO history in an involving way which reflects our values."

Kjeld Kirk Kristiansen





From Idea to Reality

The completed LEGO® House covers an area of almost 129,167 sq. ft. (12,000 m²), 91,493 sq. ft. – (8,500 m²) above ground and 36,597 sq. ft. (3,400 m²) of basement – and reaches 75.4 ft. (23 m) into the Billund skyline. It consists of four specially themed Experience Zones that offer the guests unique hands-on LEGO play experiences. There is also a historic section underground that presents the company's heritage and relates the story of the development of the LEGO products and Brand.

While the largest part of the building is reserved for paying guests, almost a quarter of the above-ground area of LEGO House – including most of the terraces, plus the café and shop – are open to everyone.

"LEGO® House is a super important project – not only to BIG and myself but to millions of people all over the world."

Bjarke Ingels



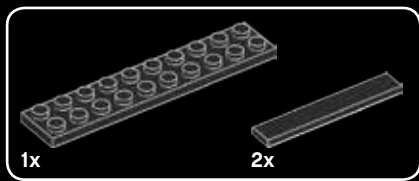
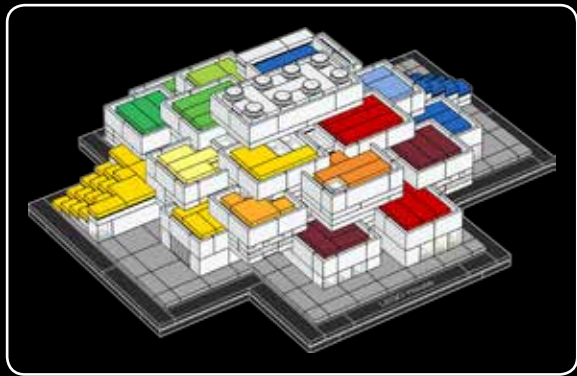

1

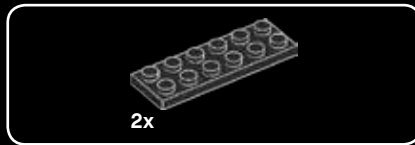
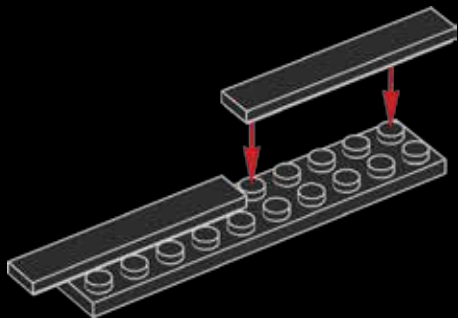

2

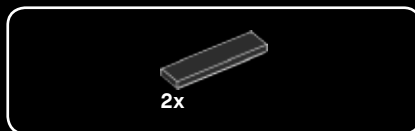
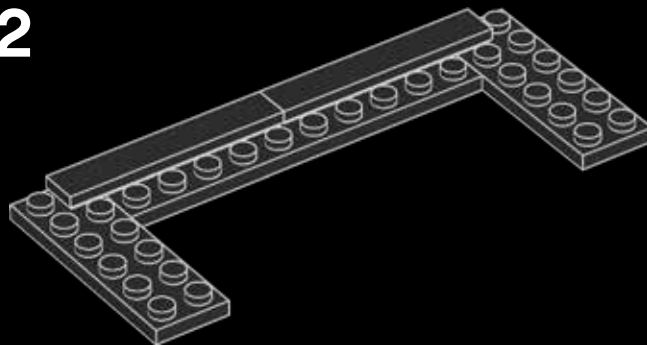

3

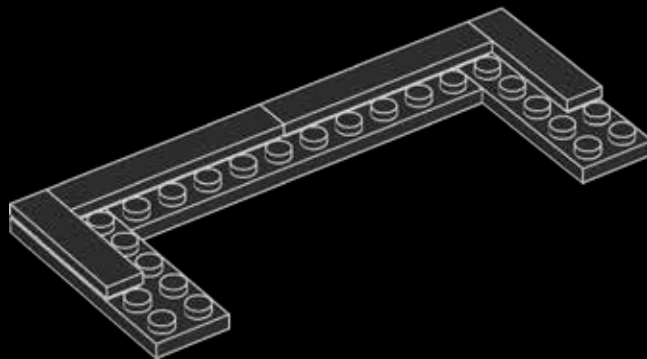

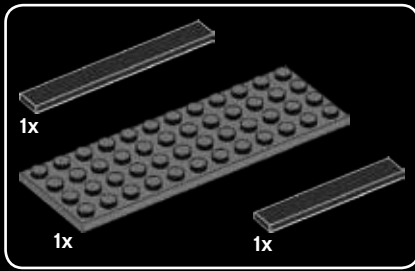

4

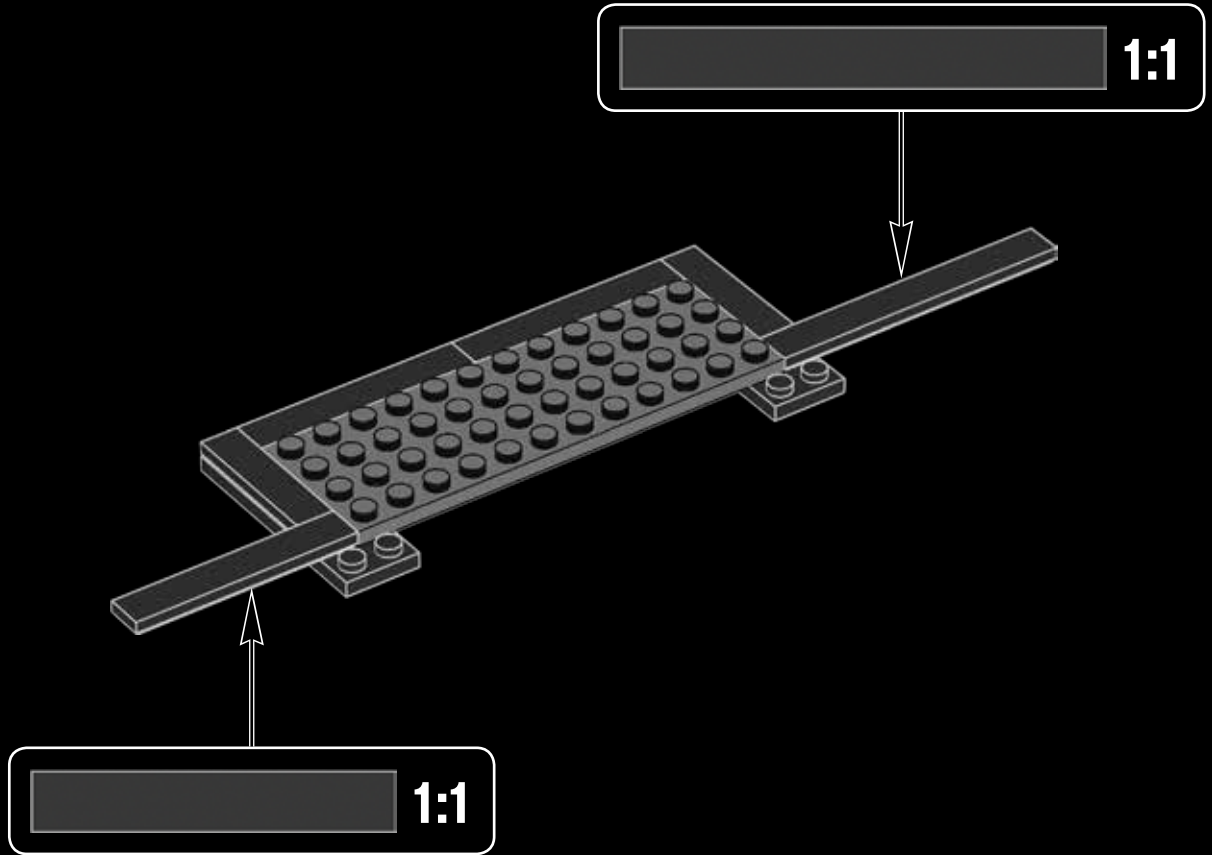

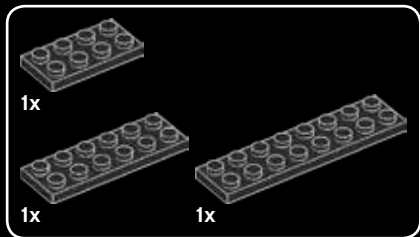

5

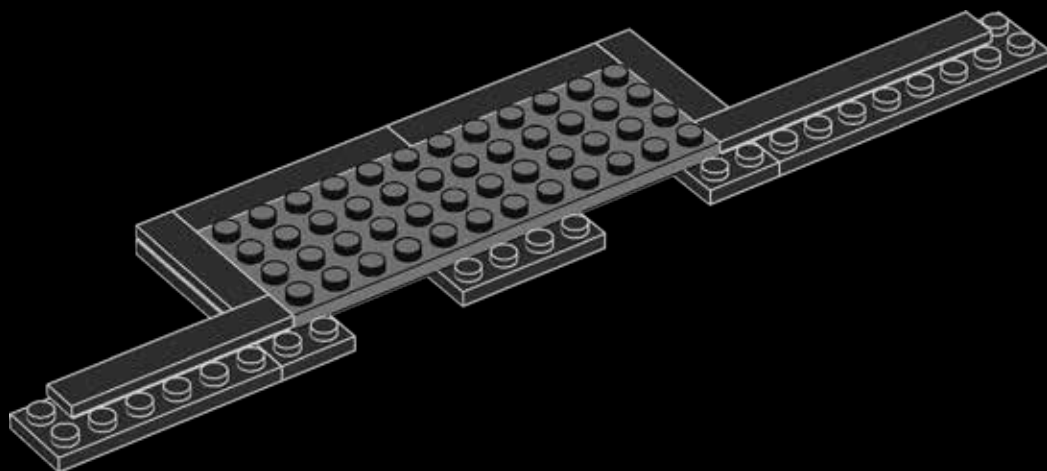

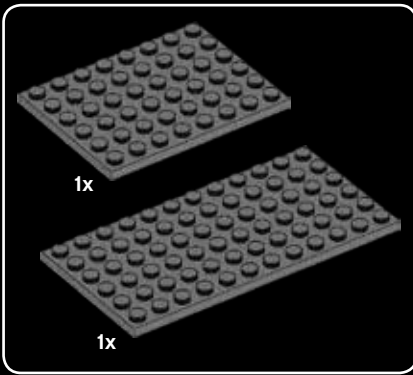

6

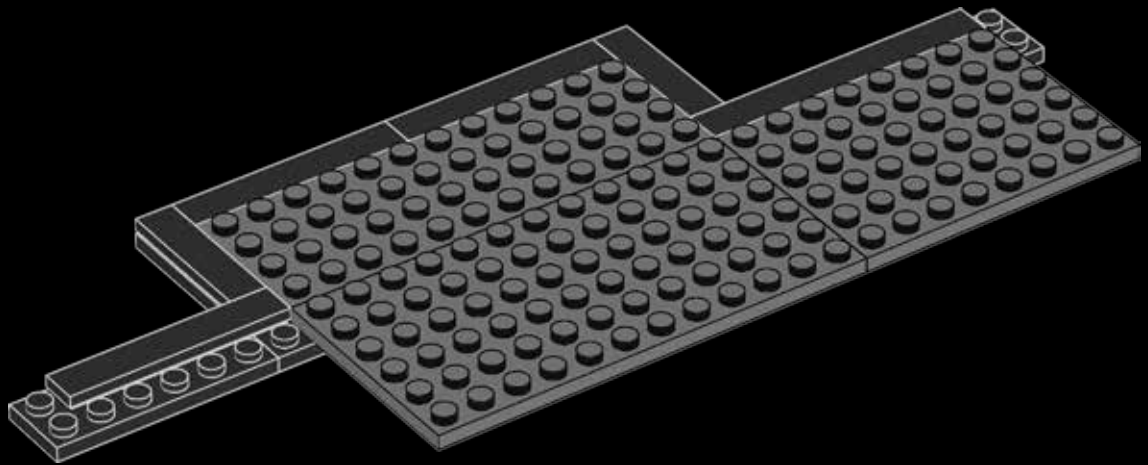

The lower deck of the
basement is made
up of 3,336 tons
(1,390 cubic meters)
of poured concrete.



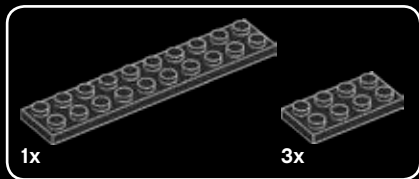

7

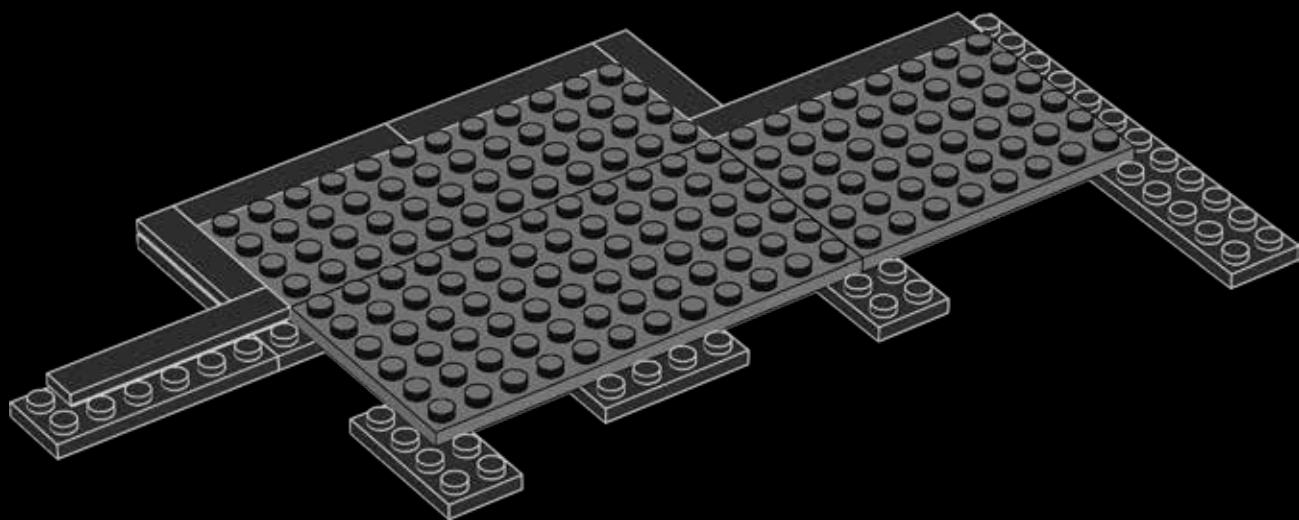

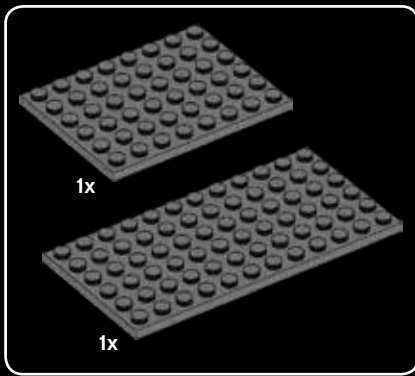

8

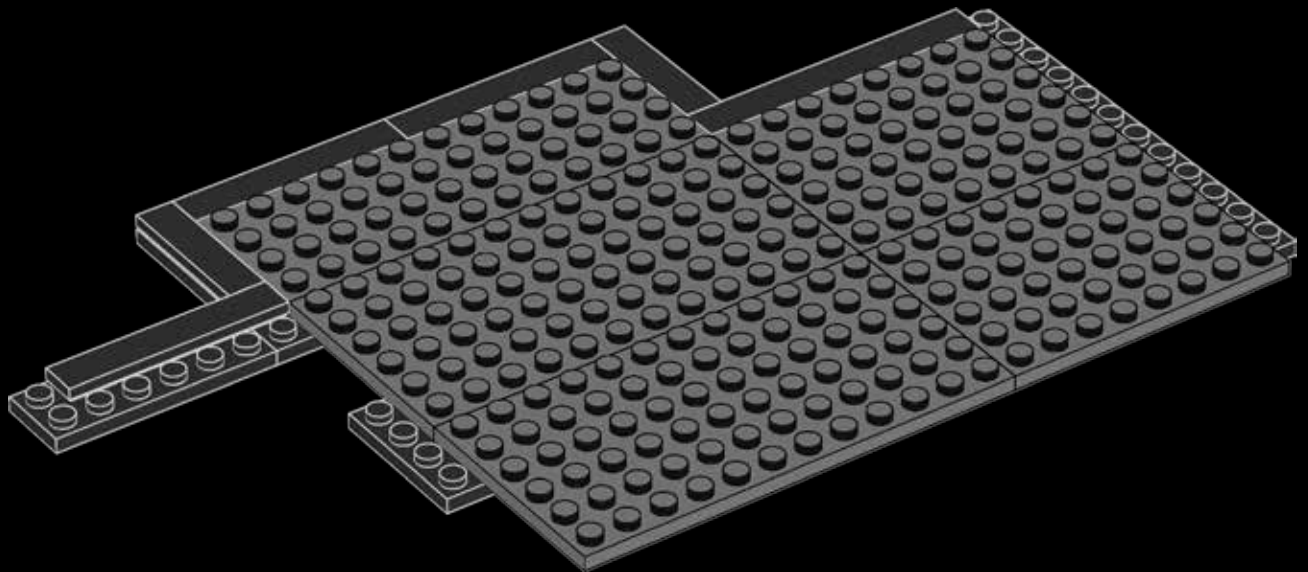

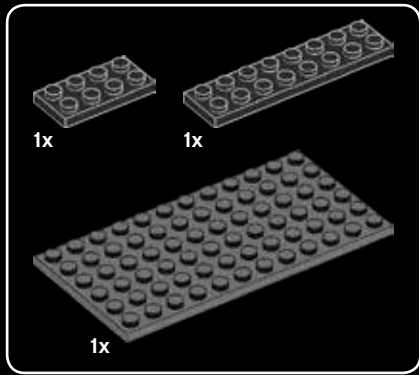

9

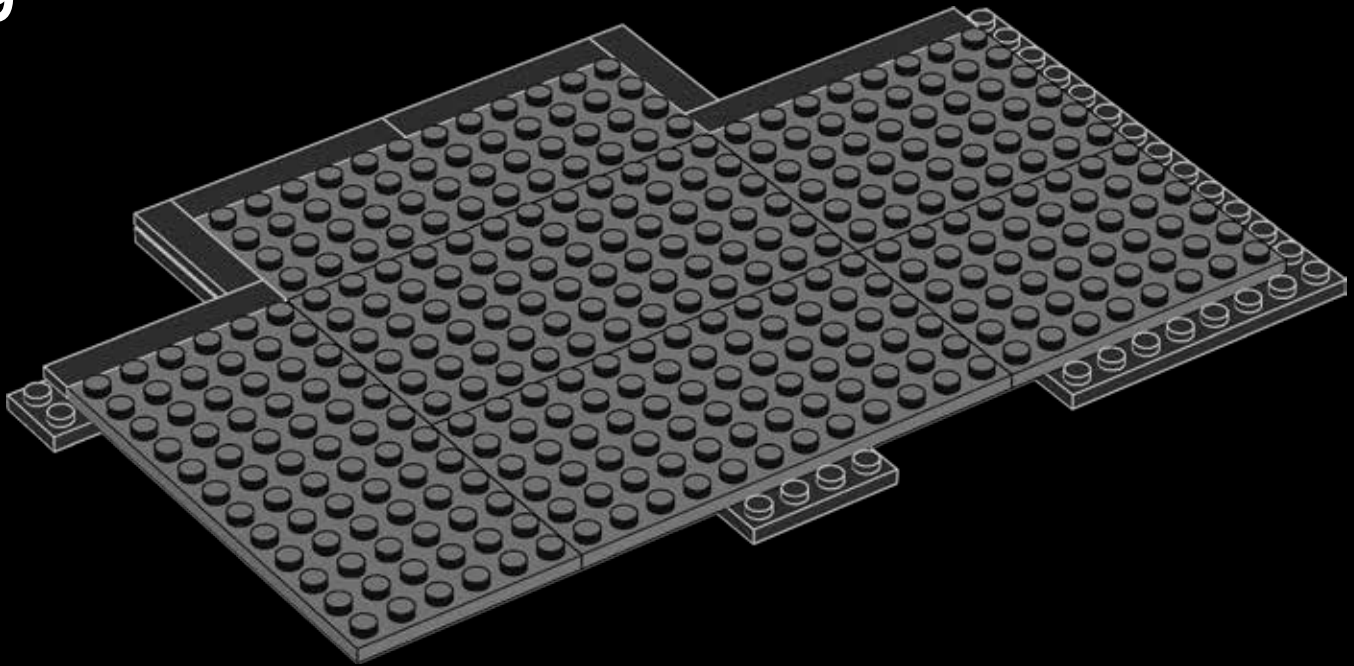

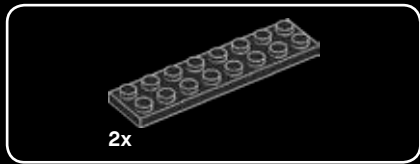

11

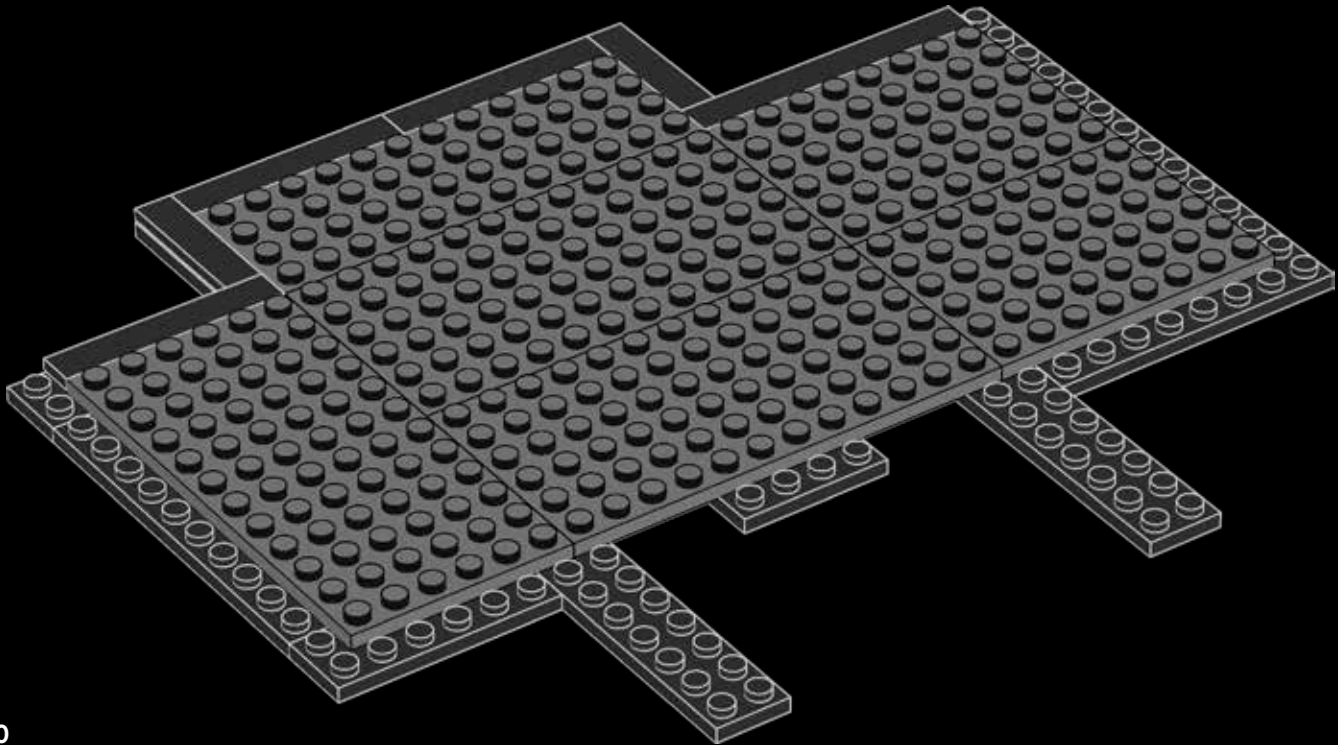

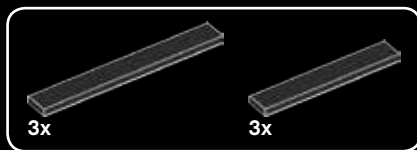

12

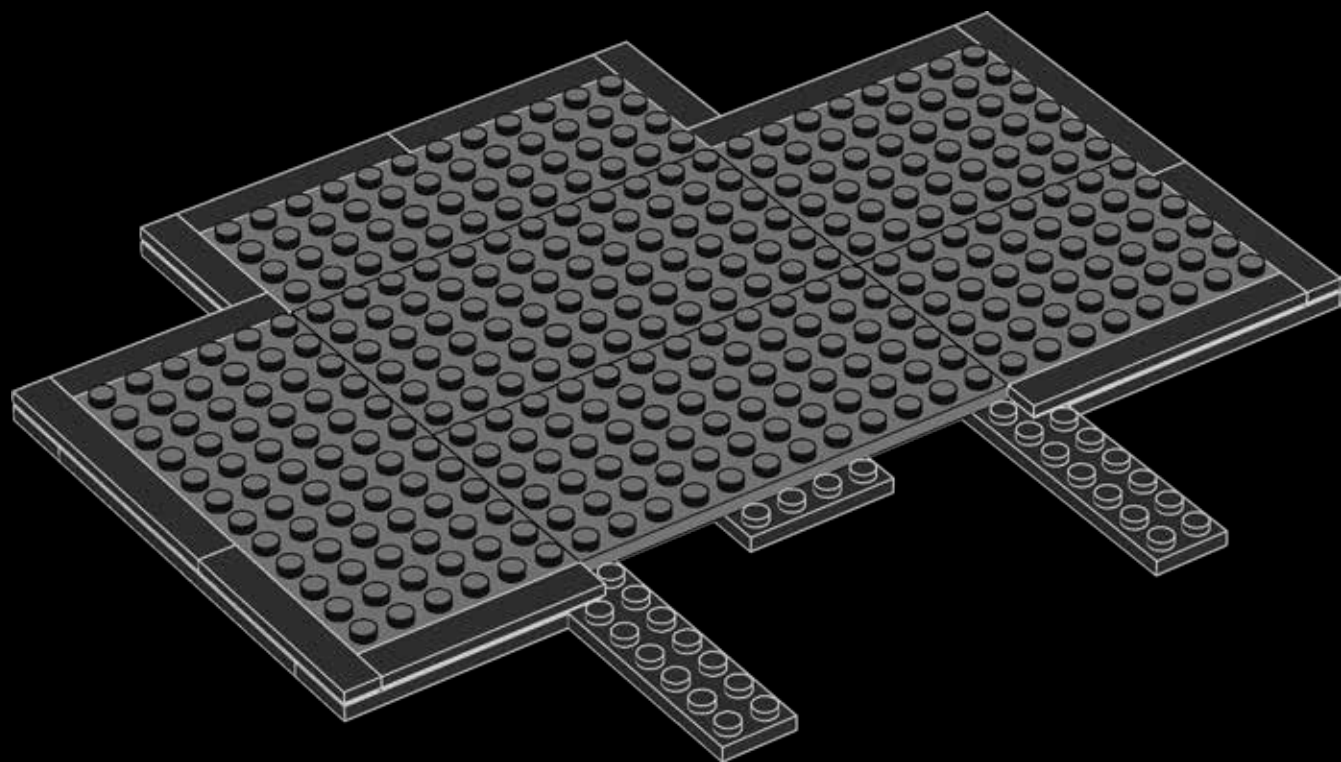

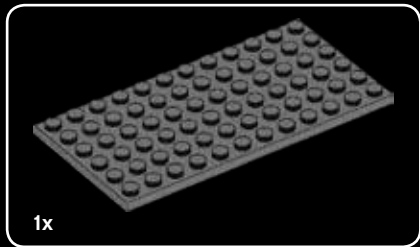

13

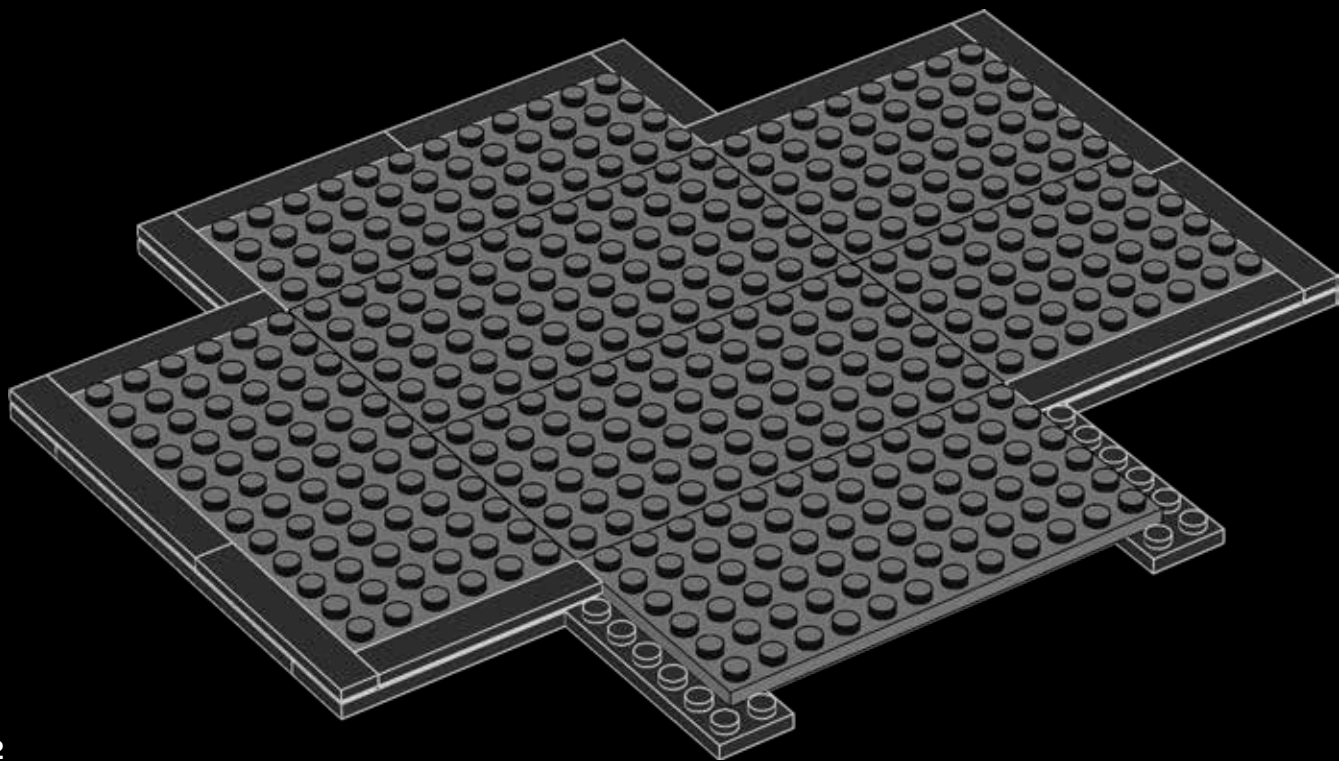

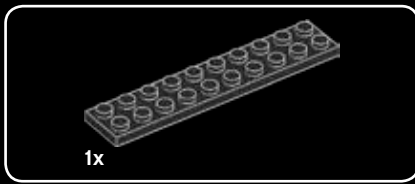

14

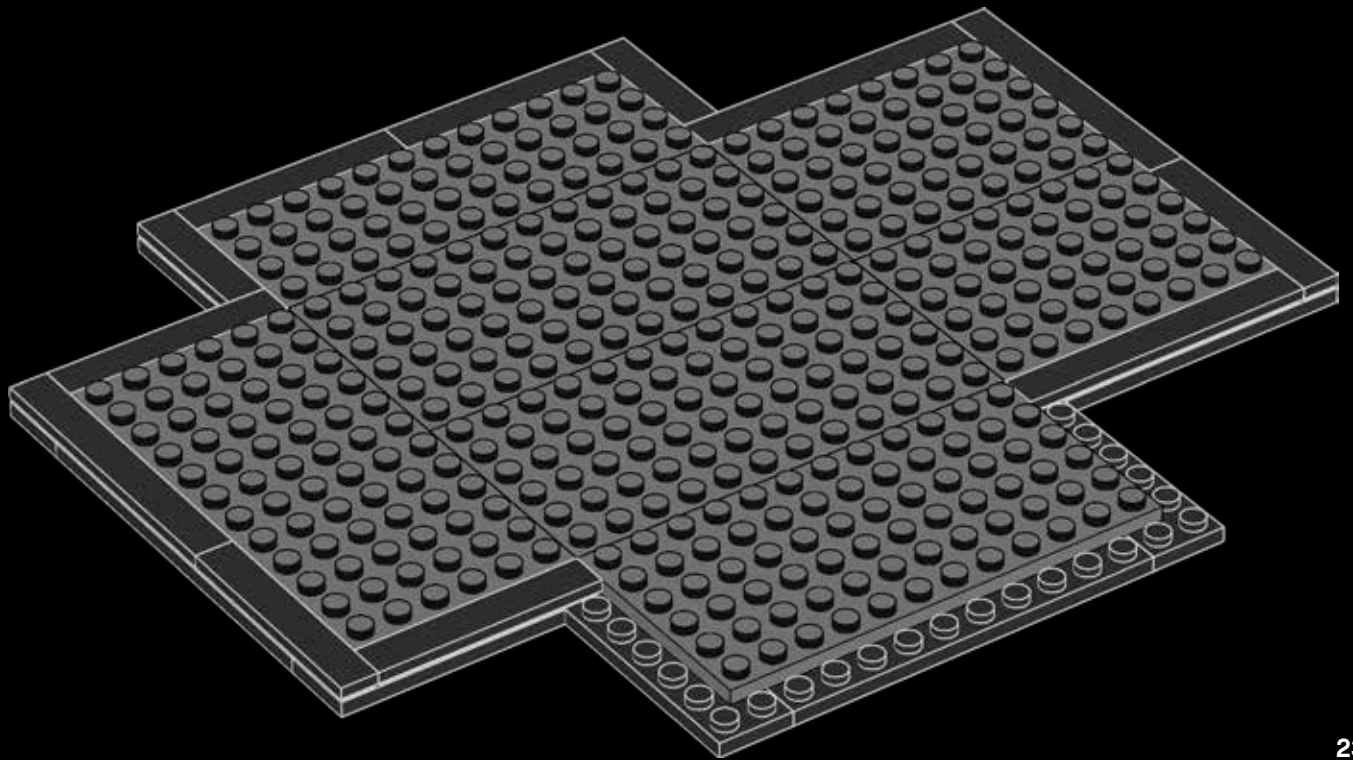

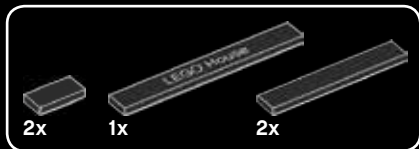

15

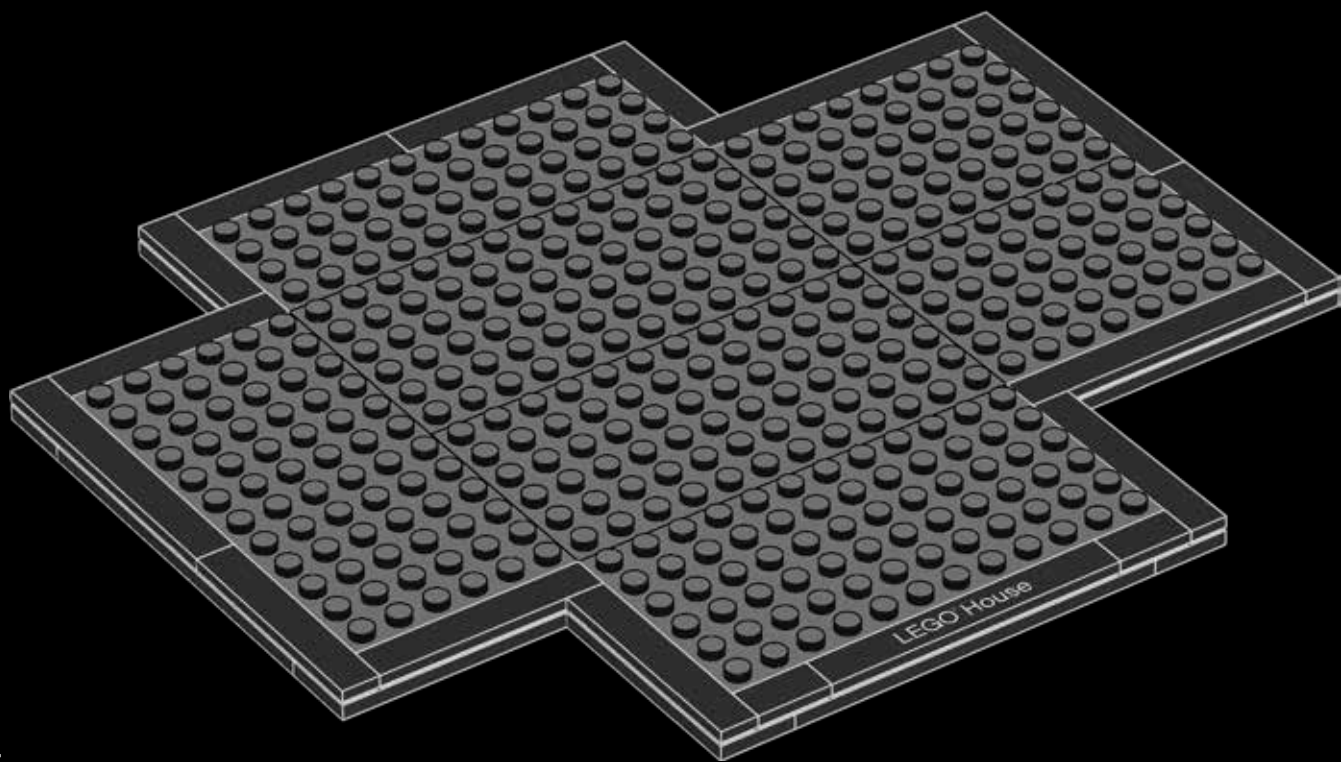



16

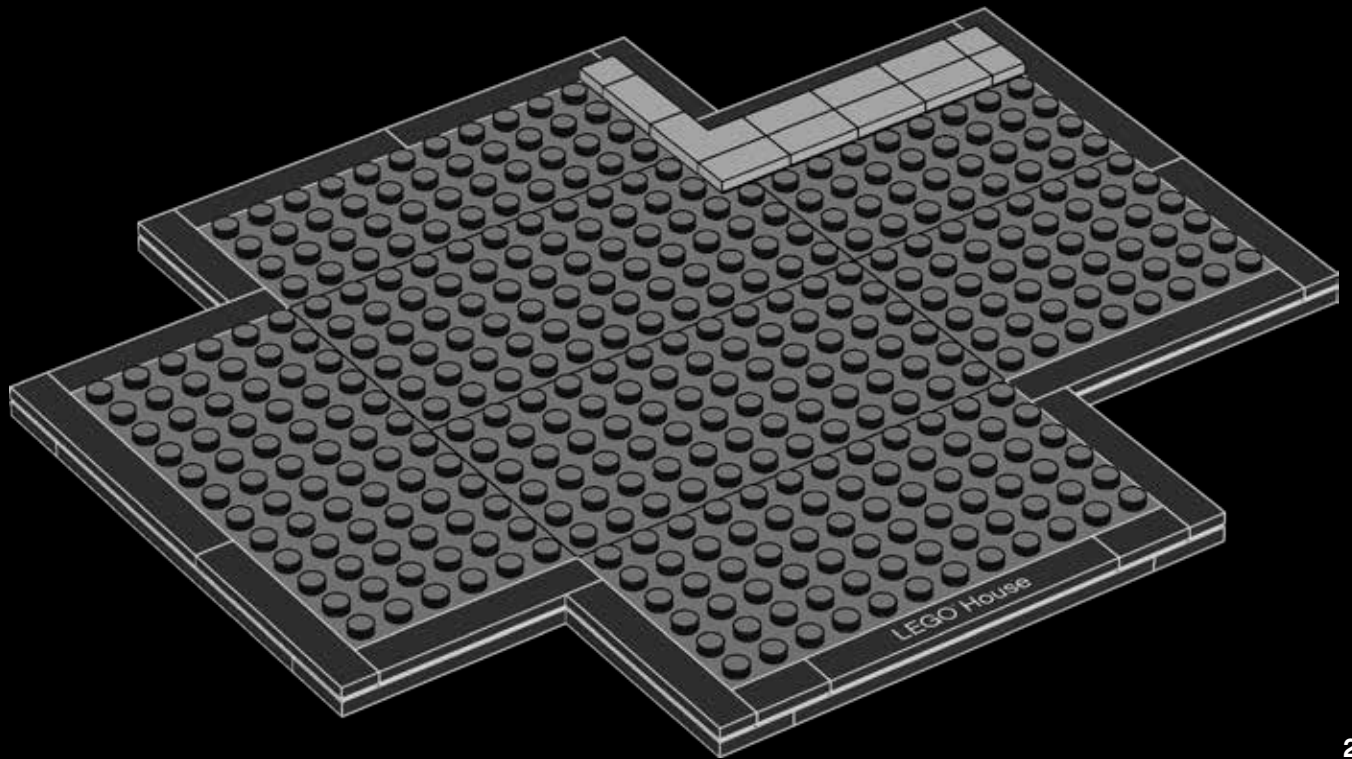

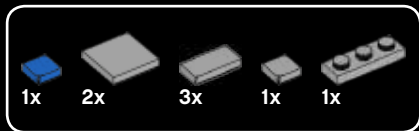

17

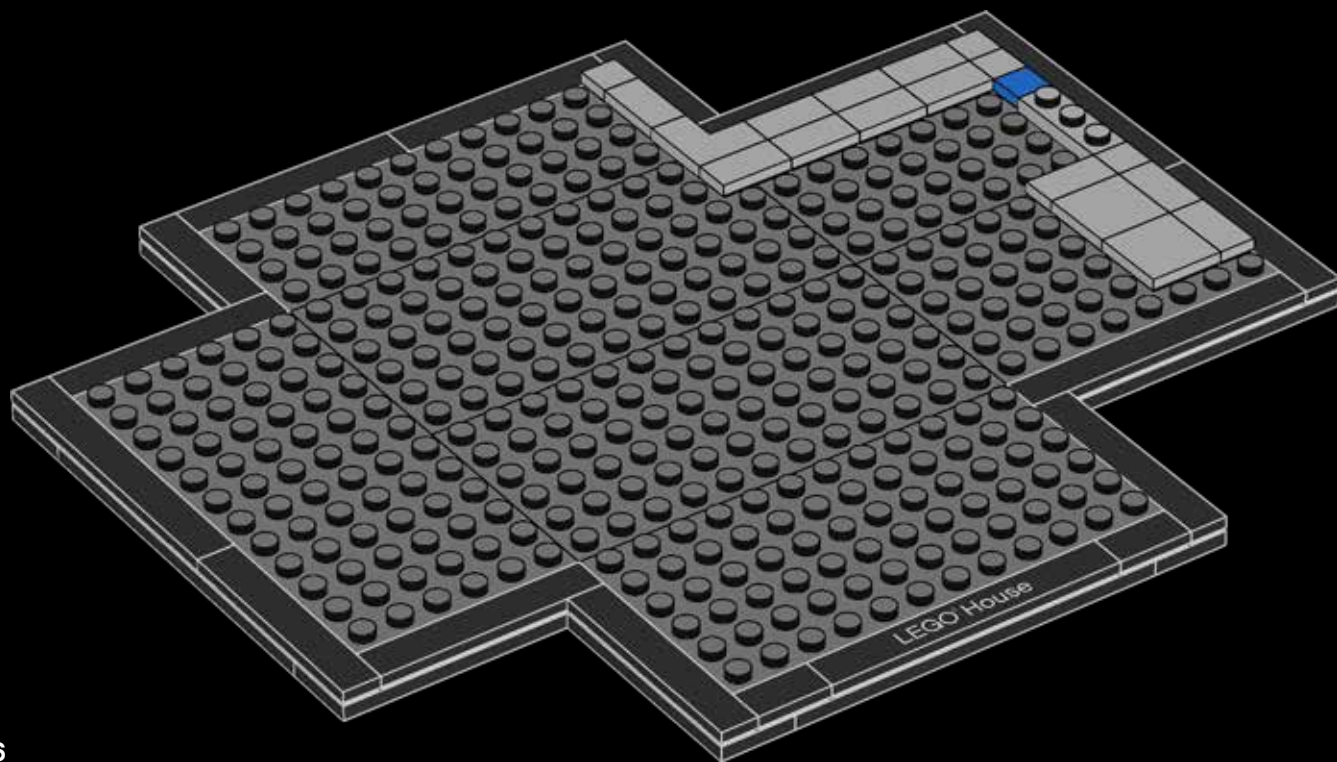



18



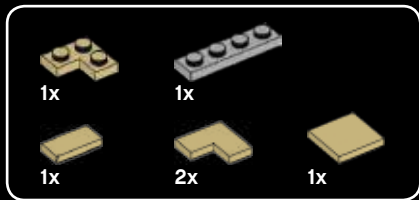

19

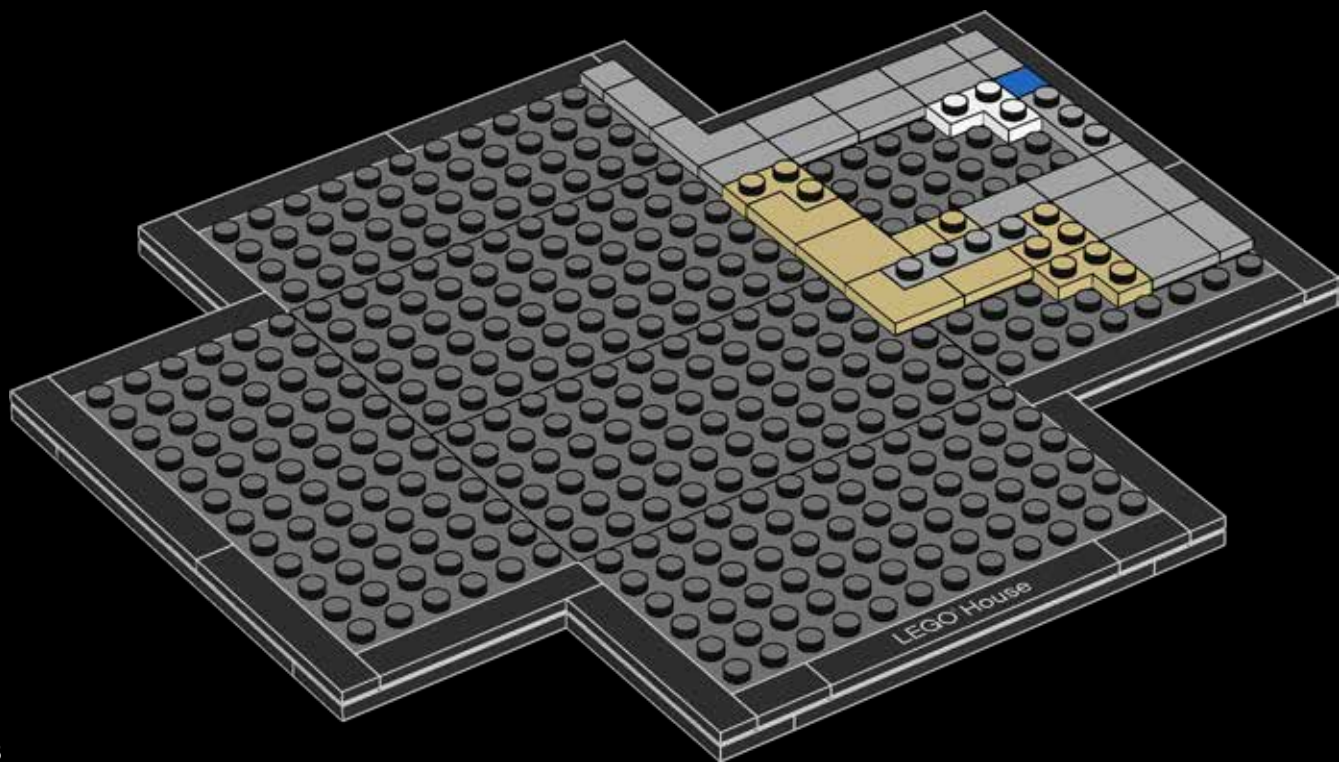



20

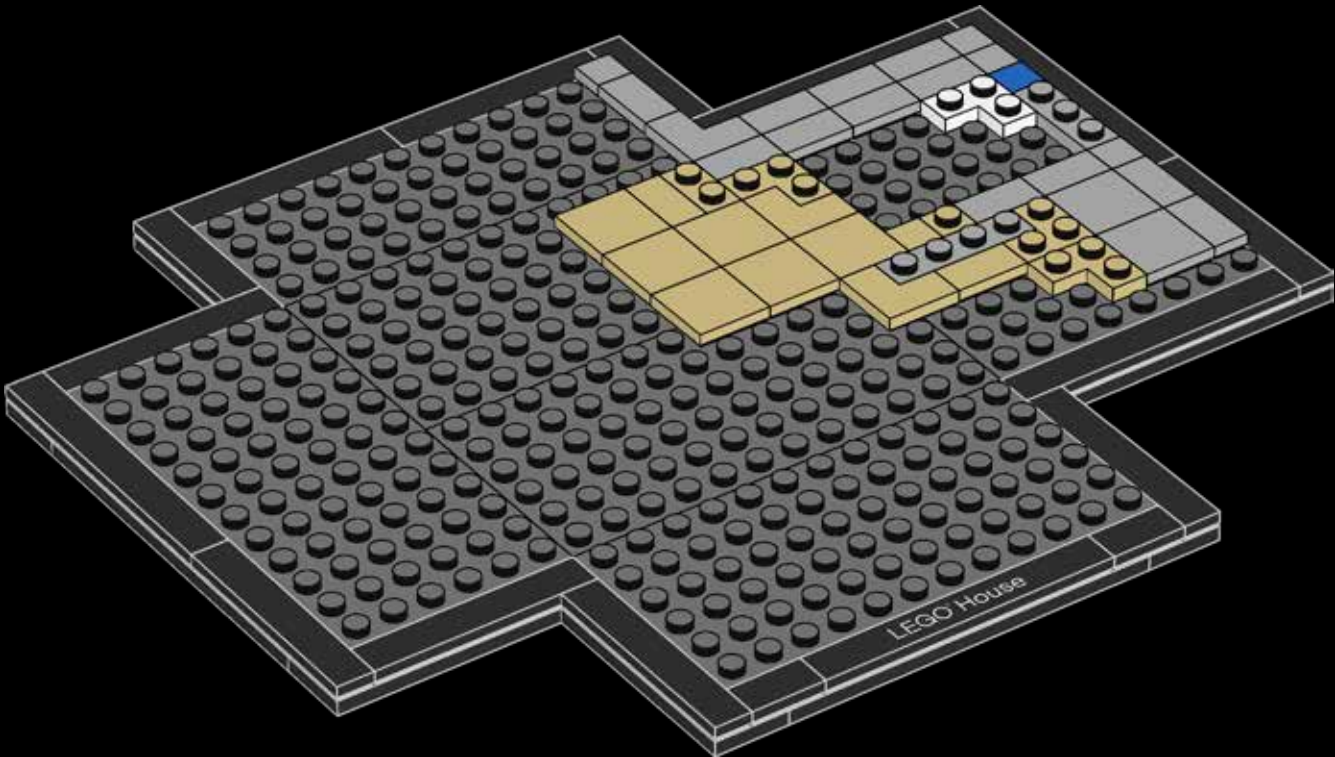

2x 3x 1x

21

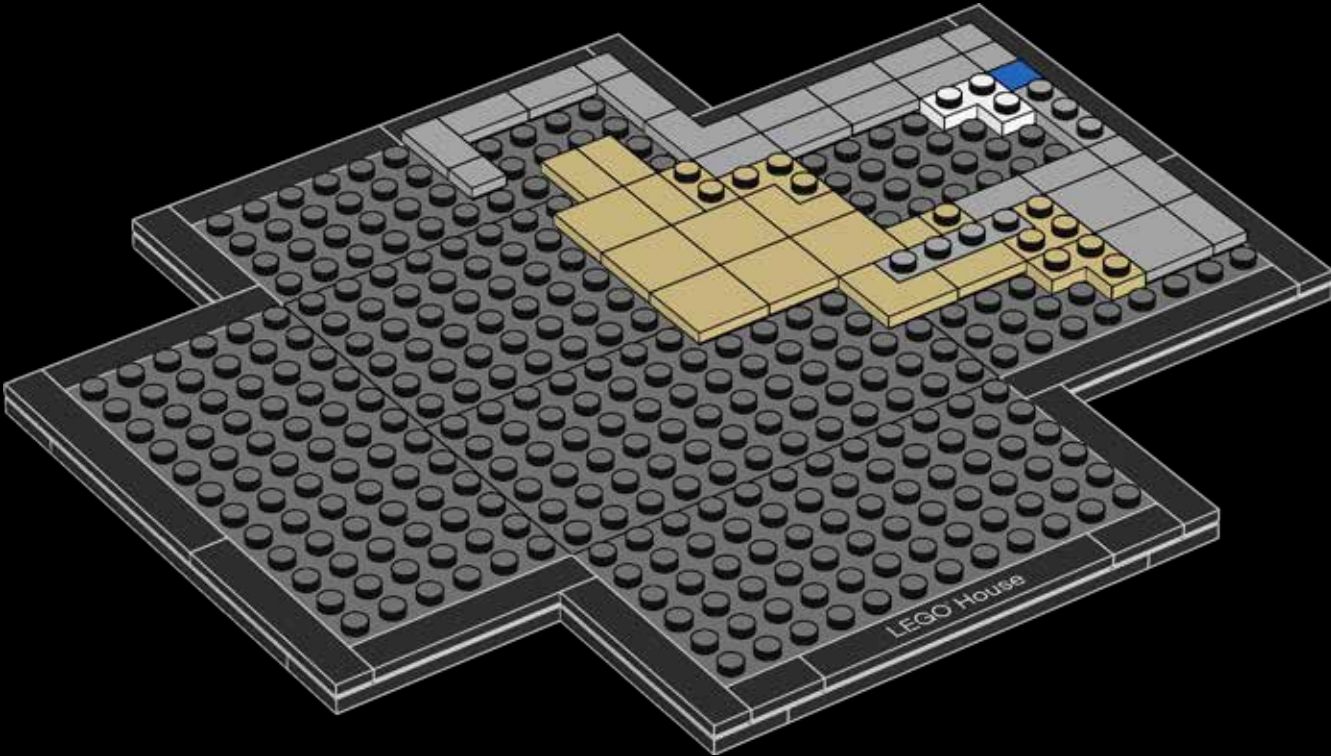

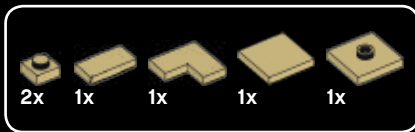

22

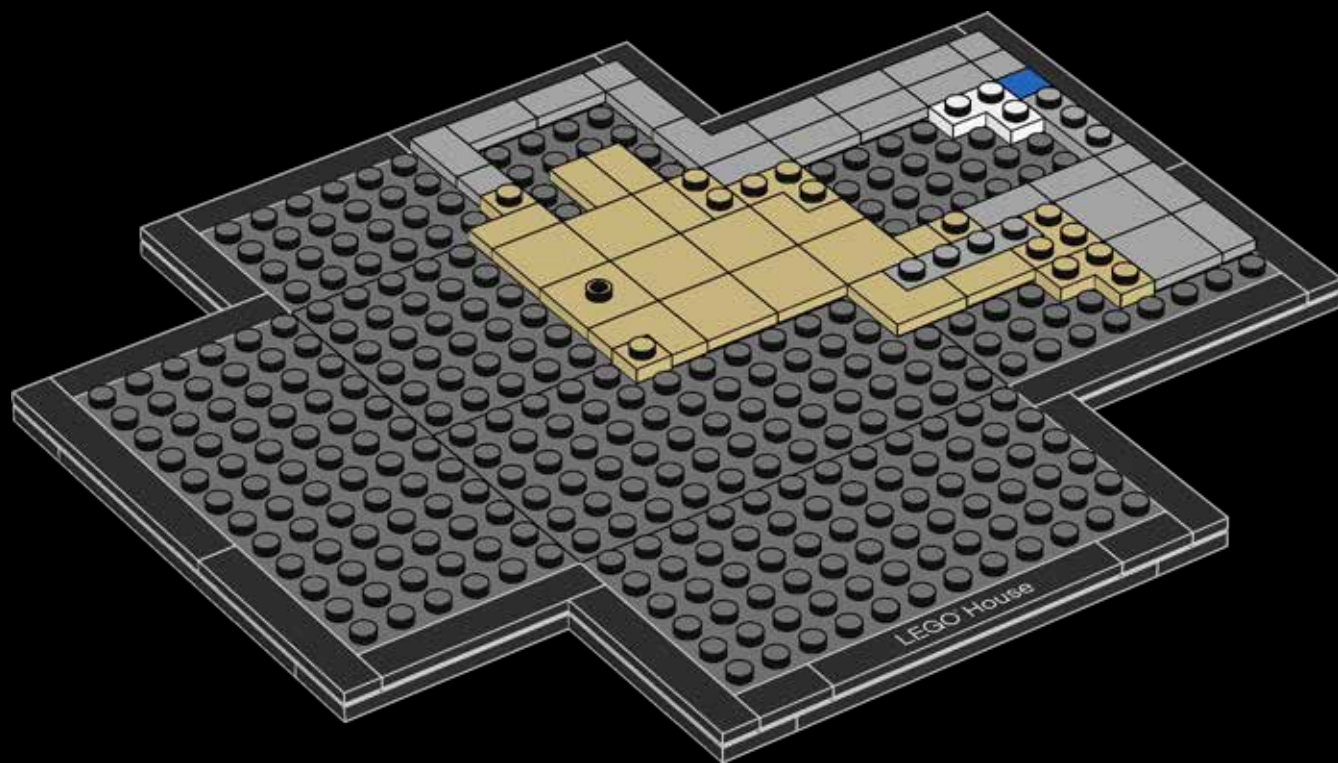



23

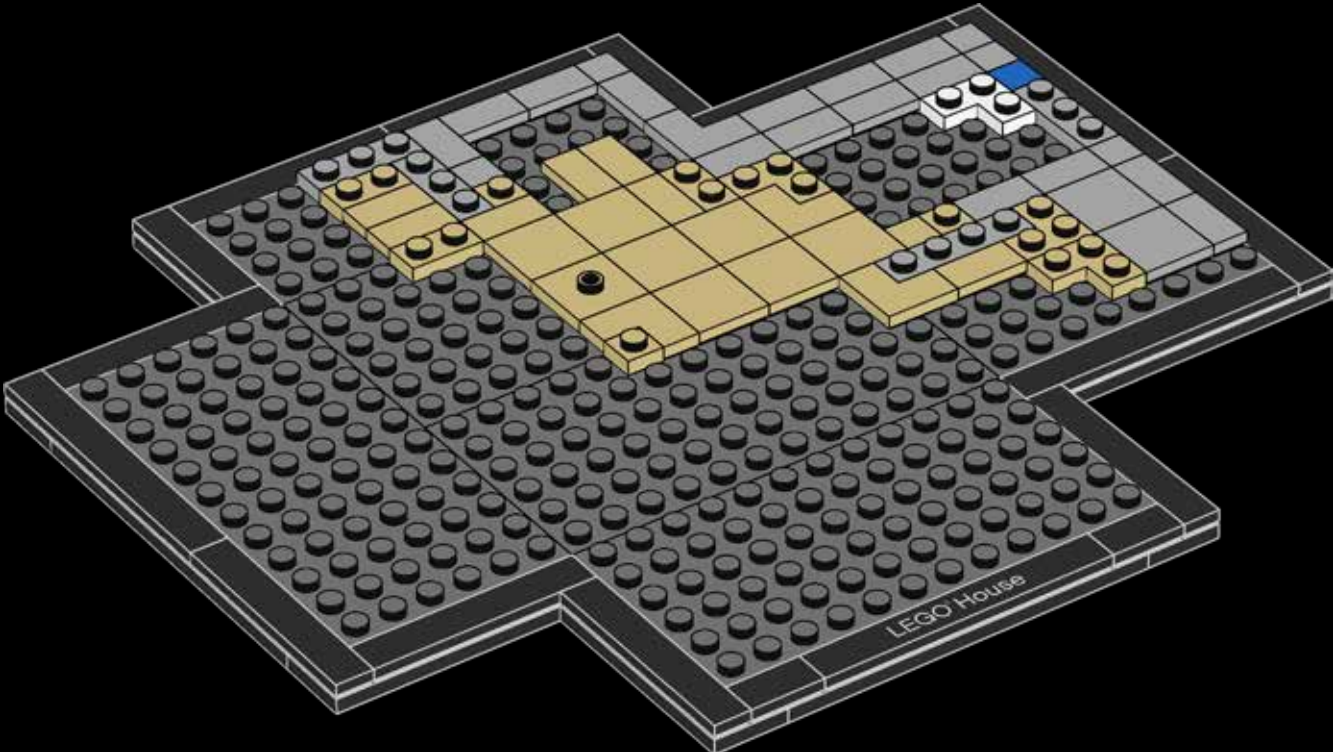

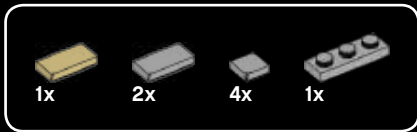

24

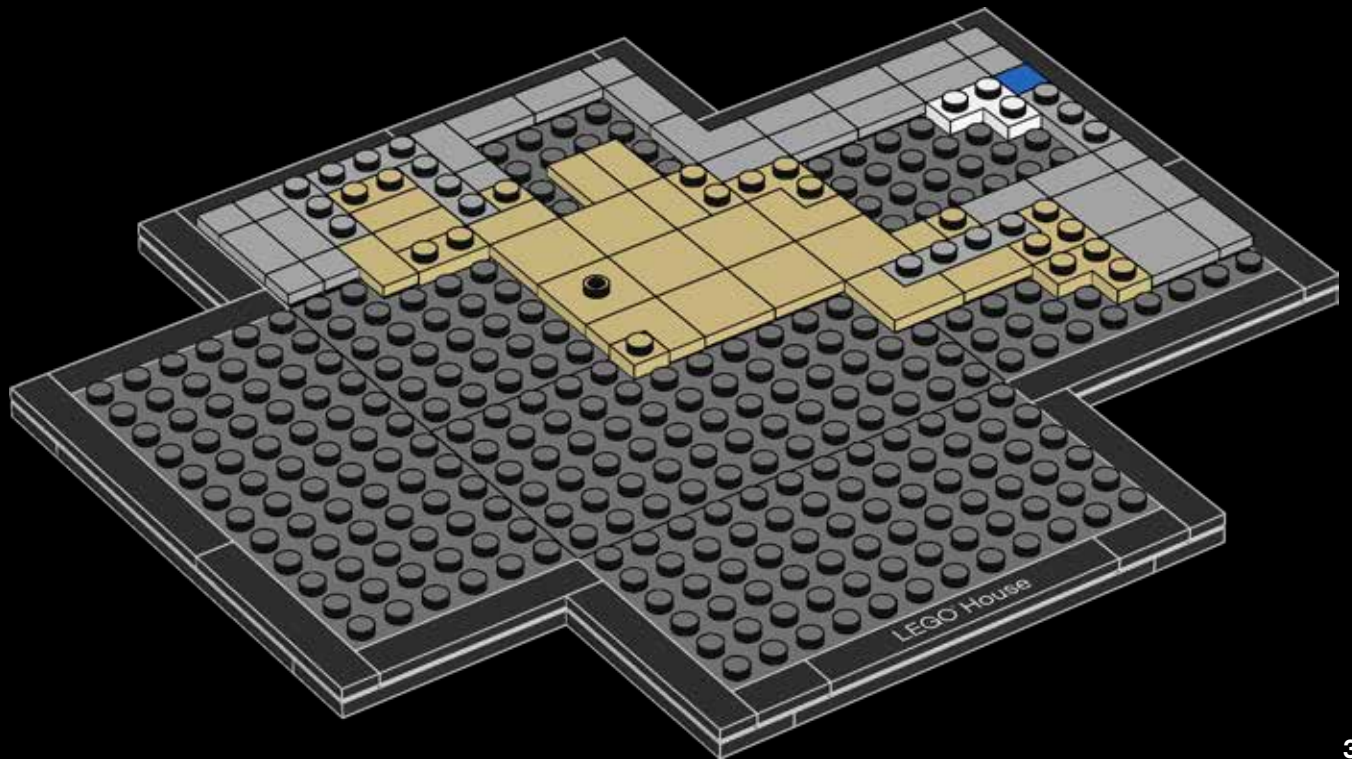



25

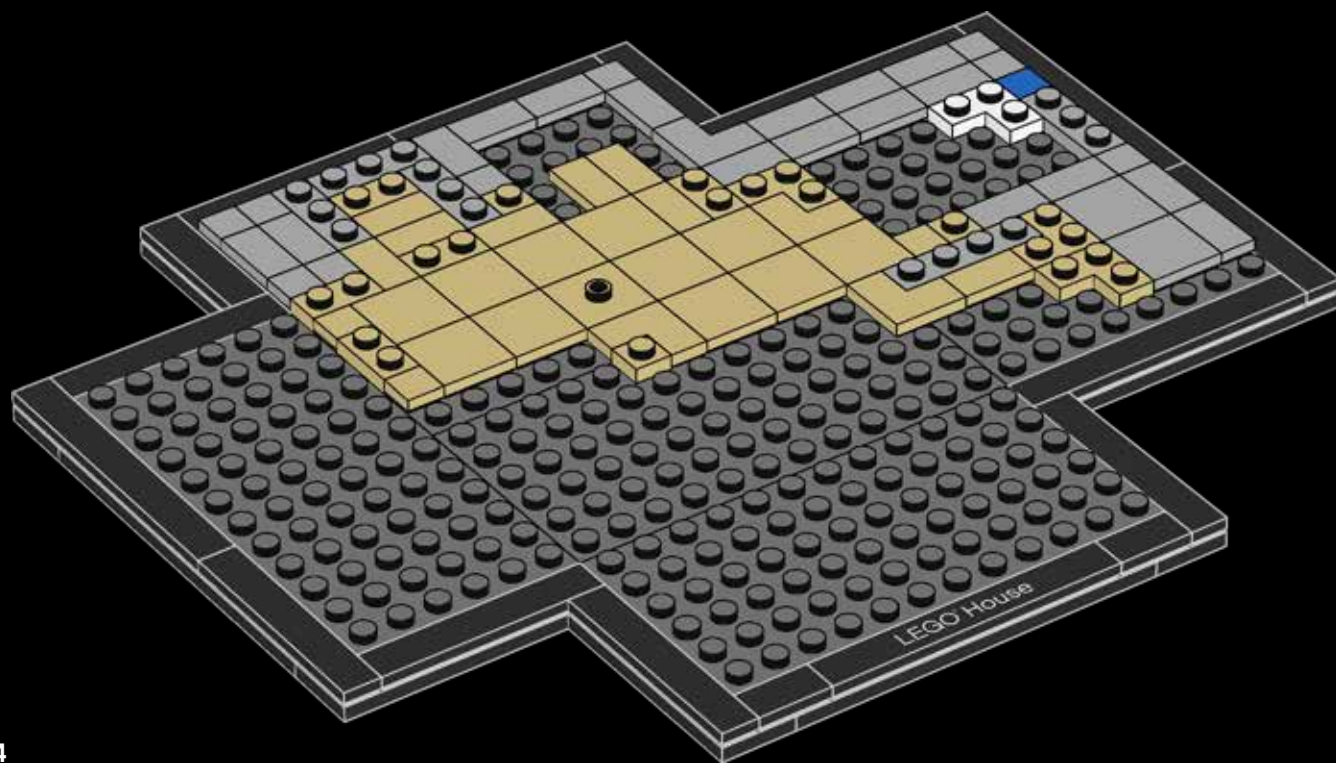



26

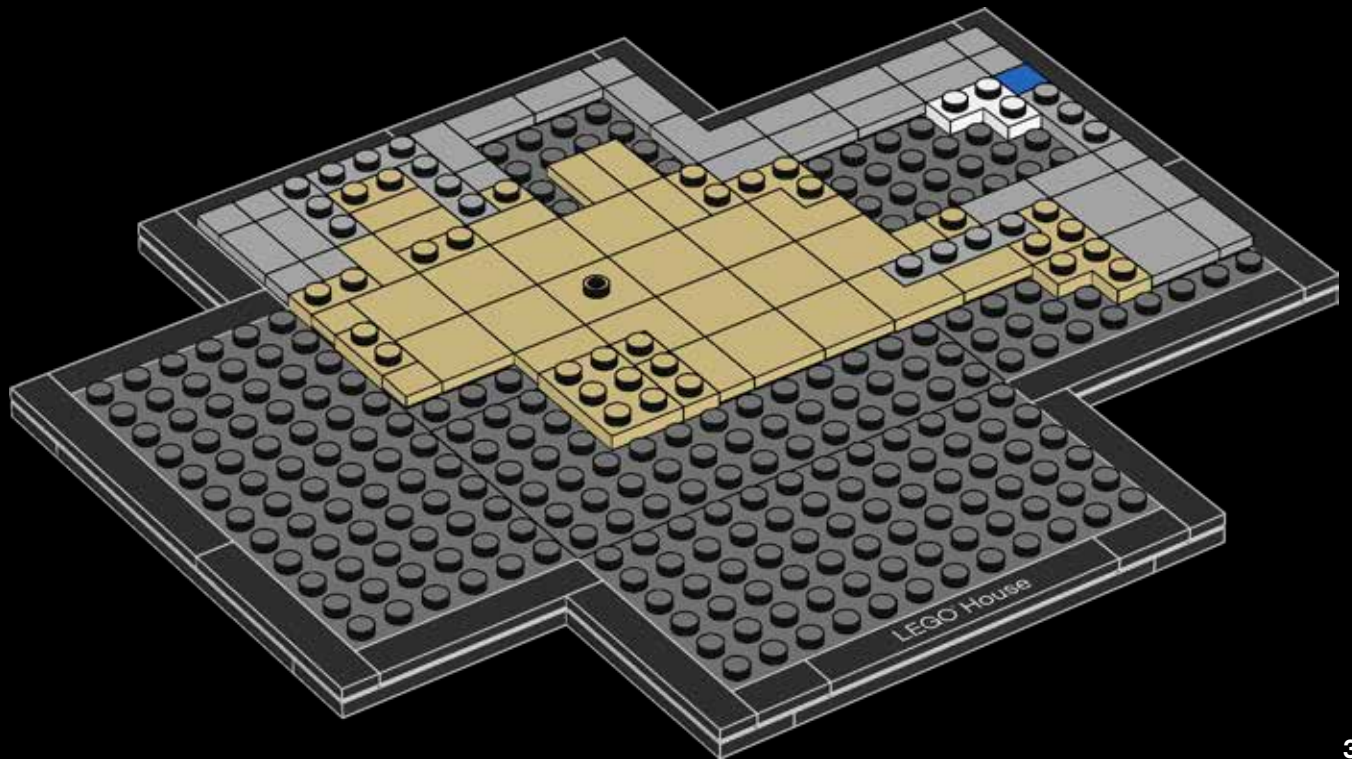



27

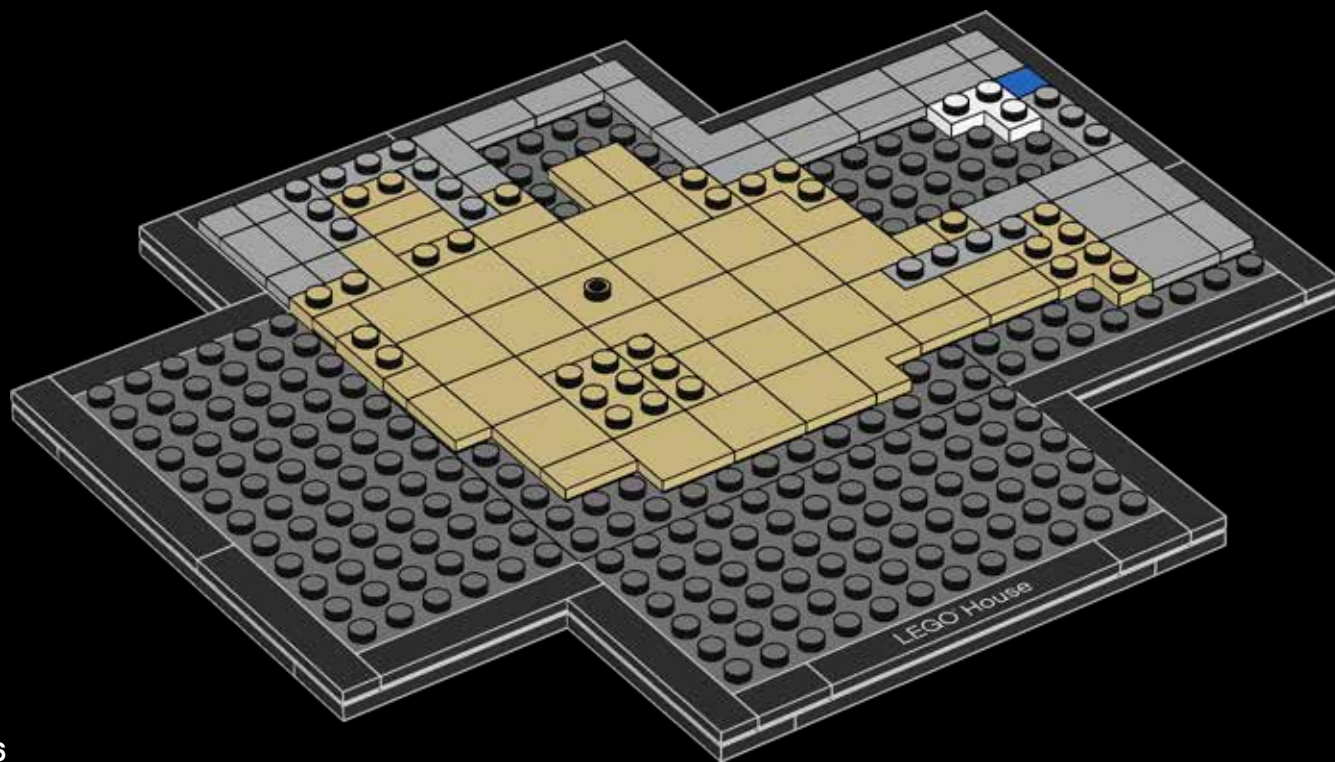



28

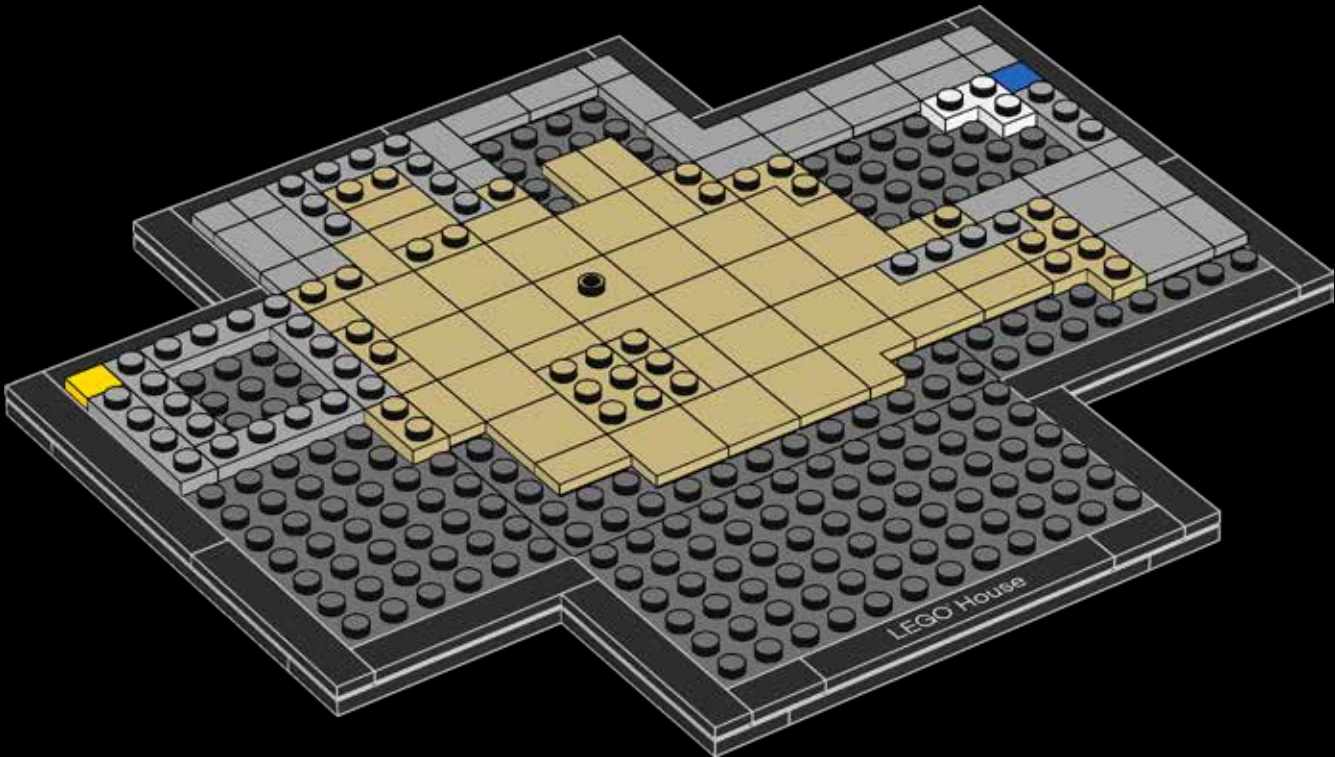

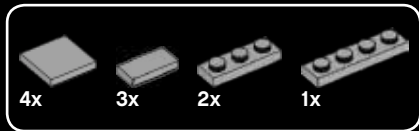

29

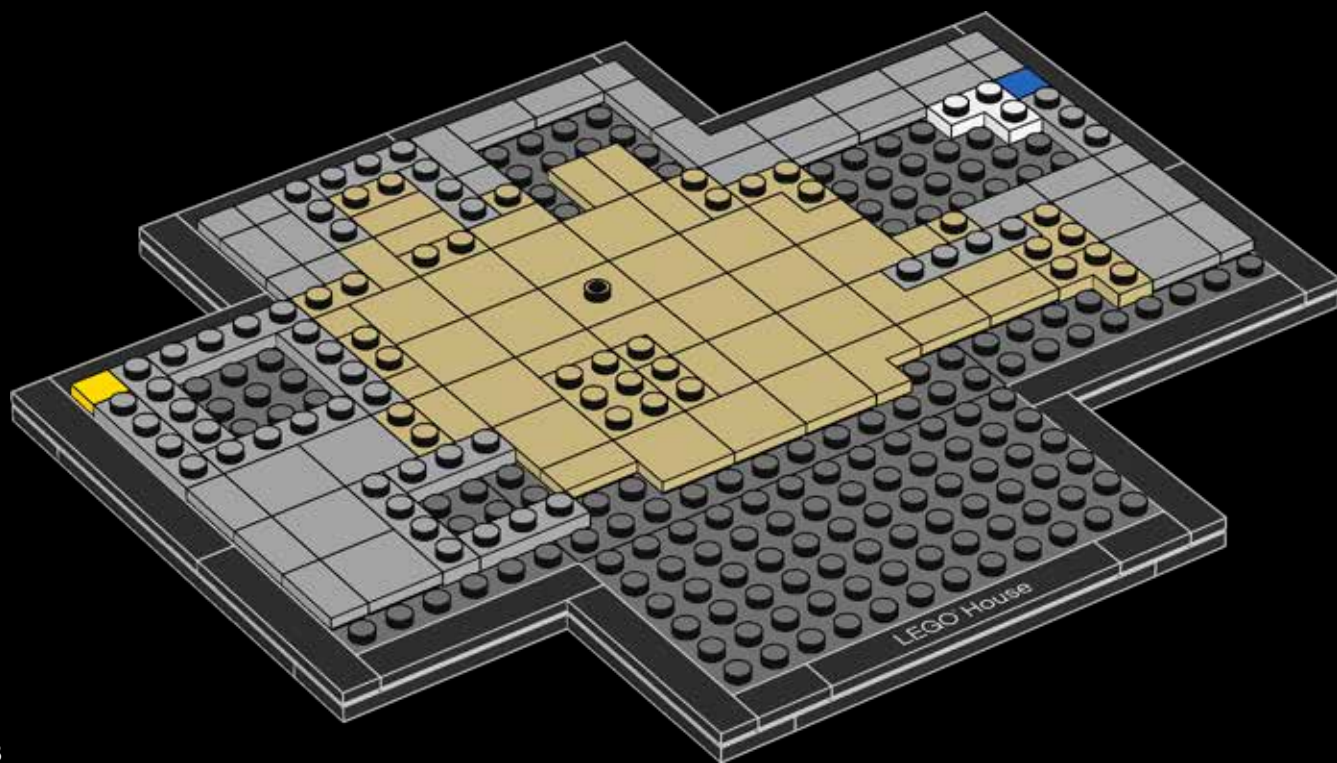



30

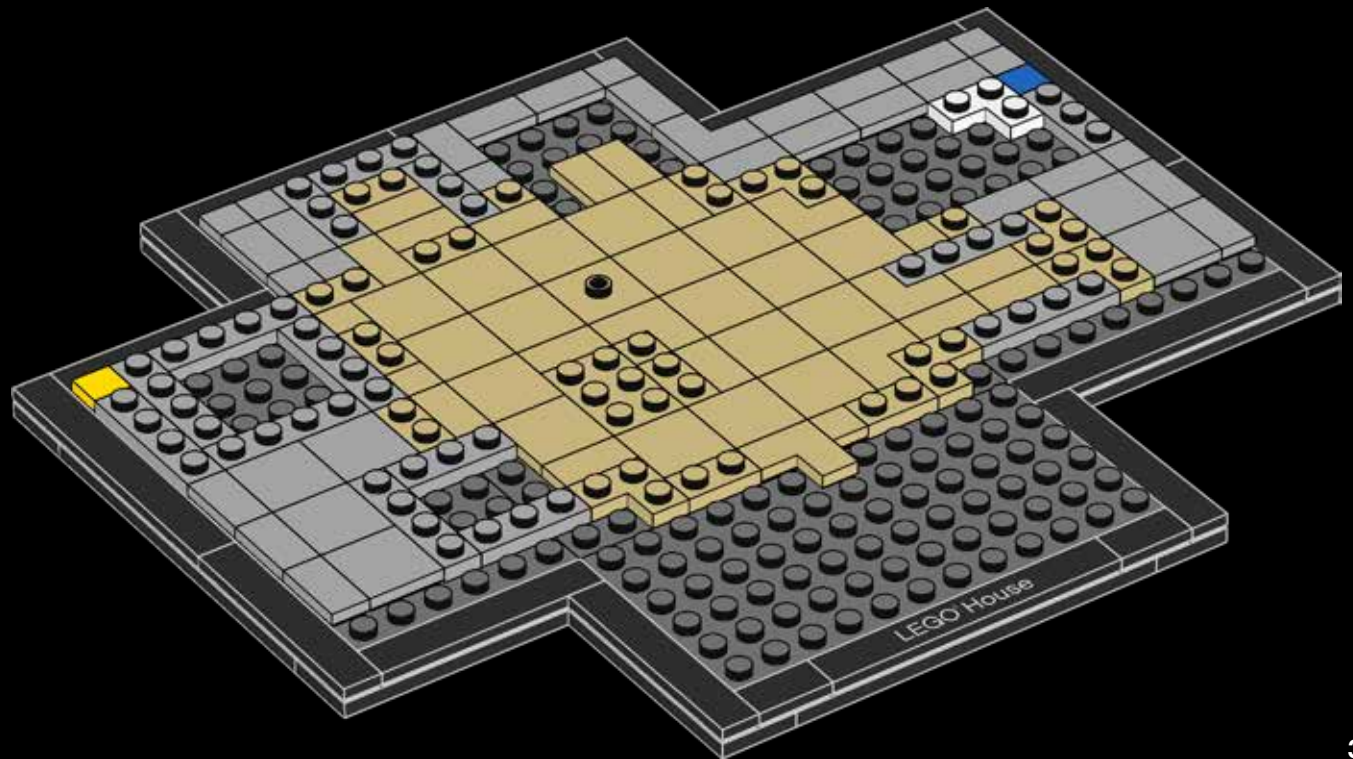



31

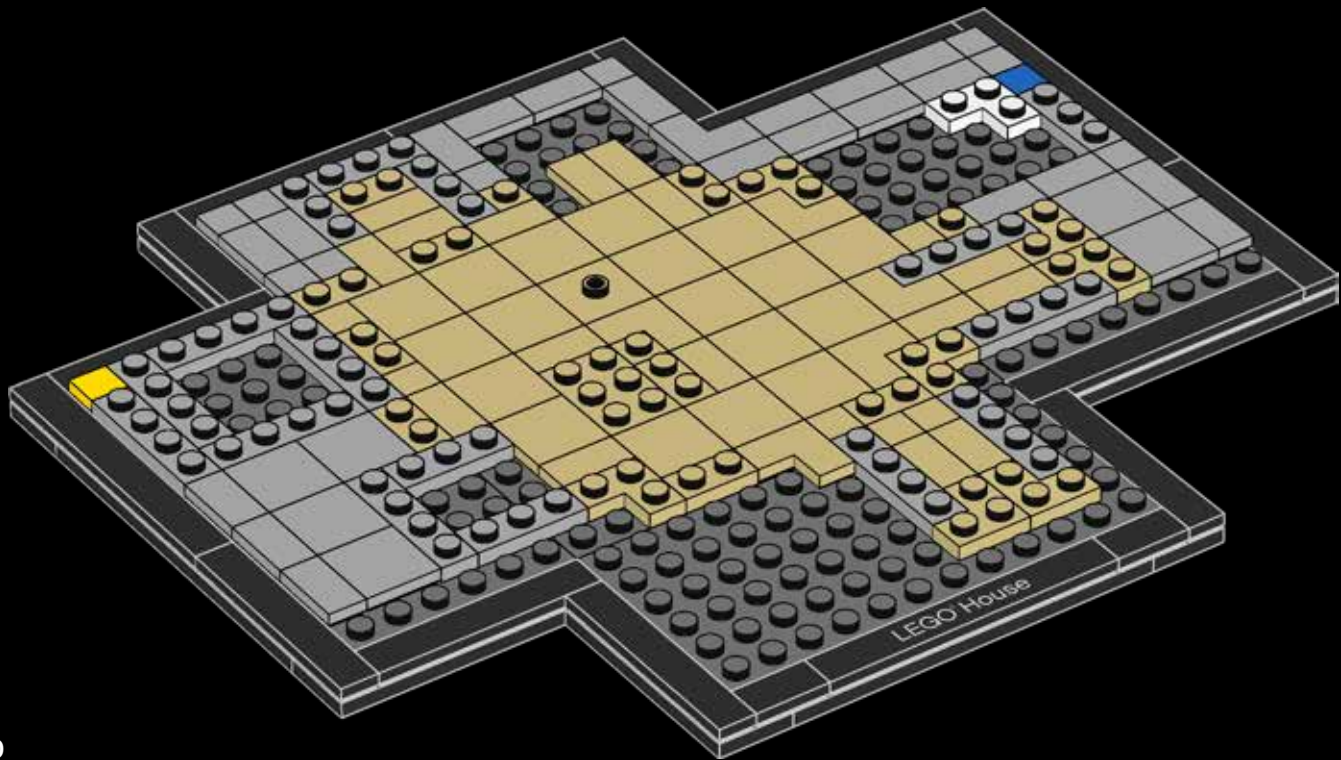



32

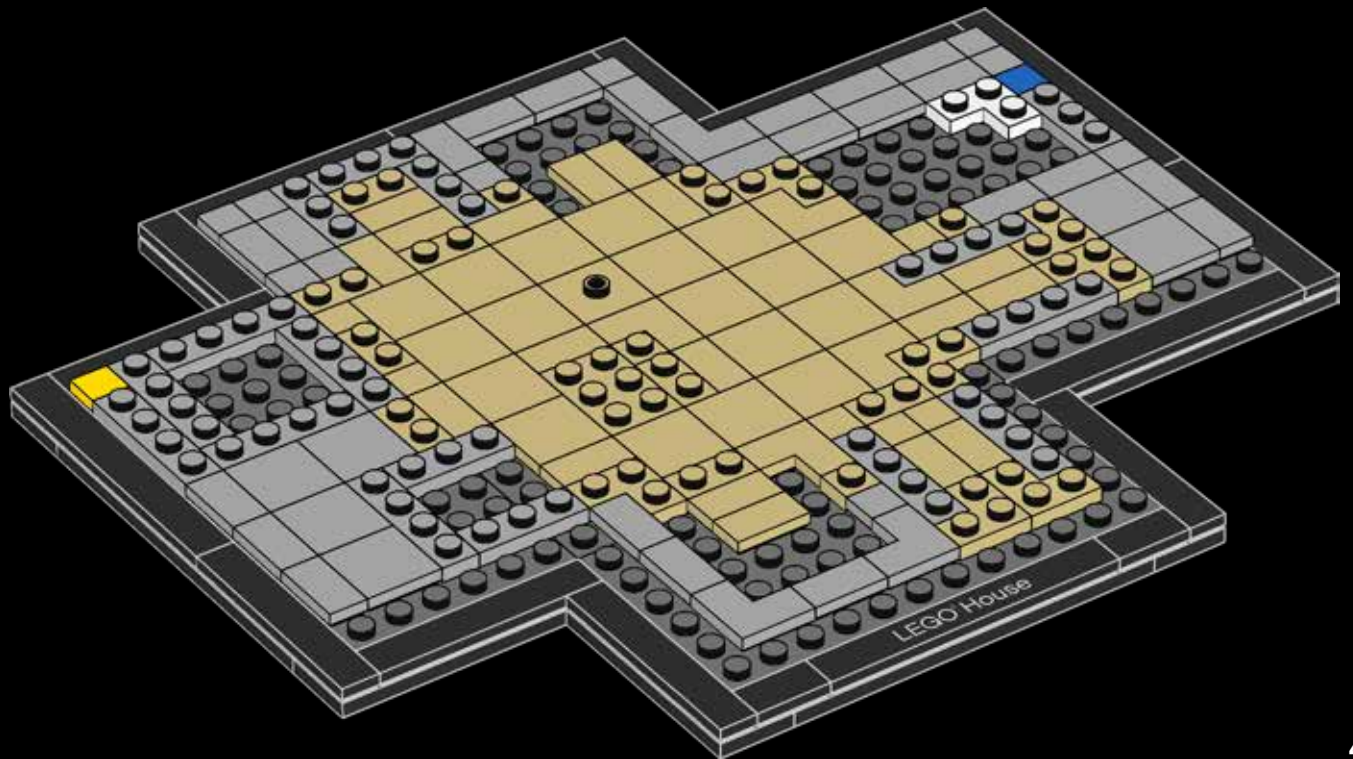

14x 4x 2x

33

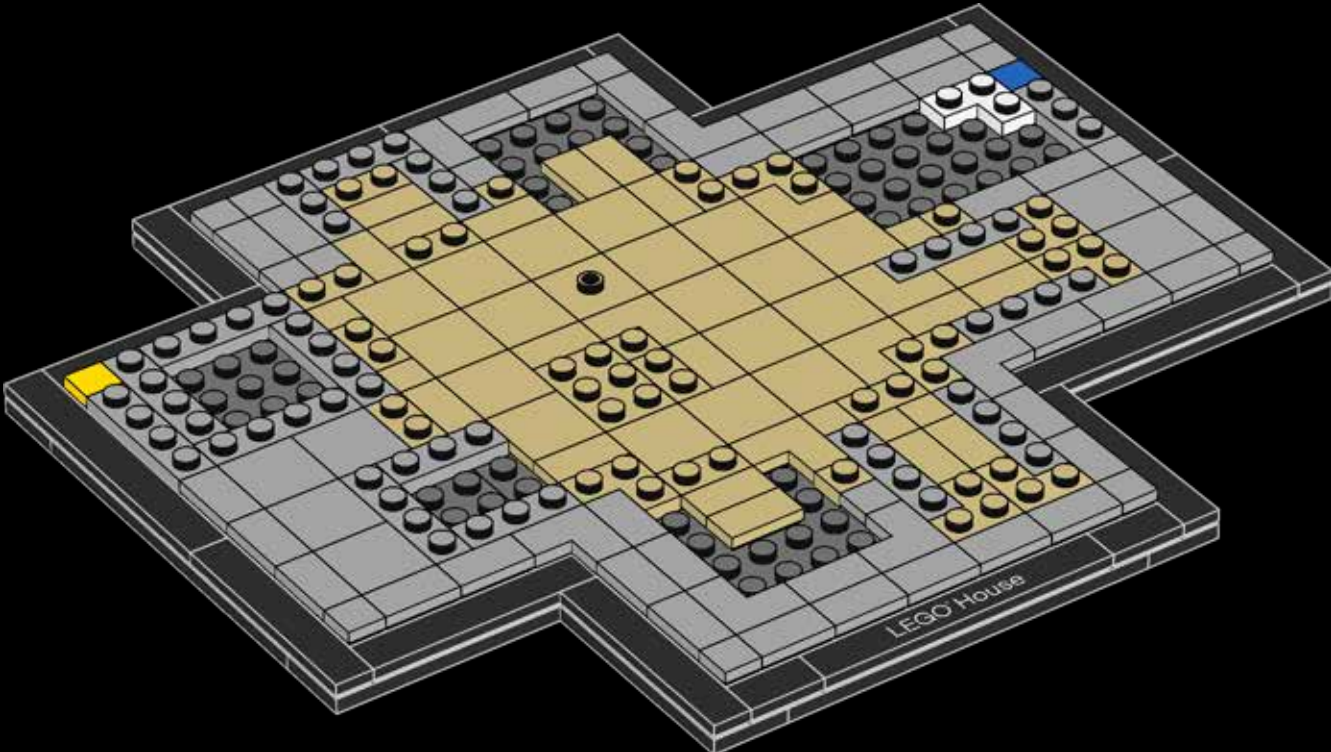

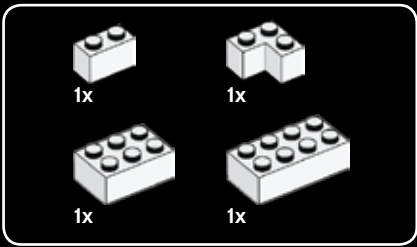

34

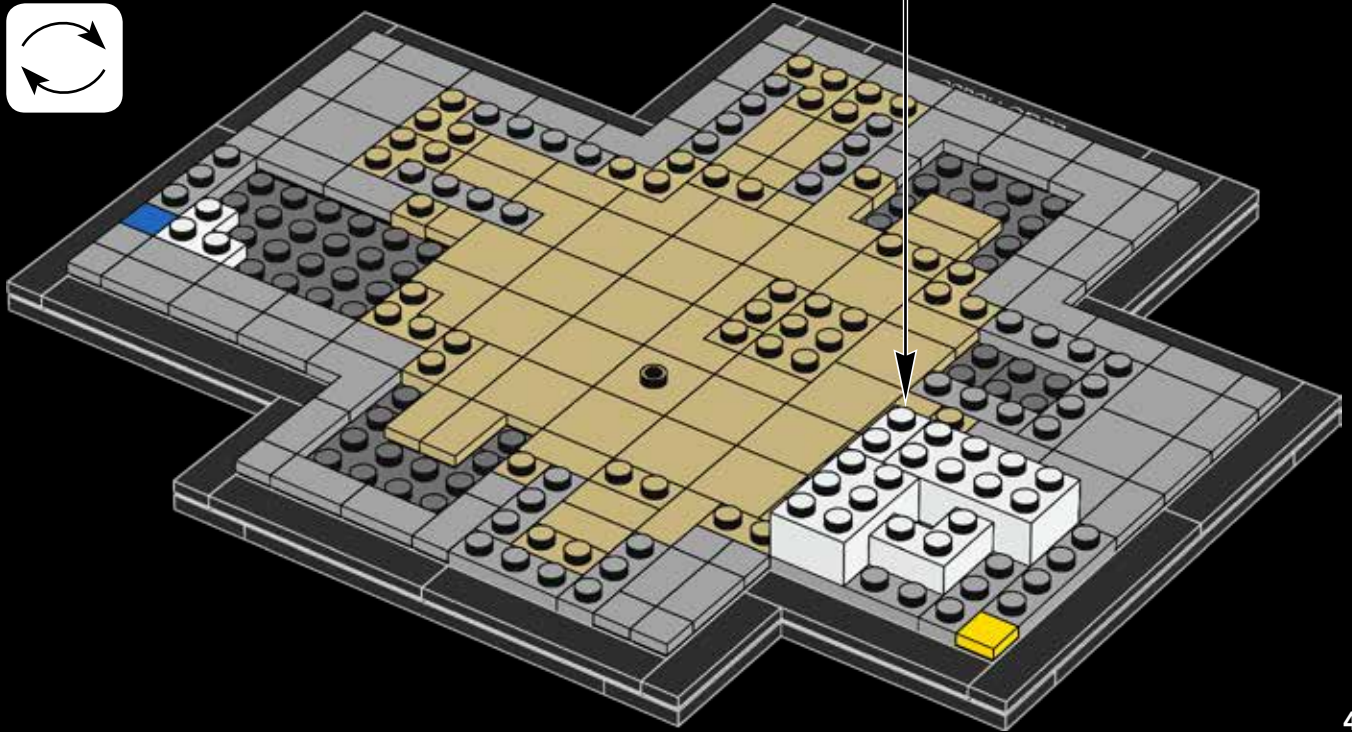



35

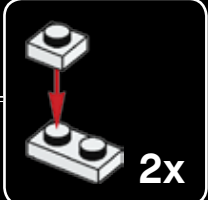
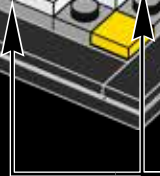
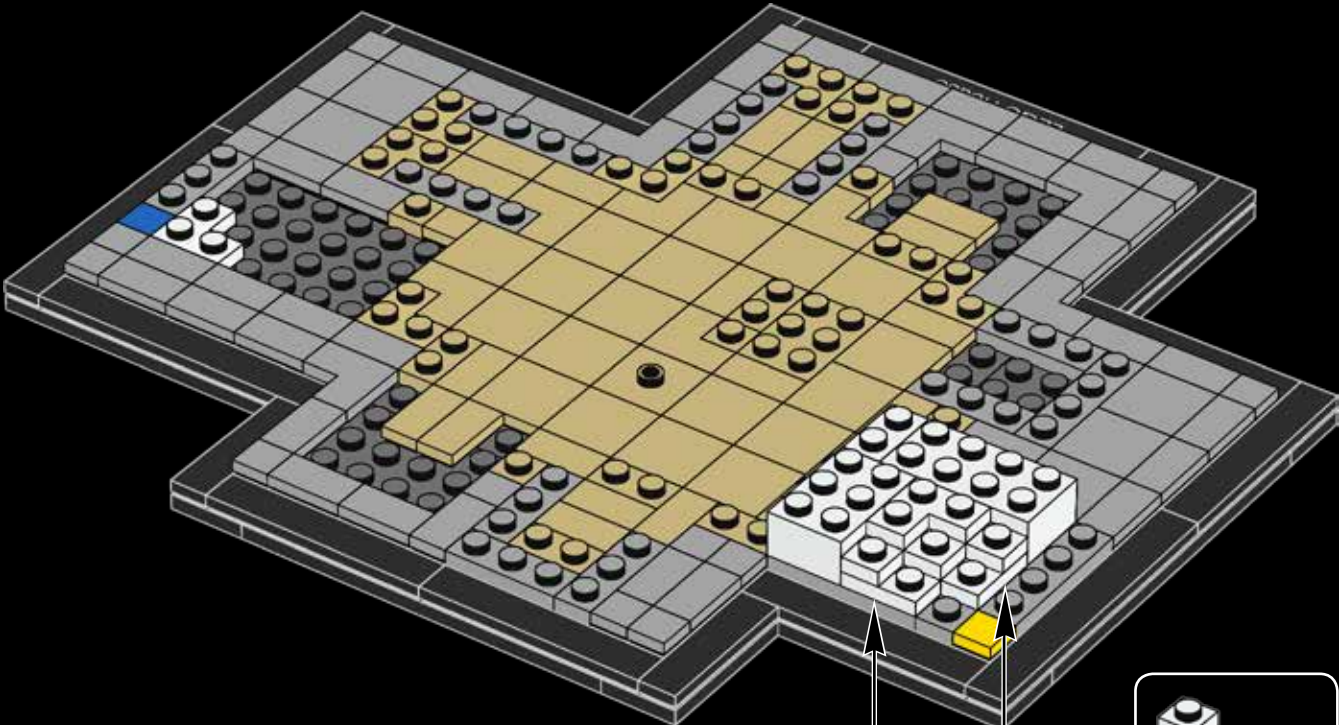



36

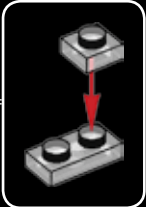
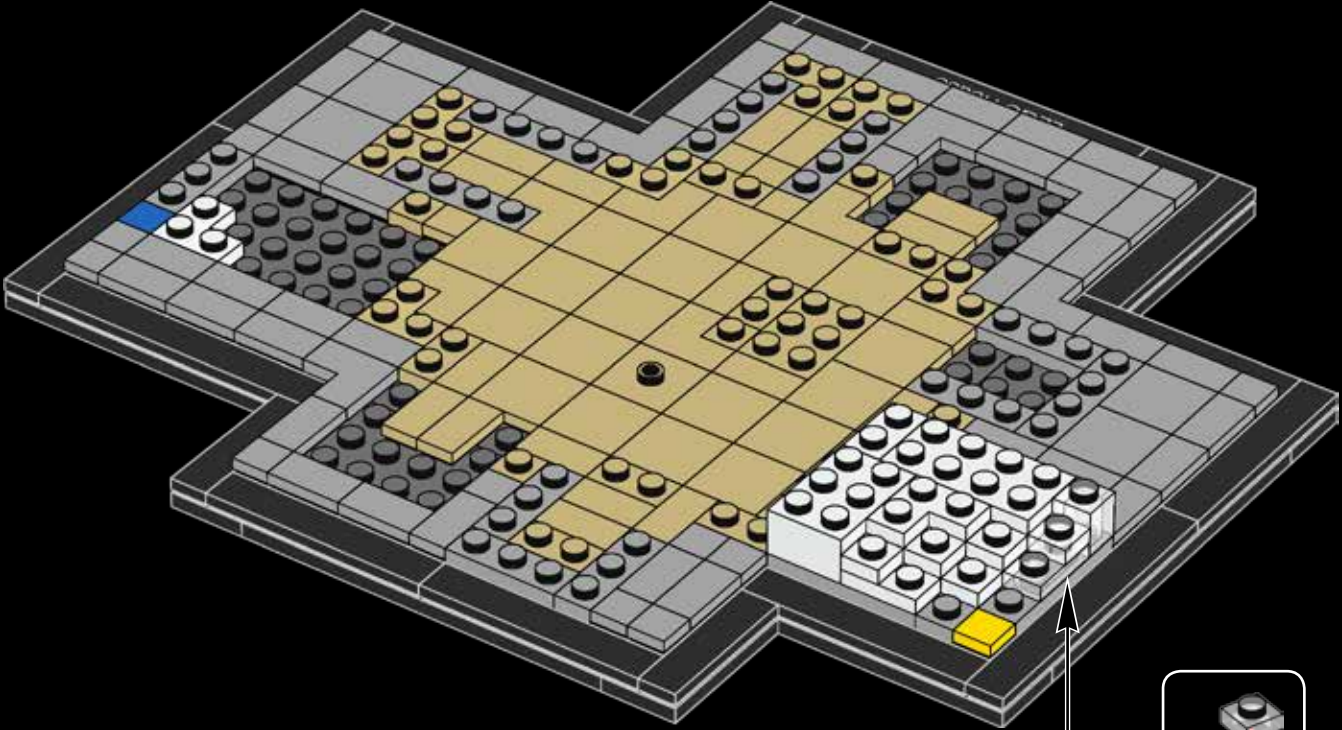



The building is covered with white facing bricks with a size of 7 x 23.5 in. (18 x 60 cm), giving the illusion that the building is made of LEGO® bricks.



37

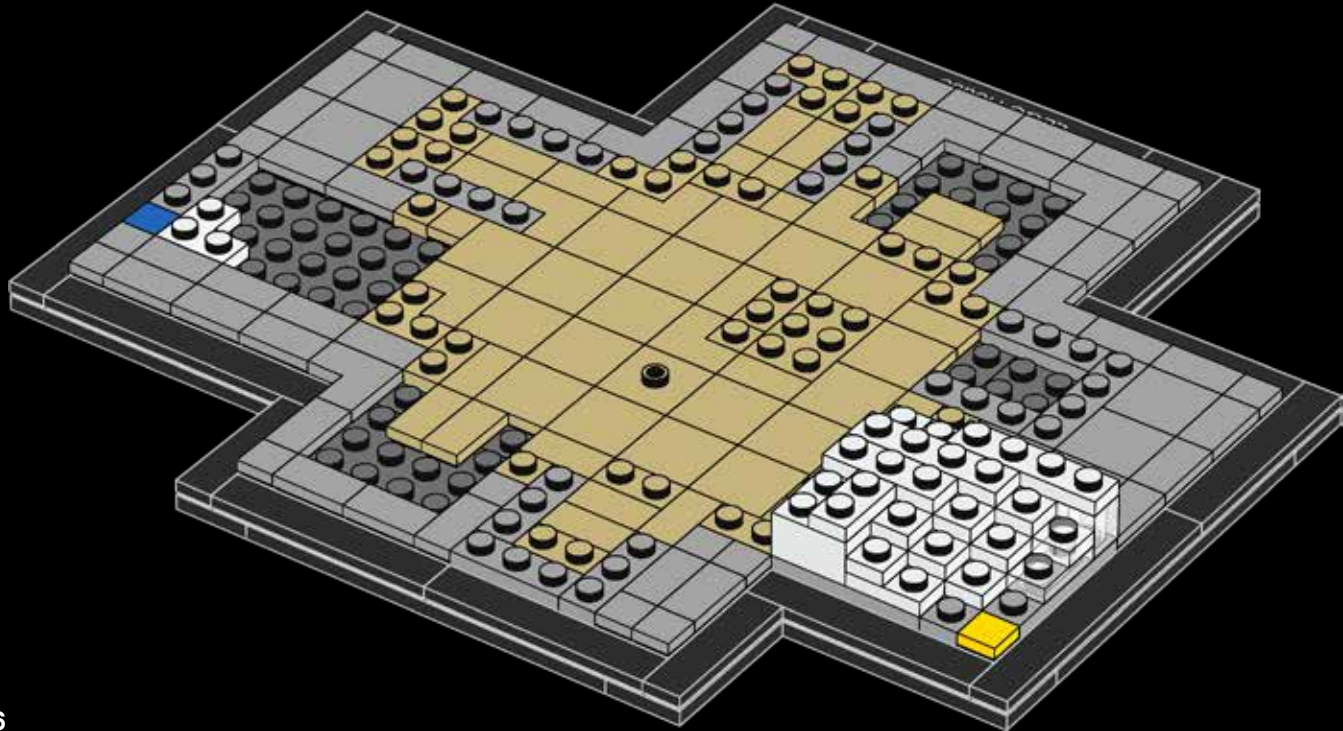



38

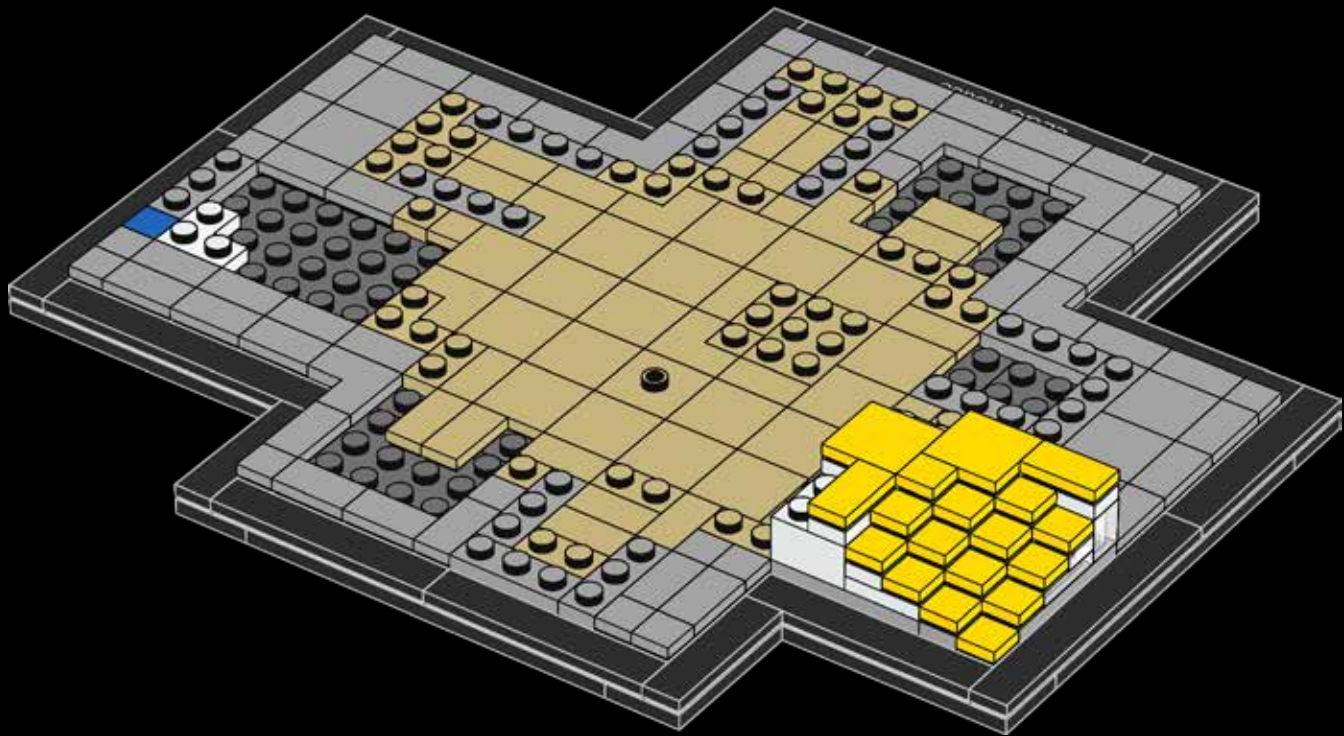



39

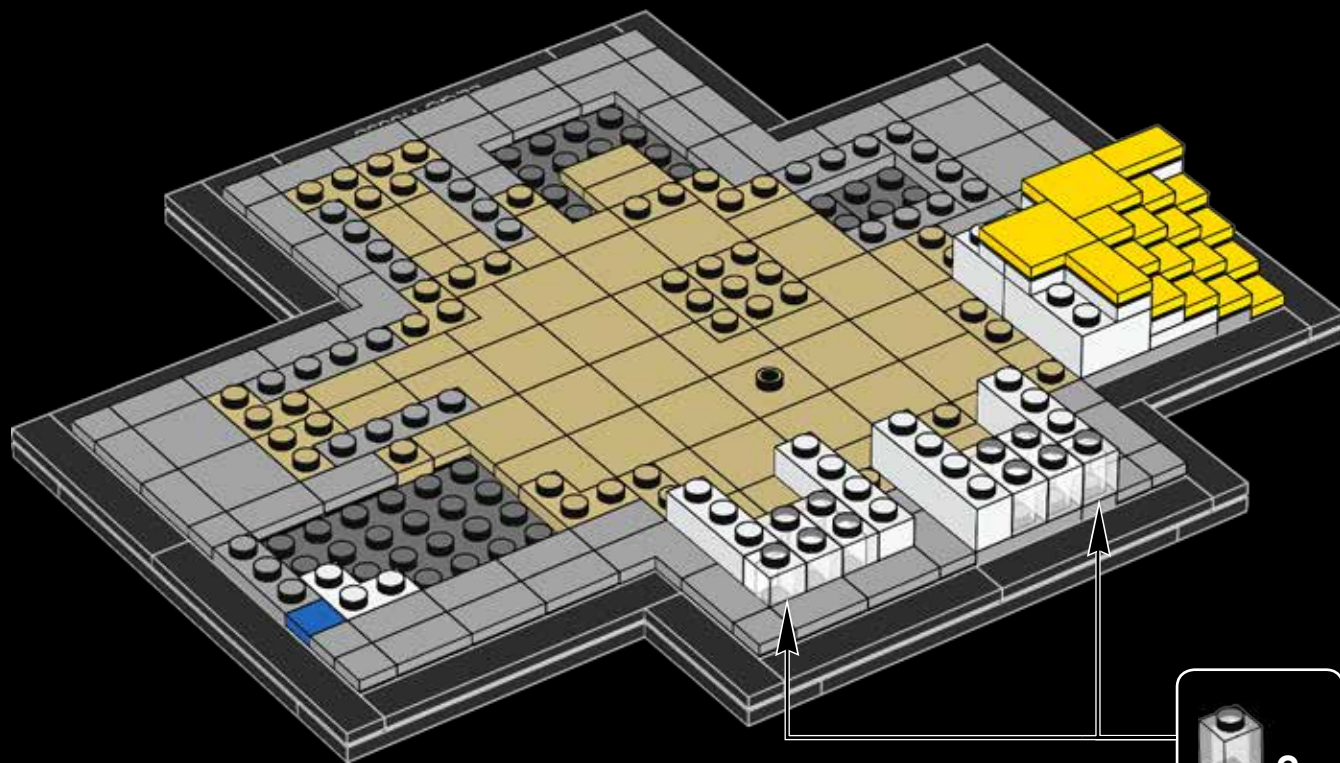



40

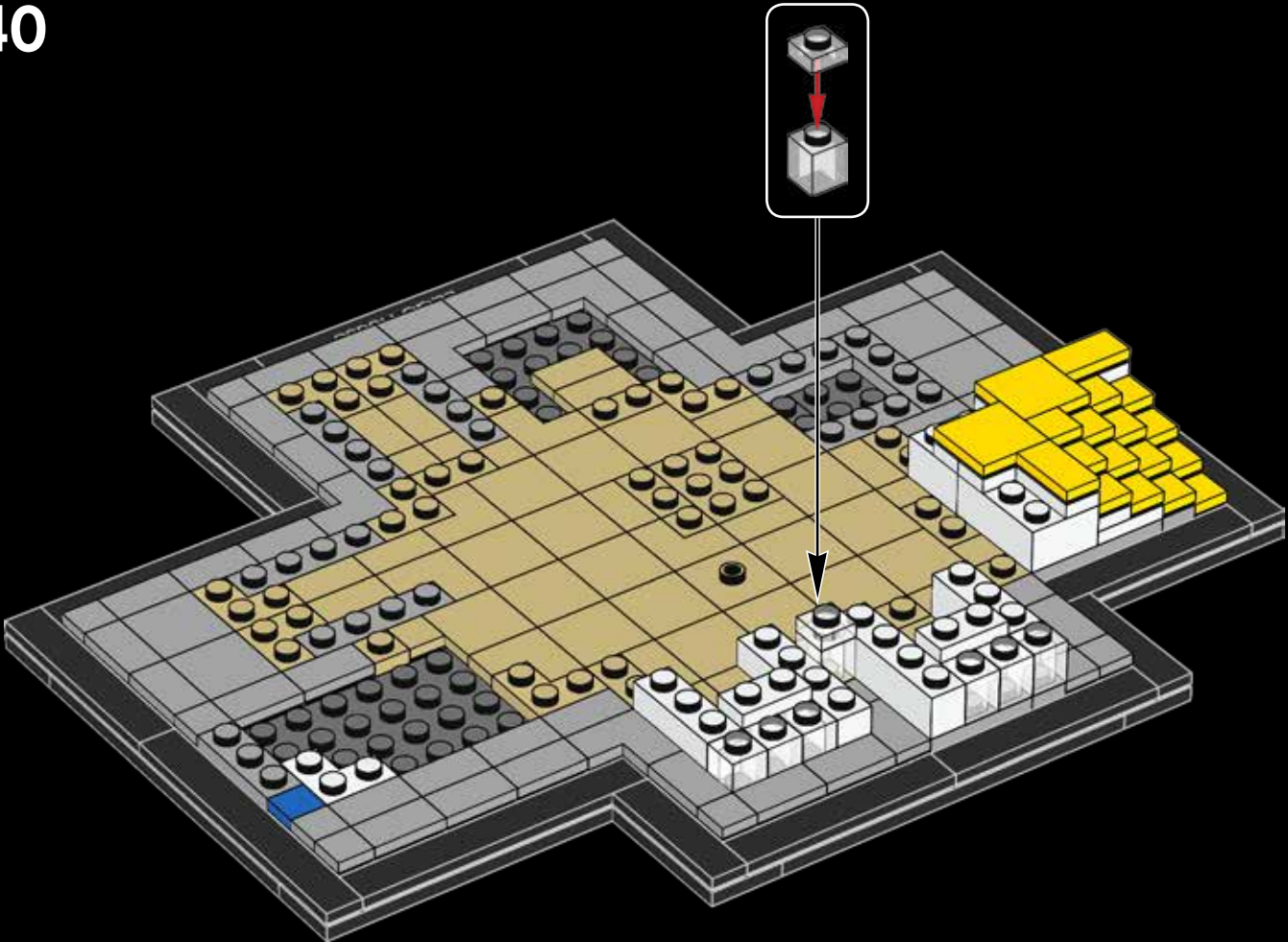



41

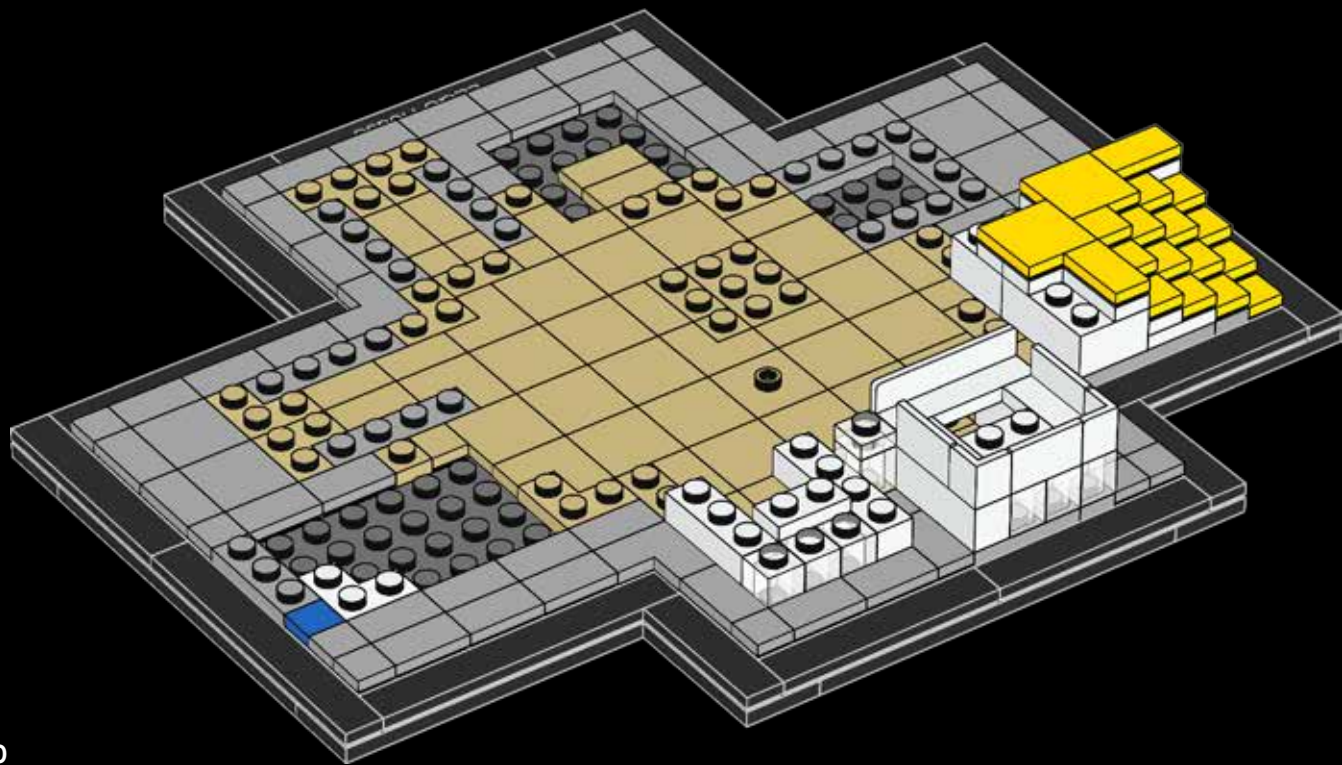



42

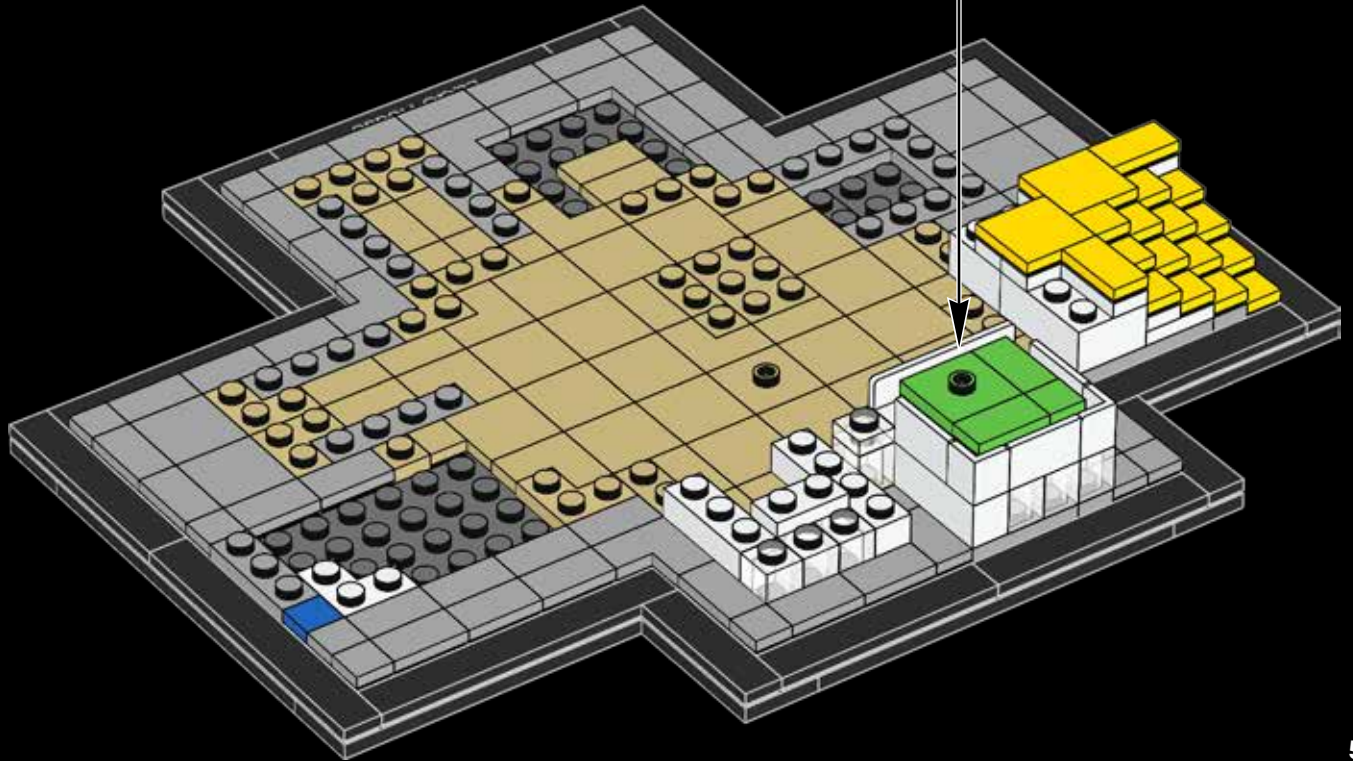
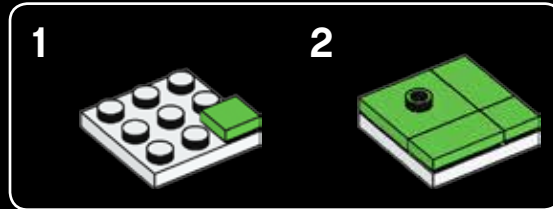



43

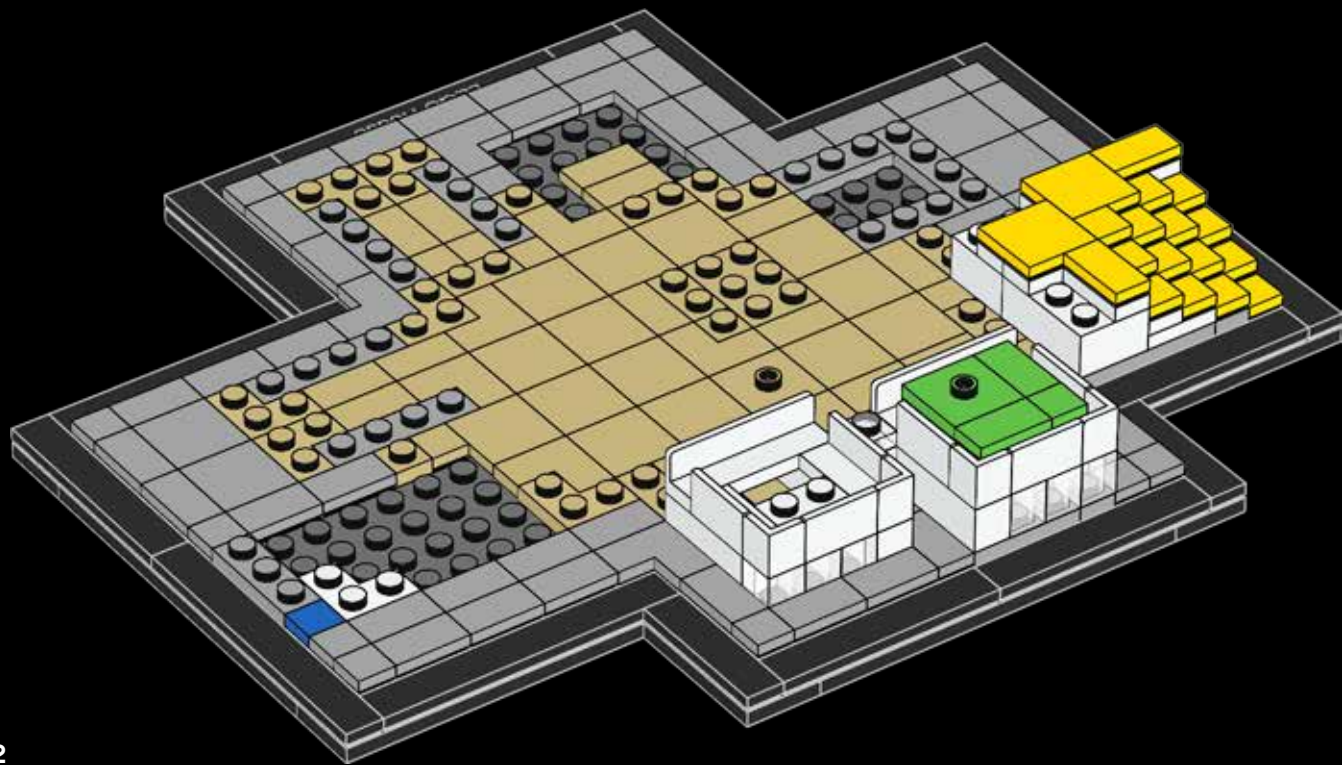

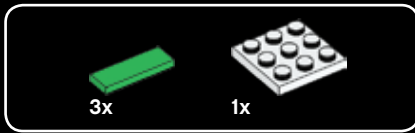

44

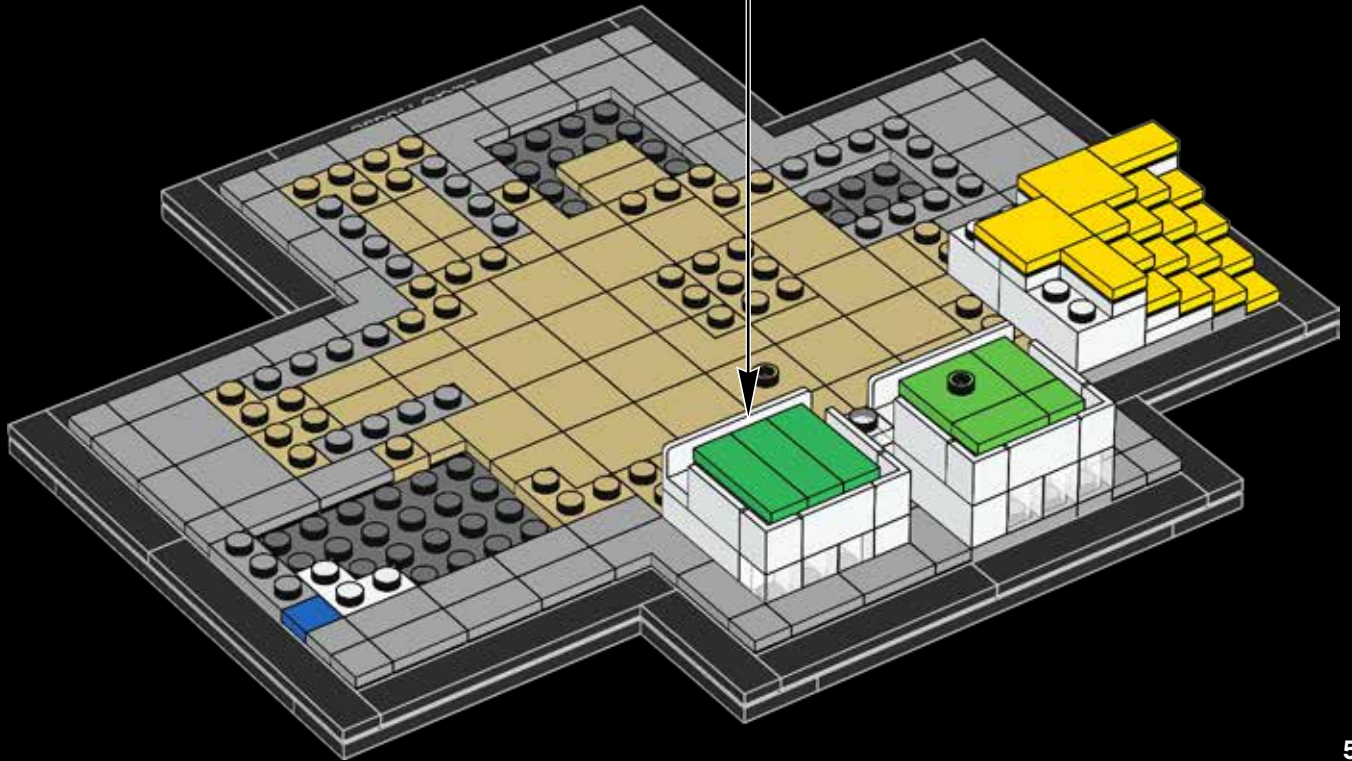
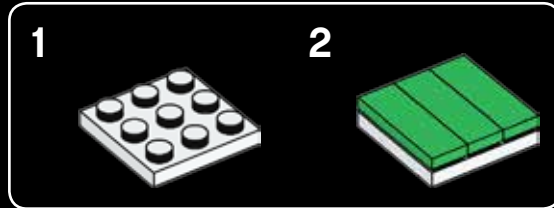





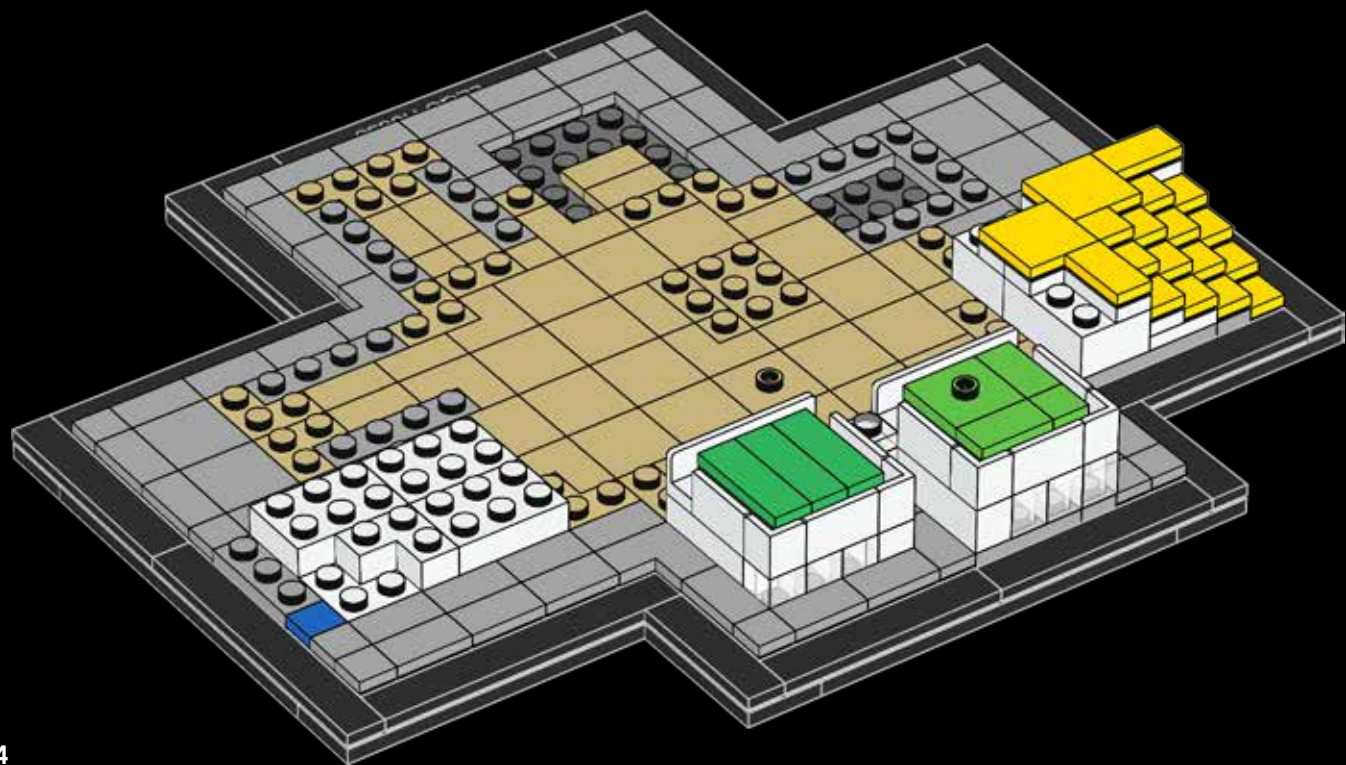

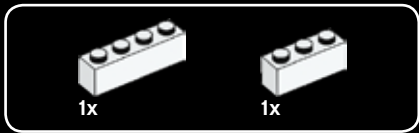
45



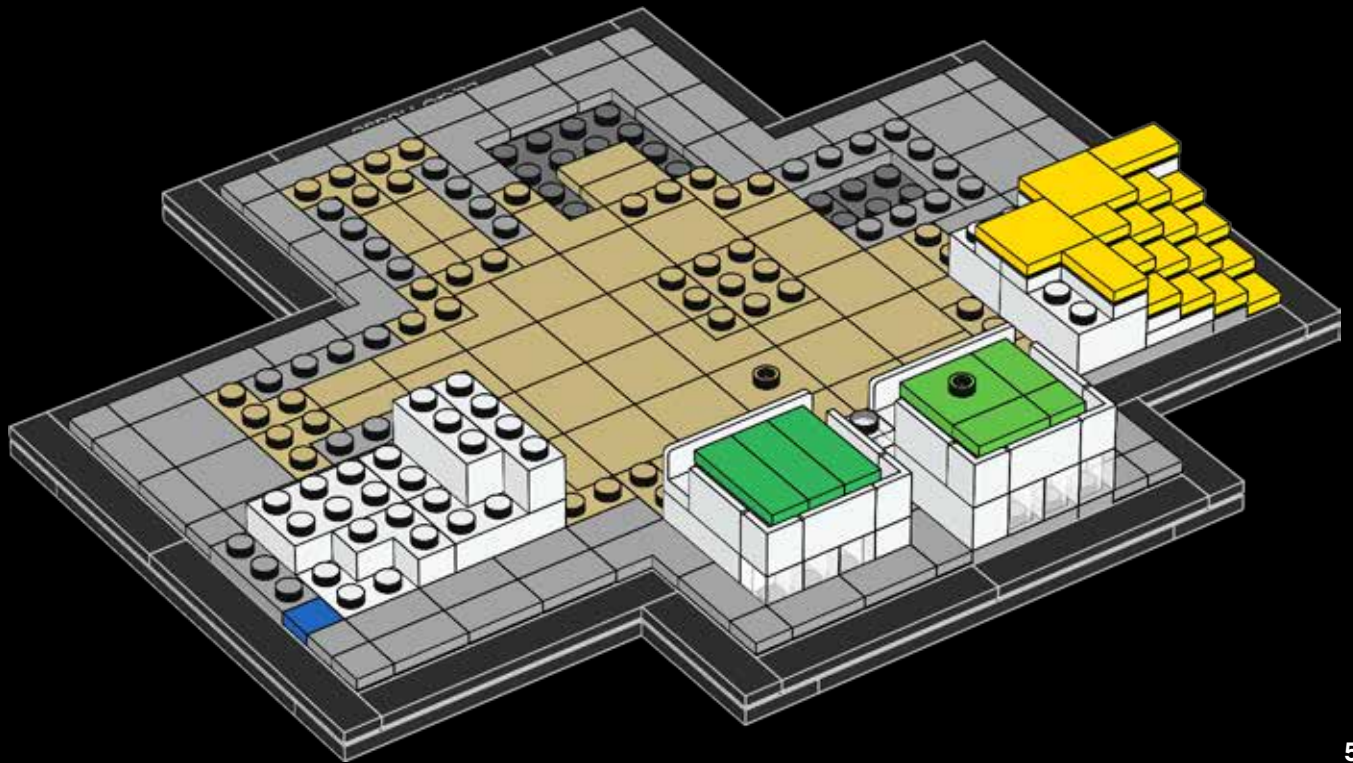

46



- 2x 
- 1x 
- 1x 

47

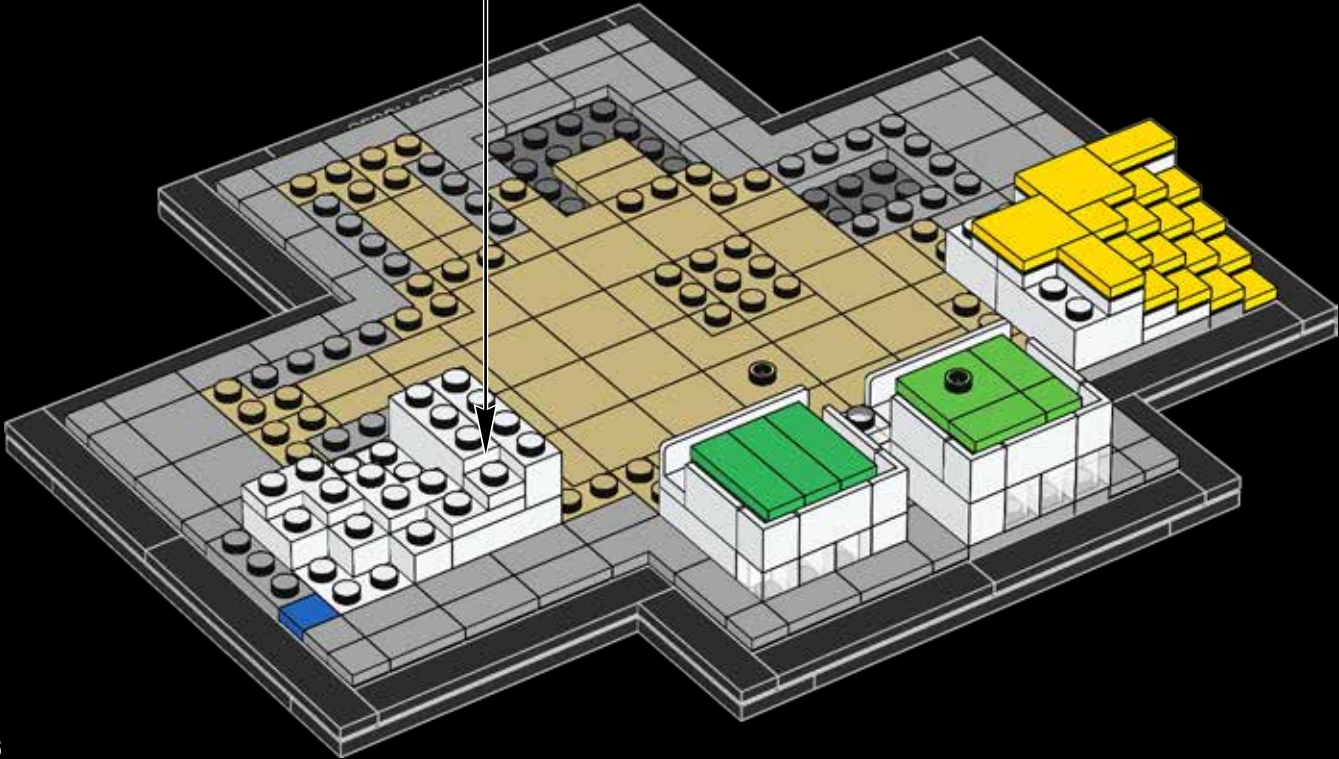
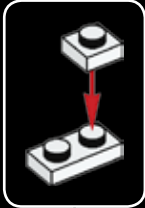

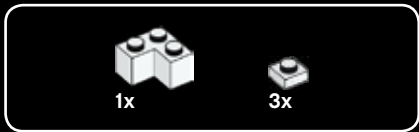

48

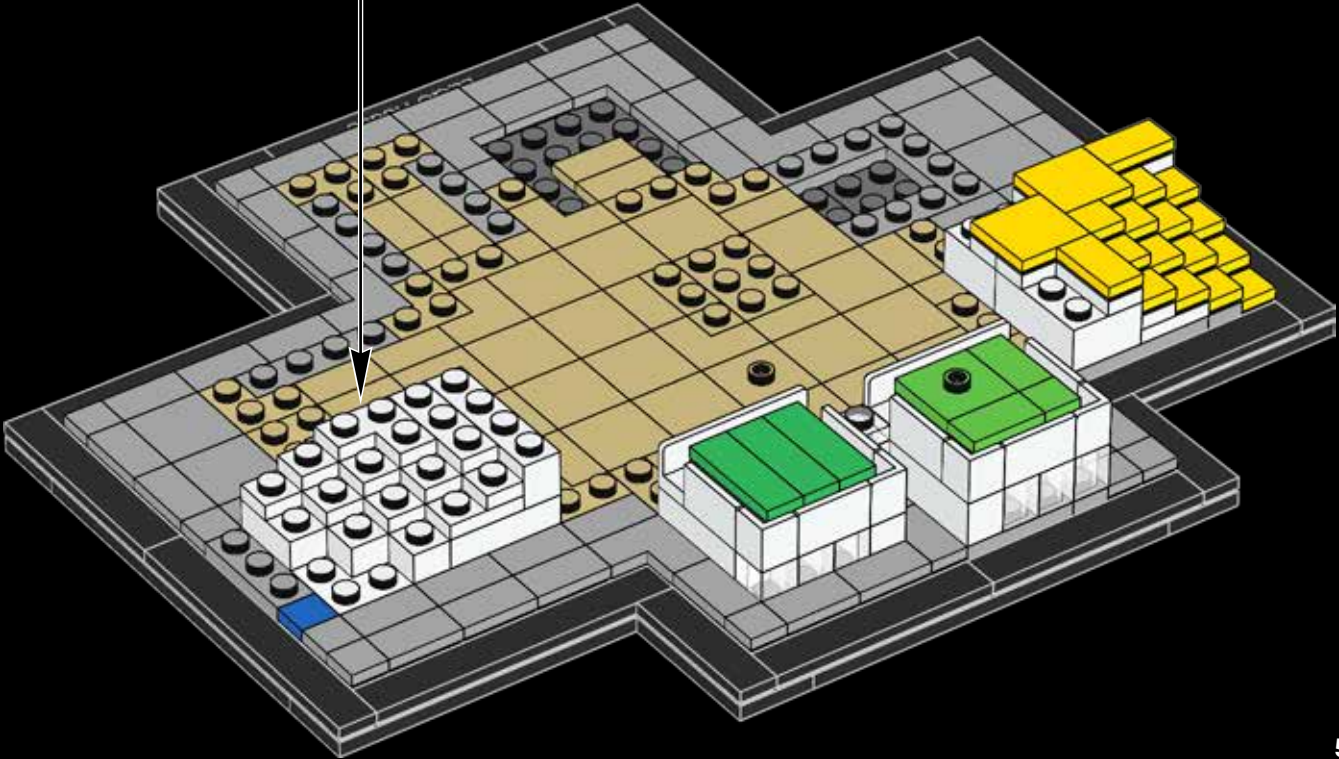

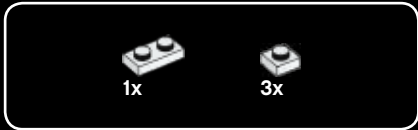

49

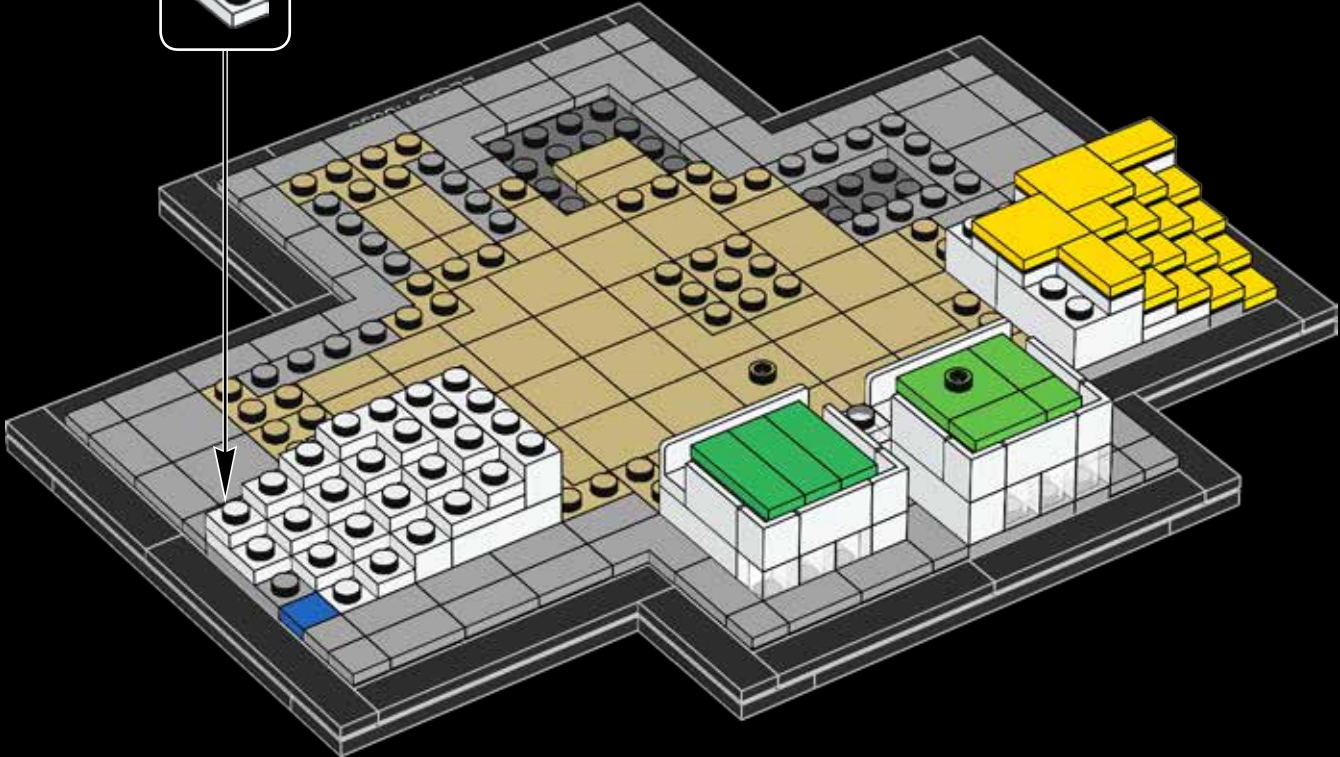
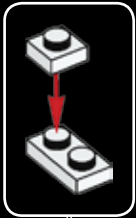

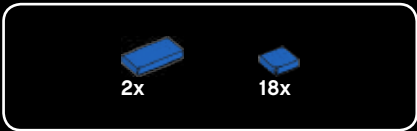

50

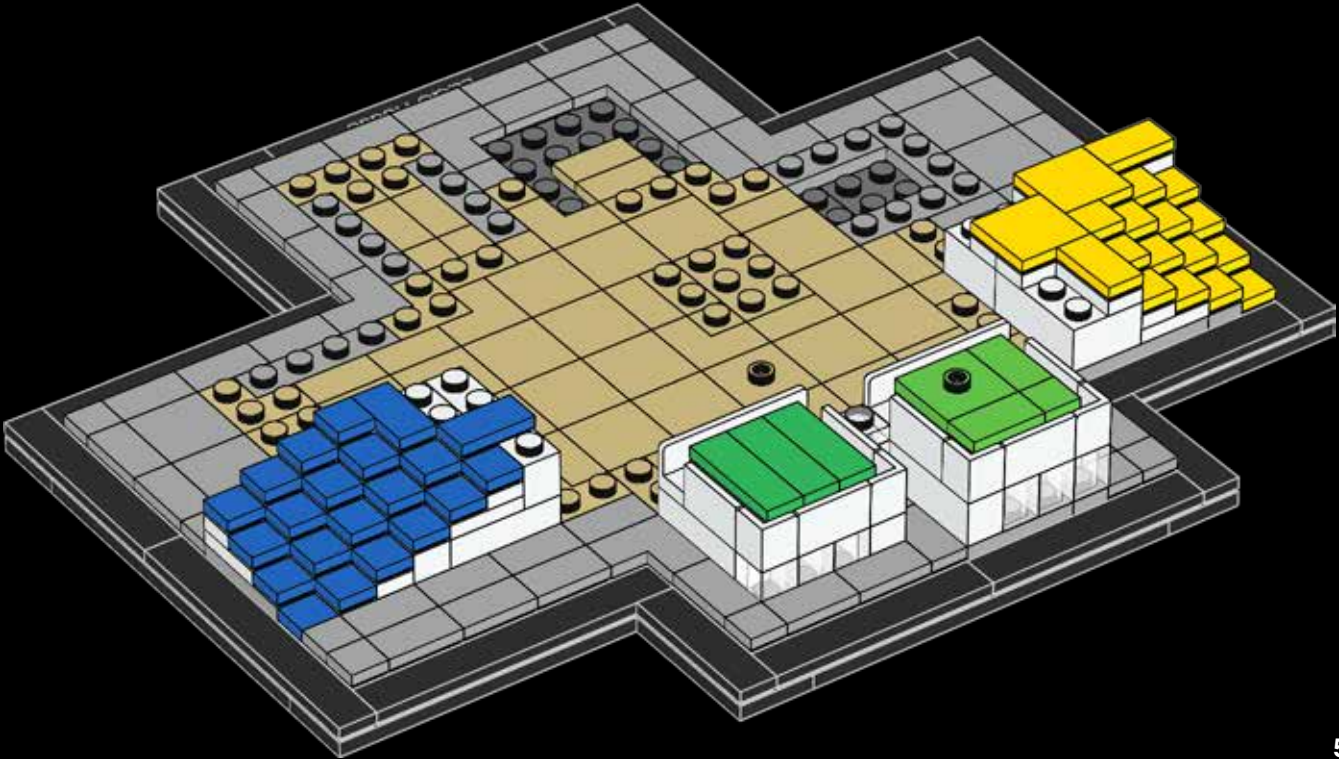



51

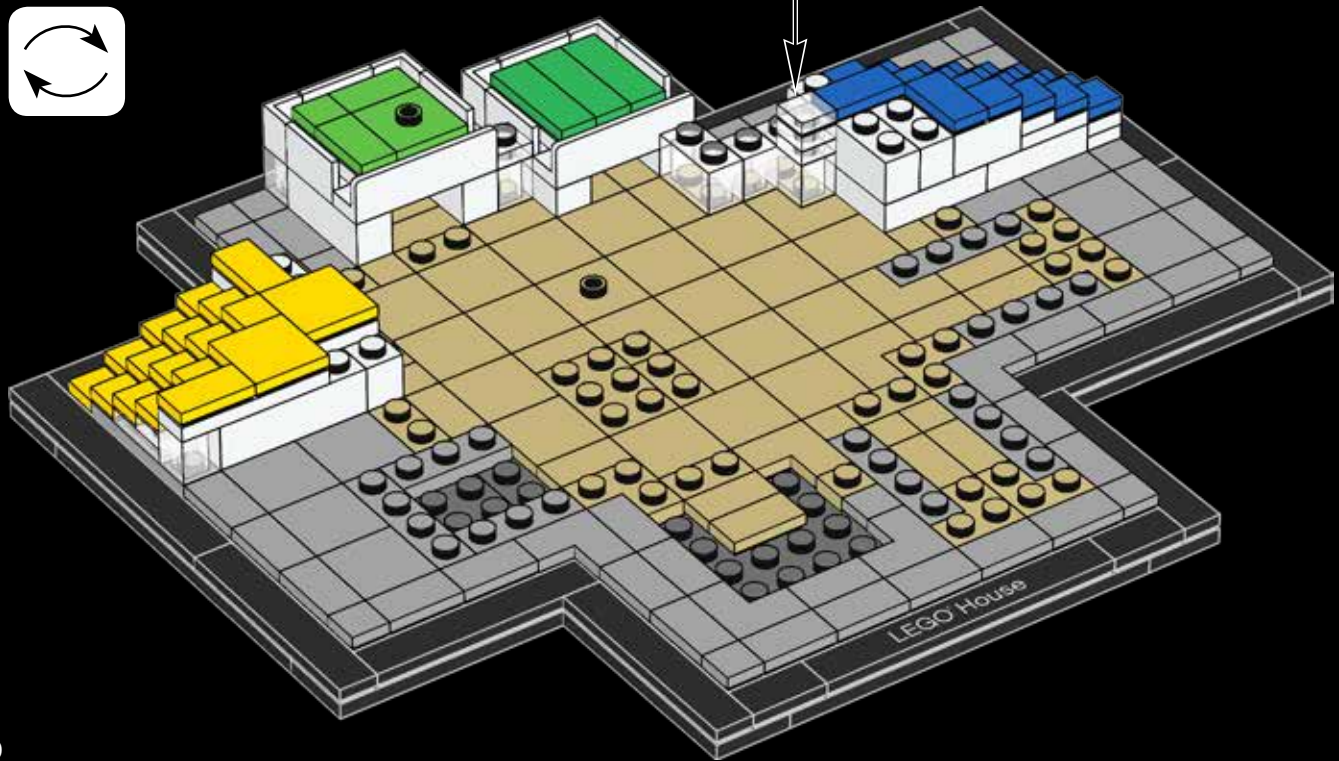
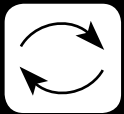
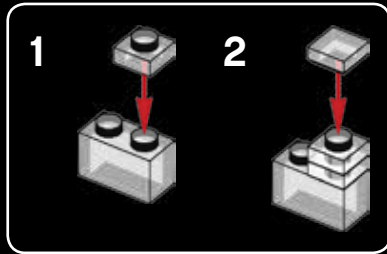



52

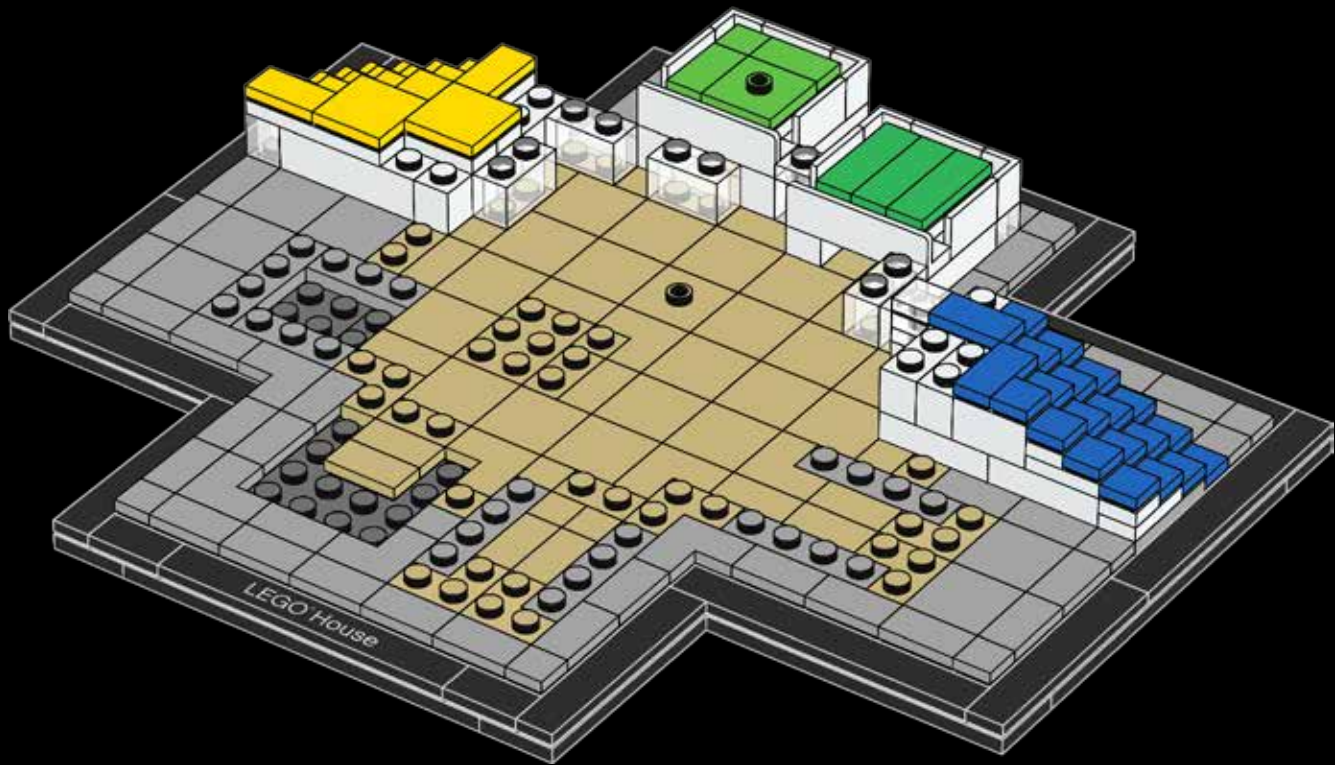

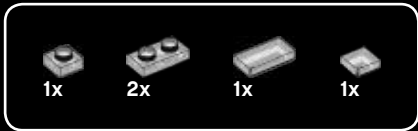

53

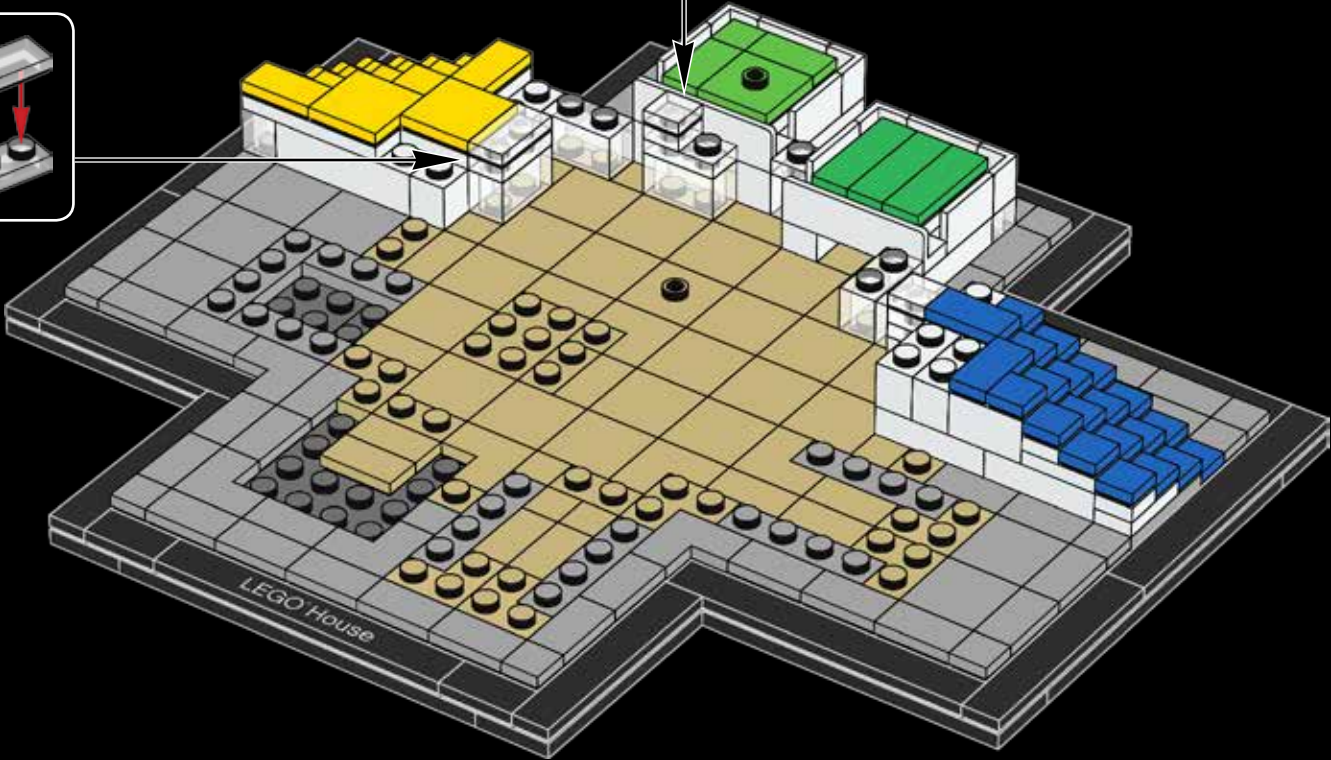
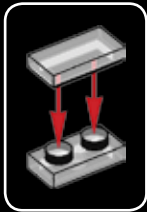
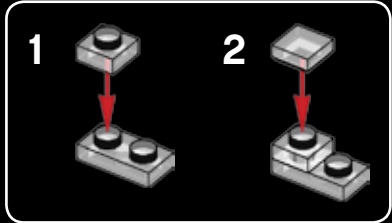



54

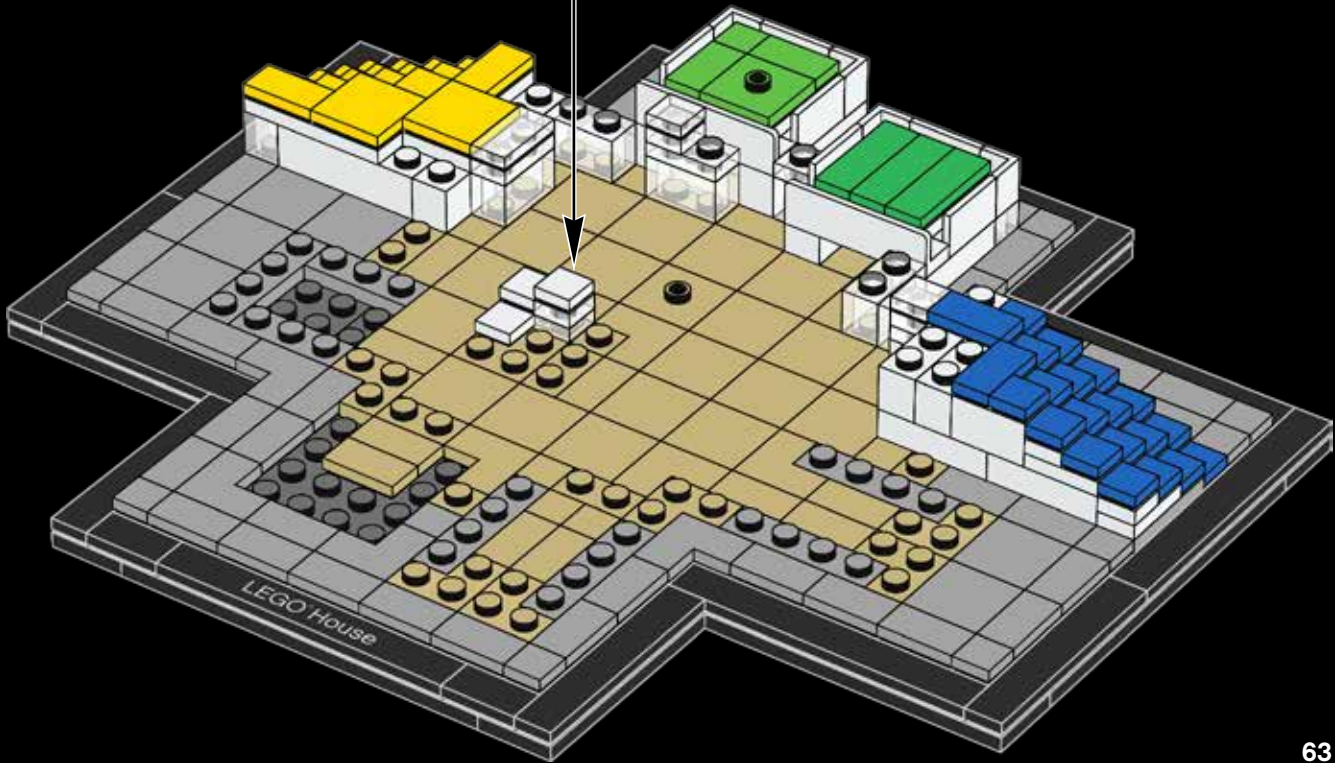
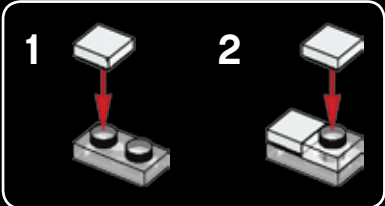



55

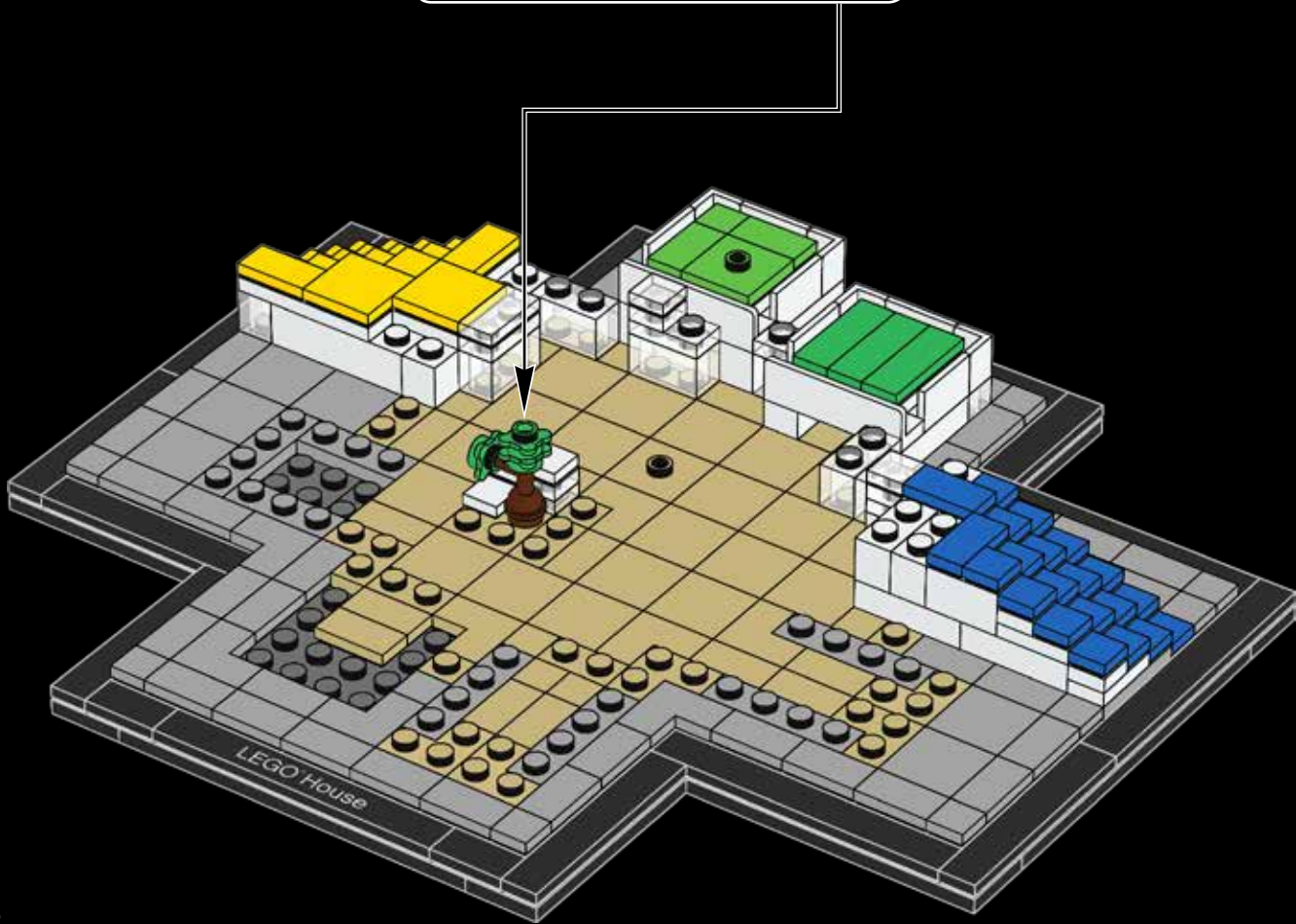
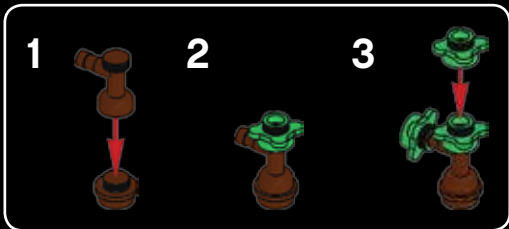



56

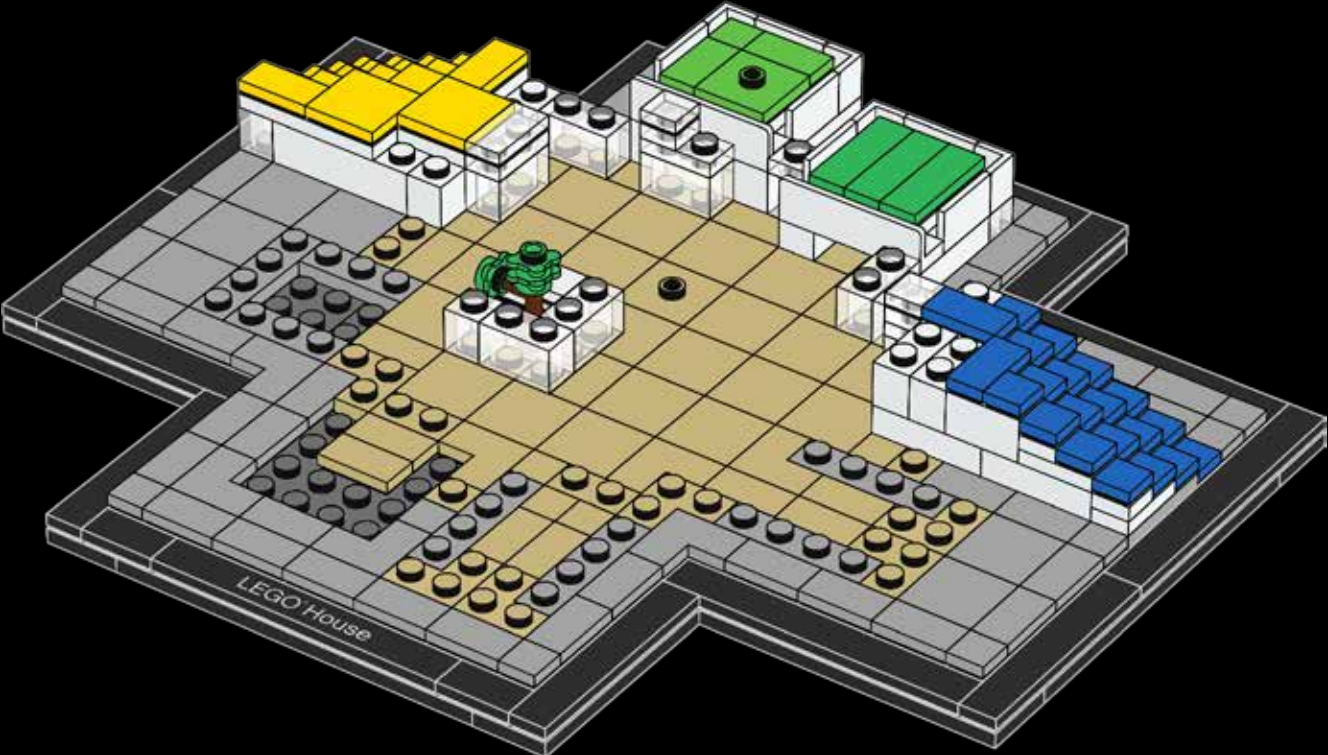

1x 1x 2x

57

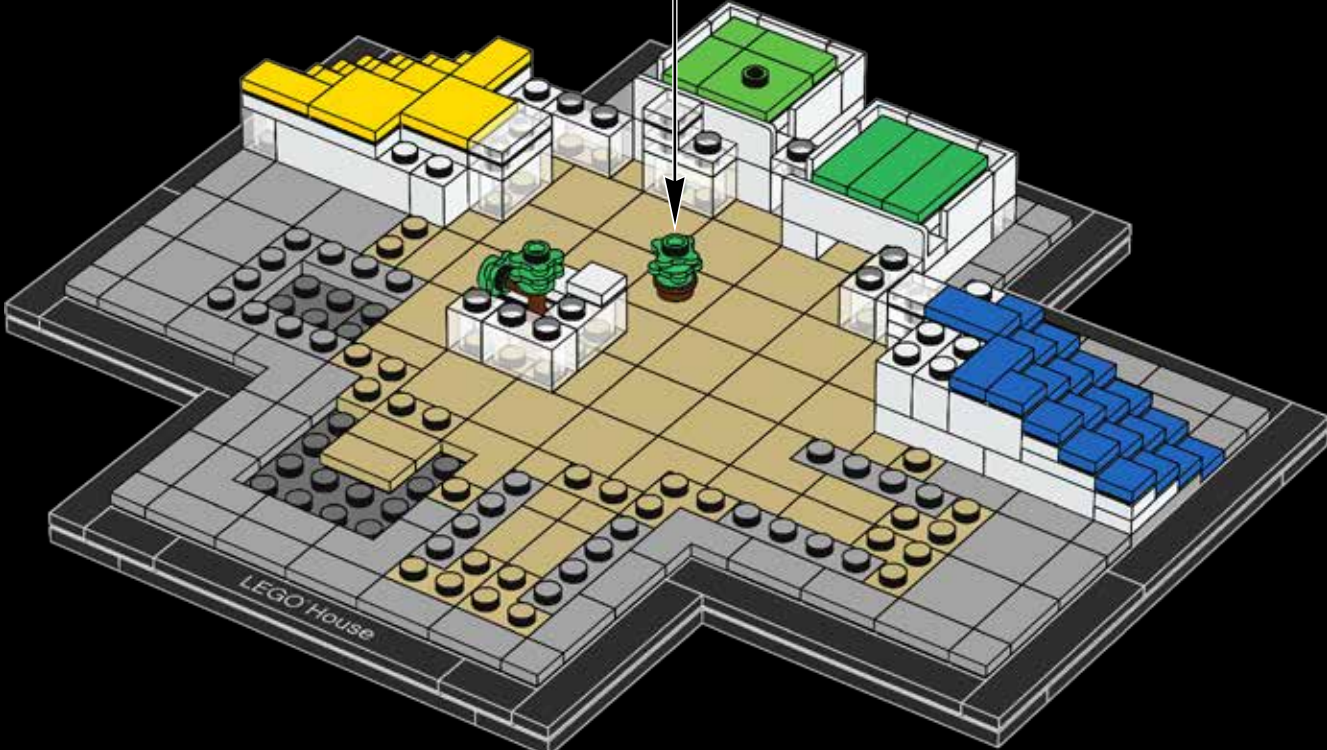



58

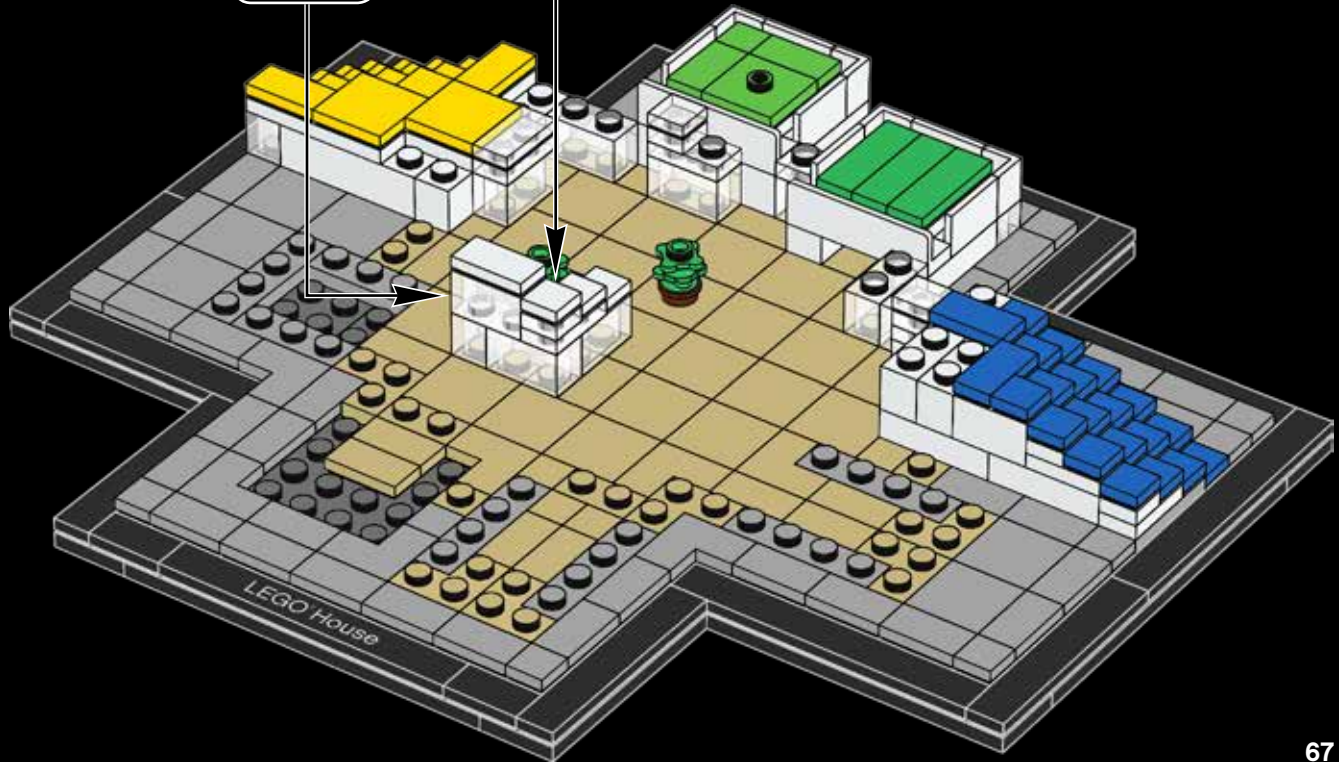
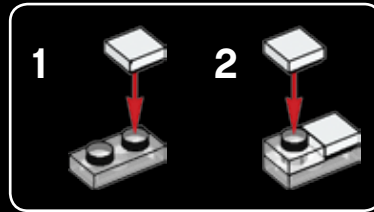
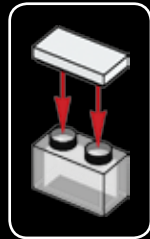

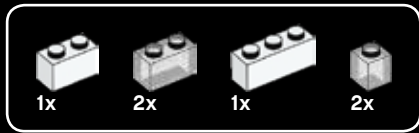

59

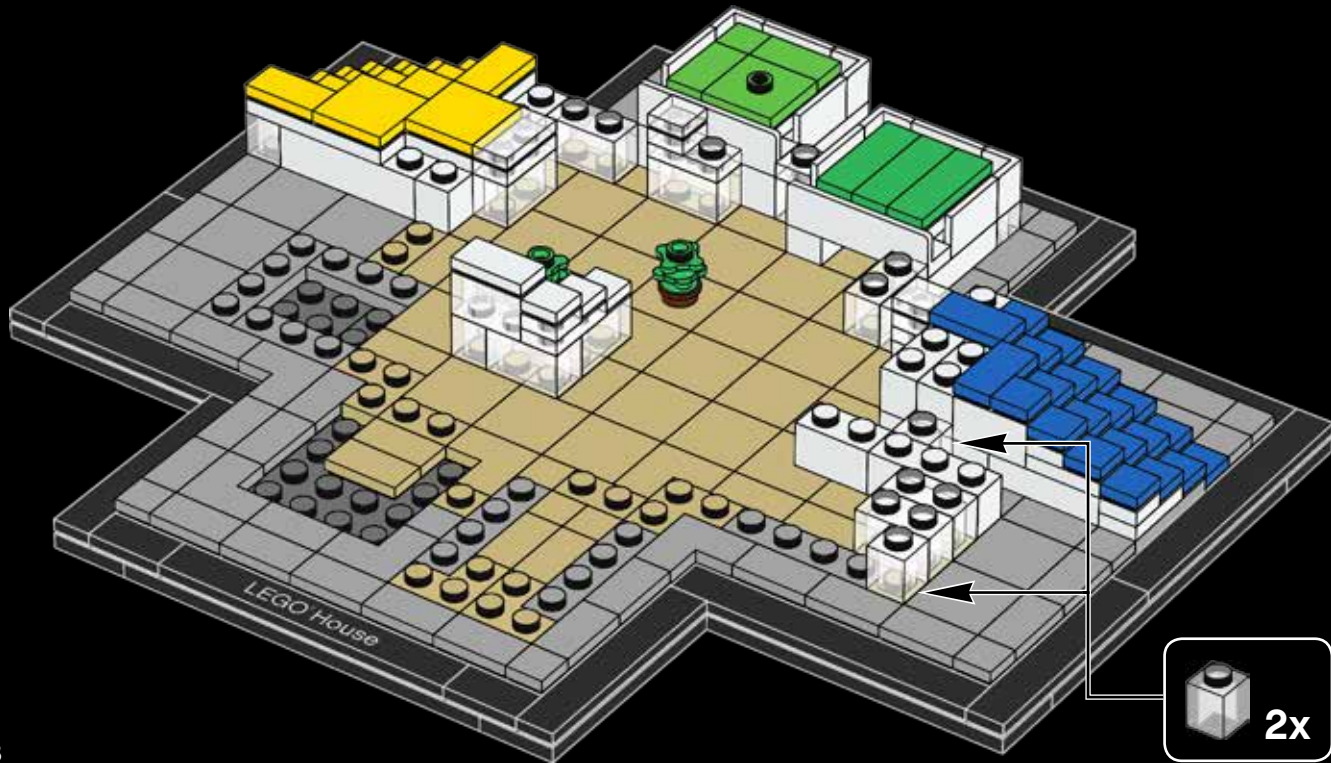



60

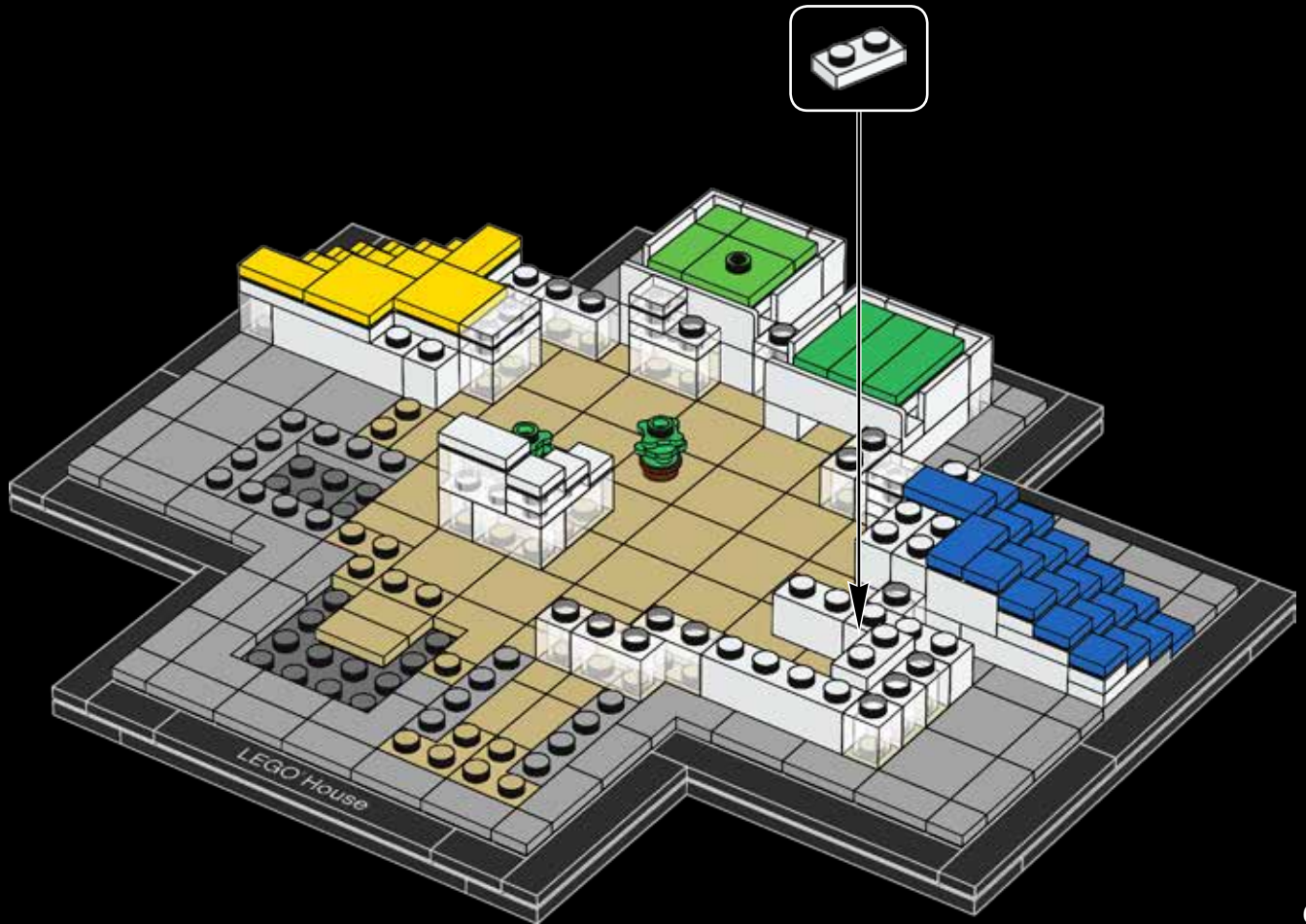

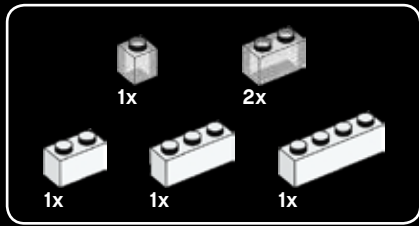

61

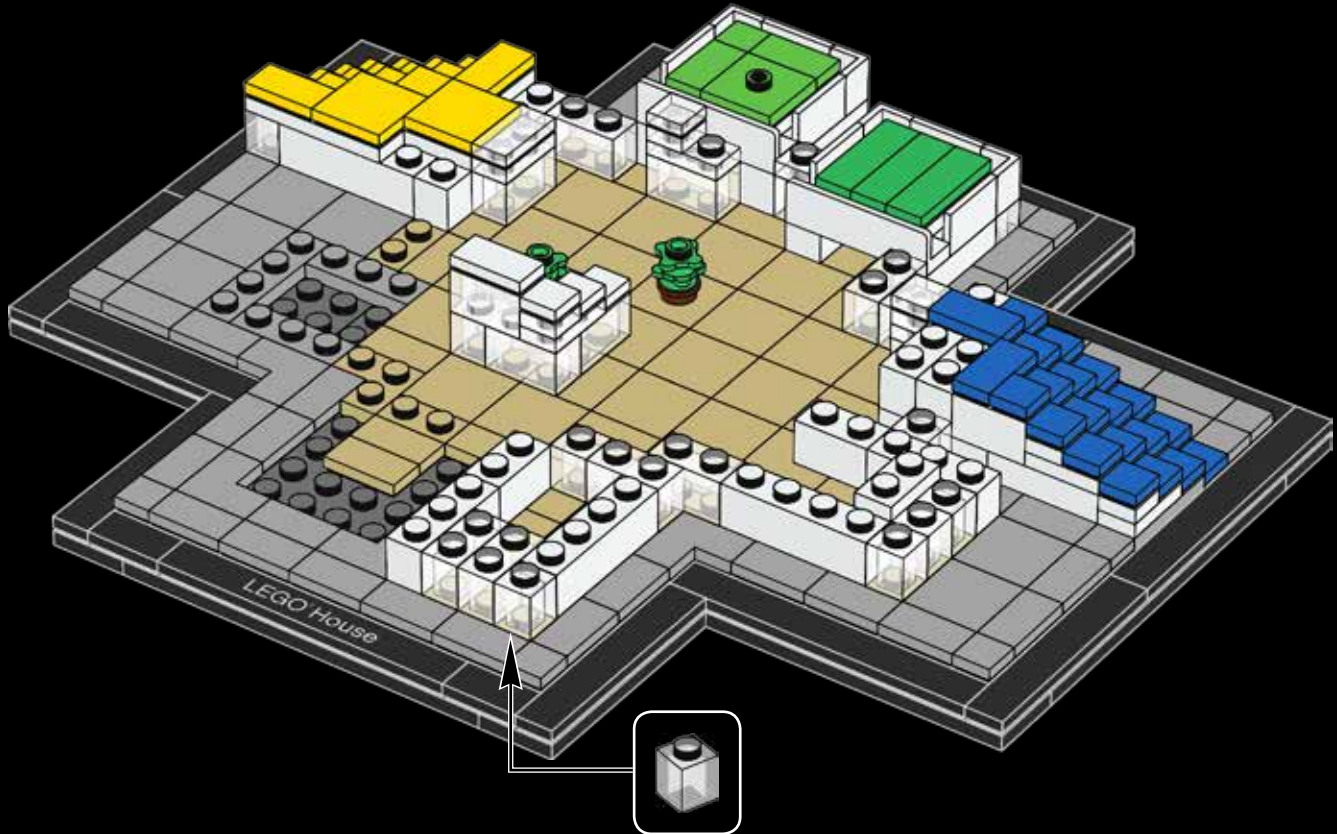



62

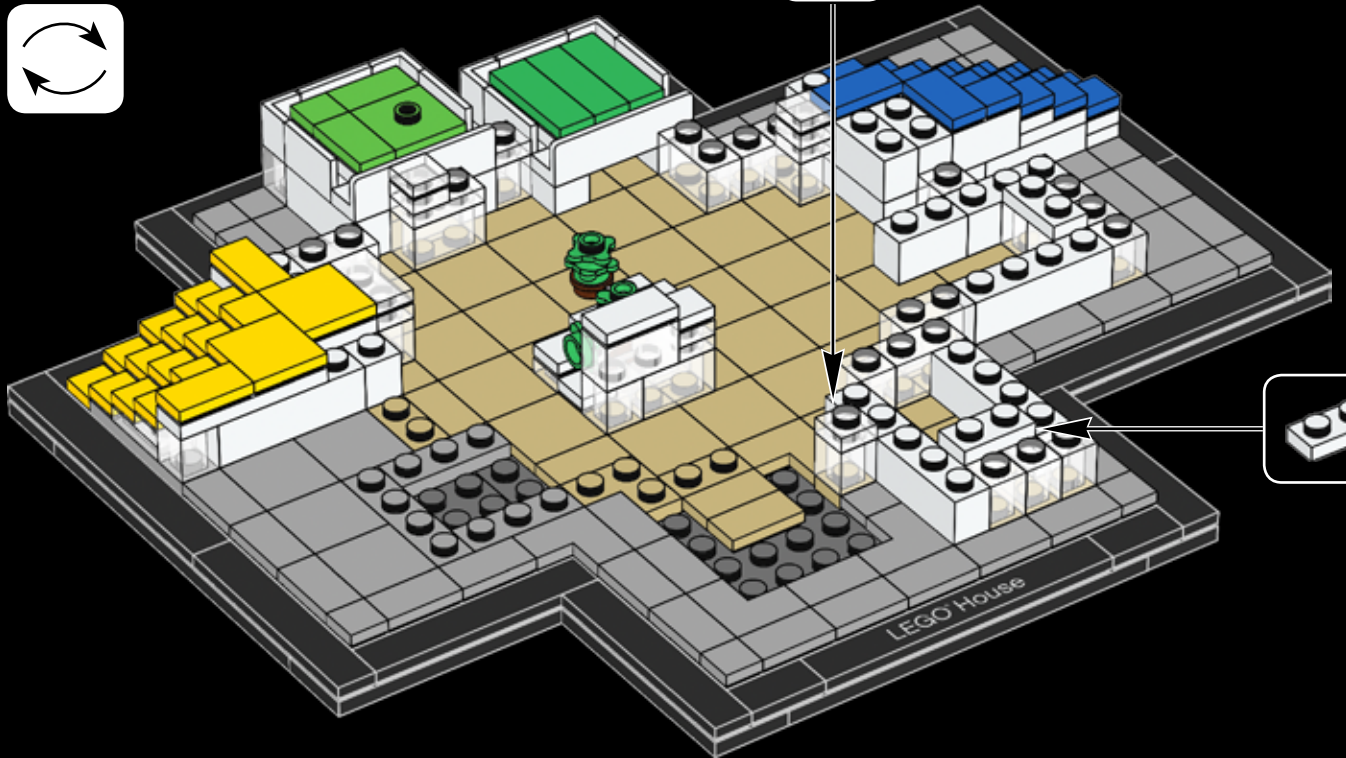
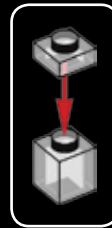

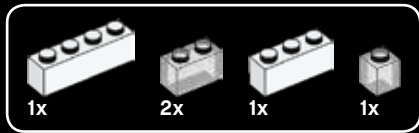

63

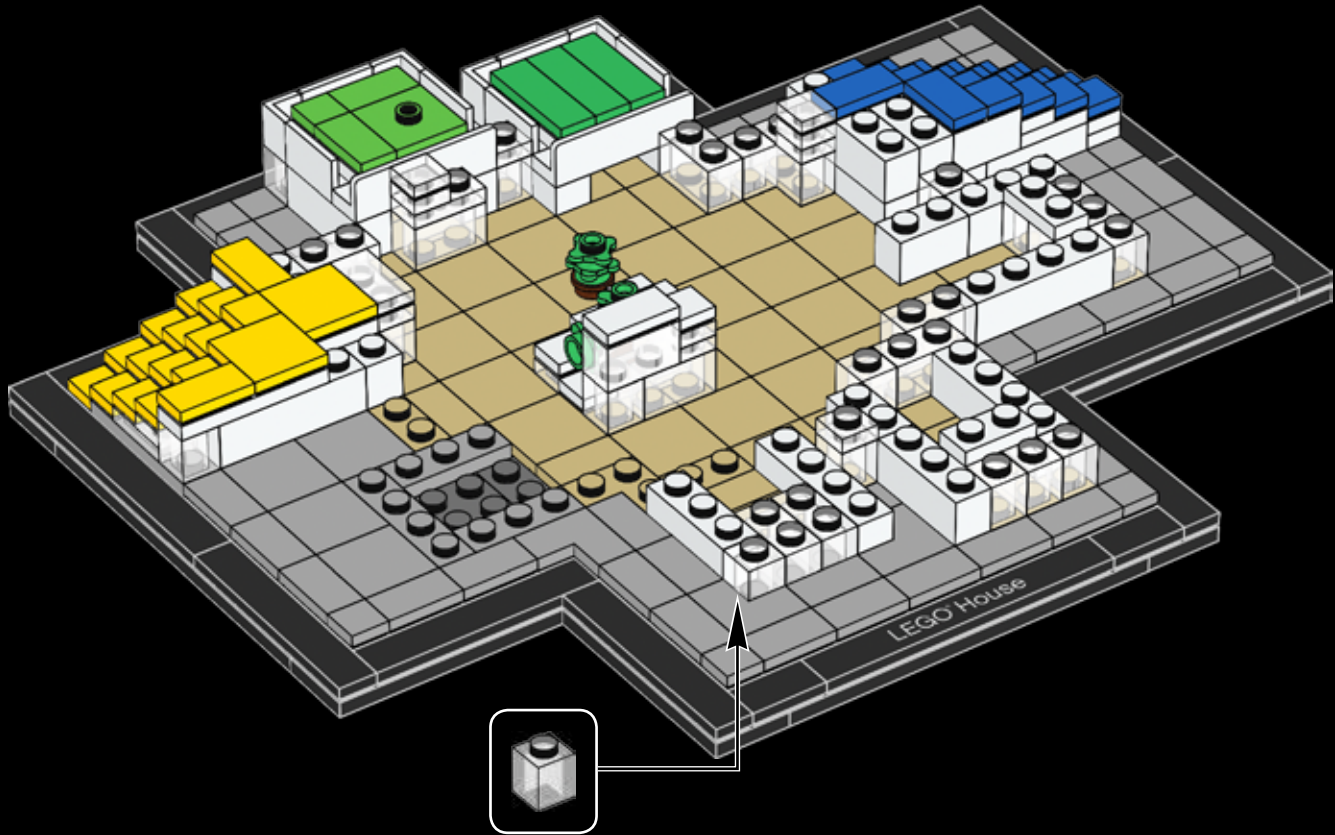



There are 13 different colors on the terraces in the palette of yellow, blue, green, red and white.



64

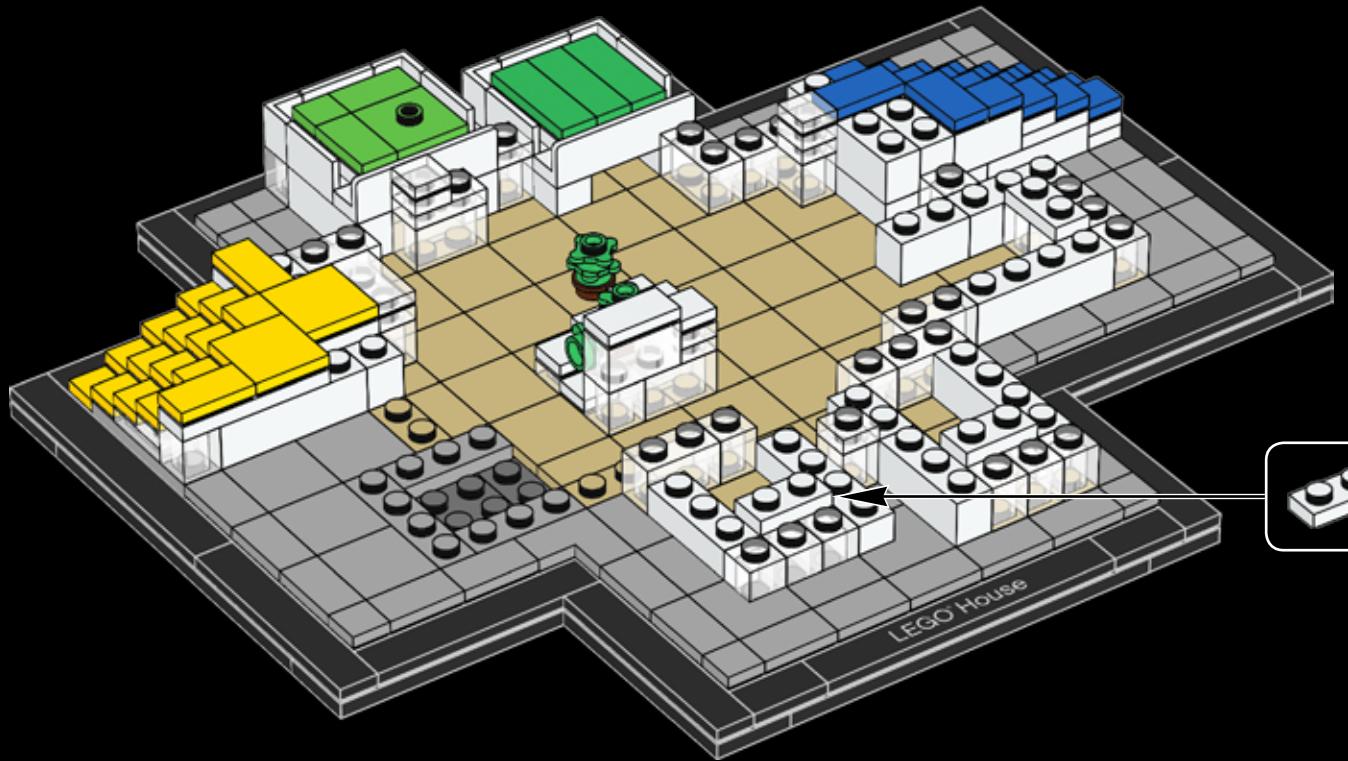

1x 2x 2x

65

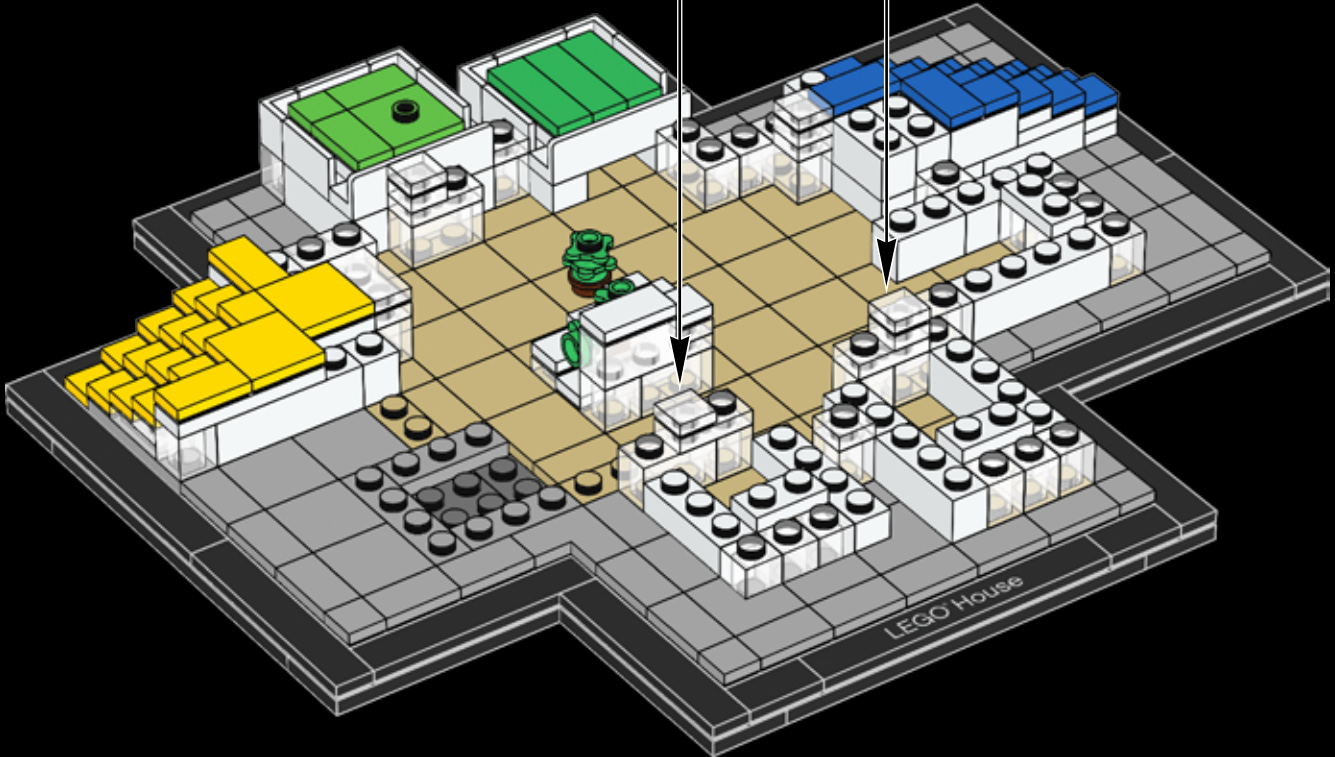
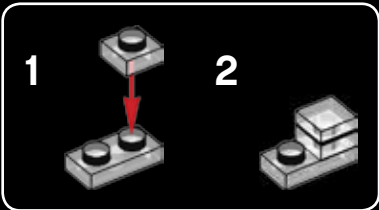
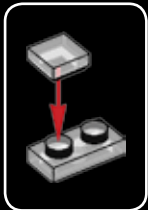

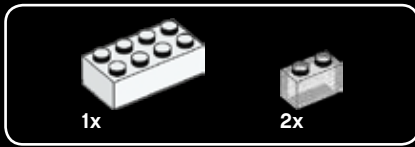

66

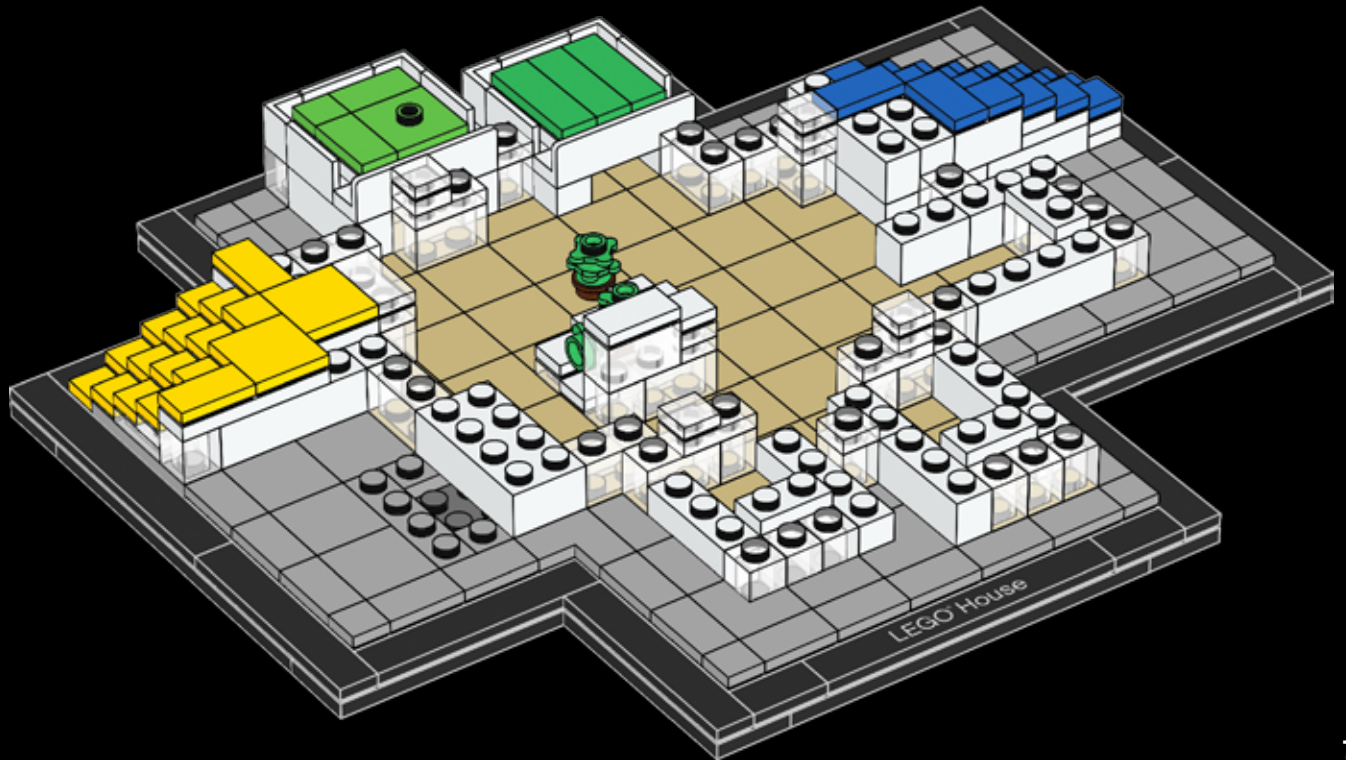



67

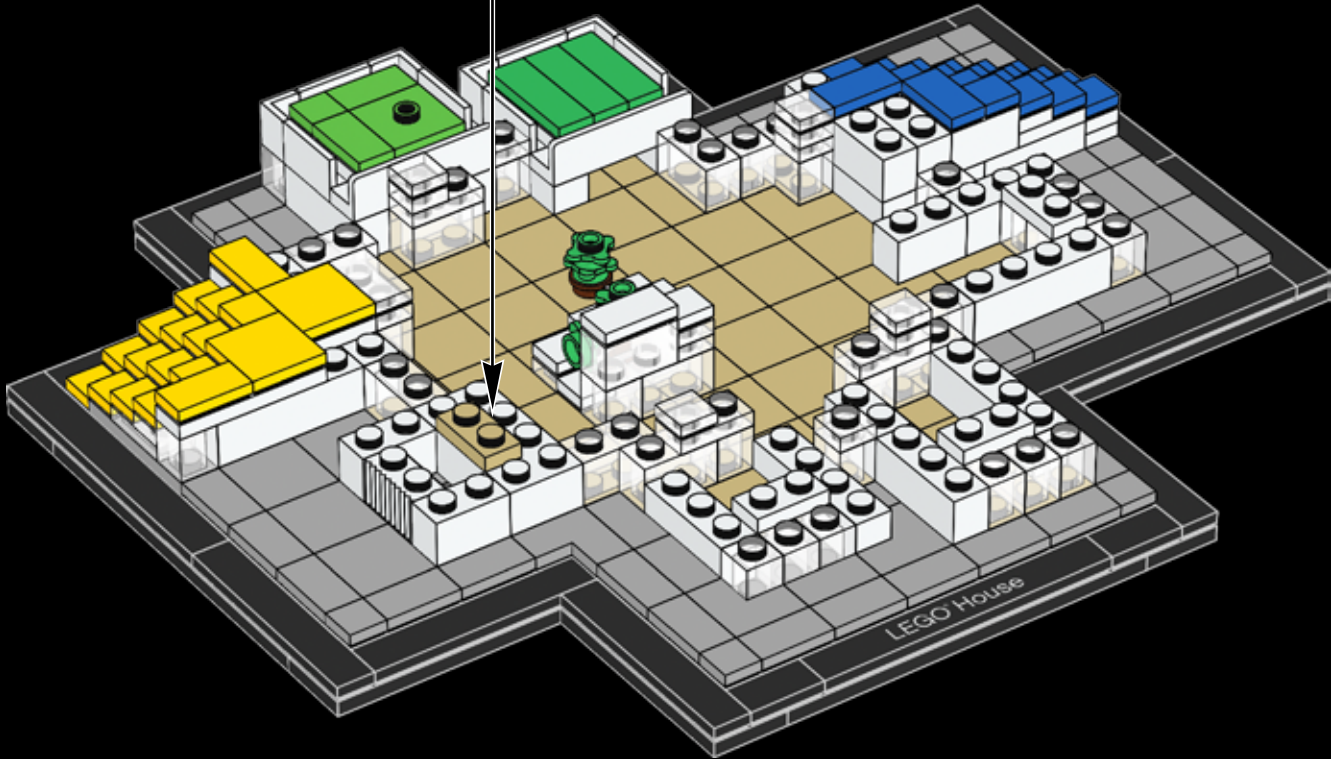

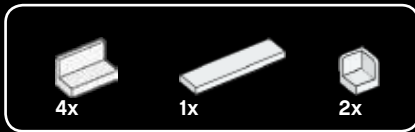

68

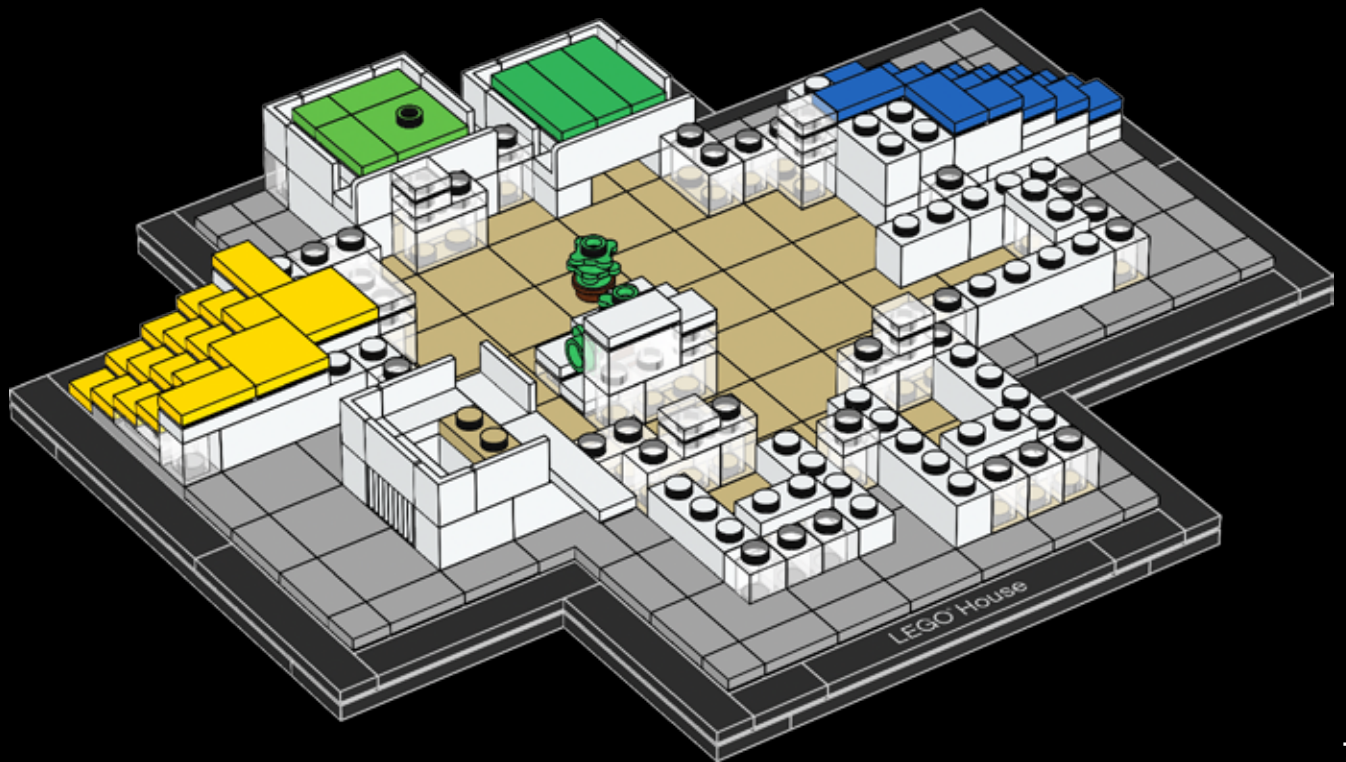

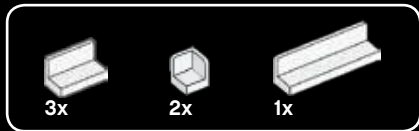

69

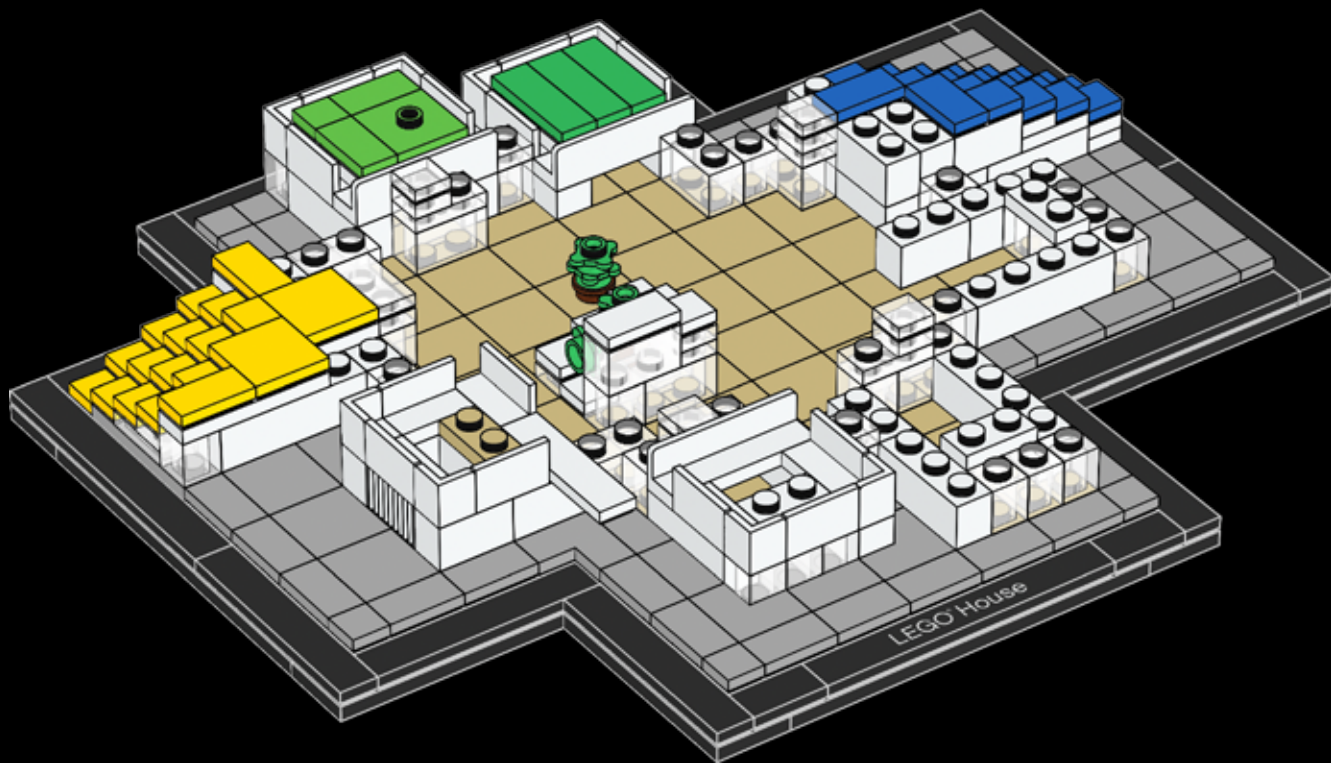

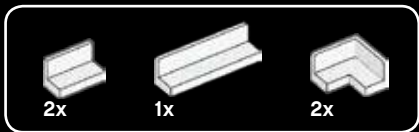

70

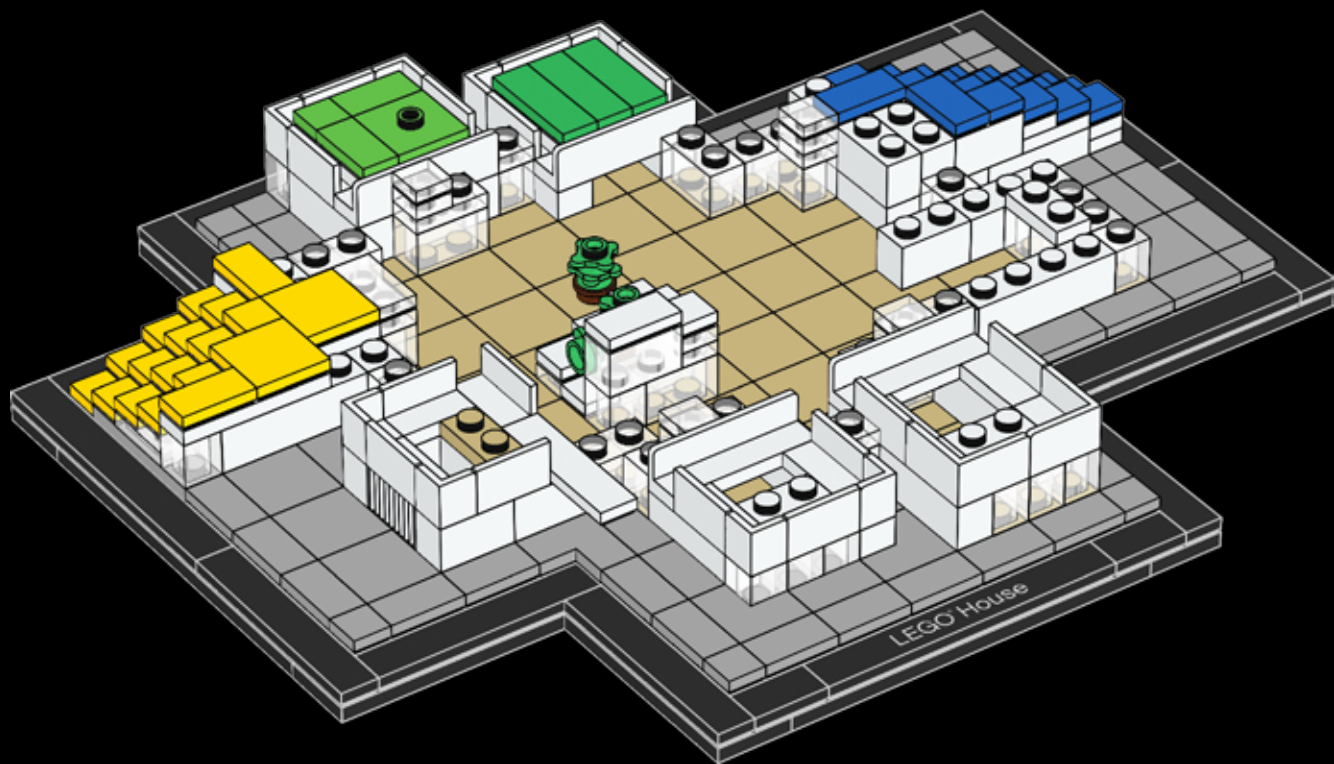

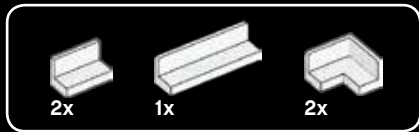

71

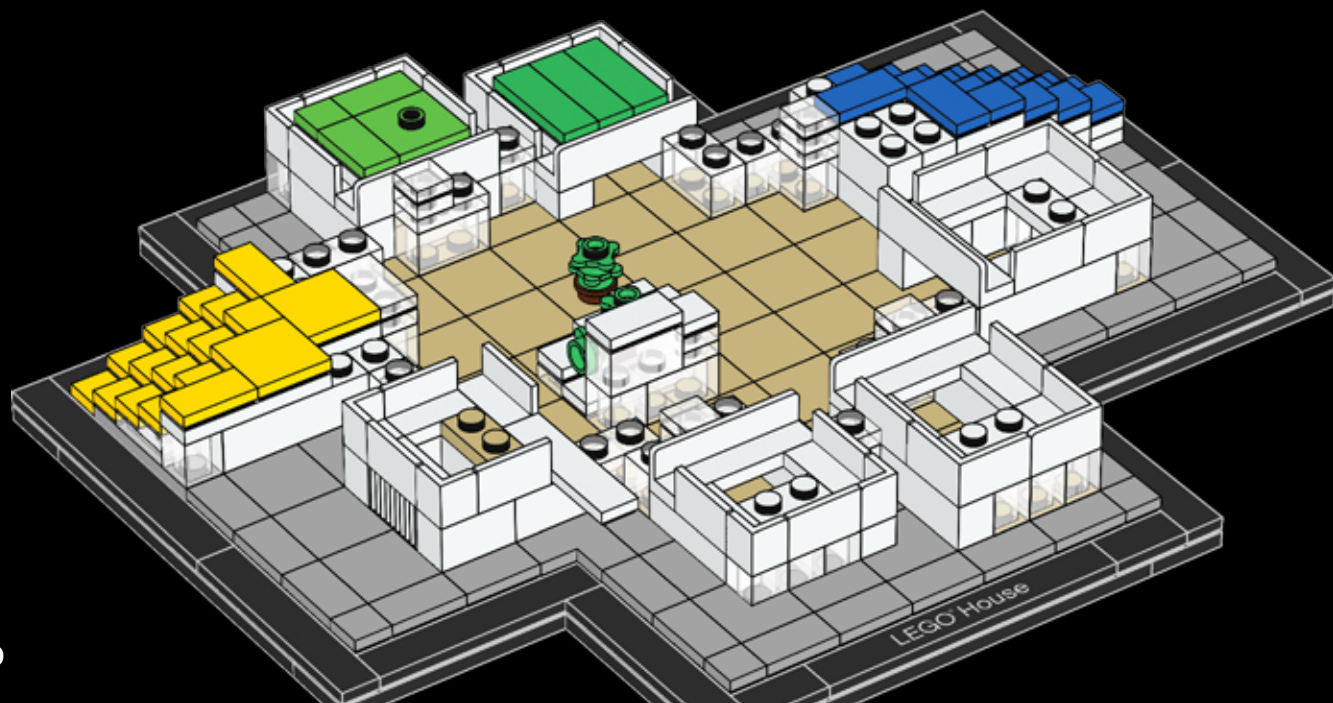

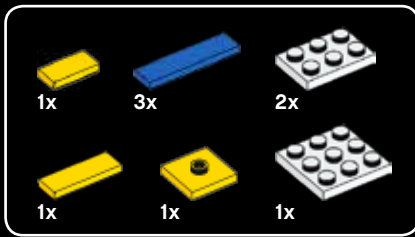

72

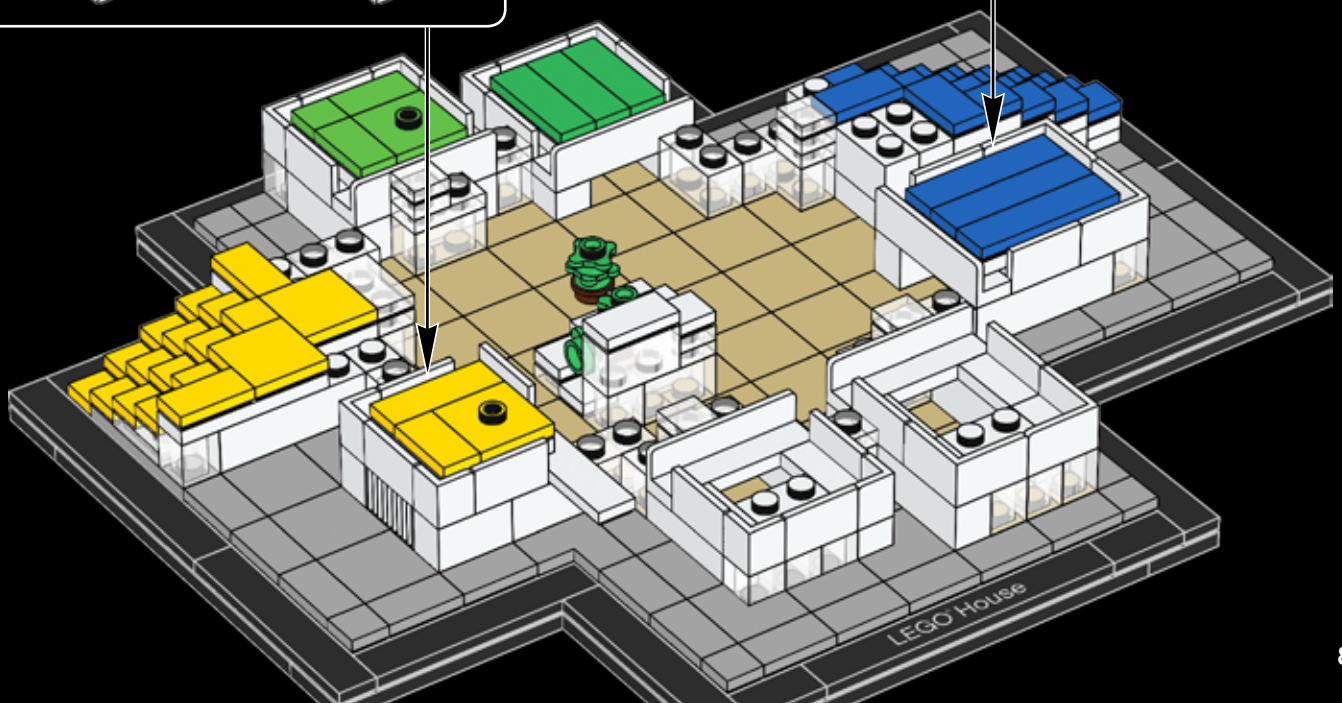
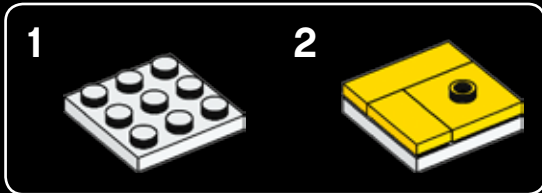
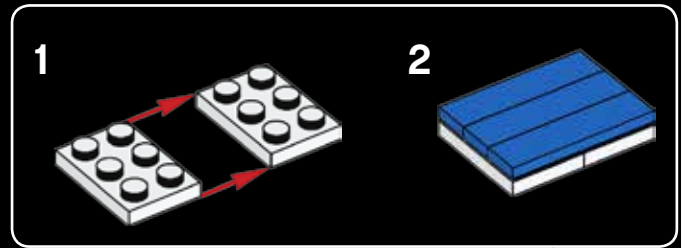

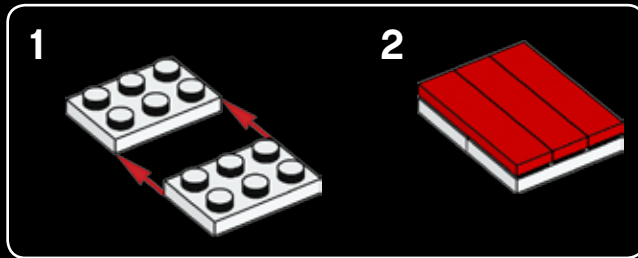
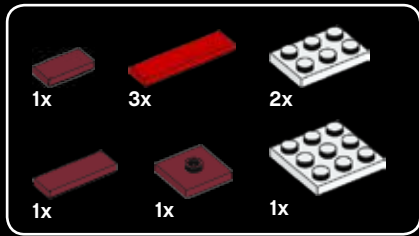

73

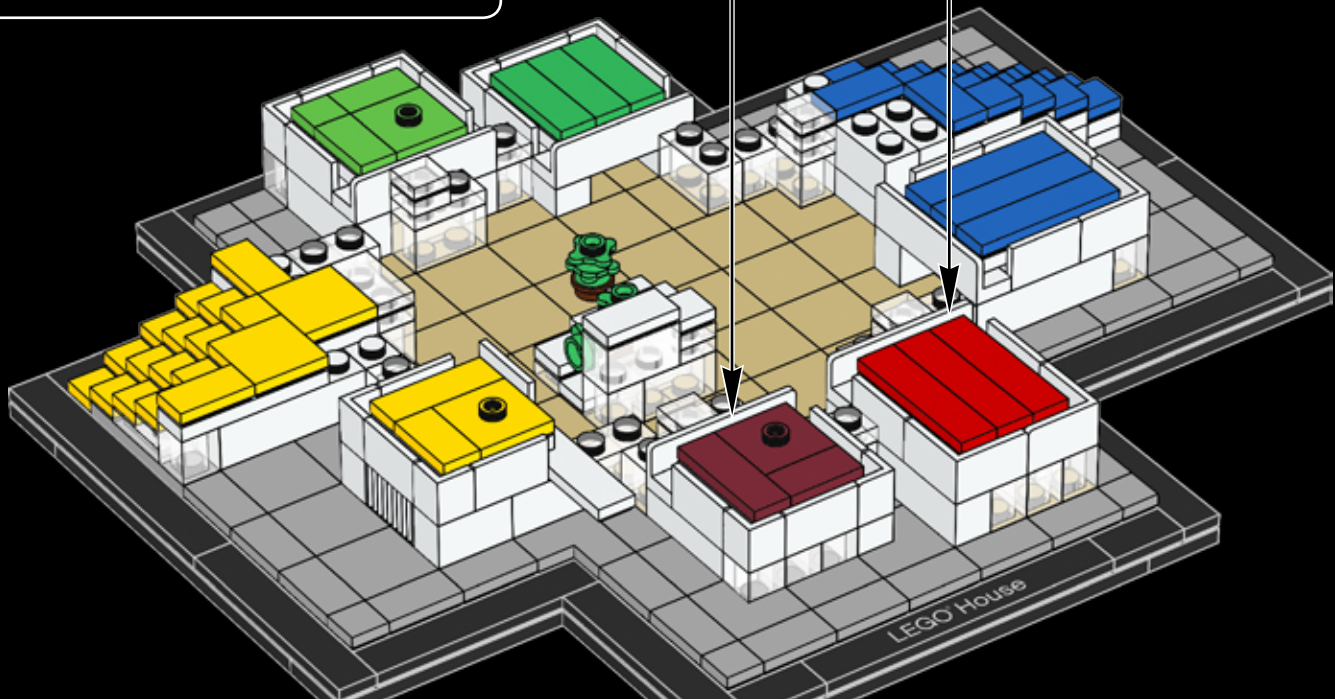
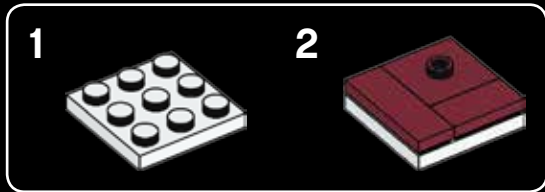



74

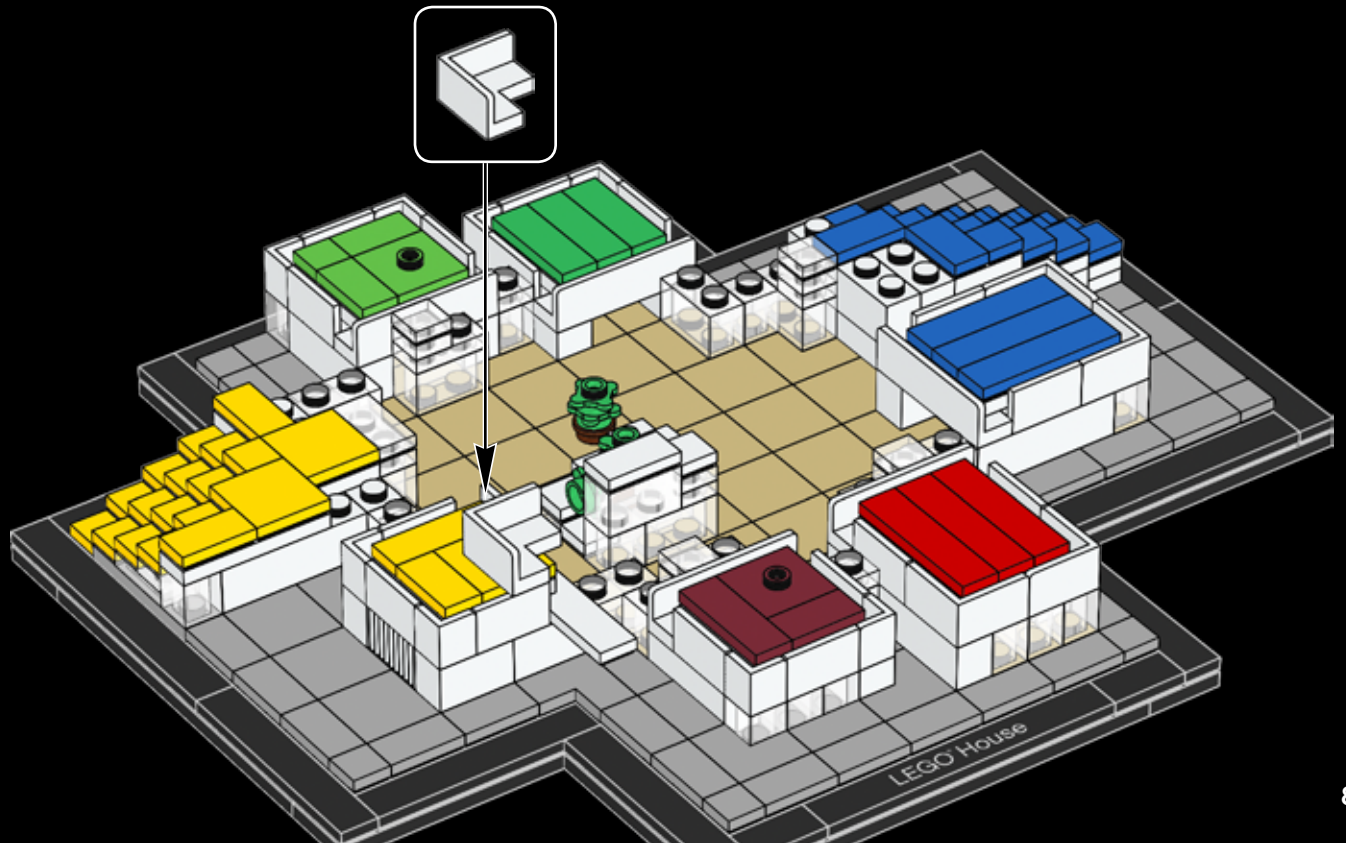



1x



75



2x

76

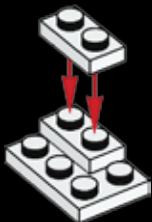

1x

77



1x

78





79

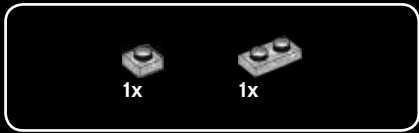

80

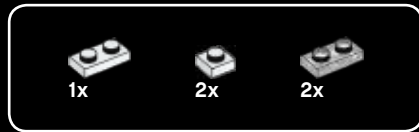

81

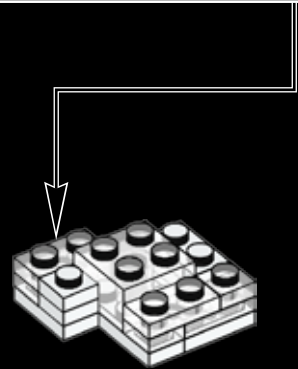
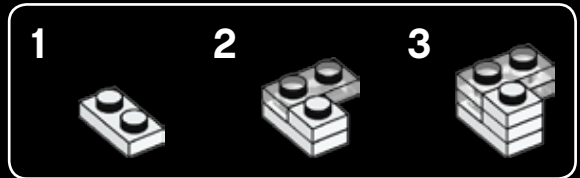



4x

82



3x

1x

83

1



2

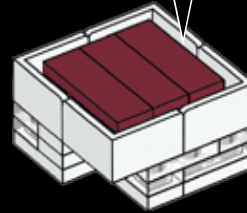
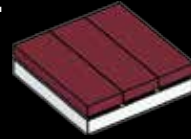

84

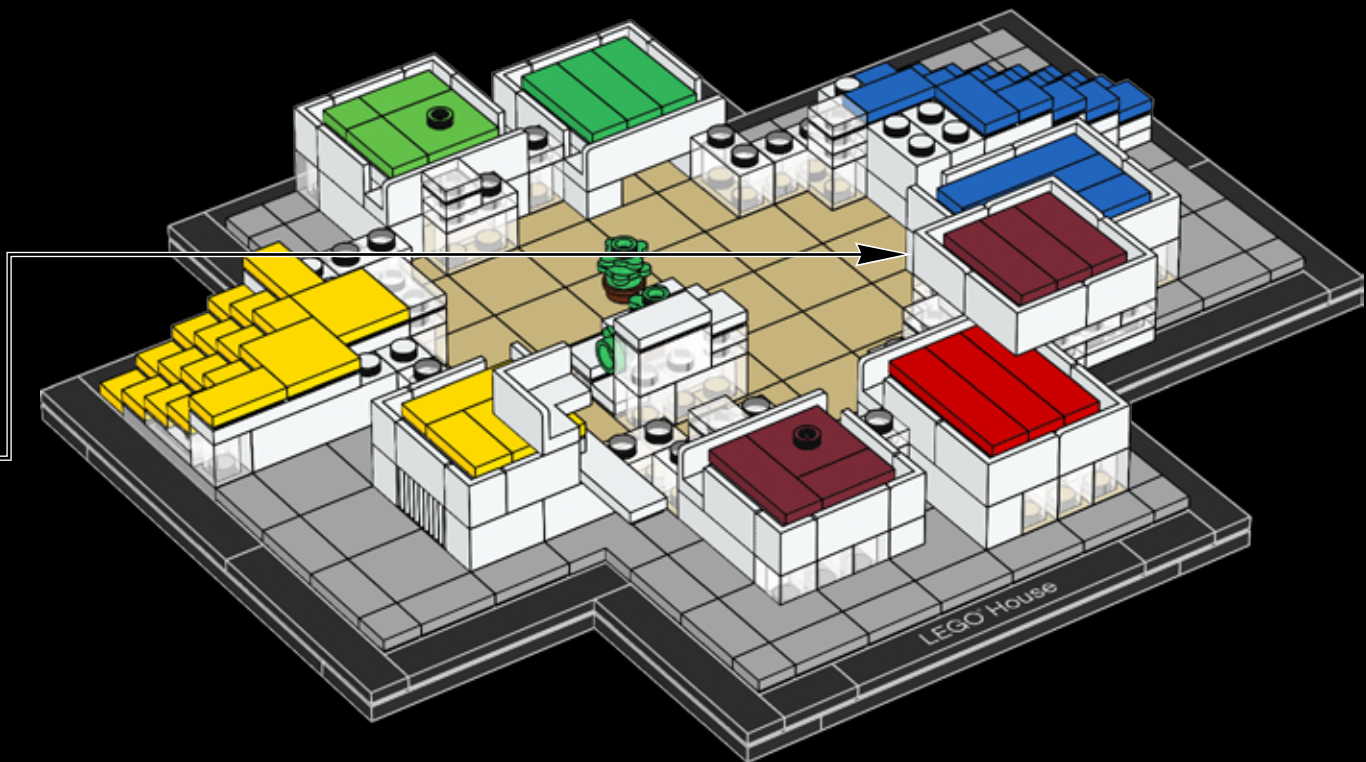



85

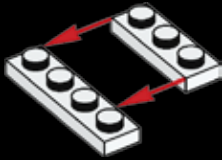

86

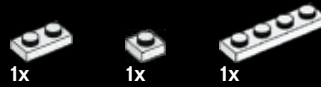

87

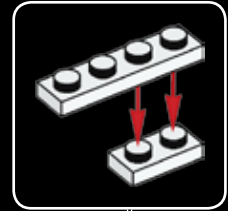

88

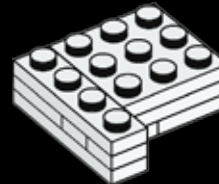



89

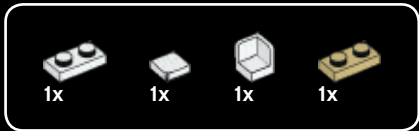
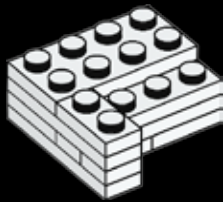

90

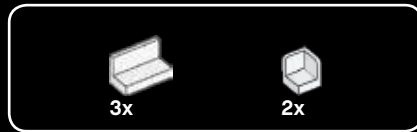
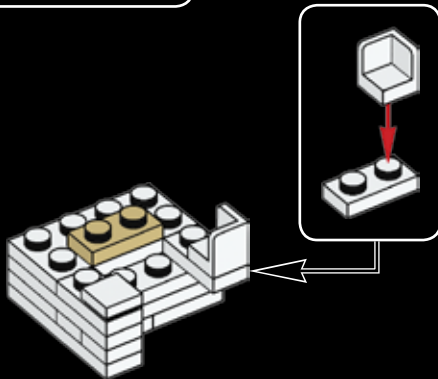

91

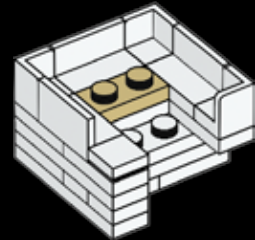



92

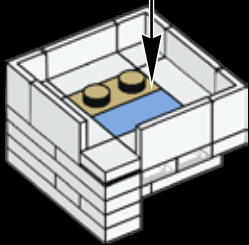
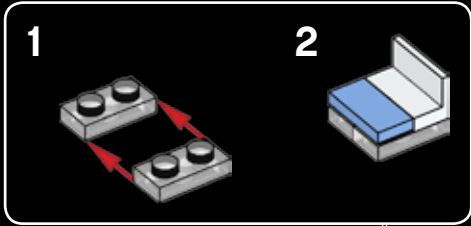

93

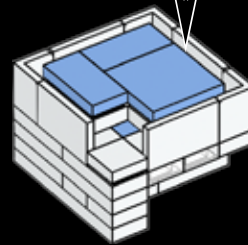
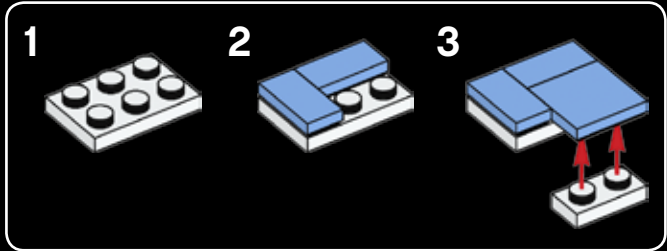

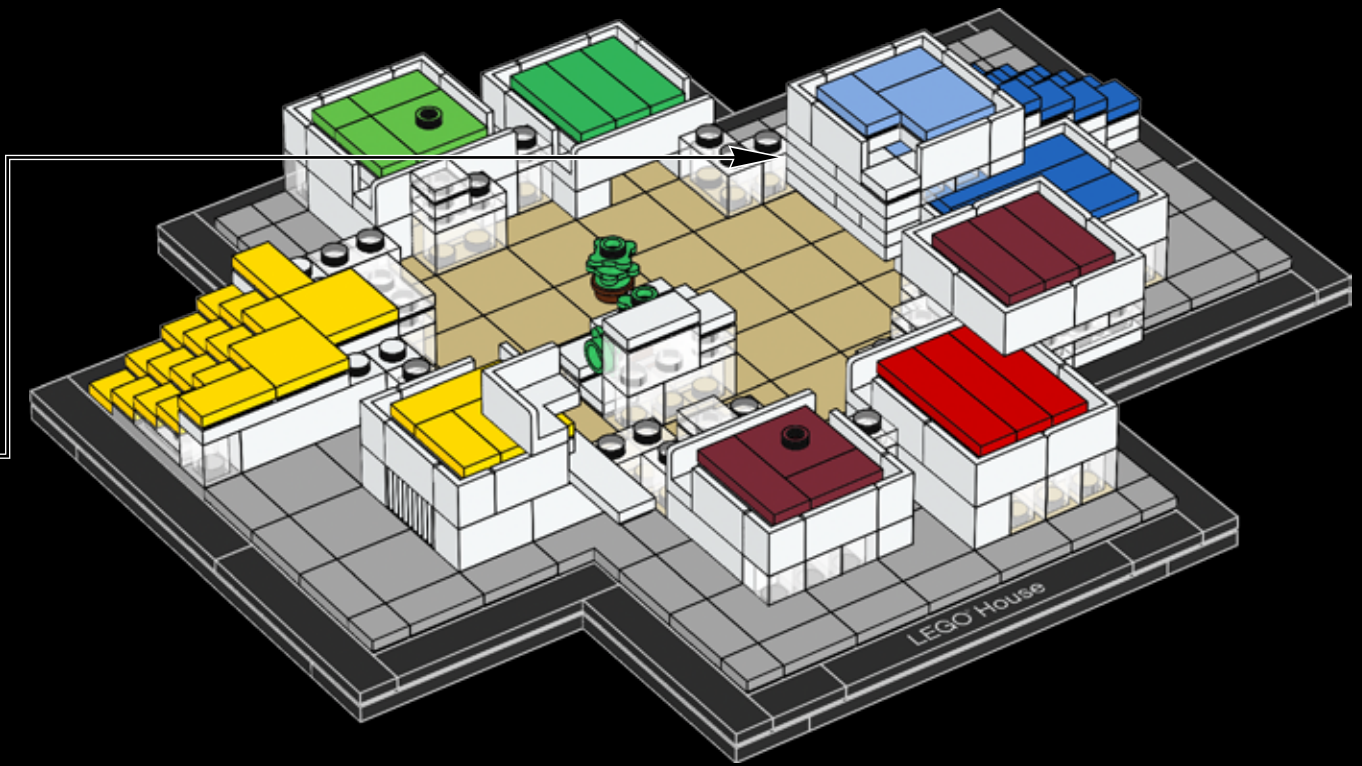



1x



1x

95

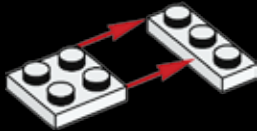

1x



1x



1x

96



1x



1x

97

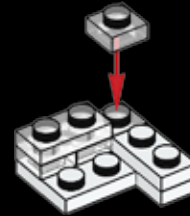

1x

98





99



100

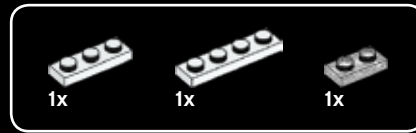
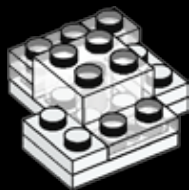

101

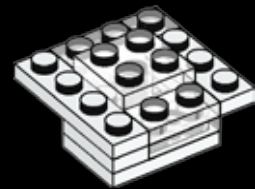



4x

102



1x



3x

103

1



2

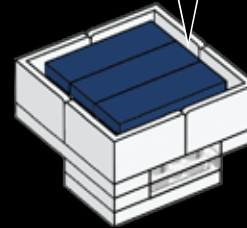
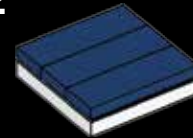

104

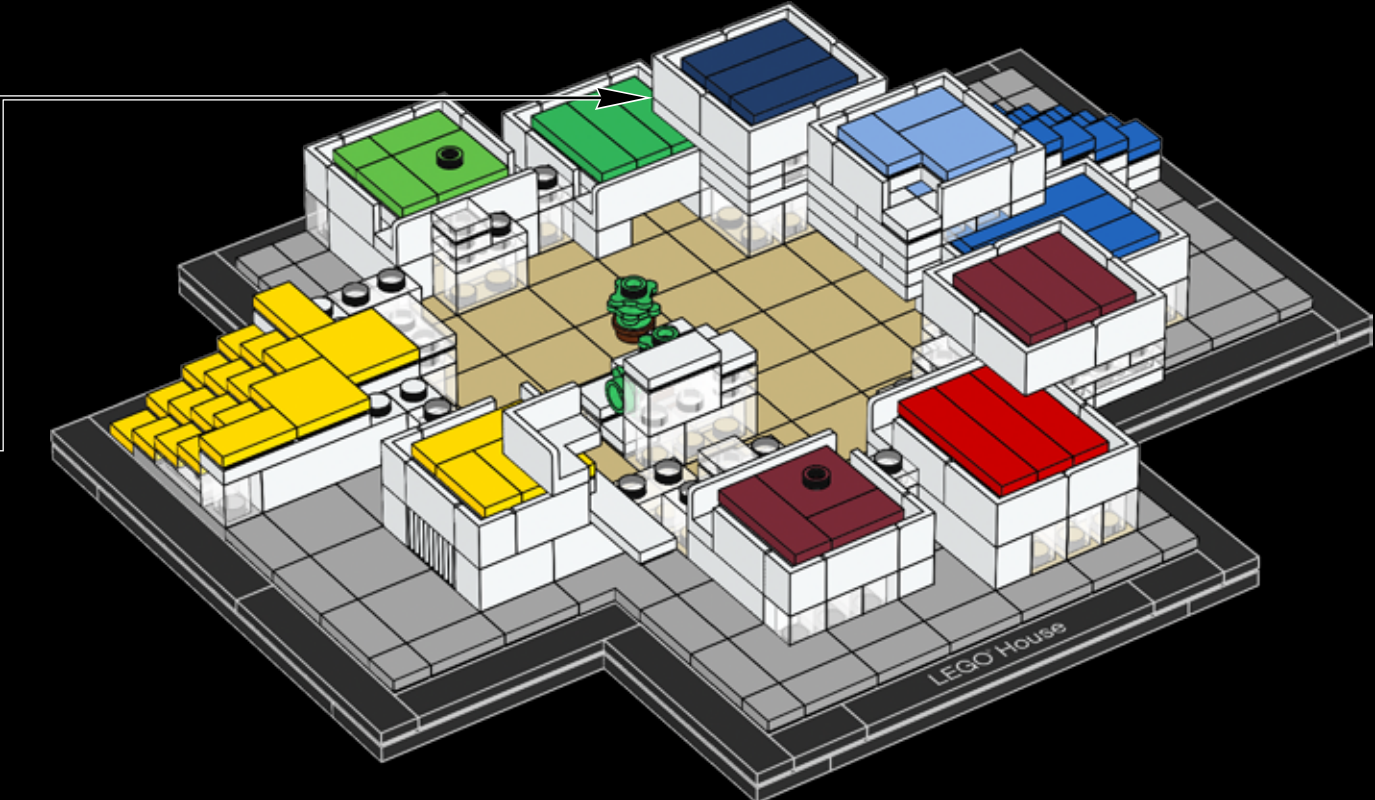



105

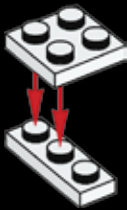

106

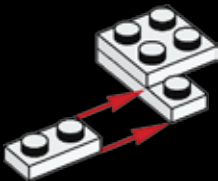

107



108

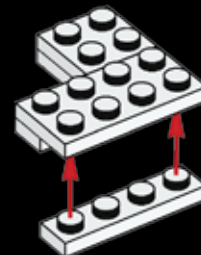



109



110



111

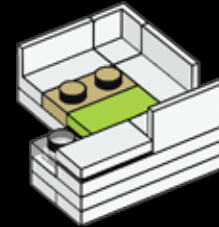



112

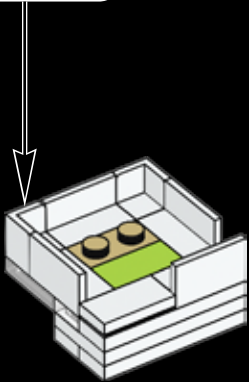
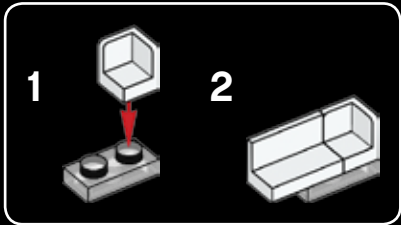

113

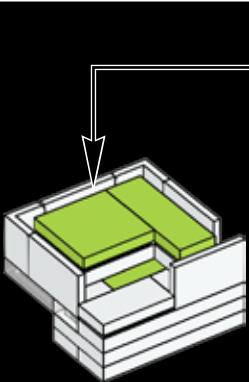
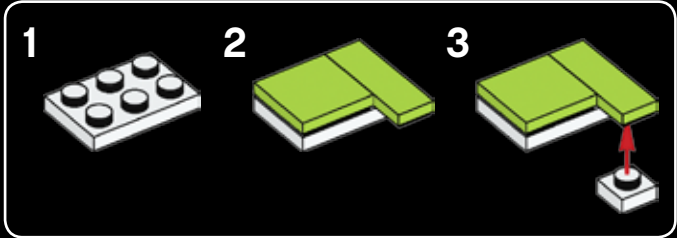

114

The surfaces of the colored terraces are made of leftover materials from sneaker production by several different international sports brands.

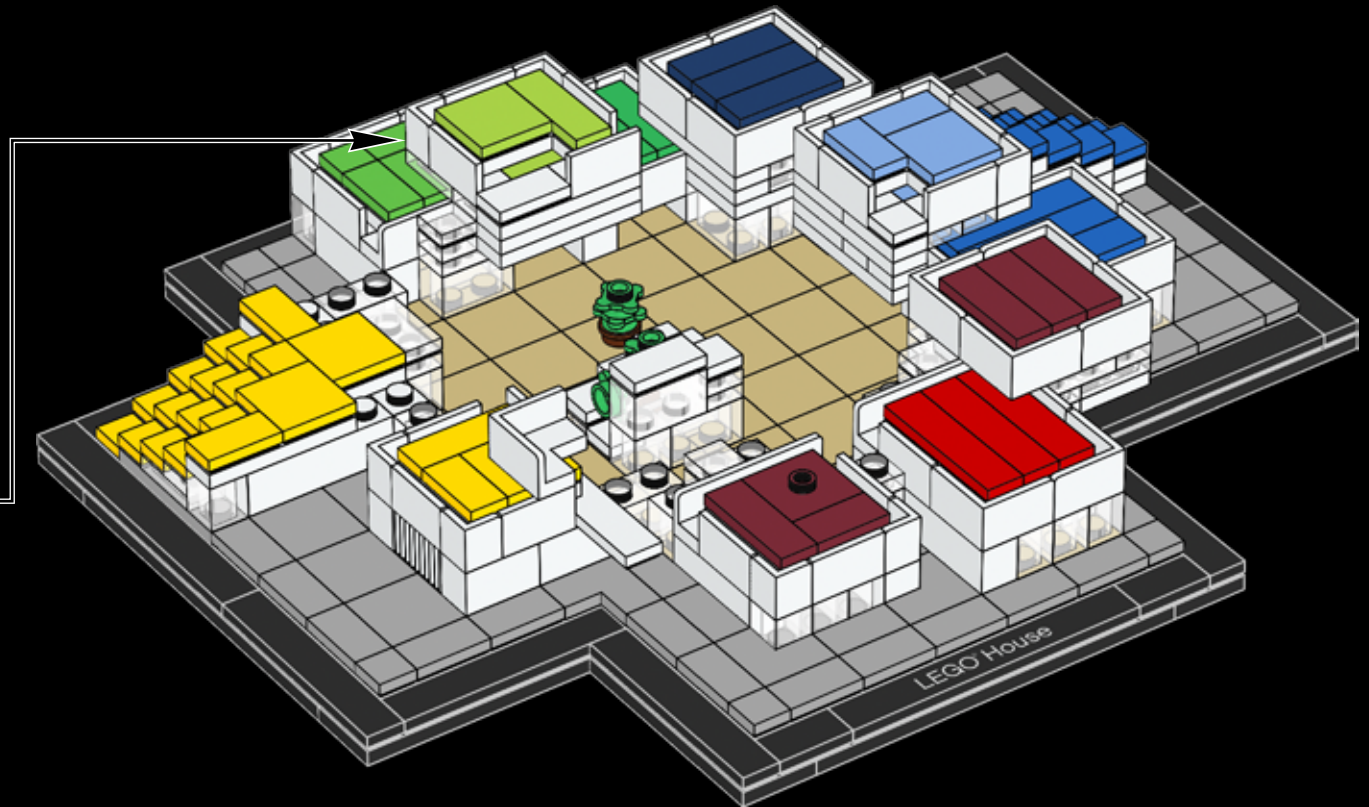



1x

115



1x



1x

116

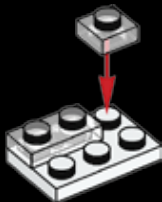

1x

117

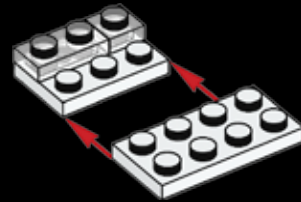

1x

118



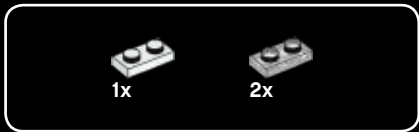

119

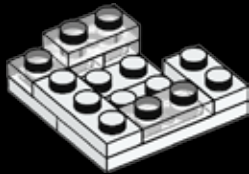

120

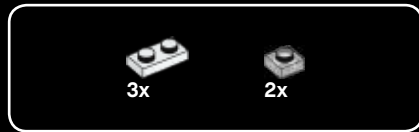
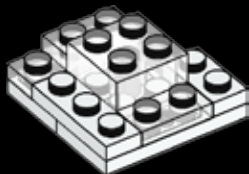

121





4x

122



3x



1x

123

1



2

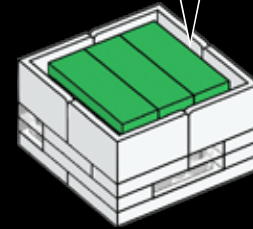

124

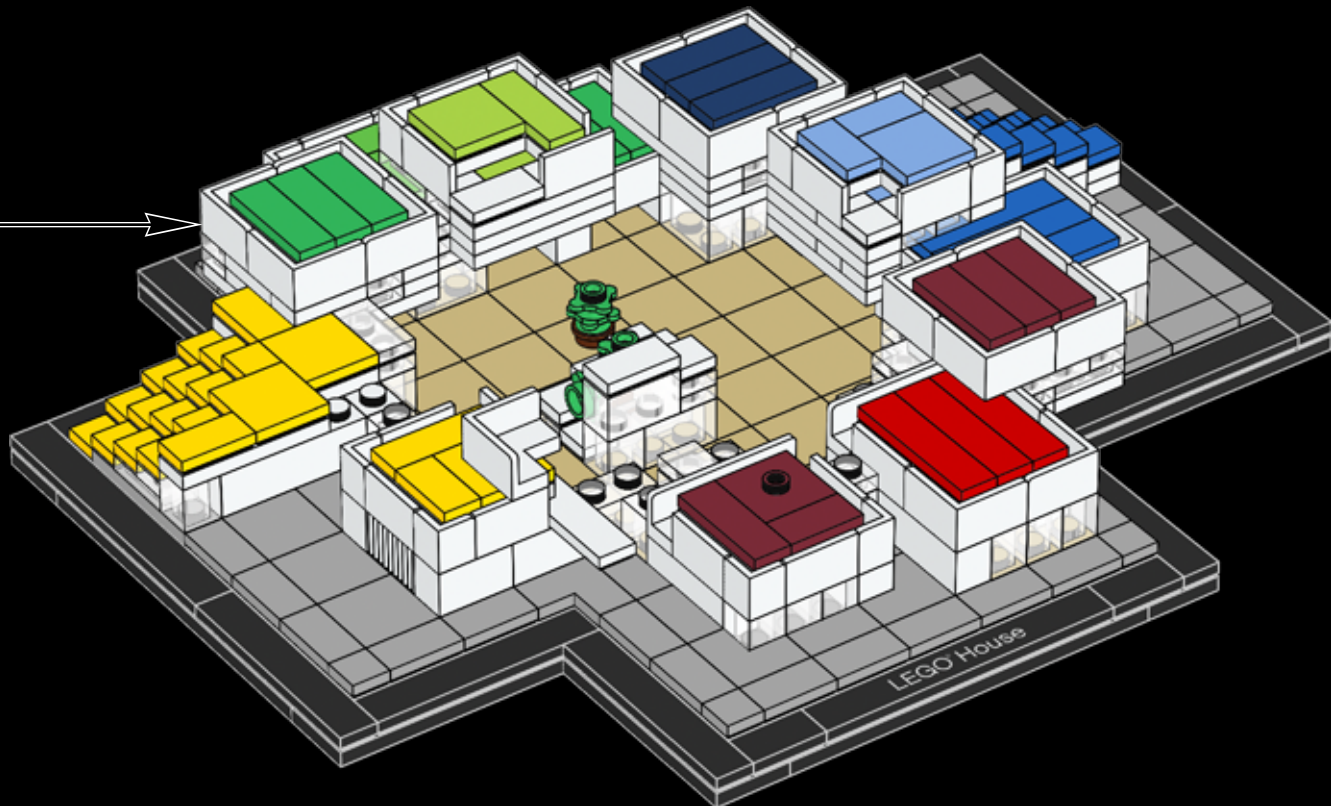



1x



1x

125

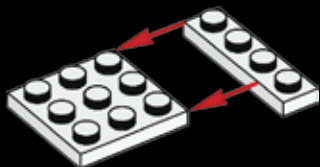

1x

126

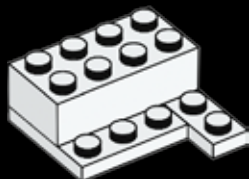

1x



1x

127

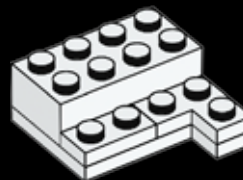

1x



1x

128

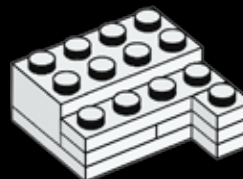



129

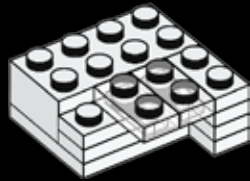

130

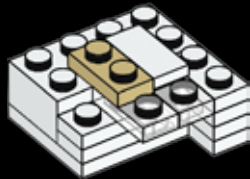

131

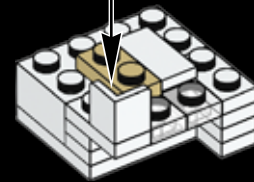
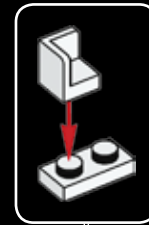



132

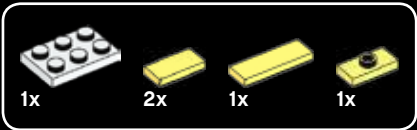
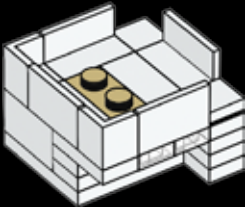

133

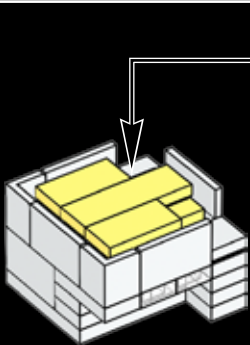
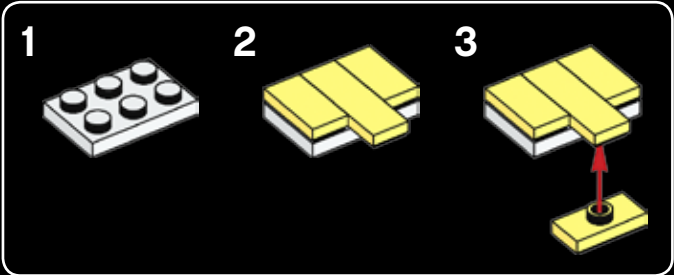

134

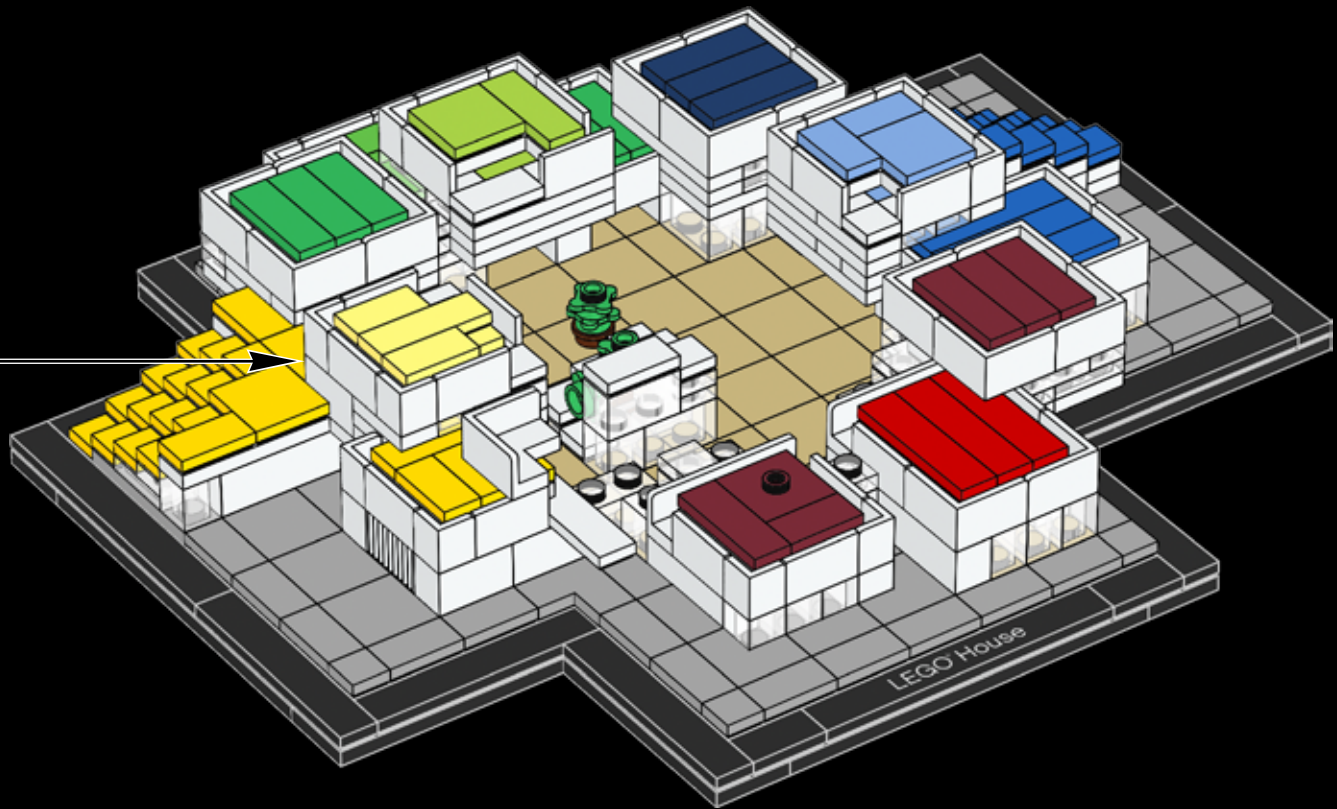



1x



1x

135

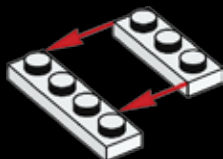

1x

136



1x

137



1x

138





139

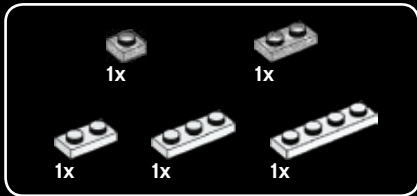

140

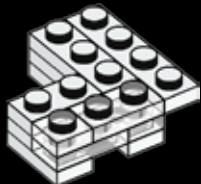

141





2x

142

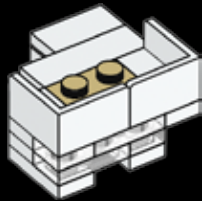

1x



1x



2x

143

1



2

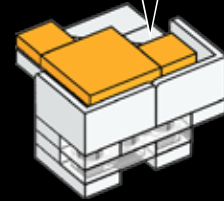

144

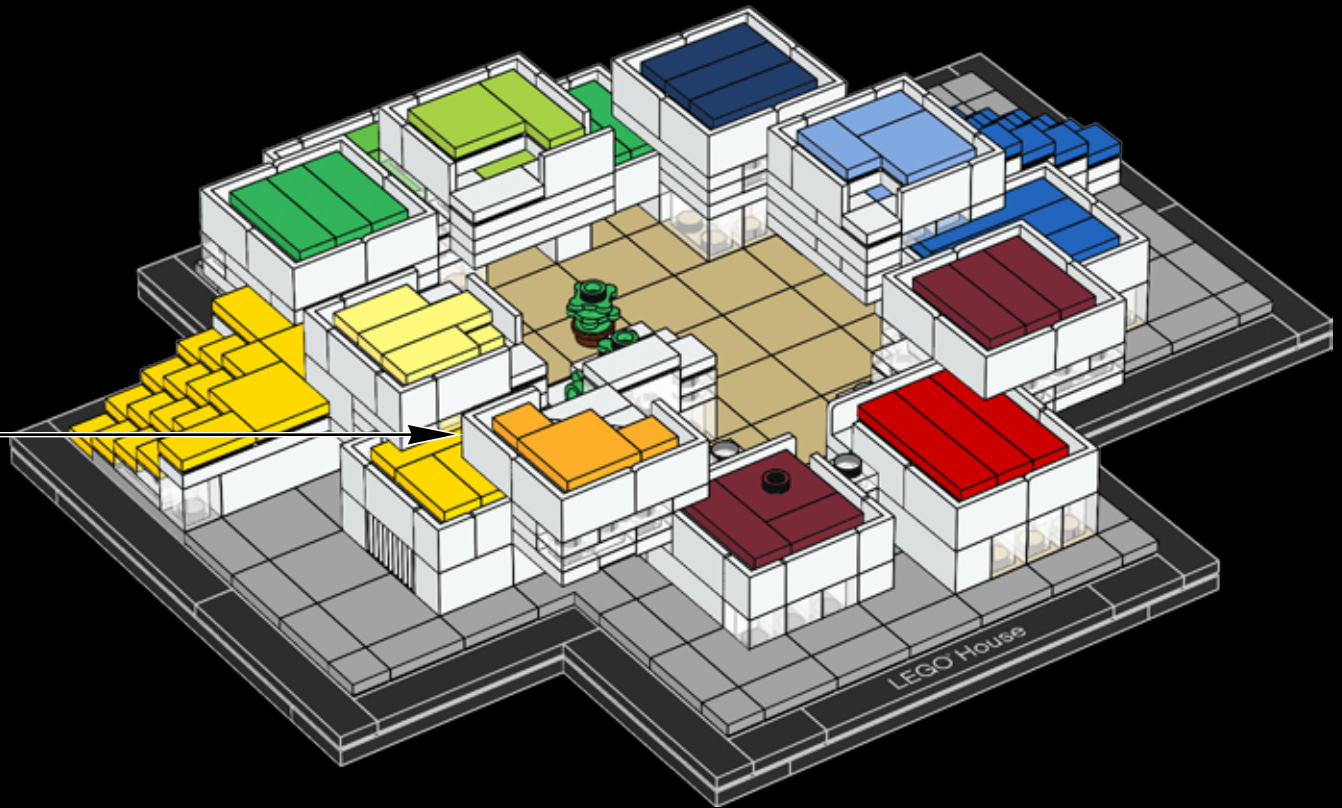



1x



1x

145

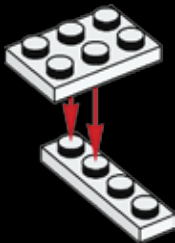

2x

146



1x



2x

147



1x



1x

148

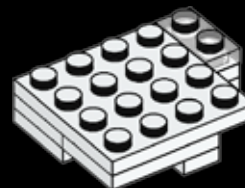



149

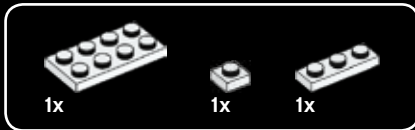
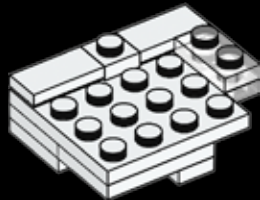
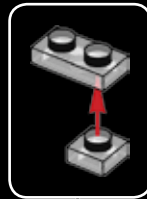

150

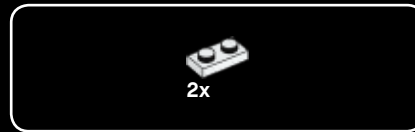
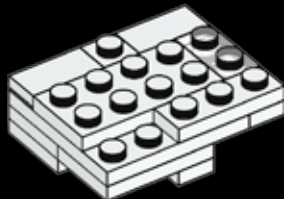
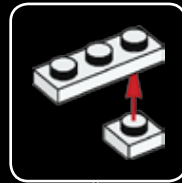

151

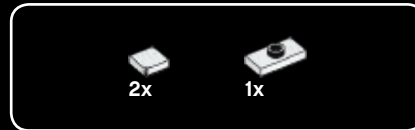
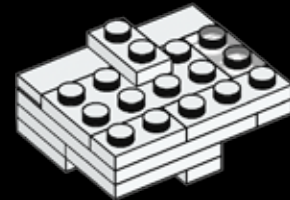

152

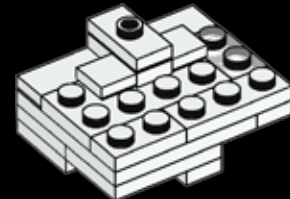

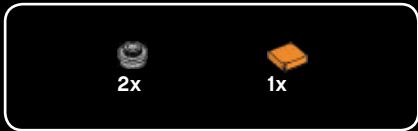

153

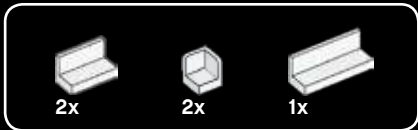
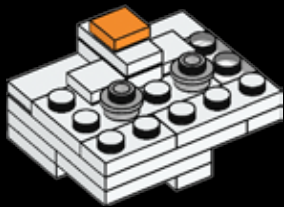

154

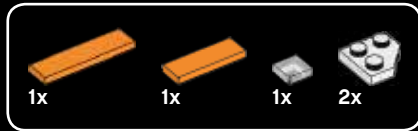
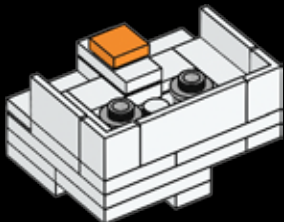

155

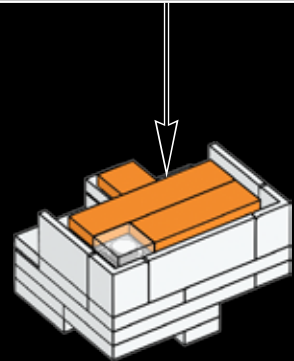
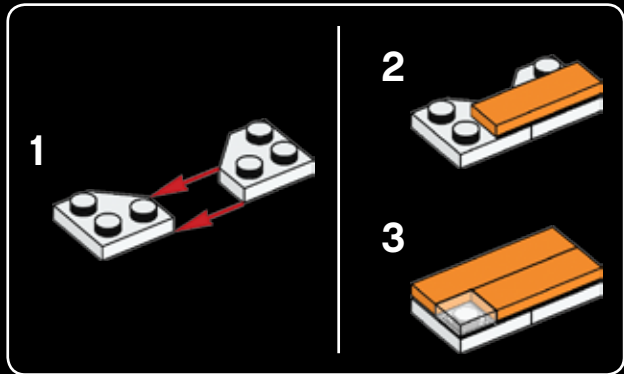

156

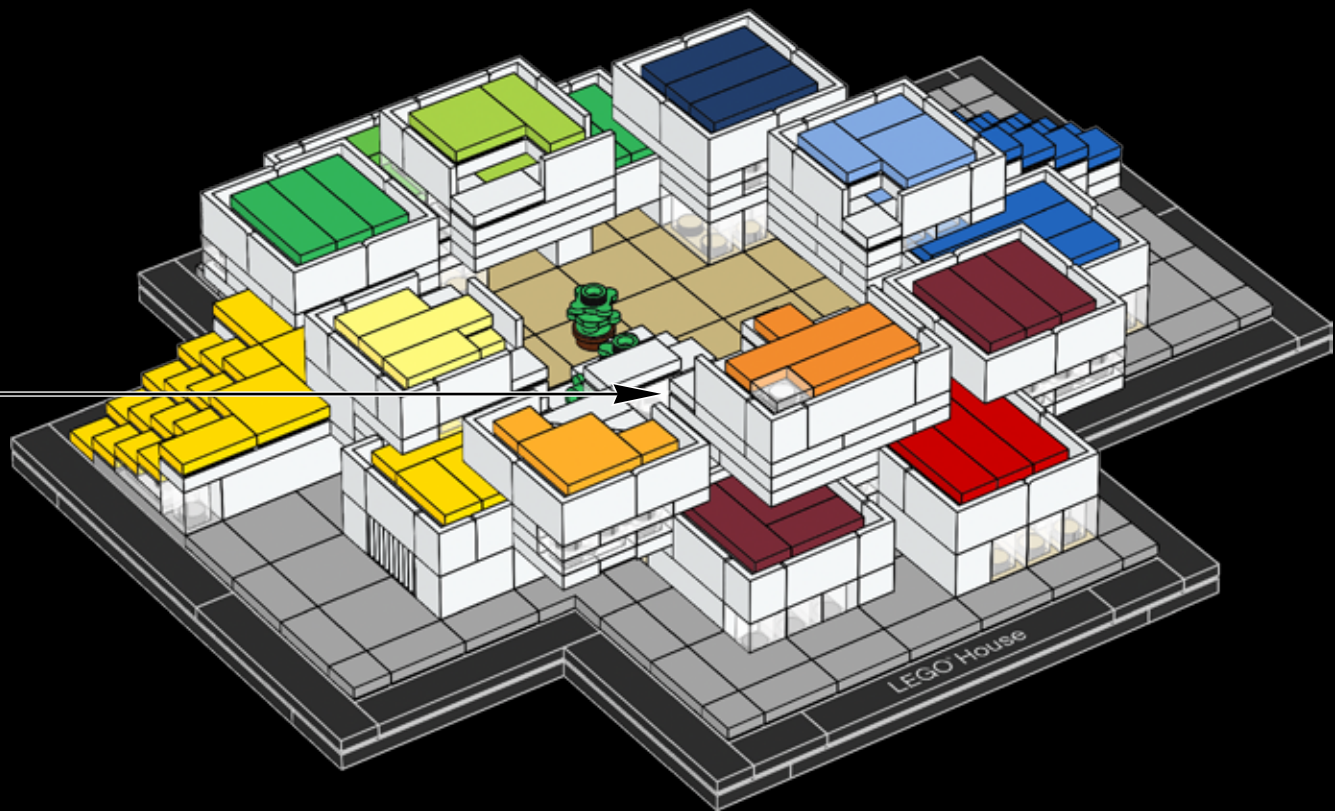

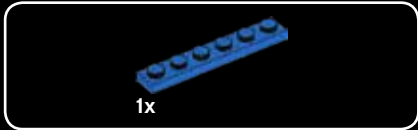
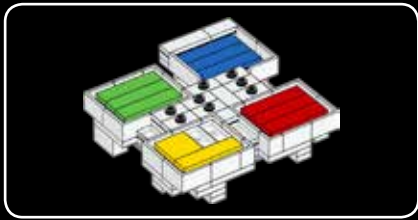

157



158

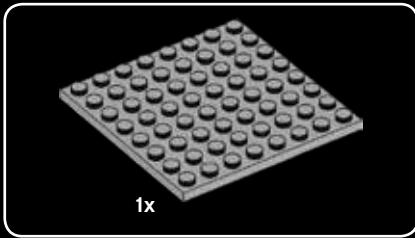

159

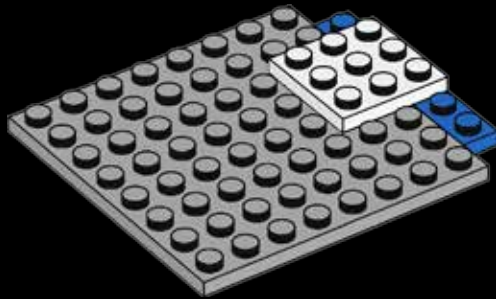



160

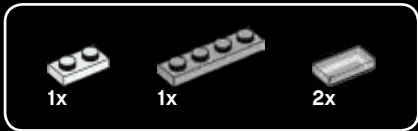
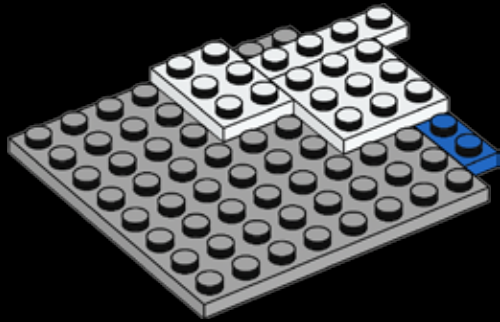

161

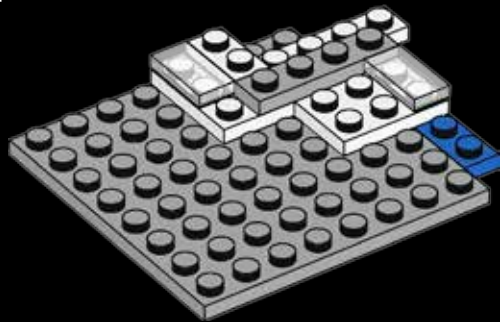

162

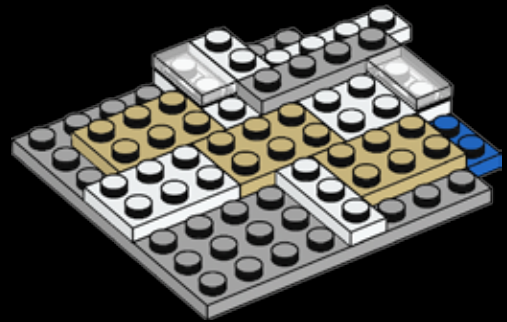



163

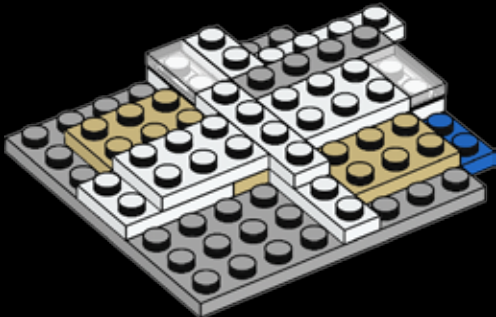

164

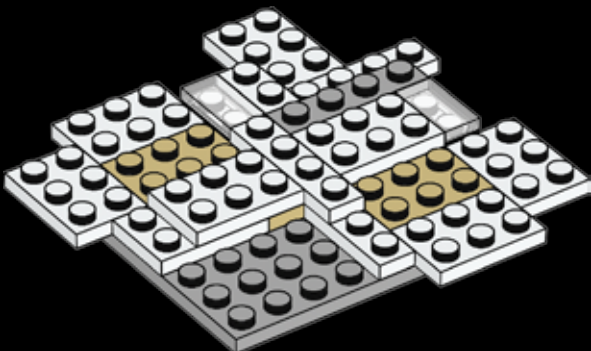

165

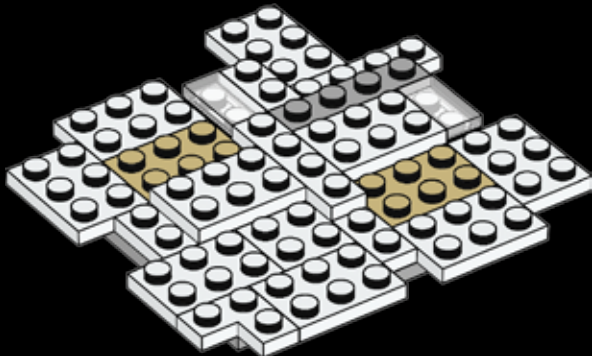

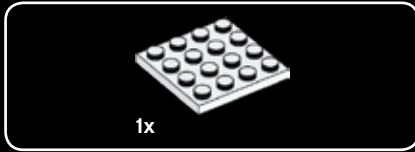

166



167



168

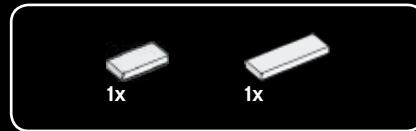

169



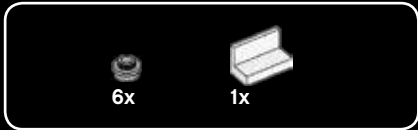

170



171

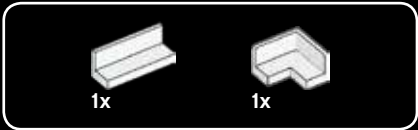
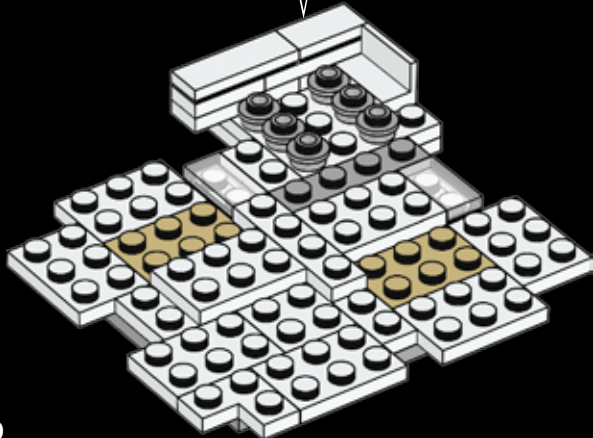

172

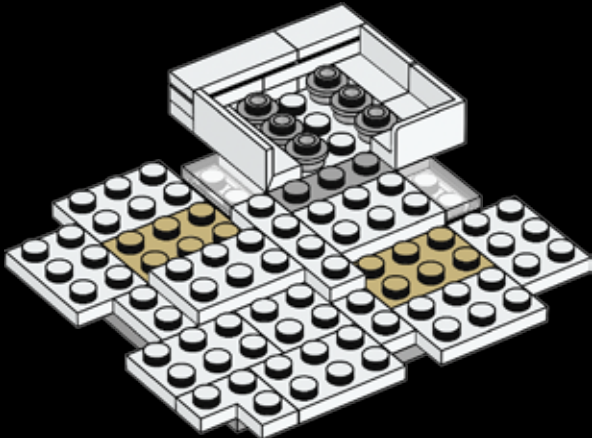

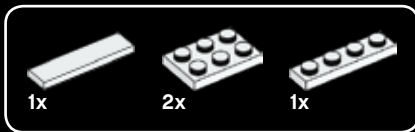

173

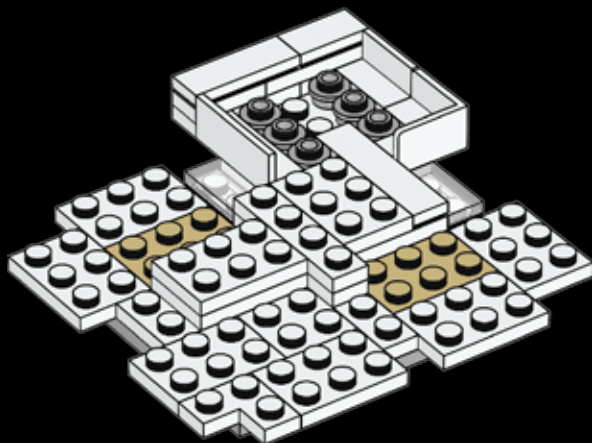

174

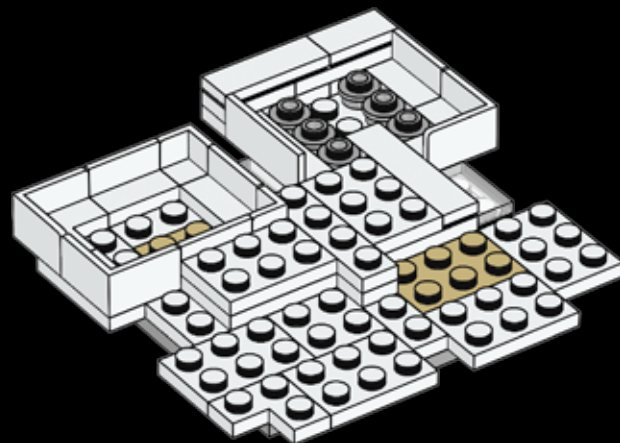



175

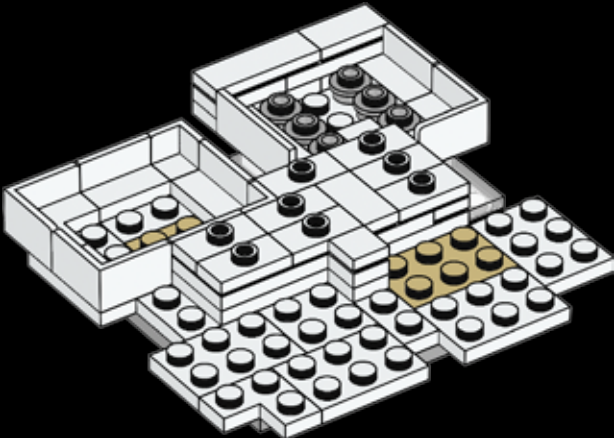

176

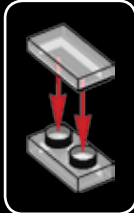
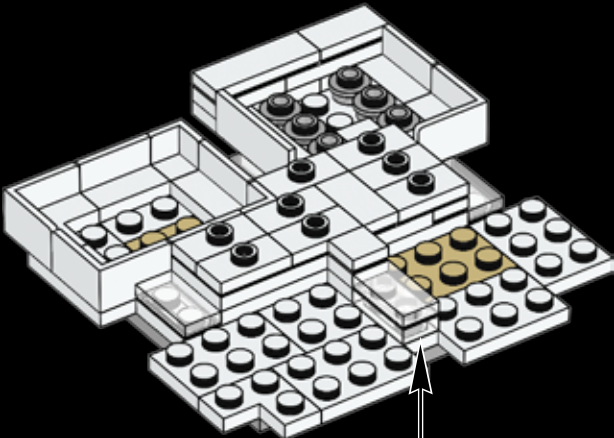



177

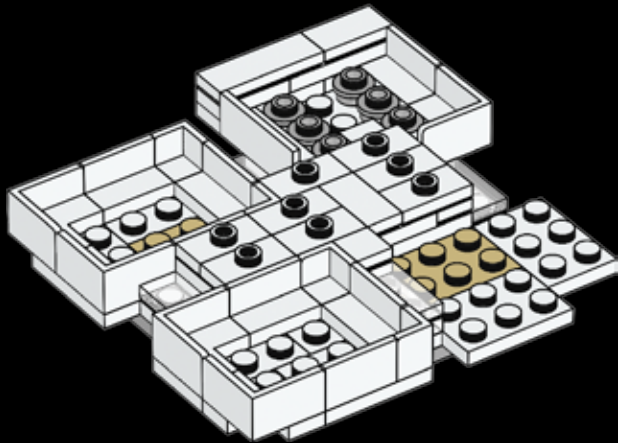

178

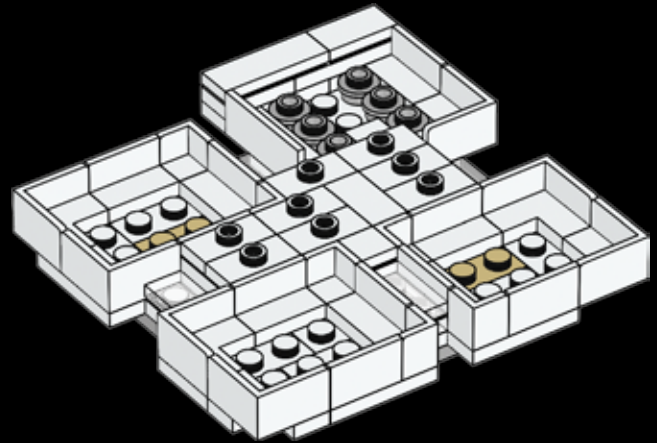



179

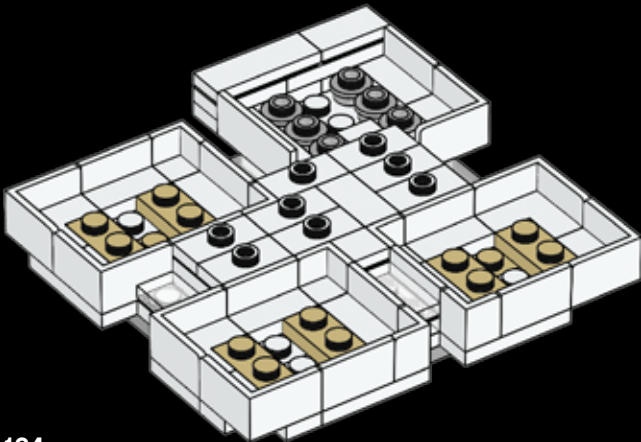

180

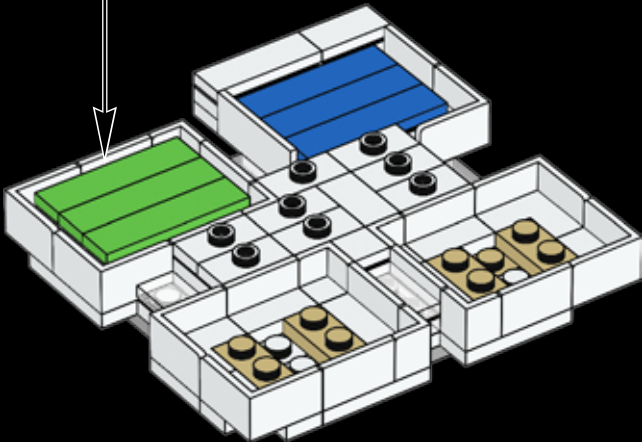
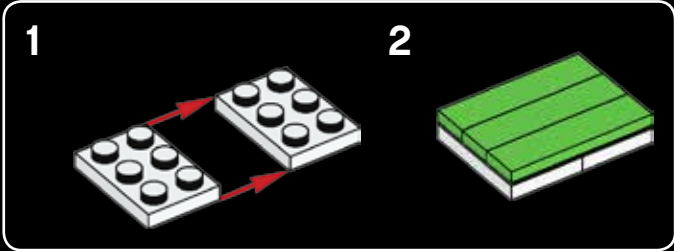

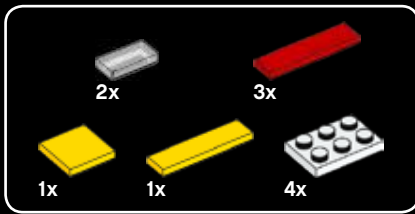

181

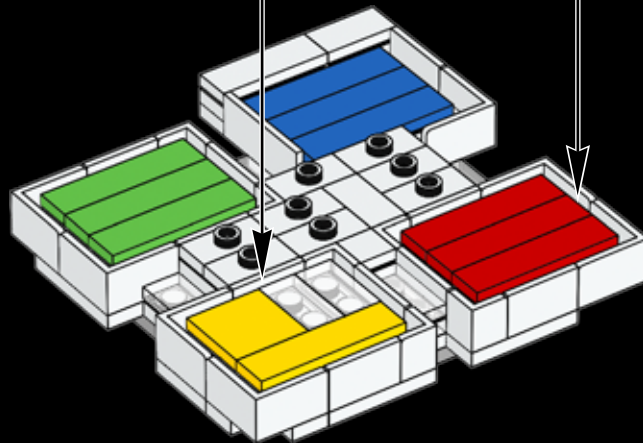
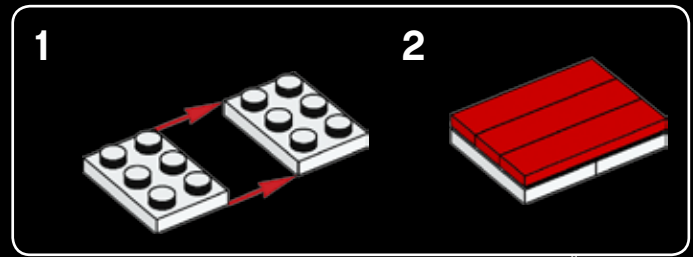
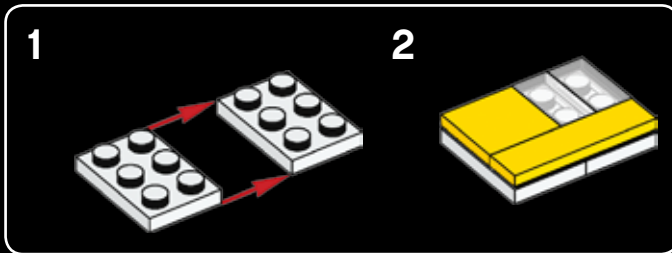



5x

182

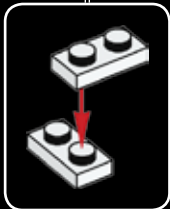
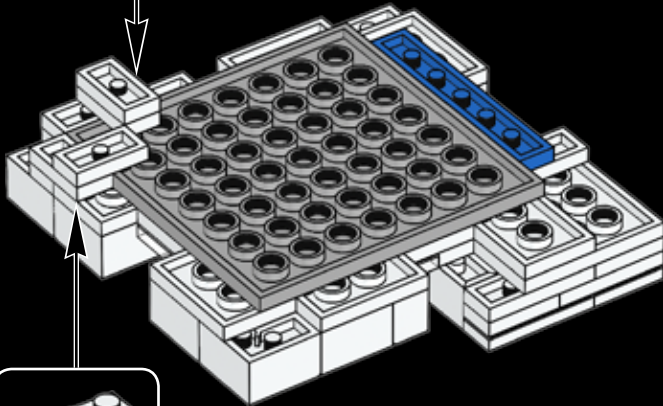
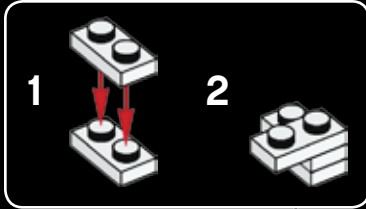

126



1x



1x



1x



1x

183

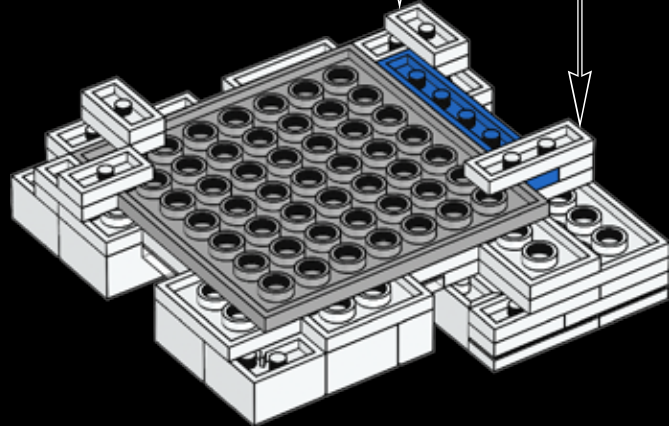
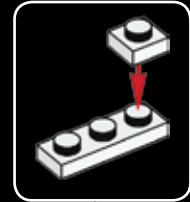
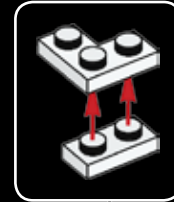



184

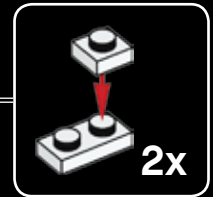
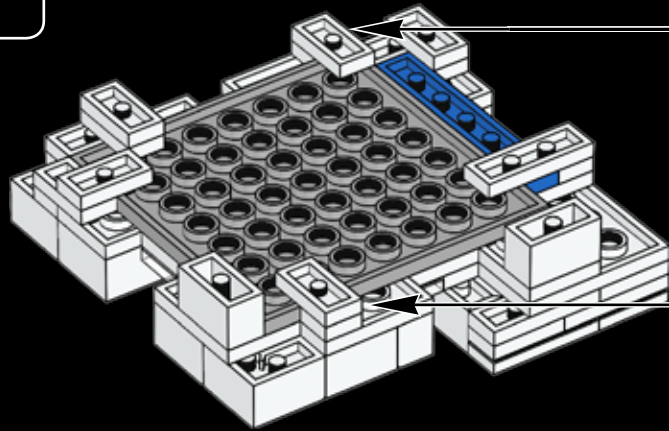

185

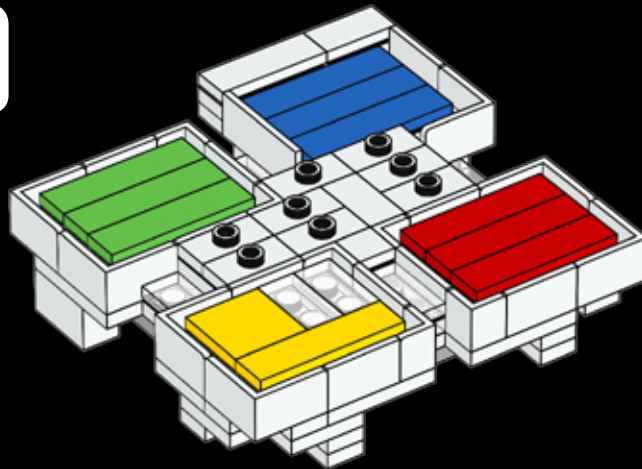

186

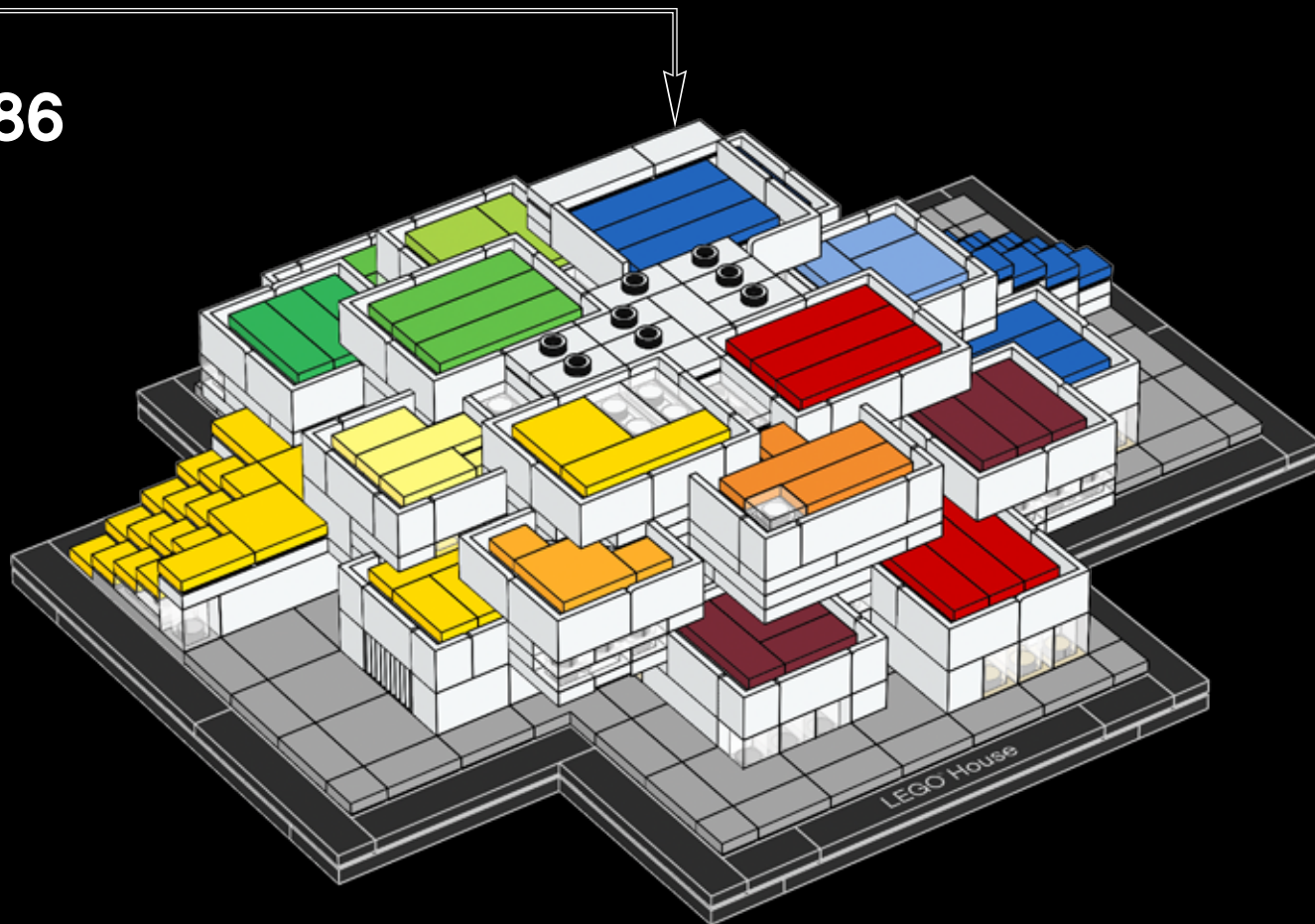

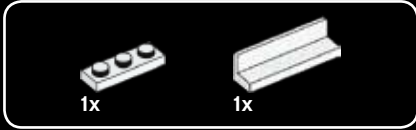

187

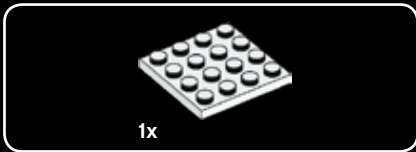
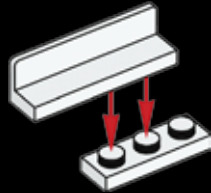

188



189



190





1x

191



2x



1x

192



1x



4x

193

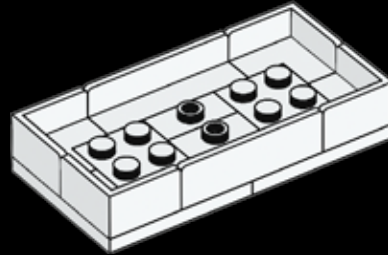

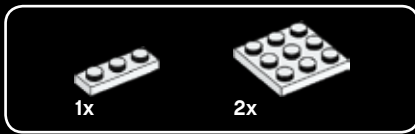

194

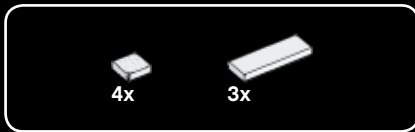
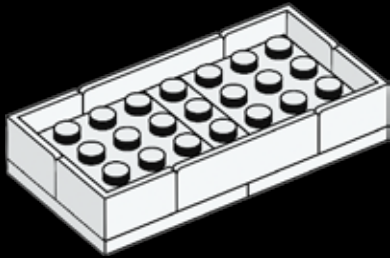

195

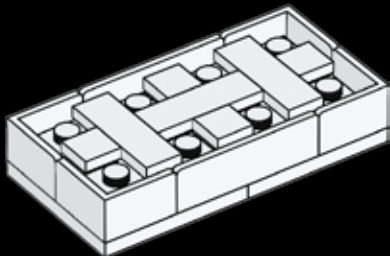

196

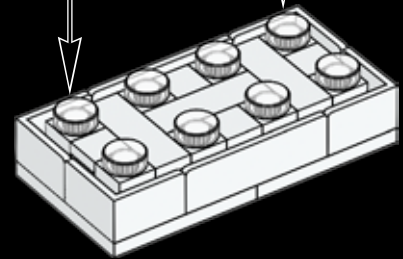
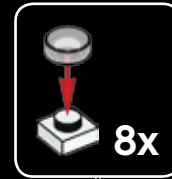

197

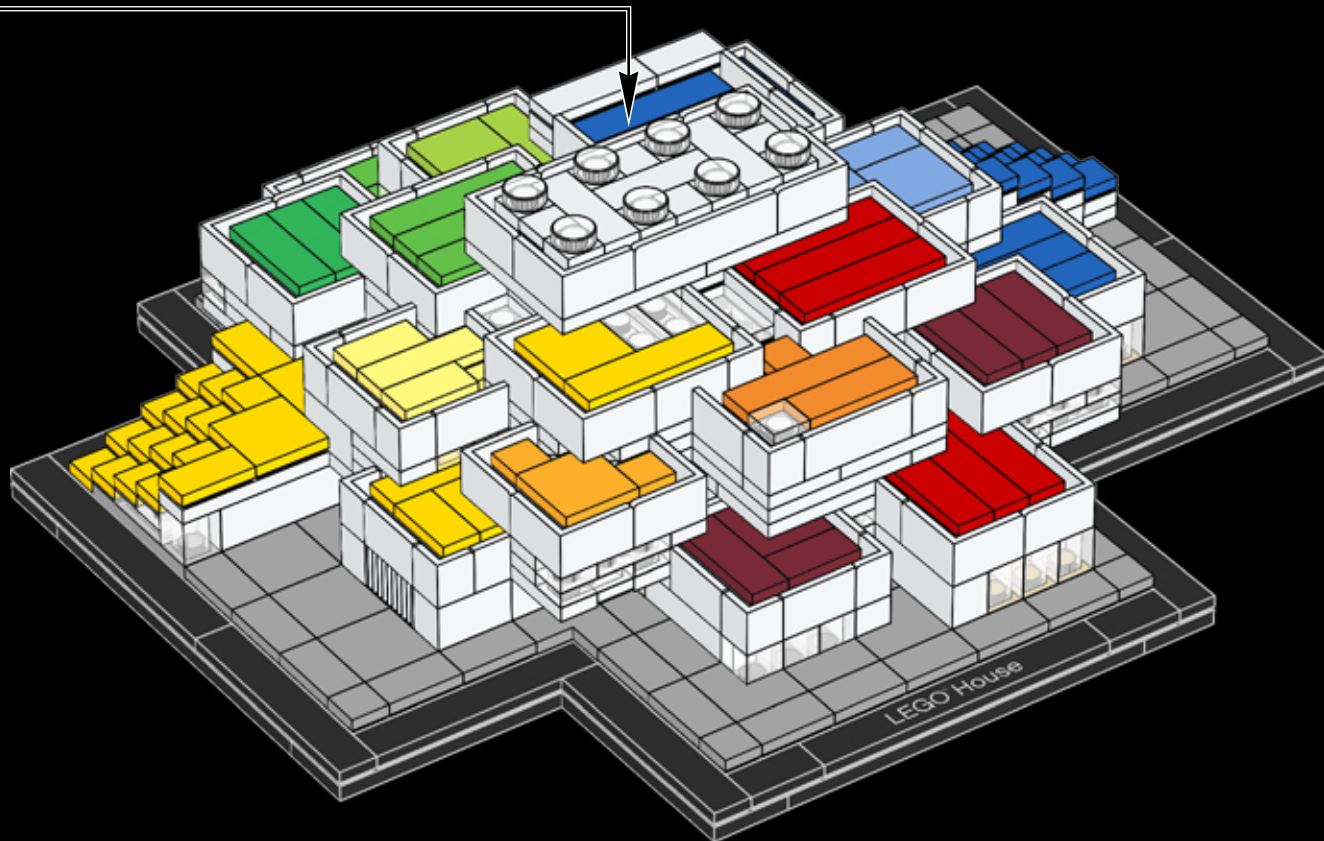

LEGO® Architecture – do you like it?

The LEGO Group would like your opinion on the new product you have just purchased. Your feedback will help shape the future development of this product series. Please visit:

[LEGO.com/productsurvey](https://www.lego.com/productsurvey)

By completing our short feedback survey, you will be automatically entered into a drawing to win a LEGO® prize.

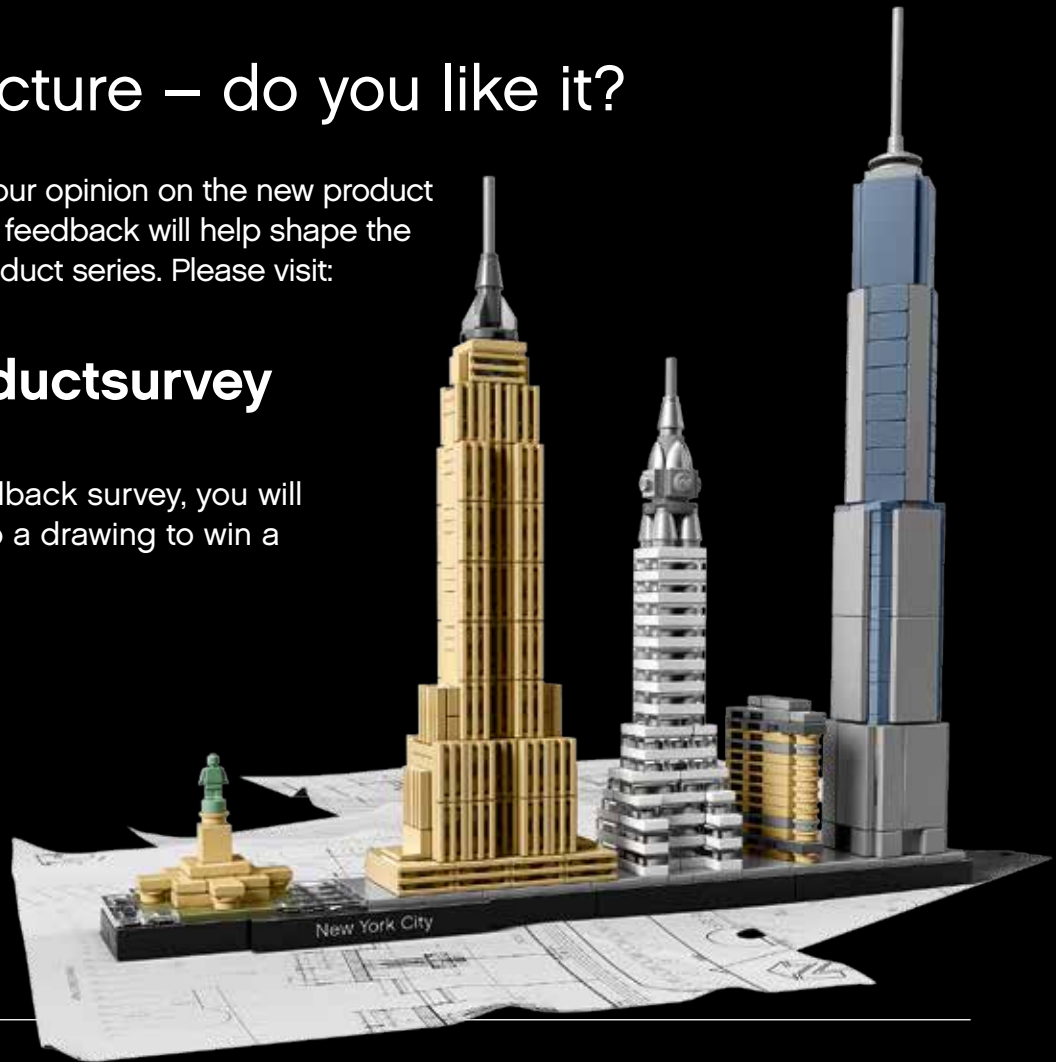

See website for official rules and details. Open to all countries where not prohibited.

LEGO and the LEGO logo are trademarks of the LEGO Group. ©2017 The LEGO Group.

LEGO® Architecture—then and now

There has always been a natural connection between the LEGO® brick and the world of architecture. Fans who build with LEGO elements instinctively develop an interest in the form and function of the structures they create. At the same time, many architects have discovered that LEGO bricks are the perfect way of physically expressing their creative ideas.

This connection was confirmed in the early 1960s with the launch of the LEGO 'Scale Model' line. It matched the spirit of the age where modern architects were redefining how houses look and people were taking an active interest in the design of their new homes. These sets were designed to be different from the normal, brightly colored LEGO boxes; they also included a book on architecture as a source of inspiration.

Decades later, architect and LEGO fan Adam Reed Tucker, revived the idea of expressing architecture using LEGO bricks and in partnership with the LEGO Group, launched the LEGO Architecture line that we know today.

His first models, and the original sets in the current LEGO Architecture series, were interpretations of famous skyscrapers from his hometown of Chicago. Since then LEGO Architecture has developed and evolved, first with well-known buildings from other cities in the United States, and now with iconic structures from Europe, the Middle East and Asia.

The introduction of our LEGO Architecture Studio set echoes the ambitions of the earlier LEGO 'Scale Model' line and widens the potential of the LEGO Architecture series. Now you can enjoy building and learning about specific landmark buildings, or create exciting architectural models from your own fantasy. An inspiring 270-page book, featuring a number of renowned architects from around the world, guides you through the principles of architecture and encourages you in your own creative building.



21050
Studio

References

Text credits:

LEGO® House

BIG – Bjarke Ingels Group

Photo credits:

LEGO House

BIG – Bjarke Ingels Group

For further information please visit:

LEGOHouse.com

Customer Service
Kundenservice
Service Consommateurs
Servicio Al Consumidor
LEGO.com/service or dial

 00800 5346 5555:
 1-800-422-5346:

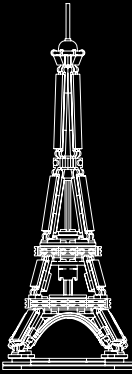

Celebrate the world of architecture and collect all the models

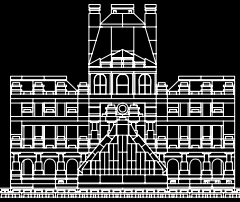

21019
The Eiffel Tower

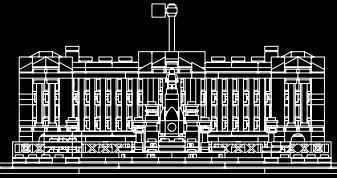

21024
Louvre



21029
Buckingham Palace

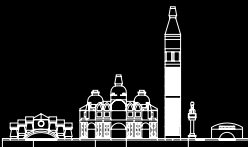

21026
Venice



21027
Berlin



21028
New York City

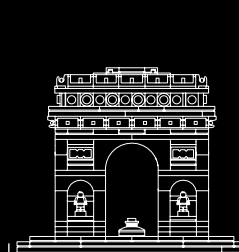

21036
Arc de Triomphe

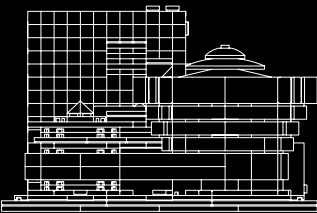

21035
Solomon R. Guggenheim Museum®

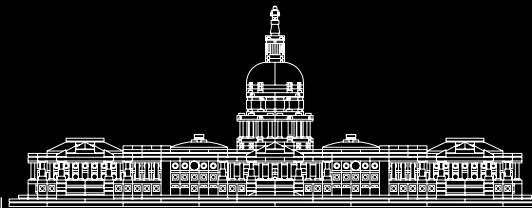

21030
United States Capitol Building

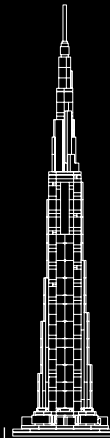

21031
Burj Khalifa

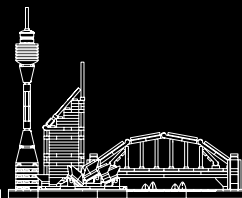

21032
Sydney

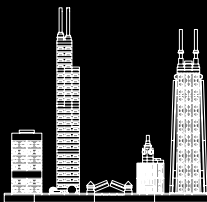

21033
Chicago

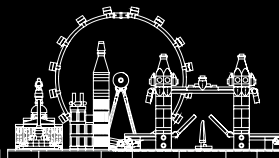

21034
London



Customer Service

Kundenservice

Service Consommateurs

Servicio Al Consumidor

LEGO.com/service or dial



: 00800 5346 5555

: 1-800-422-5346

