



Architecture

21047

Las Vegas

USA



Booklet available in English on
Heft in deutscher Sprache erhältlich auf
Livret disponible en français sur
Libretto disponibile in italiano su

Folleto disponibile en español en
Folheto disponível em português em
A fűzet magyarul ezen a honlapon olvasható:
如需中文版手册, 请访问



[LEGO.com/architecture/booklet](https://www.lego.com/architecture/booklet)

Welcome to Fabulous Las Vegas

Stretching out over the desert floor, the City of Las Vegas boasts some of the most jaw-dropping architecture in the United States. What started as a small, isolated railroad town in 1905, is now the fastest growing city in the country and one of the most visited tourist destinations in the world.

For much of its history, Las Vegas created its own identity as a city by borrowing from everyone else's. Walk along the famous Las Vegas Strip and you'll see New York skyscrapers, the canals of Venice and even a version of the Eiffel Tower.

The city's architecture often stretches the bounds of the imagination and structural engineering. Constantly making things bigger, better, higher or longer is what drives Las Vegas forwards and what continues to create one of the world's most vibrant skylines.

*"So much of Las Vegas falls
under the heading "it has to be
seen to be believed."*

Jeff Maguire





*"Las Vegas is the only place
I know where money really talks
– it says, Goodbye."*

Frank Sinatra

Welcome to Fabulous Las Vegas Sign

The classic 25 ft. (7.6 m) tall "Welcome to Fabulous Las Vegas" sign has stood at 5200 Las Vegas Boulevard since 1959. It was created by Betty Willis, who set out to design a roadside sign that was unique in its shape, style and content. Willis chose not to copyright her iconic work, instead seeing it as her gift to the city.

The sign is currently owned by the Young Electric Sign Company, who leases it to Clark County. Technically the sign isn't actually in Las Vegas; instead it stands approx. 4 miles (6.5 km) south of the city limits, in the town officially known as Paradise.







*"Everything and anything you want to do,
you can do in Las Vegas"*

Drew Carey



Bellagio Hotel, LLC

Inspired by the Lake Como town of Bellagio in Italy, Bellagio is one of the largest and most elegant resorts on the Las Vegas Strip. Completed in 1998 at a cost of \$1.6 billion, it has 3,933 guest rooms, including 512 suites, and a 100,000 ft² (9290 m²) gaming area. Guests entering the lobby are met by the stunning Fiori Di Como (Flowers of Como) sculpture, made up of over 2,000 hand-blown glass flowers that hang from the ceiling.

The Bellagio's most renowned feature is the 8-acre (3.2 hectare) lake, situated between the building and the Strip itself. Home to the spectacular Fountains of Bellagio, thousands of visitors to Las Vegas gather every evening to enjoy the graceful ballet of dancing fountains choreographed to music and lights.



Luxor Las Vegas

The spectacular Luxor Las Vegas is the 30-story, 120,000 ft² (11,000 m²) resort that brings the wonders of ancient Egypt to the ultra-modern Las Vegas. When it opened in October 1993, its iconic pyramid was the tallest building on the Strip and included a Nile River ride that encircled the casino and carried guests past re-created ancient Egyptian artwork.

Out of the top of the pyramid, the famous Luxor Sky Beam shoots the world's strongest beam of light up into the air. On a clear night it is said the beam can be seen 275 miles (443 km) away by aircraft cruising above Los Angeles airport.







Encore at the Wynn

Originally envisioned as an extension to the neighboring Wynn Las Vegas, the Encore instead became a full-blown resort and was completed at the end of 2008, at a cost of \$2.3 billion. The 631 ft. (192 m) tall and 93 ft. (28 m) wide structure features 2,034 hotel rooms, a 74,000 ft² (6,900 m²) casino and 27,000 ft² (2,500 m²) of convention space.

Though it officially has 63 floors, in reality there are only 48 floors in the building, as certain floor numbers have been omitted. The number 13 has traditionally been seen as unlucky in various Western cultures, while many Asian cultures are superstitious about the number 4.

“A little bit of this town goes a very long way”

Hunter S. Thompson



Stratosphere Las Vegas

At 1149 ft. (350 m), the Stratosphere is the tallest freestanding observation tower in the United States. It's also the tallest structure in Las Vegas and home to one of the most incredible views of the city. It has two observation decks, a revolving restaurant and four thrill rides that let visitors dangle, spin and plummet high above the city at 855 ft. (261 m).

Bob Stupak, previous owner and entrepreneur who built the Stratosphere, claimed the tower would “do for Las Vegas what the Eiffel Tower did for Paris.”

“Las Vegas is a city built on hopes, dreams, and a little bit of crazy.”

Michael McDonald



Fremont Street

Fremont Street is where Las Vegas as we know it today began; it is home to the original Vegas Strip, as well as where the first street was paved in 1925 and where the city's first traffic light was erected in 1931. As the city grew, Fremont Street was the place to see and be seen, featuring Las Vegas' legendary entertainers, best-known establishments and iconic neon signs. By the late 1980s, the street and surrounding neighborhood found itself in fierce competition with the growth and expansion of the newer casinos on Las Vegas Boulevard.

In response, Fremont Street was revitalized by the development of the Fremont Street Experience, transforming the five-block area into a dazzling entertainment district. The centerpiece of the experience is the 1,500 ft. (457 m) long and 90 ft. (27.4 m) wide video screen canopy suspended 90 ft. (27.4 m) above the pedestrian mall below delivering a spectacular audio-visual show every hour in the evening.

"Las Vegas is the boiling pot of entertainment."

Don Rickles





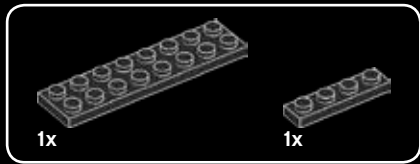

1

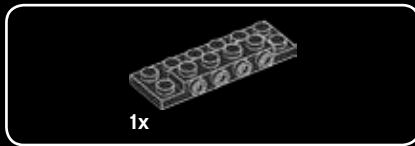
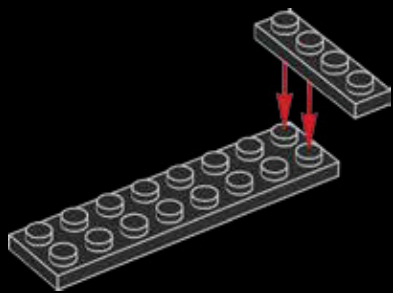

2

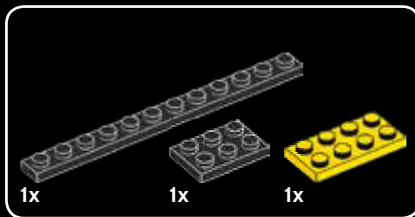
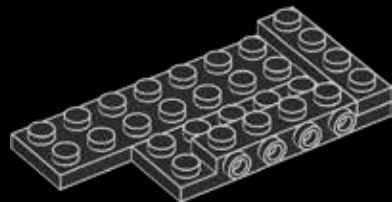

3

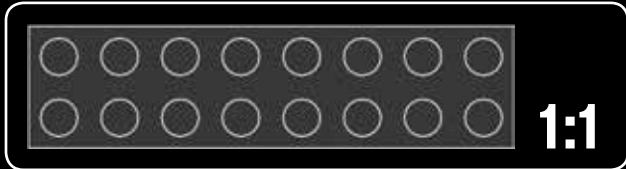
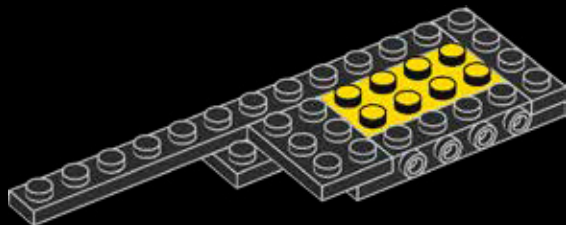



4

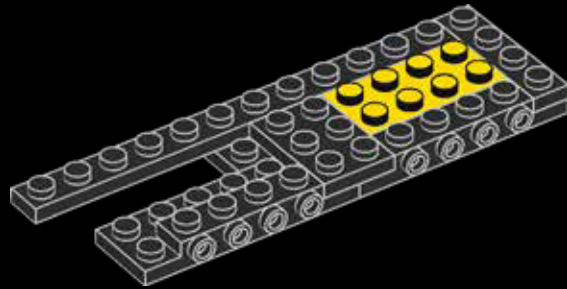

5

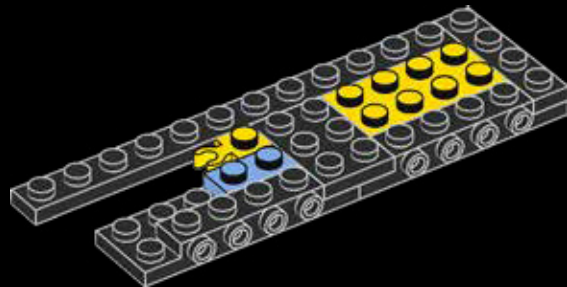

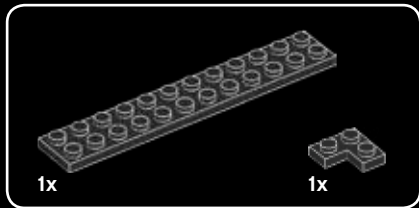

6

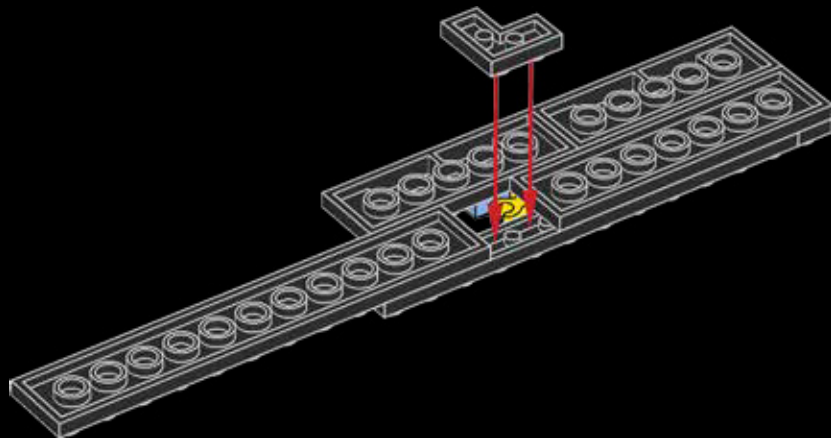

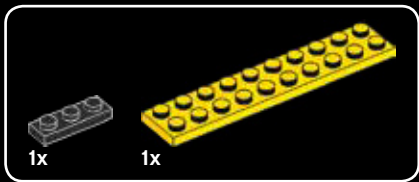

7

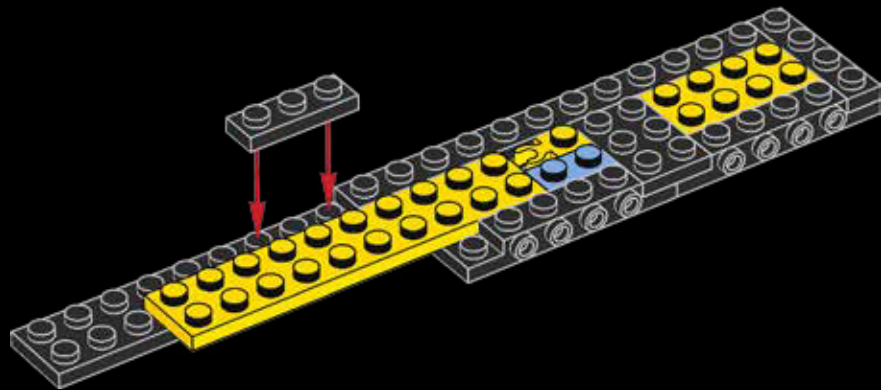
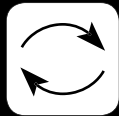

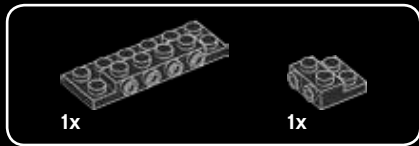

8

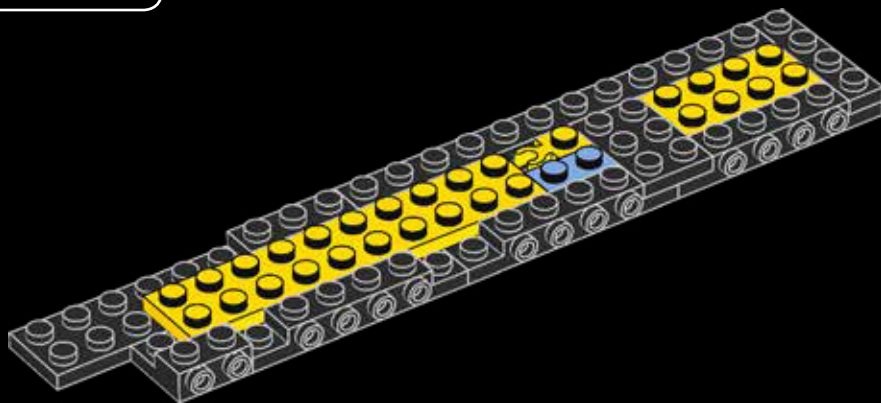

9

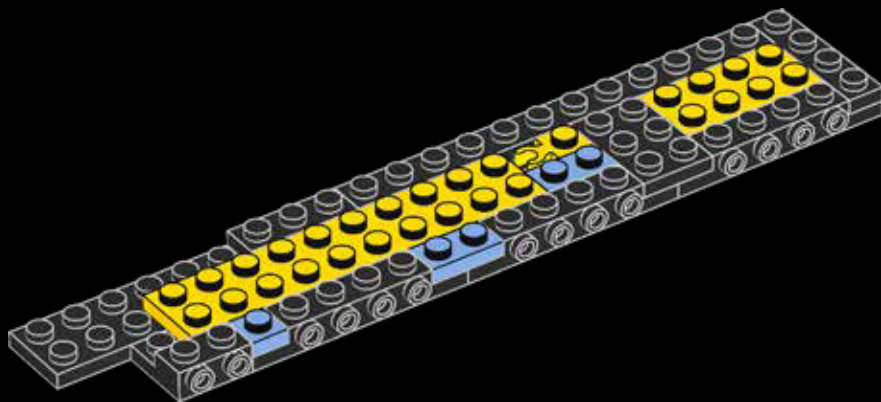

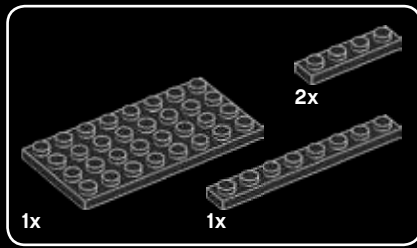

10

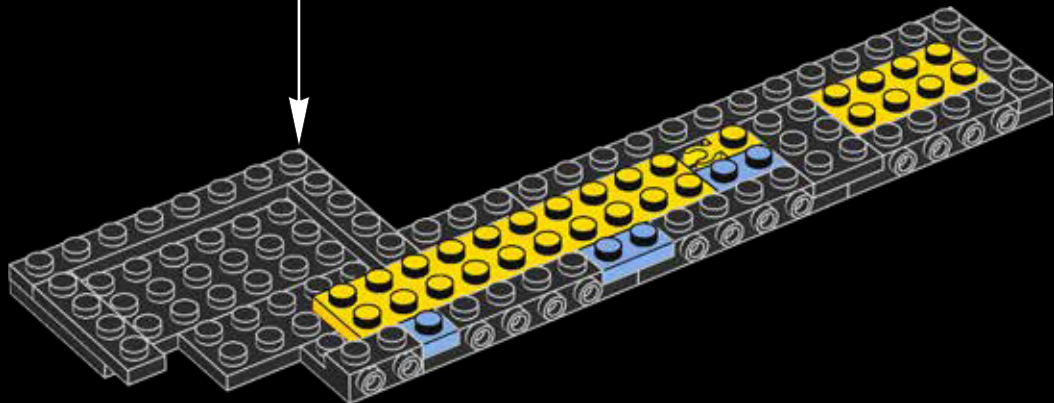
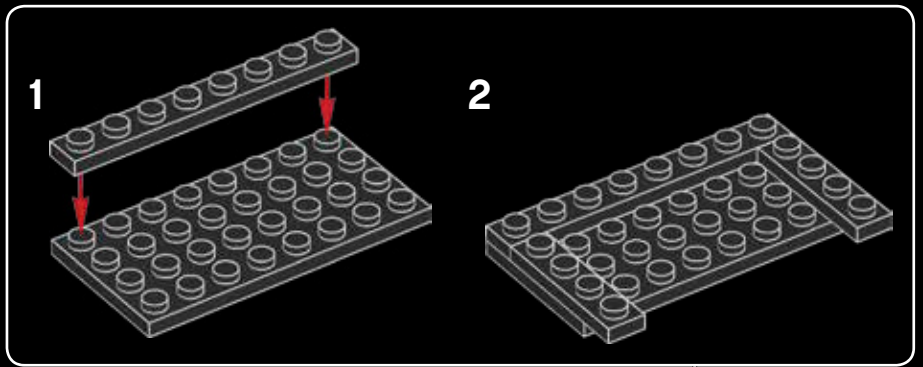

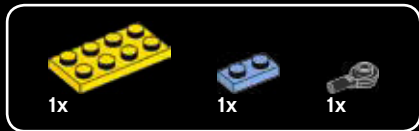

11

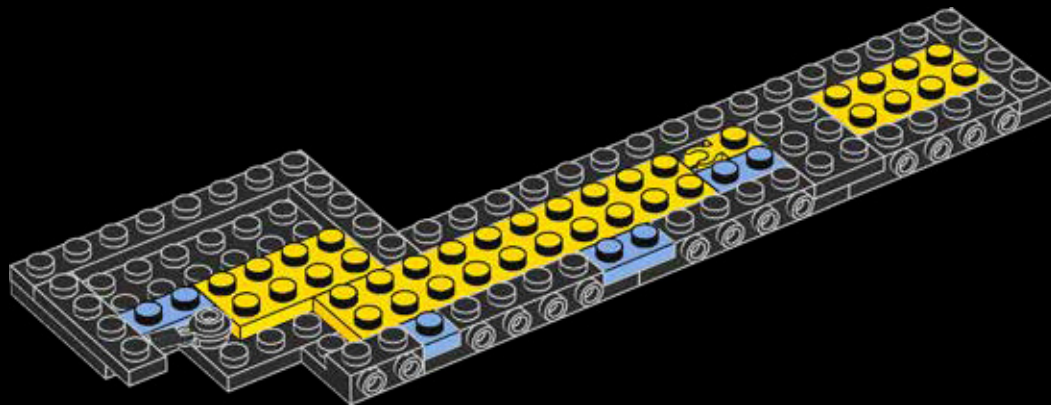
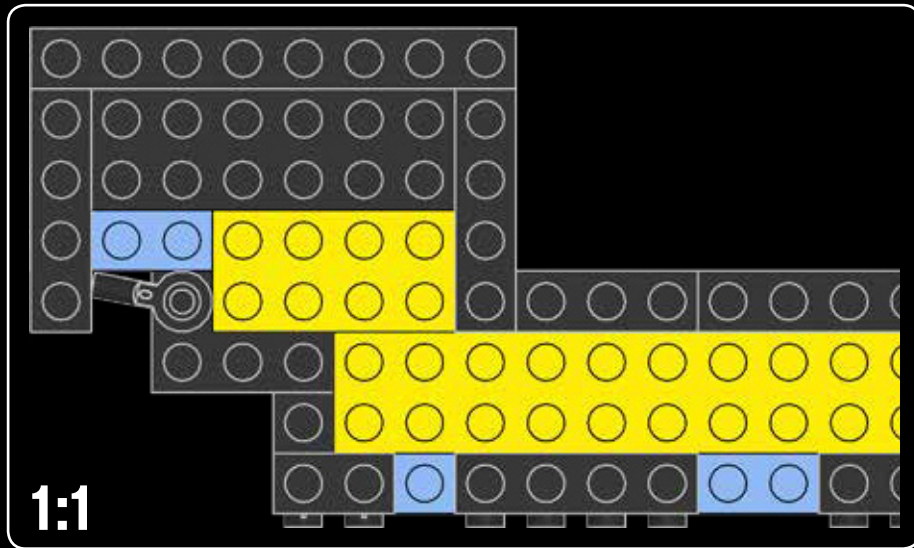

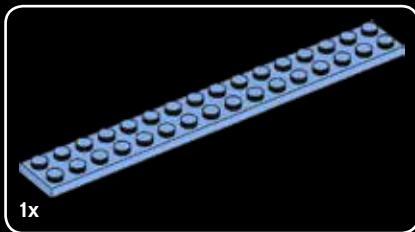

12

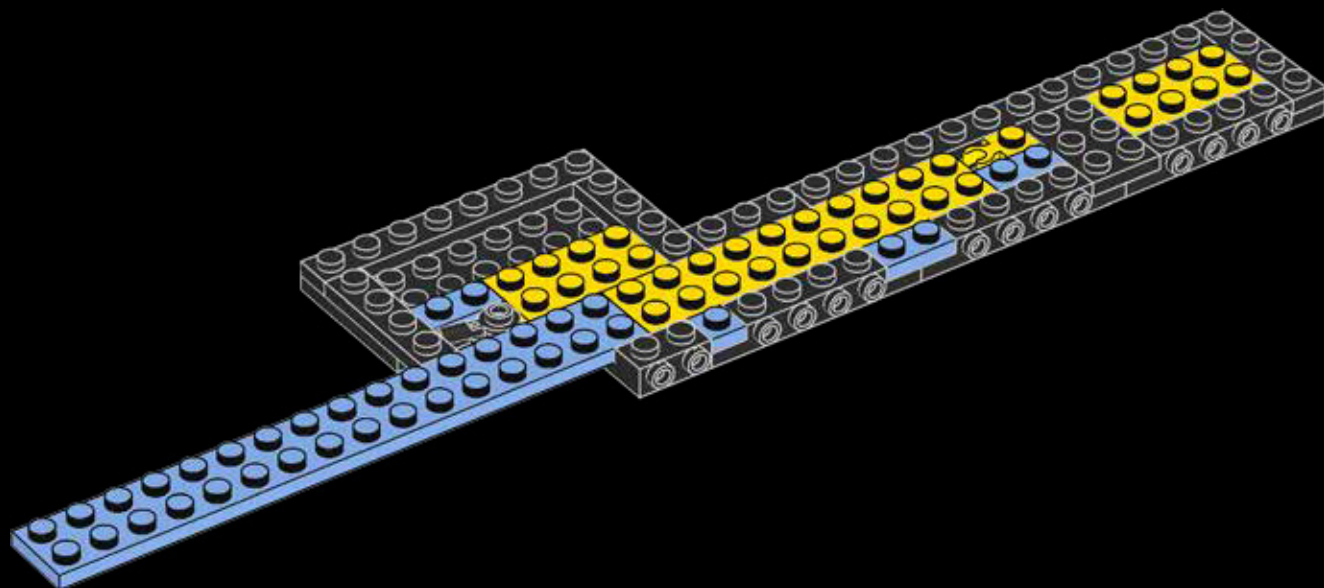



13

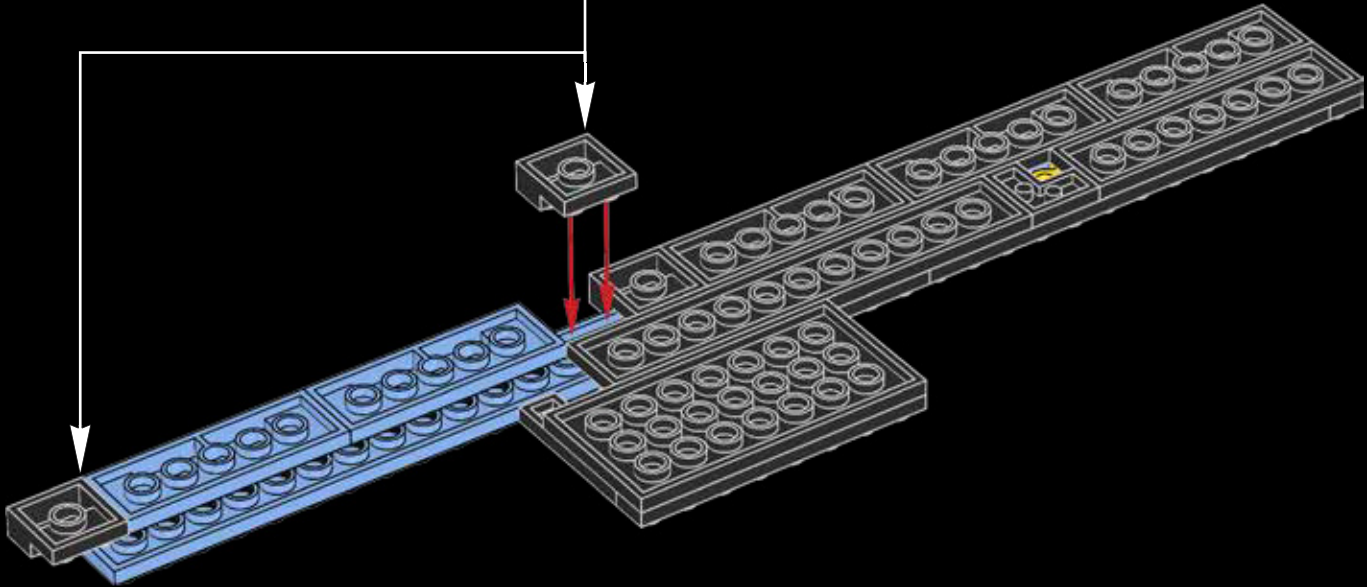
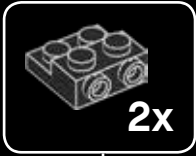

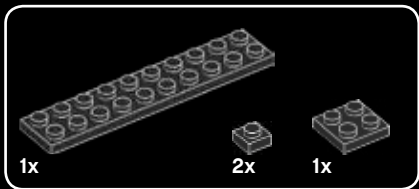

14

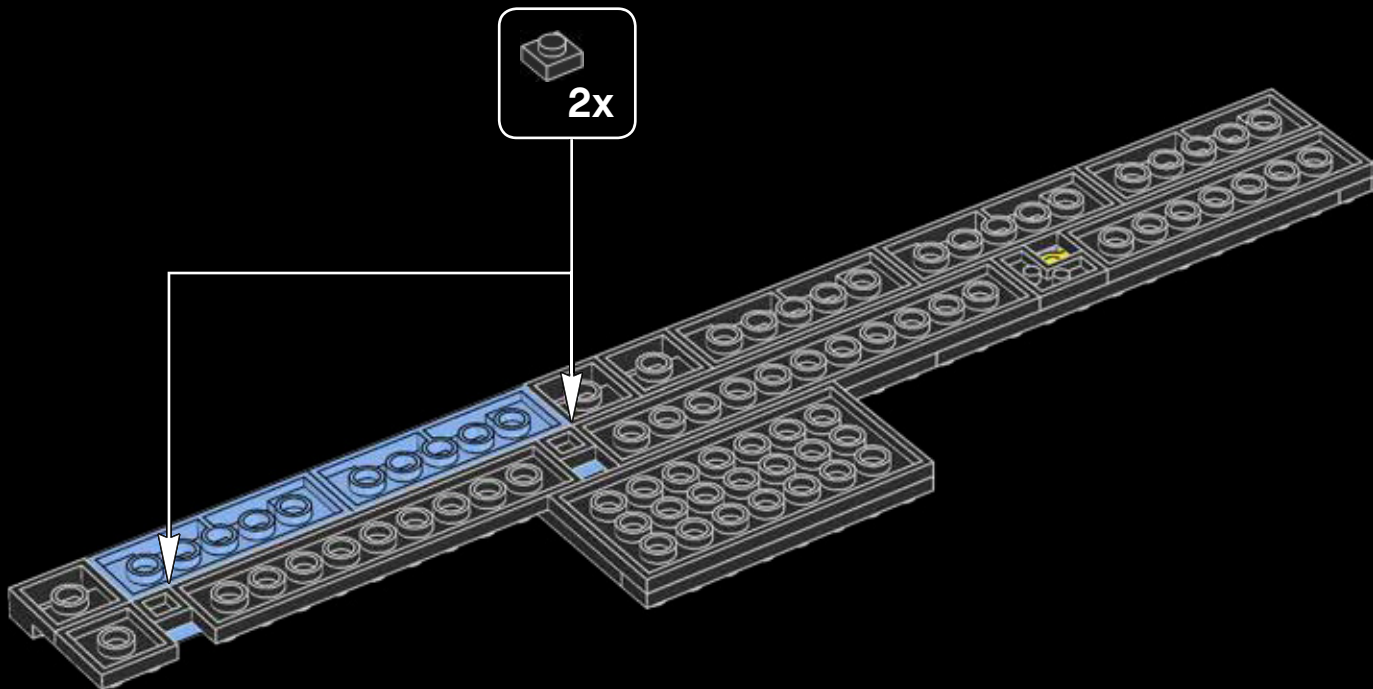



15

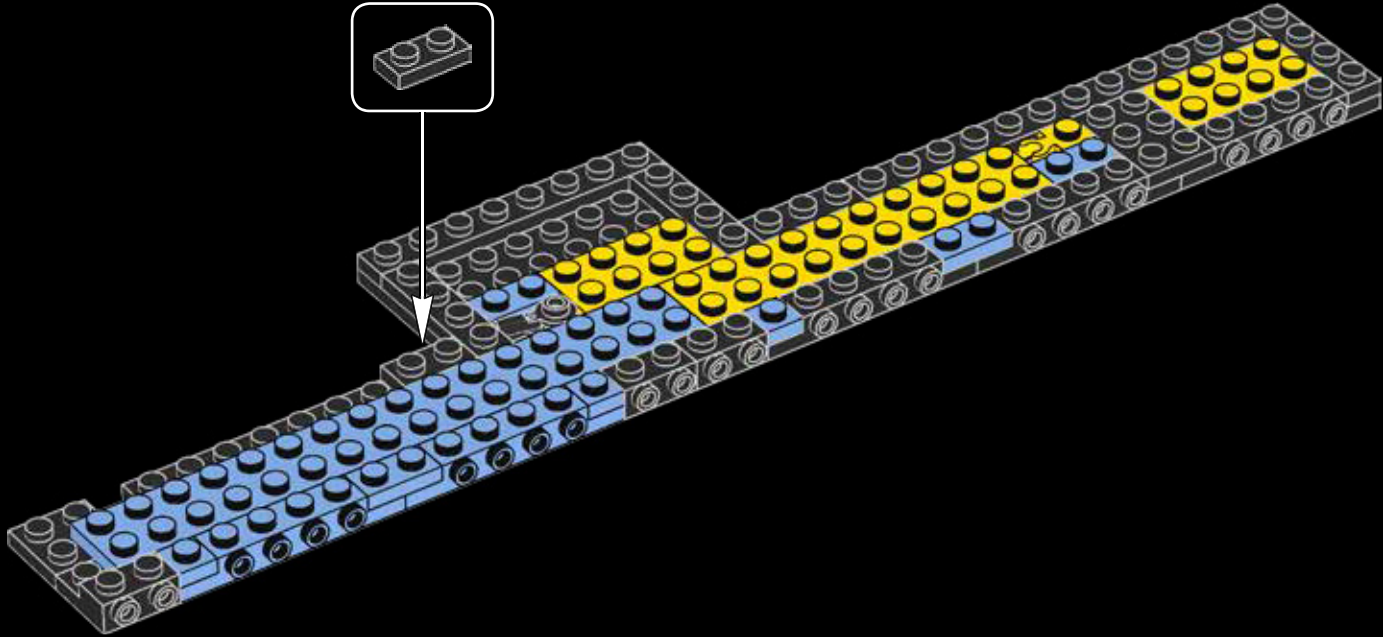



16

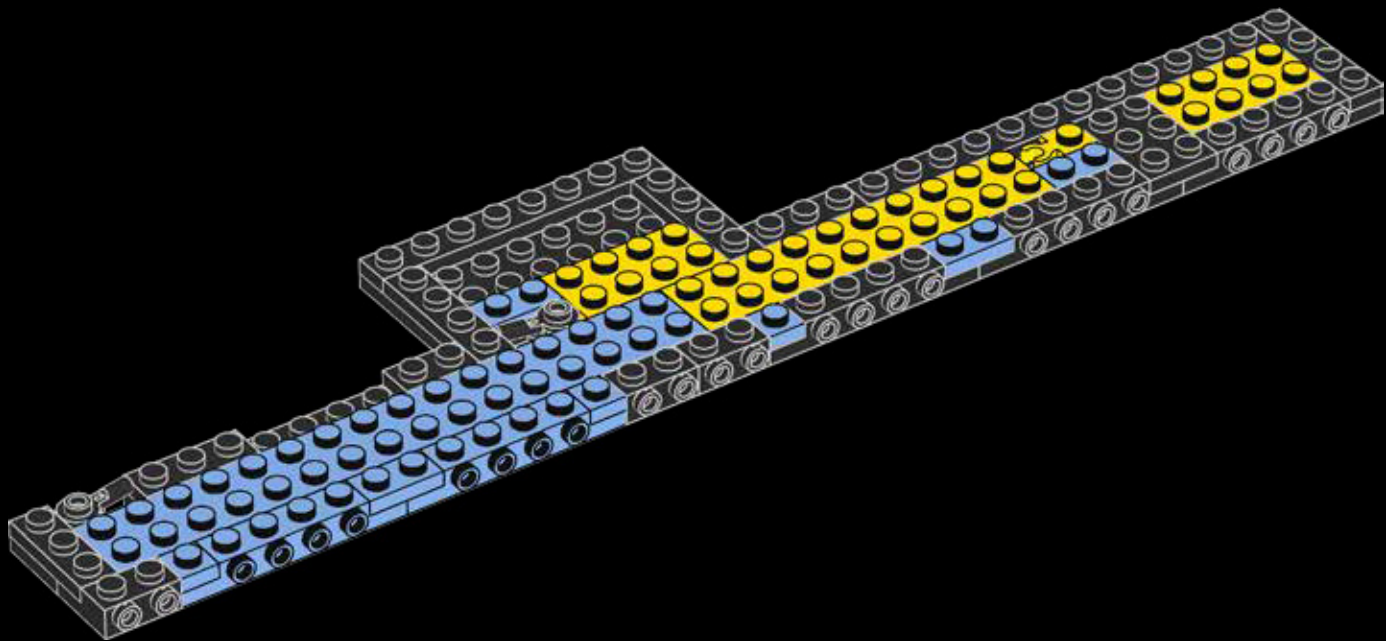
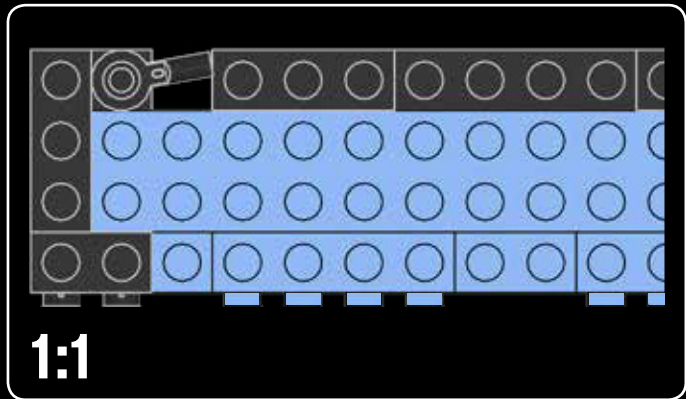

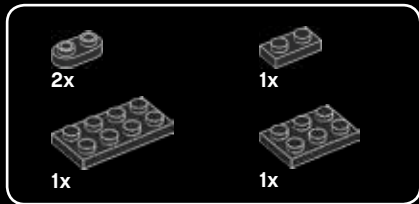

17

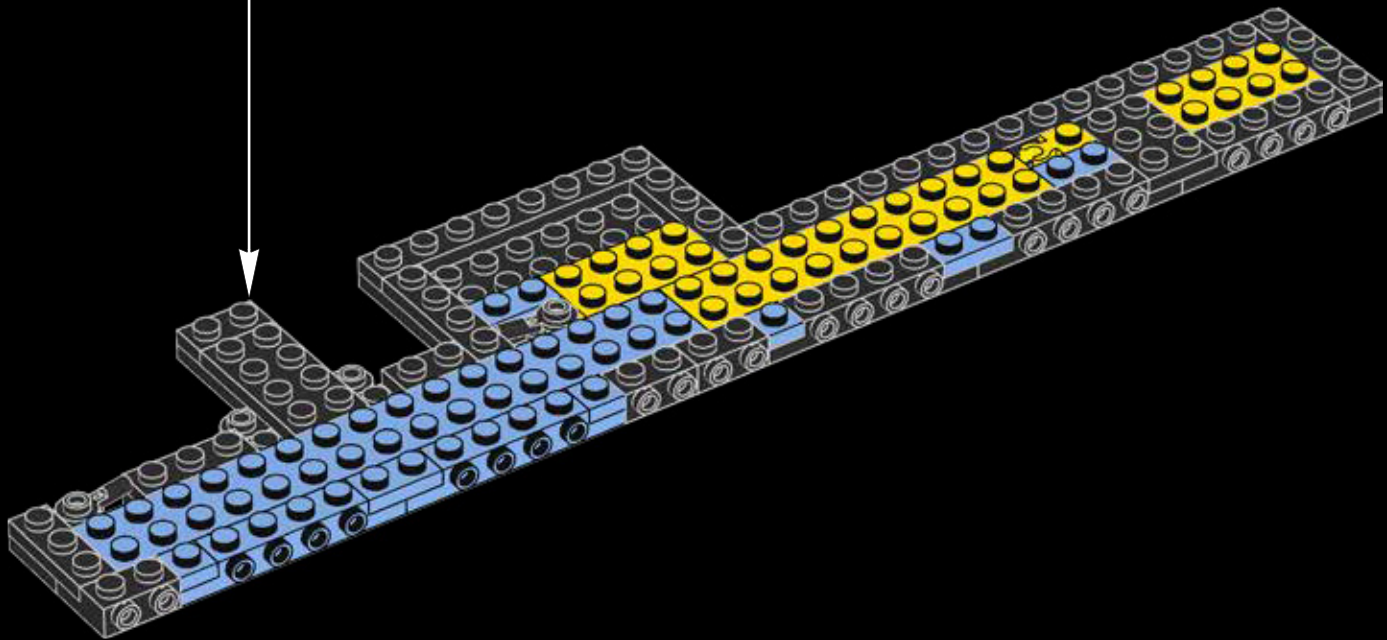
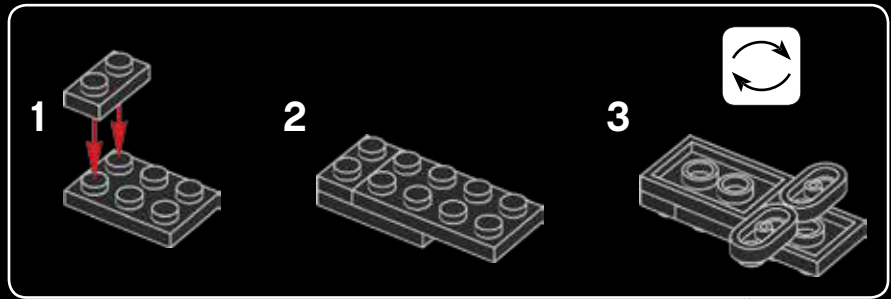



18

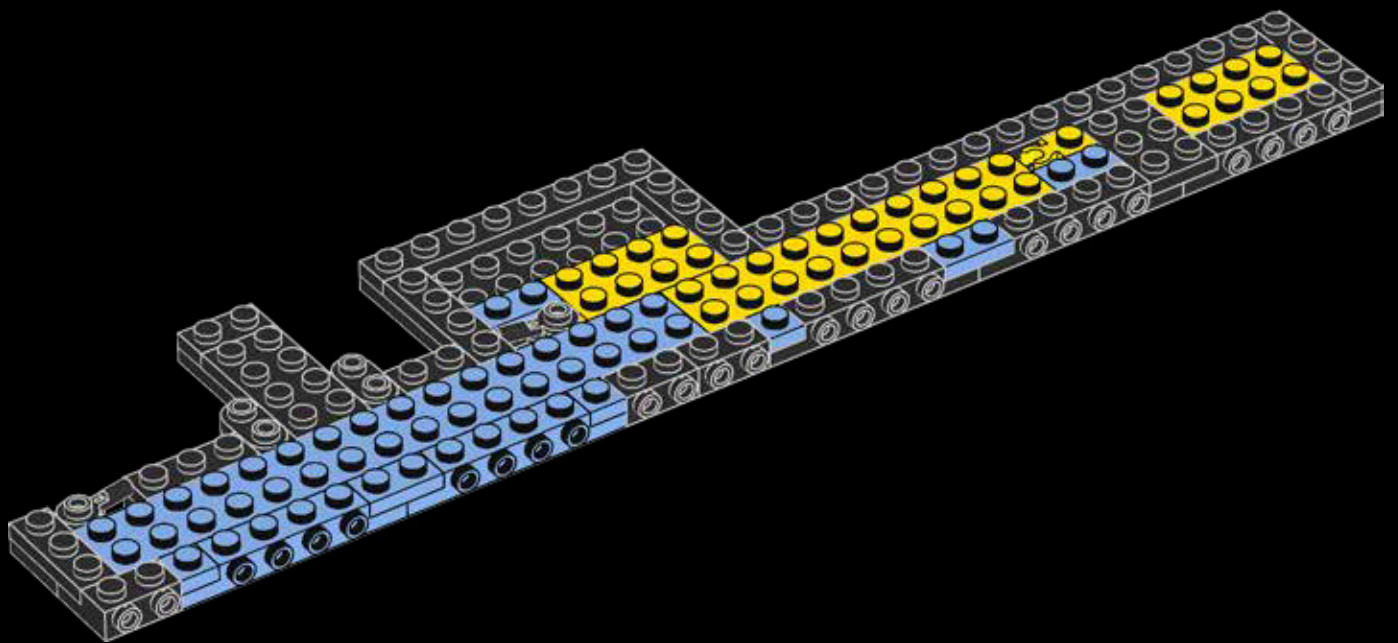

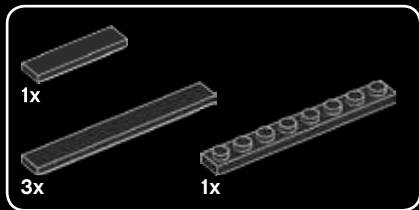

19

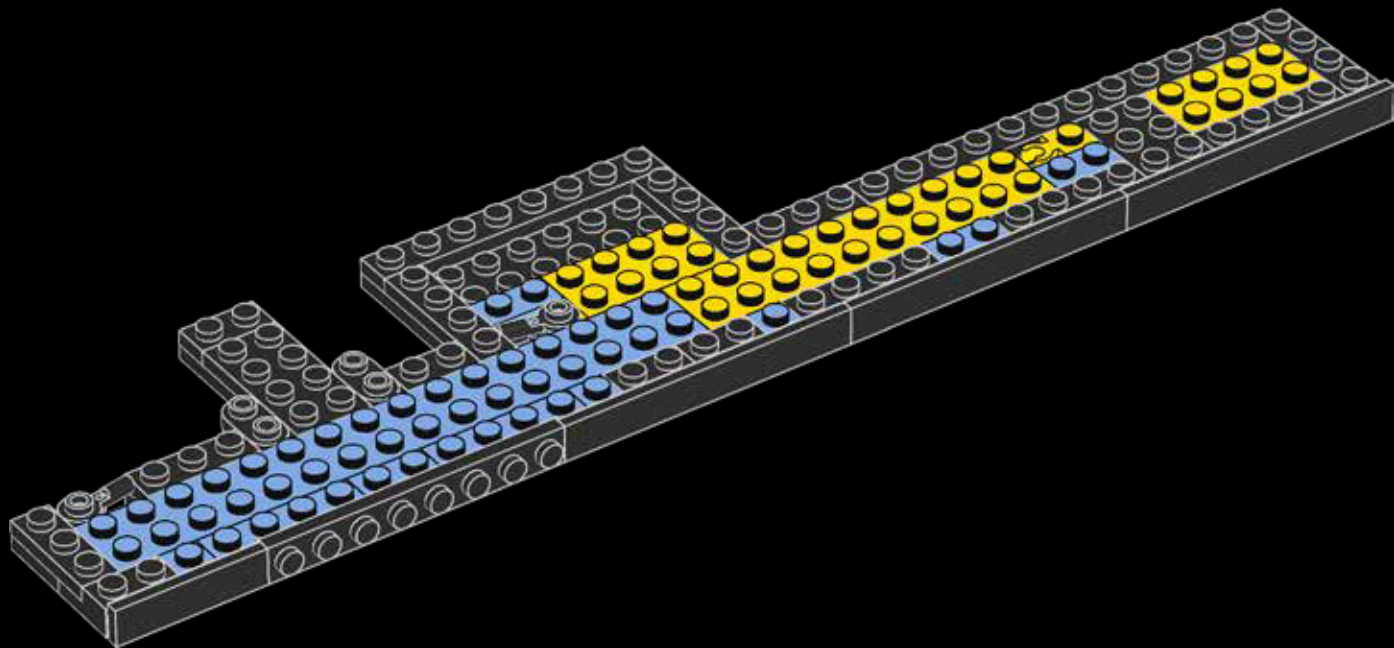

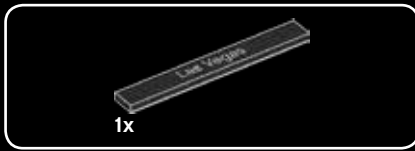

20

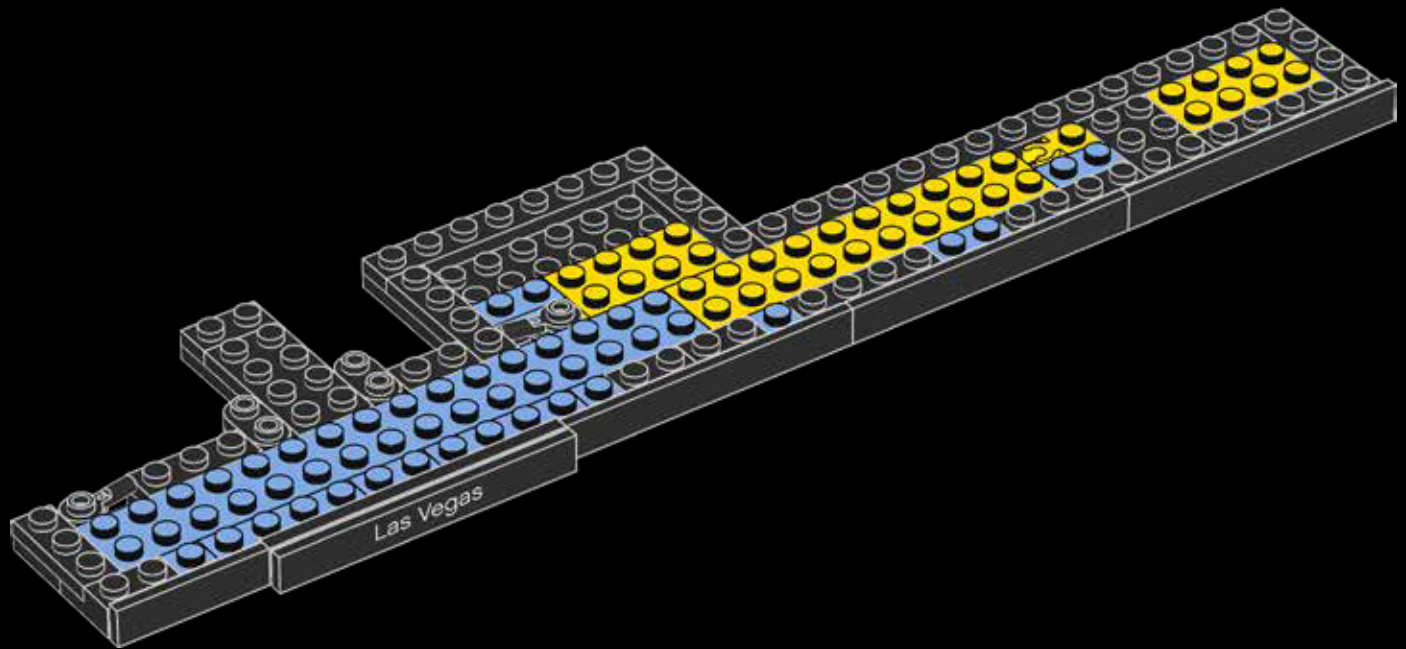

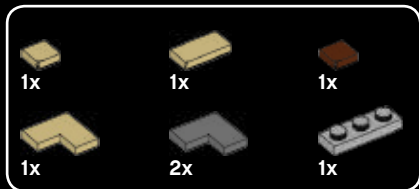

21

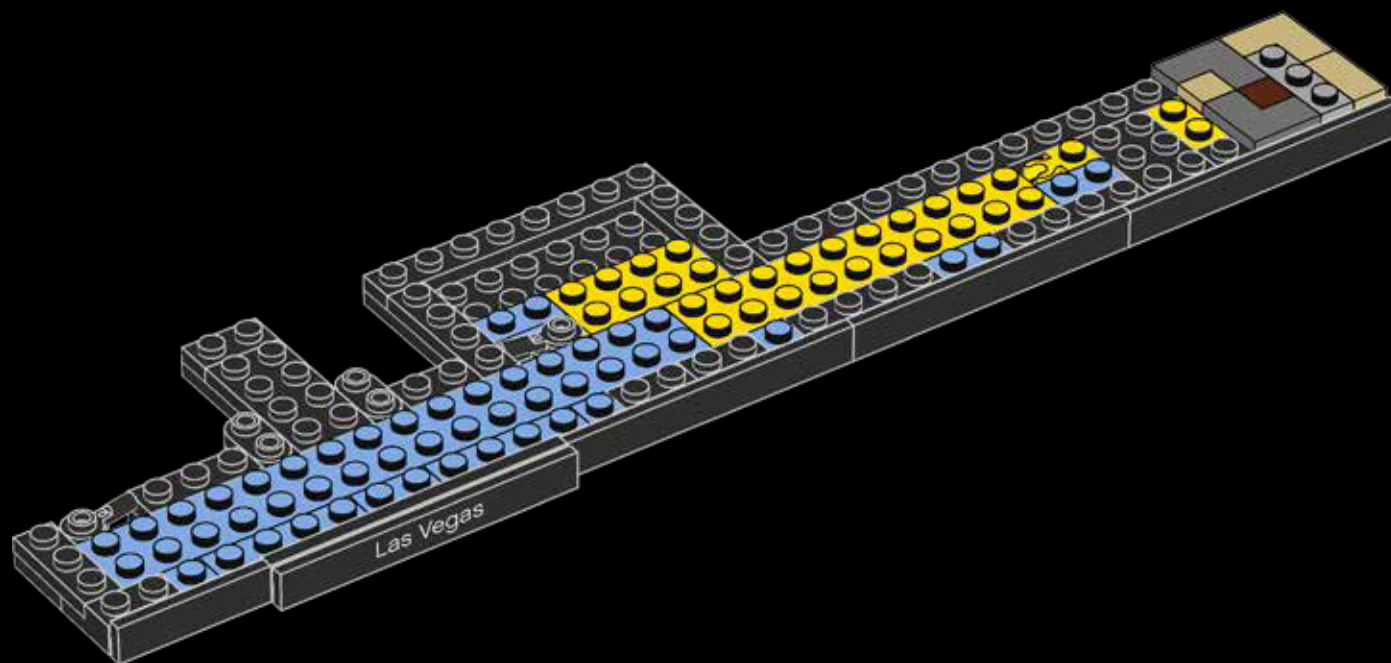

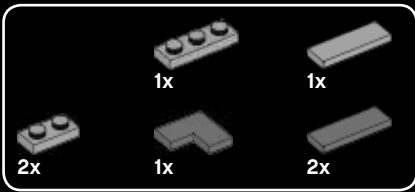

22

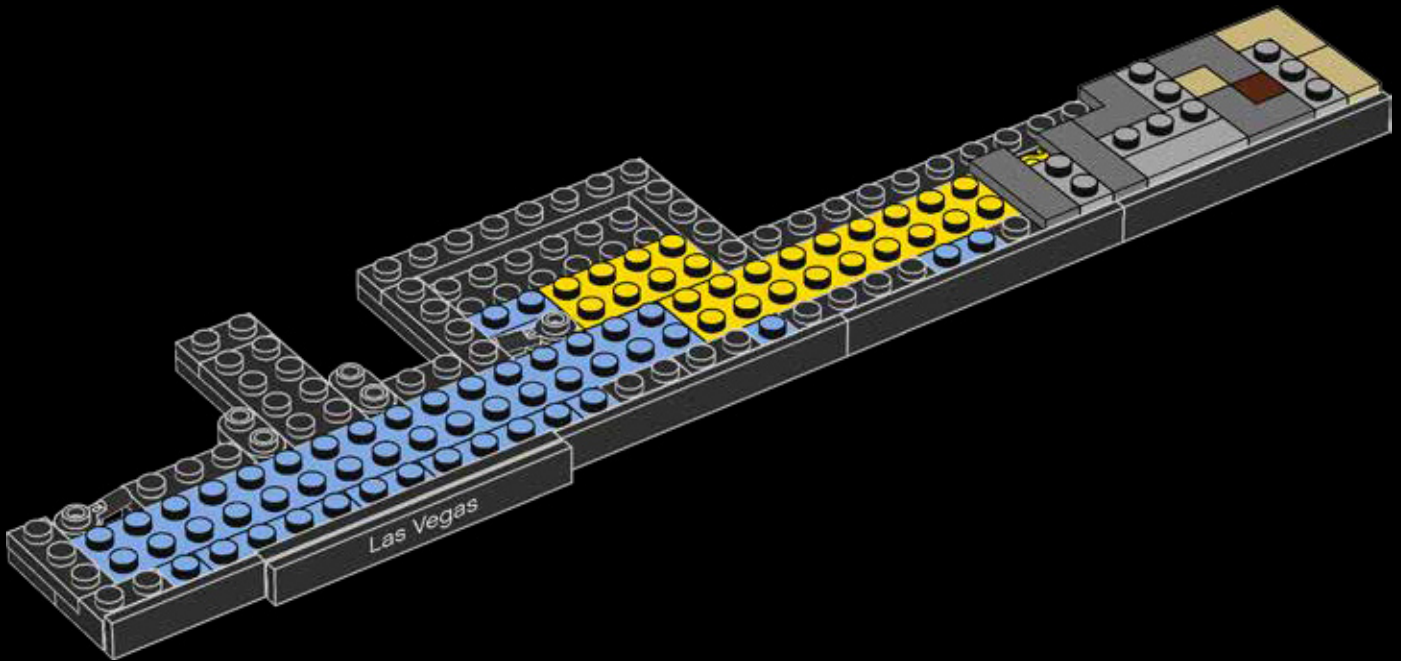

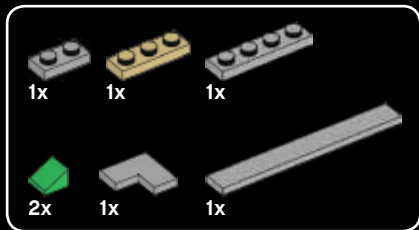

23

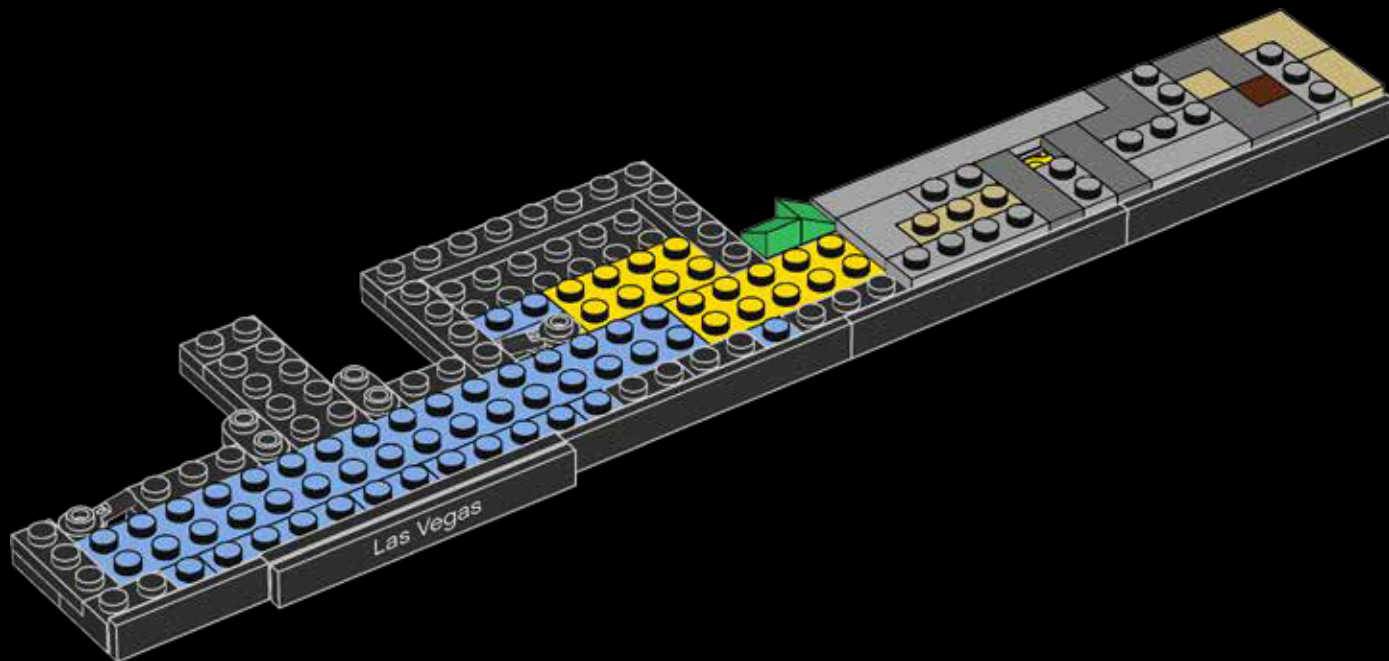



24

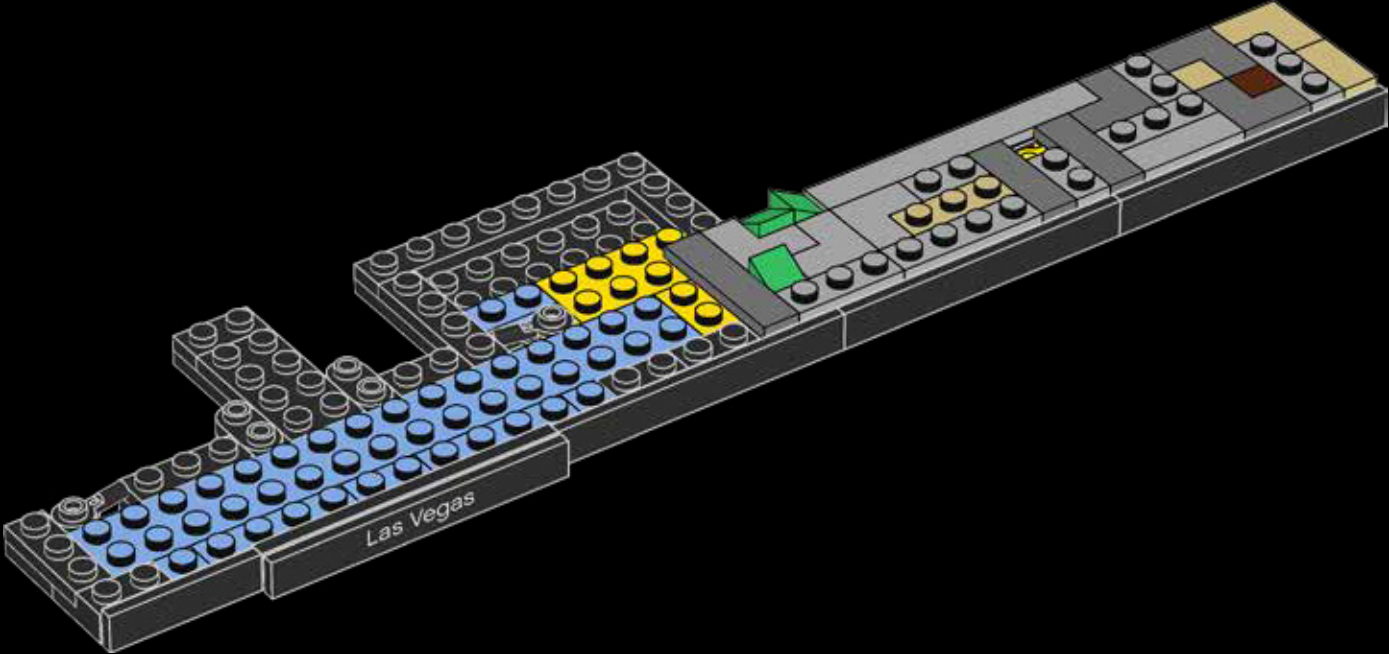

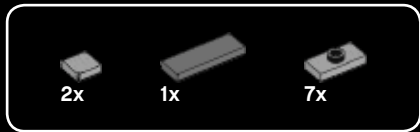

25

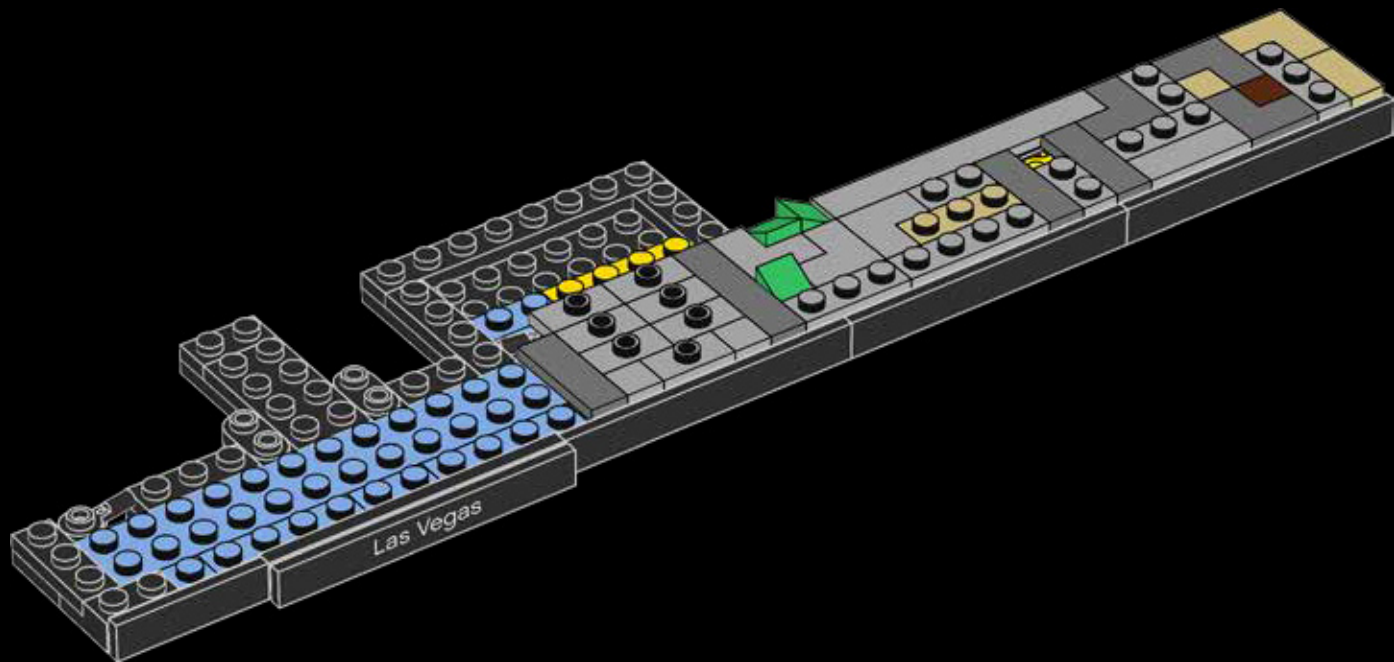



26

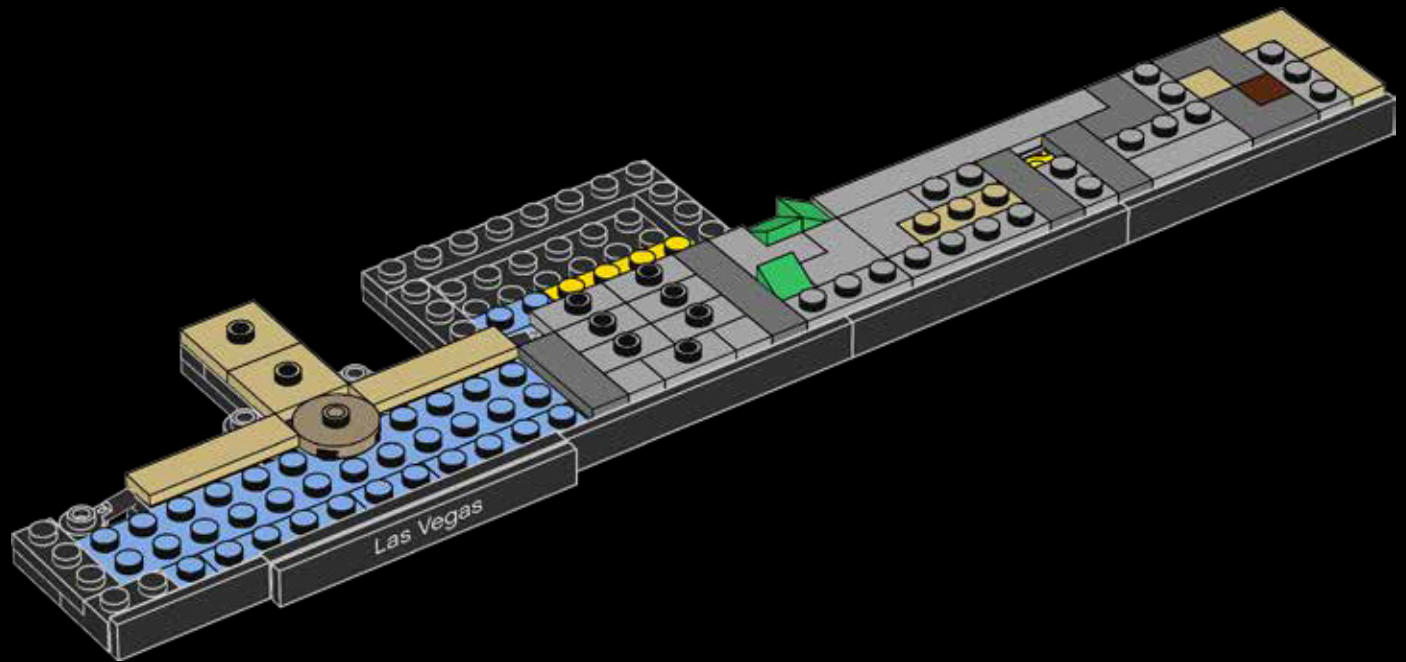



10x



4x

27

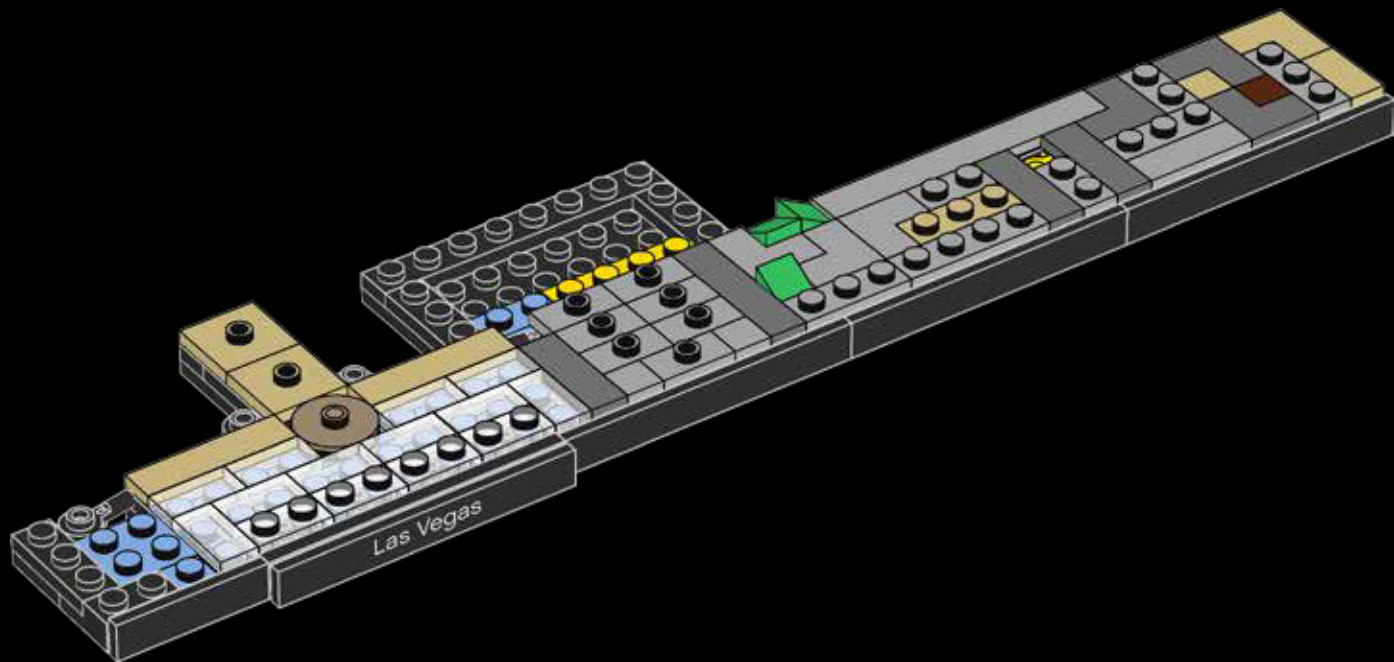



28

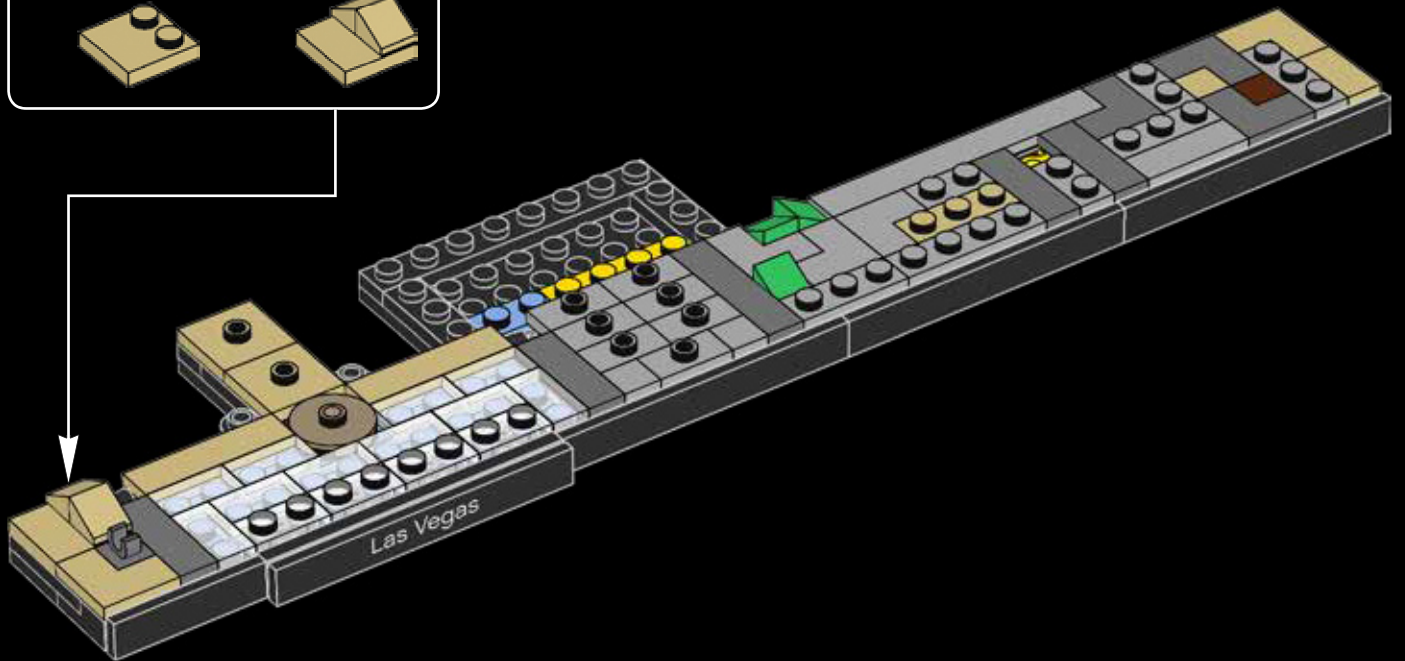
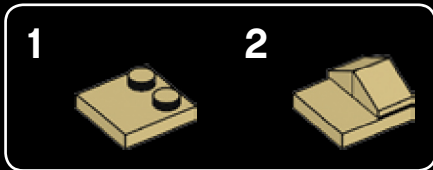



29

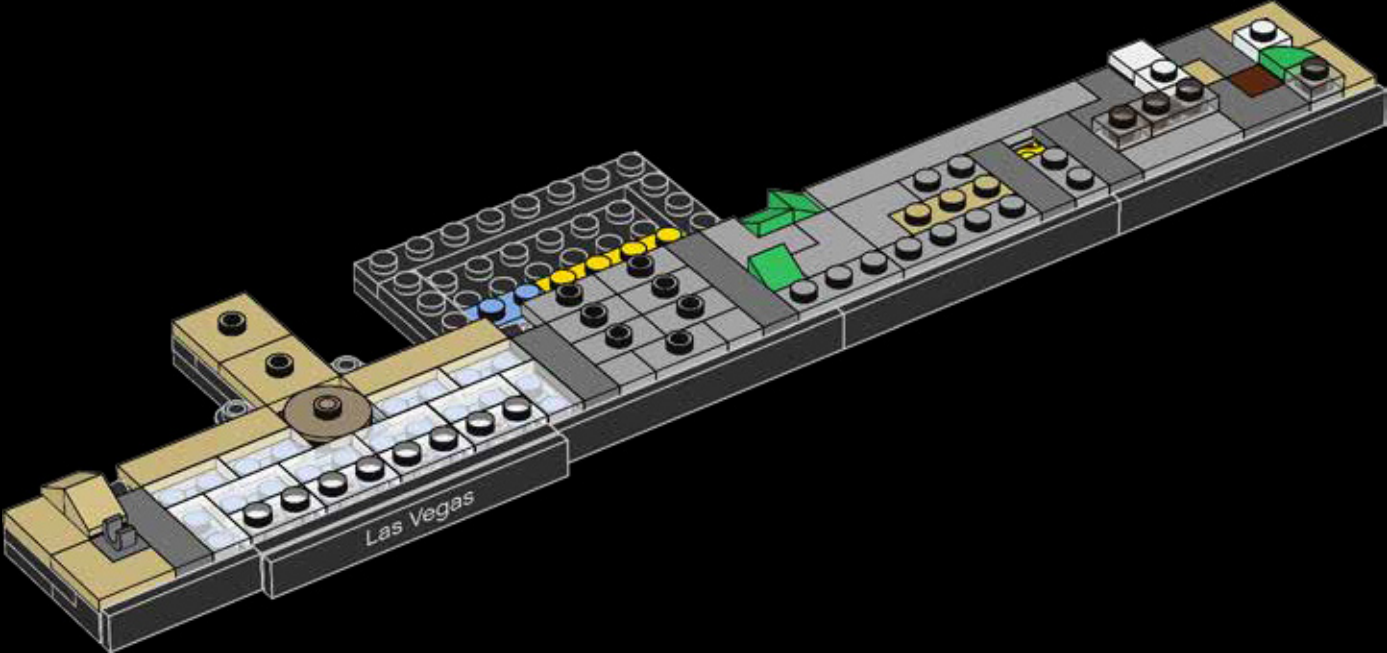



30

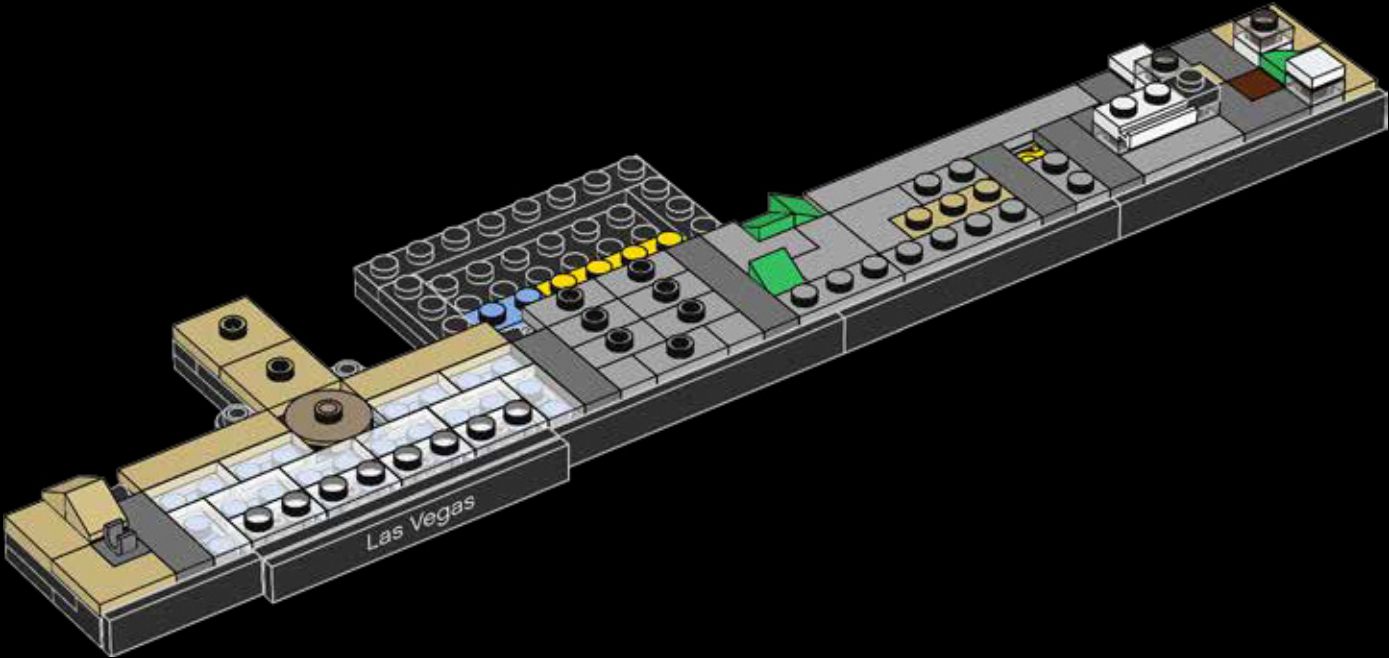

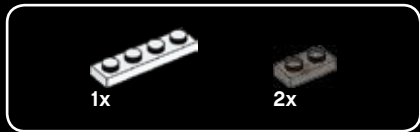

31

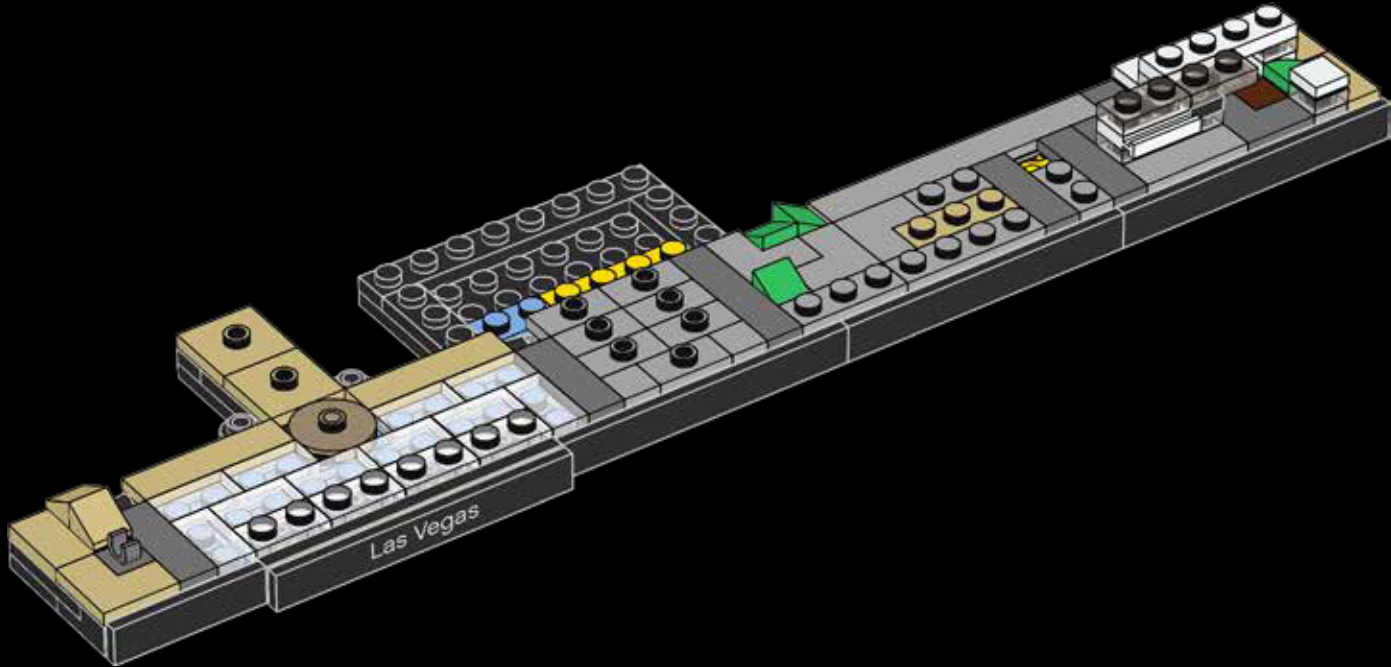



32

The Viva Vision screen that hangs above Fremont Street is the largest in the world and contains 12.5 million LED lights.

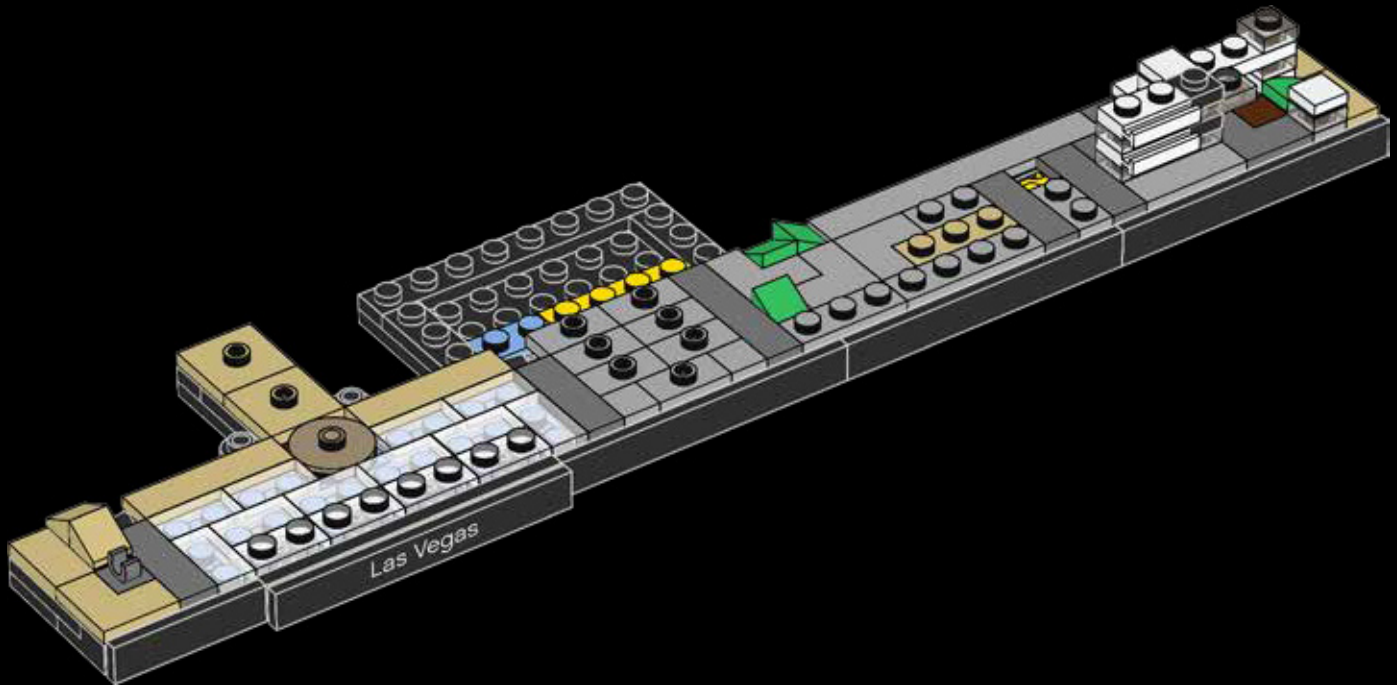



33

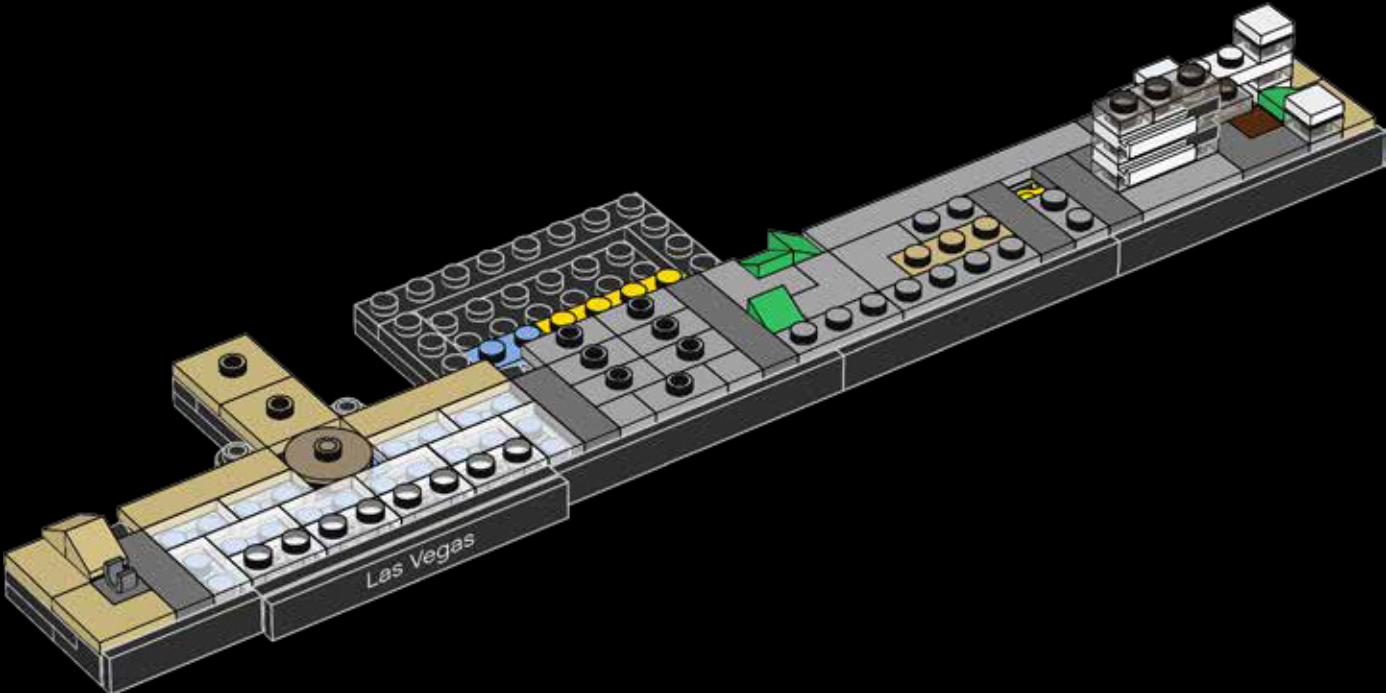



34

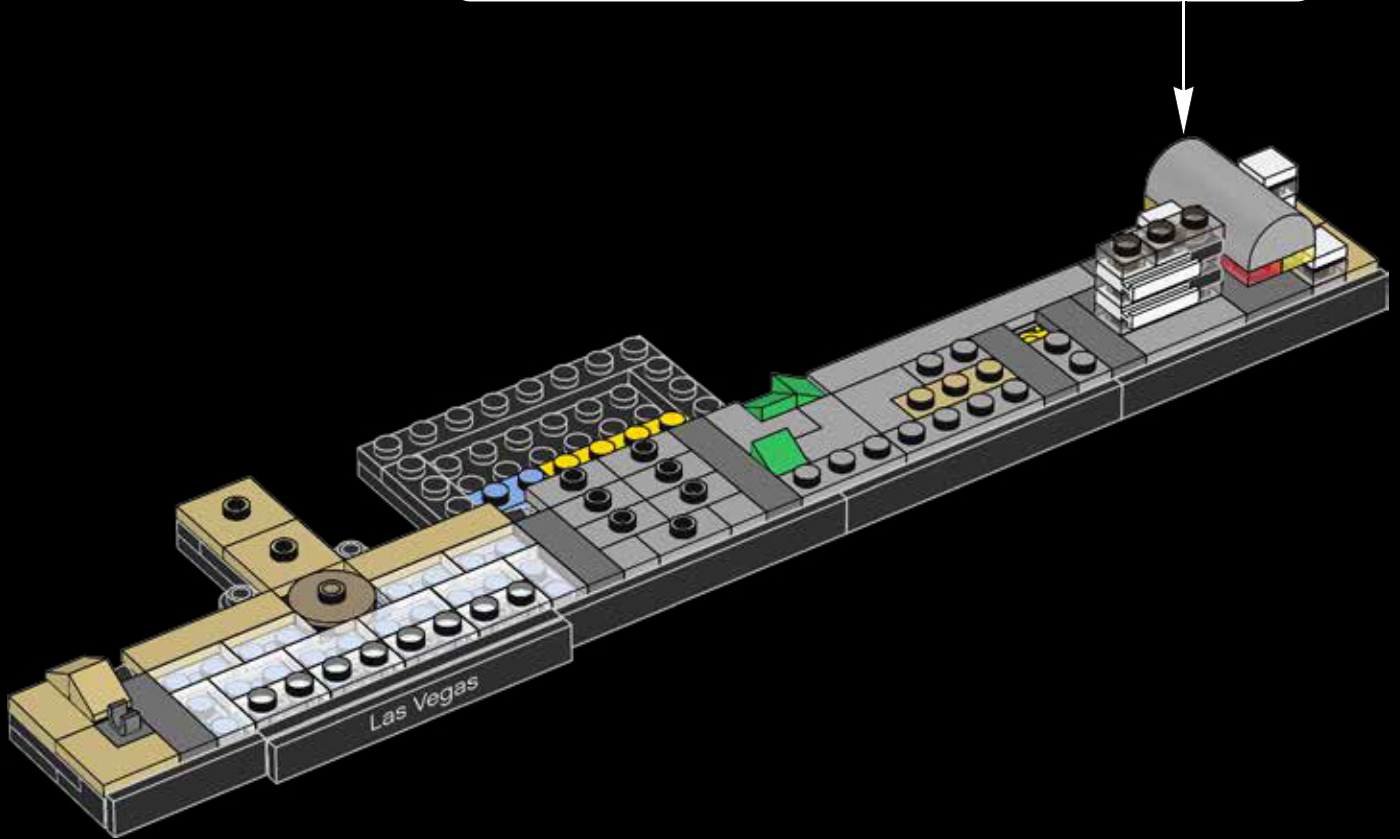
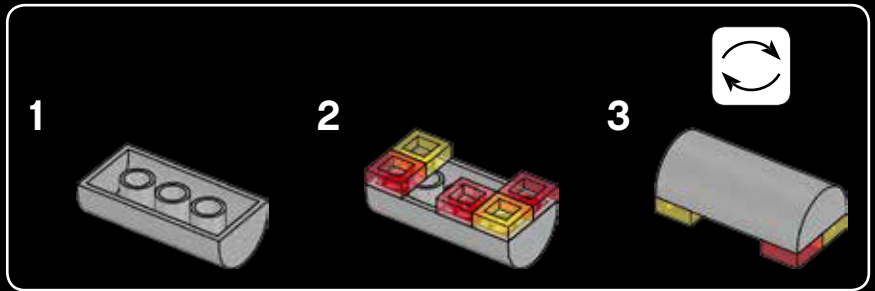



35





36

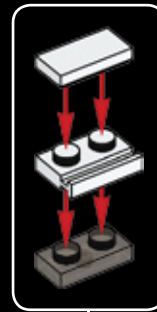



37

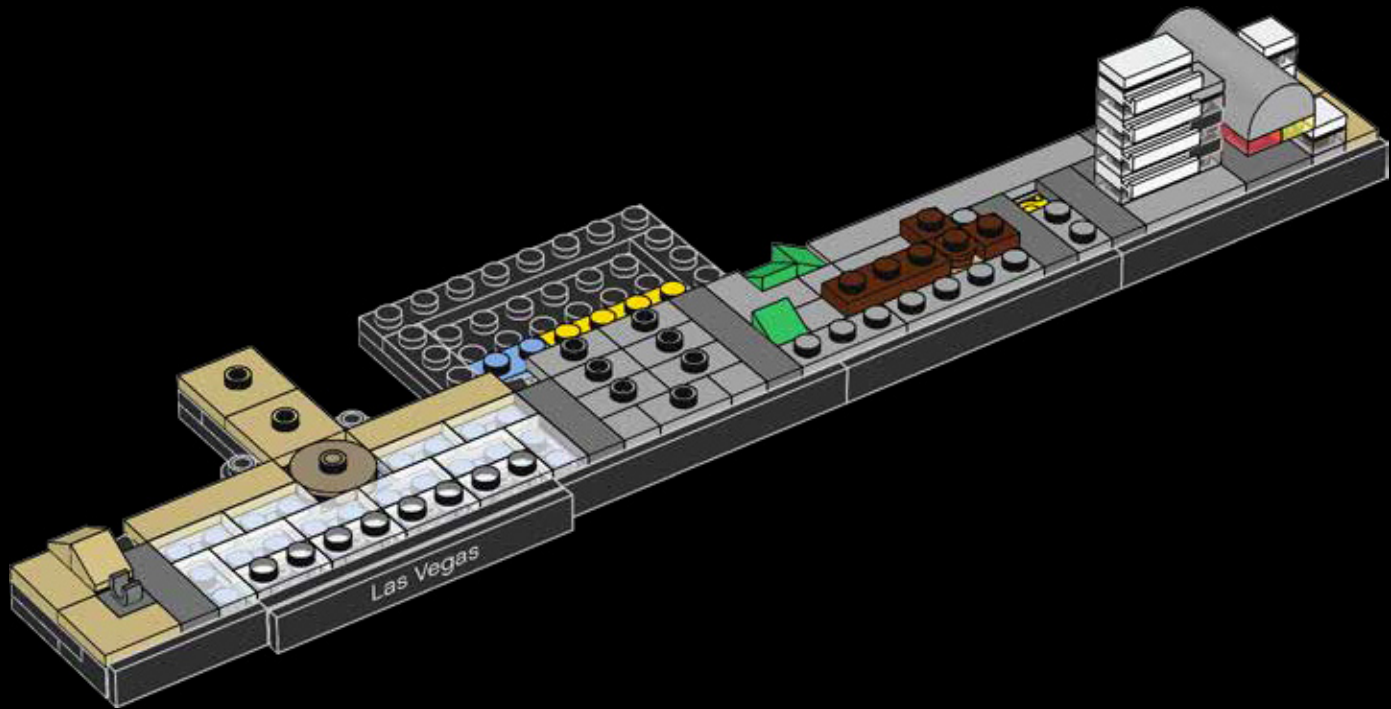

1x  7x 

38

Fremont Street was nicknamed "Glitter Gulch" due to the number of its colorful neon signs.

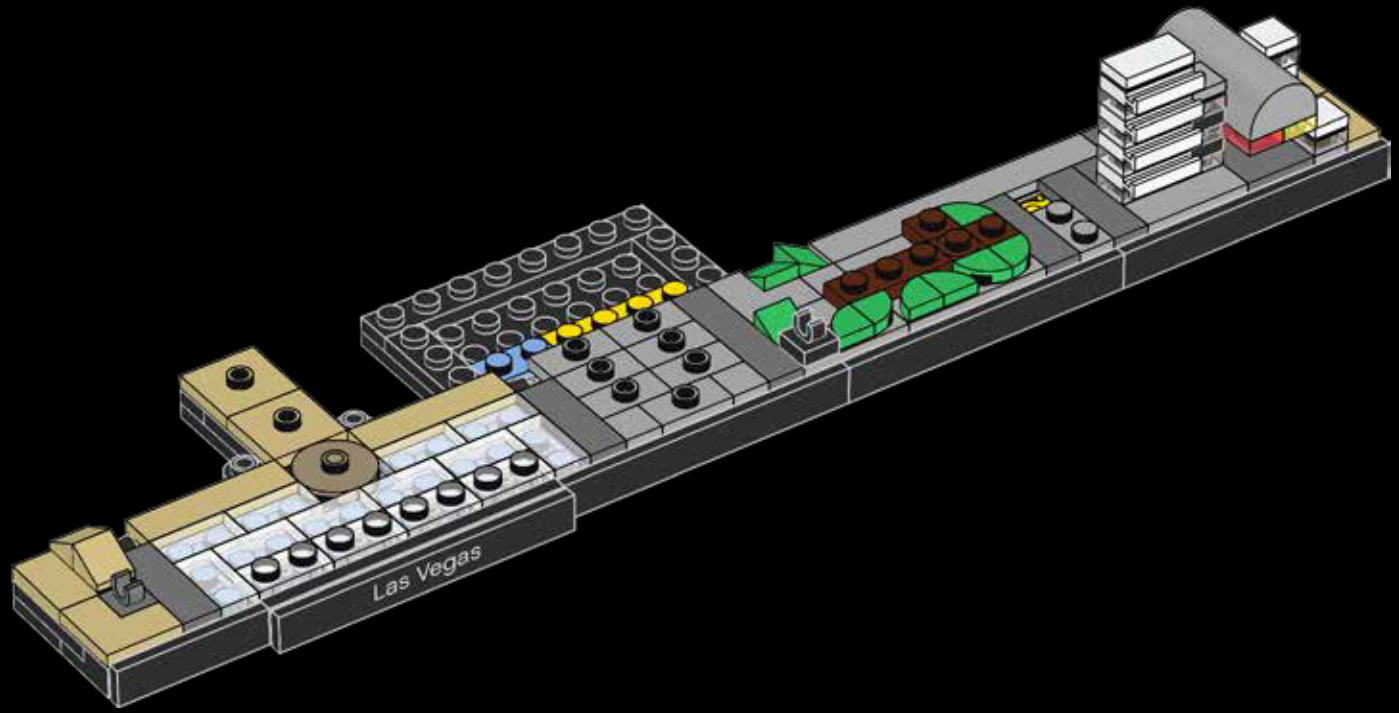

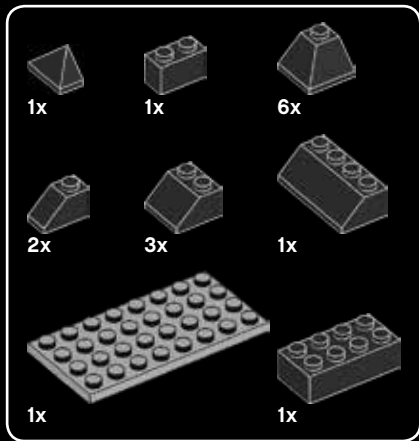

39

1

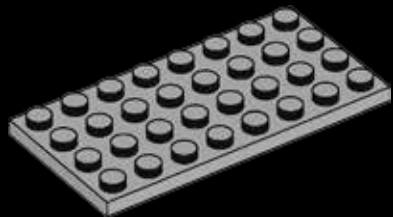

2

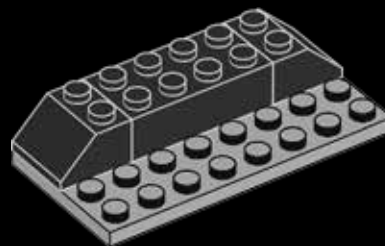

3

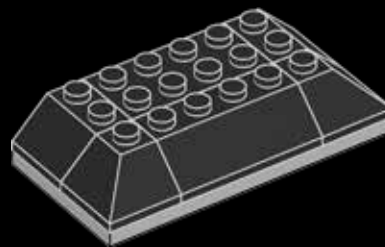

4

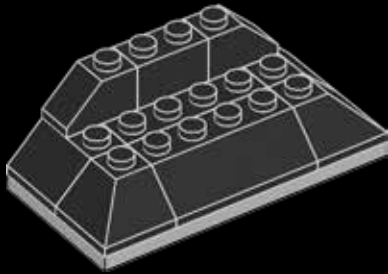

5

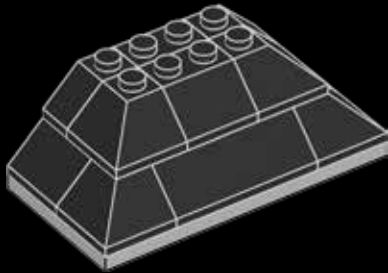

6

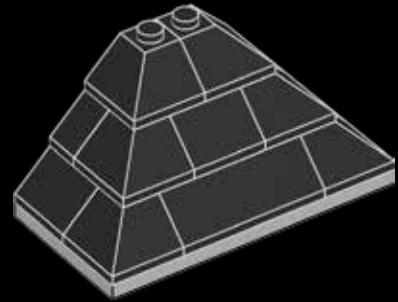

7

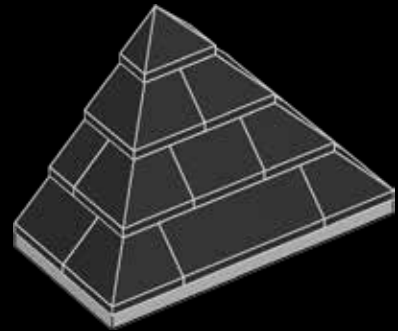

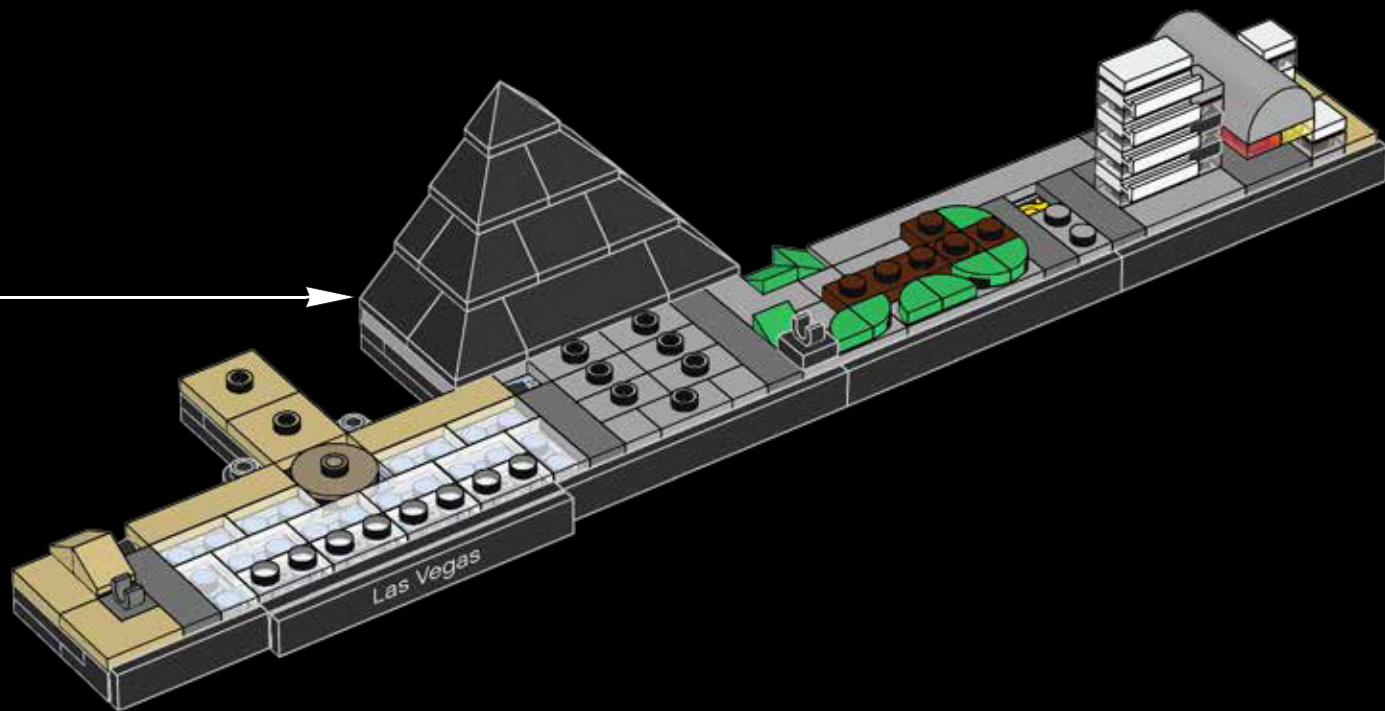

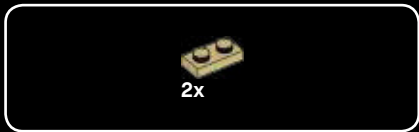

40

The Luxor Las Vegas includes special elevators, known as Inclinator, to run along its diagonal sides.

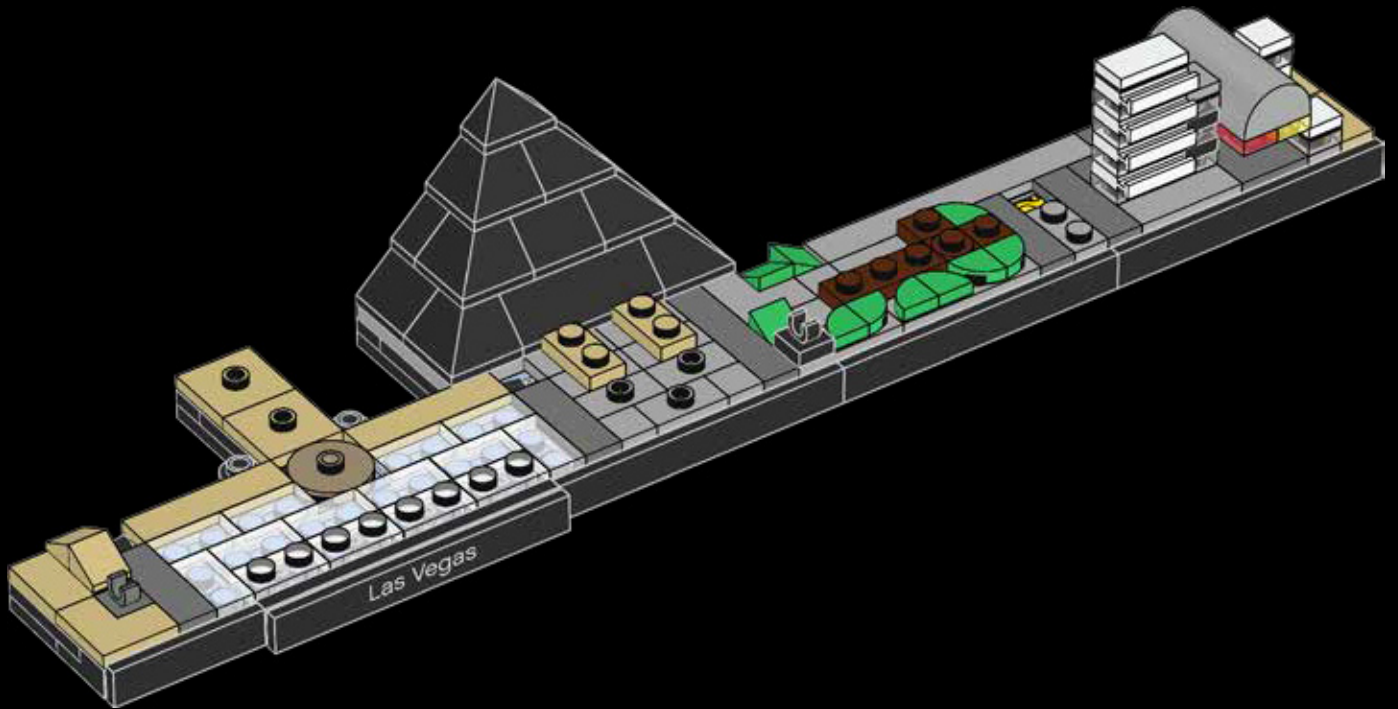



41

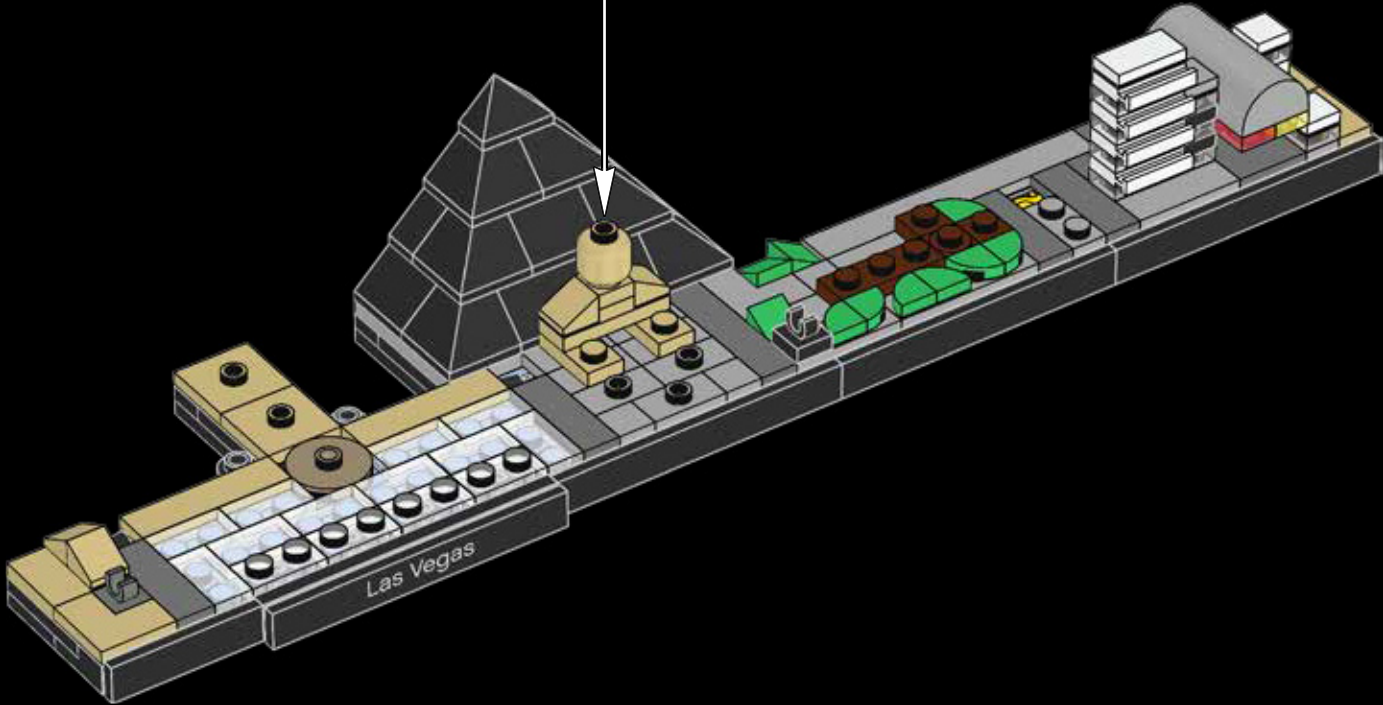
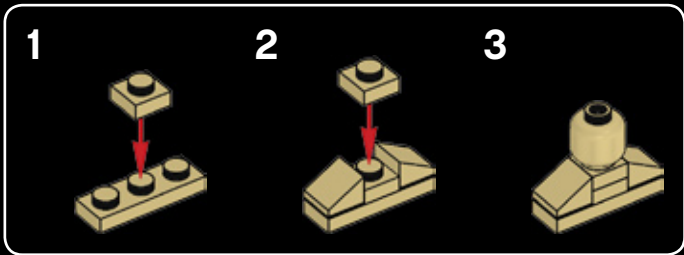

2x

2x

42

The Luxor Las Vegas' Sphinx, a re-creation of the Great Sphinx of Giza, is 101 ft. (30.8 m) high, 32.9 ft. (10 m) taller than the original.

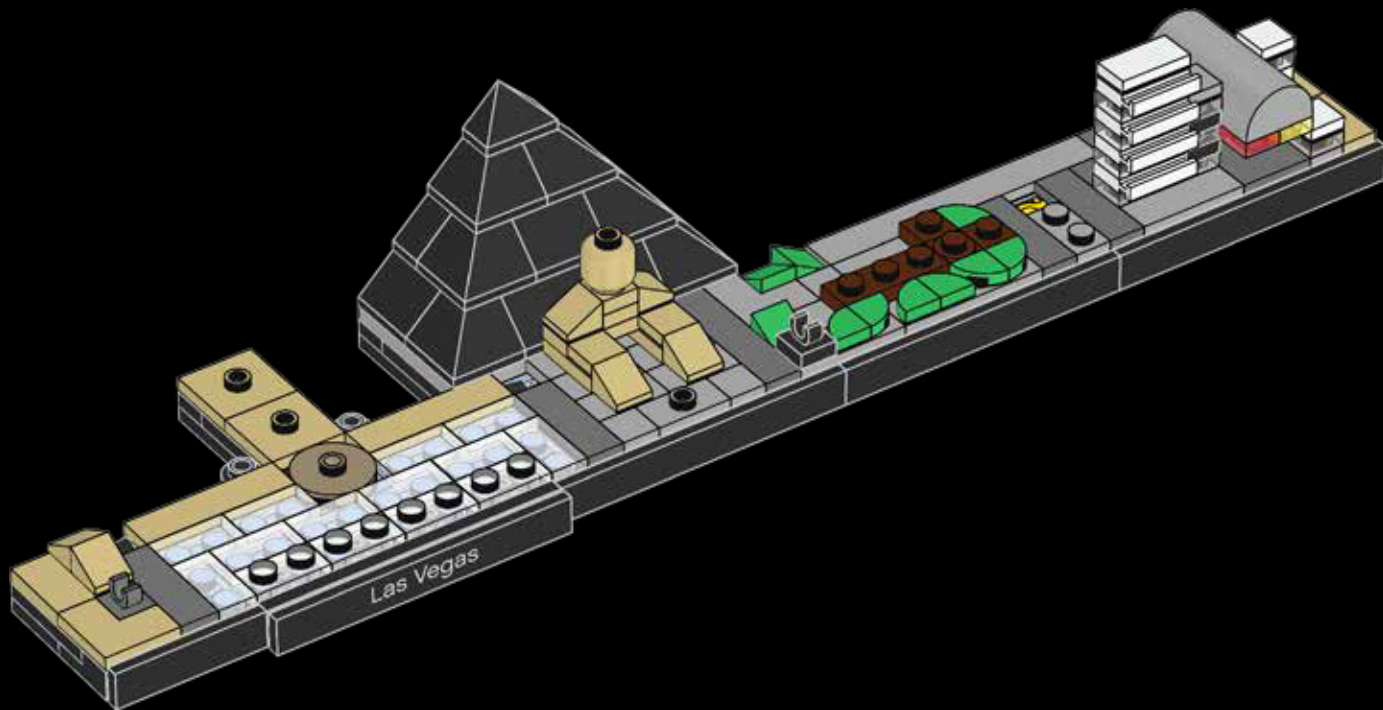



1x

43

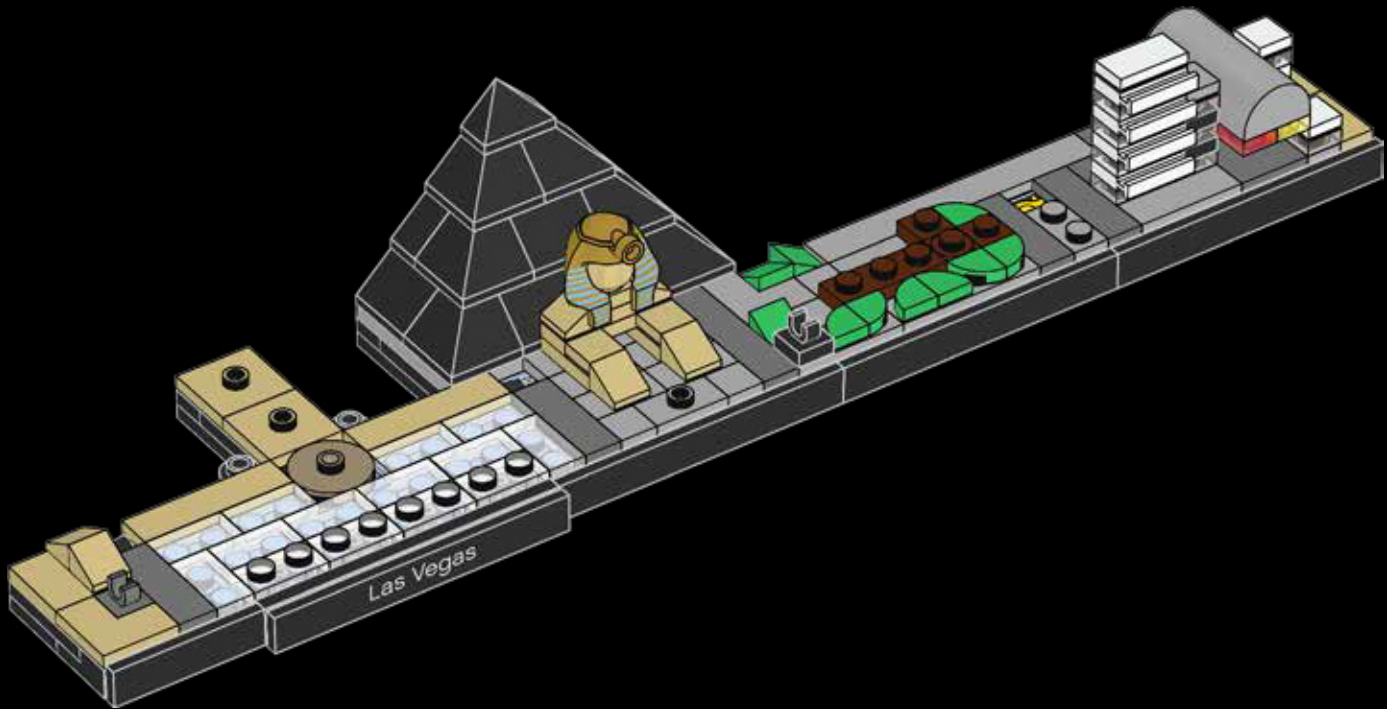



44

1



2



3



4



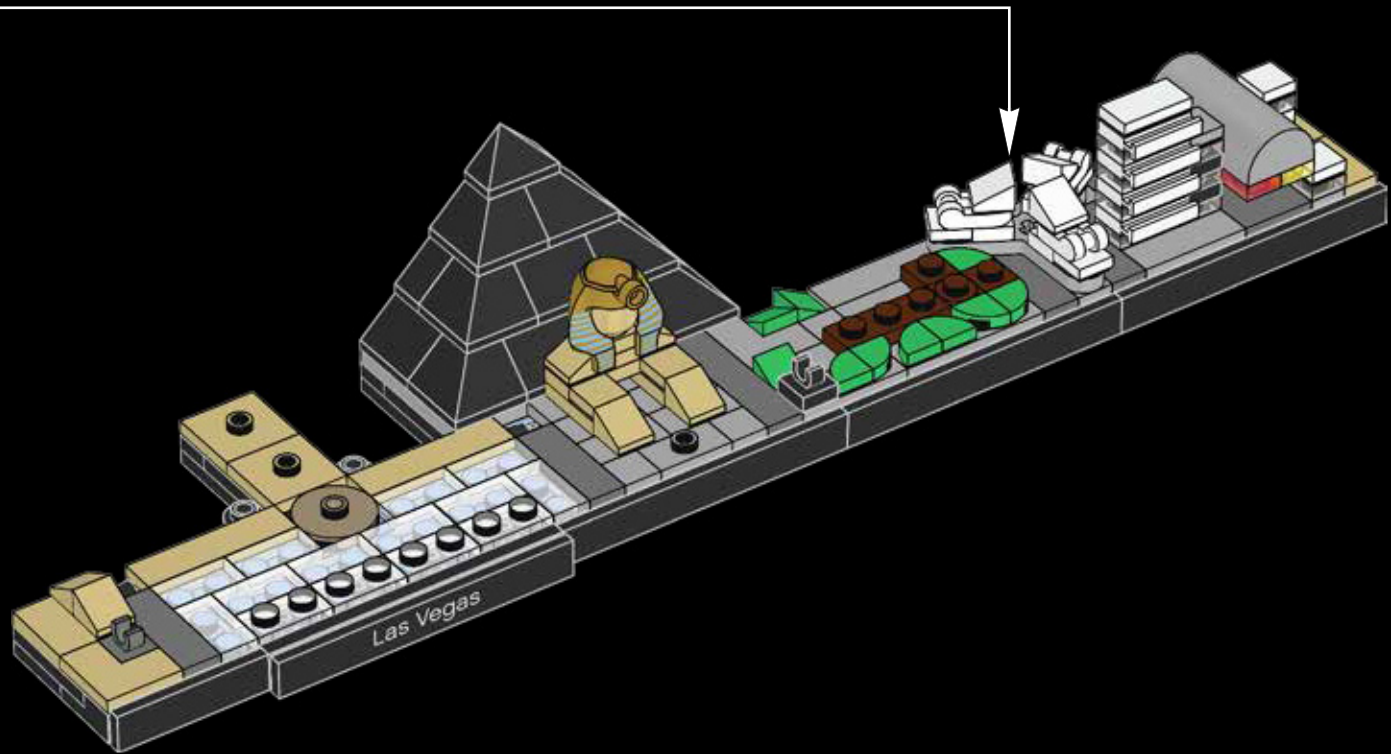

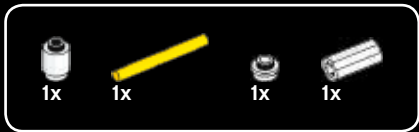

45



Construction on the tower began in February 1992. It was completed in April 1996, at a cost of \$32 million.

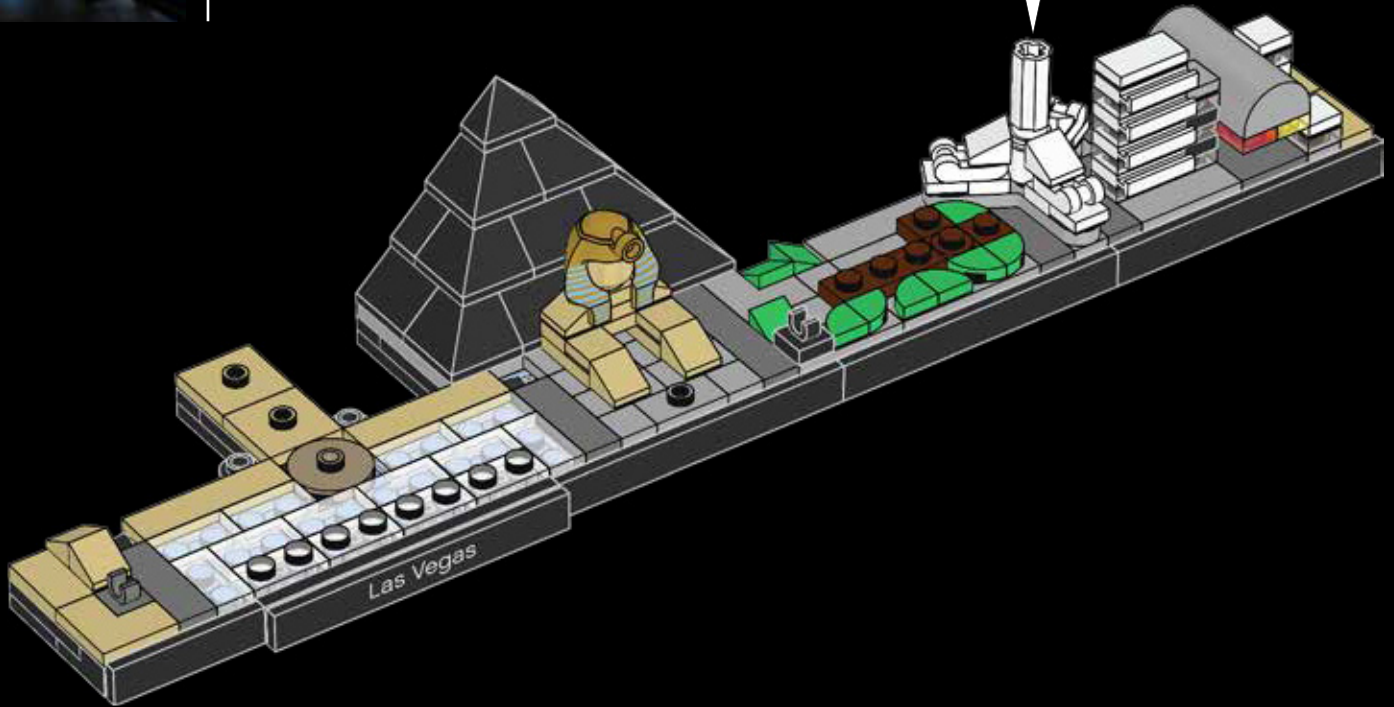
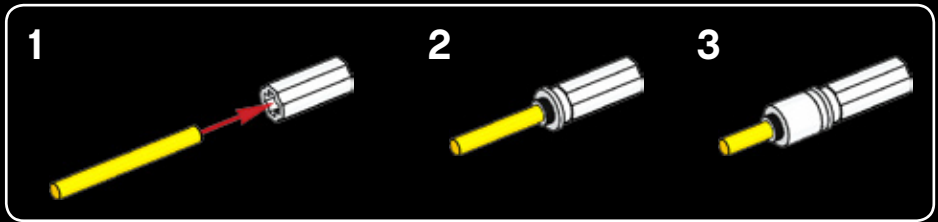

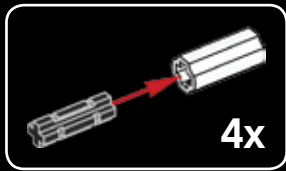

46

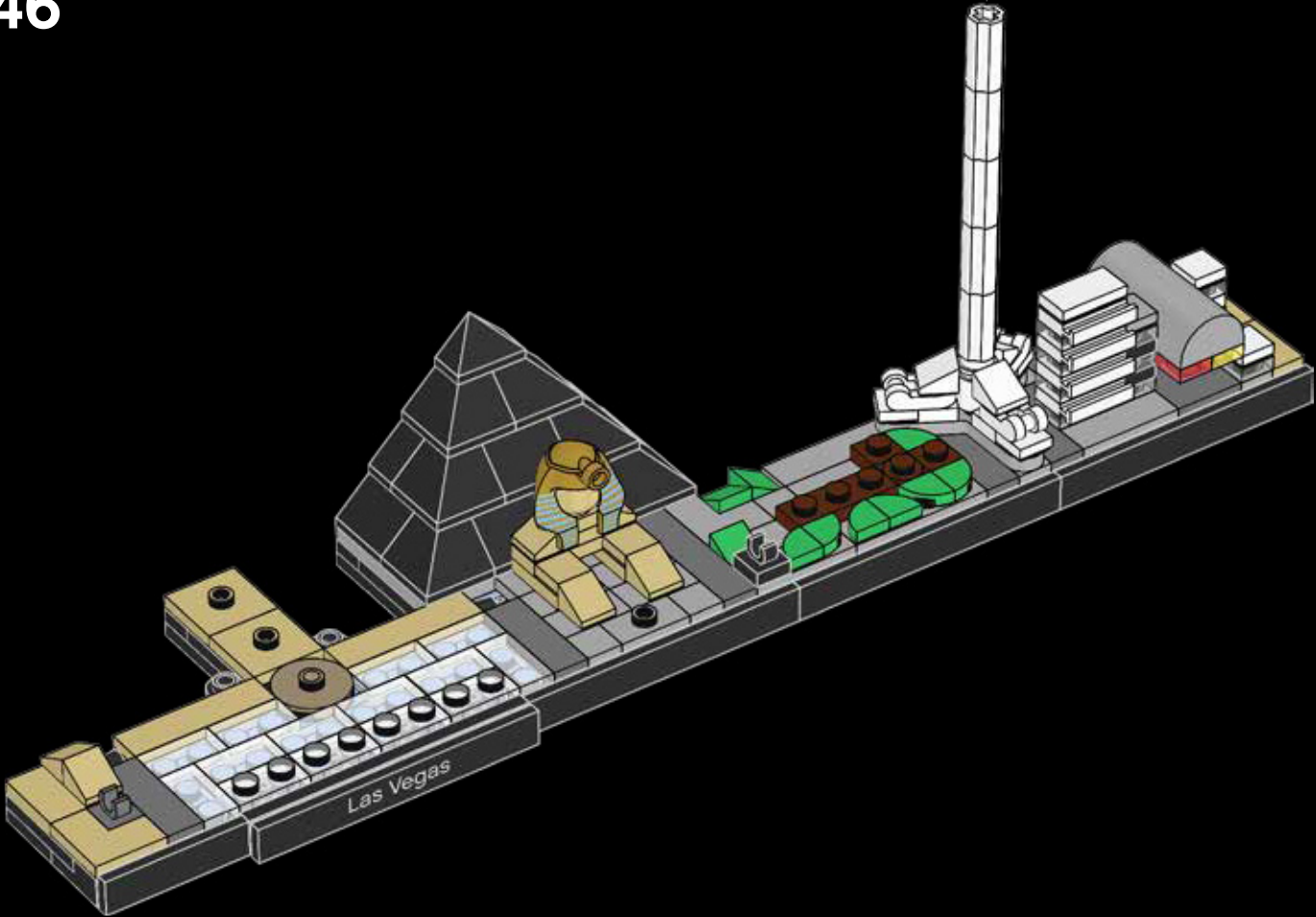

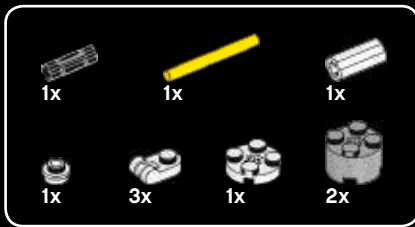

47

1



2



3

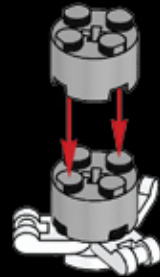

1

2



4

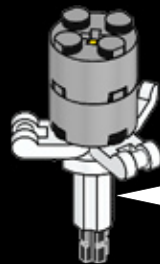

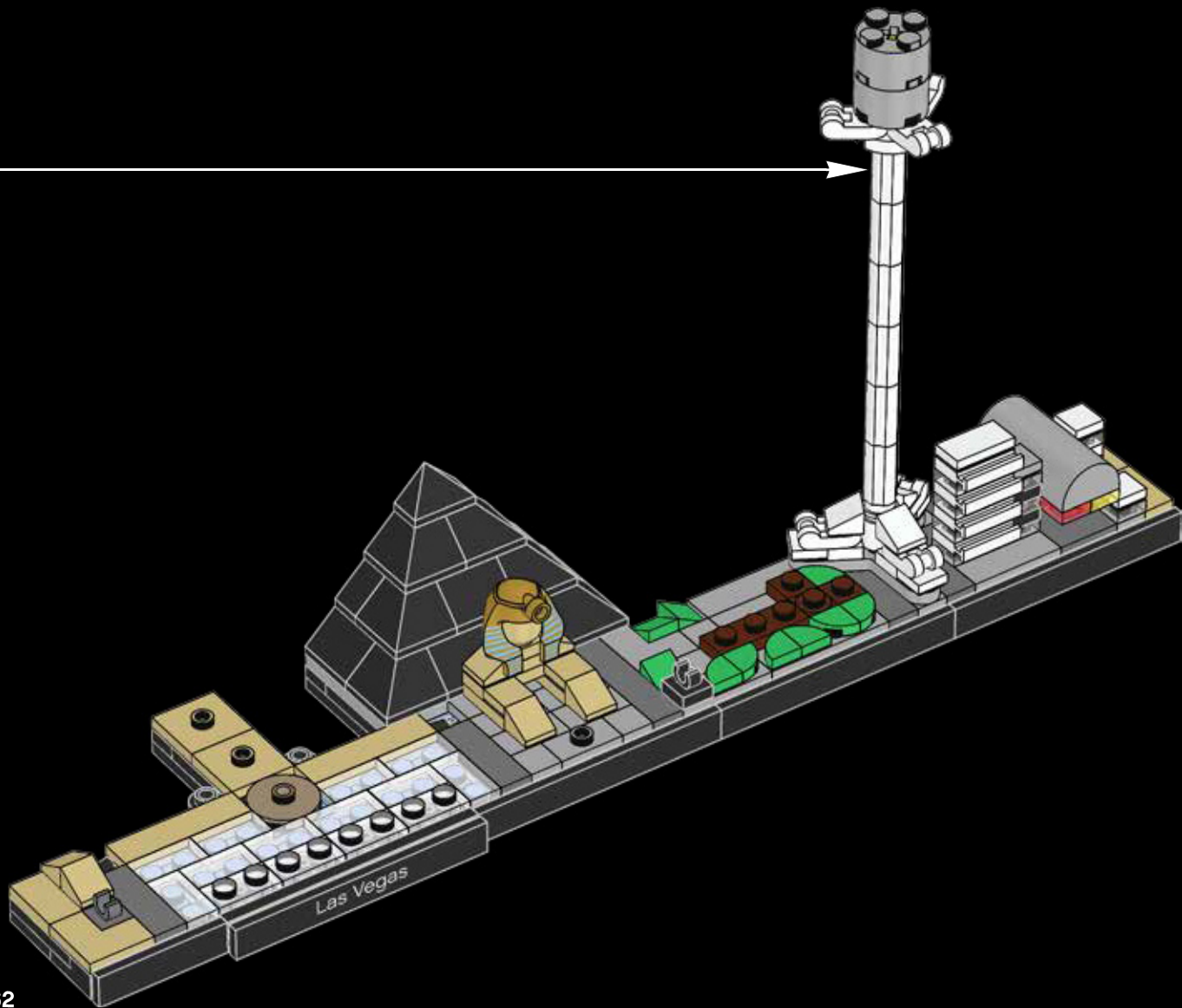

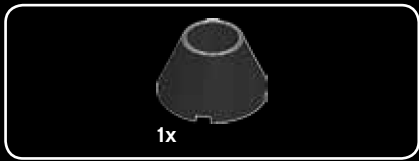

48

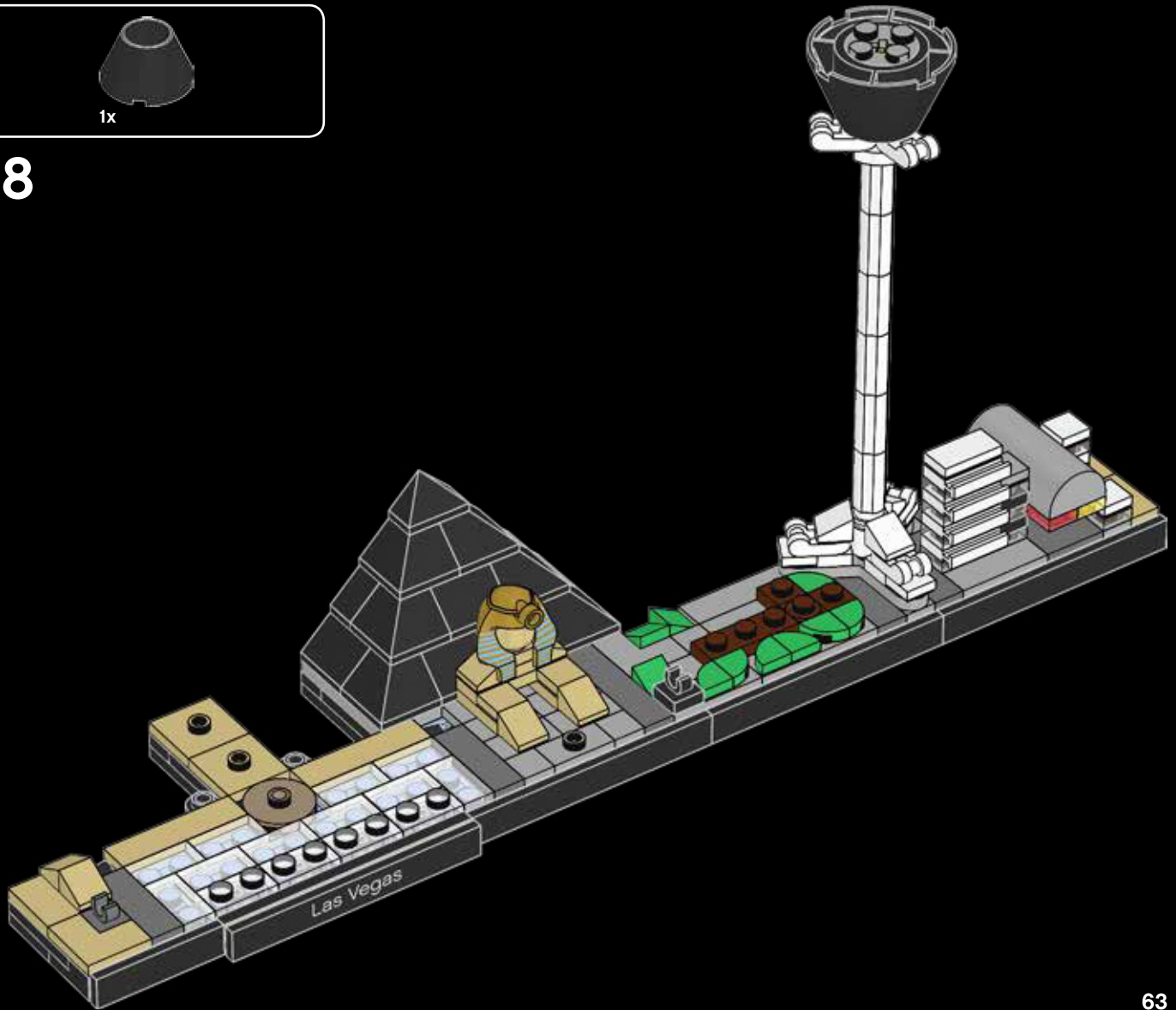



49

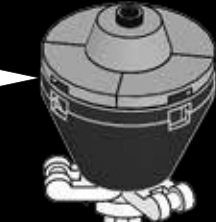
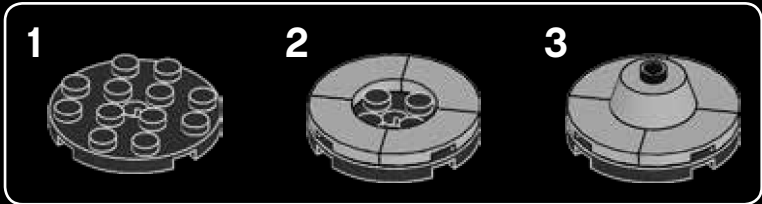



50

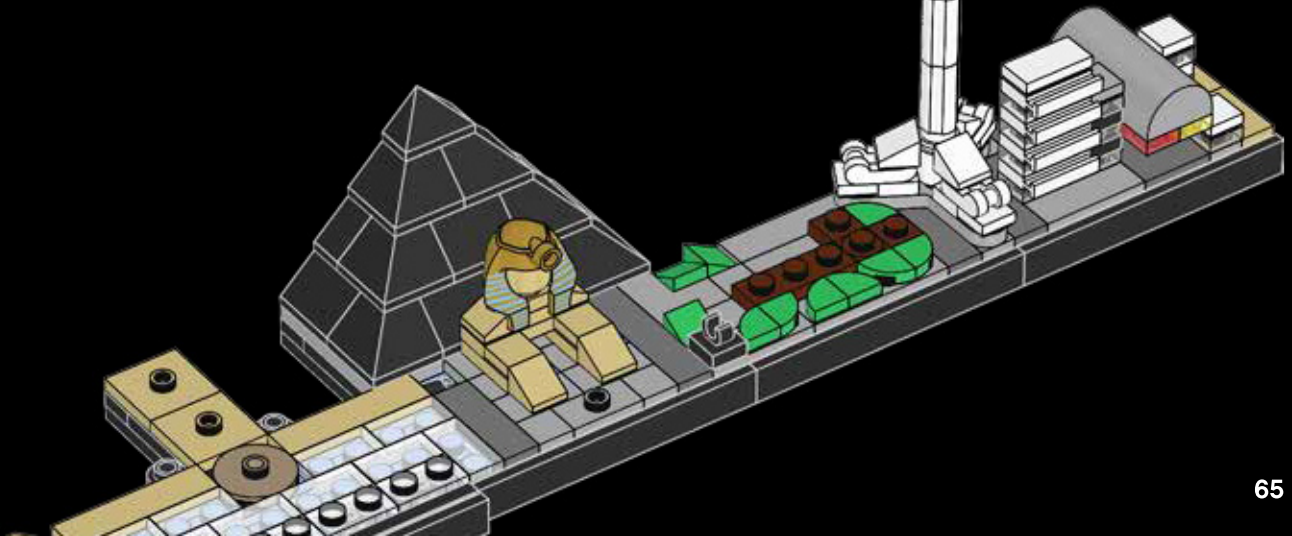
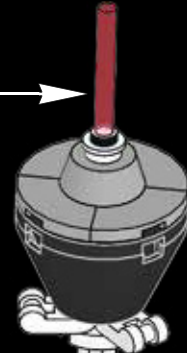
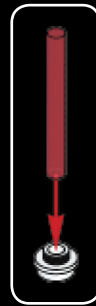

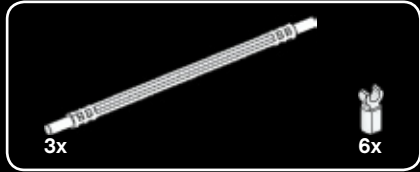

51



2

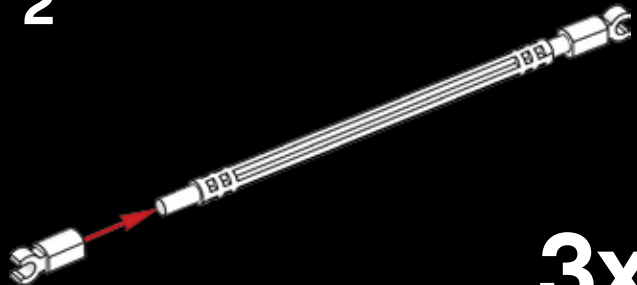

3x

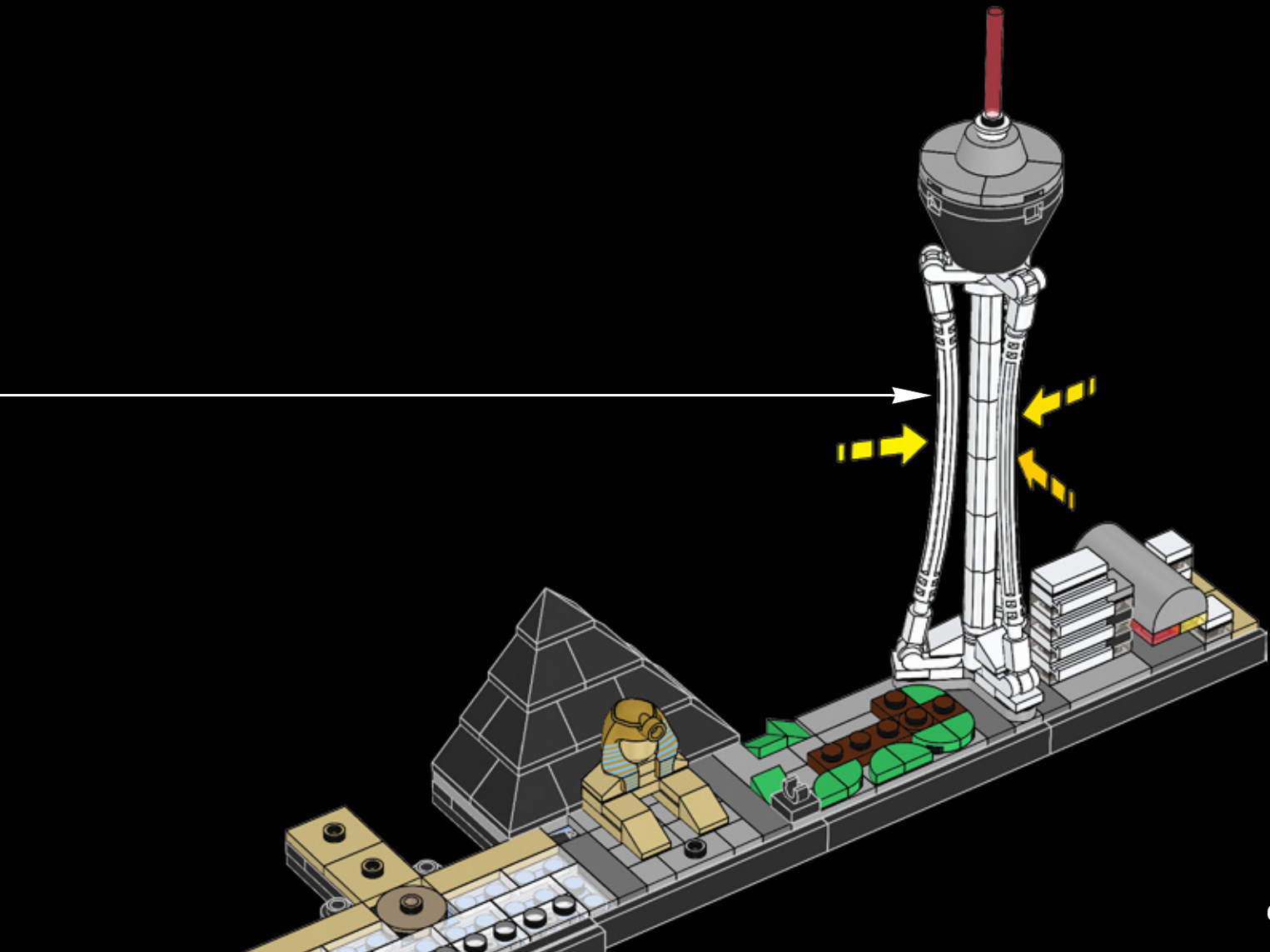



52

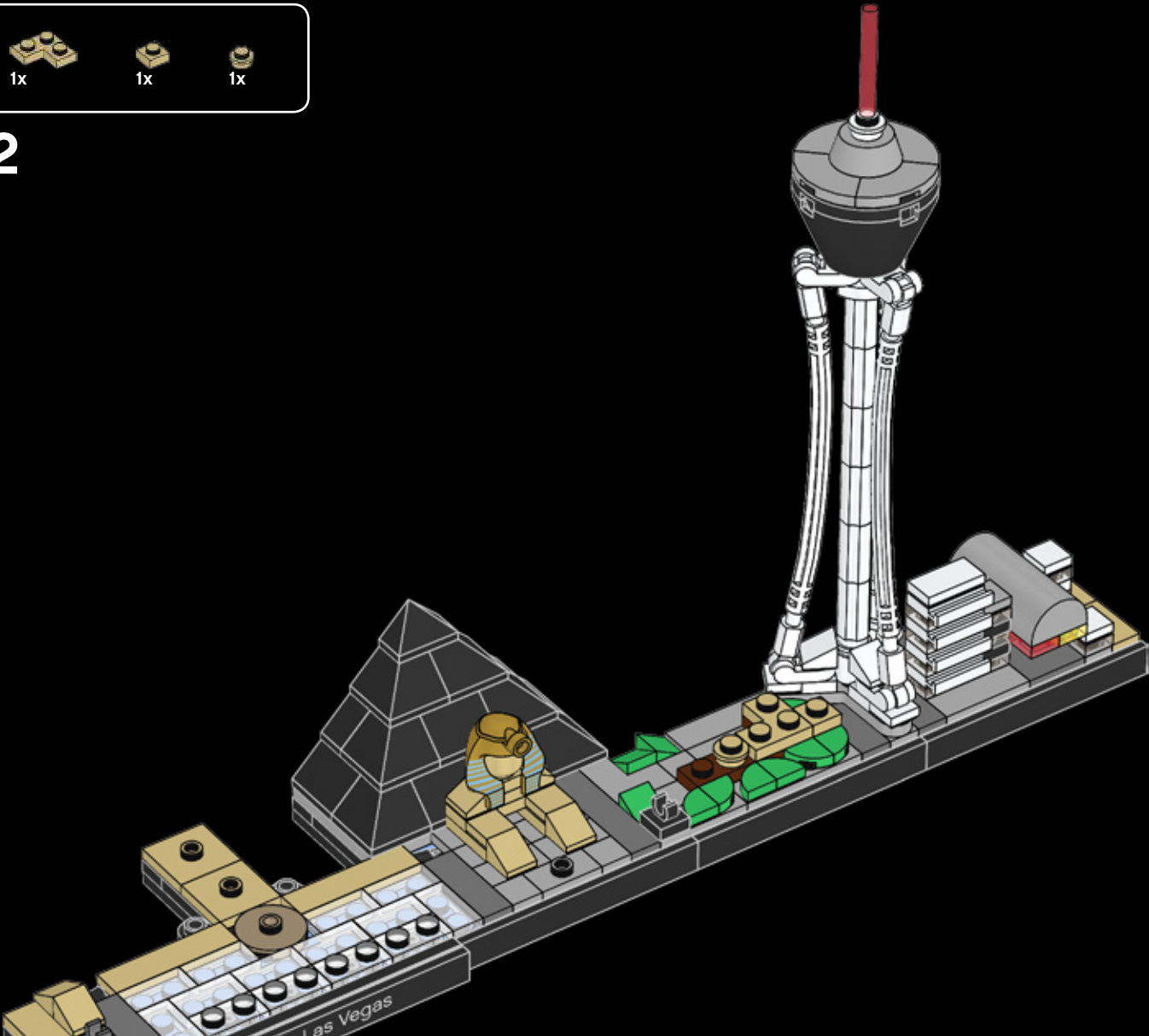



53

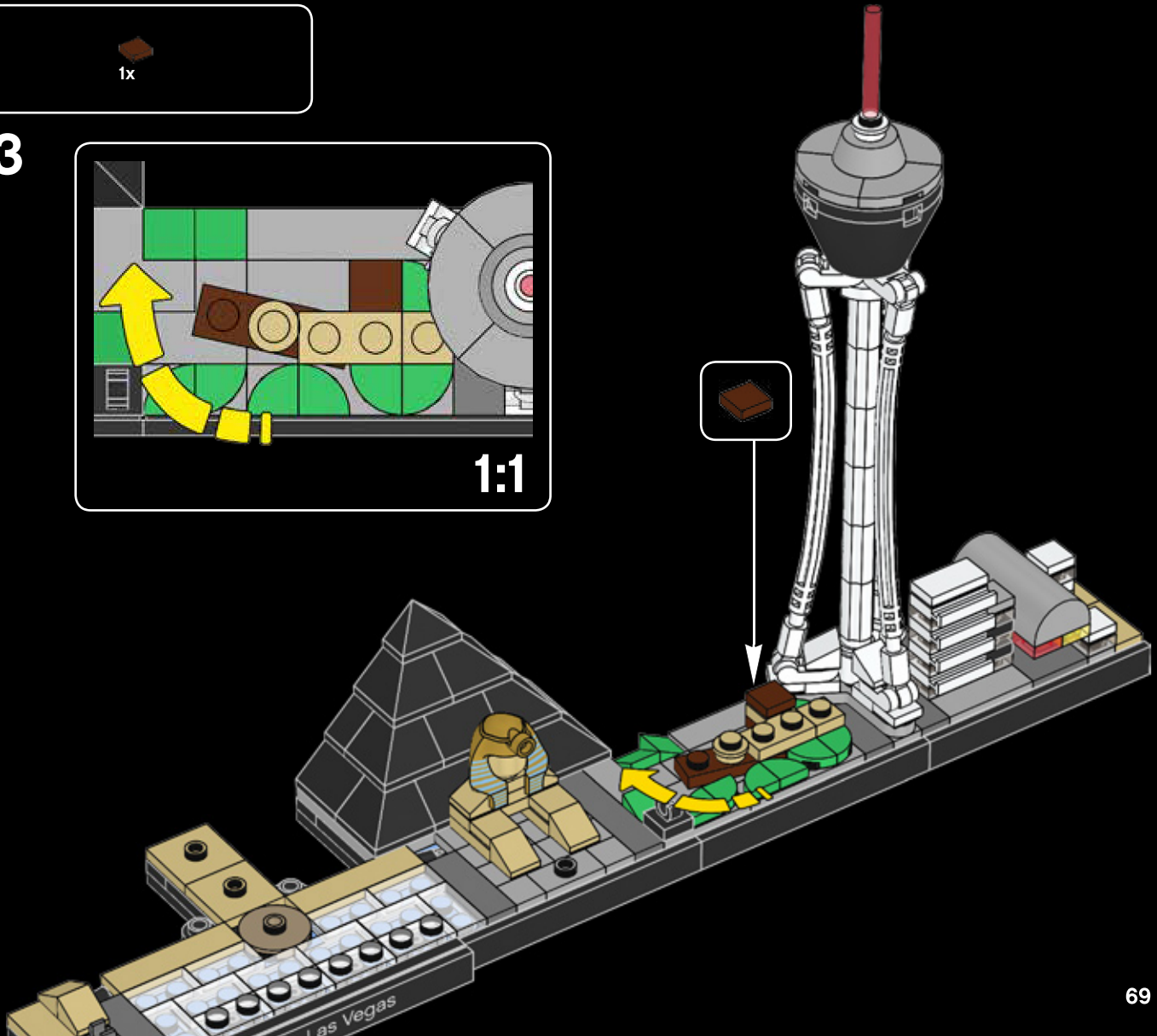
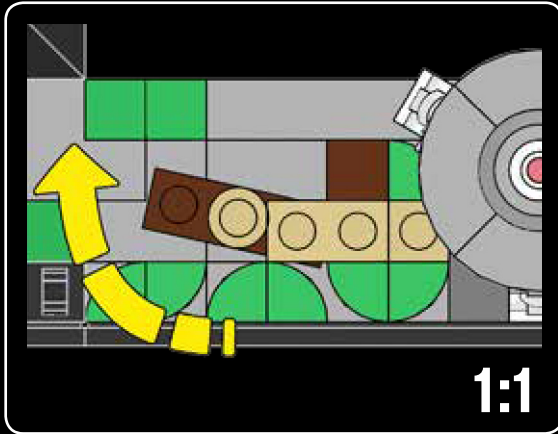



54

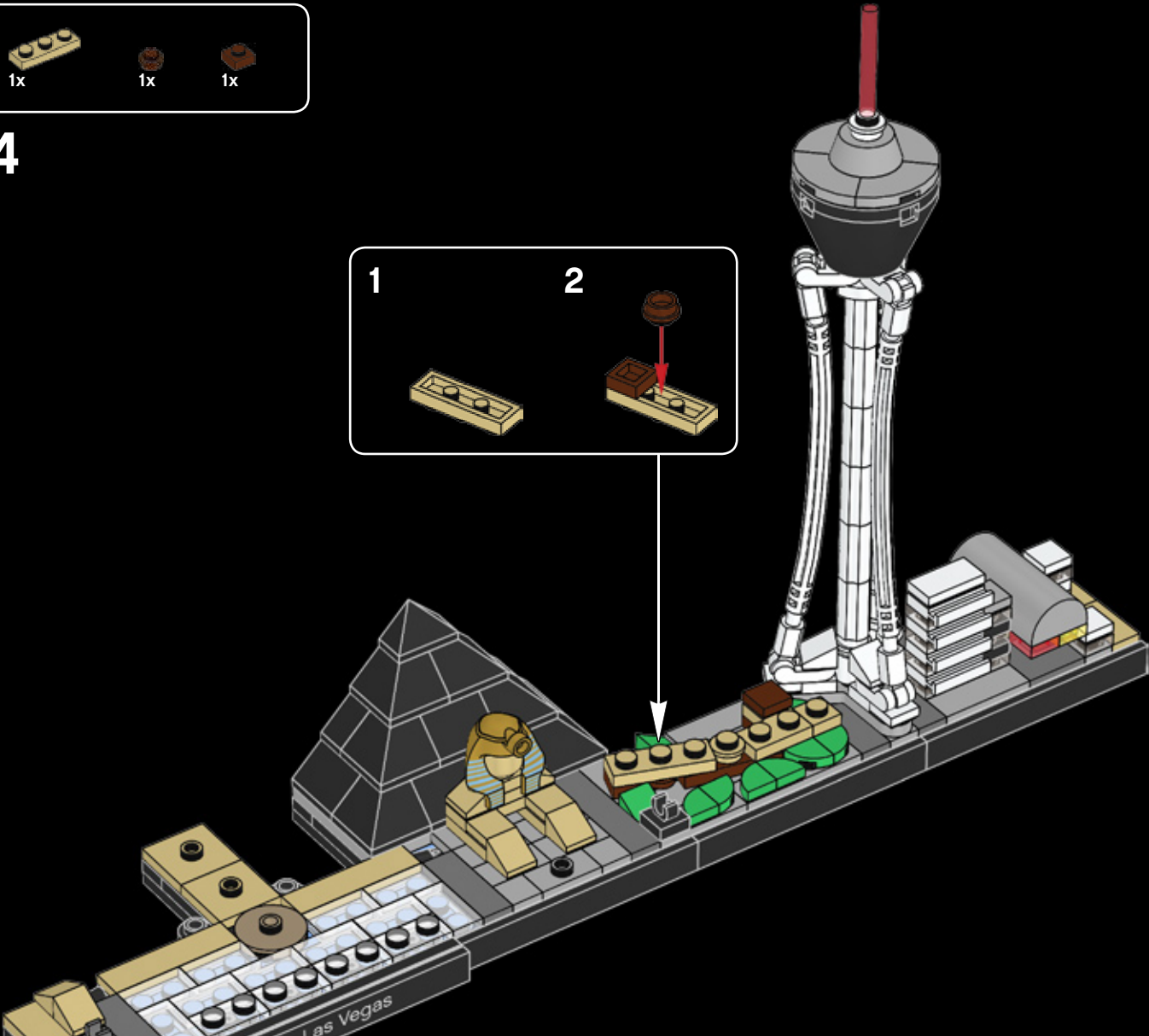
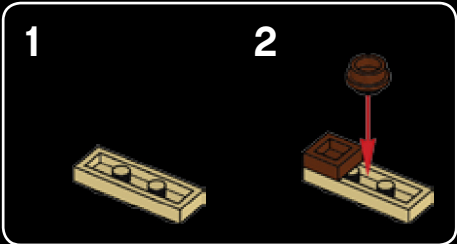



55

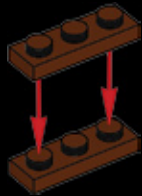

56

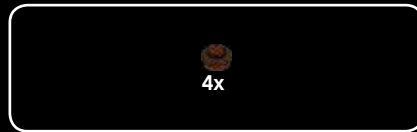

57

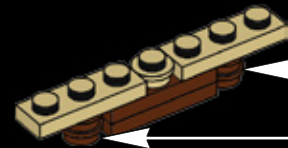
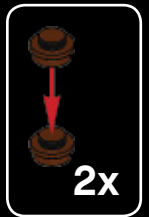

58

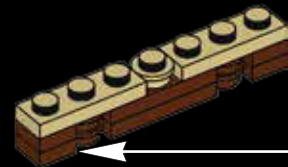
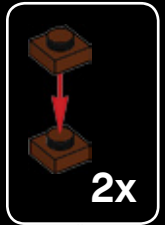

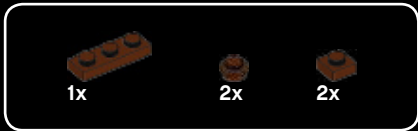

59

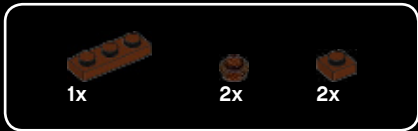
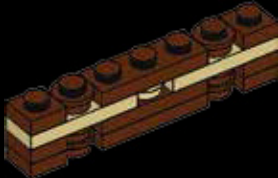

60



61

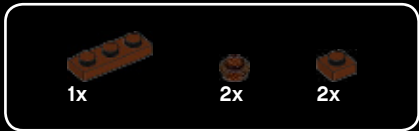
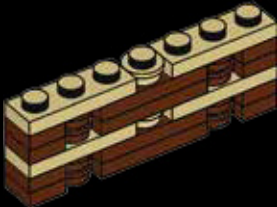

62

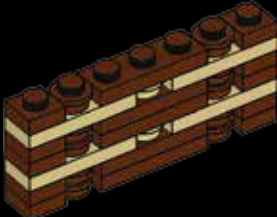

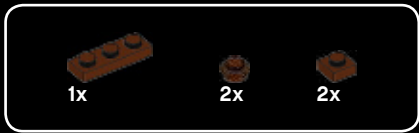

63

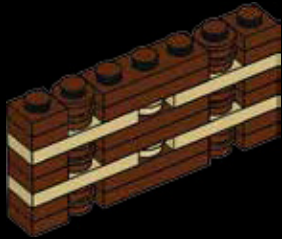

64

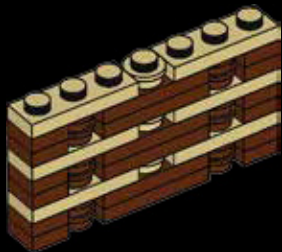

65

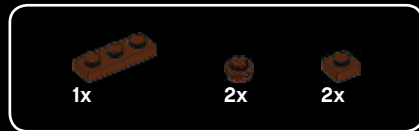

66

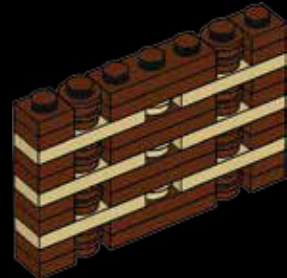



67

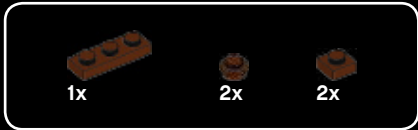

68

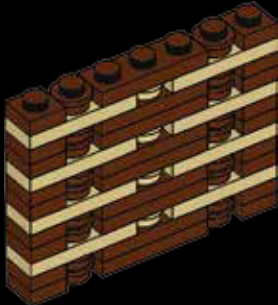

69

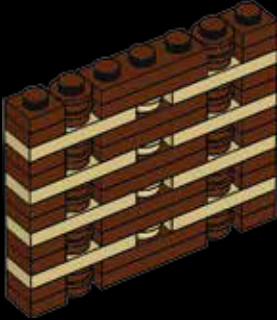

70

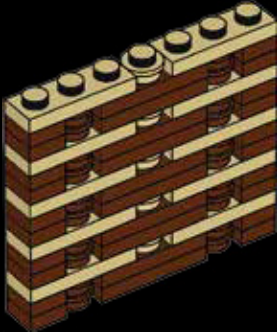

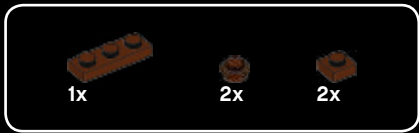

71

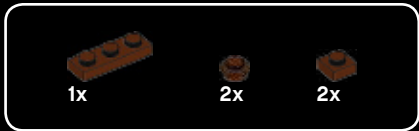
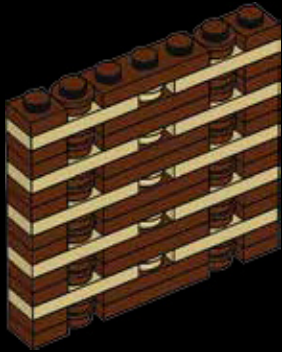

72

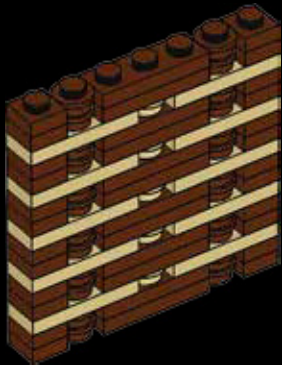

73

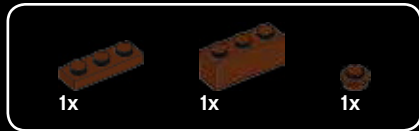
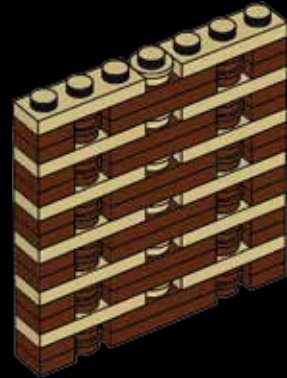

74

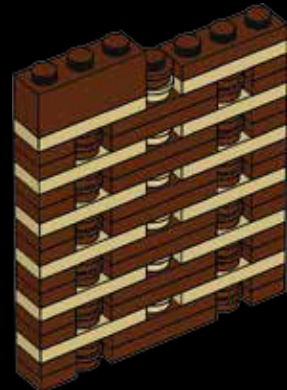



75

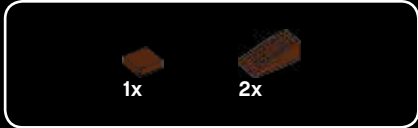
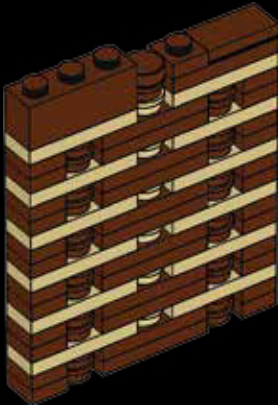

76

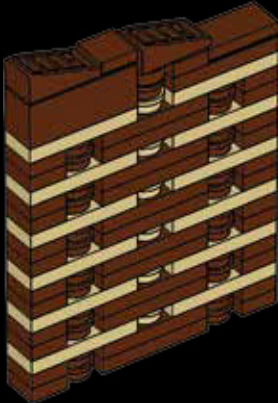

76

77

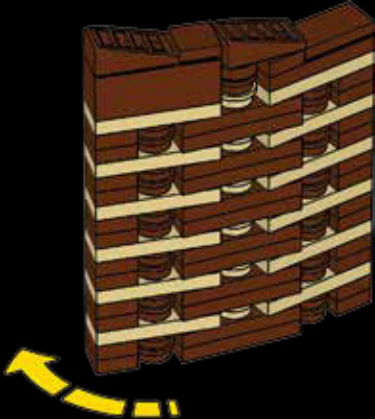
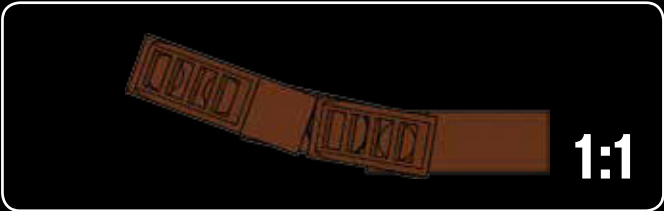

1:1

78

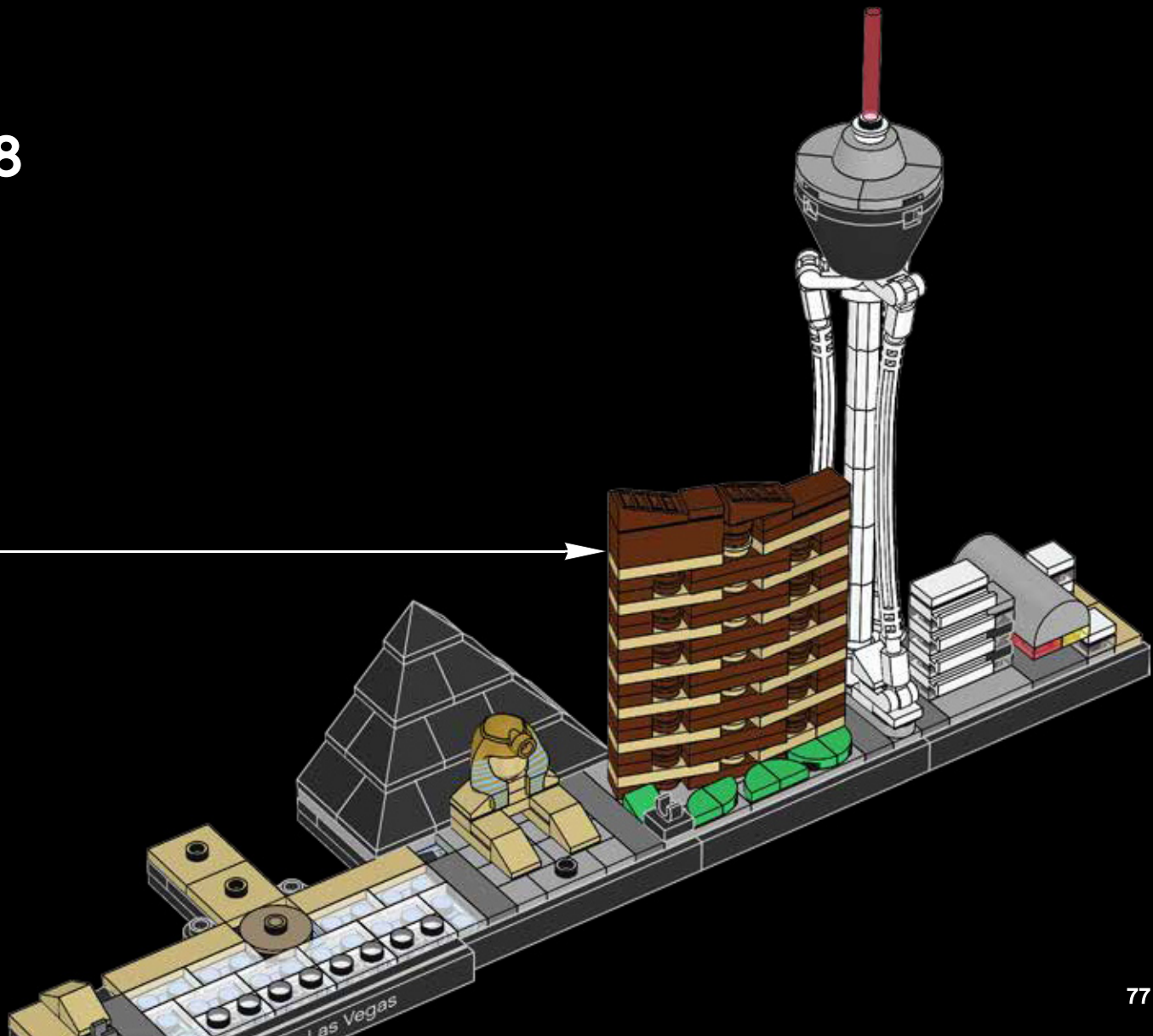

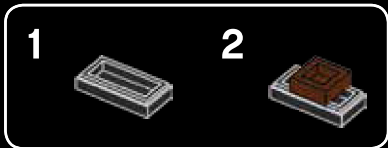

79

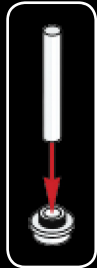

The Encore at the Wynn includes a 60,000 ft² (5574 m²) beach club and a 18-hole golf course on the resort ground.

78

Las Vegas

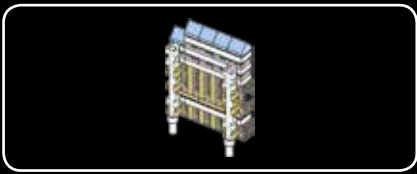

80



81

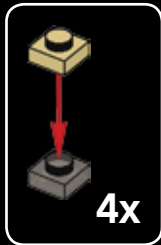

82

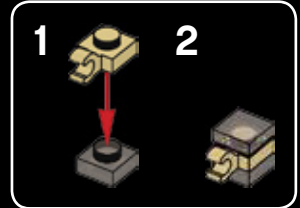

83

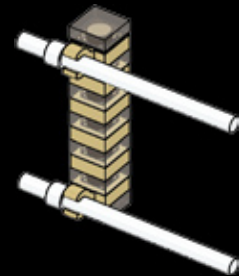



84

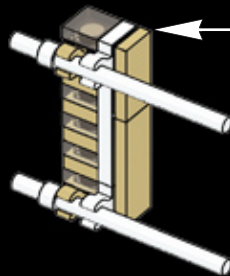
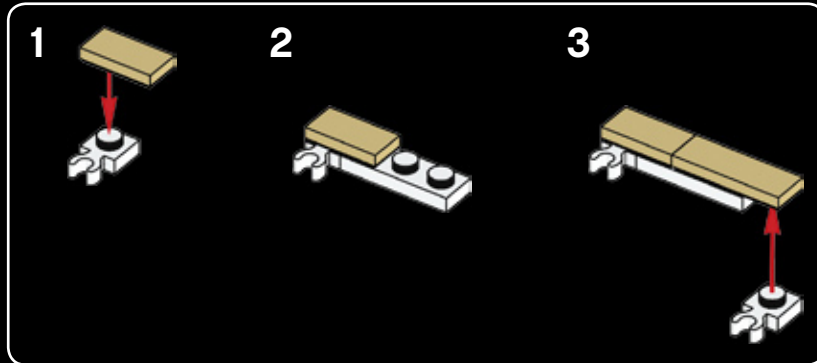



1x

85

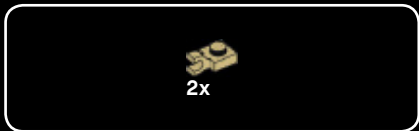

2x

86

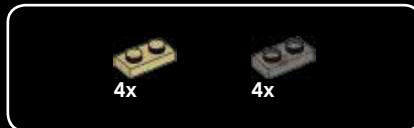

4x

4x

87

The famous Fountains of Bellagio span more than 1,000 ft. (305m), with water soaring as high as 460 ft. (140m) into the air.

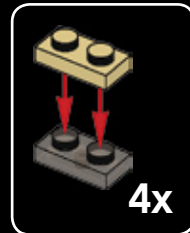



88



89

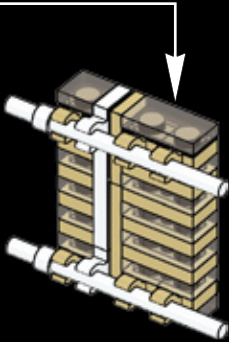



90



91

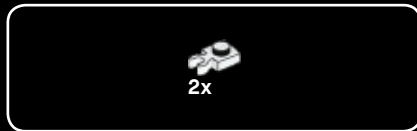

92



93



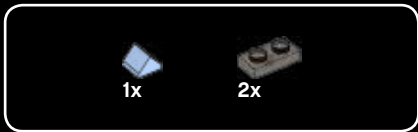

94

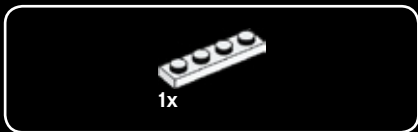
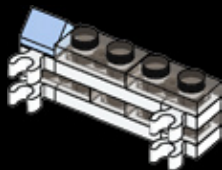

95

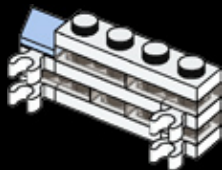

96

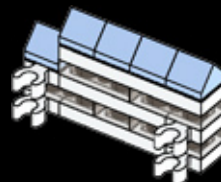

97

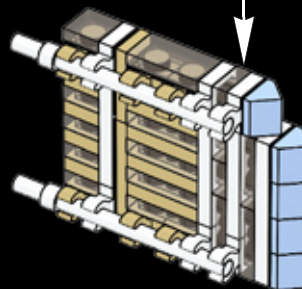

98

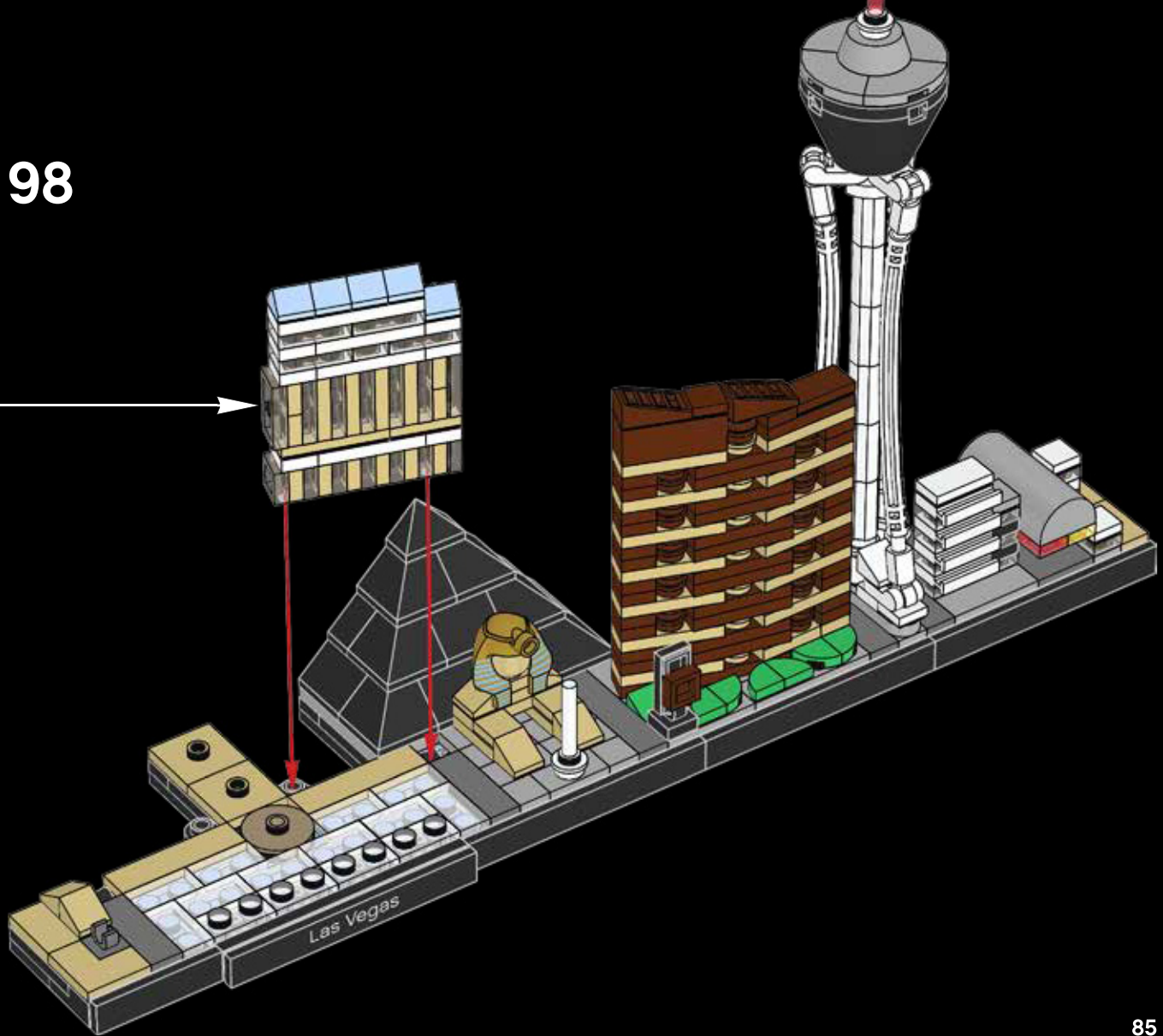

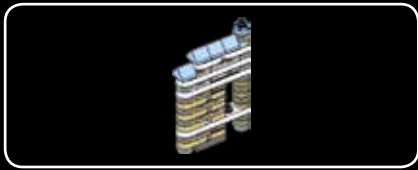

1x

99



1x

1x

100



86



1x

1x

2x

101

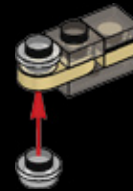

1x

102



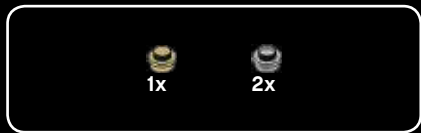

103



104

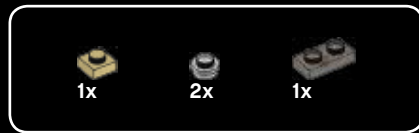
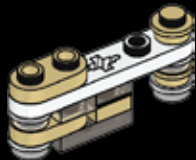

105

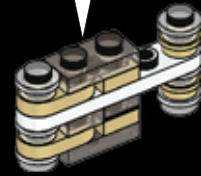
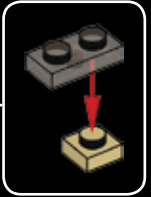

106

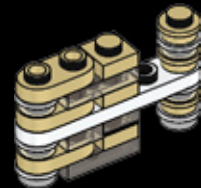



2x



1x

107



1x



1x



1x

108

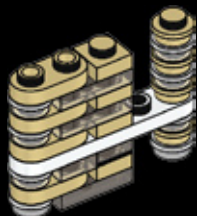

1x



1x



2x

109



1x

110





111



112

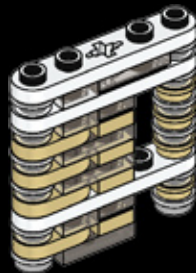

113

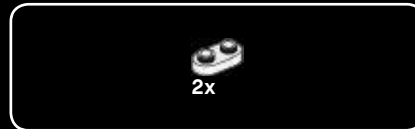

114





1x



1x



3x



1x

115

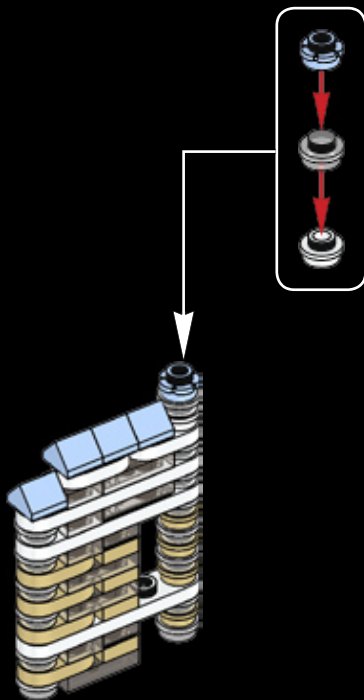

116

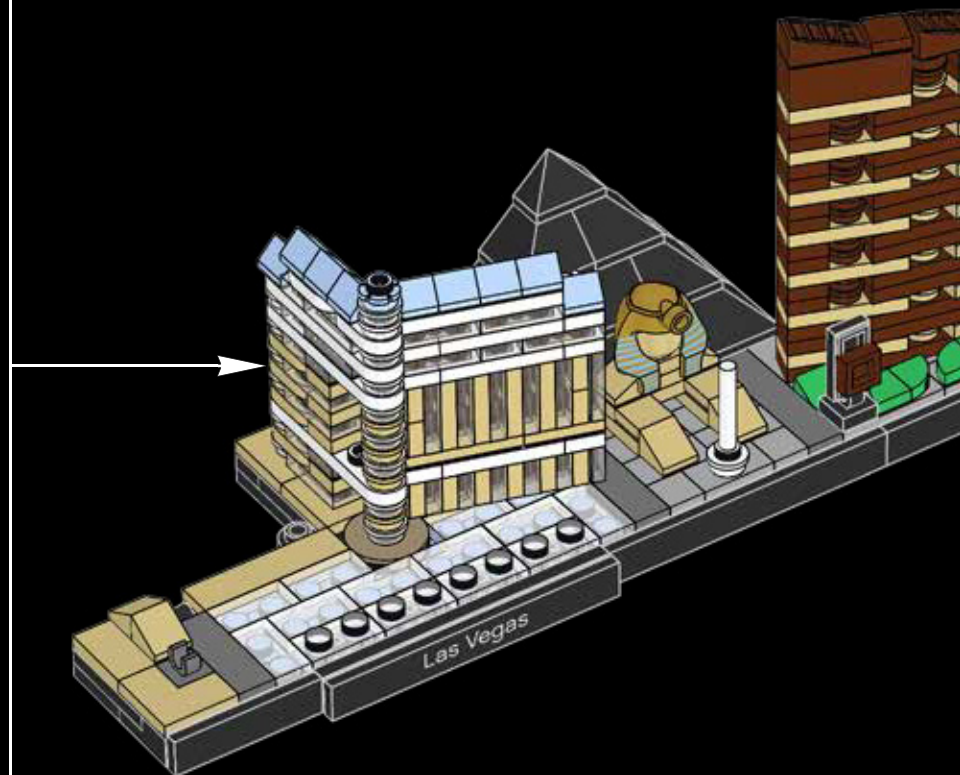



117



118

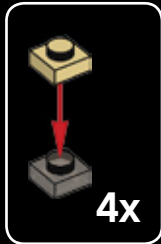

119

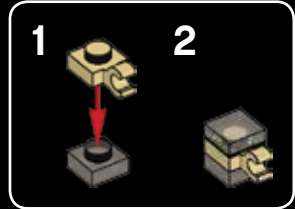

120

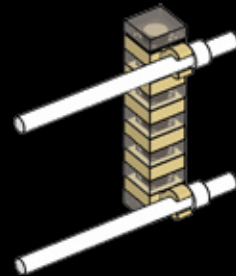



121

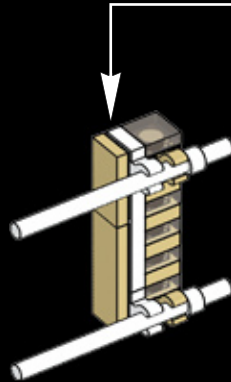
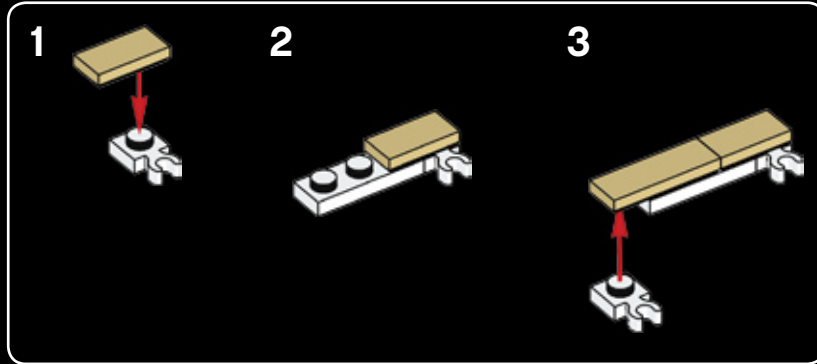



122



123

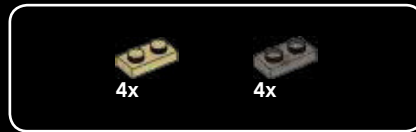

124

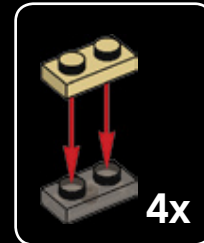



125

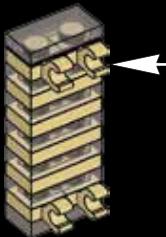
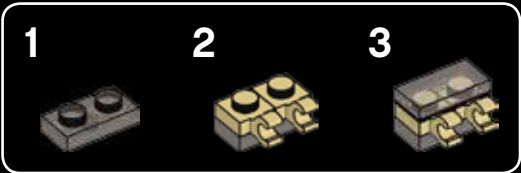

126

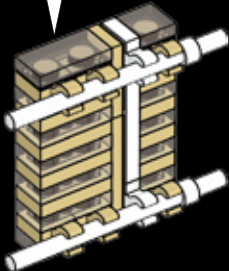



127

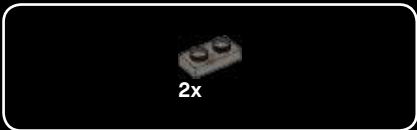

128

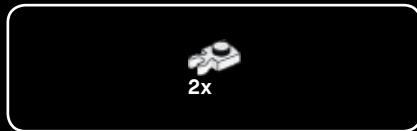

129



130

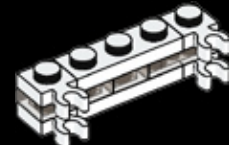



131

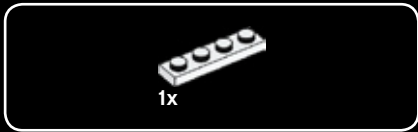
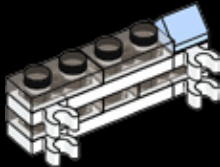

132

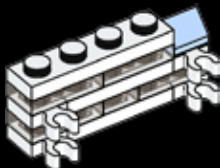

133

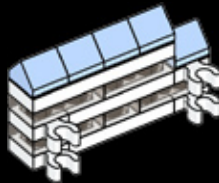

134

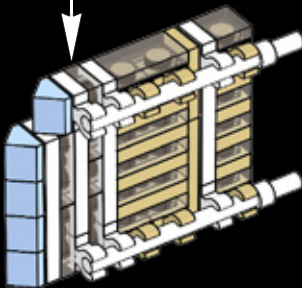

135





2x



2x

136



On the rear of the sign stands the message "Drive Carefully, Come Back Soon".

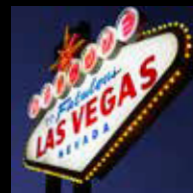



137

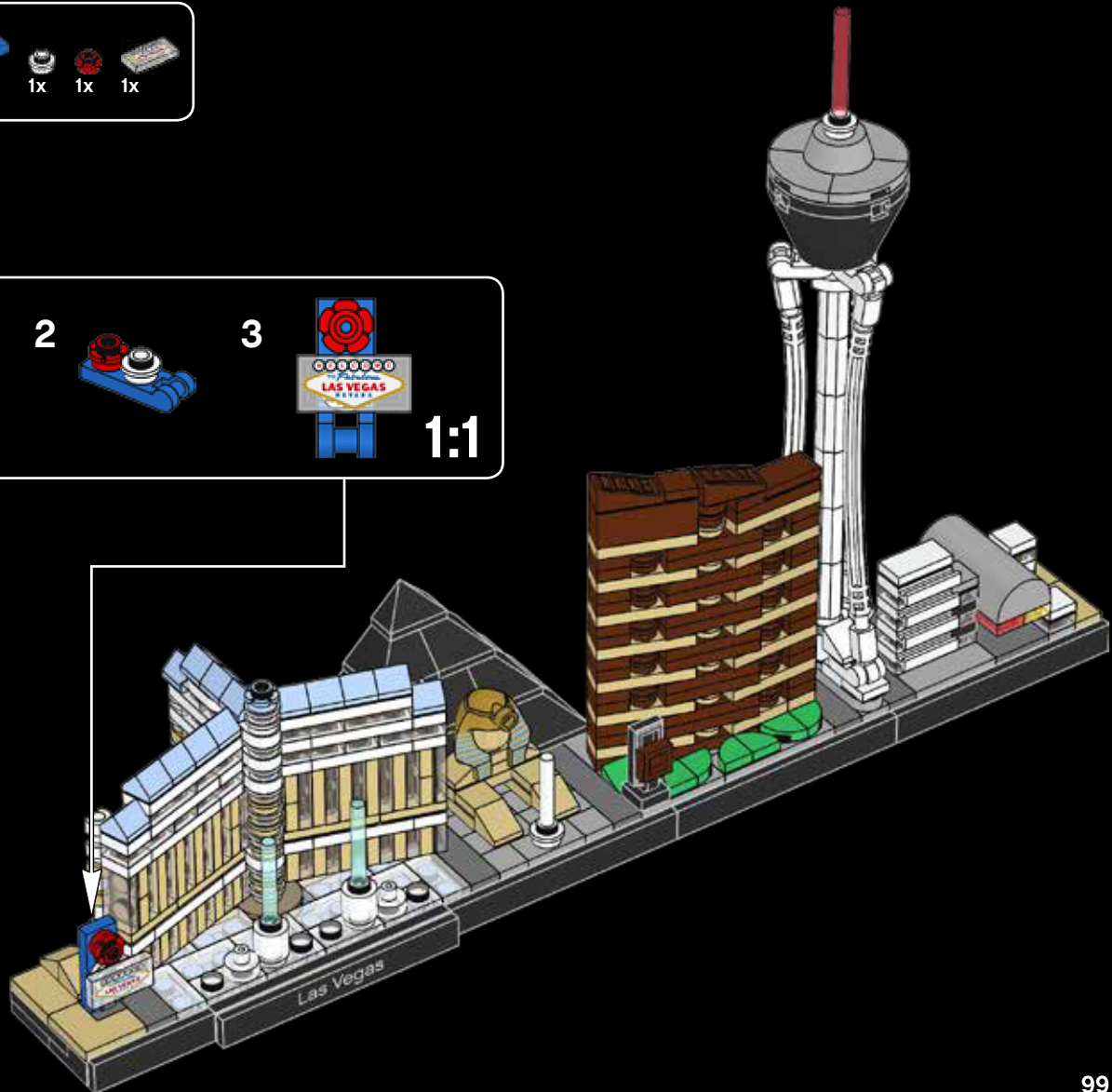



LEGO® Architecture – do you like it?

The LEGO Group would like your opinion on the new product you have just purchased. Your feedback will help shape the future development of this product series. Please visit:

[LEGO.com/productfeedback](https://www.lego.com/productfeedback)

By completing our short feedback survey, you will be automatically entered into a drawing to win a LEGO® prize.

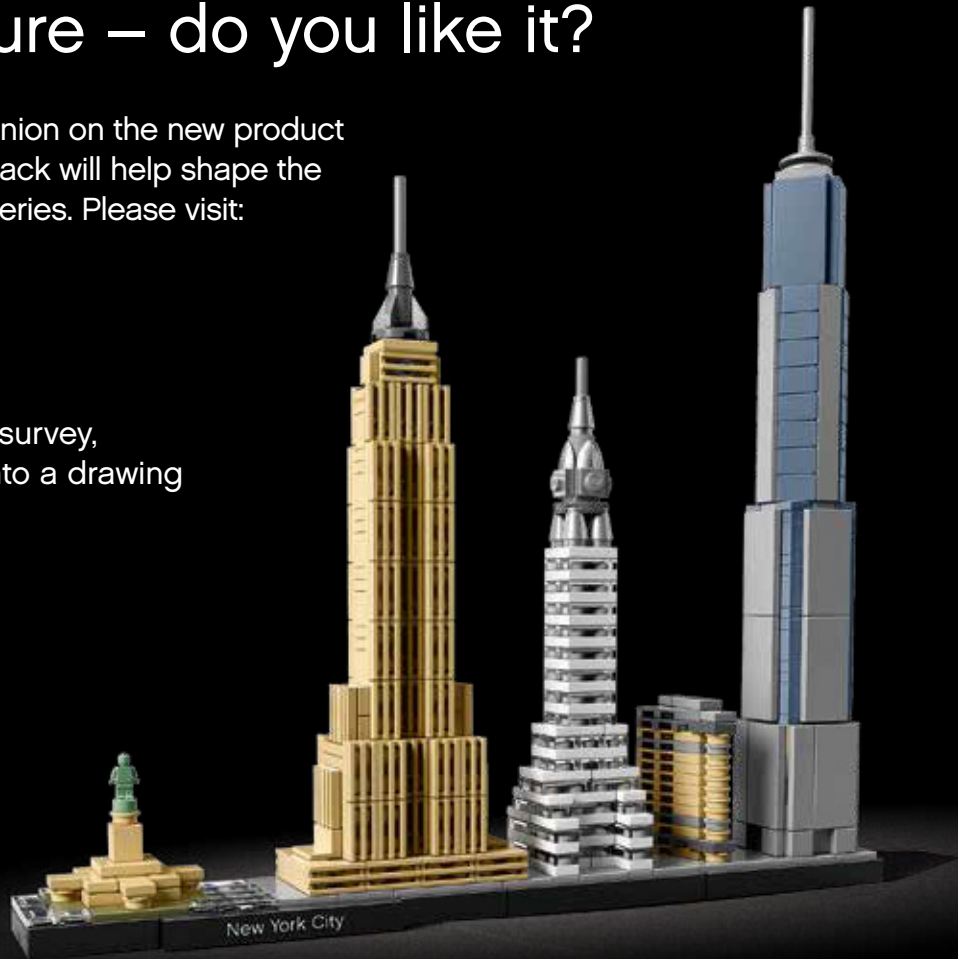



LEGO® Architecture

The LEGO® Architecture series creatively captures the essence of many of the world's most iconic landmarks while giving you an enjoyable and engaging LEGO building experience.

Whether your interest is in travel, design, history or architecture, these sets are a physical memento of a great trip abroad, a famous building you know well, or a city you still dream of visiting.

Every LEGO Architecture set is designed to be displayed. Much more than just a photo, building and displaying your model on your desk, in the bookcase or on the shelf, lets you be transported every time you admire the view.

Follow us on  

Adam Reed Tucker is the co-developer of the LEGO Architecture product line.



Celebrate the world of architecture and collect all the models

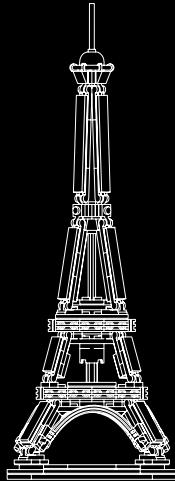

21019
The Eiffel Tower



21028
New York City



21032
Sydney

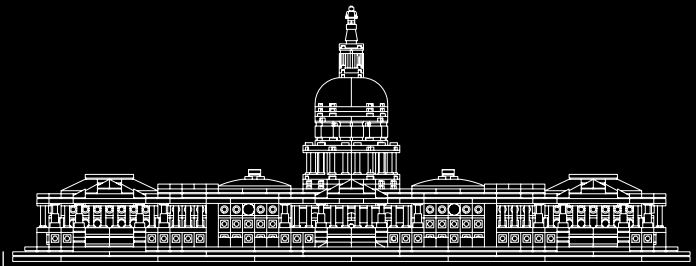

21030
United States Capitol Building



21033
Chicago

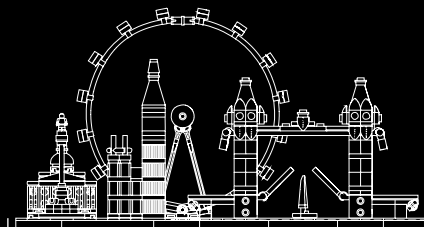

21034
London

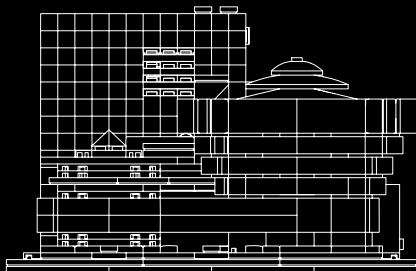

21035
Solomon R. Guggenheim Museum®



21036
Arc De Triomphe

References

Pictures -

© Shutterstock

© Stratosphere Casino, Hotel & Tower

© Fremont Street Experience

Text -

www.lasvegas.com

www.vegasexperience.com

www.stratospherehotel.com

Customer Service
Kundenservice
Service Consommateurs
Servicio Al Consumidor
LEGO.com/service or dial

 00800 5346 5555 ;  1-800-422-5346 ; 

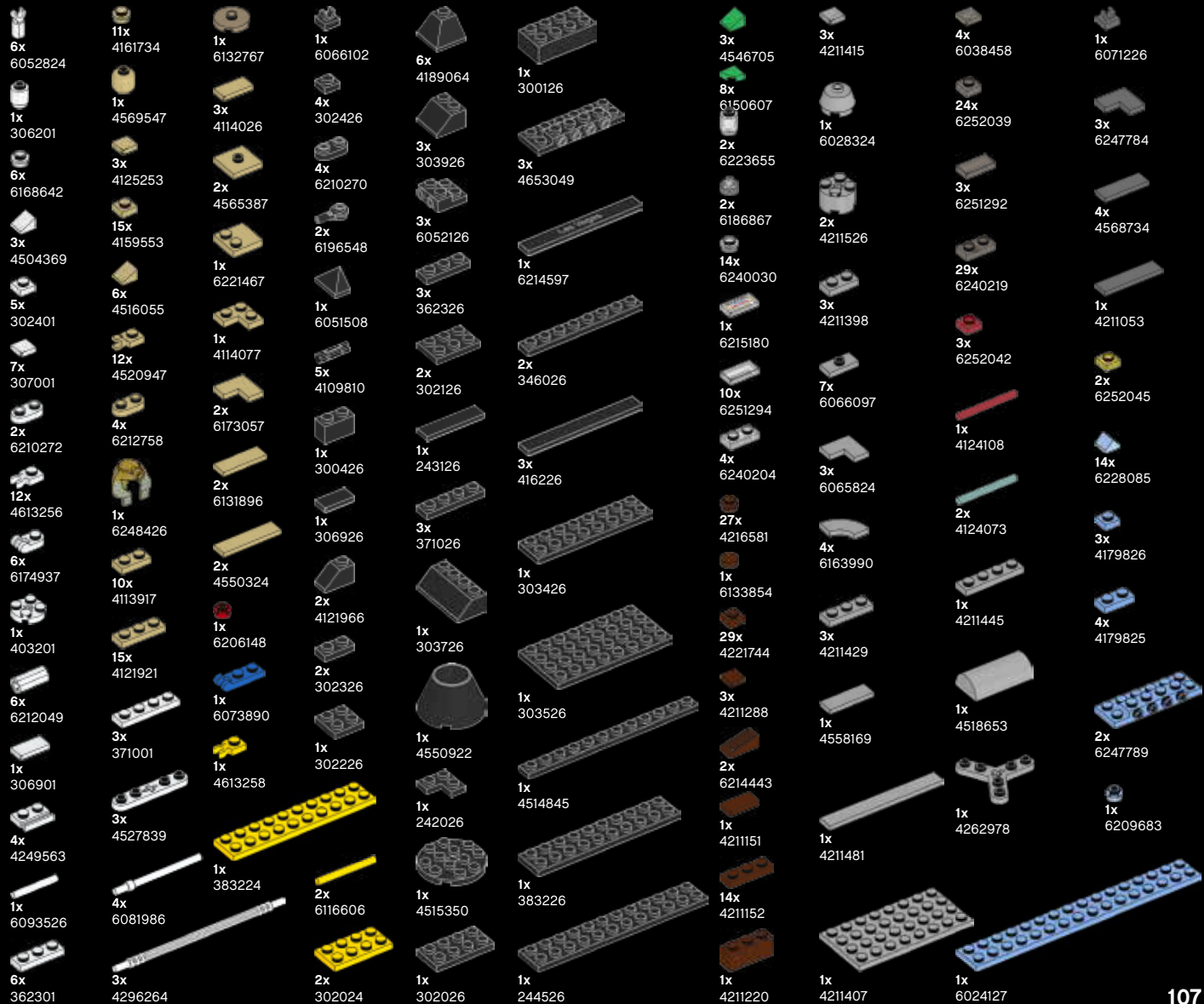

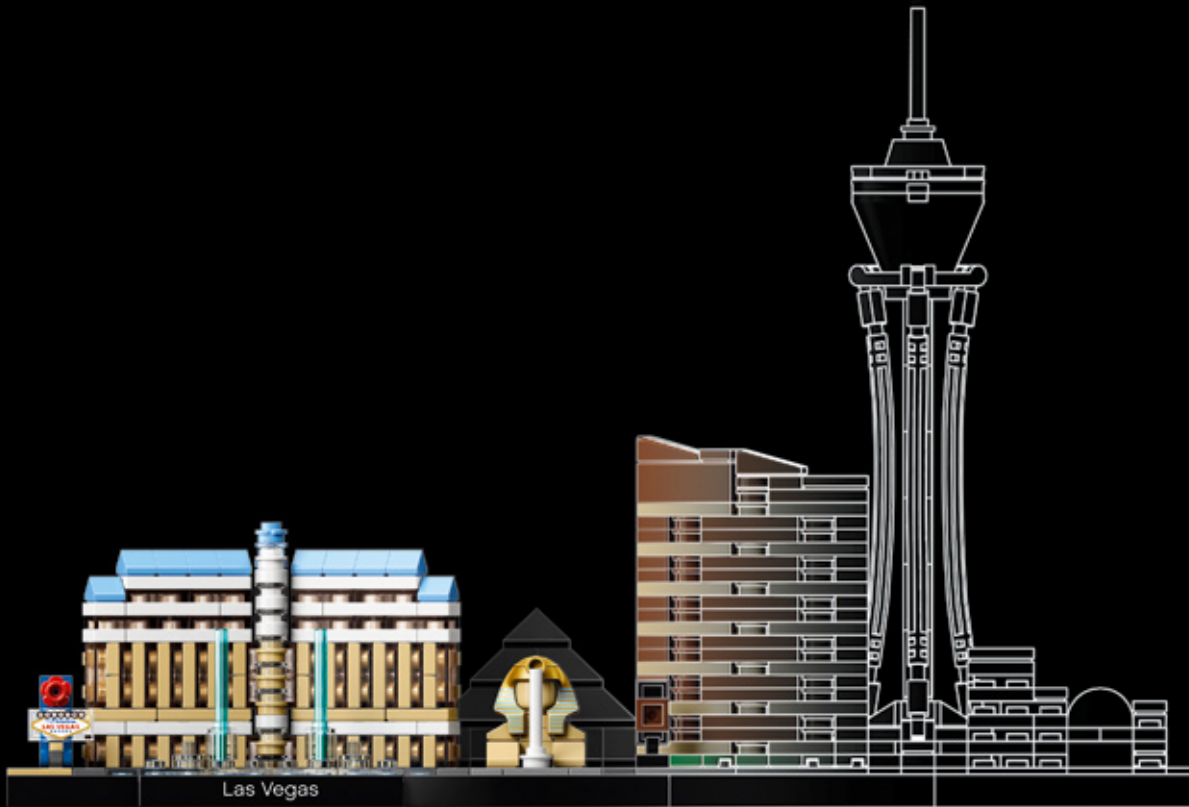

LEGO and the LEGO logo are trademarks of the LEGO Group.
©2018 The LEGO Group. 6254669

Copyright 2018 Fremont Street Experience, LLC. All rights reserved.
Copyright © 2018 Wynn Resorts Holdings, LLC. All rights reserved.
Copyright © 2018 MGM Resorts International. All rights reserved.
Copyright © 2018 Stratosphere Casino, Hotel & Tower. All Rights Reserved.