



# Architecture

21041

## Great Wall of China

China

中国长城

中国

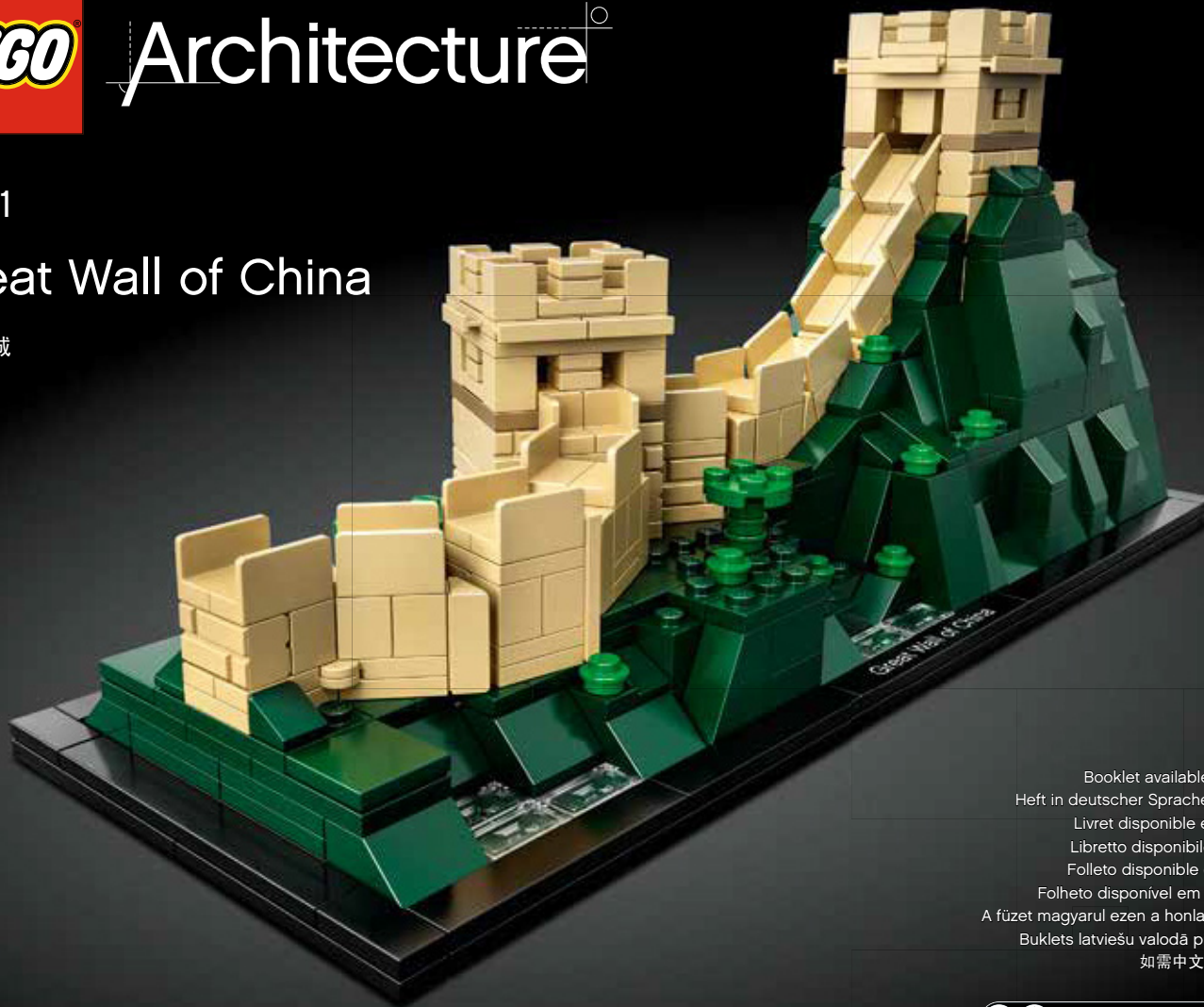

Booklet available in English on  
Heft in deutscher Sprache erhältlich auf  
Livret disponible en français sur  
Libretto disponibile in italiano su  
Folleto disponibile en español en  
Folheto disponível em português em  
A füzet magyarul ezen a honlapon olvasható  
Buklets latviešu valodā pieejams vietnē  
如需中文版手册, 请访问



[LEGO.com/architecture/booklet](https://www.lego.com/architecture/booklet)





*"There in the mist, enormous,  
majestic, silent and terrible,  
stood the Great Wall of China."*

W. Somerset Maugham

## The Great Wall

For over 2000 years the Great Wall has wound its formidable way across the hills and mountains of the Chinese countryside. Its construction helped unify a new empire and strengthened the idea of China as a single nation. As an enduring symbol of China's national pride, the wall remains one of the most impressive feats in the history of architecture.



Many people imagine the Great Wall to be one long uninterrupted structure. In reality it is more a 13,000 miles (21,000 km) network of walls that reflect the rise and fall of numerous kingdoms and dynasties. As such, the story of the Great Wall is also the story of China as the nation we recognize today.

In the 3rd Century B.C., Emperor Qin Shi Huang conquered his six neighboring kingdoms, establishing the Qin Dynasty and becoming the first Emperor of China. As well as linking together the many defensive walls the smaller kingdoms had built, he ordered the building of a new northern wall to protect his new empire from marauding tribes.

The following dynasties extended the wall further, but it was during the Ming Dynasty that much of the wall that we recognize today was constructed. In a period that stretched over 100 years, over 5,500 miles (8,850 km) of wall was added. Unlike the first walls that had often been built using compacted earth or wood, these latest sections were made of carved stone or brick. Forts, flanking towers and ramparts were added to create a formidable defensive line.

The end of the Ming Dynasty in 1644 also signaled the end of any construction or maintenance of the Great Wall. This would continue until sections of the wall were restored and opened to the public by the government of the People's Republic of China in the 1950s.

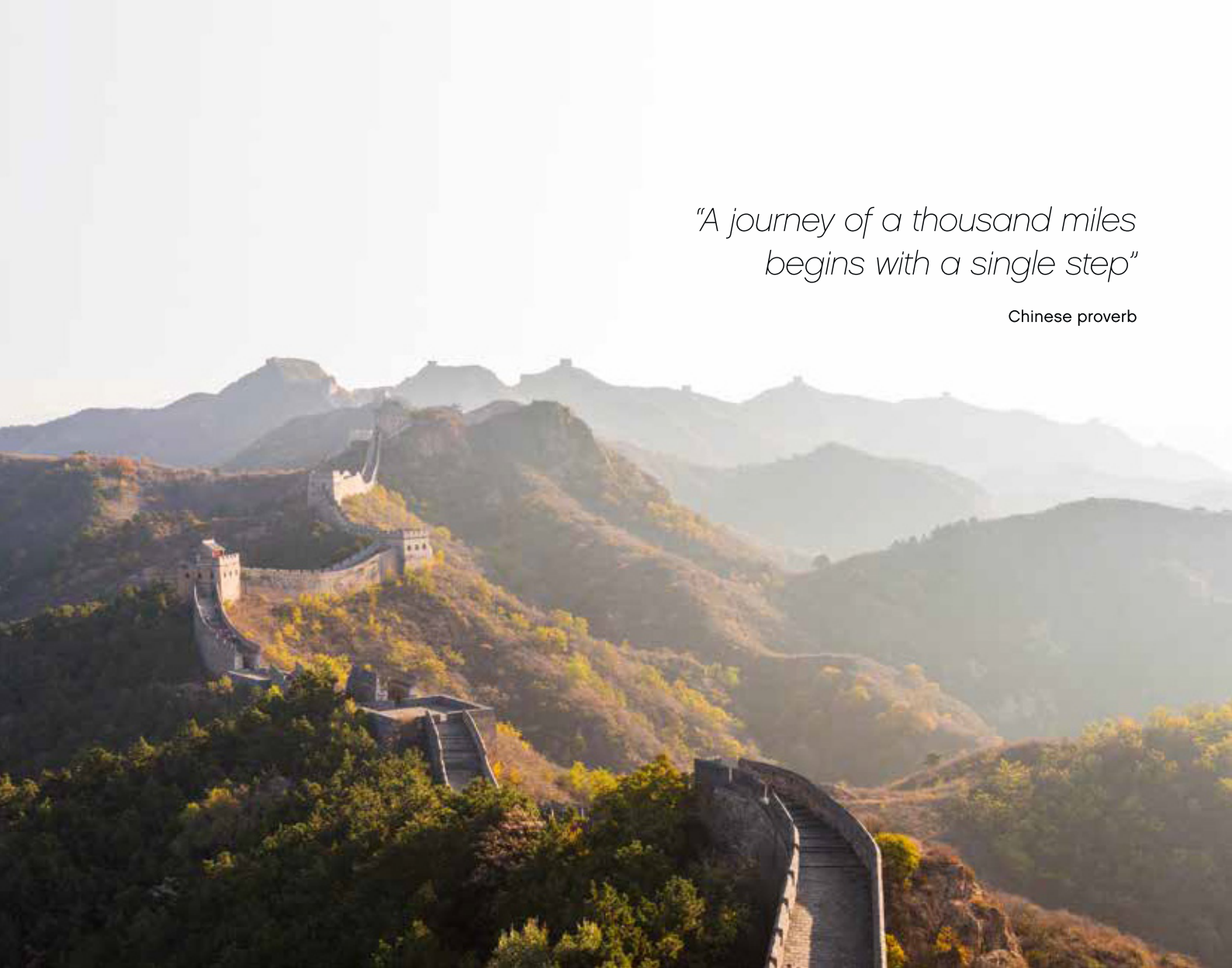

A scenic view of the Great Wall of China winding across rolling hills and mountains under a clear sky. The wall is the central focus, curving through the landscape. The hills are covered in green and yellow foliage, suggesting an autumn setting. The sky is a pale, clear blue.

*"A journey of a thousand miles  
begins with a single step"*

Chinese proverb

# From then to now

It took several different Dynasties and over 2000 years to create the Great Wall we recognize today.

770 - 476 BC

## The Spring & Autumn Period

Seven warring kingdoms built the first walls to protect their borders.

221 - 206 BC

## The Qin Dynasty

Qin Shi Huang becomes the first Emperor of China and builds a northern wall to defend his new empire from Mongol harassment.

206 - 220 AD

## The Han Dynasty

Extended the wall westward to protect the growing trade travelling via the Silk Road.

618 - 907 AD

## The Tang Dynasty

Was one of the most prosperous and peaceful dynasties in Chinese history with little construction to the wall.



960 - 1279 AD

### The Song Dynasty

Enlarged and improved the wall in an attempt to stop invasion by the Manchus and Mongols.

1271 - 1368 AD

### The Yuan Dynasty

The wall fails to stop the Mongol invasion and China comes under the control of the Mongol Empire.

1368 - 1644 AD

### The Ming Dynasty

The Chinese regain control of the country and set about systematically rebuilding and strengthening the Great Wall.

1644 - Present

### Post-Ming

The Manchus breach the wall and end the last Chinese dynasty. The wall falls into disrepair.





*“Until you reach the Great Wall,  
you are no hero”*

Chairman Mao

While foreign travelers have always marveled at the Great Wall, the Chinese themselves only started to appreciate the massive structure midway through the 20th century. This was partly due to the historical financial and human costs of building the wall: heavy taxes had been imposed to pay for it and it's estimated that hundreds of thousands of soldiers, laborers and convicts died during its construction. But also because it had failed to stop the invasions it was built to hinder.

Today the wall plays a major part in the Chinese national identity, and the restored sections, especially around Badaling, have become a major tourist destination with over 10 million visitors each year. The wall was made a UNESCO World Heritage Site in 1987, and has long been regarded as one of the seven modern wonders of the world.









*"He who has never been to the  
Great Wall is not a true man."*

Chinese poem

Many myths and legends have emerged about the Great Wall. Unfortunately, the most famous one, that it is the only man-made structure on earth that can be seen with the naked eye from outer space, is untrue. At best, the wall can be spotted during a low orbit, but even then only if sunlight and weather permits it.







“长城在迷蒙中赫然矗立着，巨大雄壮，沉默威严。”

威廉·萨默塞特·毛姆

## 长城

2000多年来，雄伟的长城穿行在中国的崇山峻岭之间。它的修建有助于新王朝的统一，并强化了中国大一统的思想。作为中华民族自豪感的一个永恒象征，长城是世界建筑史上最令人难忘的壮举之一。



很多人都认为长城是一个绵延万里的连续性建筑。事实上，它更是一个长达21000公里（13000英里）的防御工程体系，见证了无数王朝的兴衰。鉴于此，长城的故事同时也是当代中国的故事。

公元前3世纪，秦始皇统一六国，建立了秦朝，成为了中国历史上第一位皇帝。他不仅将各诸侯国原有的长城连接起来，而且下令在北境修筑新的长城，以保护新帝国免受匈奴的侵扰。

尽管后续各朝都对长城进行了扩建延伸，但直到明代，经过大规模兴建之后，才形成了我们今天所看到的长城。在明朝中期的100多年间，新建了8850多公里（5500英里）的长城。不像首批长城那样使用压实的泥土或木材，明长城的最新段采用了砖石结构。还增建了戍堡、侧翼敌楼和城墙，形成了一道强大的防御体系。

1644年明朝的结束也标志着长城的建造或修缮工作自此终结。直到1950年，中华人民共和国政府对部分长城进行了修复，并对公众开放。



“不积跬步，无以至千里”

中国谚语



# 从那时起到现在，

历经多个朝代——2000多年——的建造和修复，  
造就了我们今天所熟知的长城！

公元前770 - 476年

## 春秋战国时期

战国七雄逐鹿中原之时，  
各国为保护其边境建造了首批长城。

公元前221 - 206年

## 秦朝

秦始皇成为中国的第一位皇帝，为了防止  
匈奴的侵扰，保障新建帝国的安全，开始  
修筑北部的长城。

公元前206年 - 公元220年

## 汉朝

将长城向西延伸，  
维护了丝绸之路的畅通和安全。

公元618 - 公元907年

## 唐朝

是中国历史上最繁荣和平的  
朝代，长城建造也很少。



公元960 - 公元1279年

### 宋朝

扩建并改进了长城，试图阻止金朝和蒙古的入侵。

公元1271 - 公元1368年

### 元朝

长城未能阻止蒙古的入侵，中国汉族被蒙古帝国统治。

公元1368 - 公元1644年

### 明朝

中国汉族重新夺得了全国的政权，并对长城进行了系统化的重建和加固。

公元1644年 - 至今

### 南明王朝

满族突破长城，结束了大明王朝之后，长城便被遗弃。





## “不到长城非好汉”

毛主席

就在外国旅客惊叹于长城的雄伟之时，中国人自己才开始欣赏20世纪中期的宏大建筑。这一方面由于修筑长城时的无数人力和财力投入：为修建长城所征收的繁重赋税，据估计有成千上万的士兵、劳力和罪犯埋骨长城脚下。另一方面由于长城未能阻挡外族入侵。

今天，长城成为了中国国家的一个重要标志，那些修复的部分，尤其是八达岭段，已成为了一个主要旅游景点，每年接待1000多万名游客。长城于1987年列入世界文化遗产，并一直被认为是世界七大奇迹之一。









## “不到长城非好汉”

中国诗句

关于长城涌现了许多神话和传说。不幸的是，其中最著名的一个——长城是从外太空中唯一一个可用肉眼看到的人造建筑——是不真实的。在最好情况下——处于近地轨道，并且太阳光照和天气允许，才能发现长城。



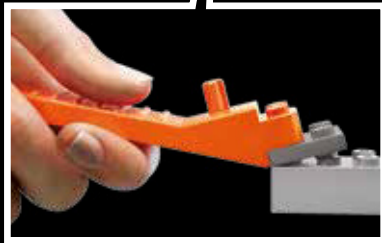
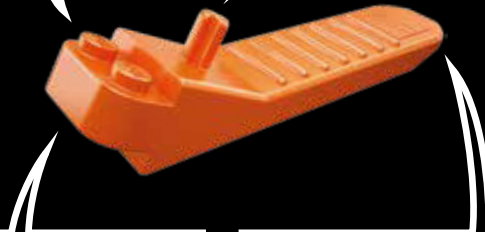
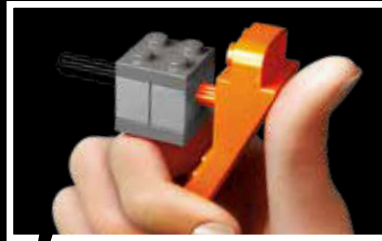
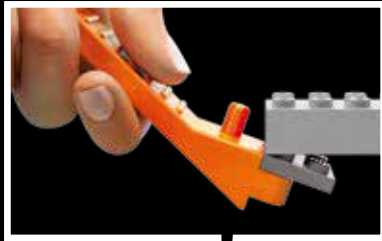

[LEGO.com/brickseparator](https://LEGO.com/brickseparator)

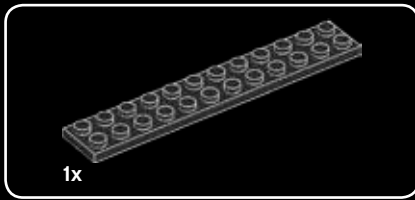

1

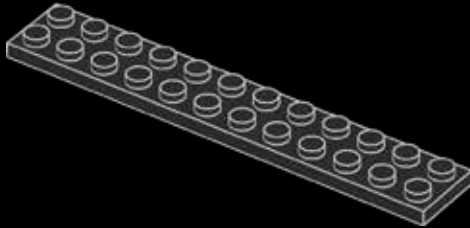

2

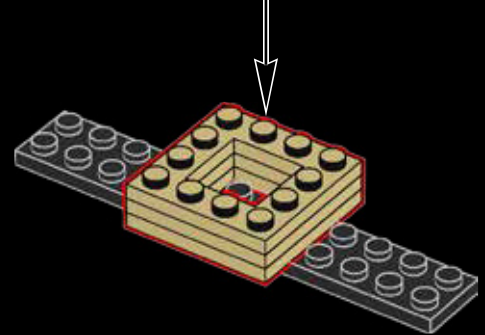
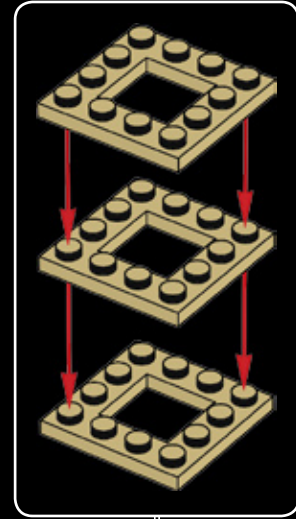

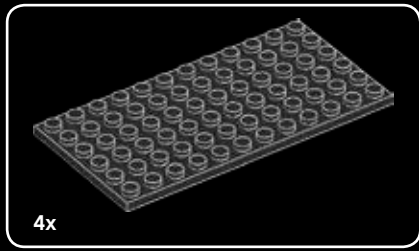

3

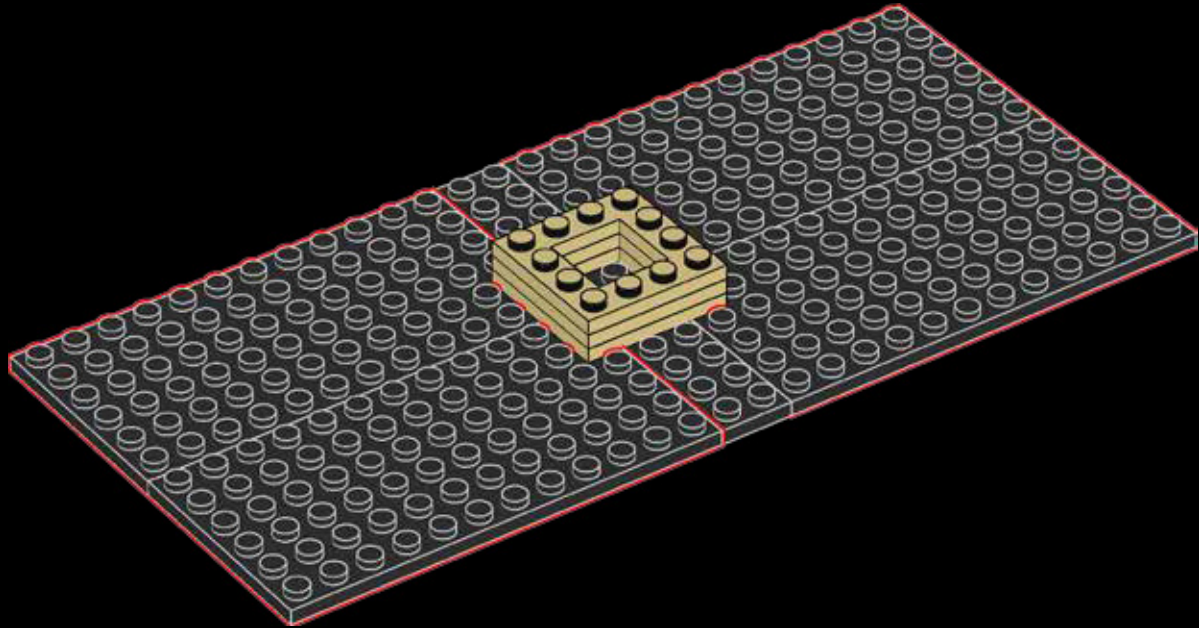



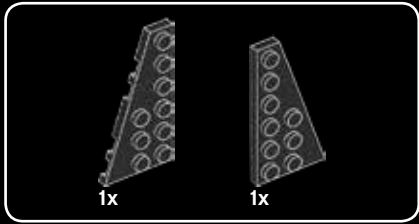

4

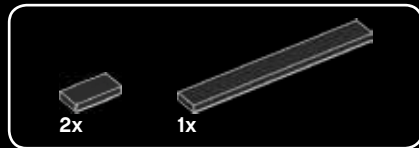
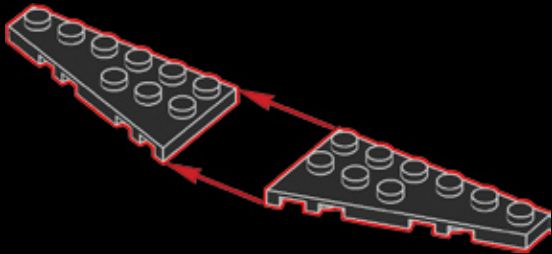

5

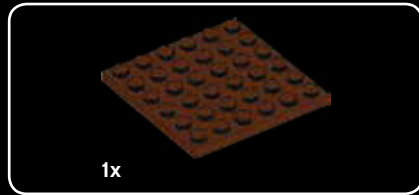
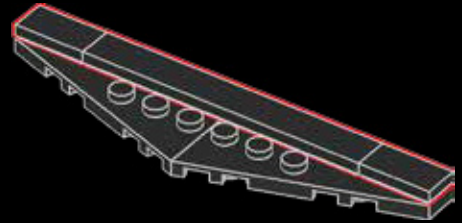

6

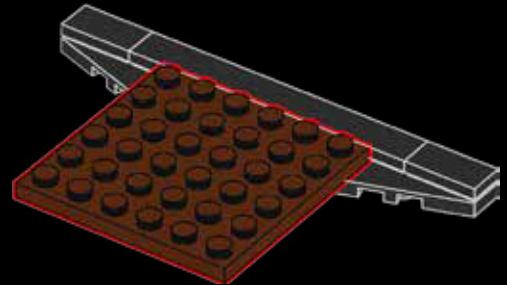

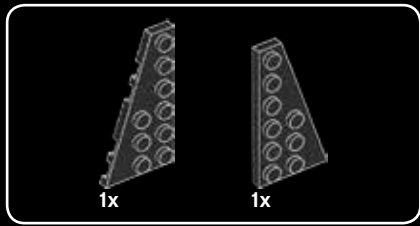

7

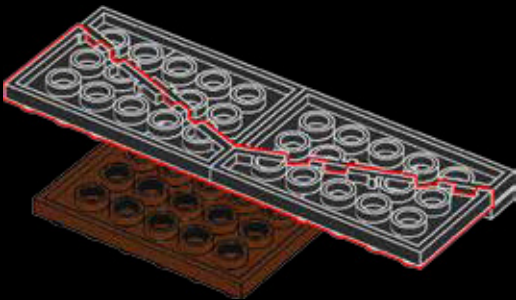

8

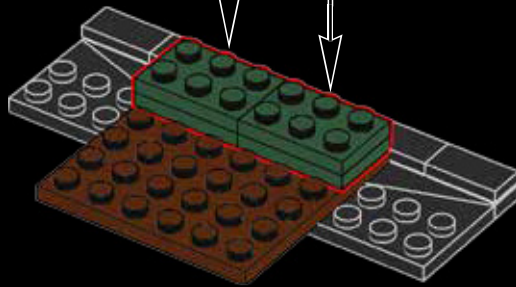
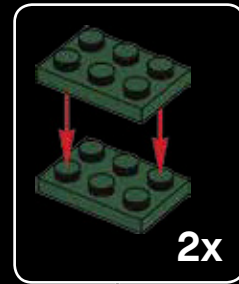

2x

The average width of the wall is 21.3 ft. (6.5 m)  
长城的平均宽度为6.5米（21.3英尺）。



9

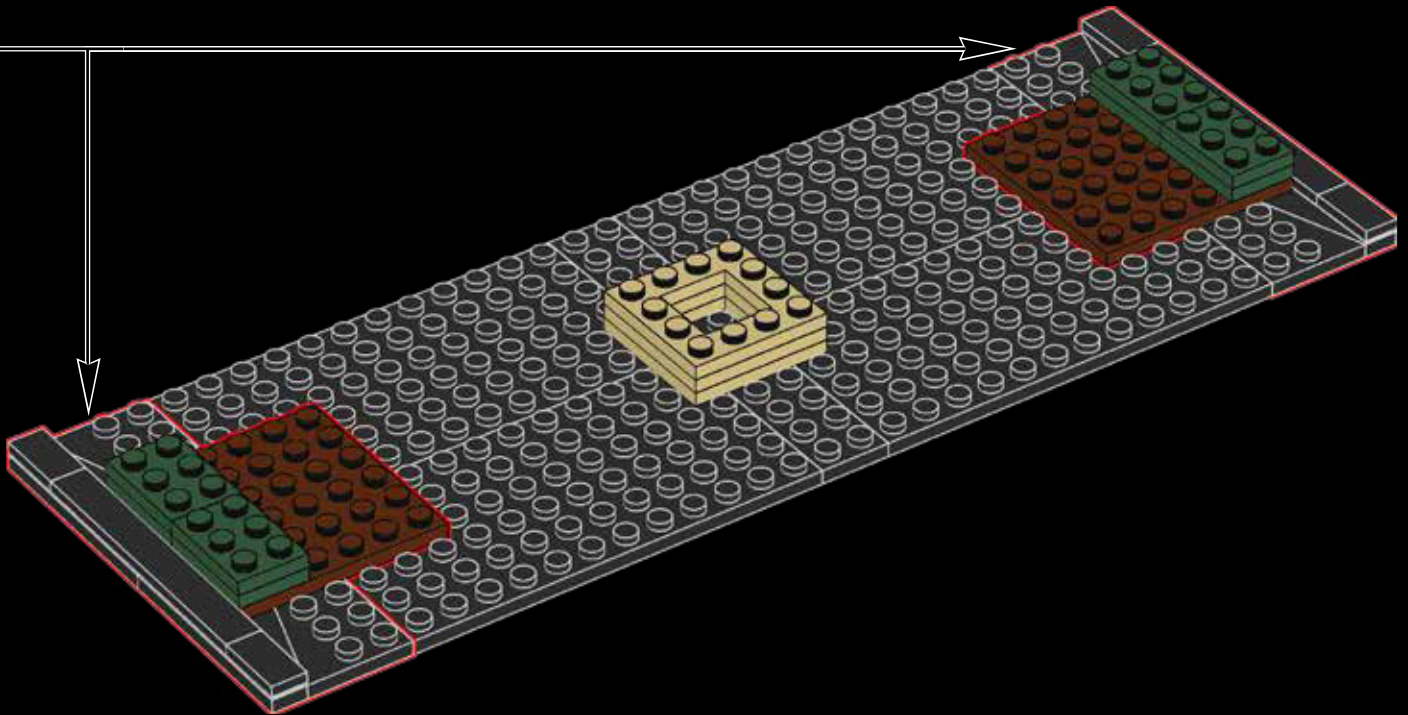

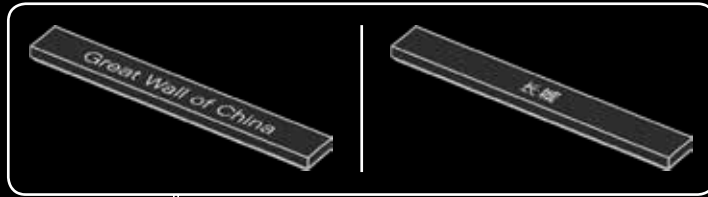
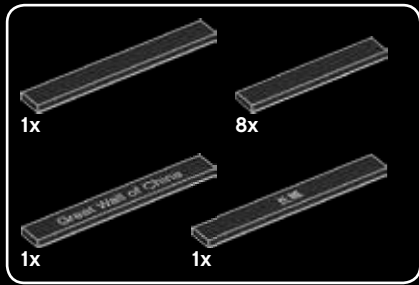

10

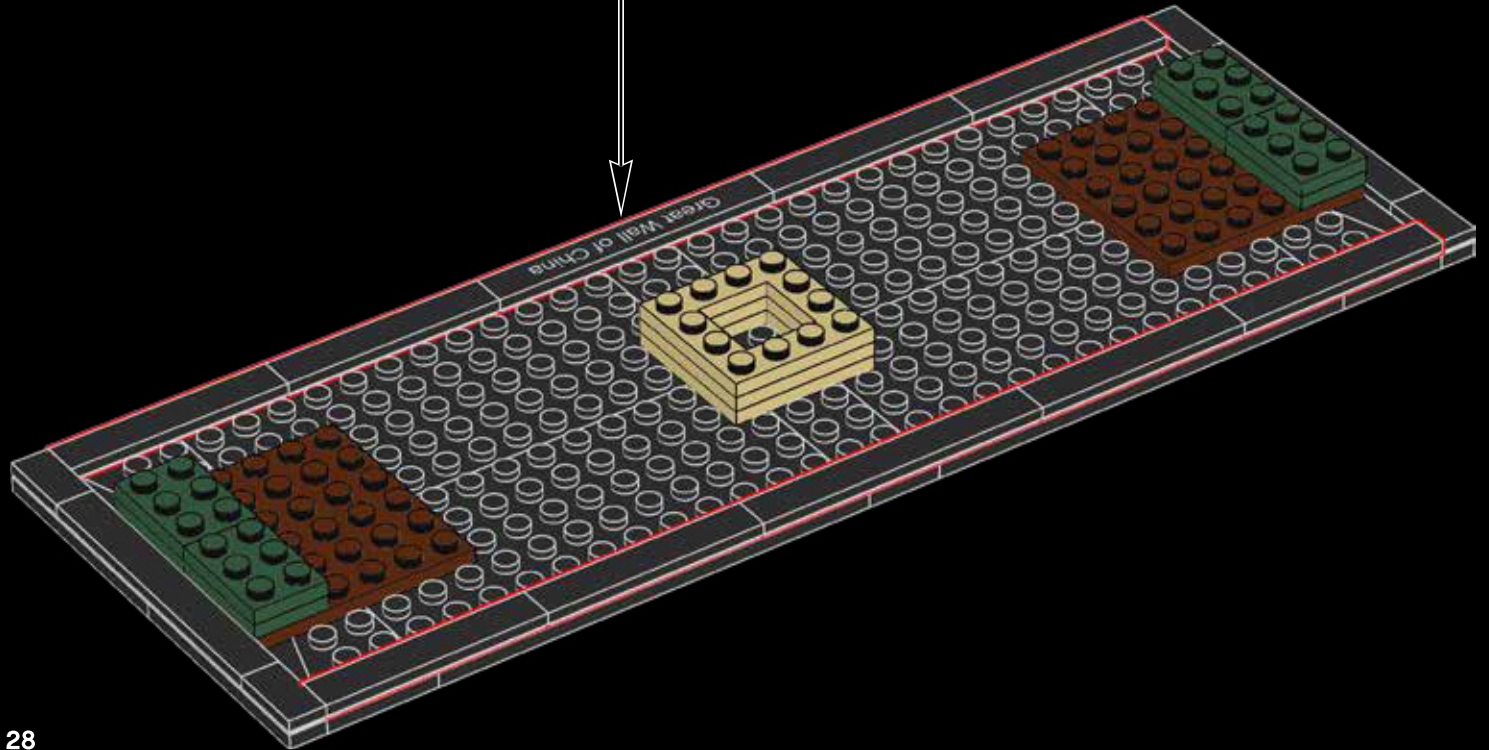

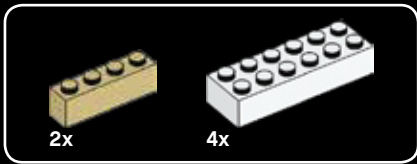

11

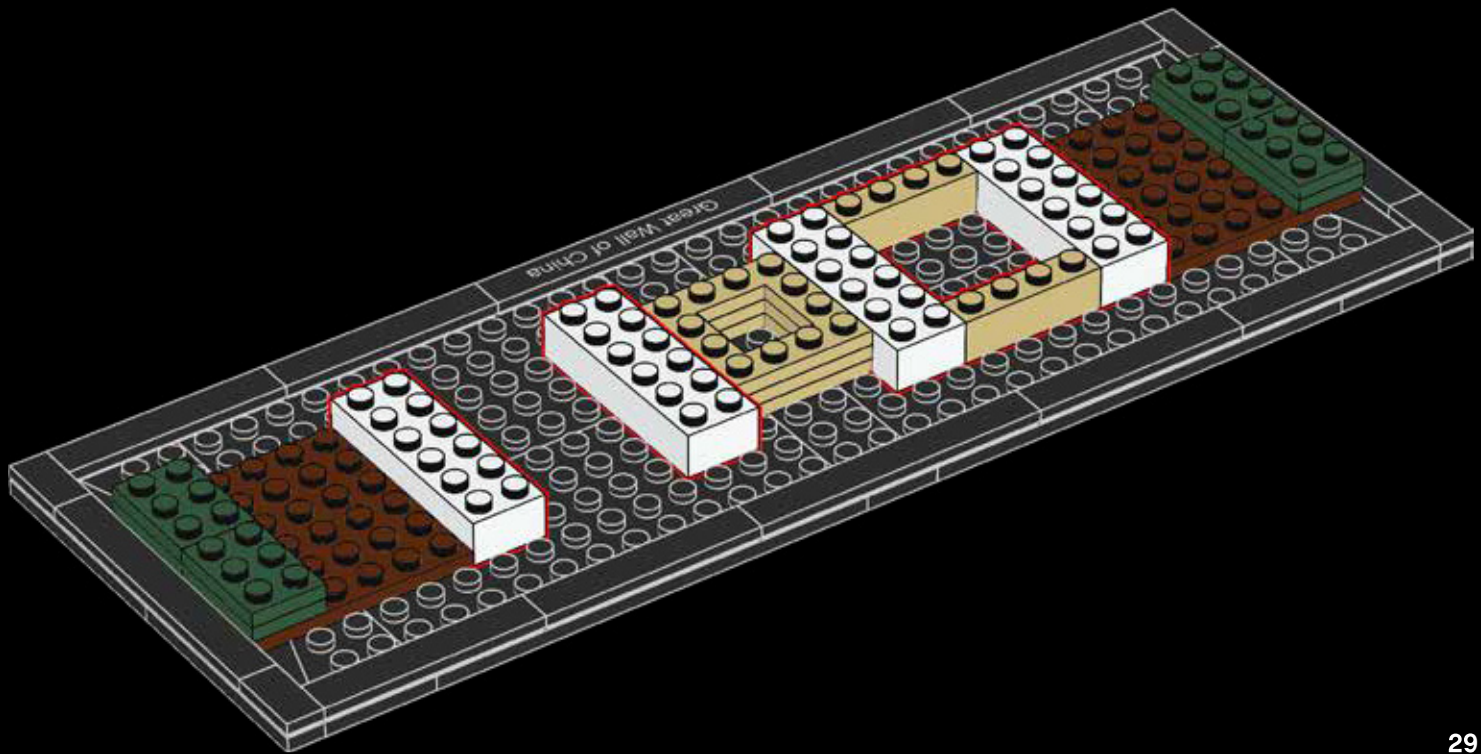





12

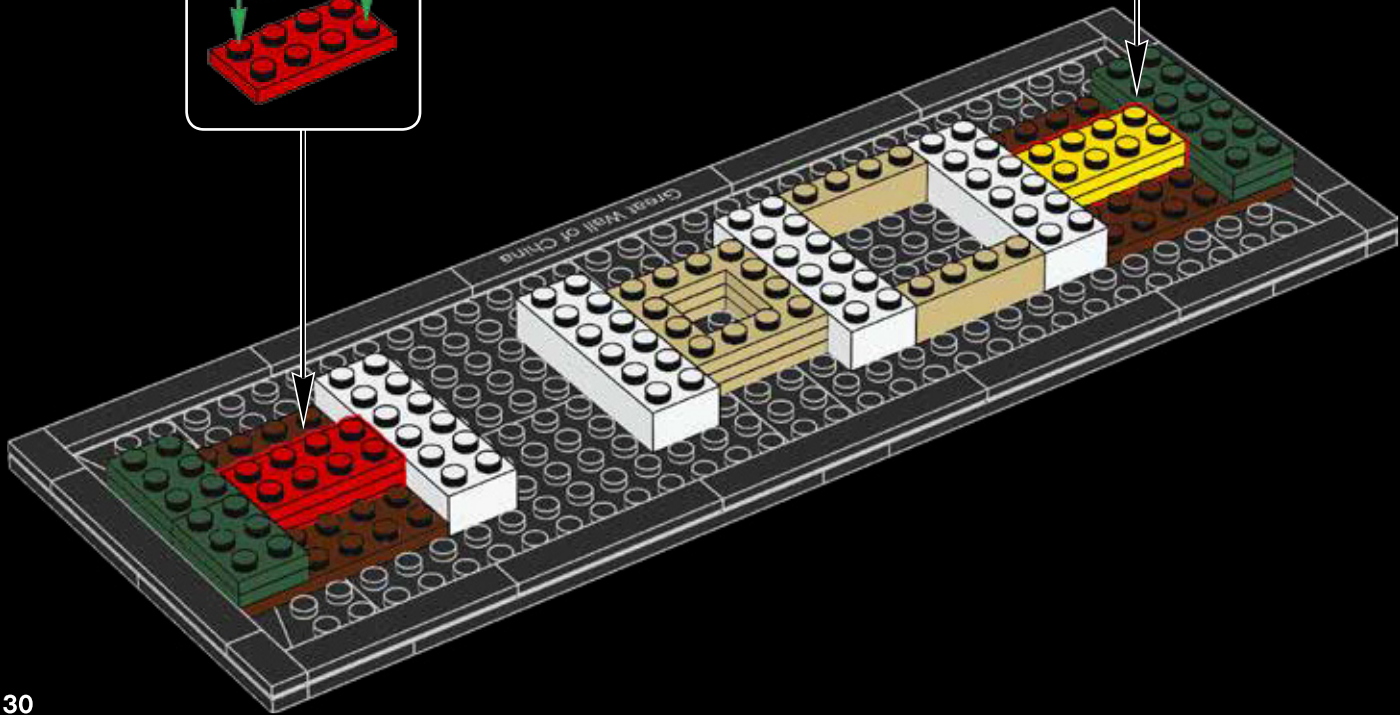
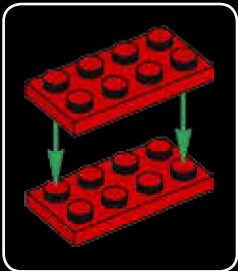
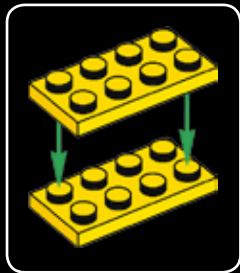



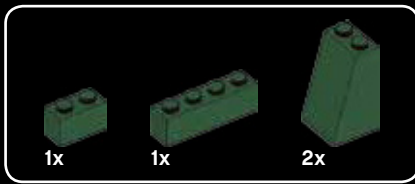

13

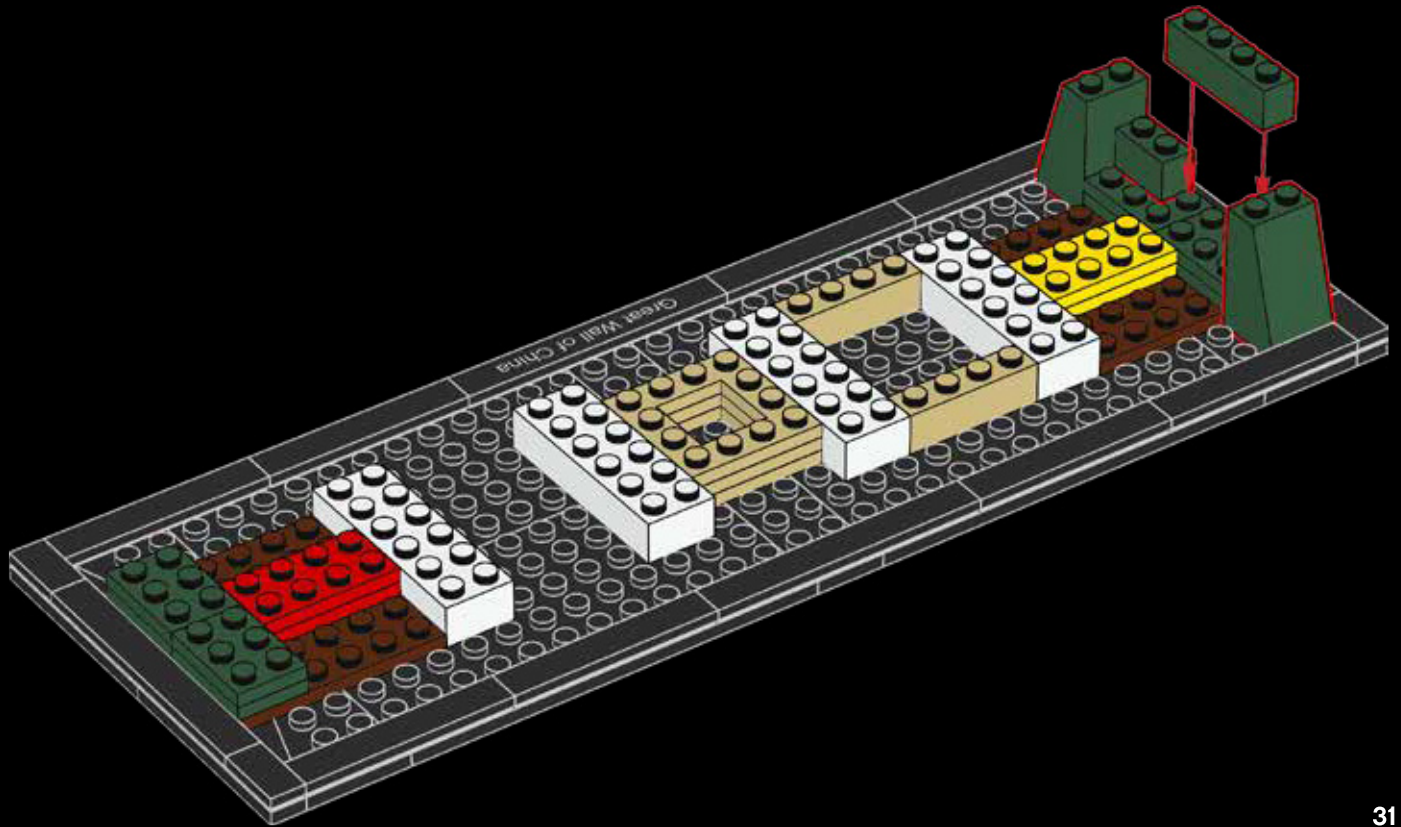



14

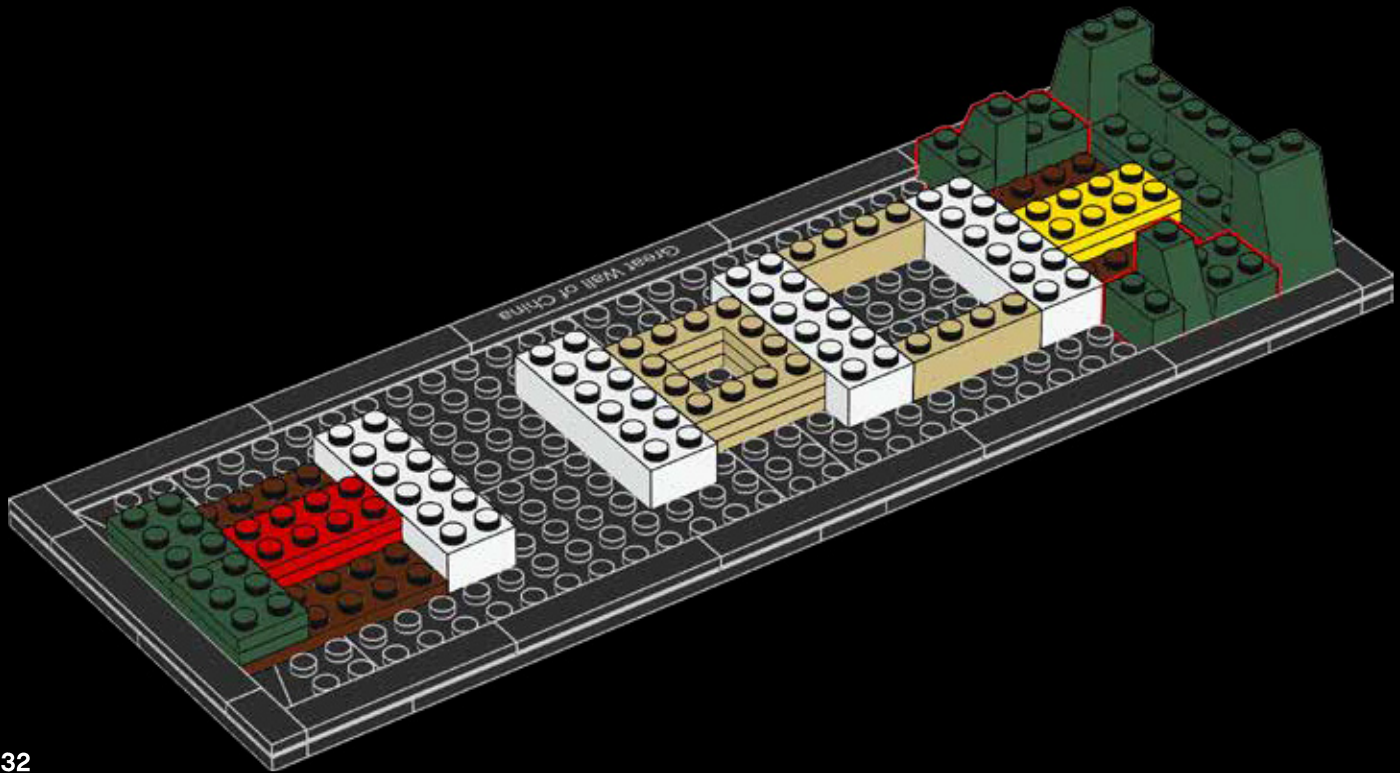

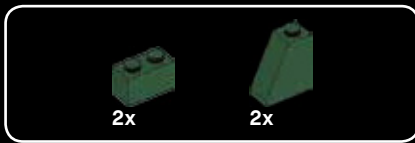

15

New sections of the wall continue to be discovered, especially around the border of present-day Mongolia. 新段的长城遗址被持续发现，尤其是在今天的蒙古边界。

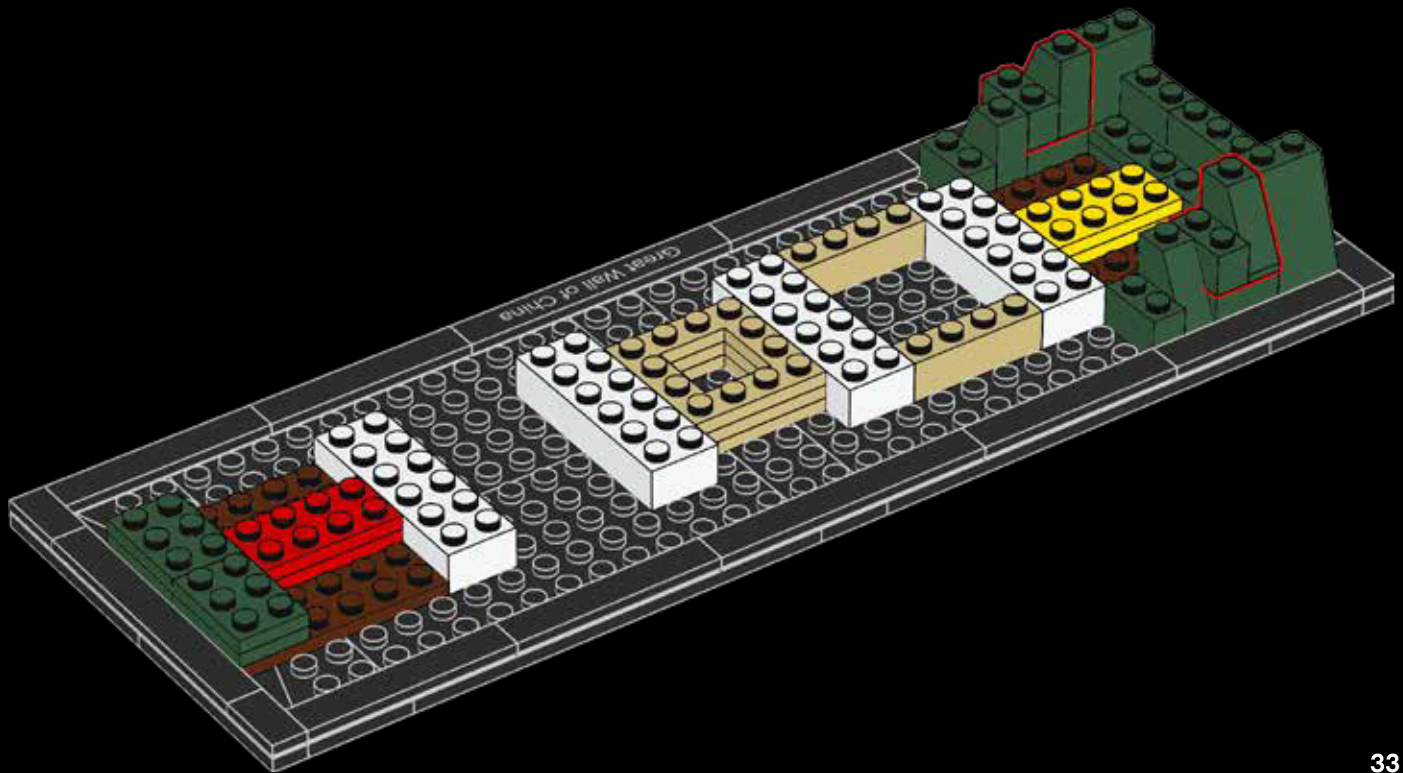



# 16

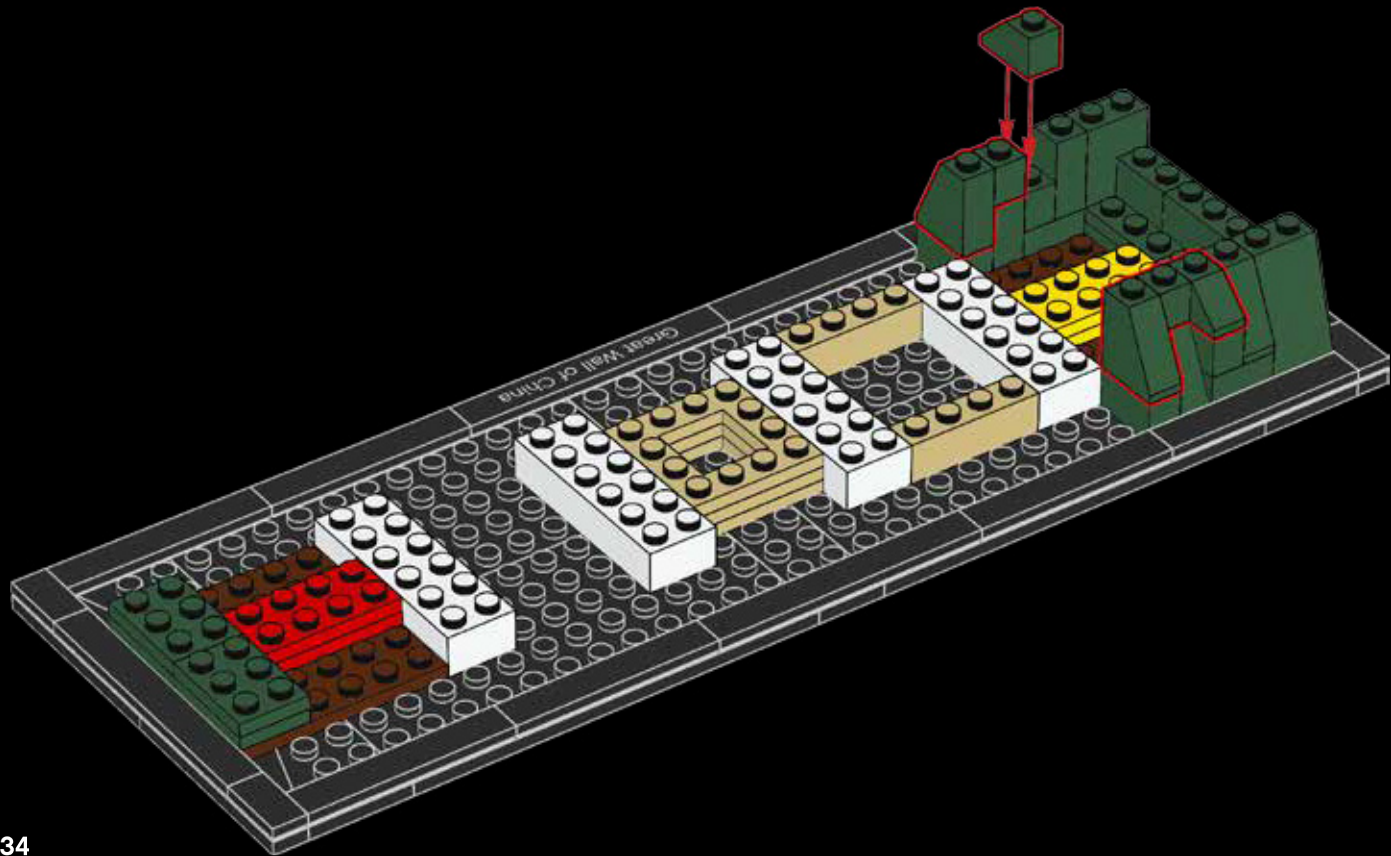



17

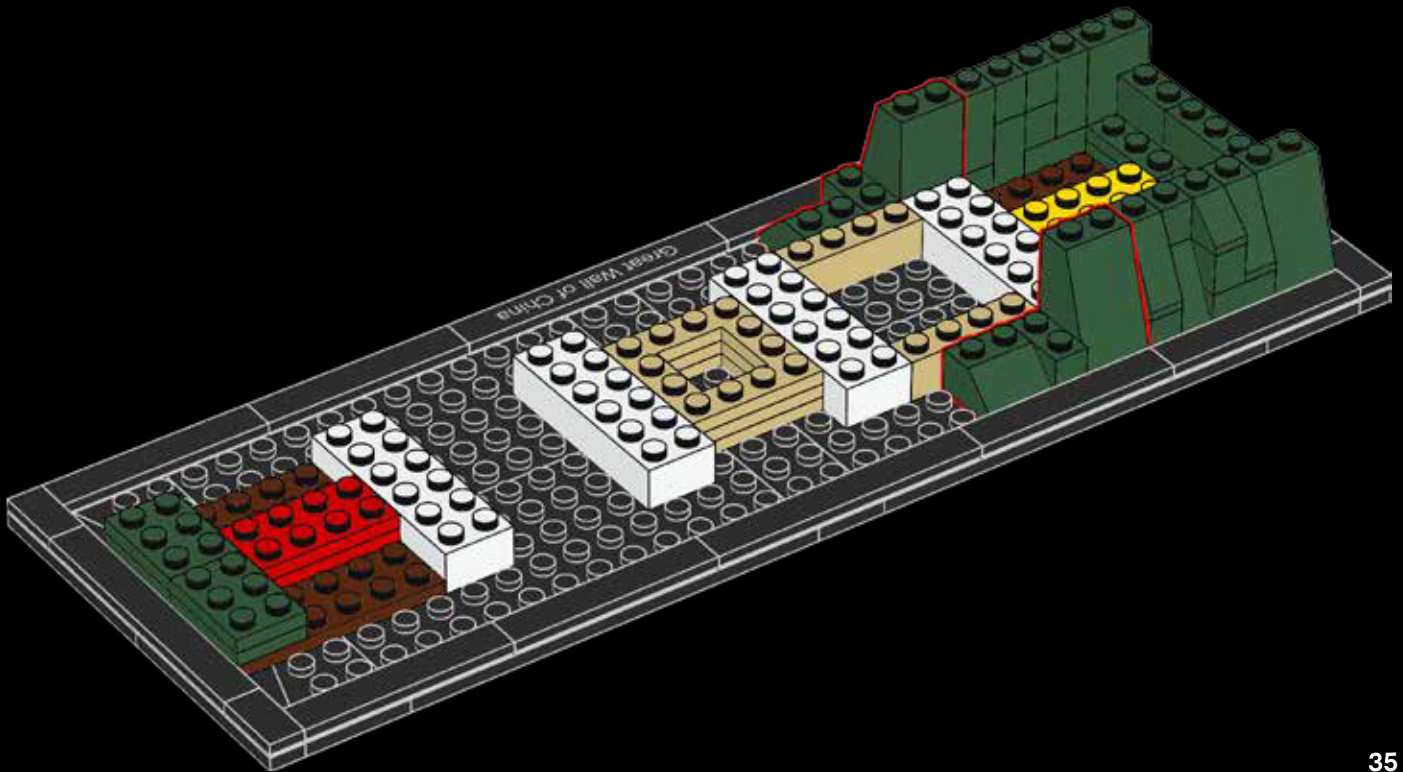



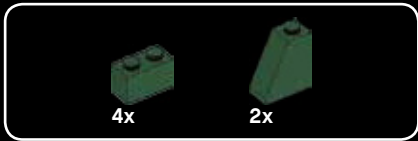

18

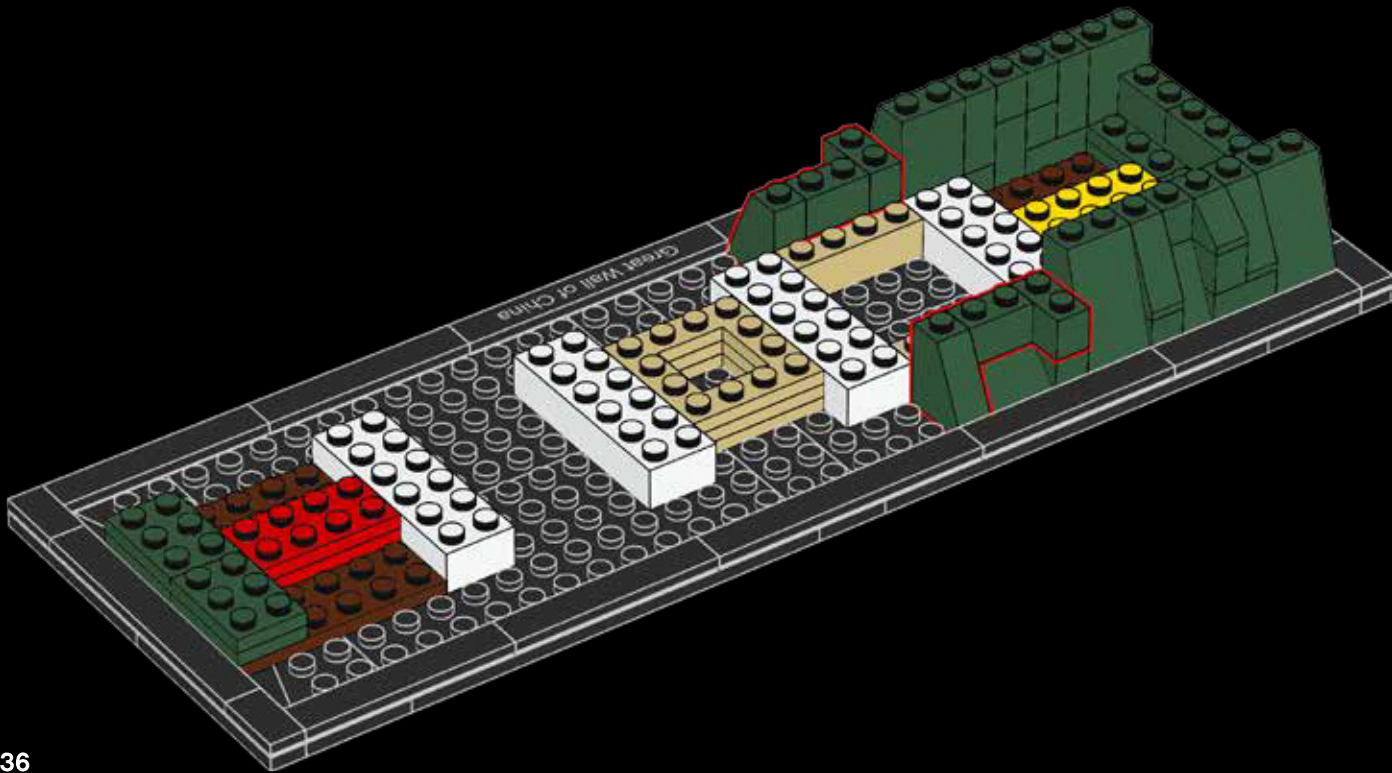



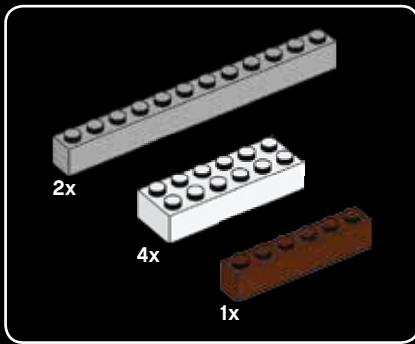

19

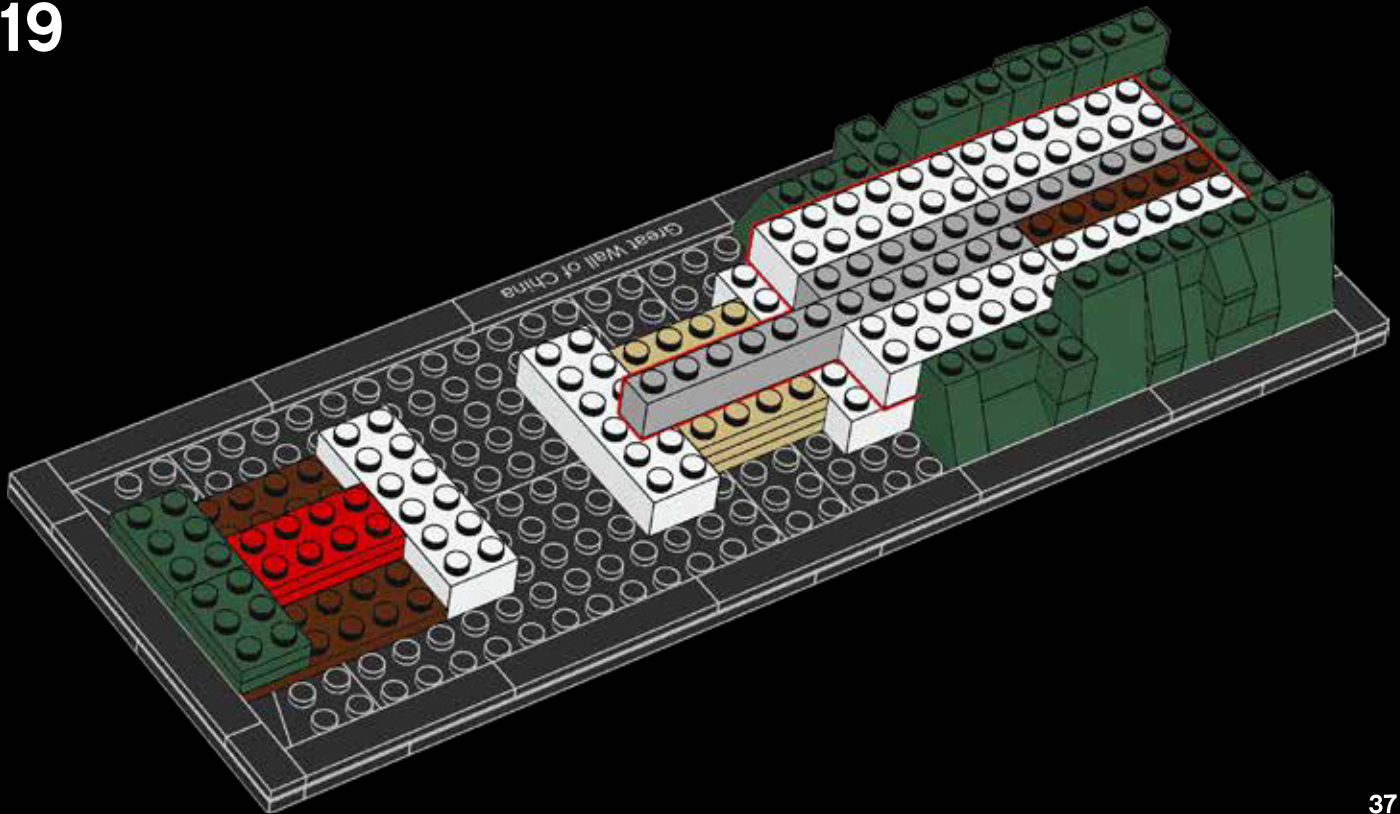



20

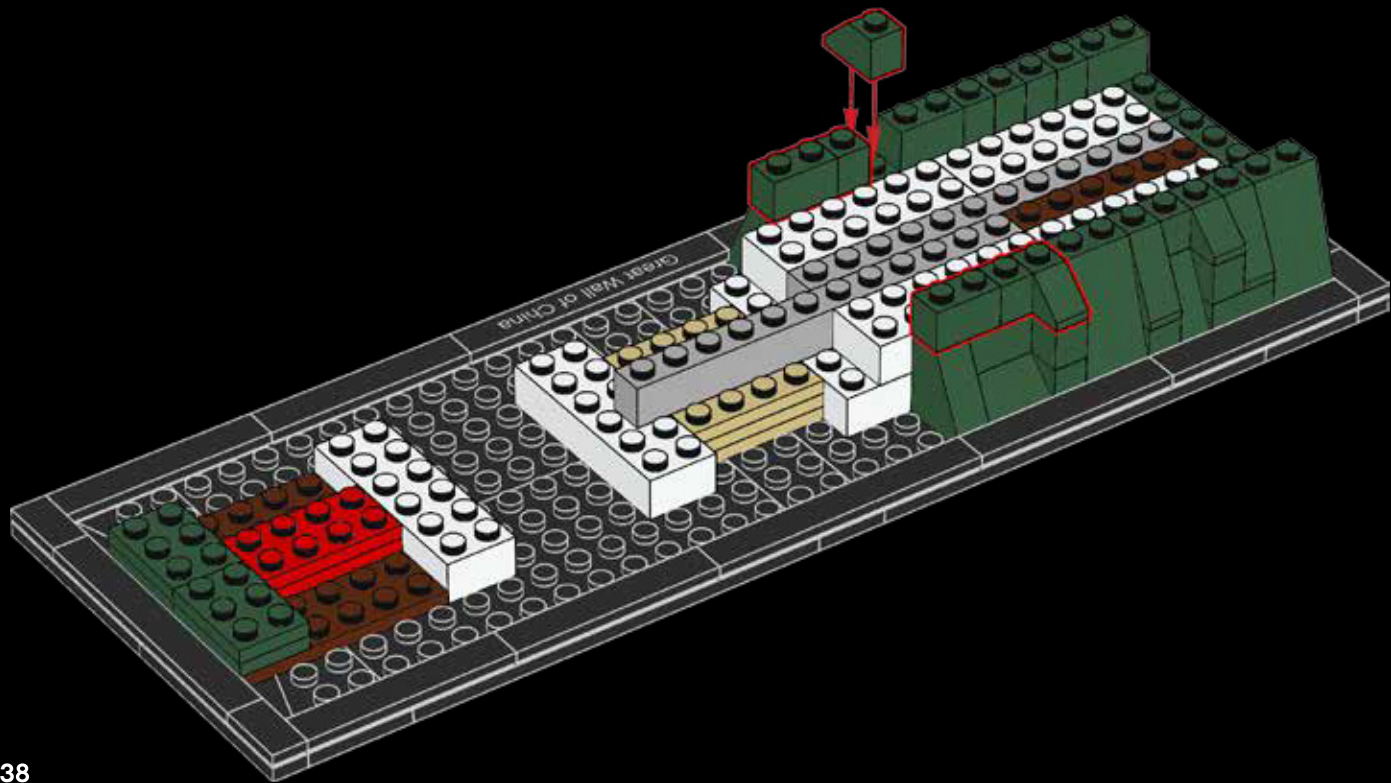



# 21

During the 1960s and 1970s, miles of the wall were stripped of bricks to build civilian housing. In the 1960s and 1970s, miles of the Great Wall of China were stripped of bricks to build civilian housing.

在20世纪60年代和70年代，数英里的长城被拆毁，拆下的砖用于建筑民居。

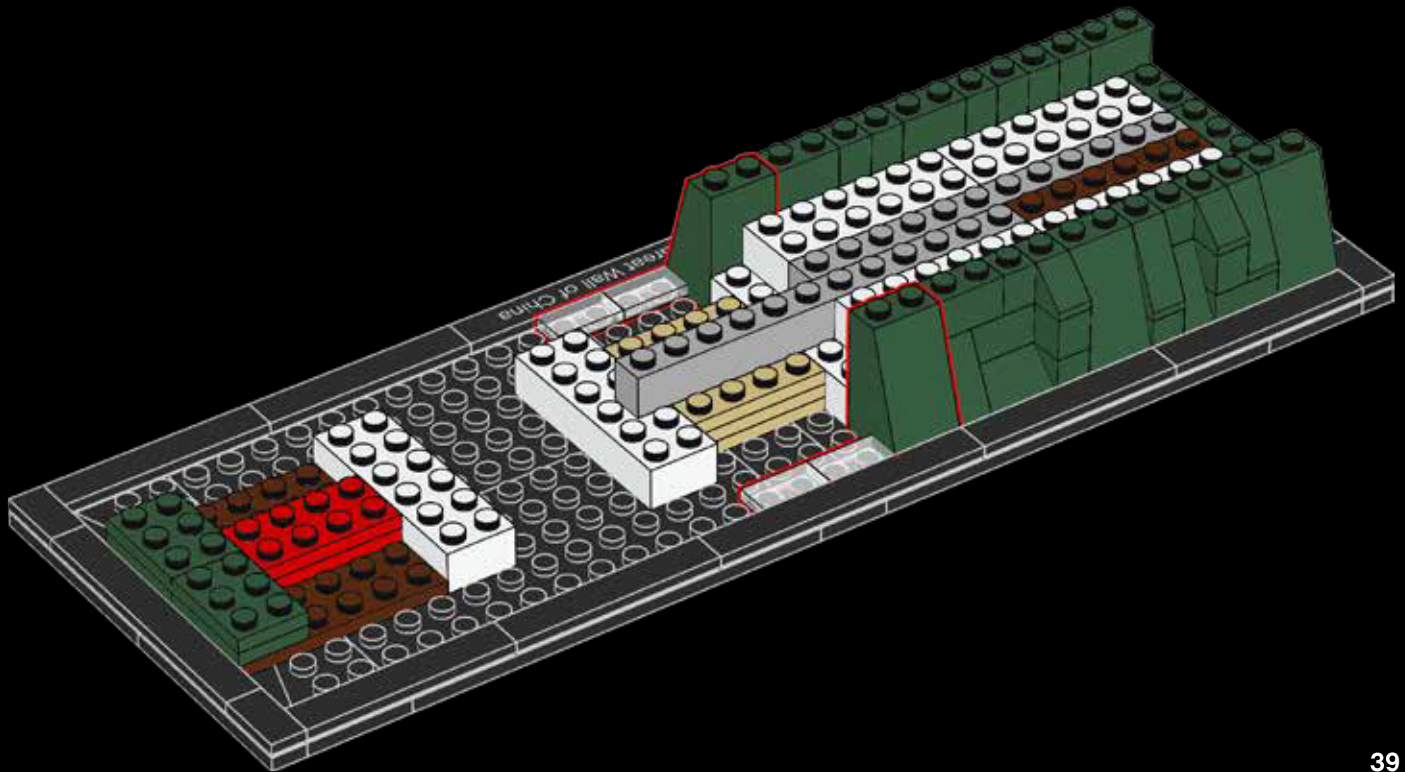

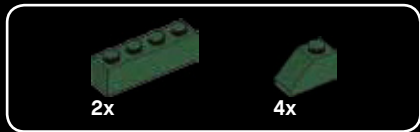

22

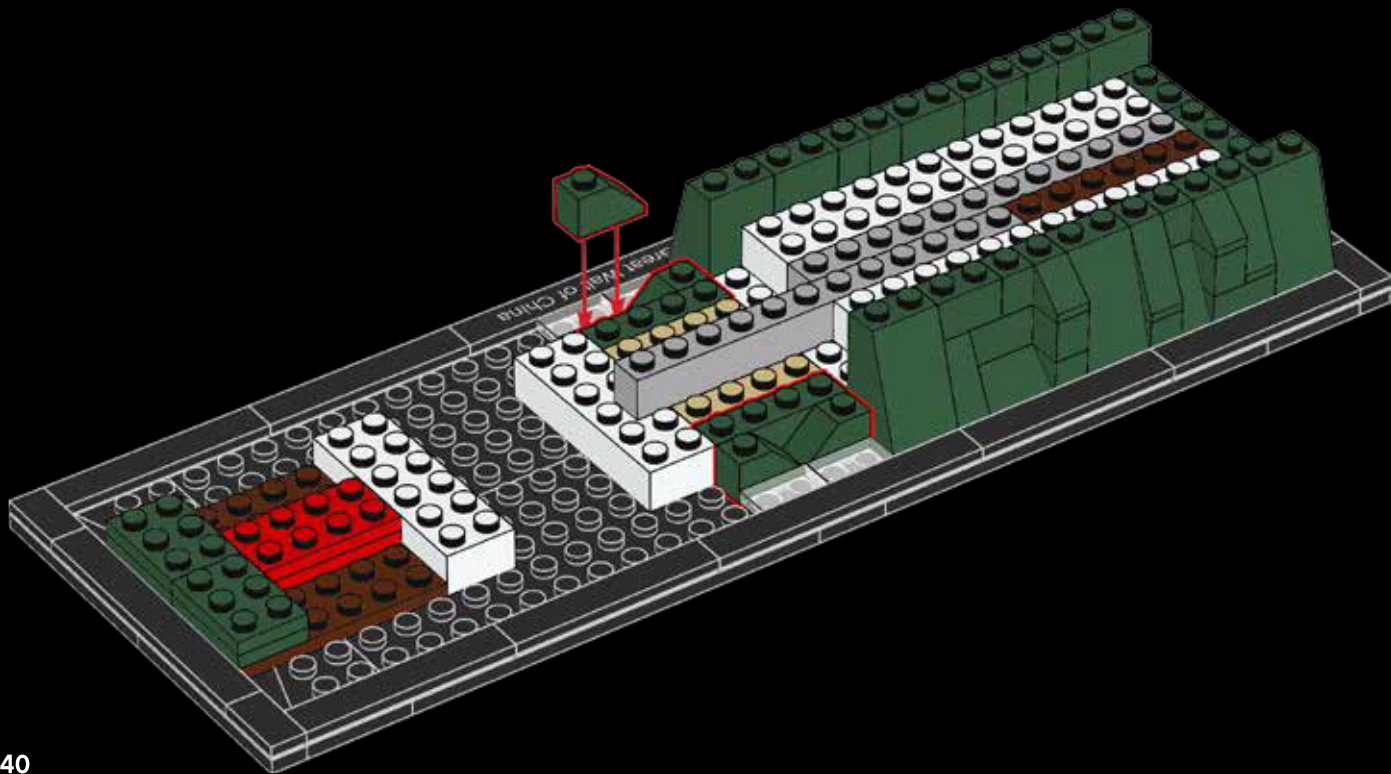



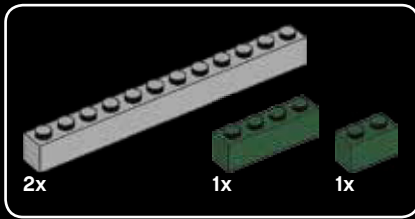

23

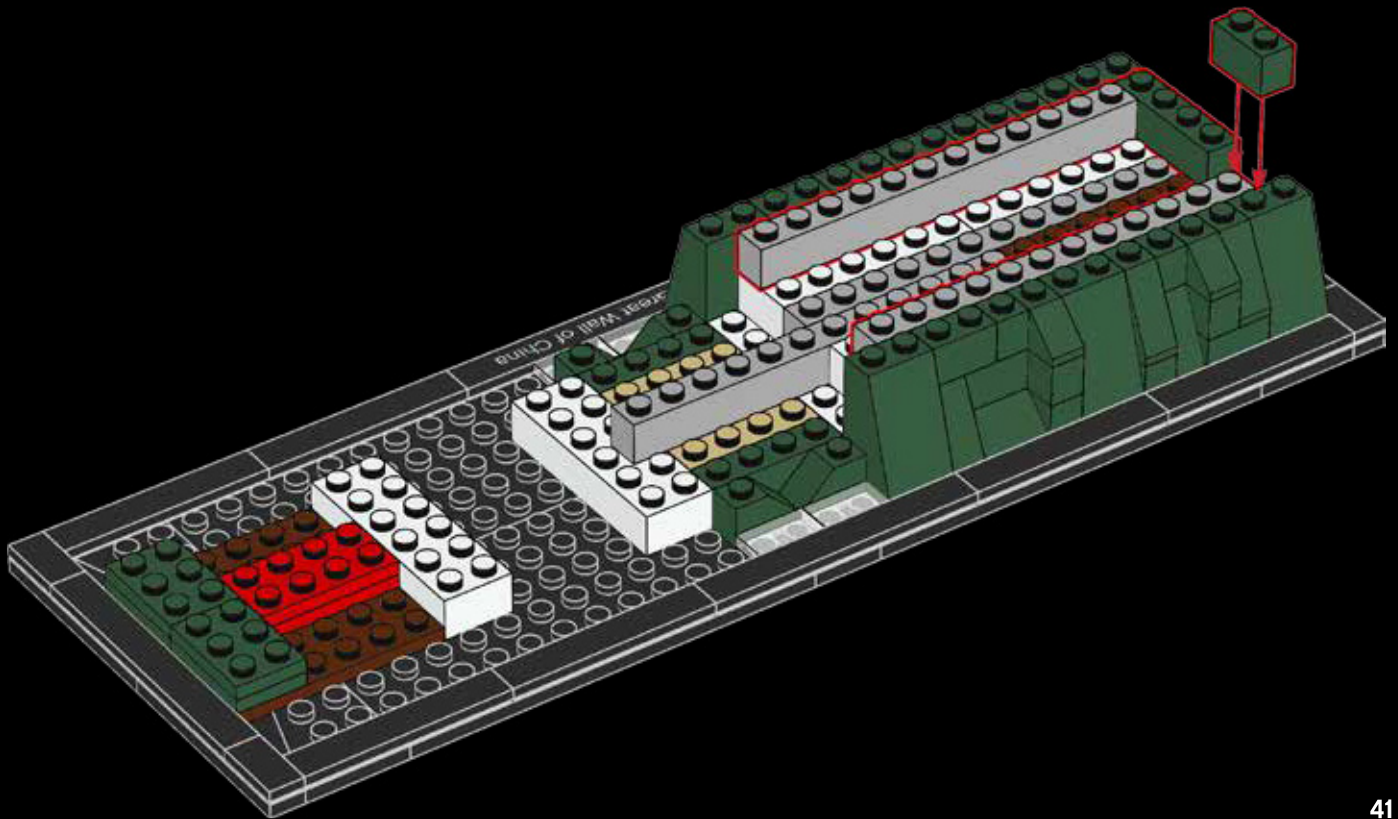



3x

24

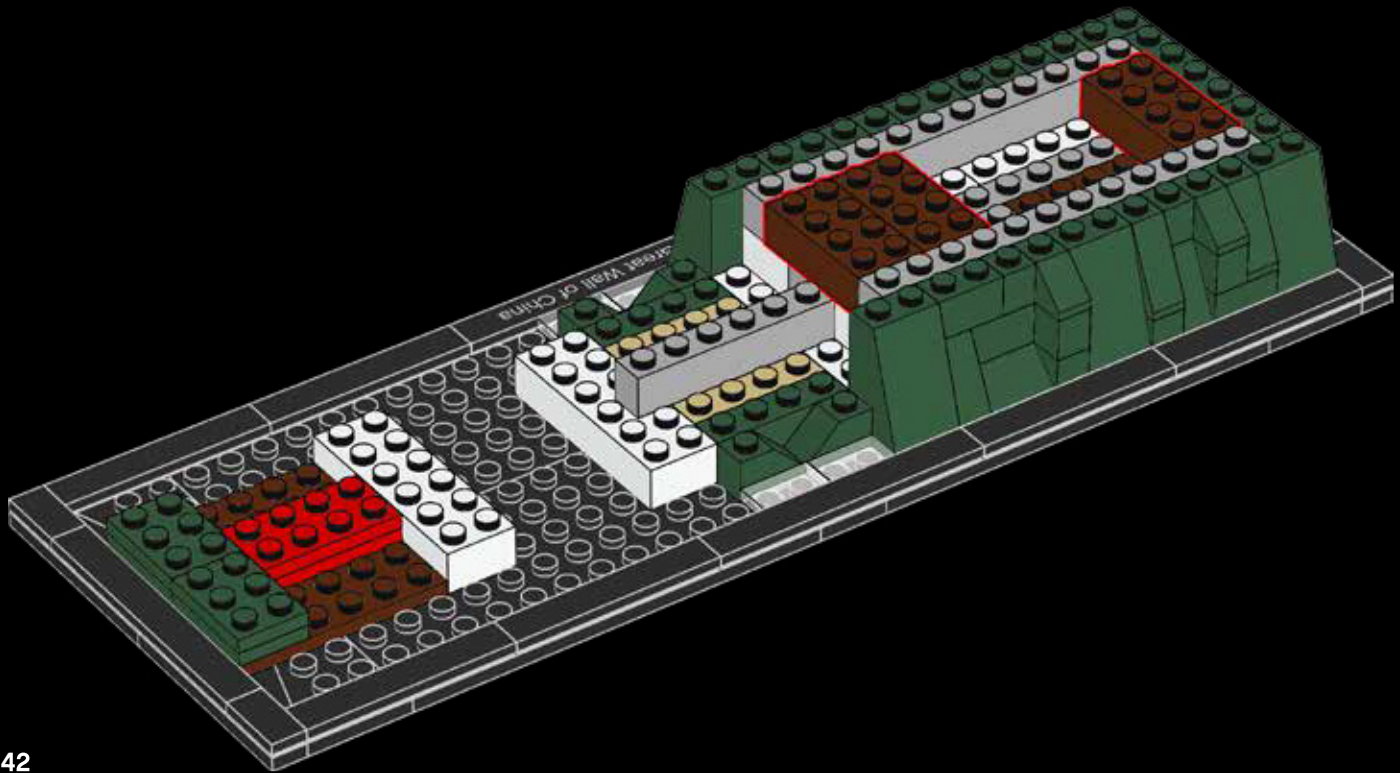



25

It is believed that almost one third of the wall has disappeared without trace.

人们相信，几乎三分之一的长城已完全消失，无迹可寻。

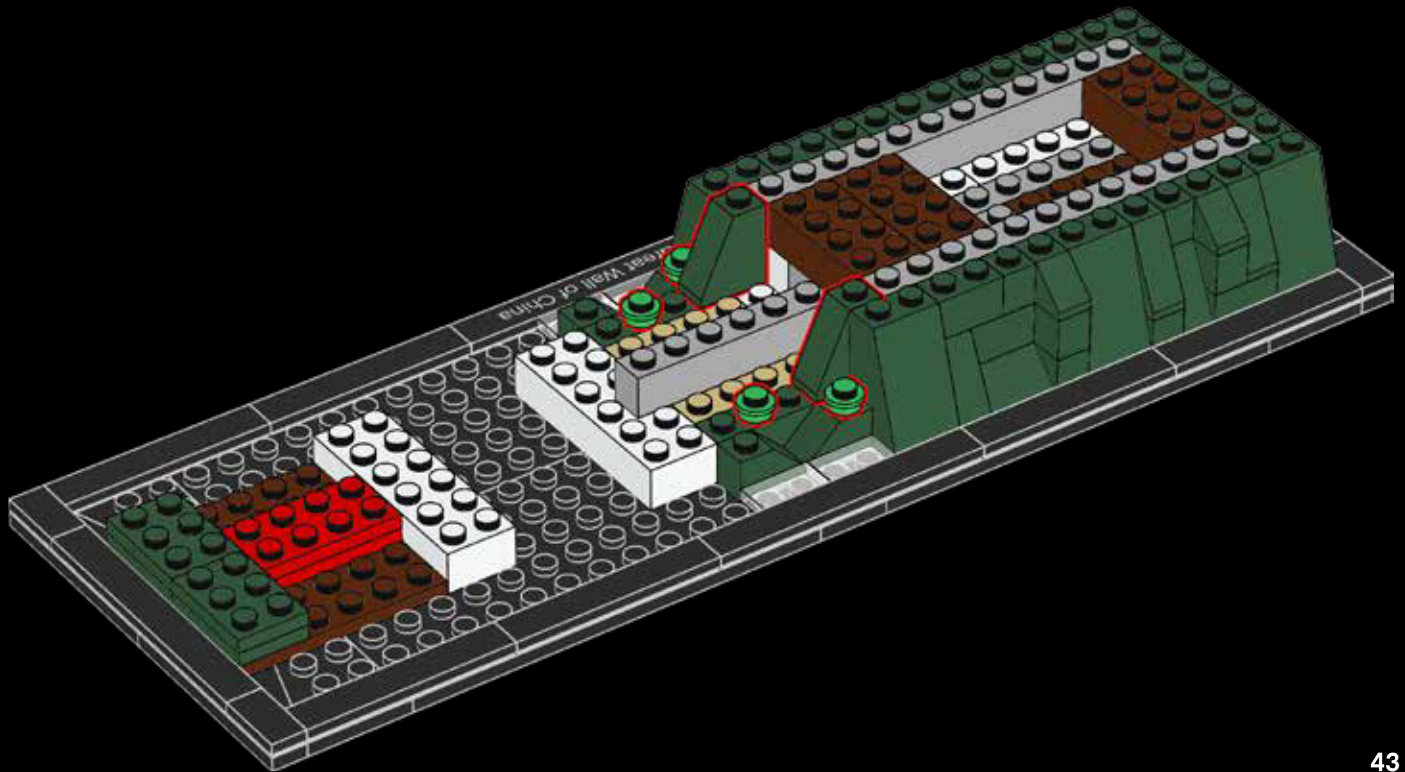



6x

26





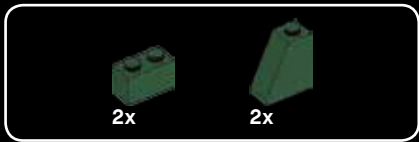

27

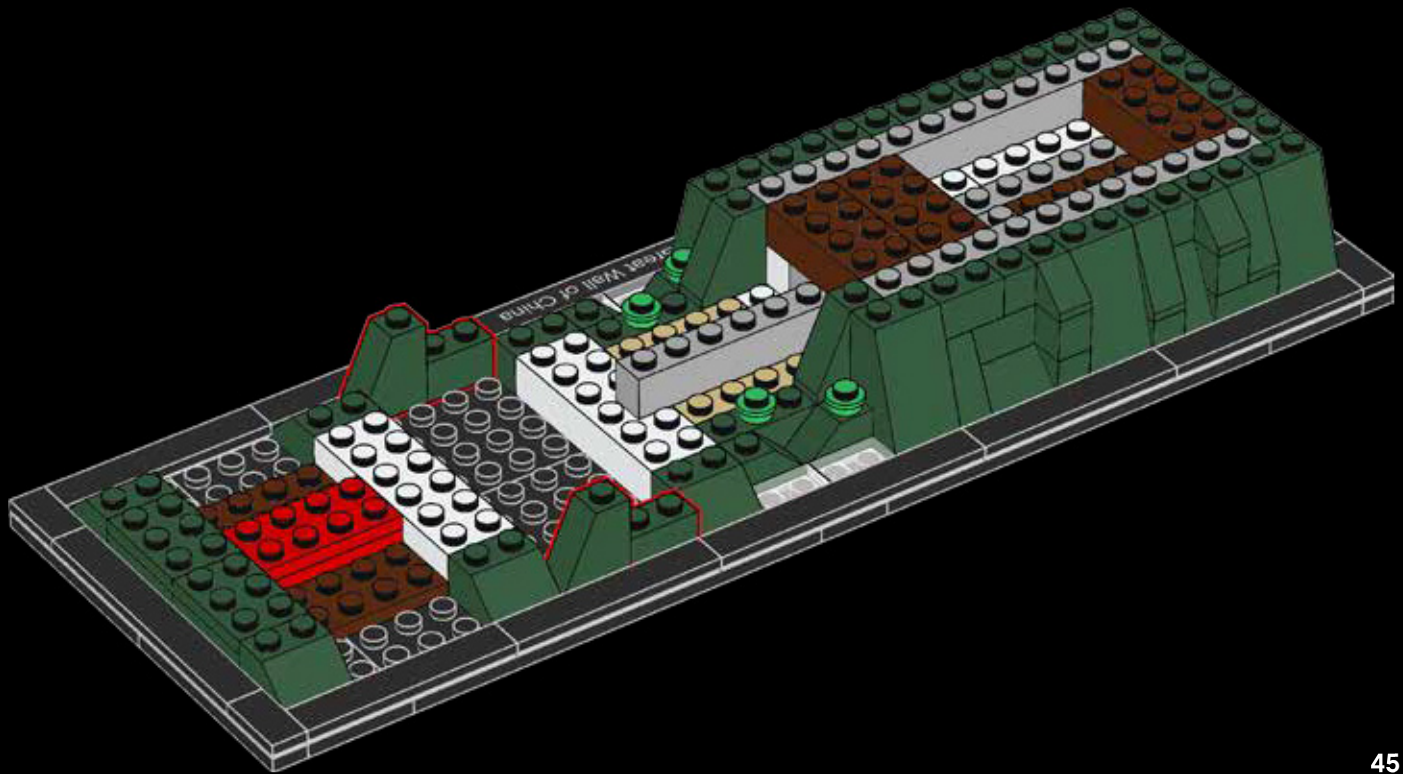

The first mention of the wall outside China came in the early 16th century when a Portuguese writer wrote about a solid wall with a strong garrison.

中国境外首次提及长城的信息可追溯到16世纪初，一位葡萄牙作家曾写到一个筑有雄关的长城。





28

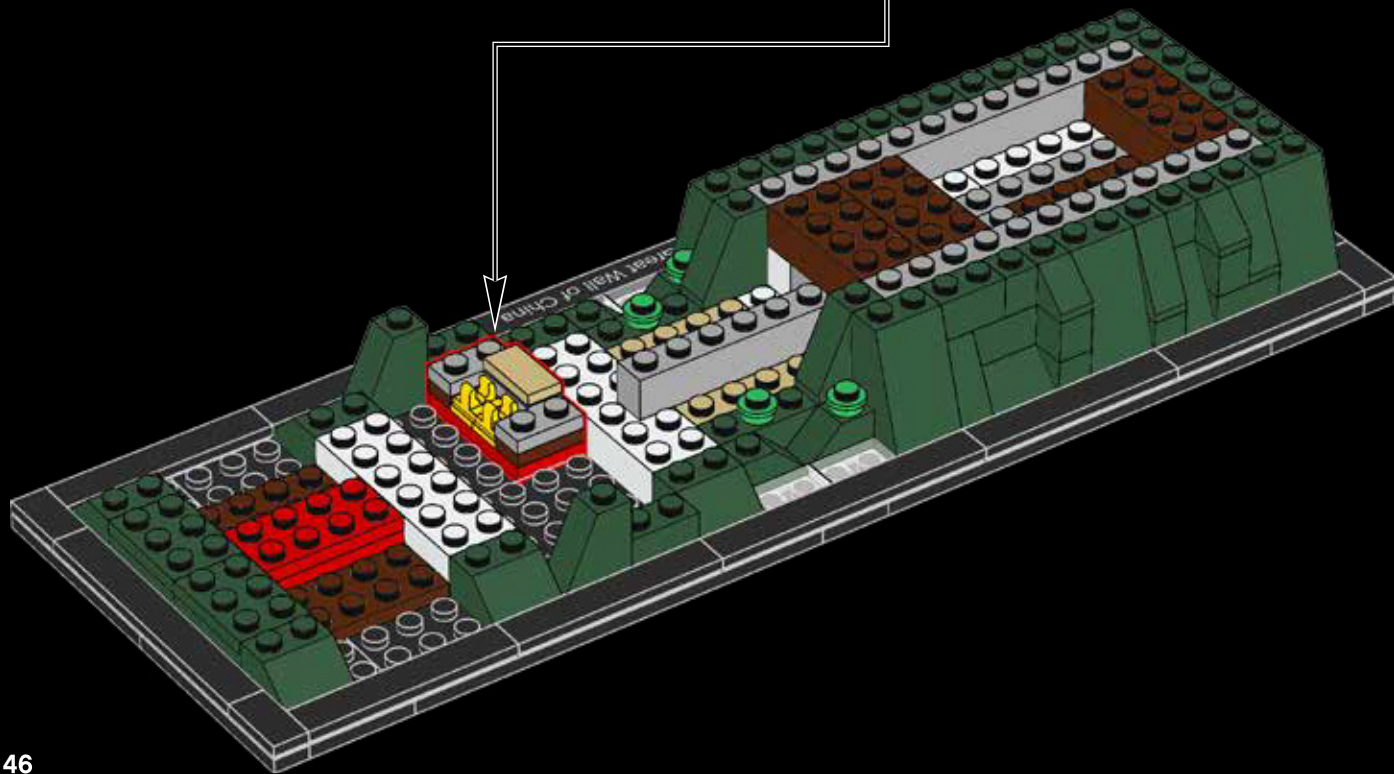
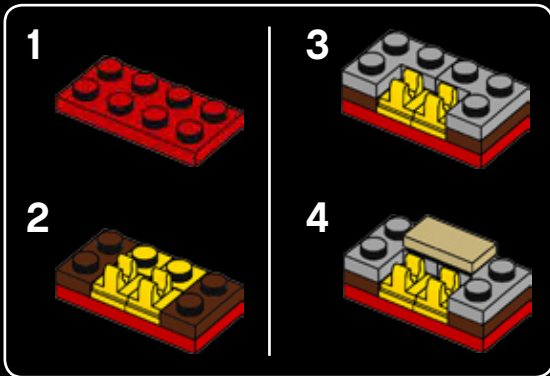

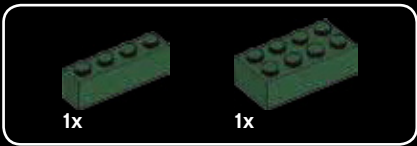

29



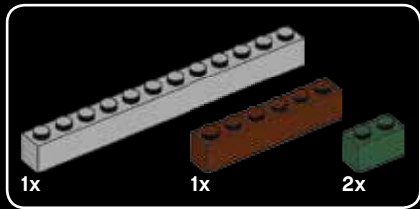

30

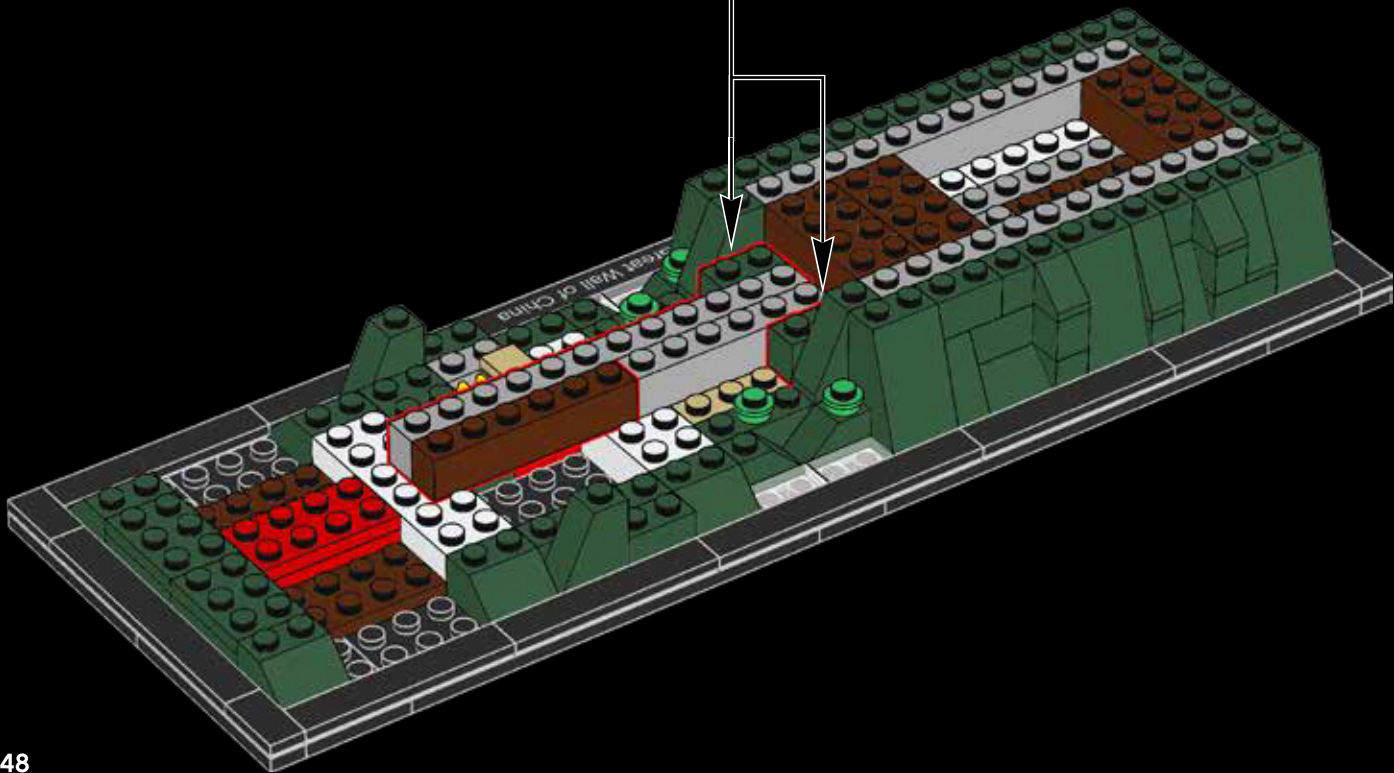
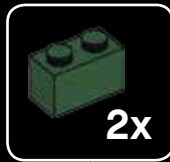





31

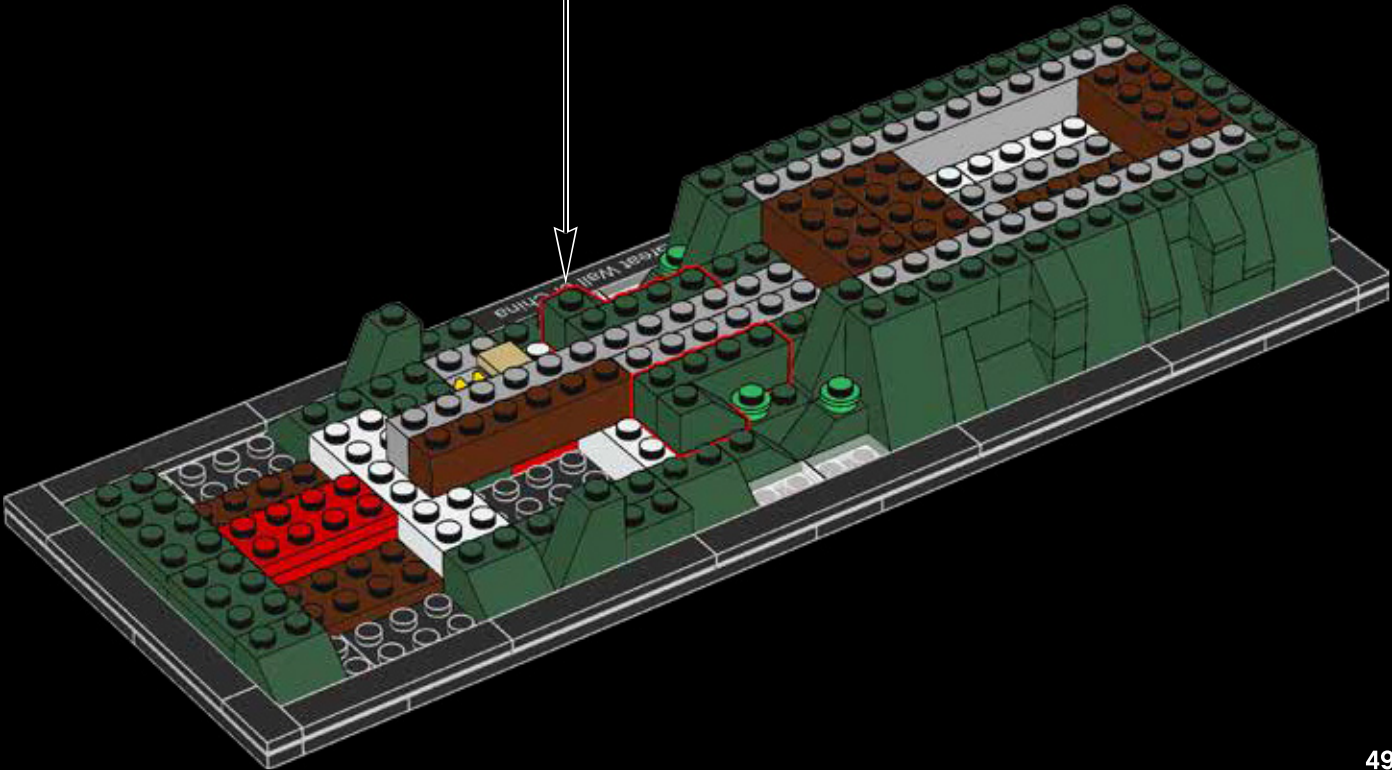

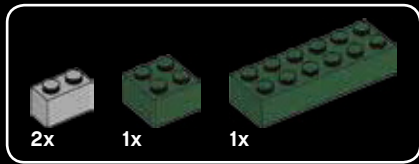

32

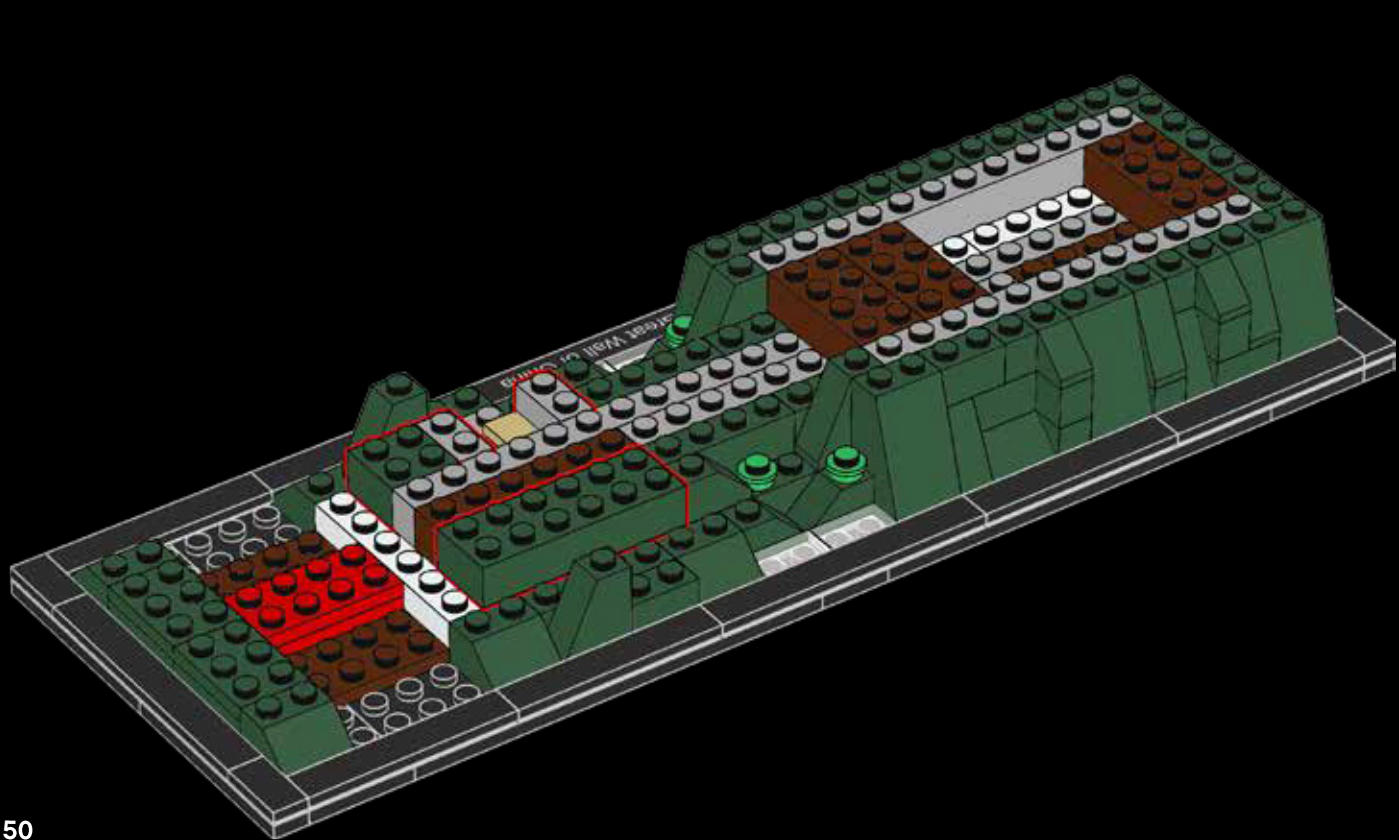



33

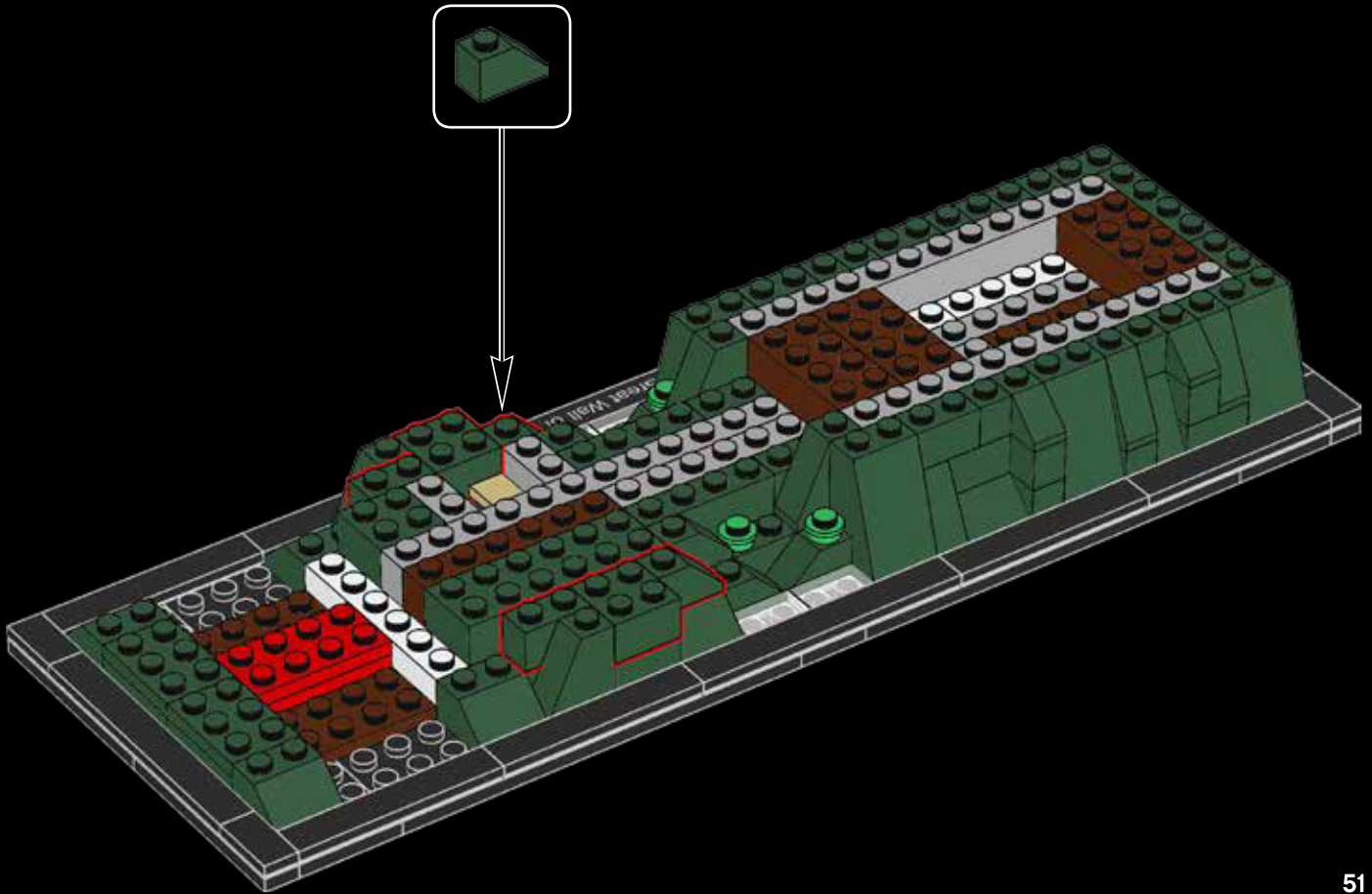



34

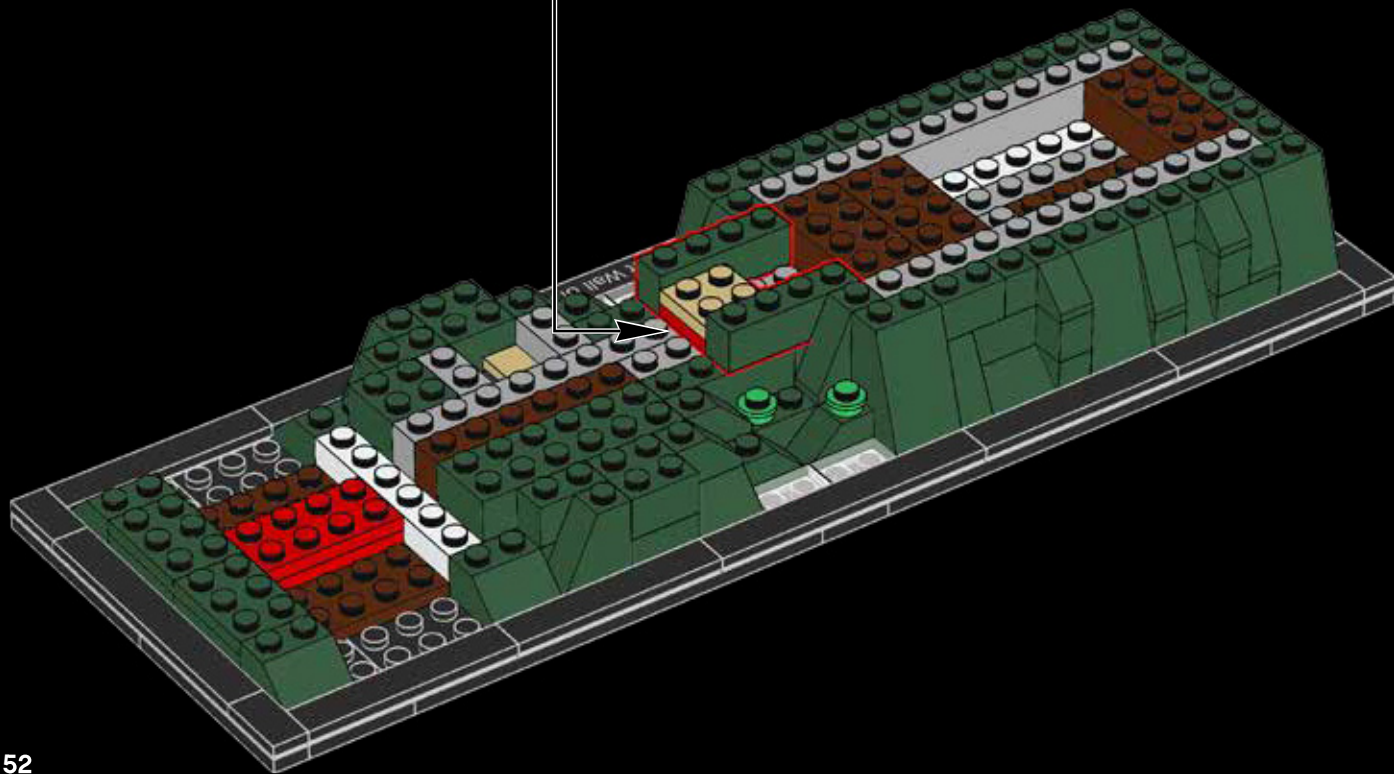
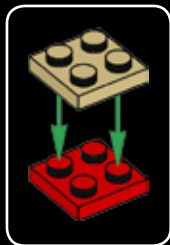



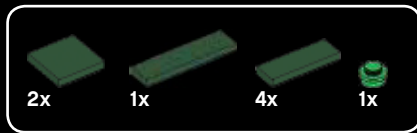

35

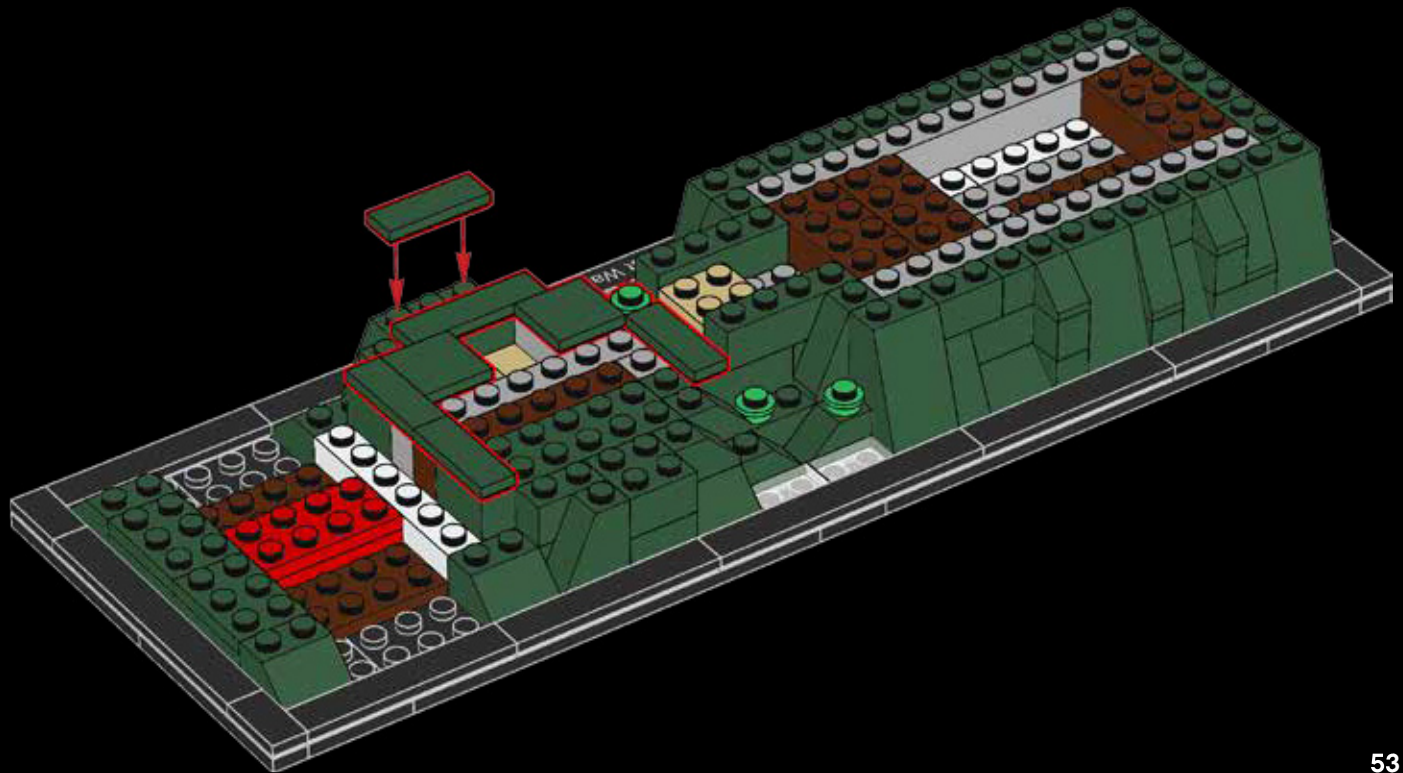

Until the 20th century the Chinese themselves never spoke of a single Great Wall.  
二十世纪之前，中国人自己从未提到过长城。



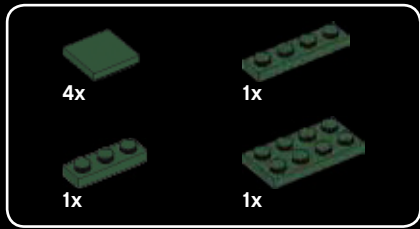

36

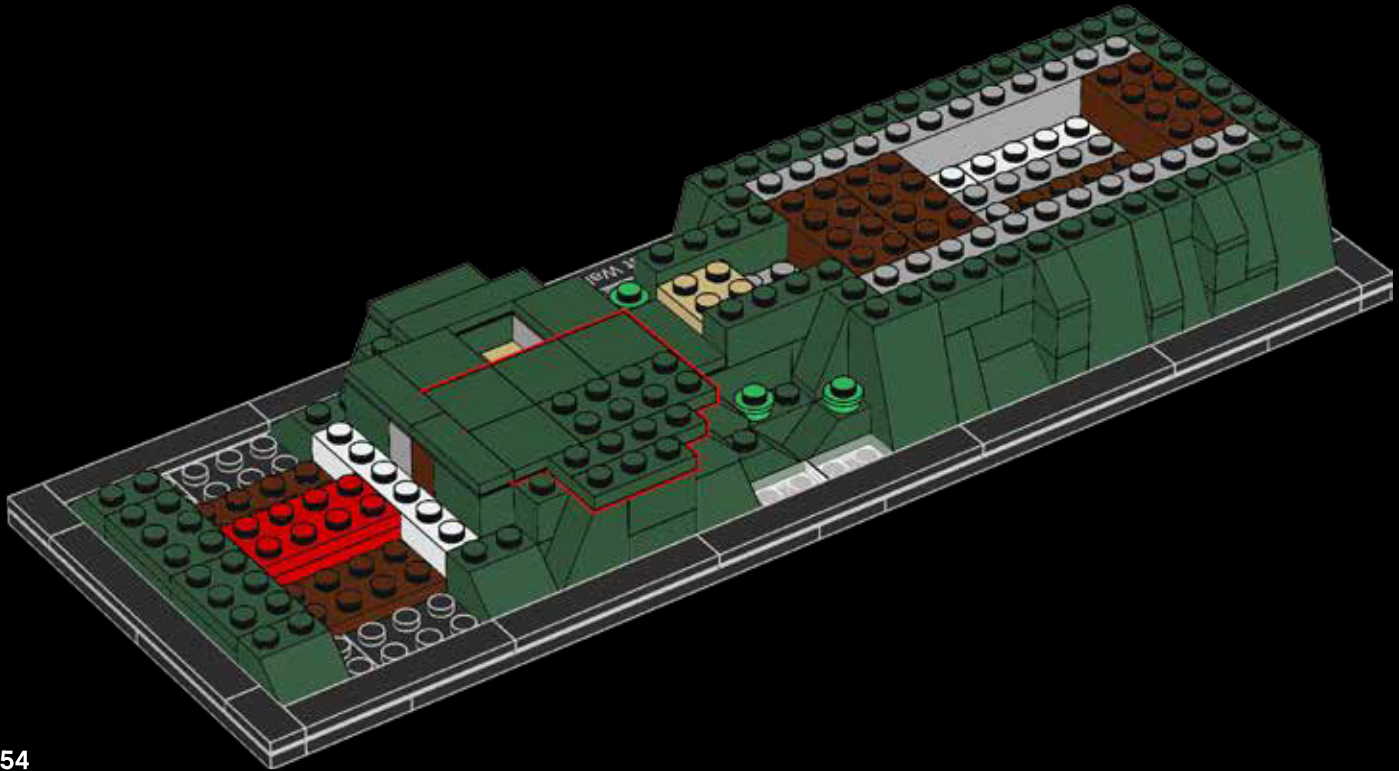



37

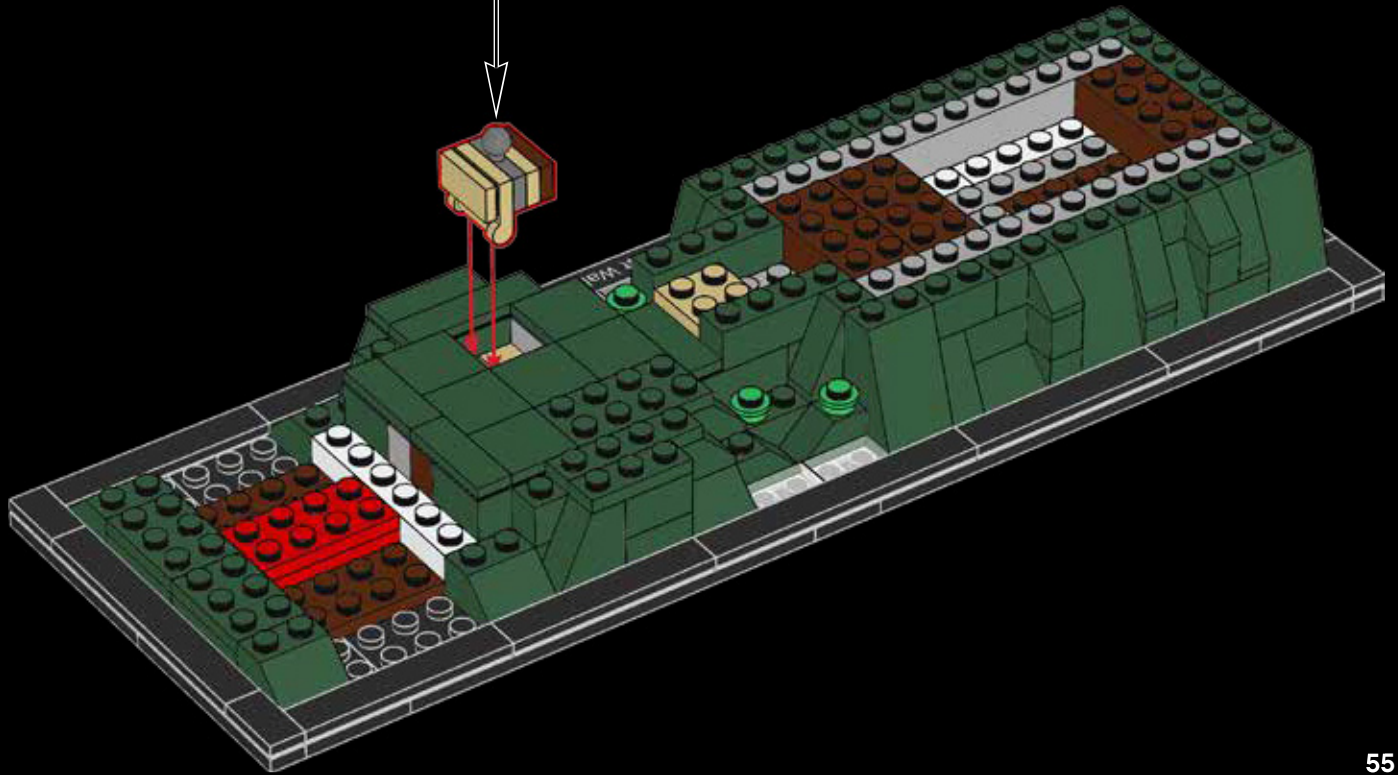
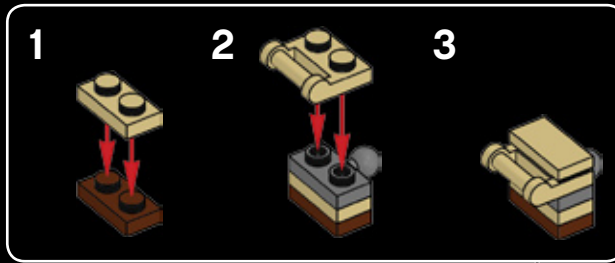



38

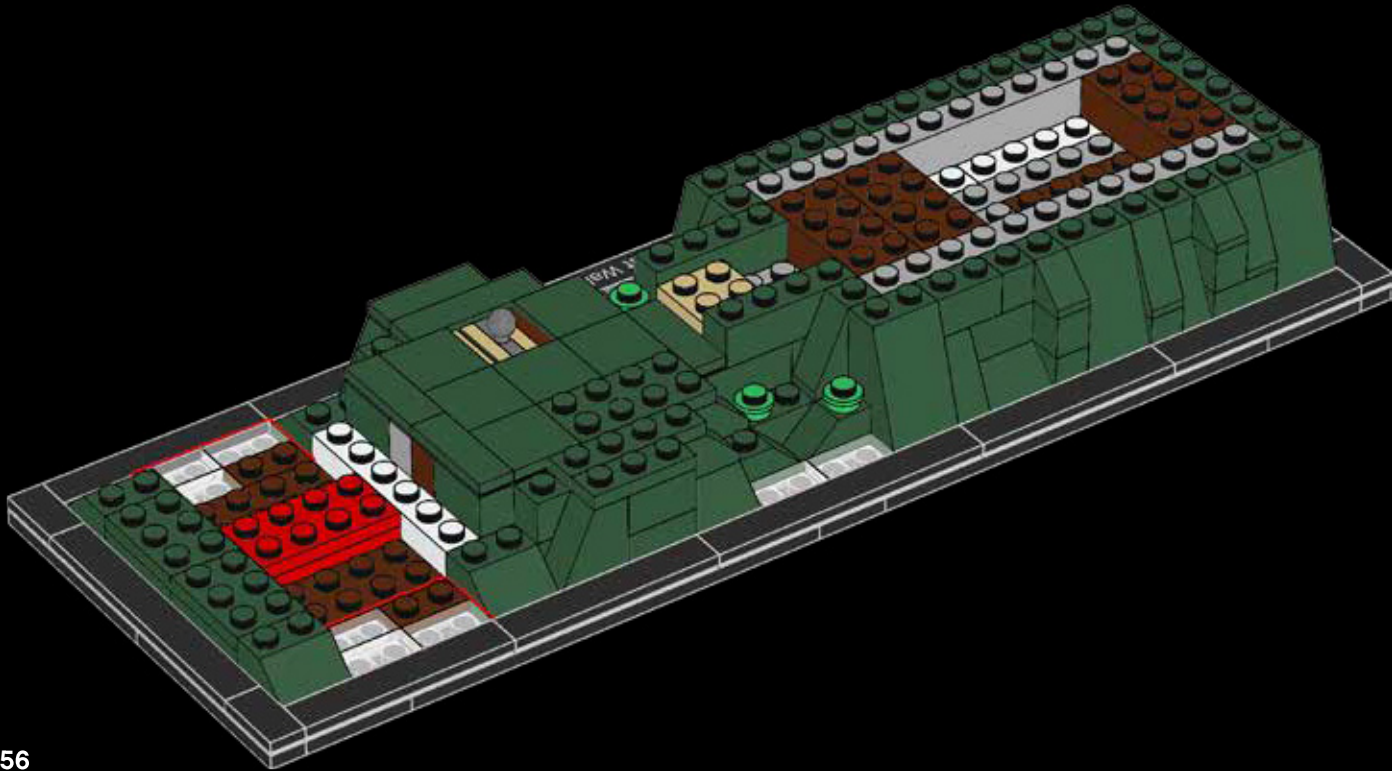



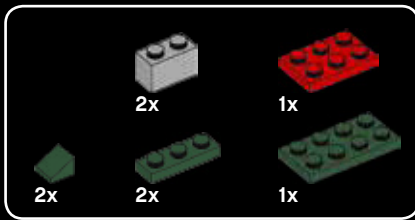

39

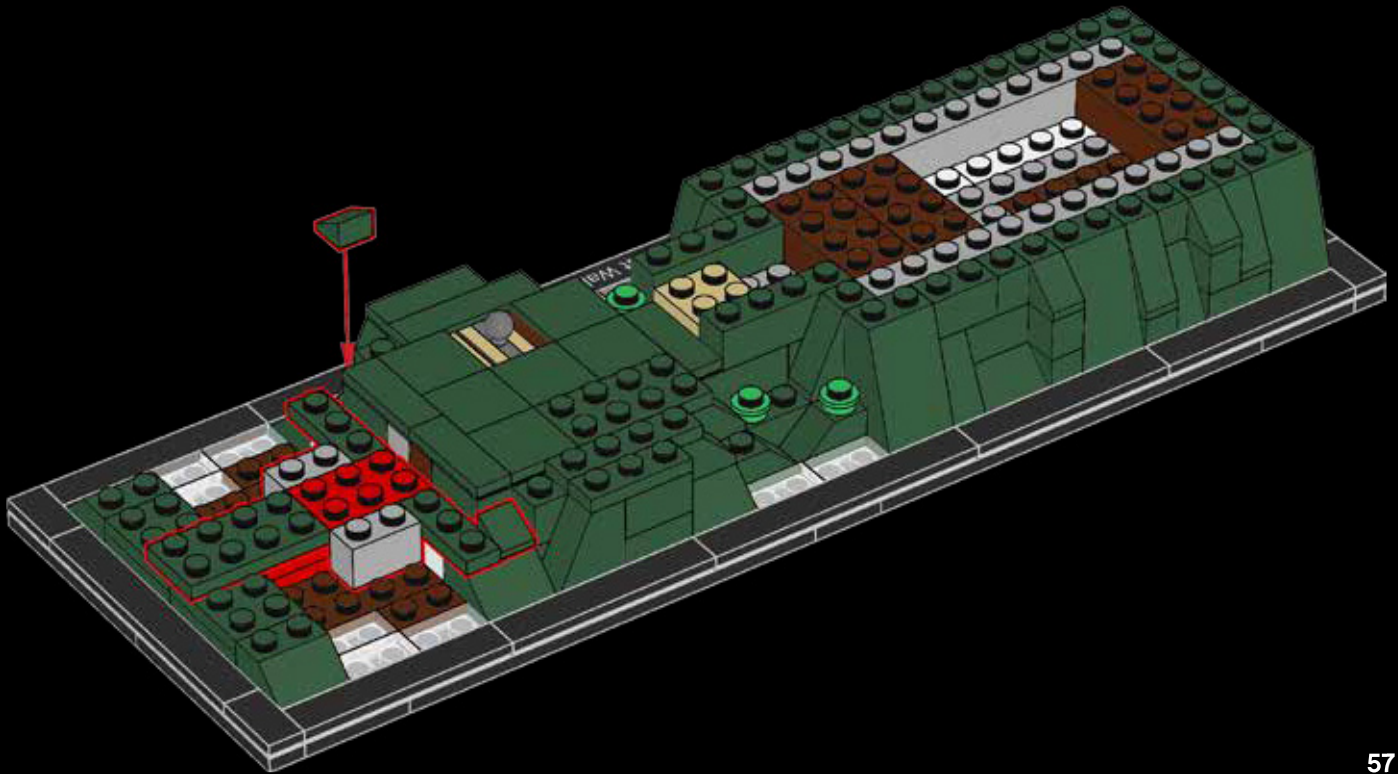

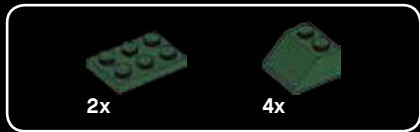

40

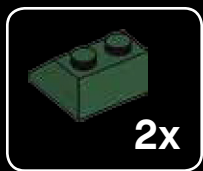

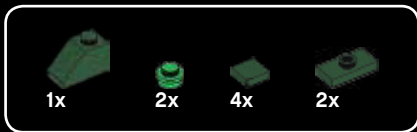

41

The wall's strength and endurance has been put down to the use of "sticky rice" in the mortar that holds the stones and bricks in place. 长城墙体的高强度和耐久性得益于“糯米”砂浆，其可将石块和砖块牢牢地黏接在一起。

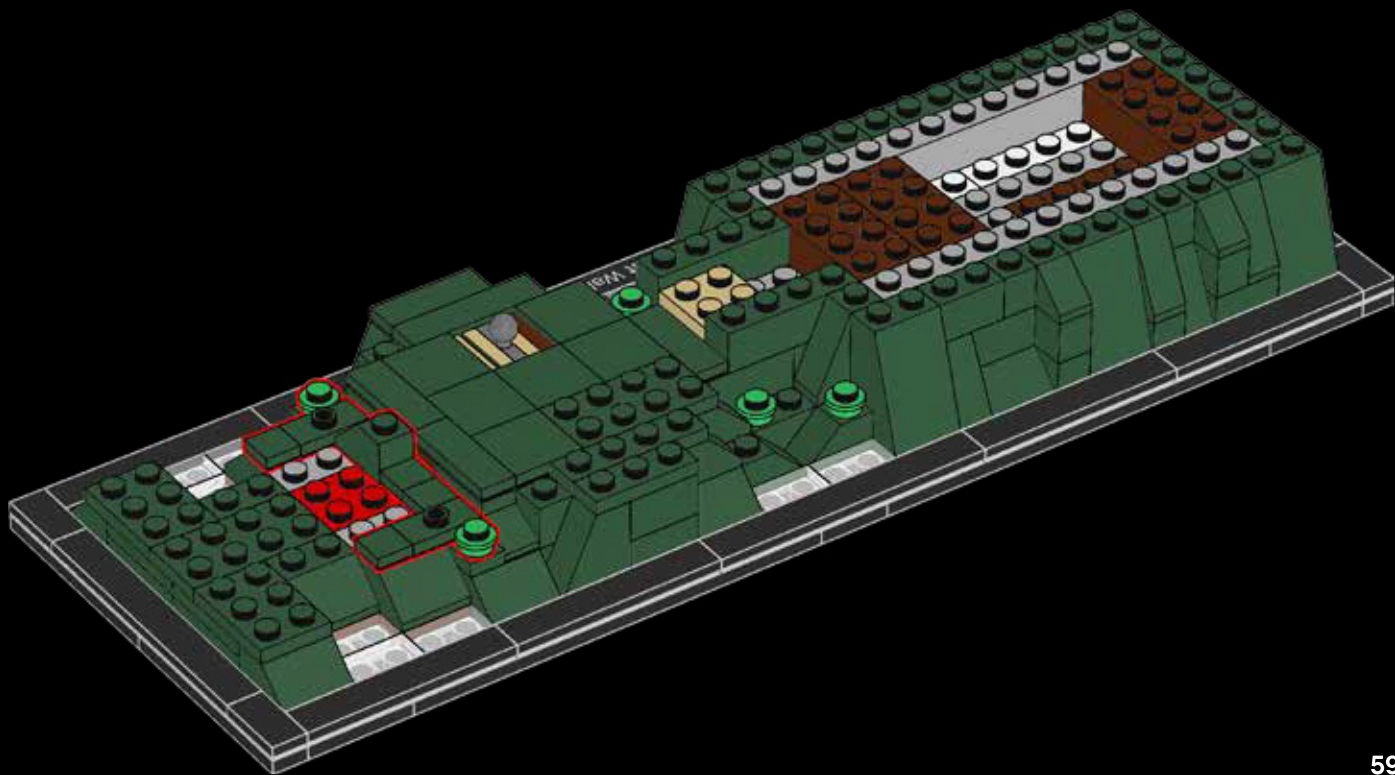

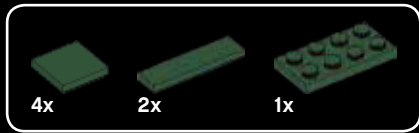

42

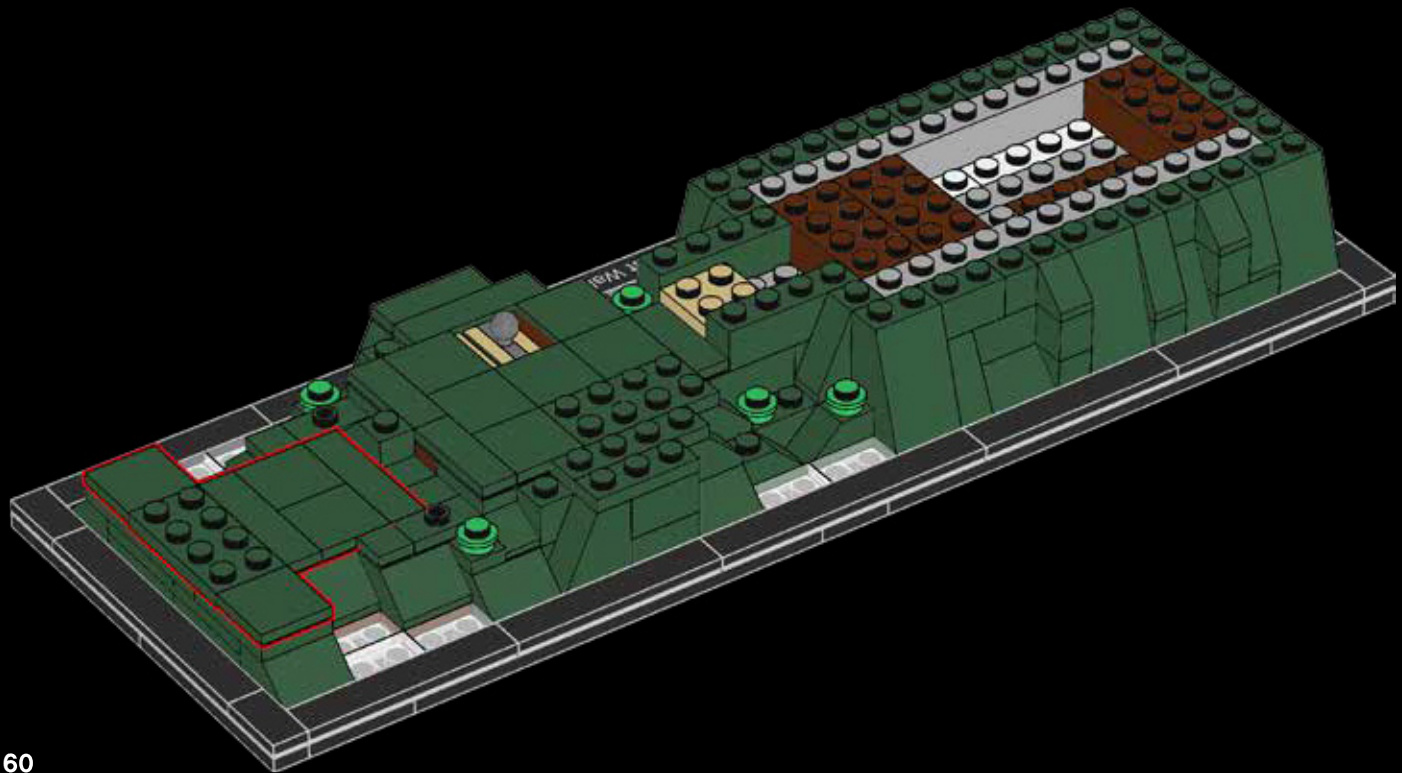



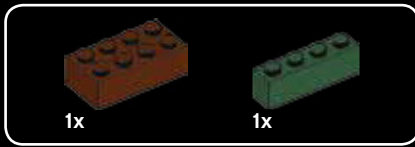

43

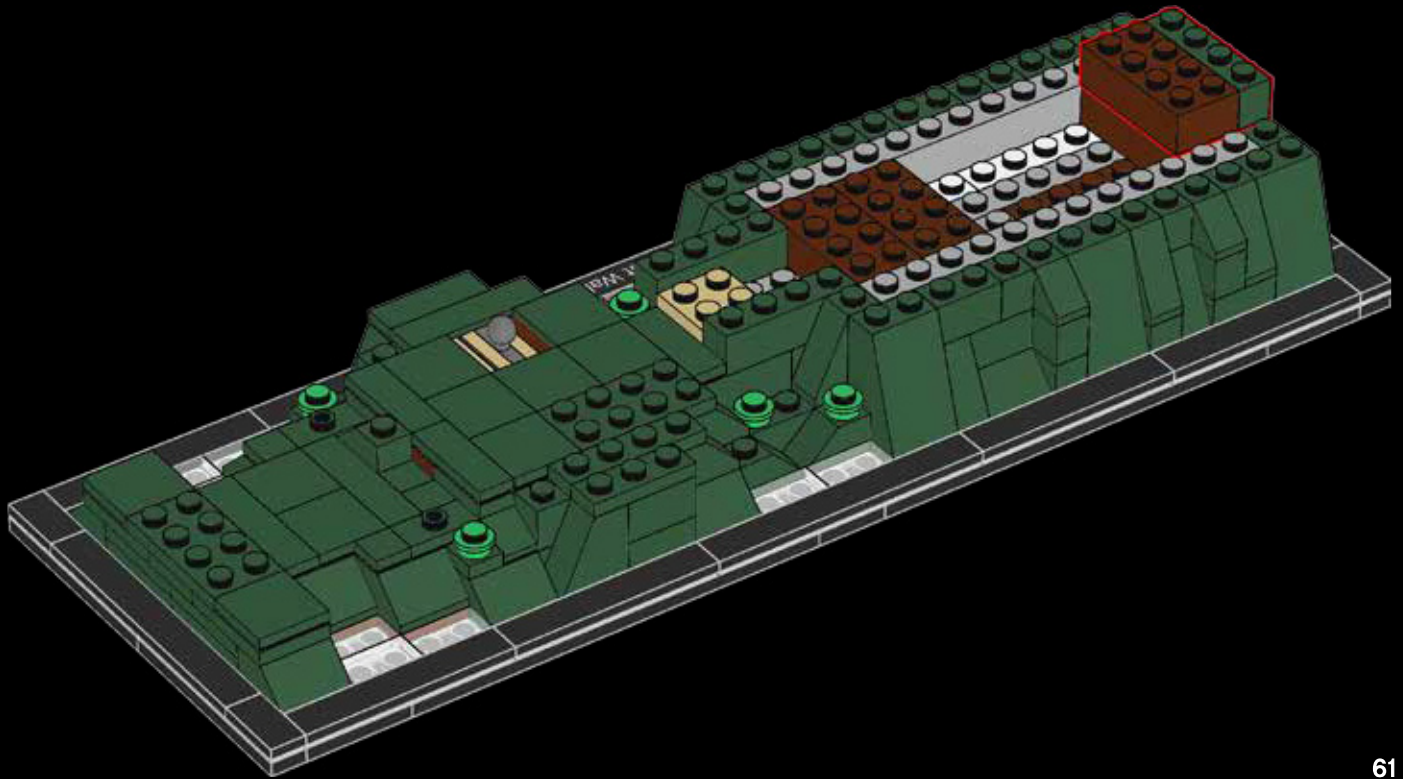

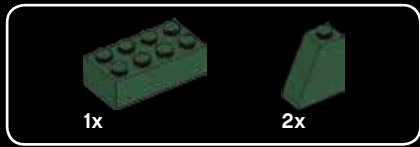

# 44

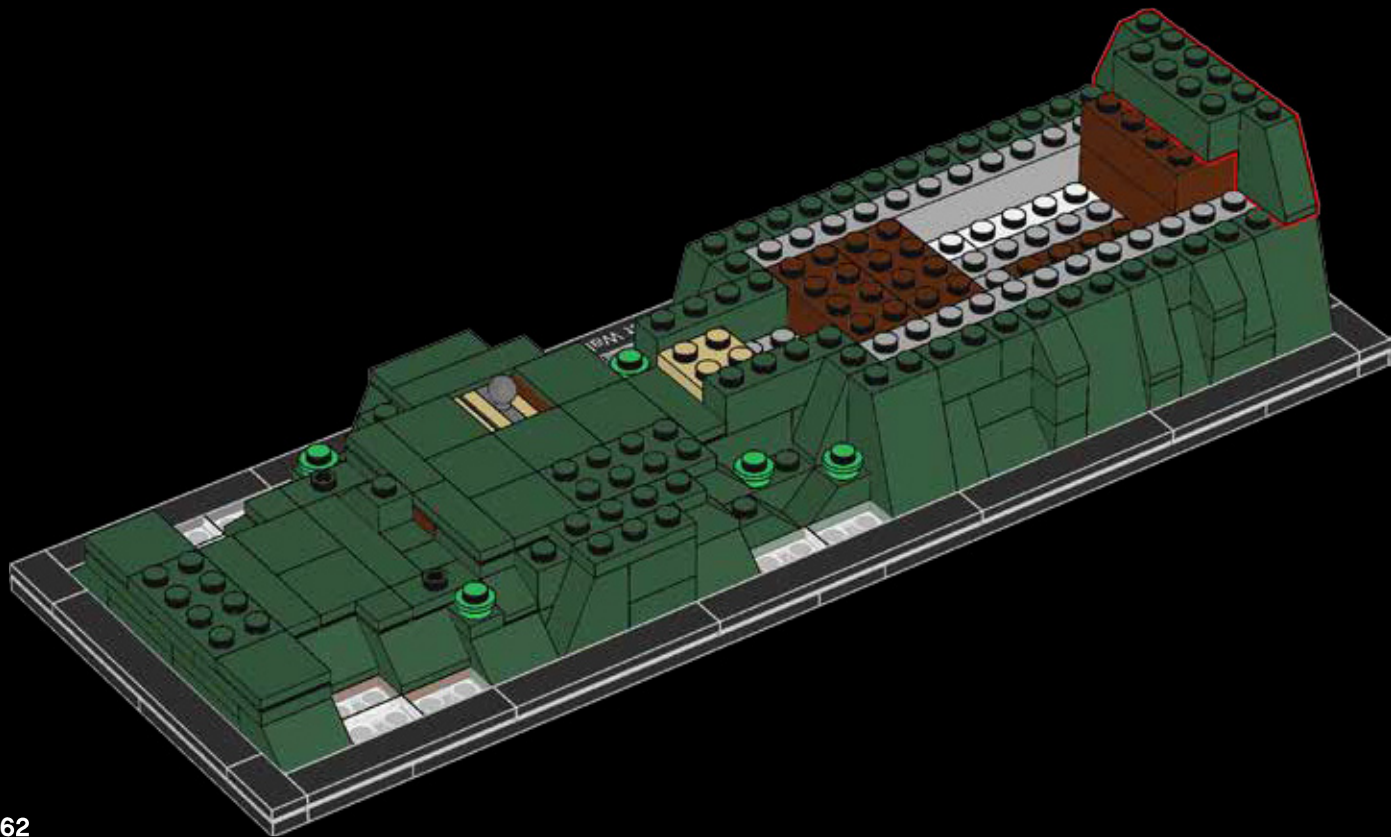

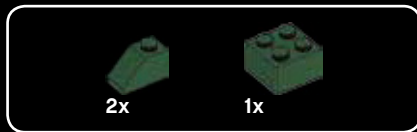

45



The Great Wall is also a "must-see" for VIPs and over 300 heads of states have visited the impressive structure. 长城还是VIPs的“必看景点”，已有300多名各国政要游览了这个气势恢宏的建筑。



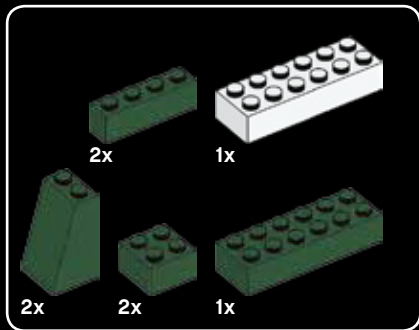

46





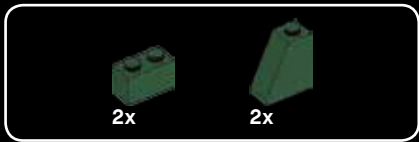

47

The wall spans across 15 different regions in northern China.  
长城跨越中国北方的15个不同地区。

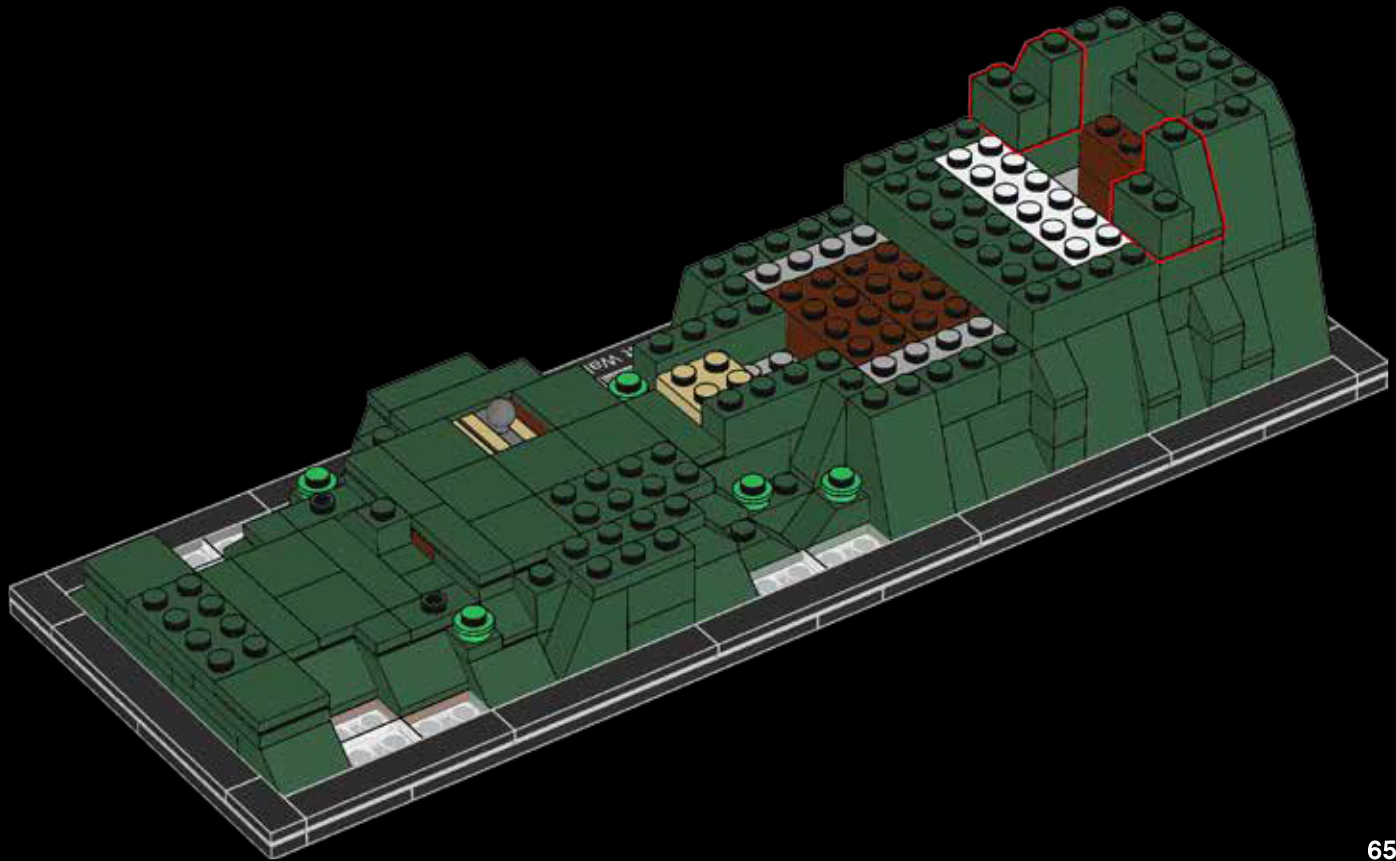

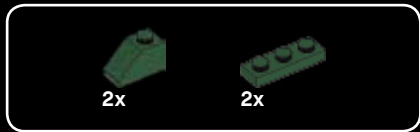

48

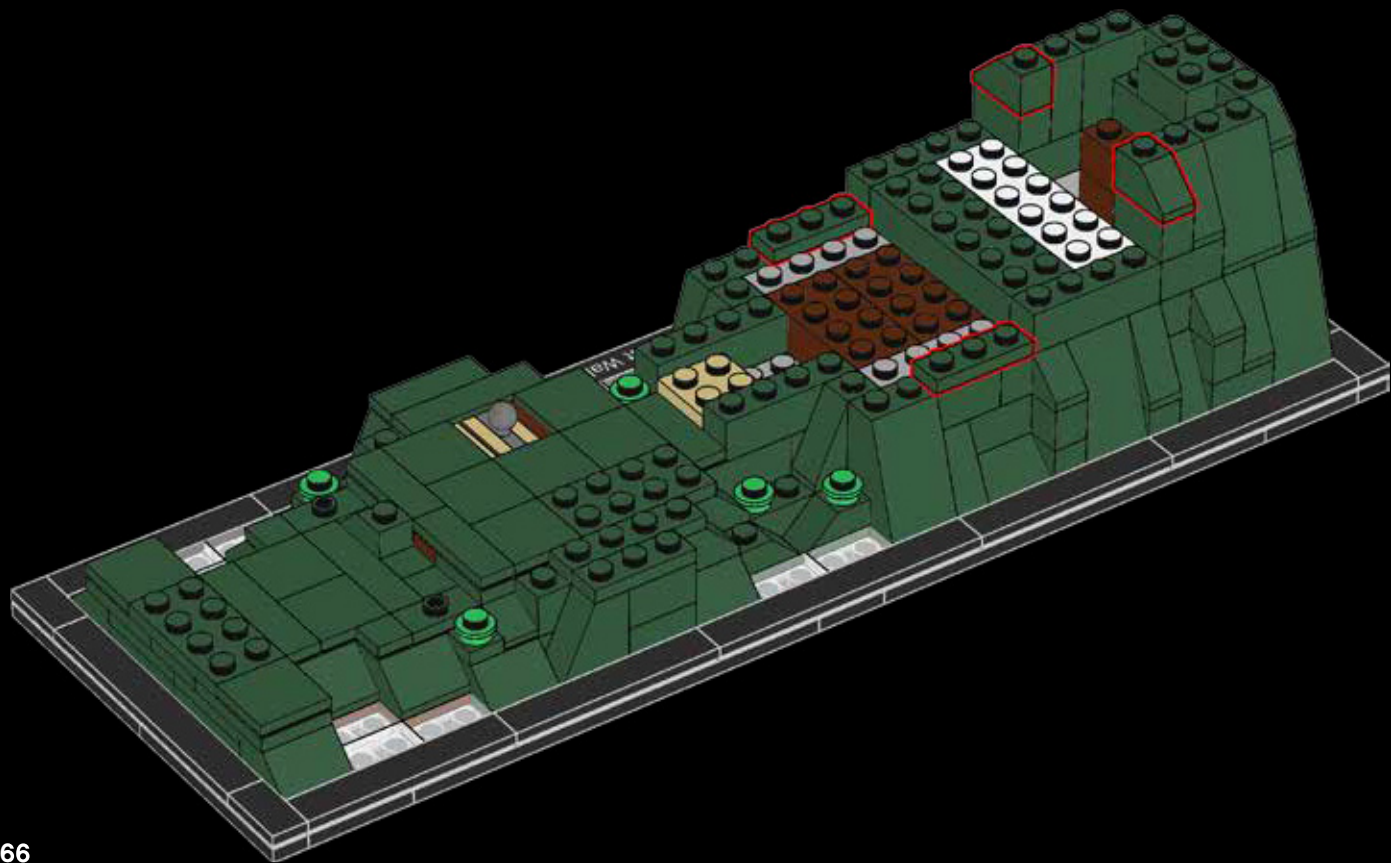



49

At its highest, the wall is 46 ft. (14 m) tall.  
在最高段，墙体高达14米（46英尺）。

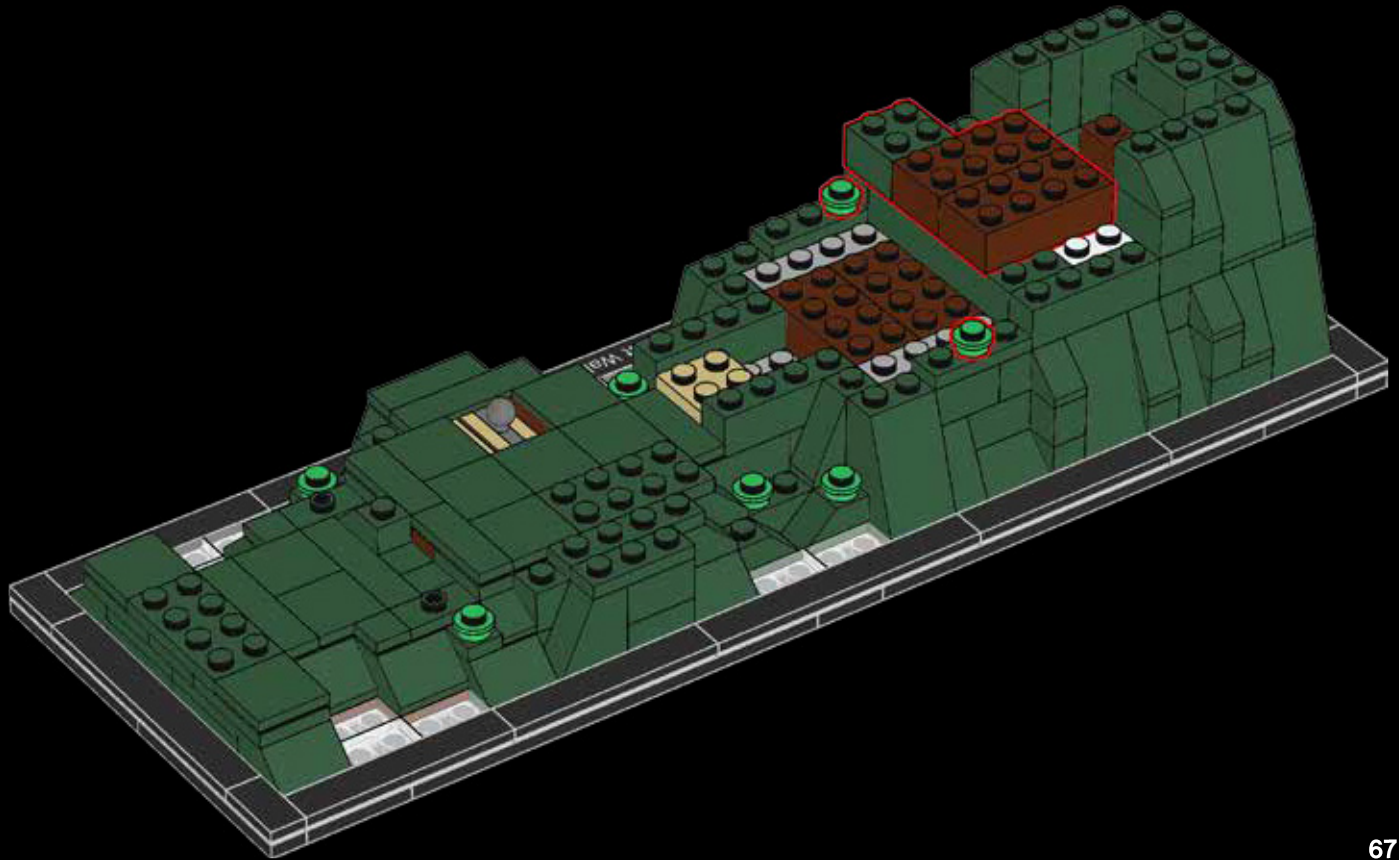

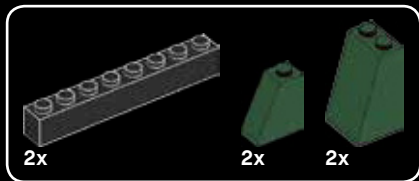

50

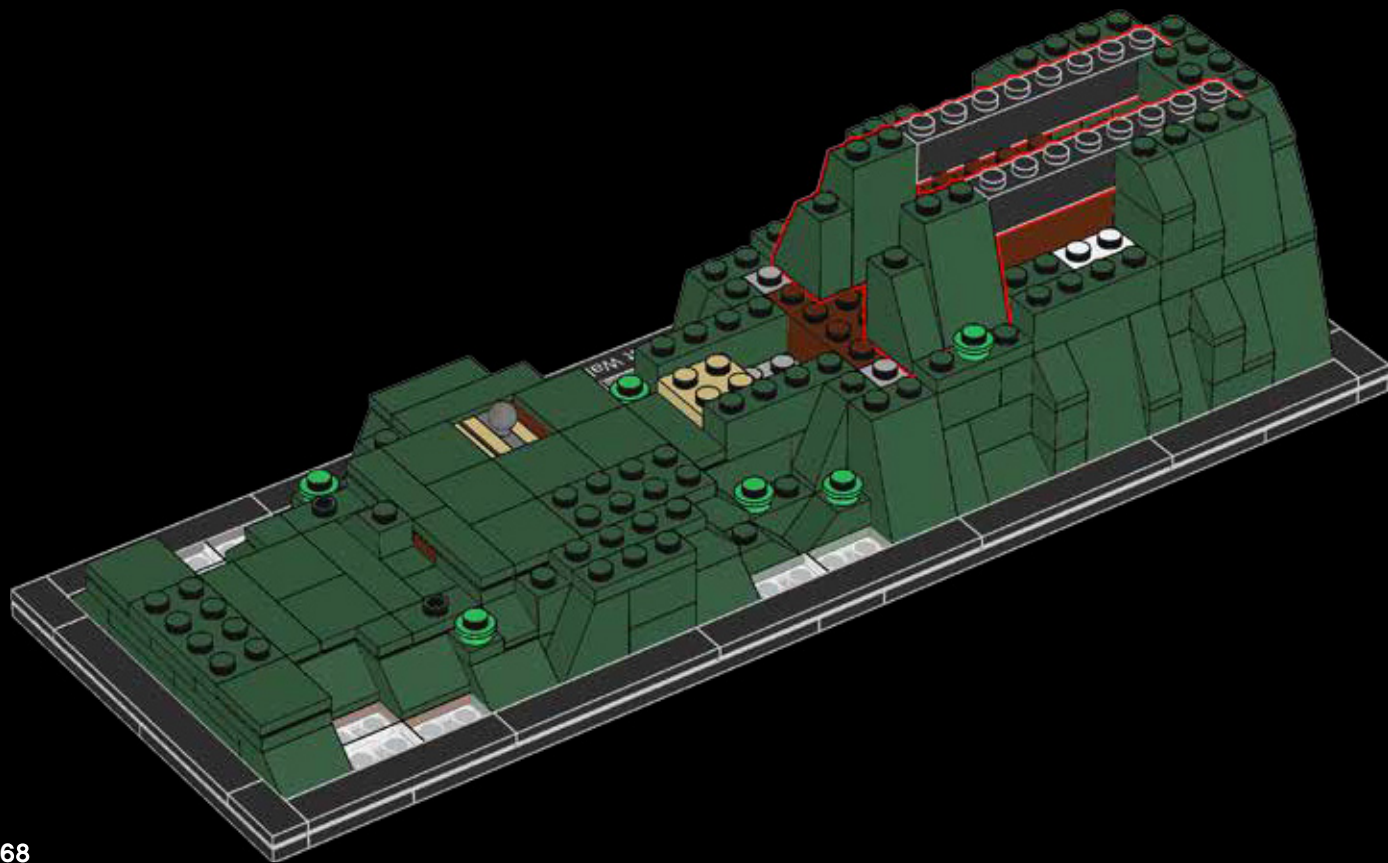



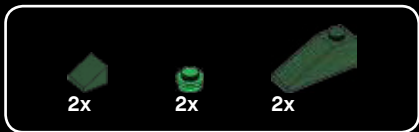

51

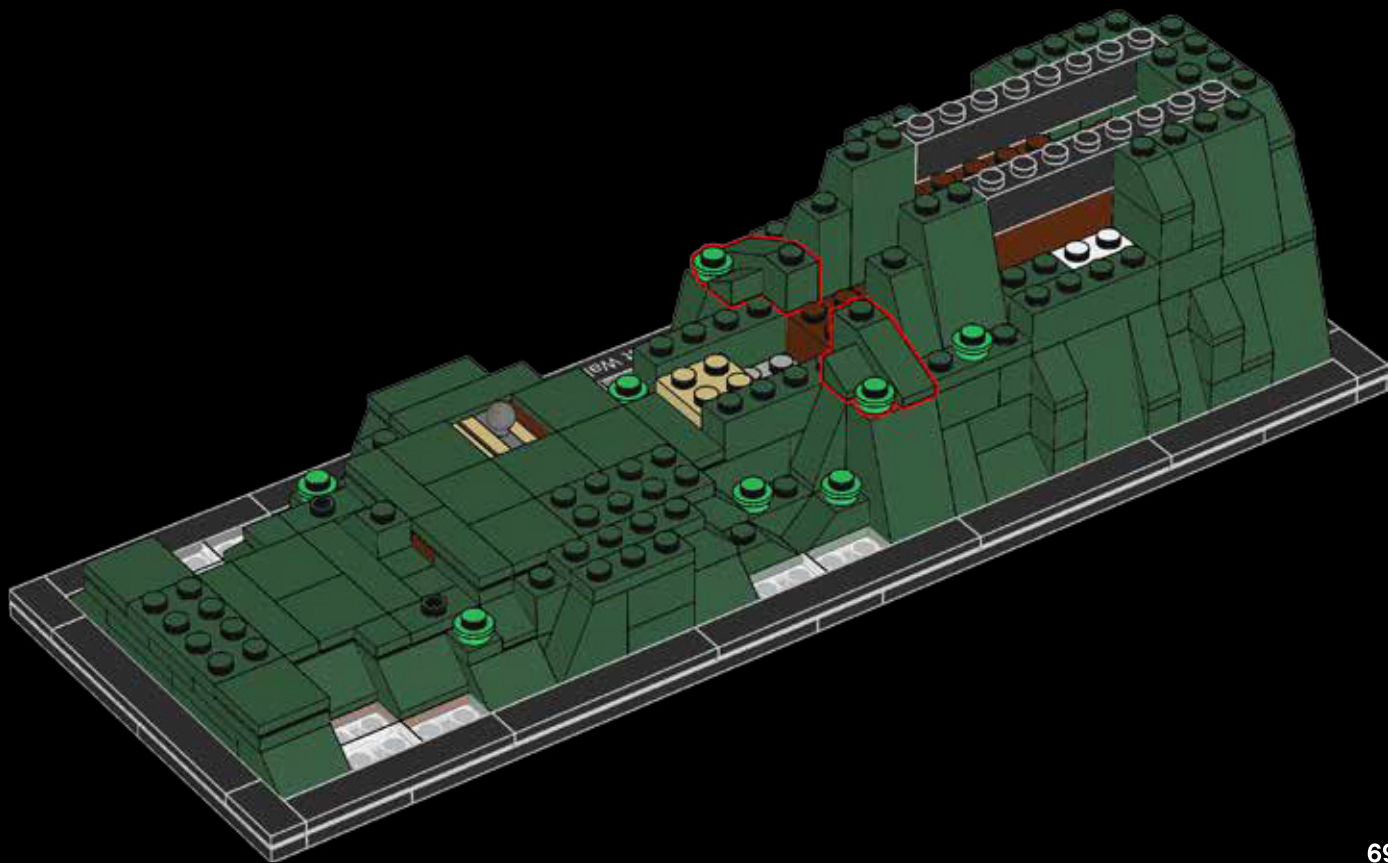

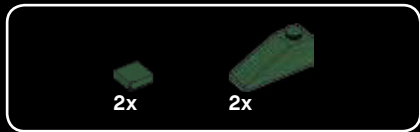

52

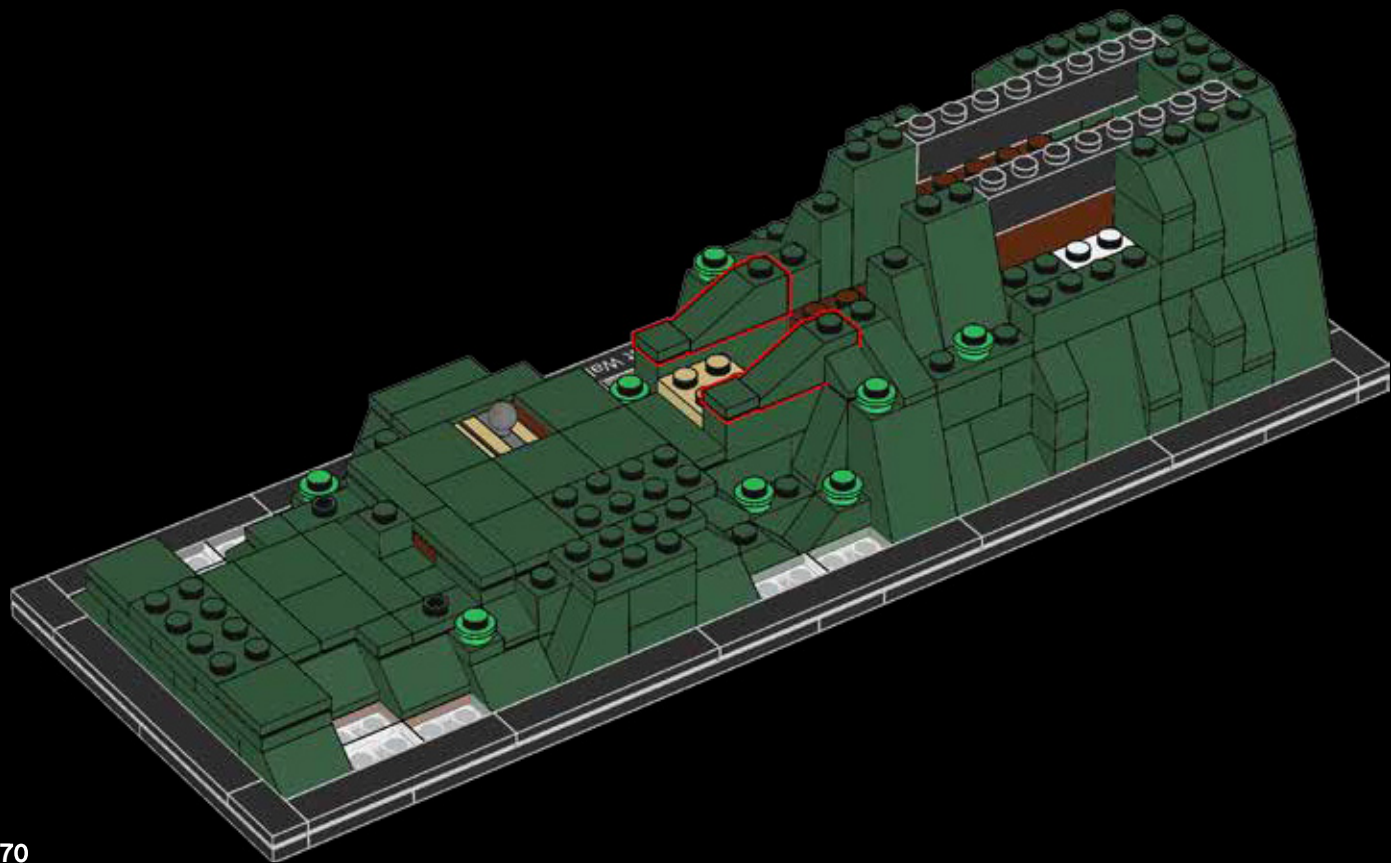



53

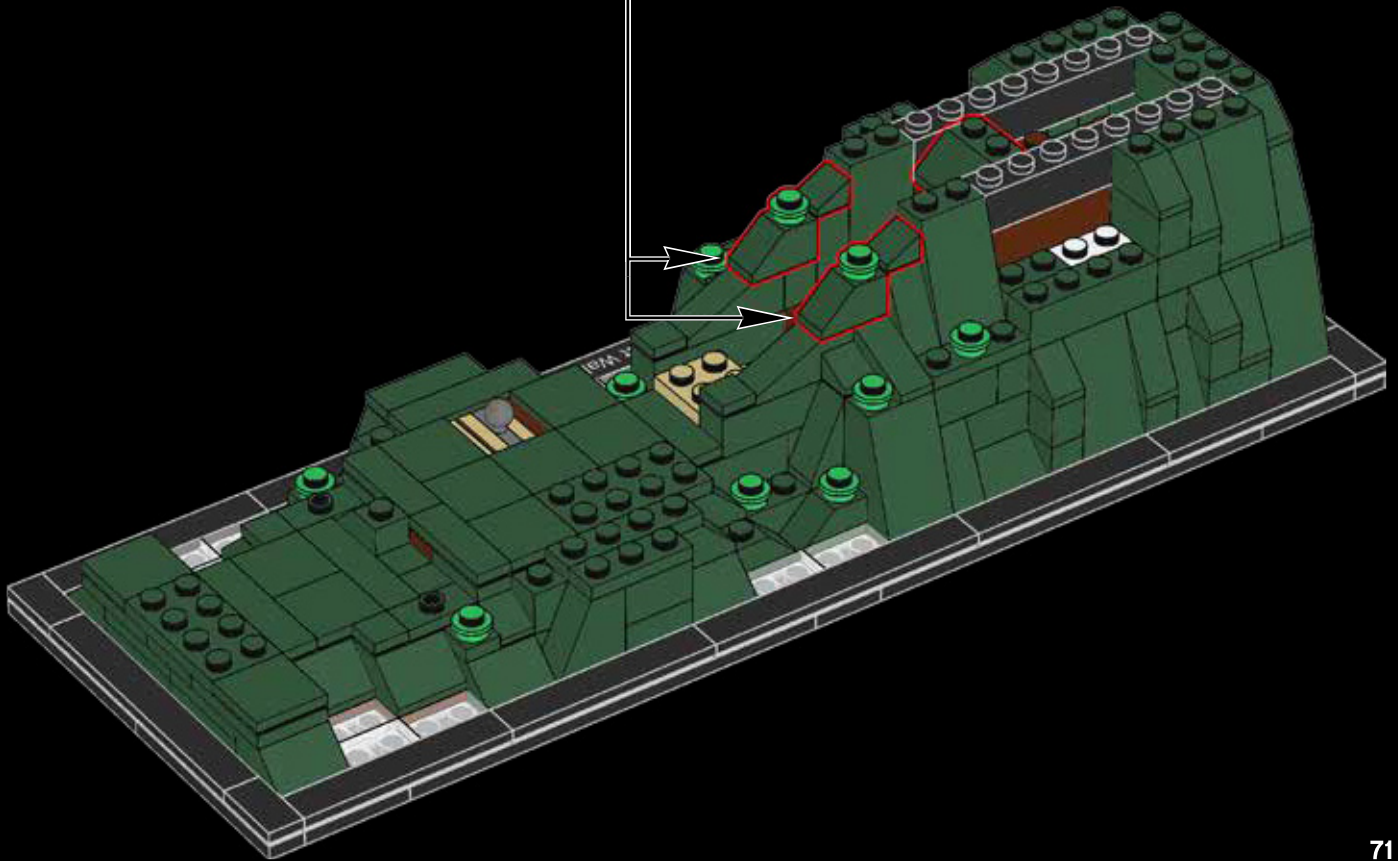
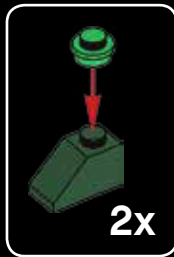



54

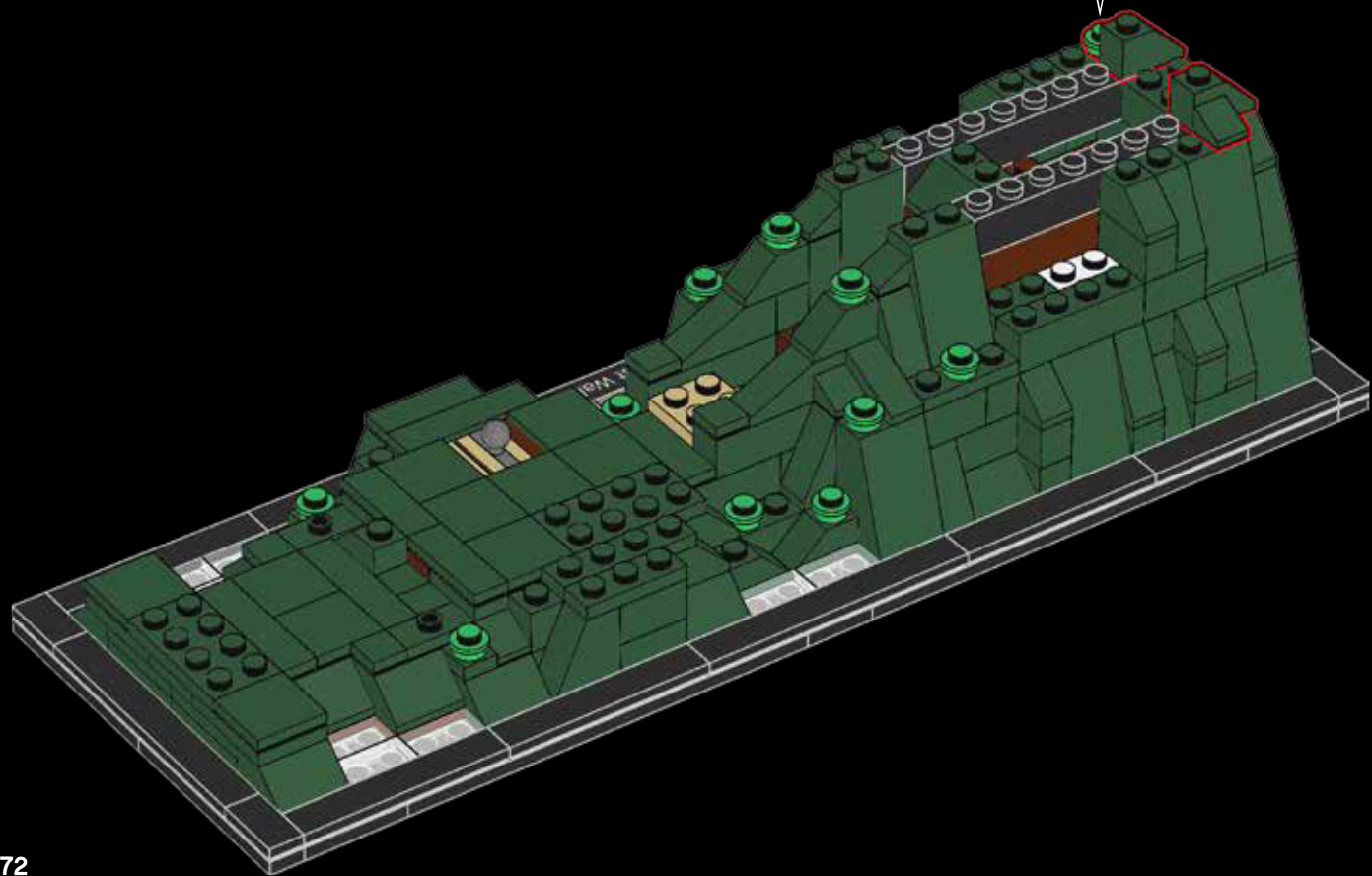





The Great Wall is the world's longest defensive fortification.  
长城是世界上最长的防御性建筑。



55

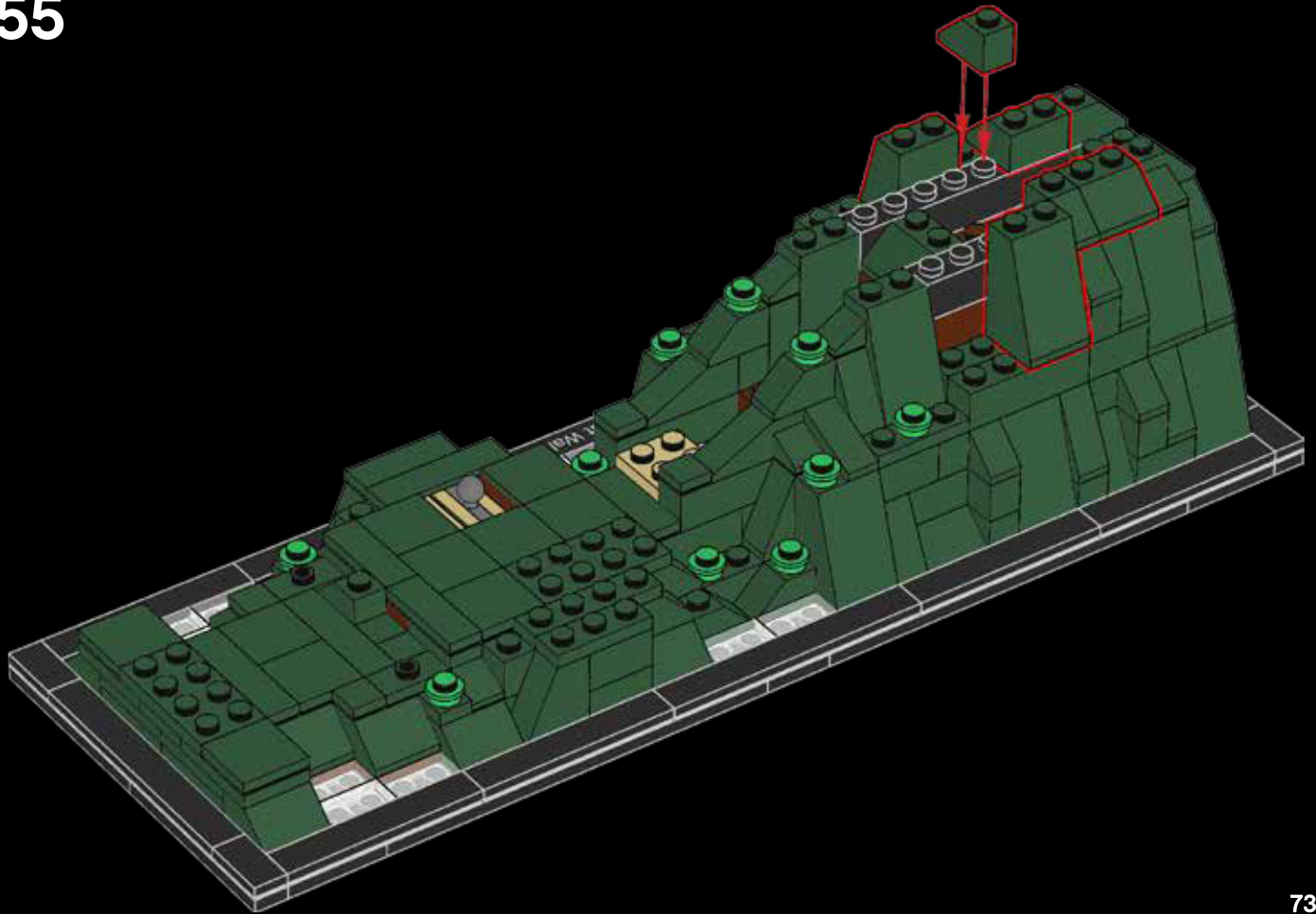



56

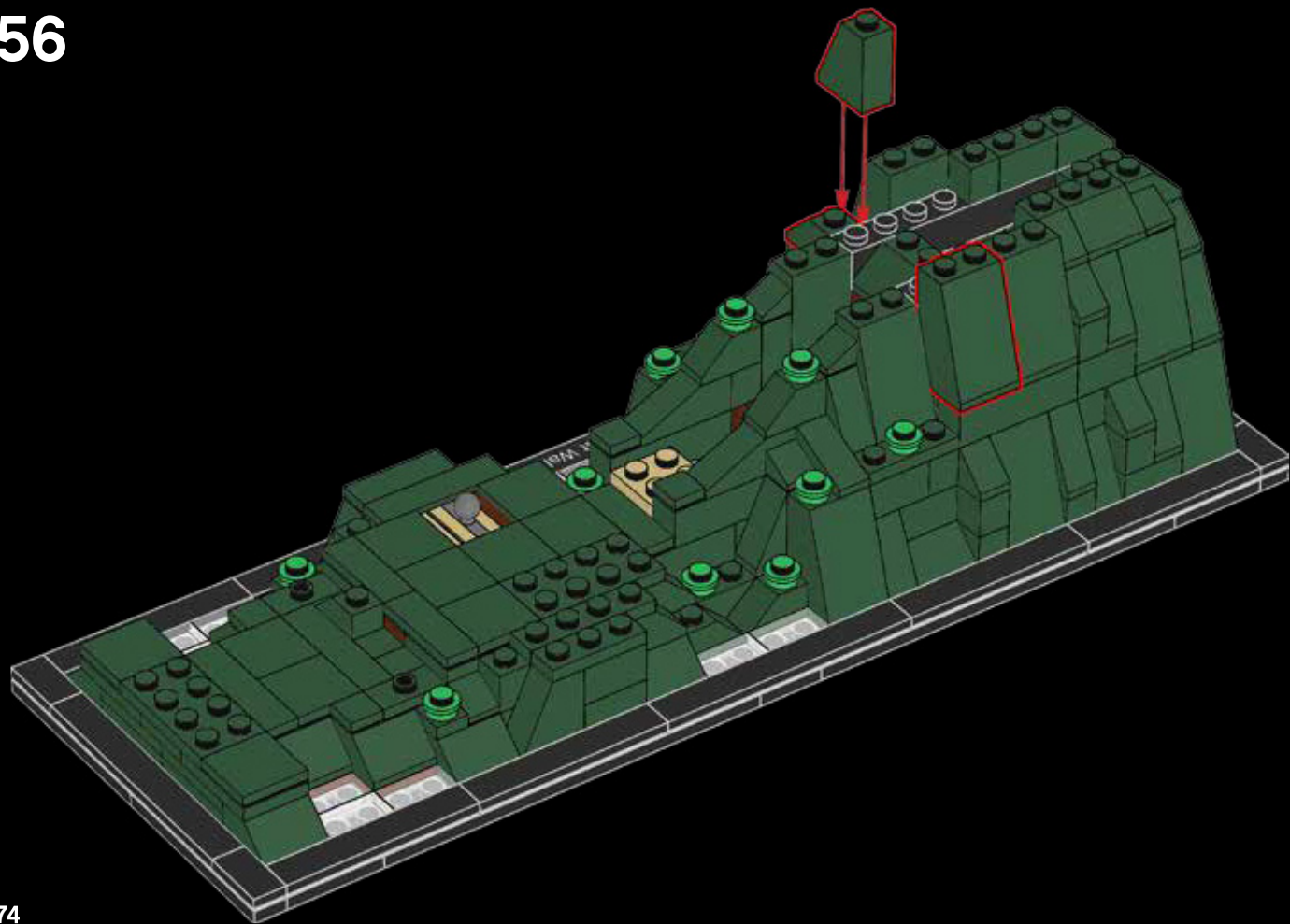



57



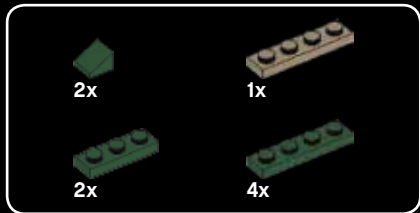

58







59

Throughout its history the wall has been called "The Purple Wall," "The Earth Dragon" and most recently "The Long Wall." 长城在历史上曾被称为“紫塞”、“土龙”，以及时间最近的“长墙”。





6x

60



78

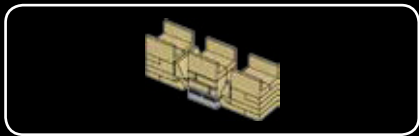

61



62



63

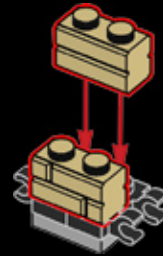

64





# 65

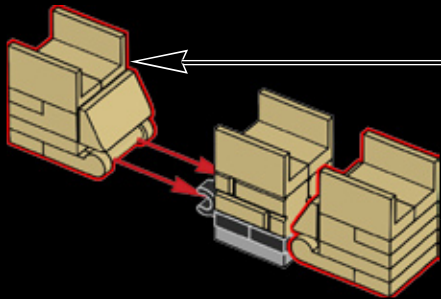
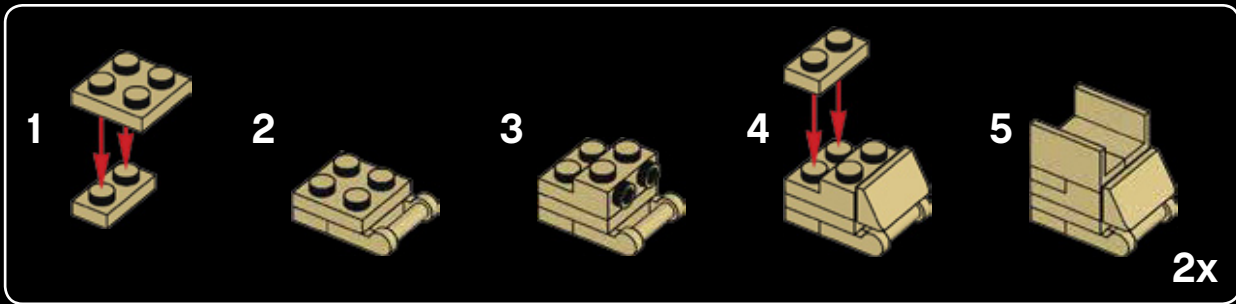



66

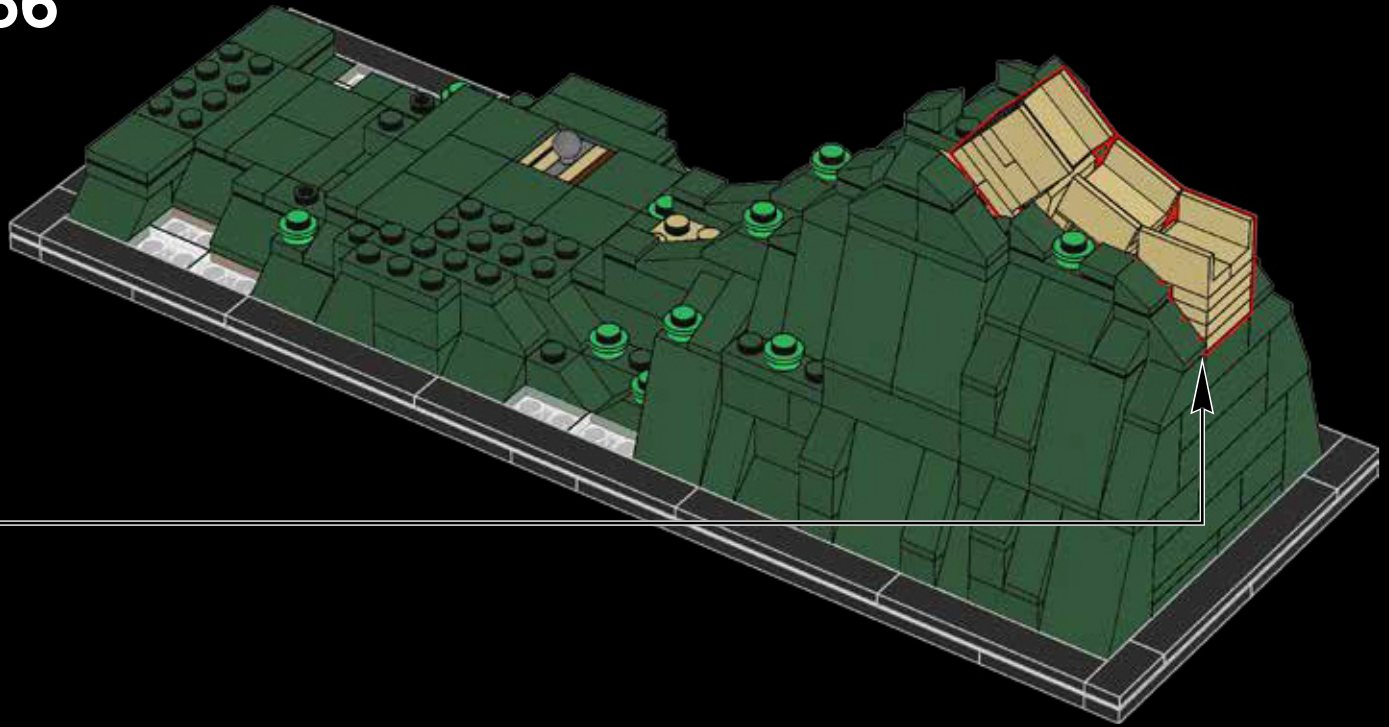



2x

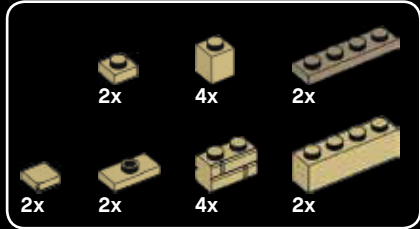

67

1



2

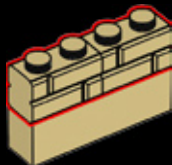

3

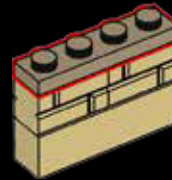

4

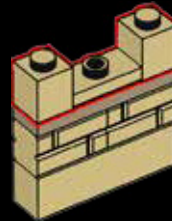

5

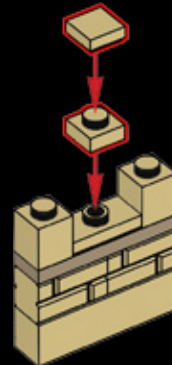

2x

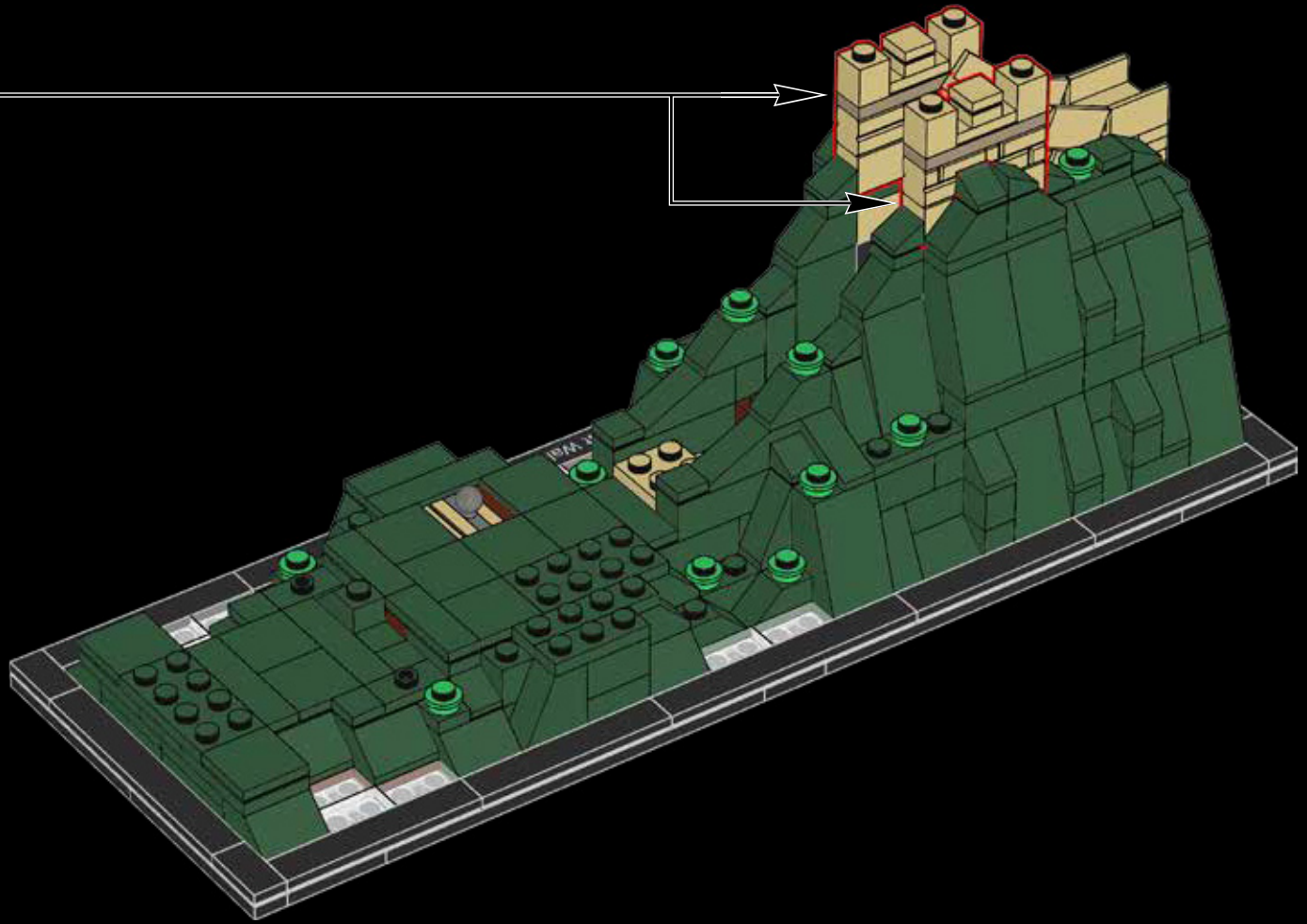

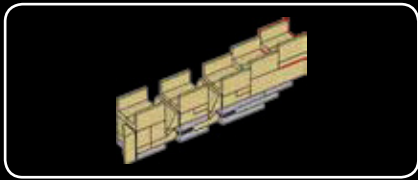

1x

68

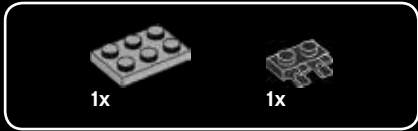

1x

1x

69

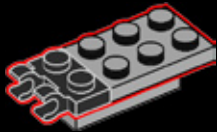

1x

1x

1x

70

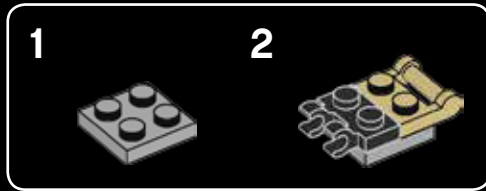

1

2

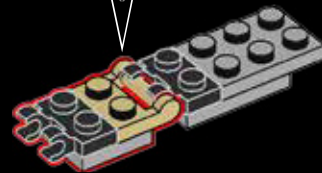





71

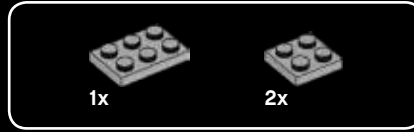
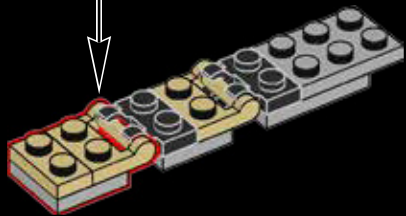
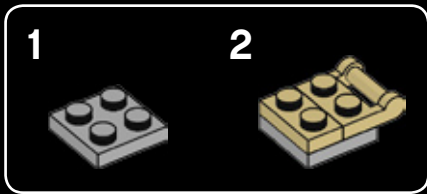

72

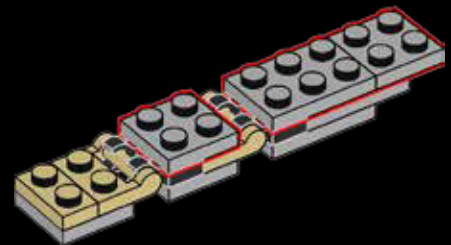



# 73

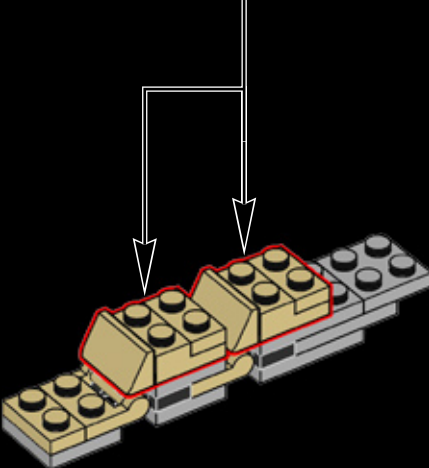
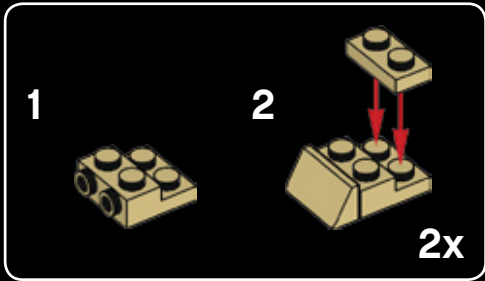

# 74

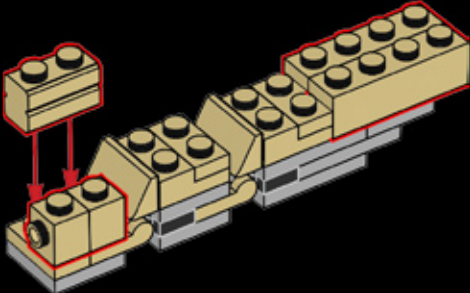



75

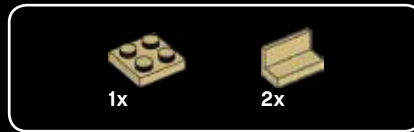
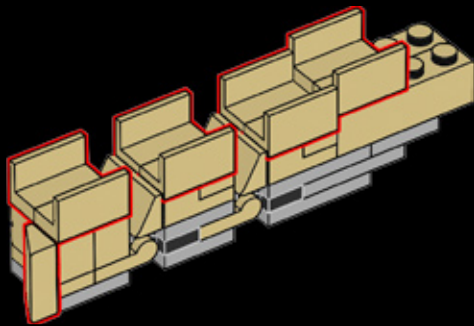

76

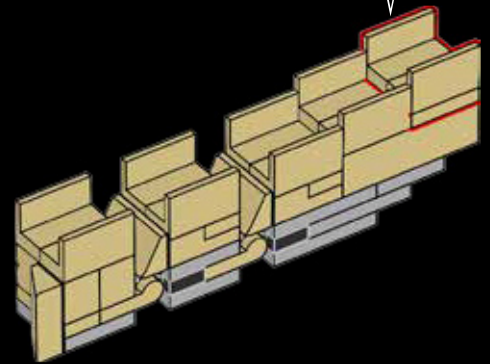
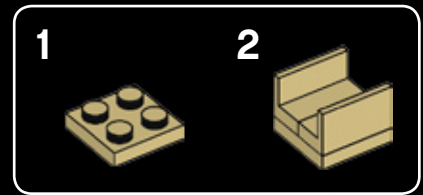

77

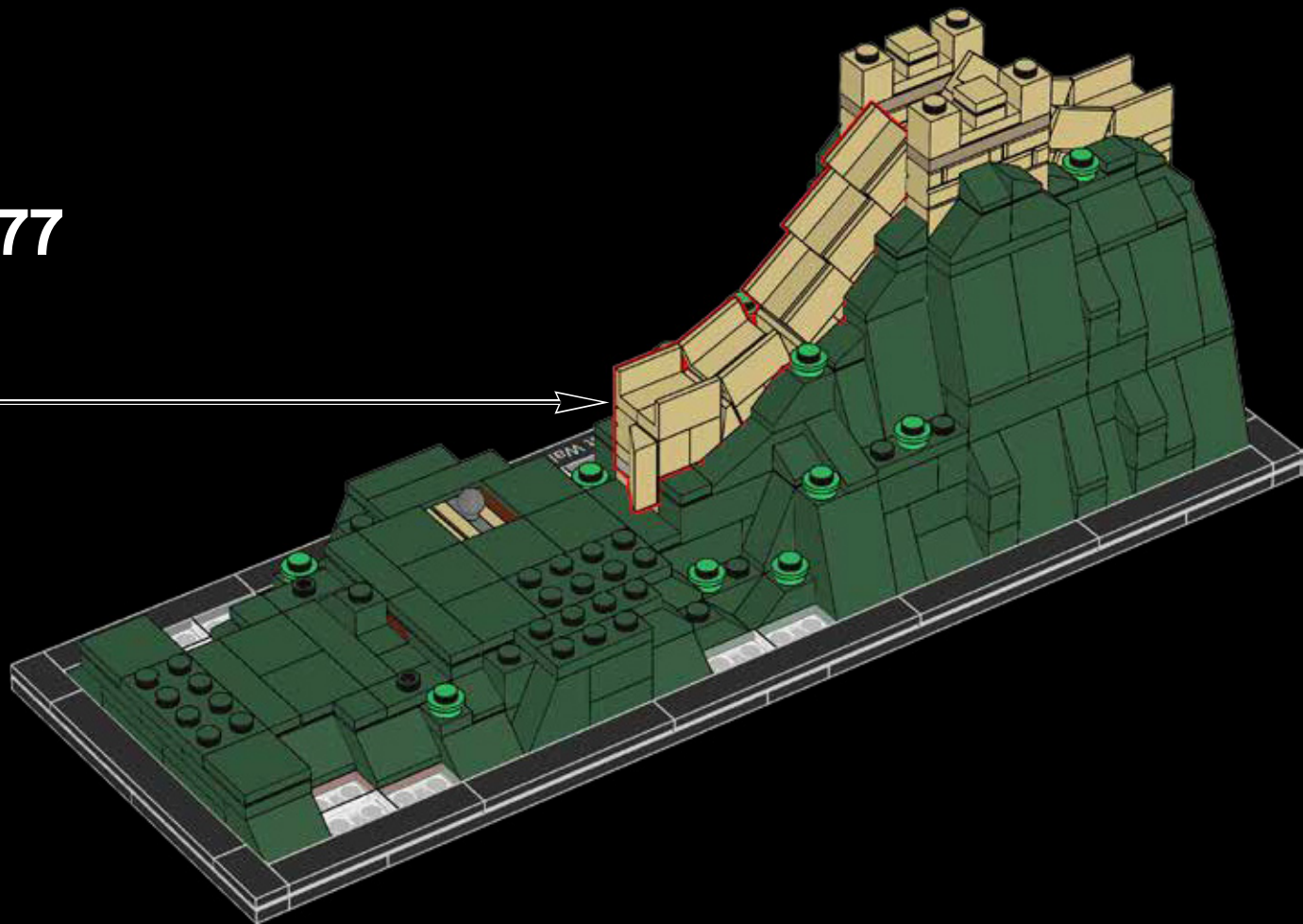

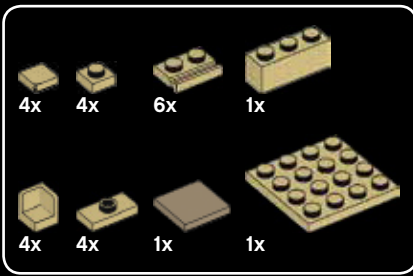

78

1

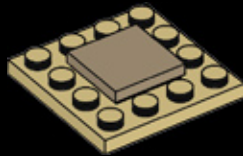

2

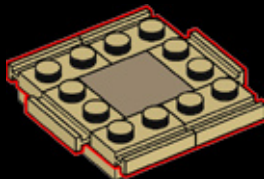

3

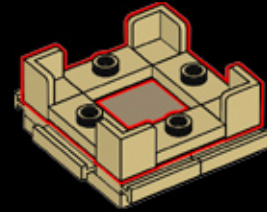

4

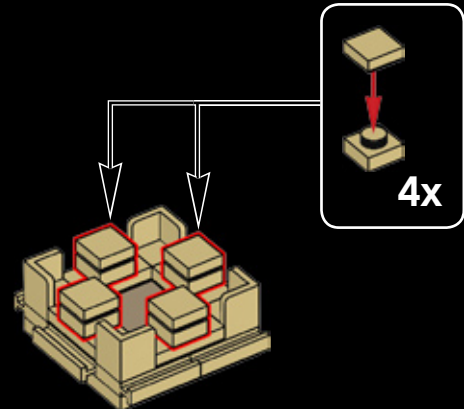

5

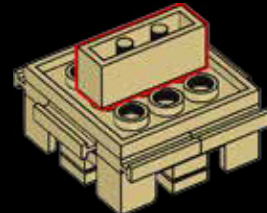
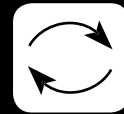



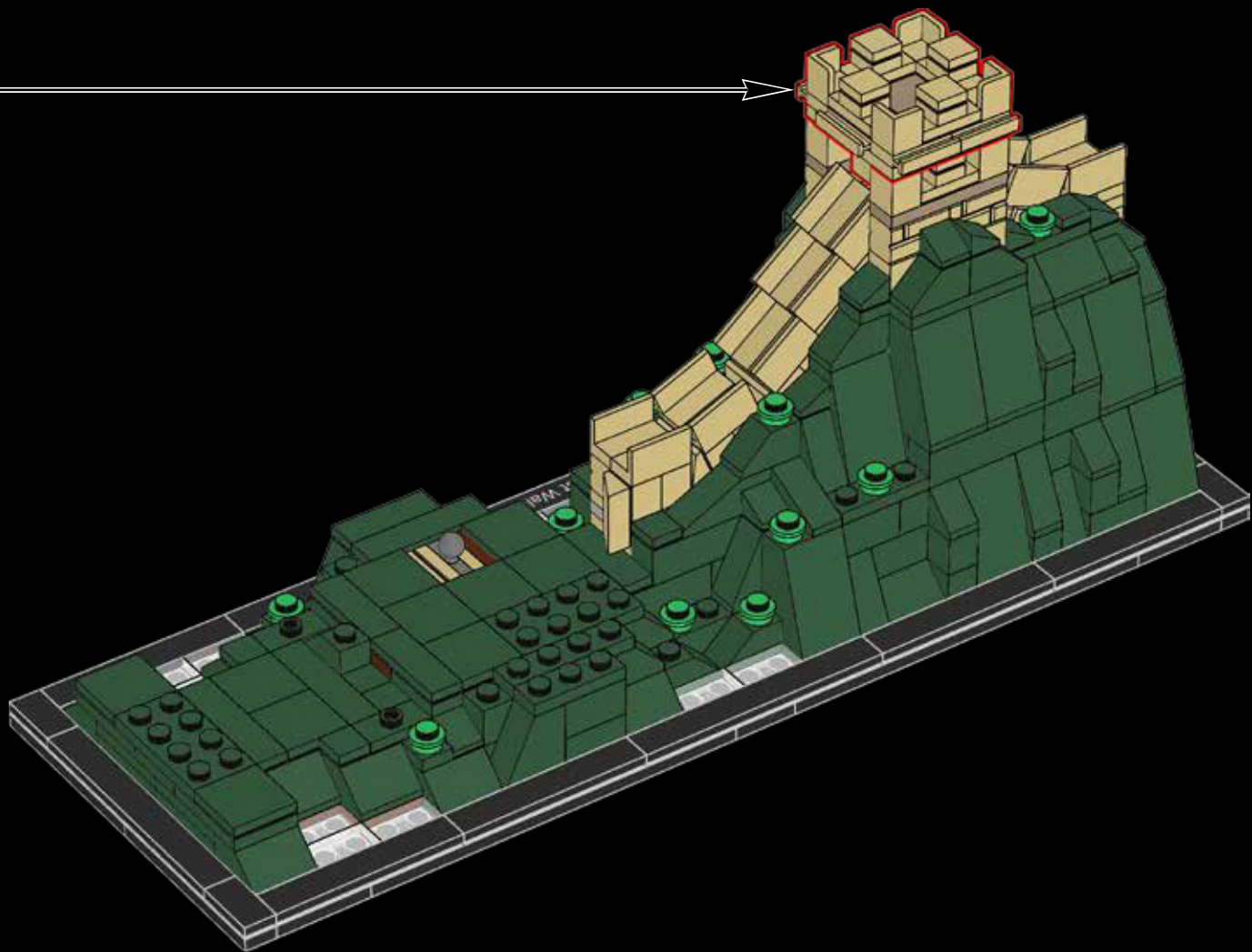

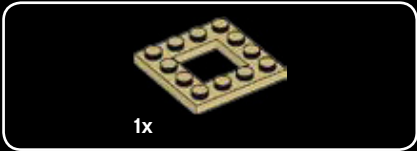
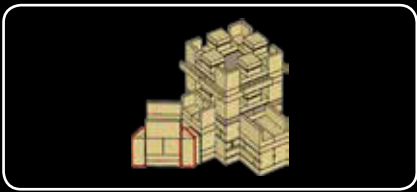

79

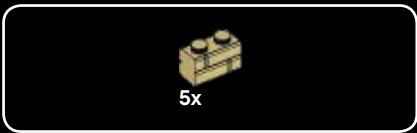
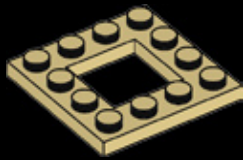

80

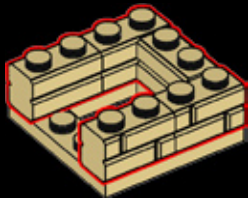

81

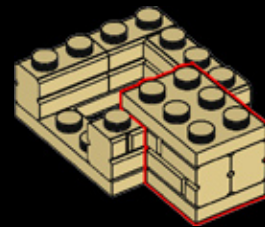
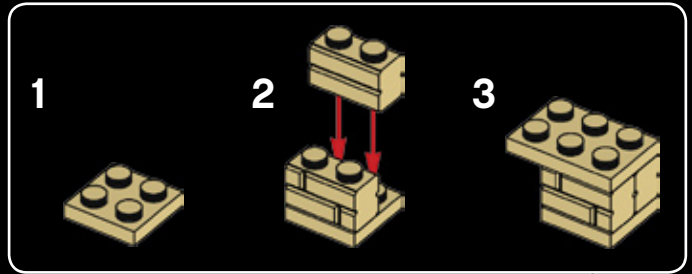



2x

82

1



2

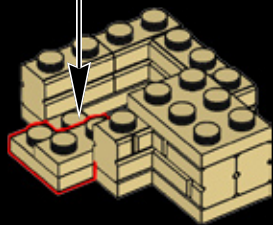

1x



1x



1x

83

1



2



3

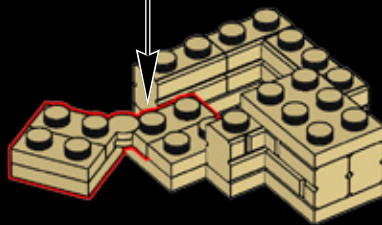

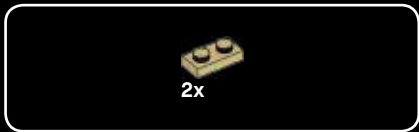

84

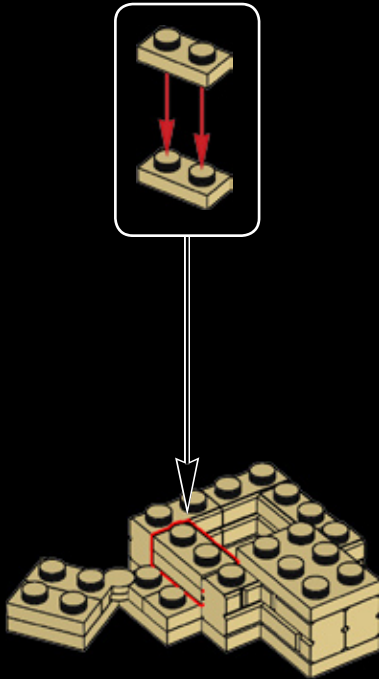

85

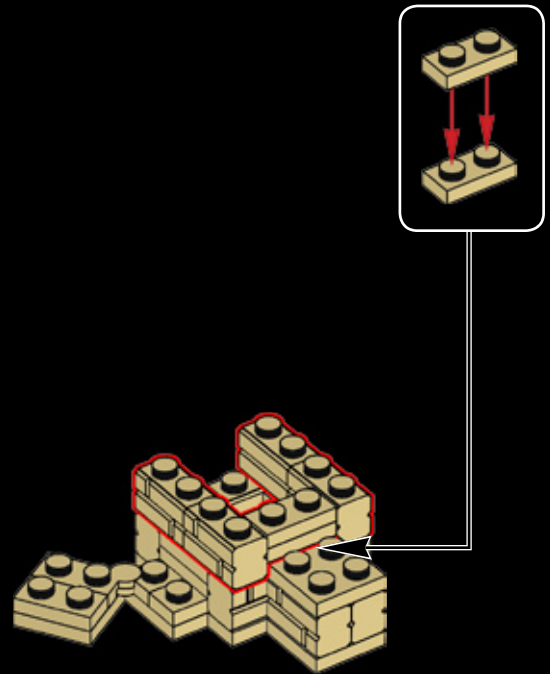

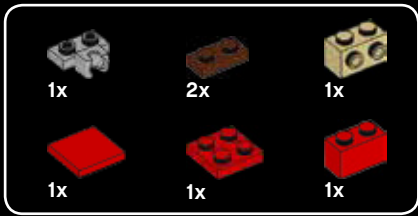

# 86

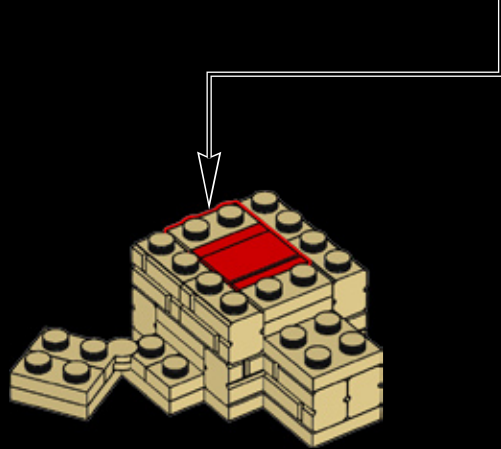
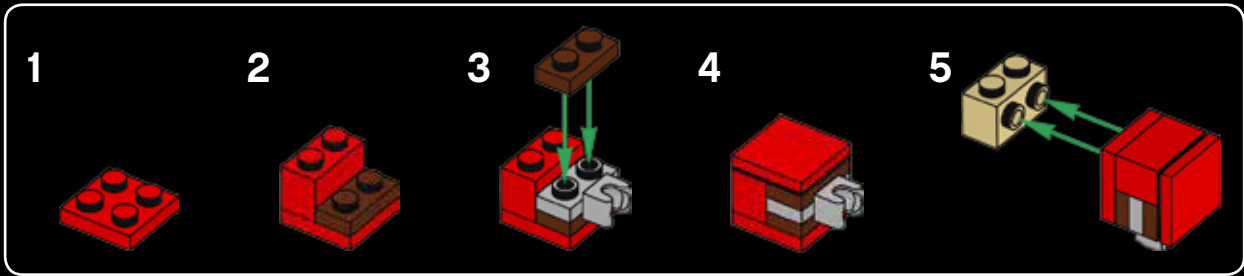





87

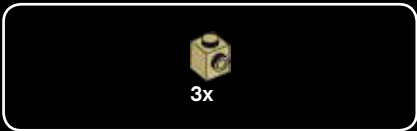
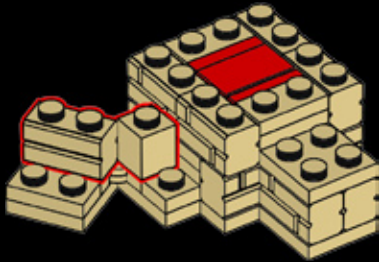

88

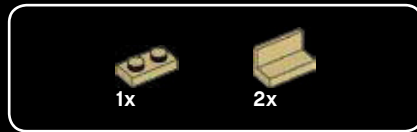
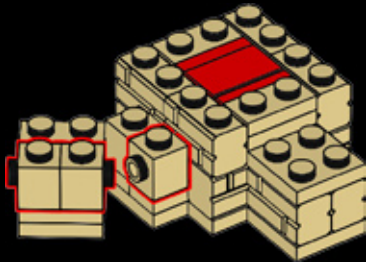

89

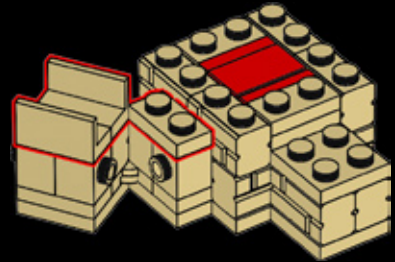

90

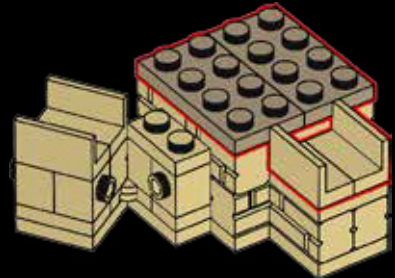



2x



4x

# 91

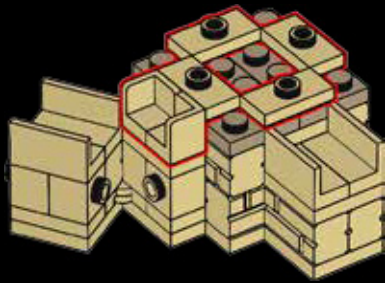

4x

# 92

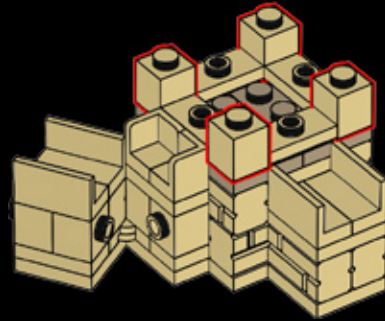



93

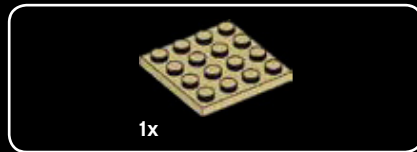
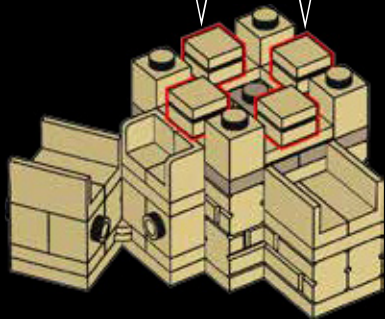
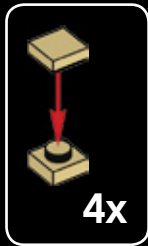

94

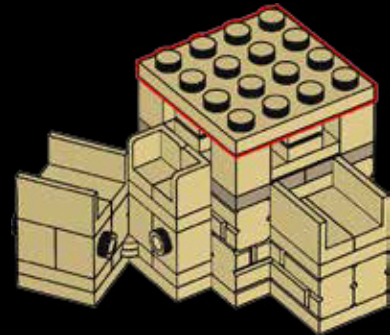



6x



1x

# 95

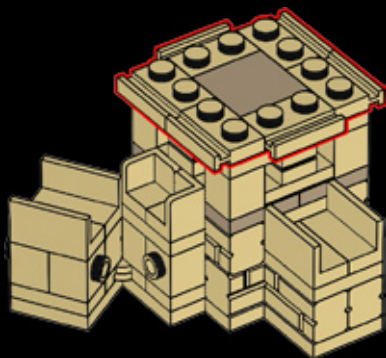

4x



4x

# 96

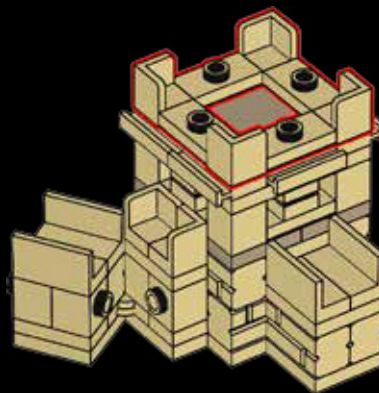



97

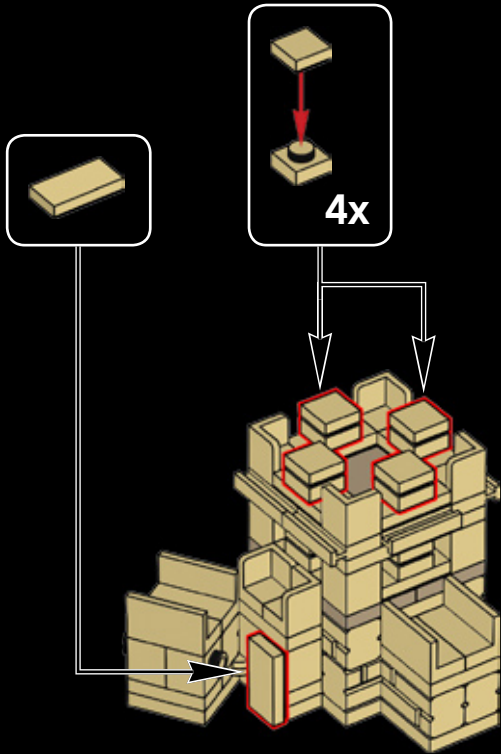

98

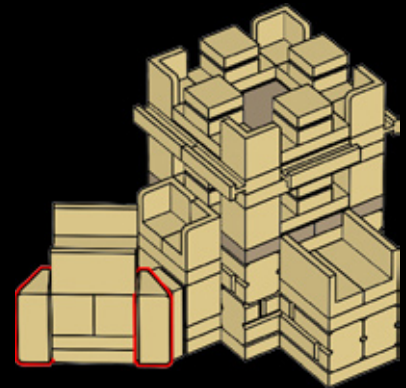



99

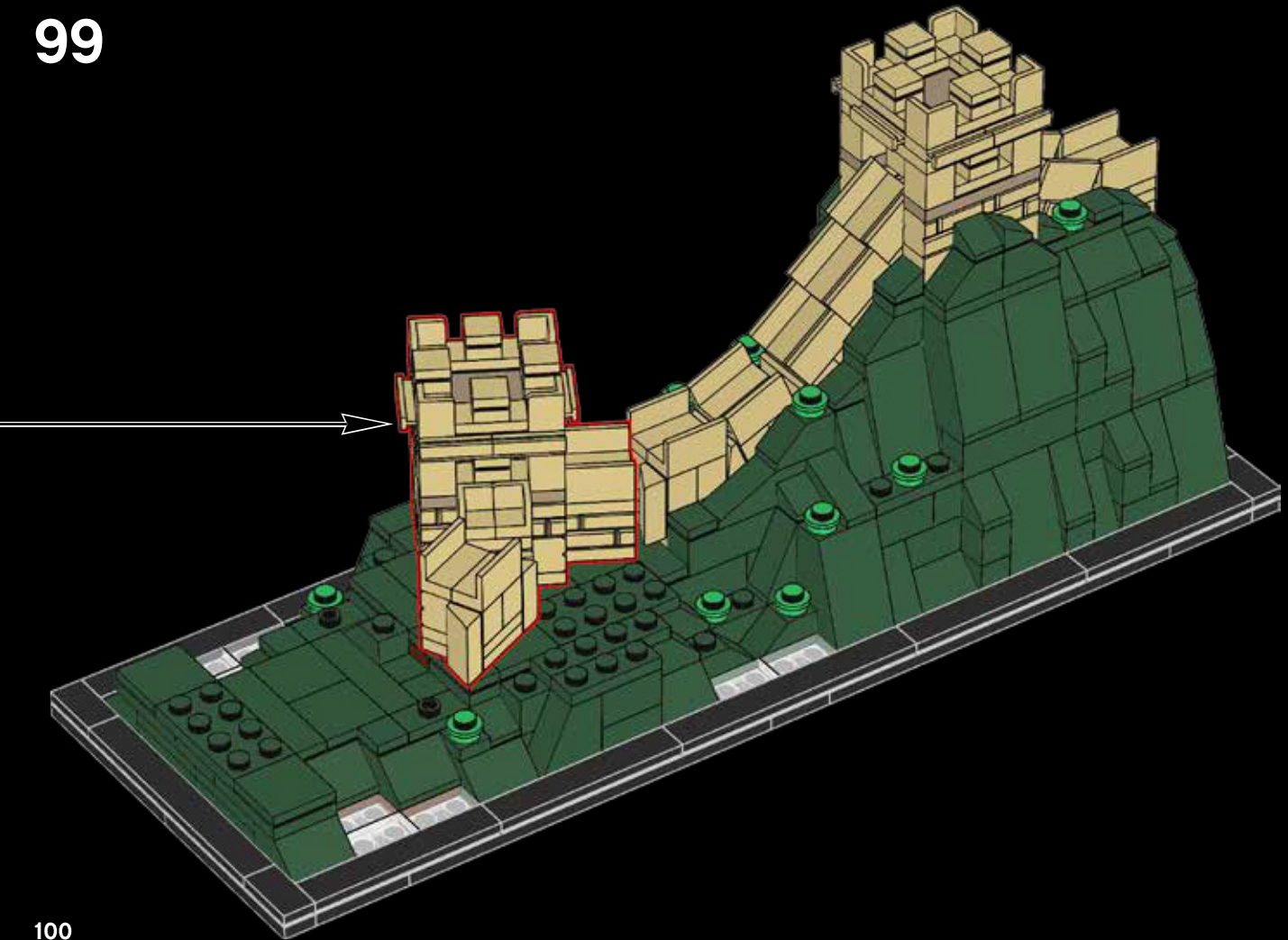

100

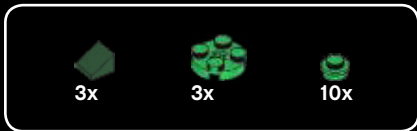

100

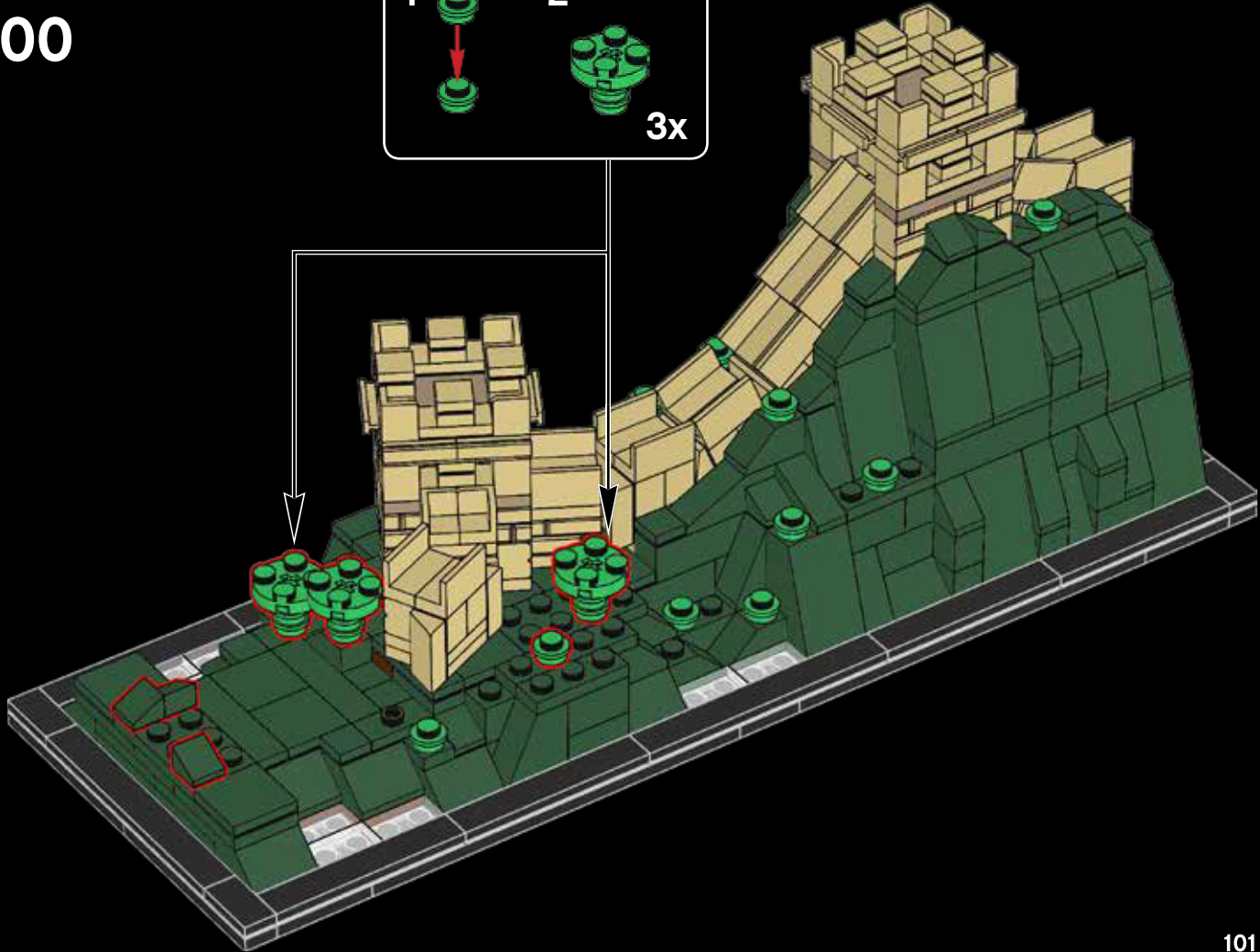
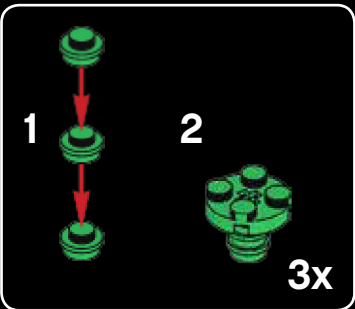



1x

101



2x

102



102



2x

2x

103

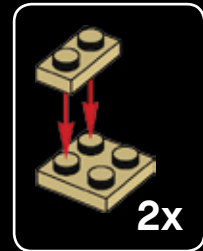

2x

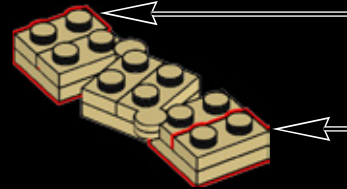

1x

1x

1x

104

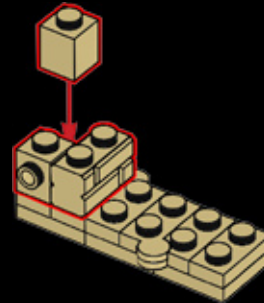



1x

1x

# 105

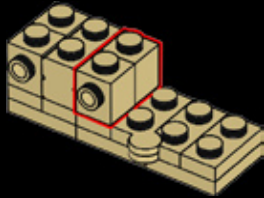

1x

1x

# 106

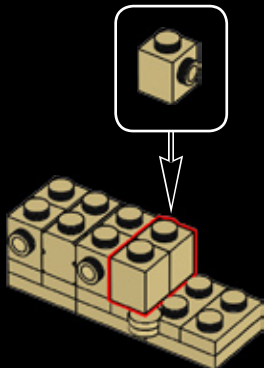

1x

1x

1x

# 107

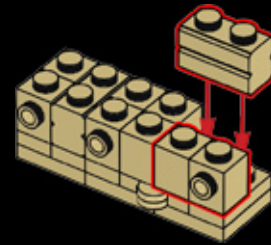

1x

4x

# 108

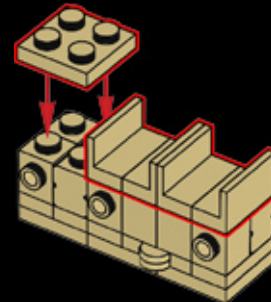



109

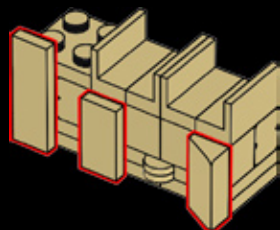

110

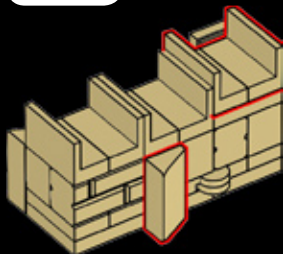

111

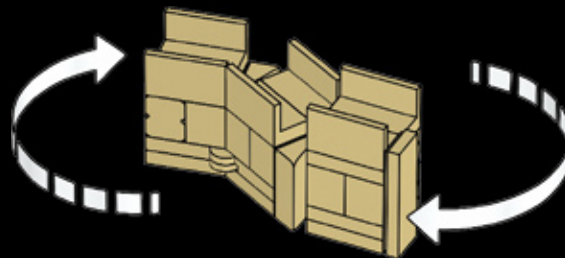



112

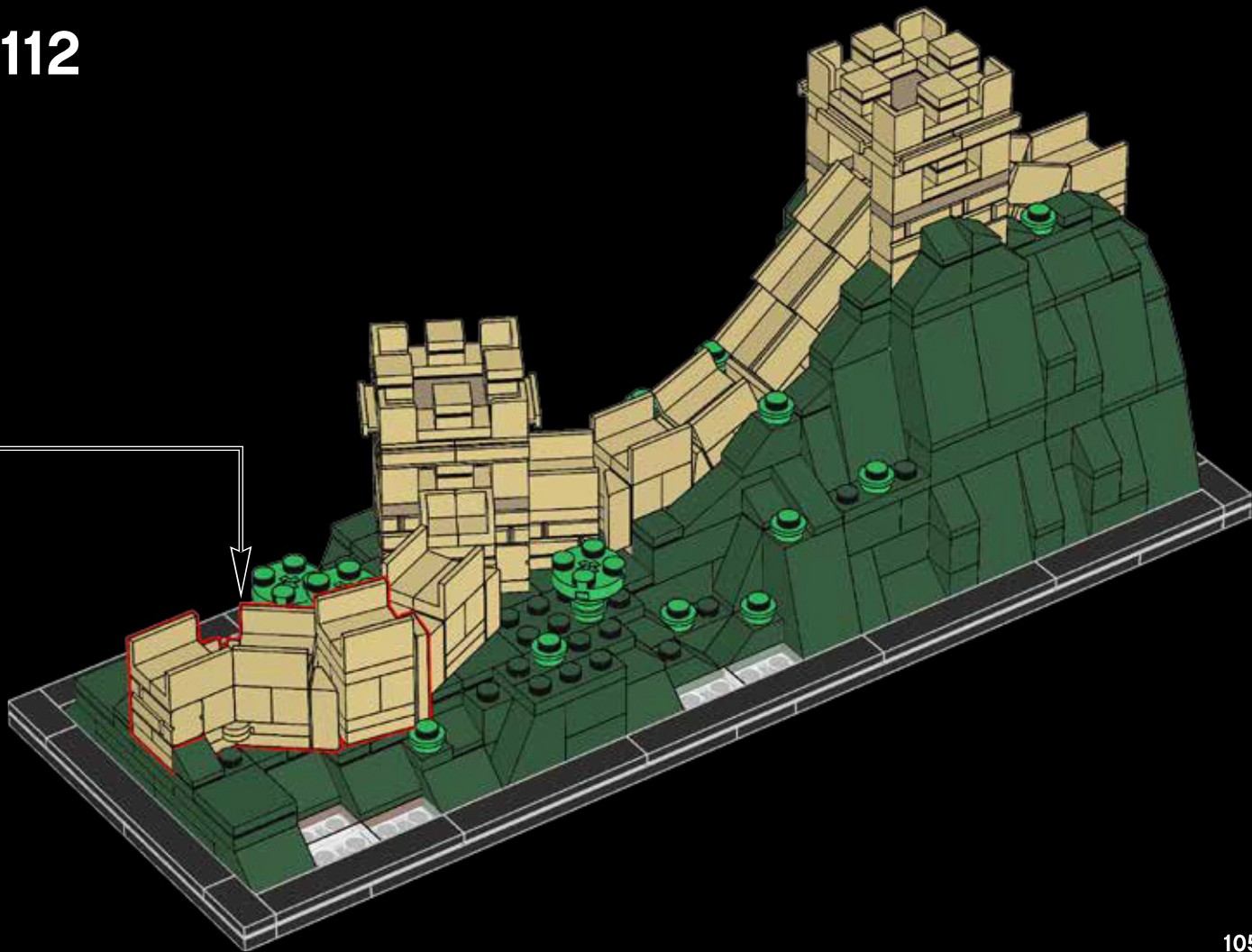

# LEGO® Architecture – do you like it?

The LEGO Group would like your opinion on the new product you have just purchased. Your feedback will help shape the future development of this product series. Please visit:

**[LEGO.com/productfeedback](http://LEGO.com/productfeedback)**

By completing our short feedback survey, you will be automatically entered into a drawing to win a LEGO® prize.

## 乐高®建筑系列——您喜欢吗？

乐高集团期待您就所购买的新产品发表看法。您的宝贵意见将帮助我们在今后改进本款产品系列。请访问：

**[LEGO.com/productfeedback](http://LEGO.com/productfeedback)**

完成我们的简短反馈调查，即可自动进入抽奖，赢取乐高®奖品。





Terms & Conditions apply.  
适用条款和条件。

## LEGO® Architecture

The LEGO® Architecture series creatively captures the essence of many of the world's most iconic landmarks while giving you an enjoyable and engaging LEGO building experience.

Whether your interest is in travel, design, history or architecture, these sets are a physical memento of great trip abroad, a famous building you know well, or a city you still dream of visiting.

Every LEGO Architecture set is designed to be displayed. Much more than just a photo, building and displaying your model on your desk, in the bookcase or on the shelf, lets you be transported every time you admire the view.

Follow us on  



Adam Reed Tucker is the co-developer of the LEGO Architecture product line.

## 乐高®建筑

乐高®建筑系列深得众多世界标志性地标建筑的神韵，同时还为您带来欢乐有趣的乐高拼搭体验。

无论您钟情于旅行、设计、历史，还是建筑，这些套装均可作为超赞的纪念品，以怀念一次超棒的国外旅行、一座您所熟知的著名建筑，或者一座您十分向往的城市。

每款乐高建筑套装都适合展示。这不仅仅是一张照片、一座建筑，或将模型摆放到办公桌上、书柜里或者架子上，每当您欣赏它们时，都会令您身临其境、如醉如痴。

请关注我们  

亚当·里德·塔克（Adam Reed Tucker）是乐高建筑产品线的合作开发者。

# Celebrate the world of architecture and collect all the models

## 纵览世界著名建筑，集齐所有乐高建筑系列模型

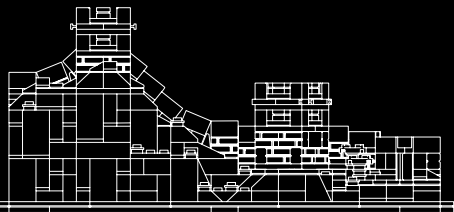

21041  
Great Wall of China  
中国长城

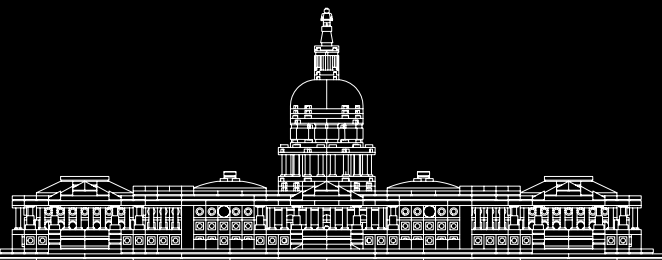

21030  
United States Capitol Building  
美国国会大厦

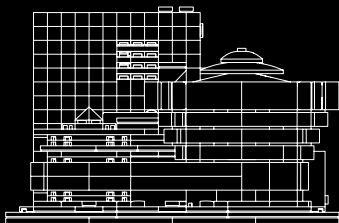

21035  
Solomon R. Guggenheim Museum®  
古根海姆博物馆

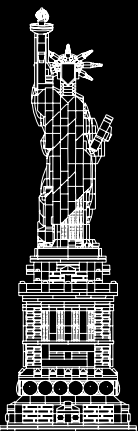

21042  
Statue of Liberty  
自由女神像



21036  
Arc de Triomphe  
凯旋门

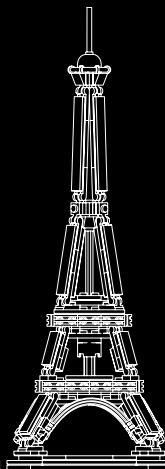

21019  
The Eiffel Tower  
埃菲尔铁塔

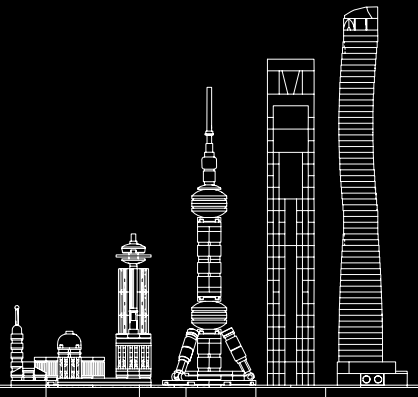

21039  
Shanghai  
乐高®建筑天际线系列：上海



21033  
Chicago  
芝加哥

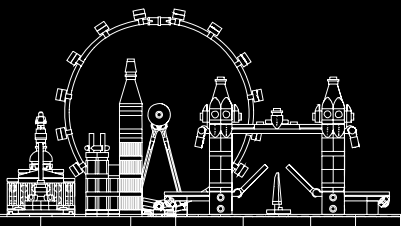

21034  
London  
伦敦

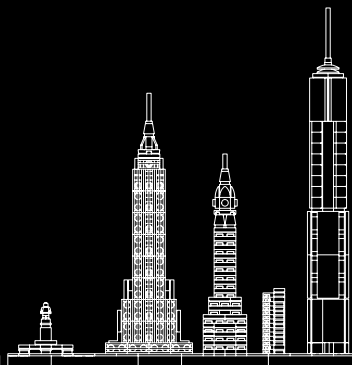

21028  
New York City  
纽约



21032  
Sydney  
悉尼



# References

Pictures -

© Shutterstock

© Offset

Text -

# 参考资料

图片 -

© Shutterstock

© Offset

文本 -

Customer Service  
Kundenservice  
Service Consommateurs  
Servicio Al Consumidor  
LEGO.com/service or dial



00800 5346 5555 :



1-800-422-5346 :

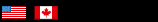

14x  
4159553

14x  
4125253

14x  
4113915

10x  
4612603

9x  
4624086

21x  
6148262

14x  
6092587

26x  
6146221

1x  
6024495

4x  
4114026

2x  
4507045

3x  
4626904

2x  
4267874

8x  
4579260

18x  
4113917

12x  
4160483

5x  
4217562

10x  
4114084

4x  
6132769

1x  
6131896

1x  
4162465

1x  
4118790

8x  
4113916

3x  
6102772

4x  
6223291

2x  
4243824

1x  
300421

1x  
306821

2x  
302221

1x  
302121

3x  
302021

4x  
306926

4x  
4556158

4x  
4283047

4x  
4283046

4x  
4283046

1x  
6226753

2x  
6171814

2x  
302024

1x  
6240515

8x  
663626

3x  
416226

1x  
6223318

2x  
300826

1x  
244526

4x  
302826

10x  
4569297

25x  
4569058

3x  
403228

5x  
4521915

8x  
6055171

21x  
4504375

19x  
6003331

22x  
4245570

2x  
6192250

30x  
4255624

10x  
4528778

13x  
6226384

15x  
6223304

9x  
6214611

7x  
6013975

4x  
6168573

4x  
4650622

10x  
4650244

12x  
4245571

3x  
4543949

5x  
6020923

3x  
4586057

2x  
4260493

2x  
6215657

7x  
4211150

6x  
4211201

2x  
4211193

2x  
4217848

9x  
4181142

1x  
6039479

1x  
6043656

4x  
4211388

5x  
4211397

2x  
4211353

3x  
4211396

5x  
4211522

