

1

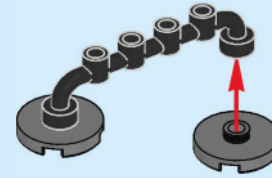

2

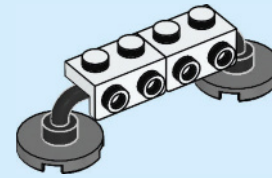

3

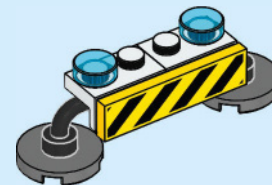

1

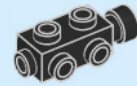

2

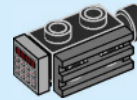

3

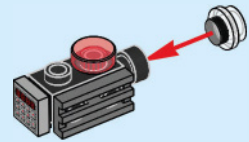

4

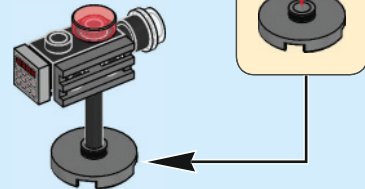

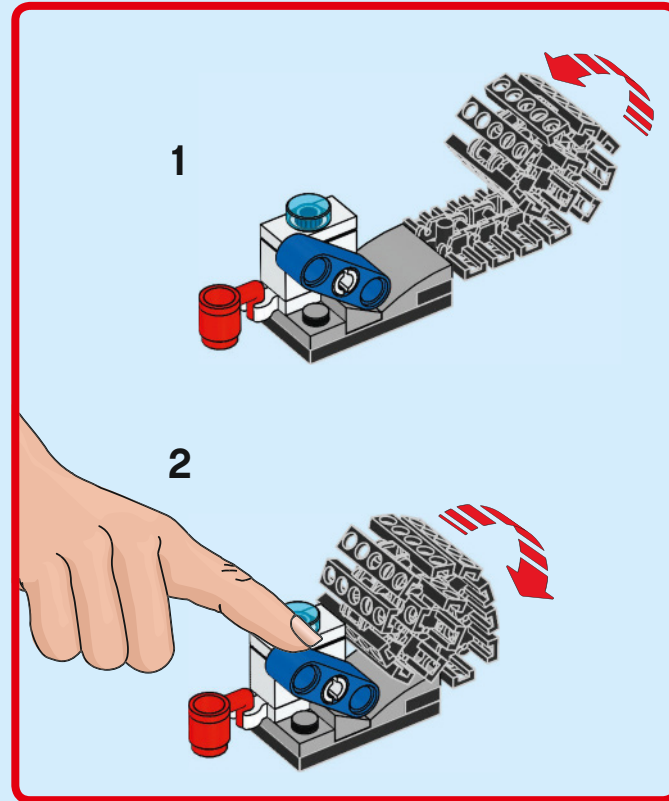
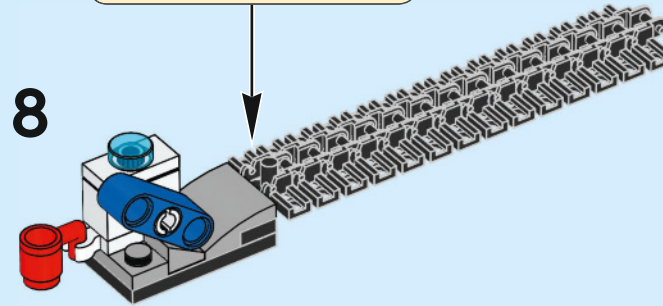
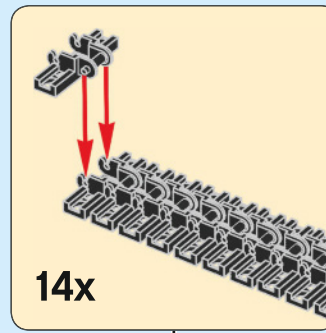
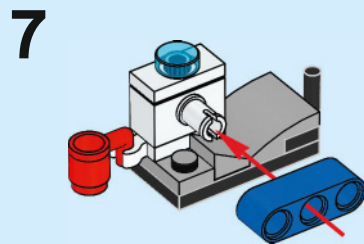
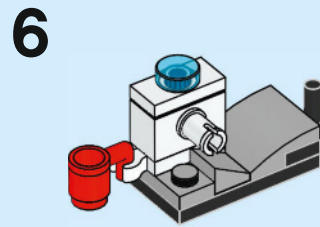
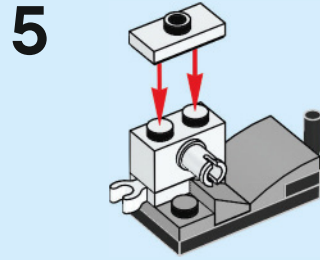
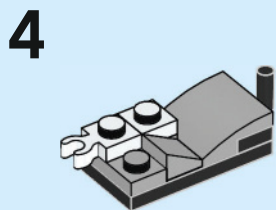
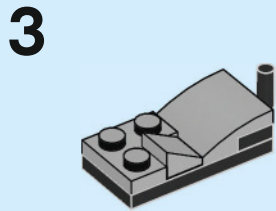
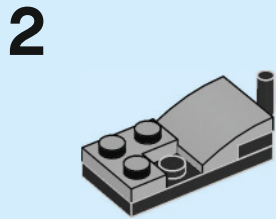
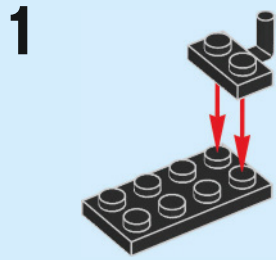

1x
302401

1x
4613256

1x
6051511

2x
6018774

1x
4160228

1x
6055384

1x
6100054

14x
6047885

1x
4569733

1x
4523339

1x
6116604

1x
302026

1x
614026

1x
606428

1x
389921

1x
4509376

1x
6021844

1x
389921

1x
4509376

1x
6021844

1x
6172536

1x
4119091

1x
3005740

1x
4646864

3x
4646861

1x
6055889

1x
4162916

1x
4521921

1x
6142309

1x
4211353

1x
6102357

3x
6115080

1x
4210631