



THE WHITE HOUSE

WASHINGTON D.C., USA



Architecture

Booklet available in English on
Heft in deutscher Sprache erhältlich auf
Livret disponible en français sur
Libretto disponibile in Italiano su
Folleto disponible en español en
如需中文版手册, 请访问

LEGO.com/service/buildinginstructions



The White House

The White House is an enduring symbol of the United States and one of the most famous buildings in the world. Every president since John Adams has occupied the White House and countless leaders and dignitaries have been entertained within its walls. It's a place where many momentous decisions have been taken and where history continues to unfold.



James Hoban's White House design.
Wikimedia Commons



Lorenzo Winslow's 1948 plan for changes.
White House Museum

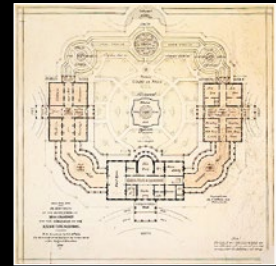

Alterations to the Executive Mansion.
Library of Congress, Prints & Photographs Division



The History

The first president, George Washington, selected the site in 1791 and a competition design submitted by Irish-born architect James Hoban was chosen a year later. During the War of 1812, the British set fire to The White House and James Hoban was appointed to rebuild it. Completed once again in 1817, there have been countless renovations and additions since.



James Hoban

The White House Historical Association (White House Collection)



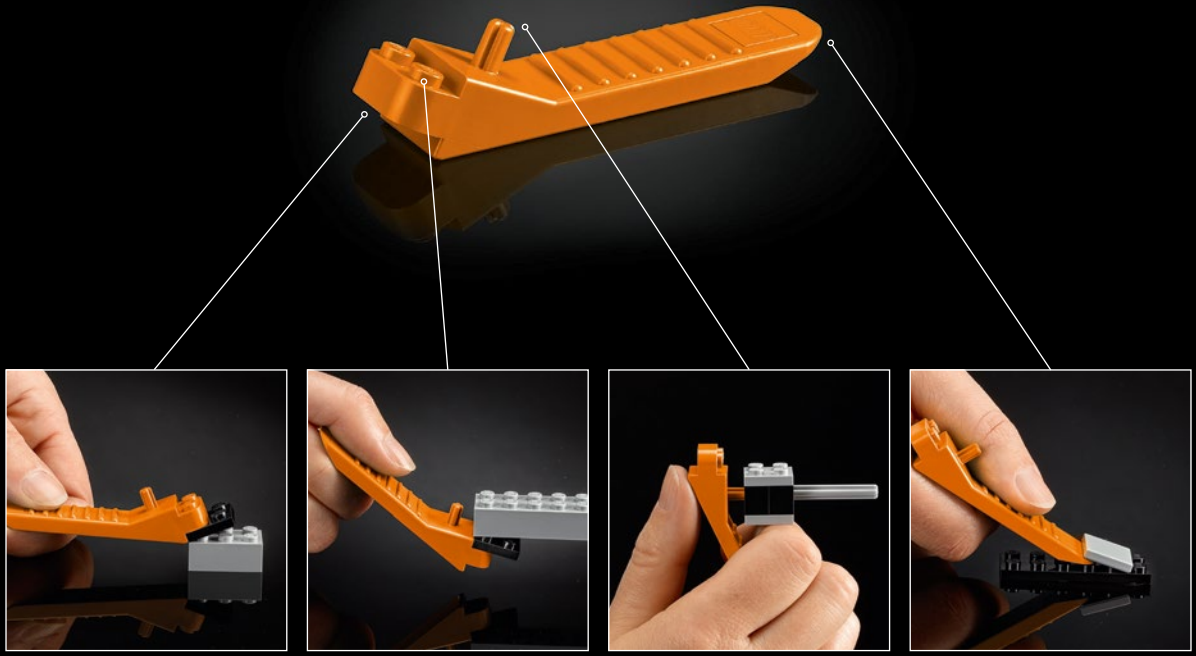

LEGO.com/brickseparator

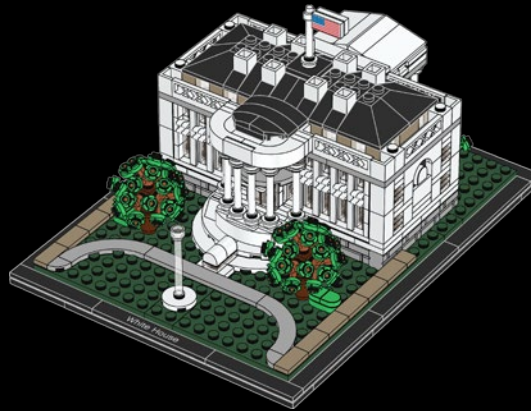







A Grand Mansion



The White House is a grand mansion in the neoclassical Federal style with details that echo classical Greek architecture. The style shares its name with the Federal Period in American history, a time when the founding generation of the young Republic consciously chose to associate the nation with the ancient democracies of Greece and the republican values of Rome.

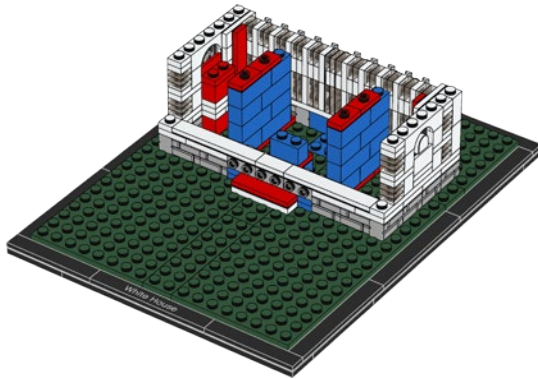
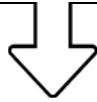

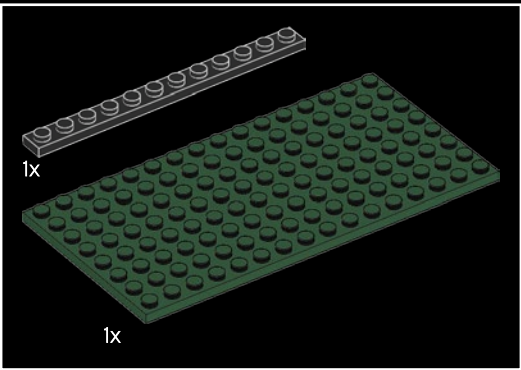
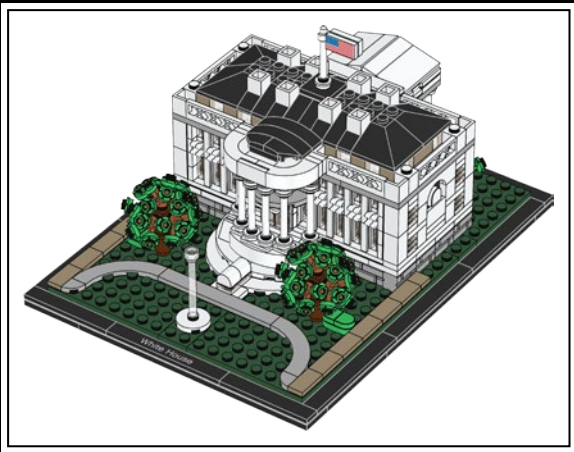

1

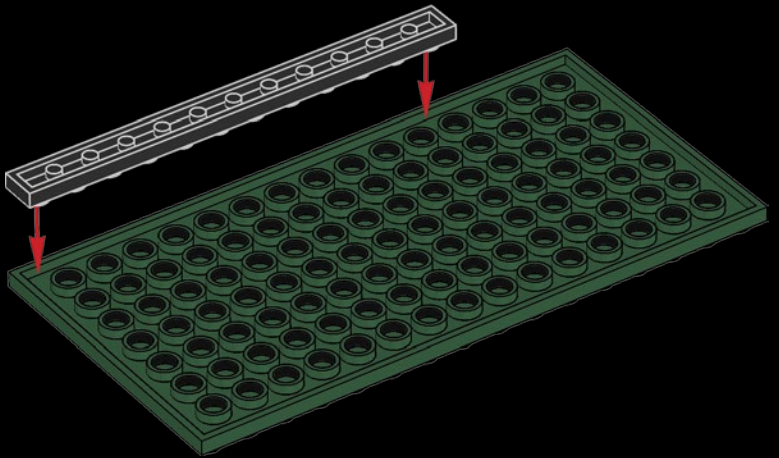

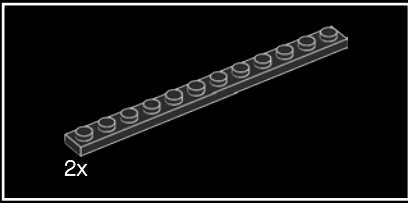

2

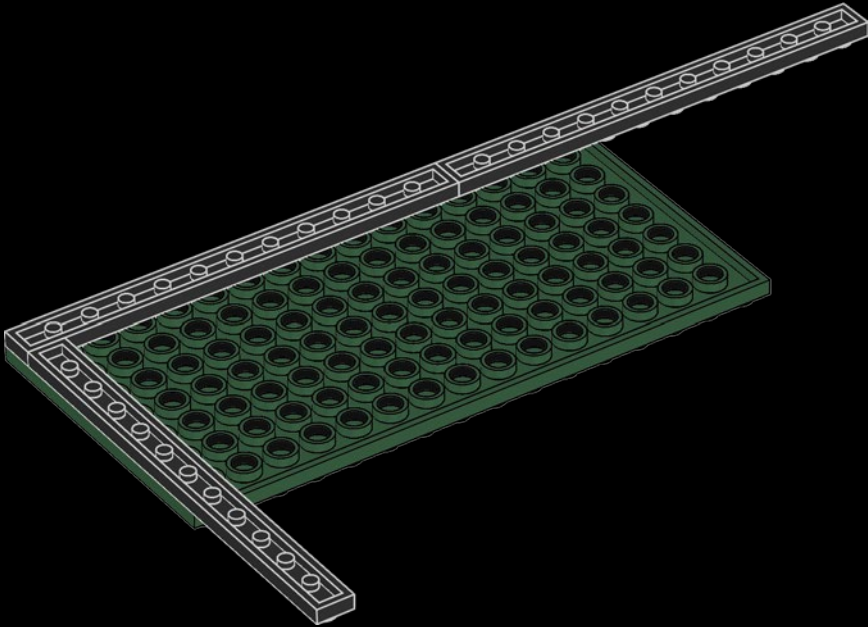

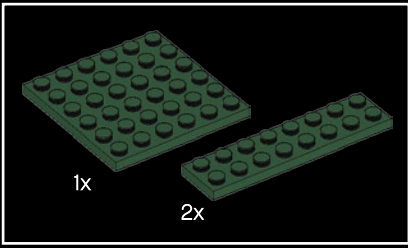

3

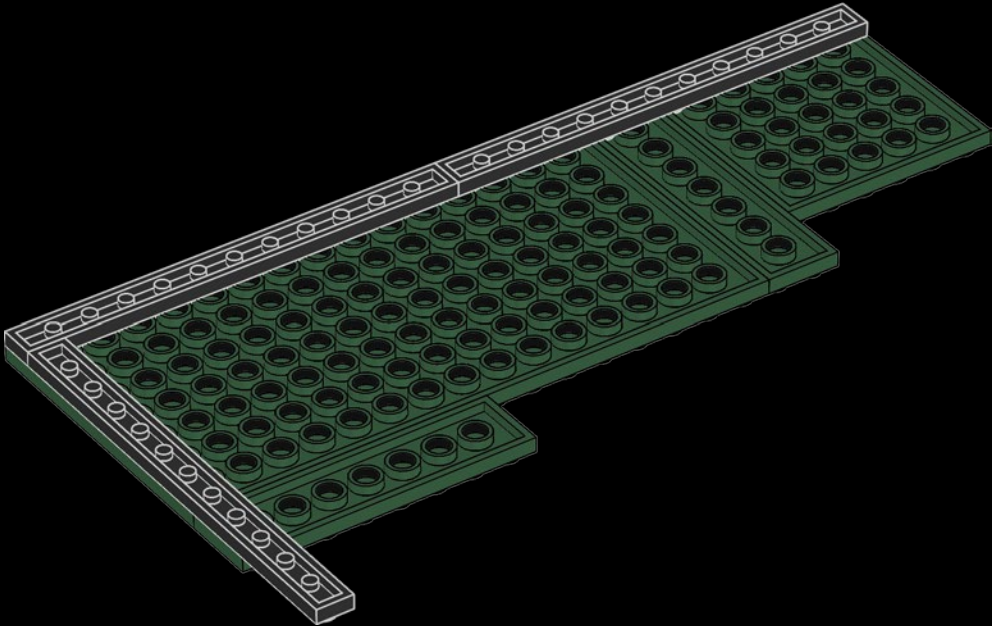

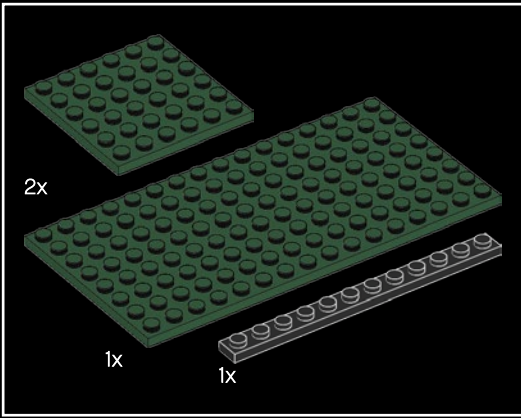

4

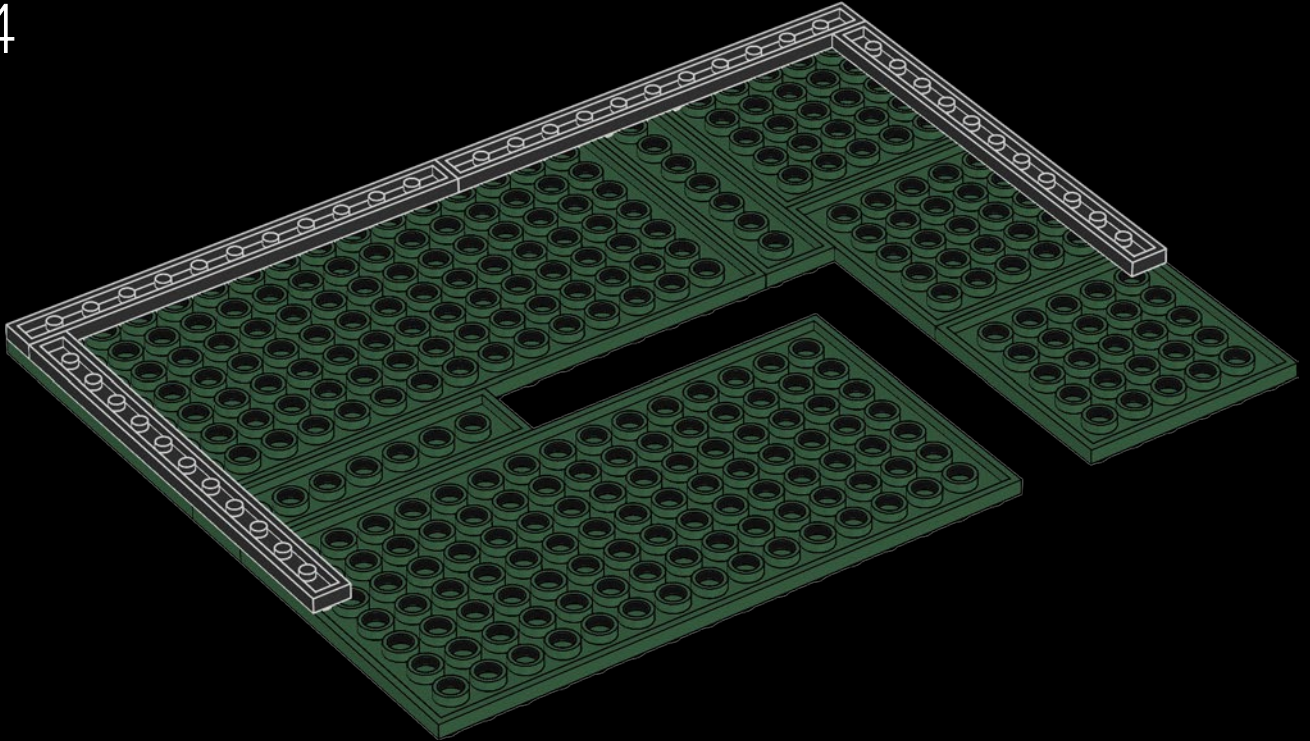

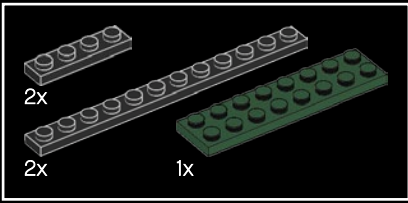

5

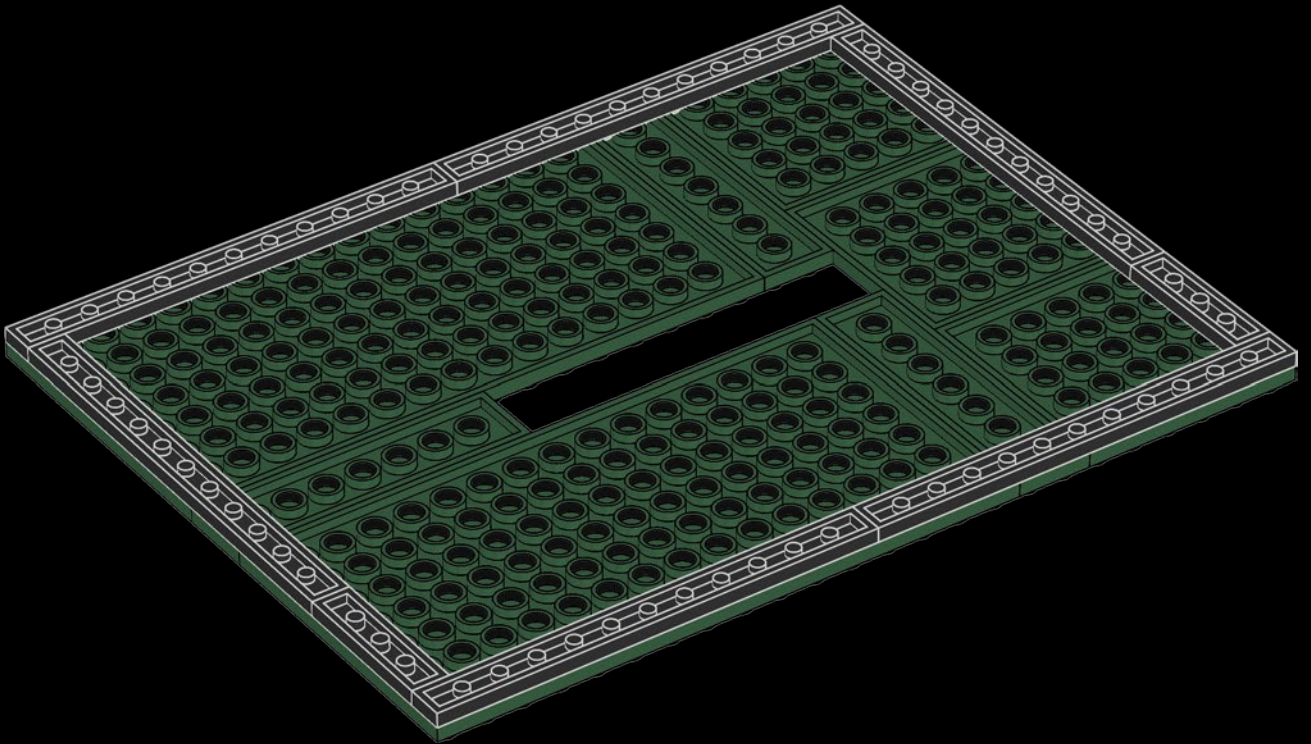

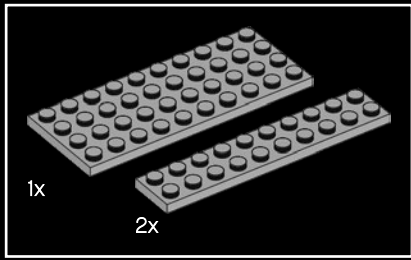

6

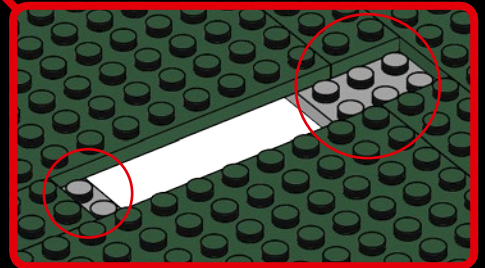
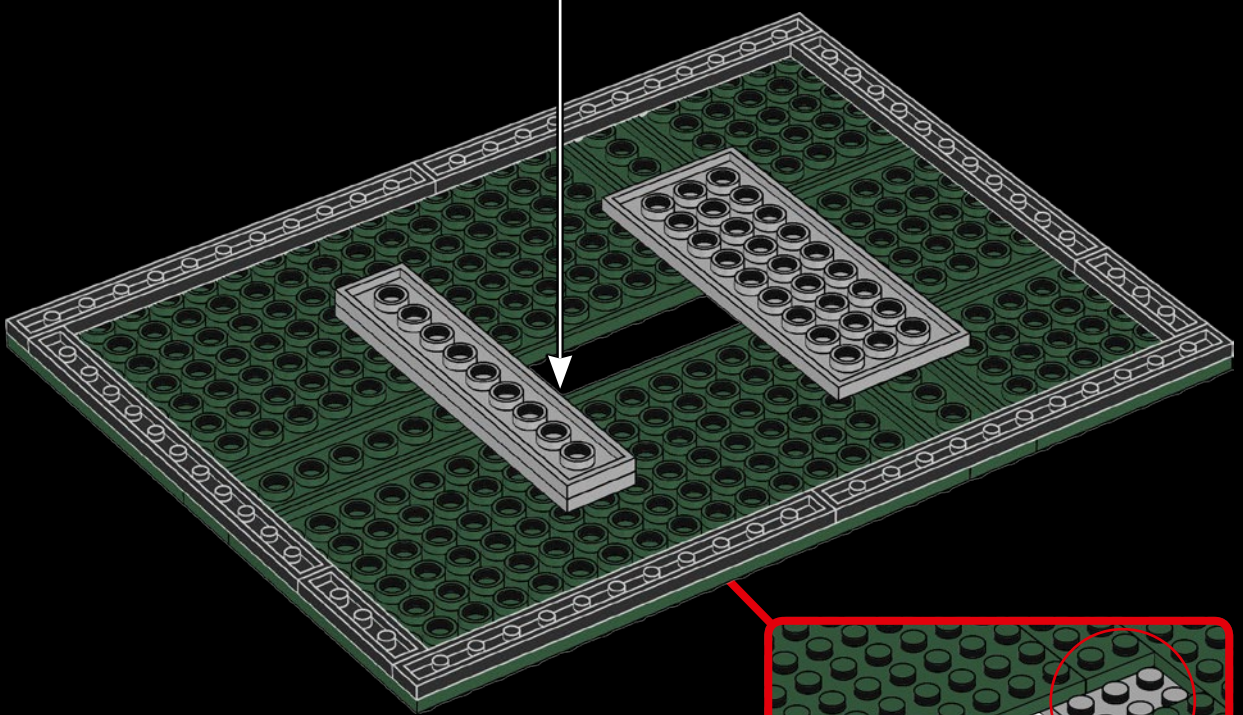
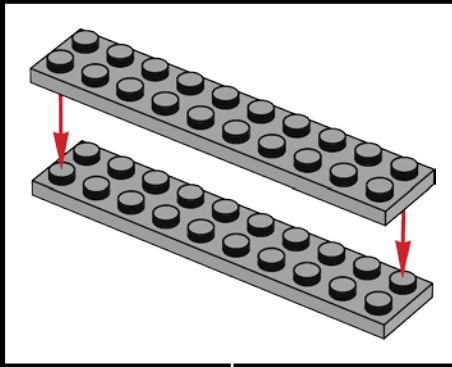

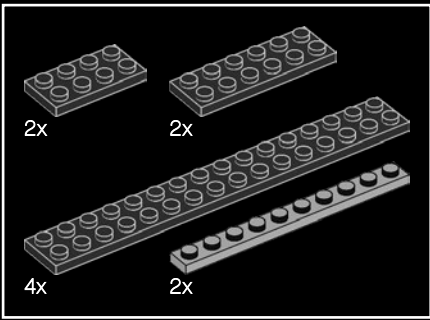

7

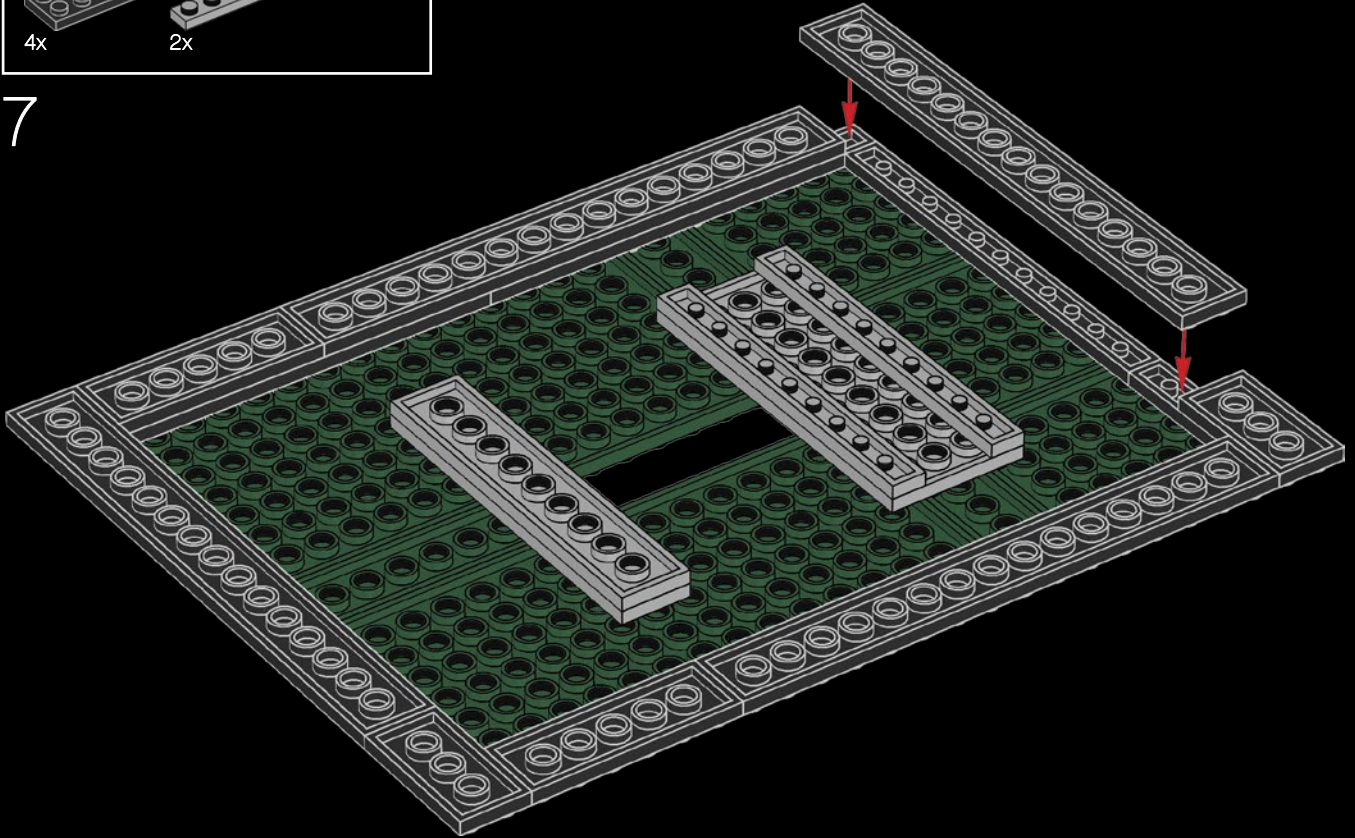

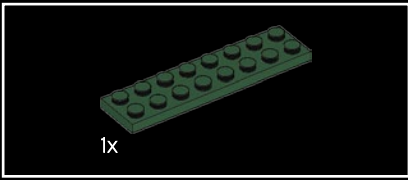

8

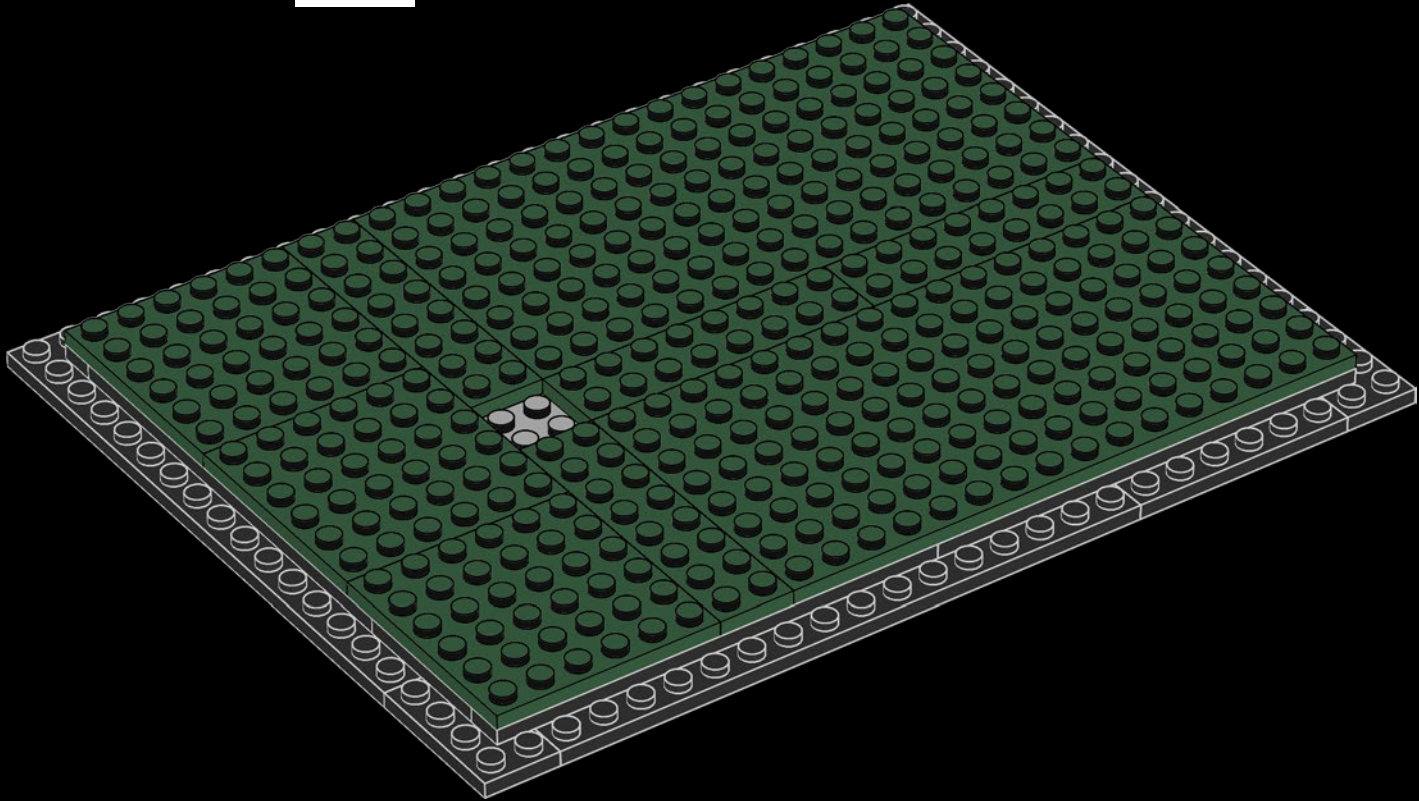

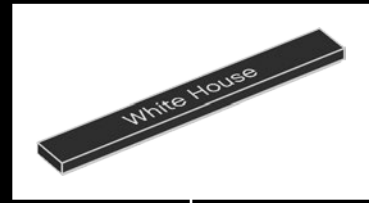
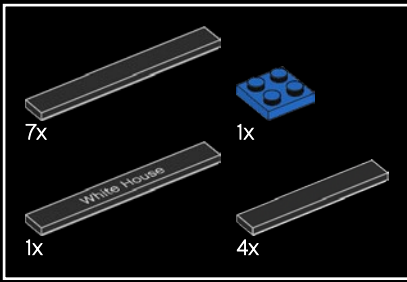

9

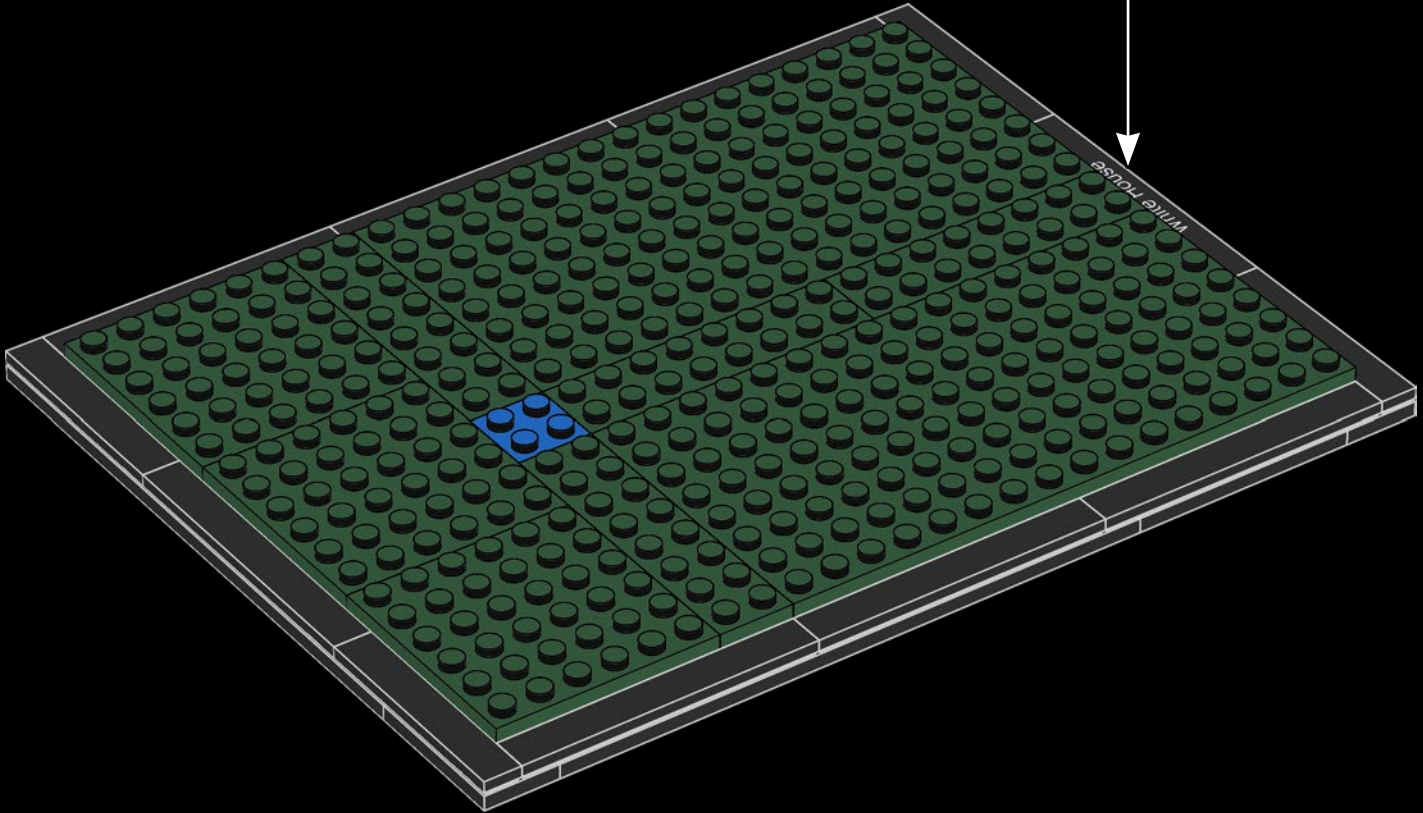

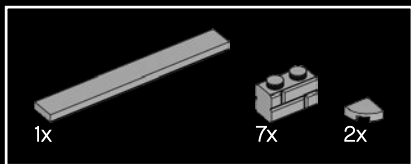

10

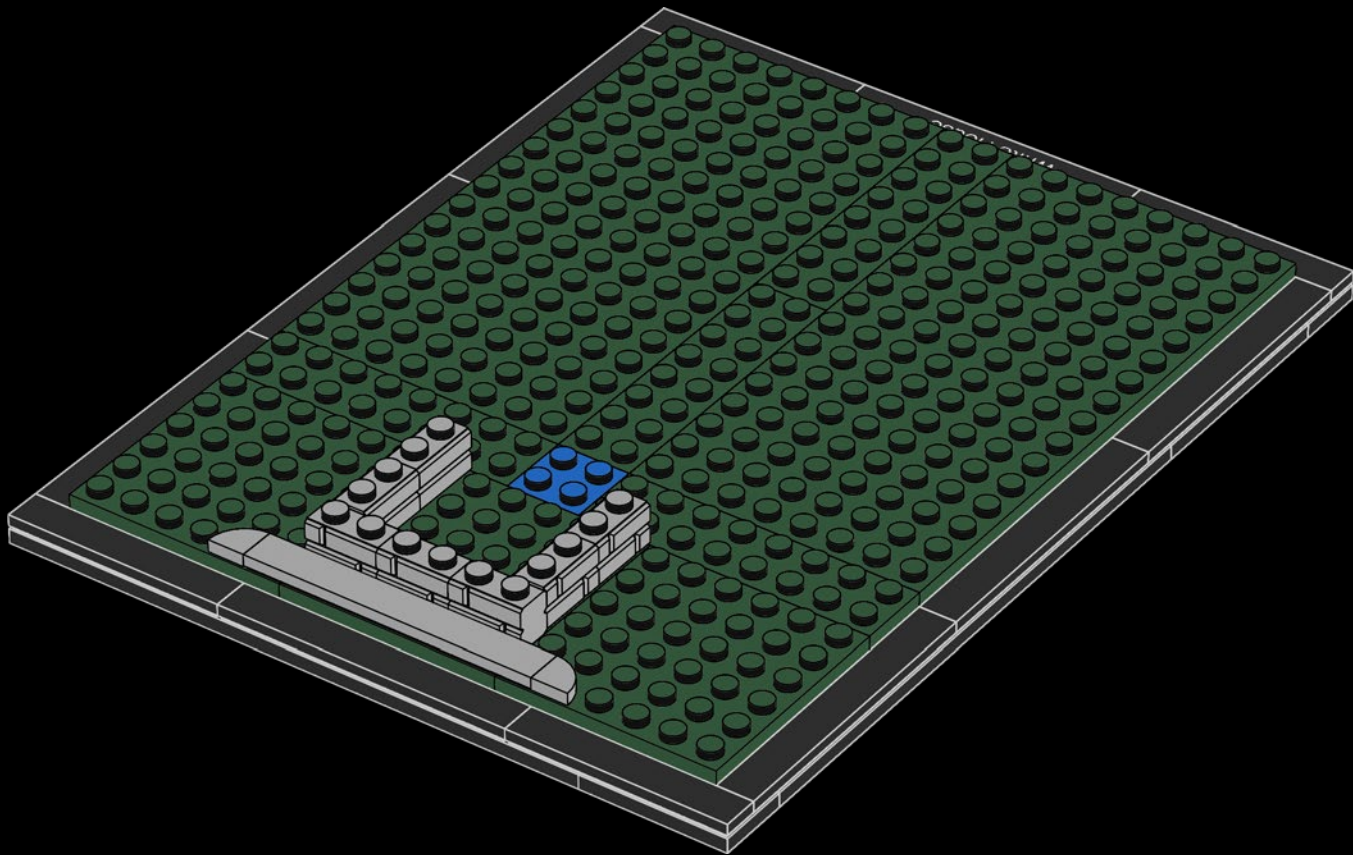

The White House sits at 1600 Pennsylvania Avenue in Washington D.C., the capital city of the United States

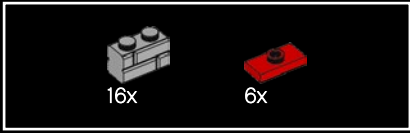

11

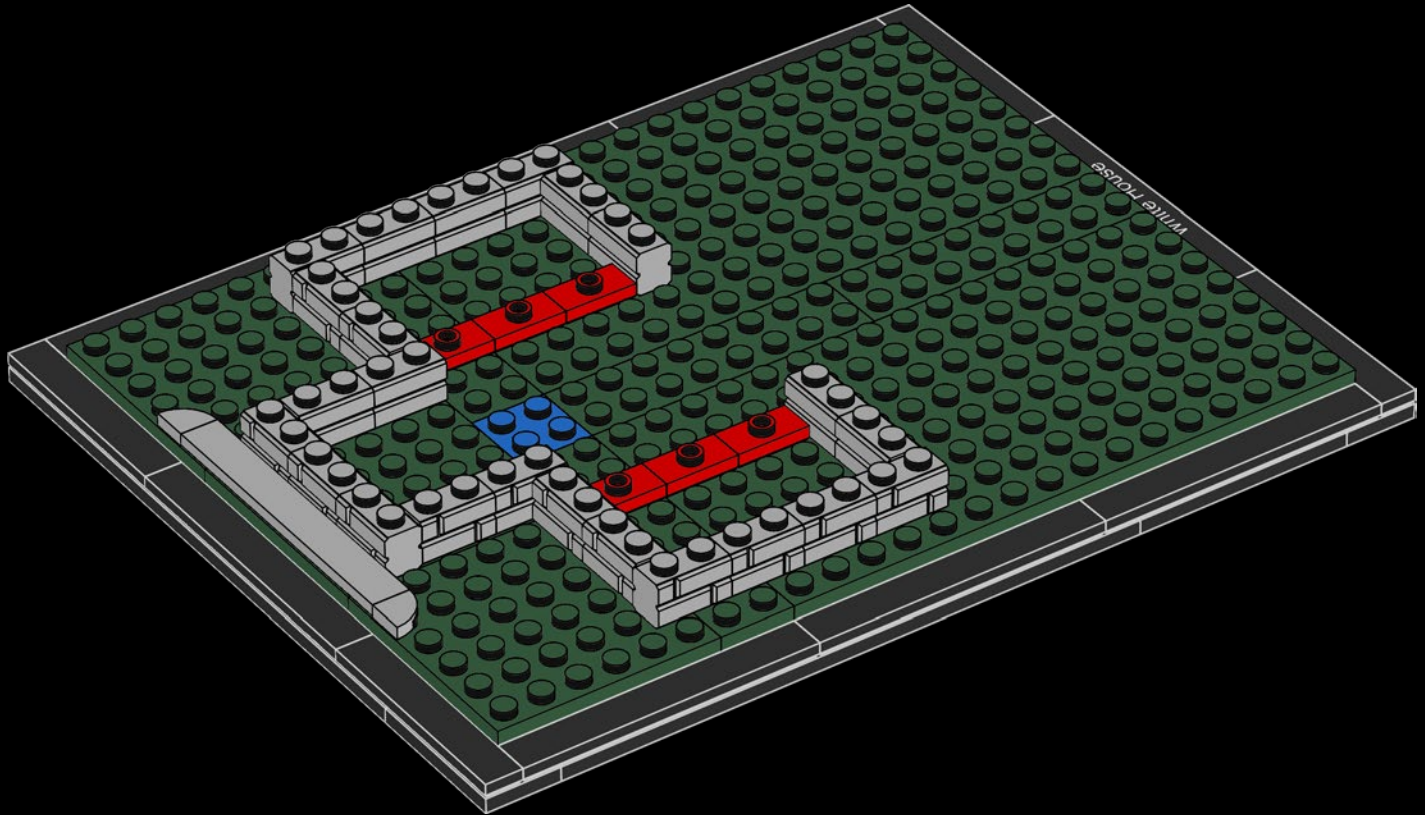

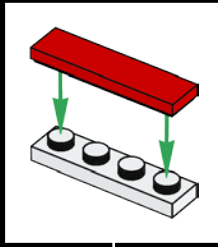
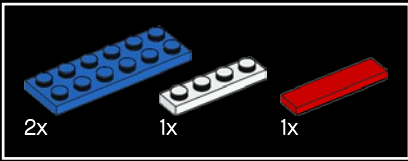

12

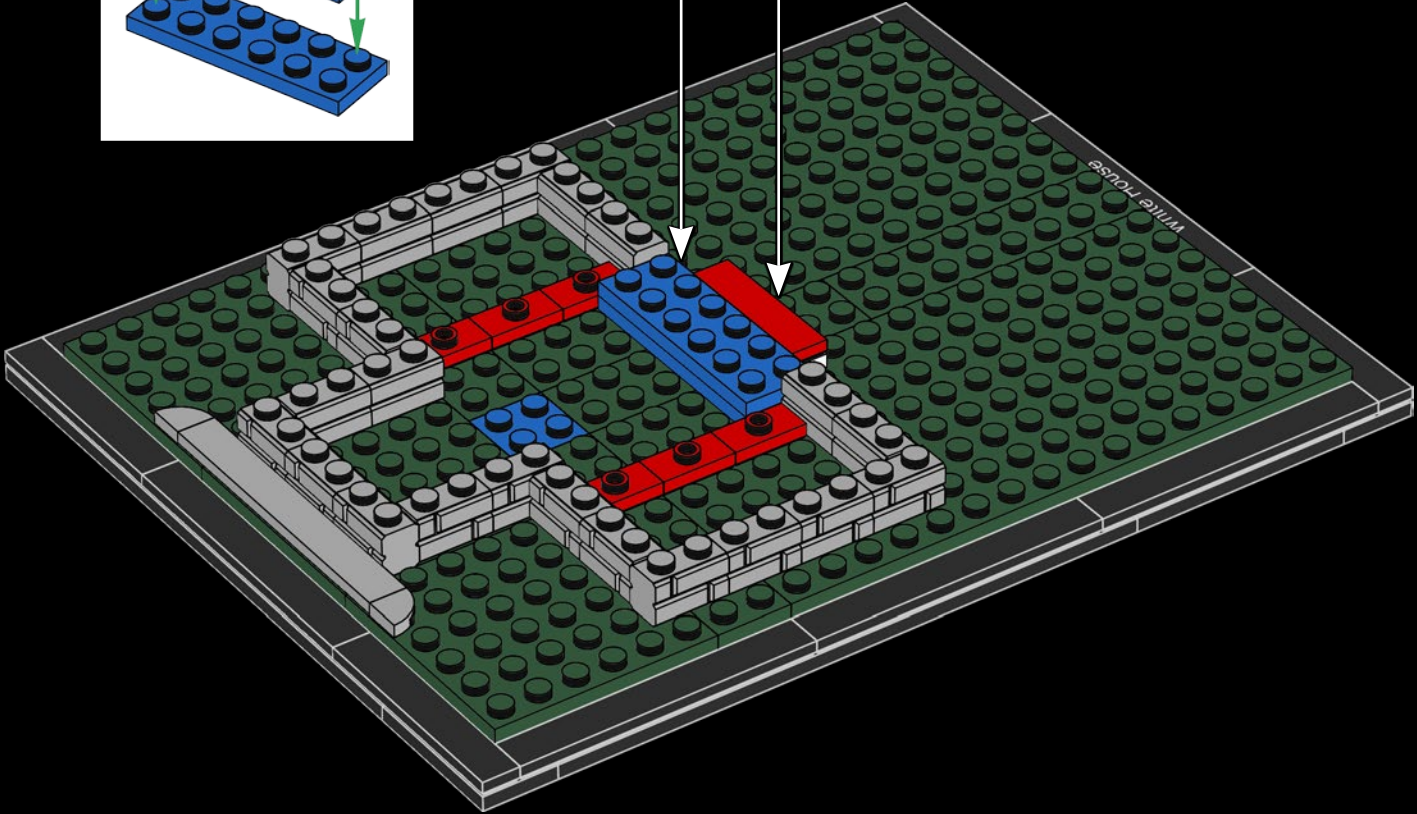
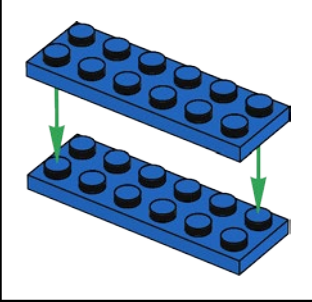

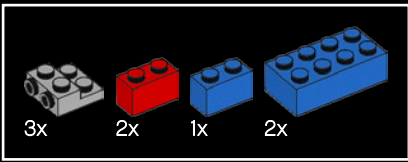

13

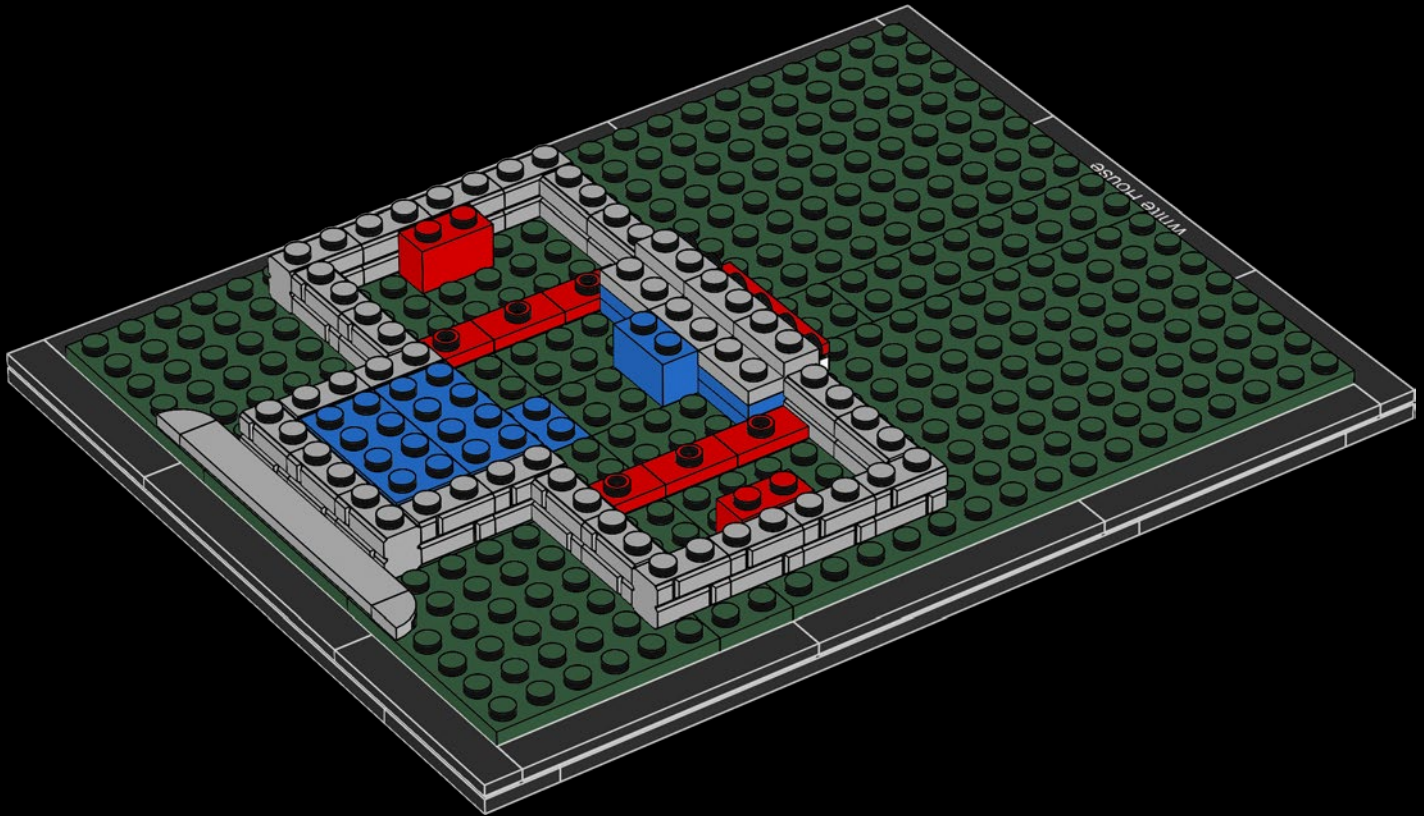

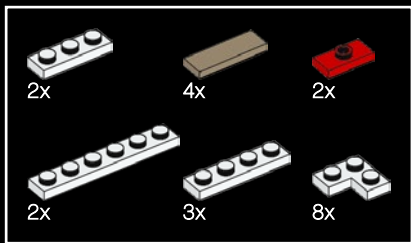

14

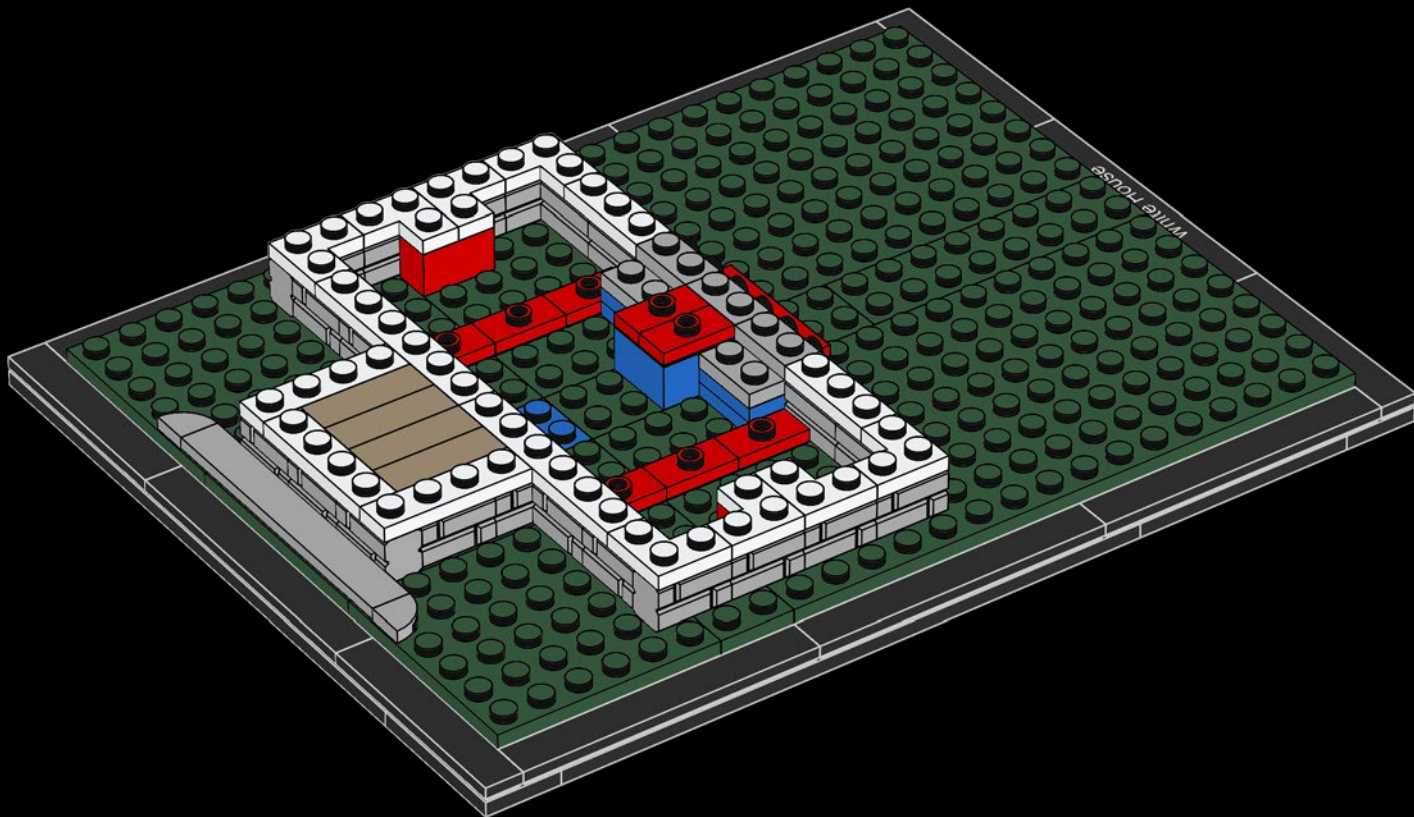

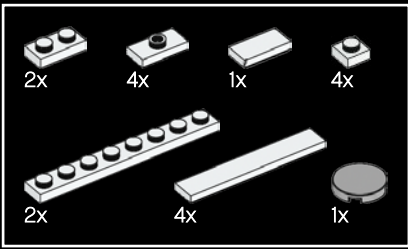

15

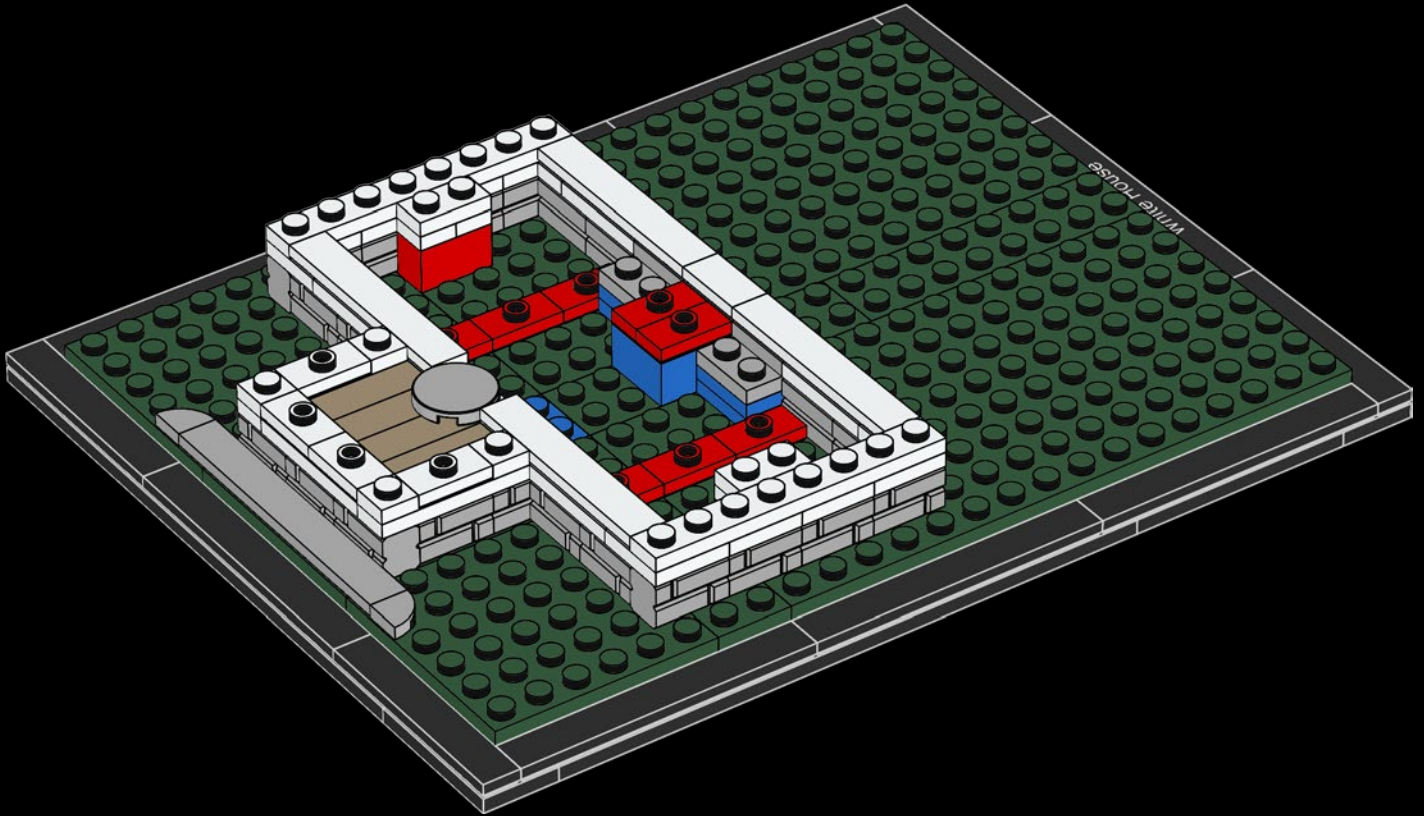

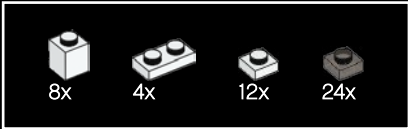
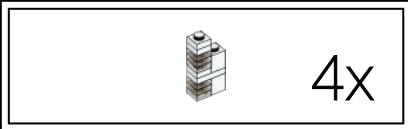

16

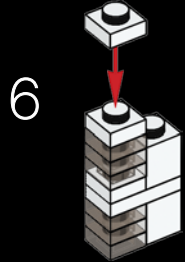
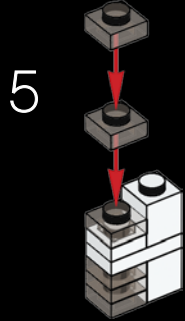
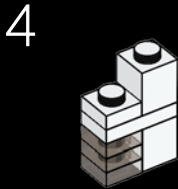
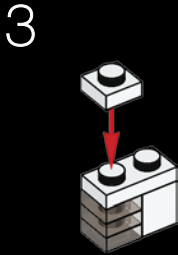
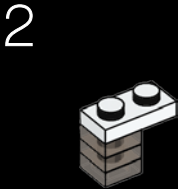
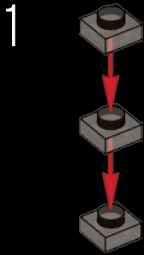

4x

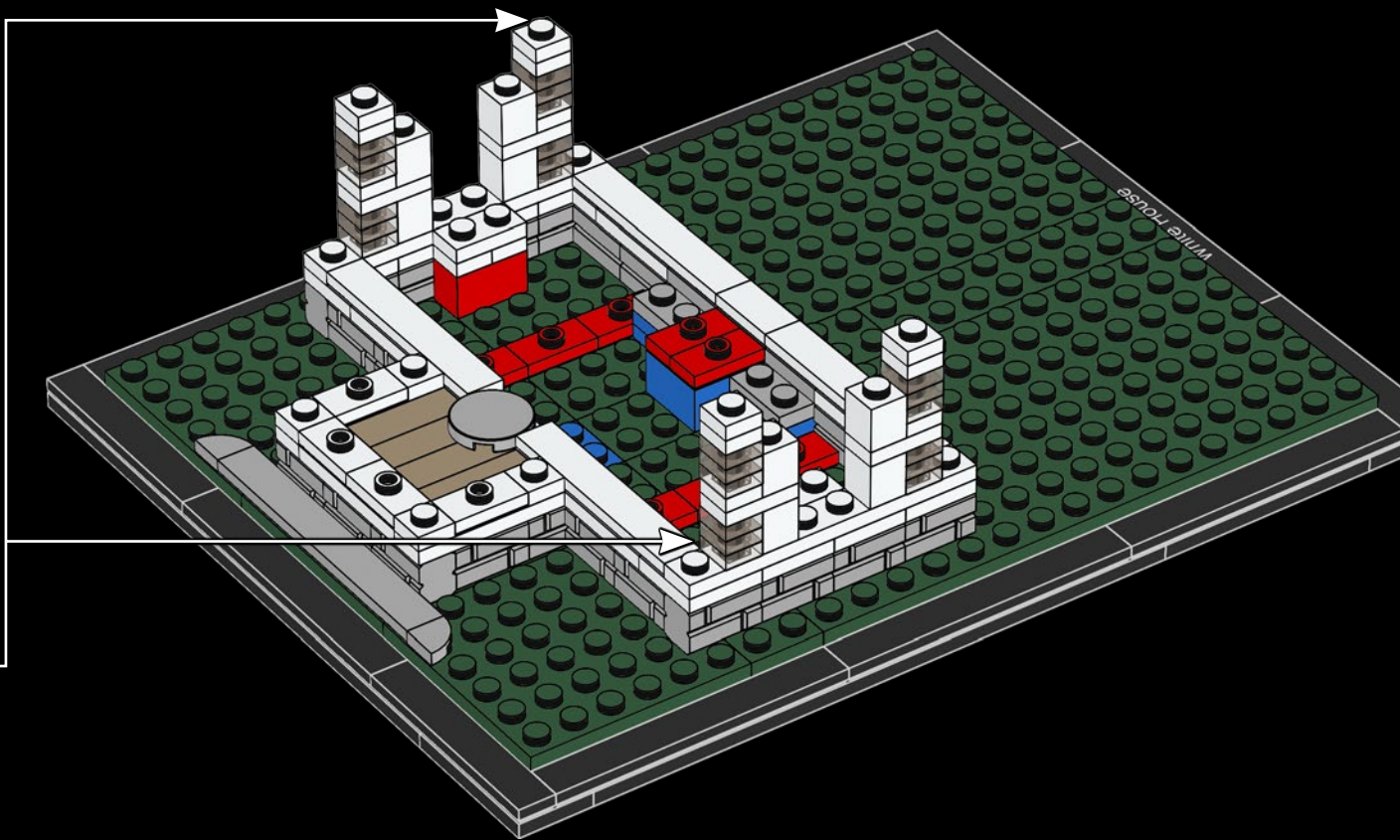

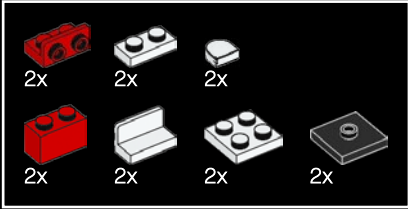

17

1



2



3

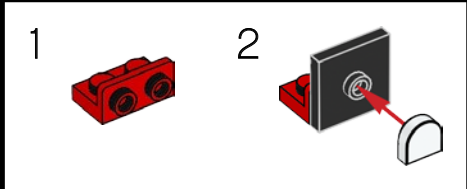
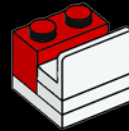

4



2x

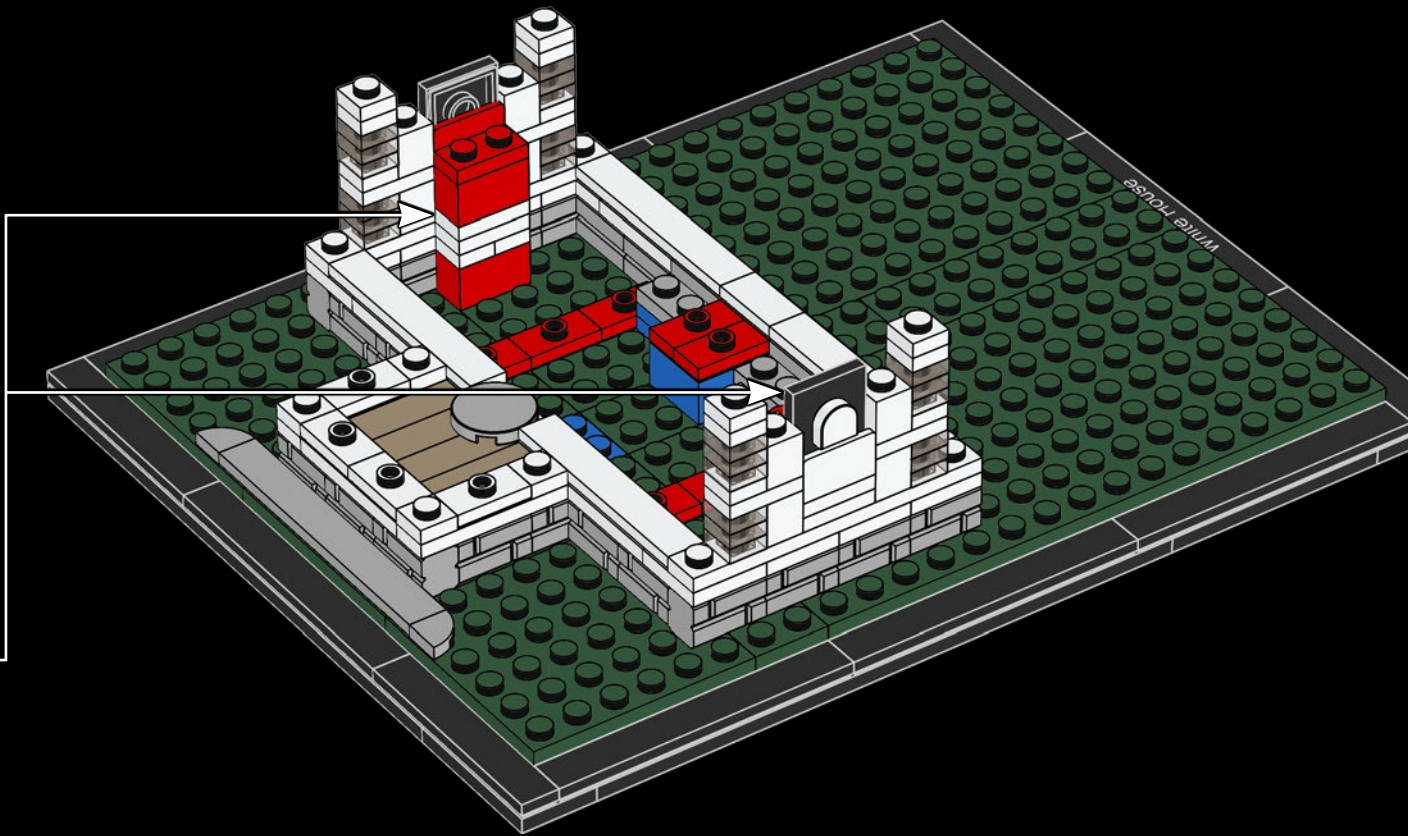

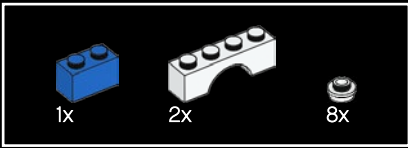

18

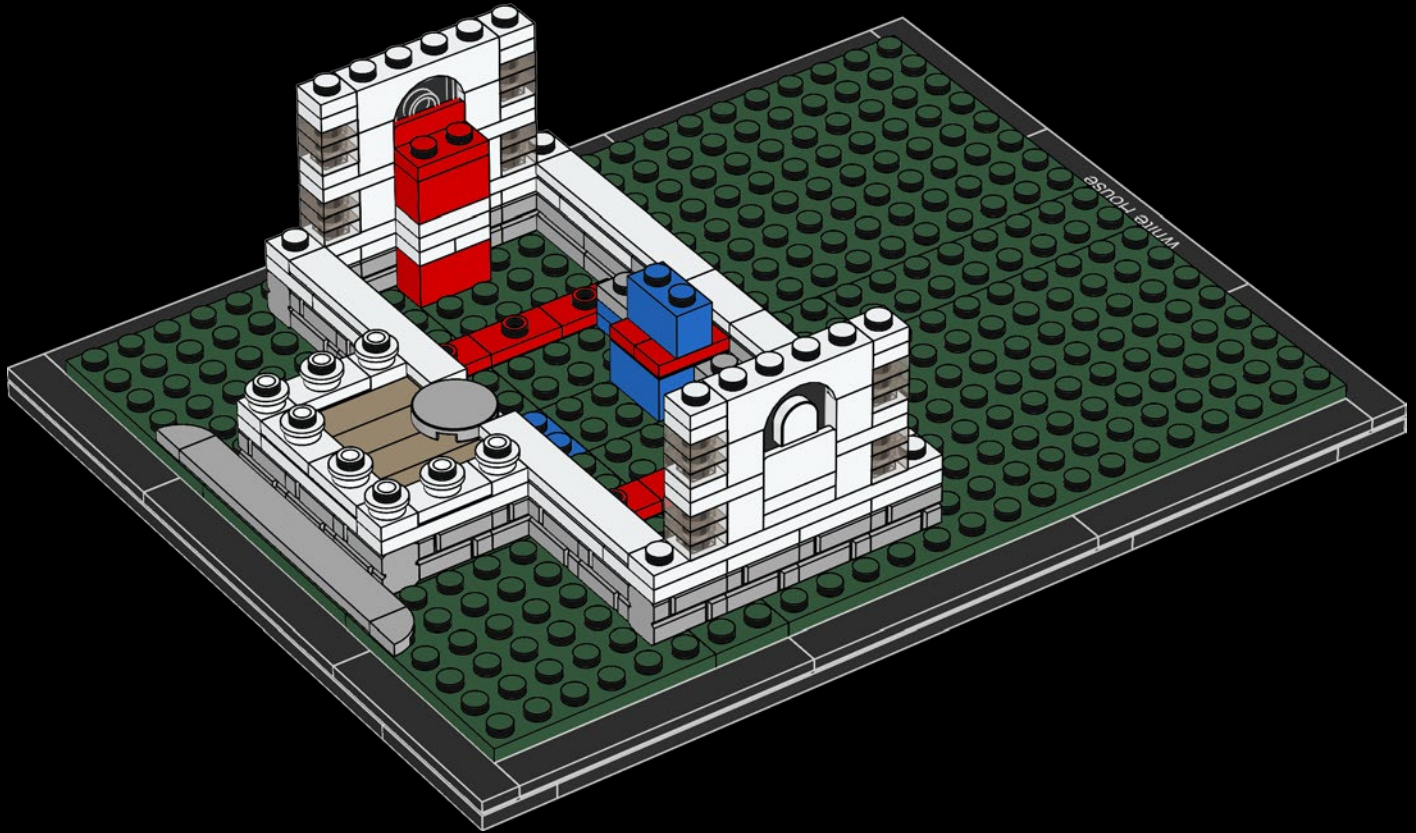

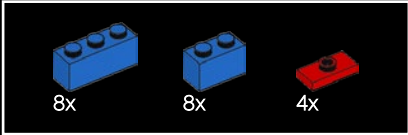
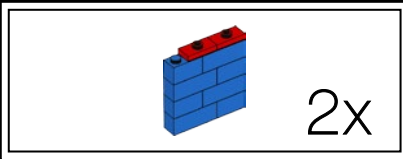

19

1

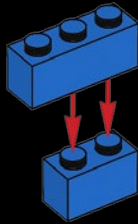

2

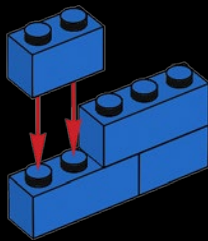

3

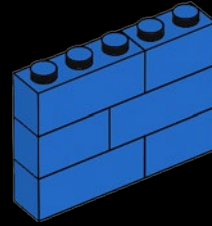

4

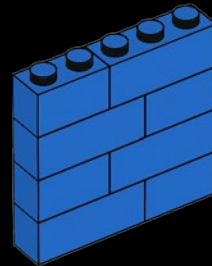

5

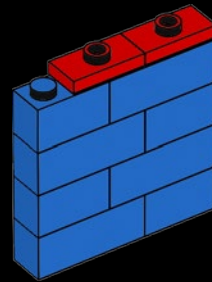

2x

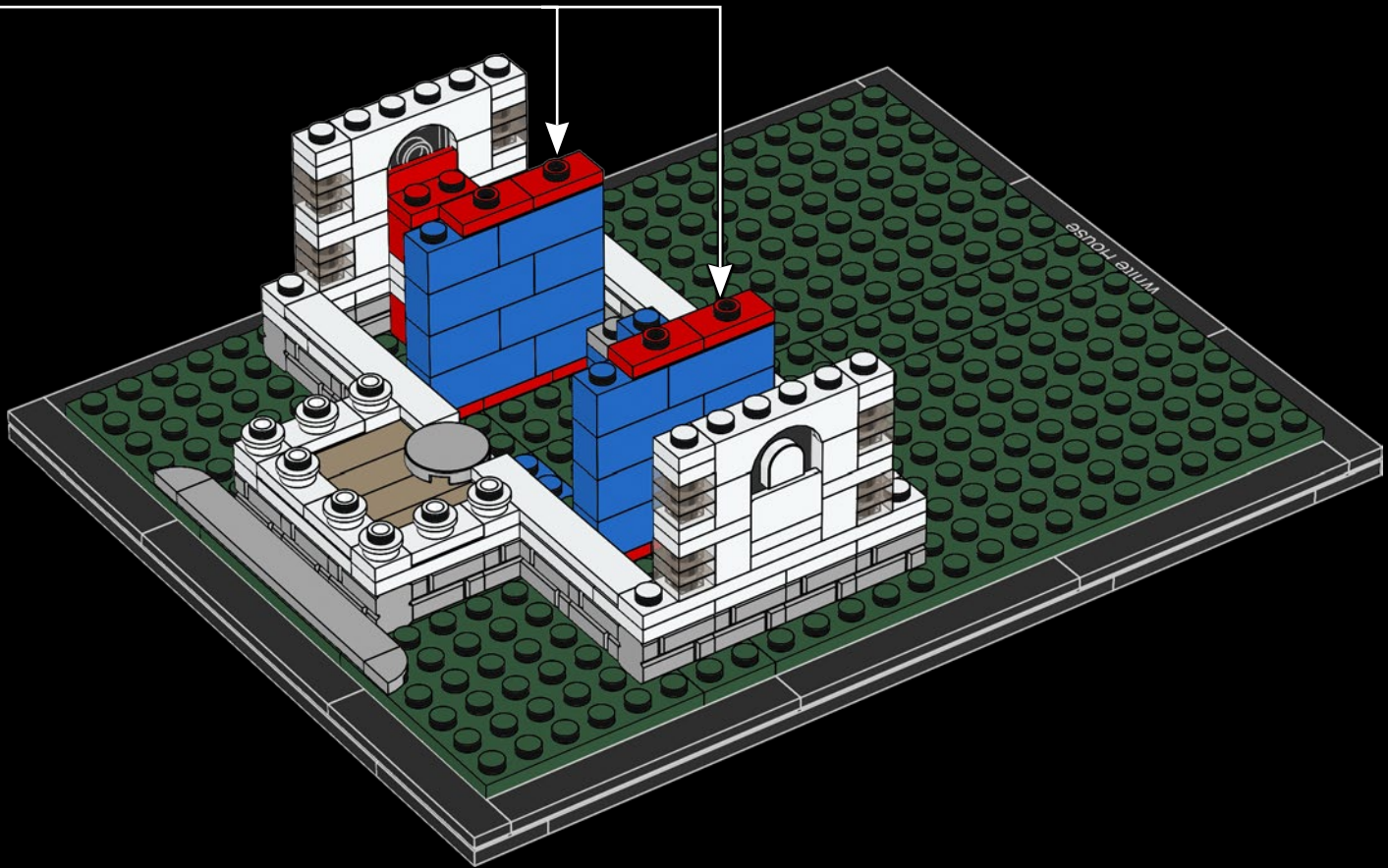

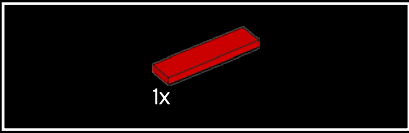
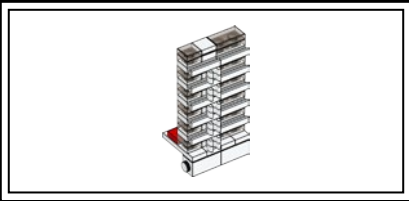

20

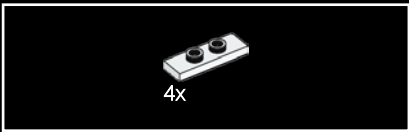

21



22

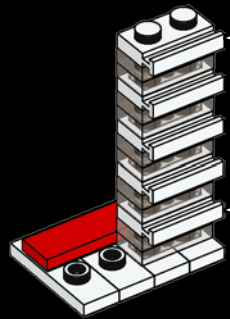
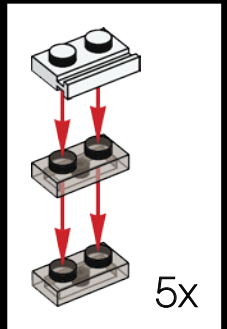



23

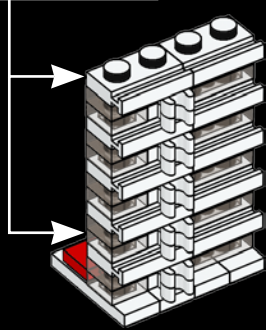
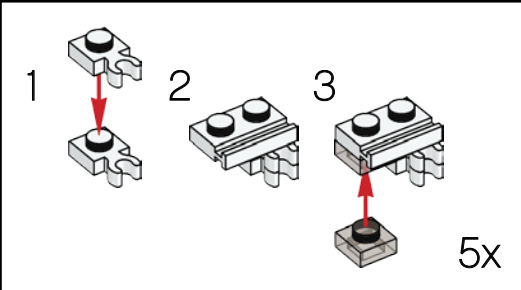

24

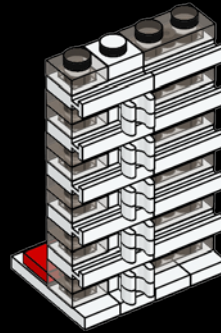



25

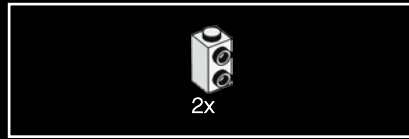
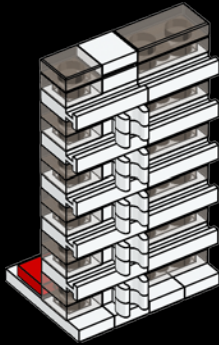

26

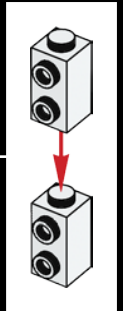
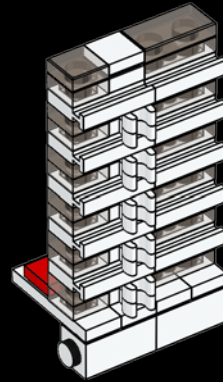

27

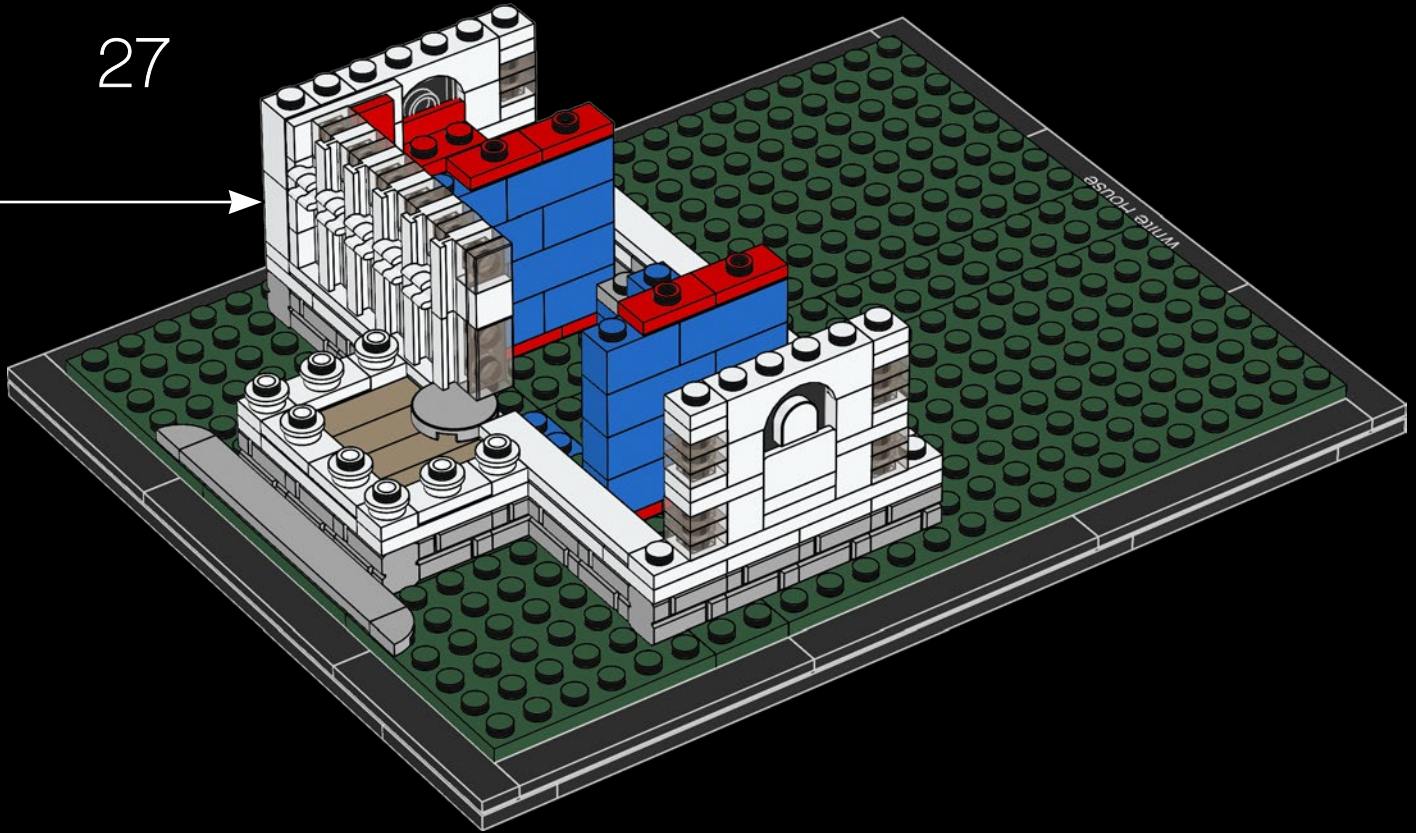

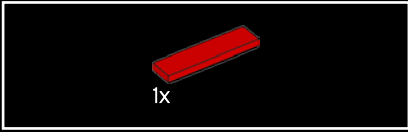
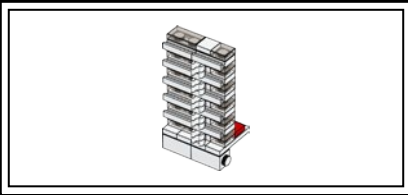

28

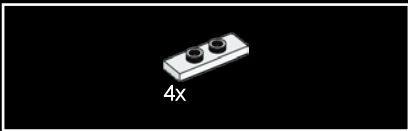

29

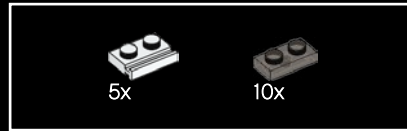

30

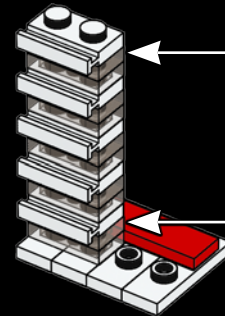
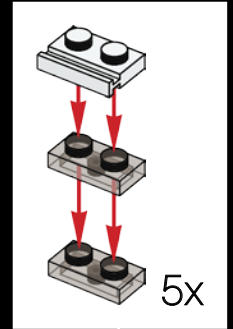



31

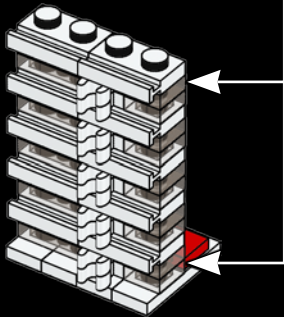
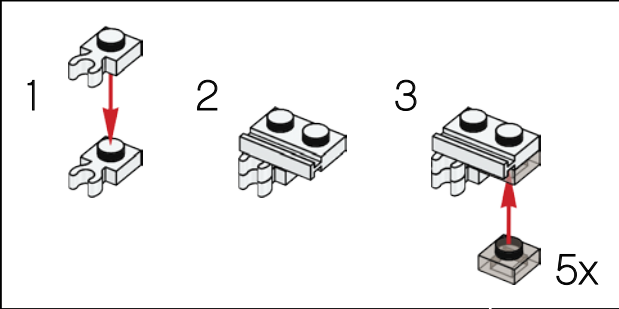

32

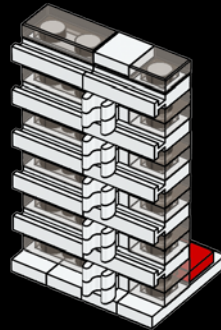

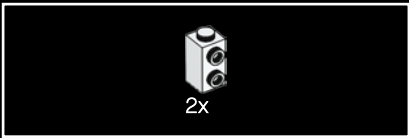

33

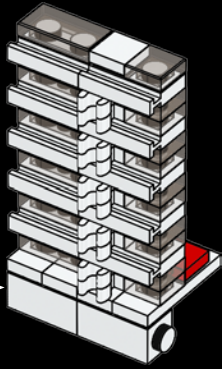
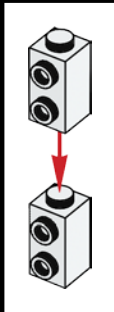

34

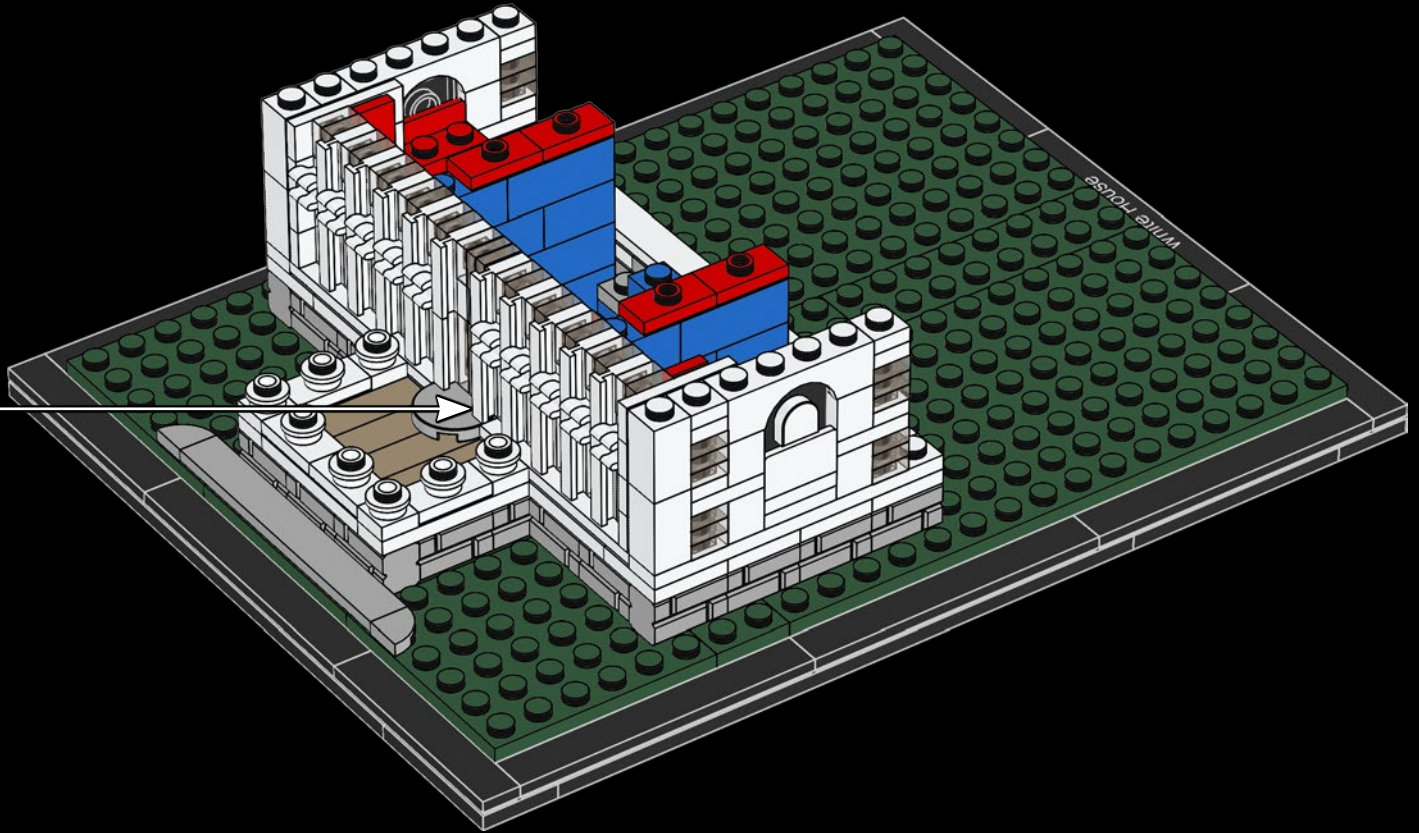

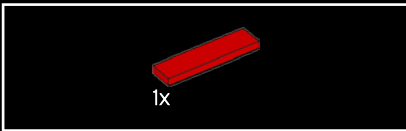
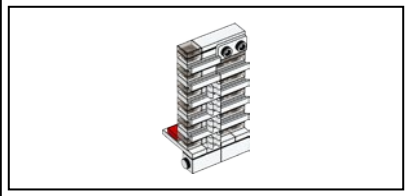
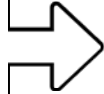

35

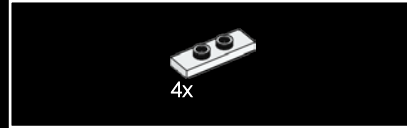

36





37

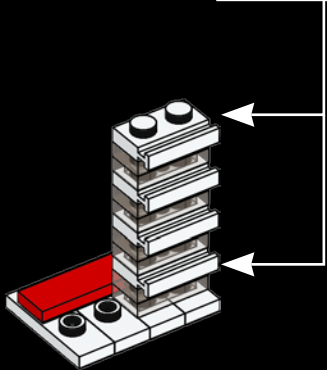
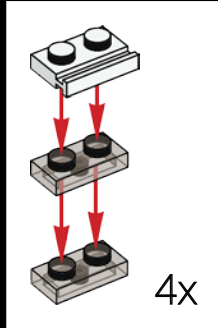

38

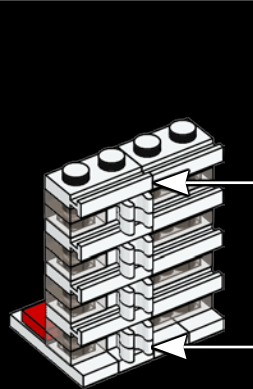
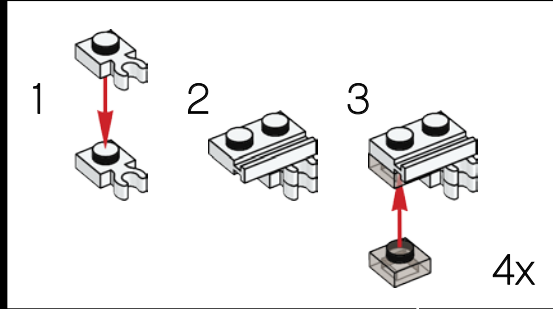



39

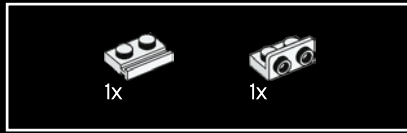
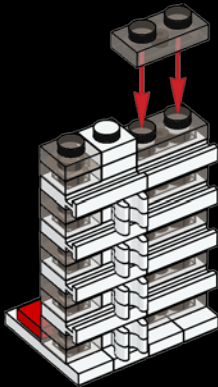

40

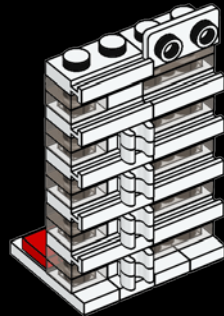

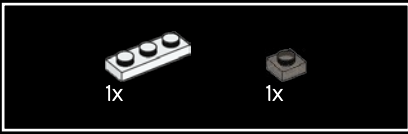

41

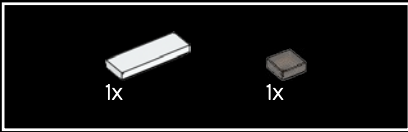
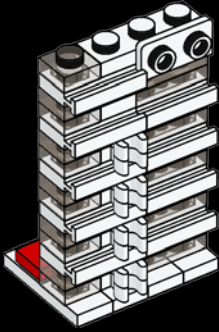

42

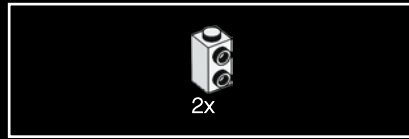
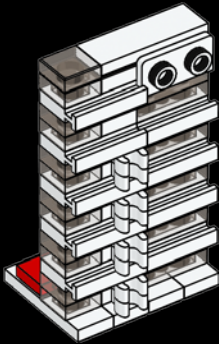

43

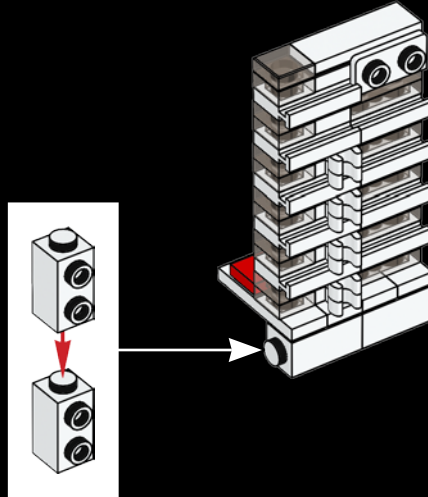

44

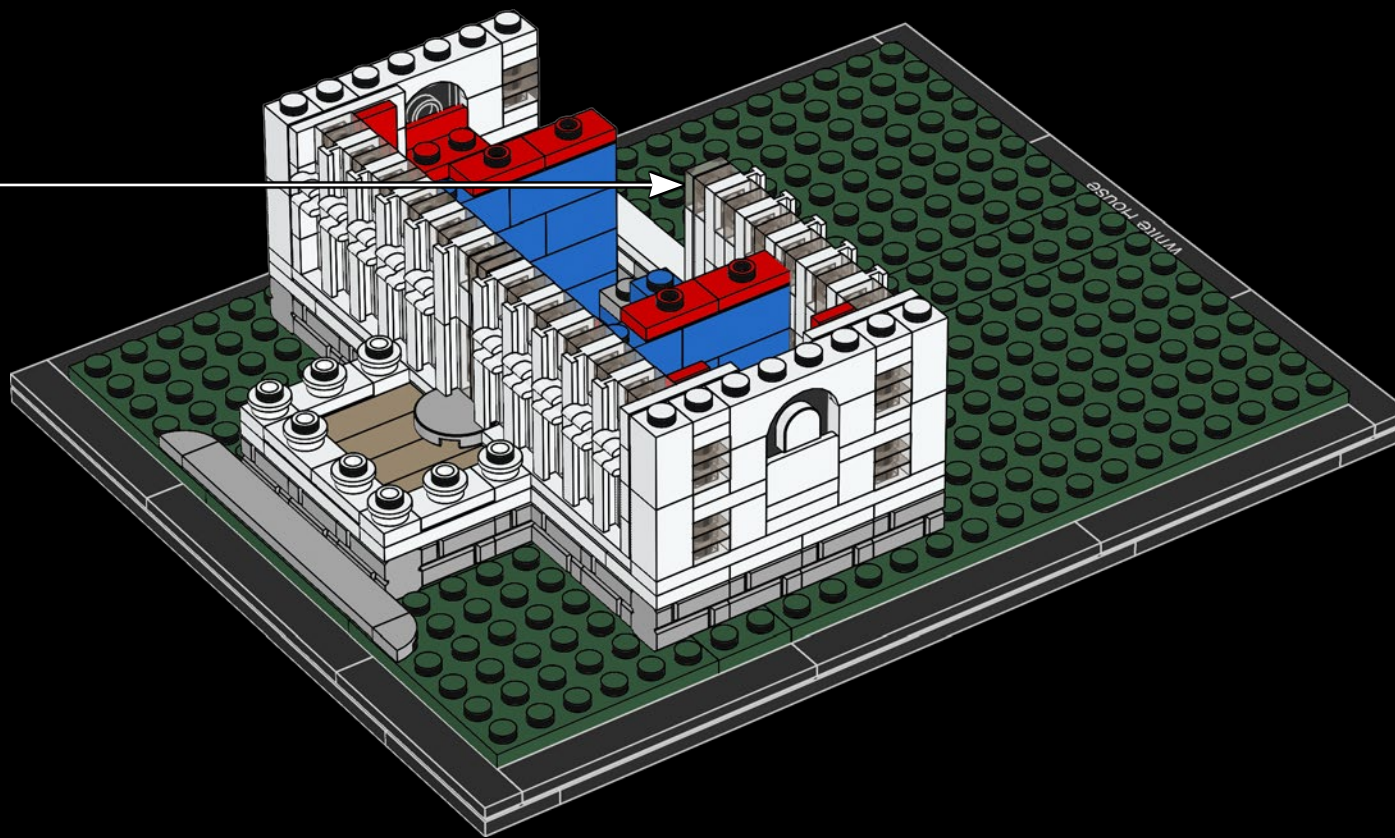

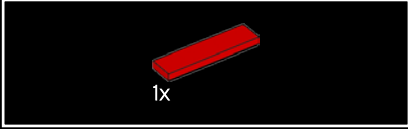
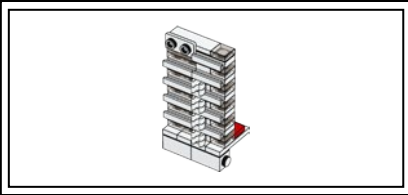

1x

45

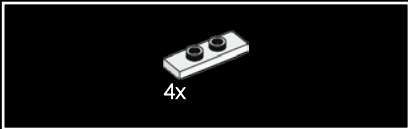

4x

46



48



4x

8x

47

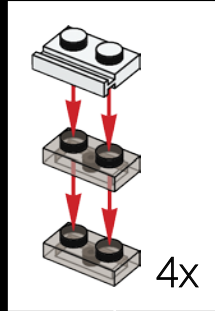

4x

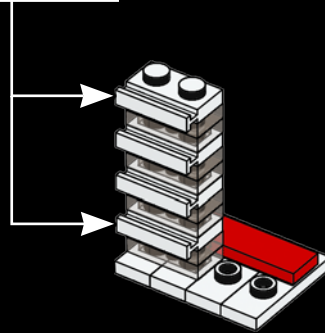



48

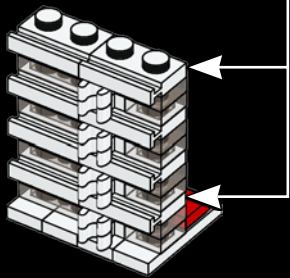
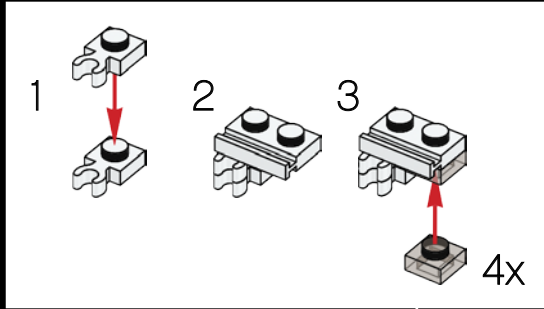

49

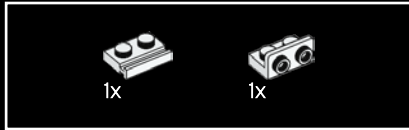
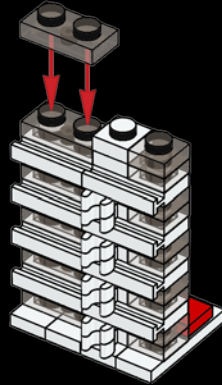

50

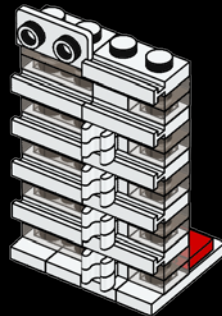

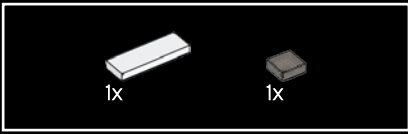

51

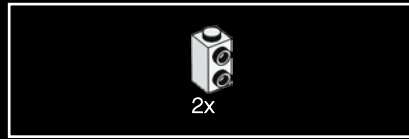
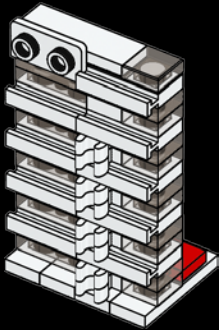

52

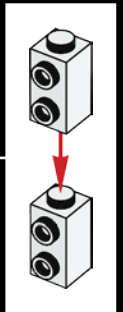
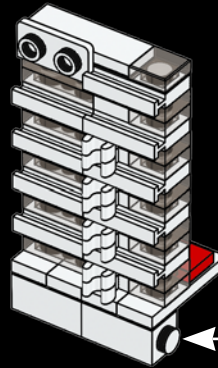

53

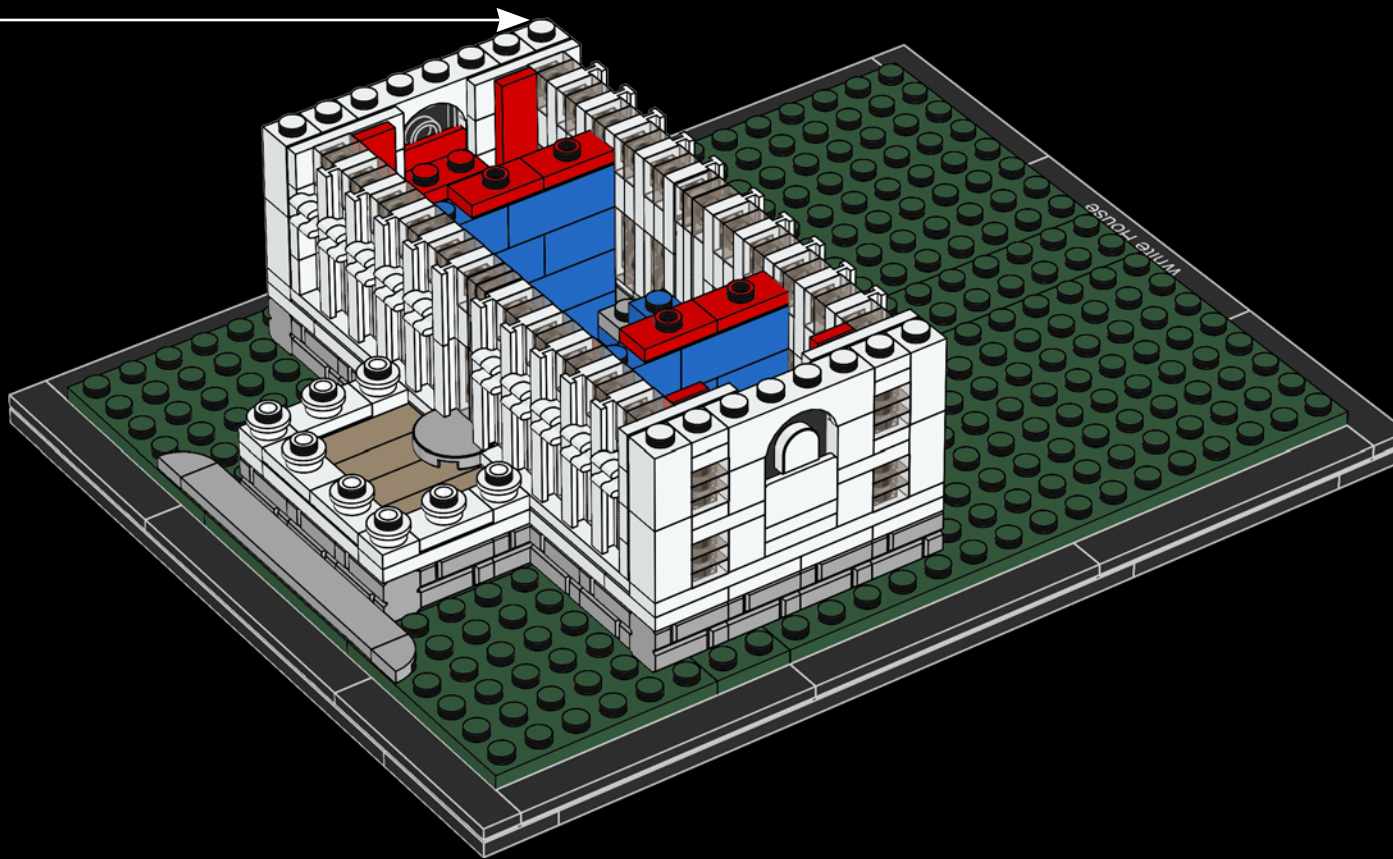

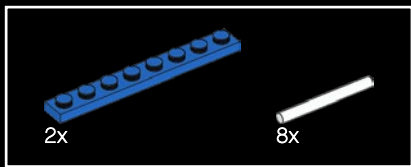

54

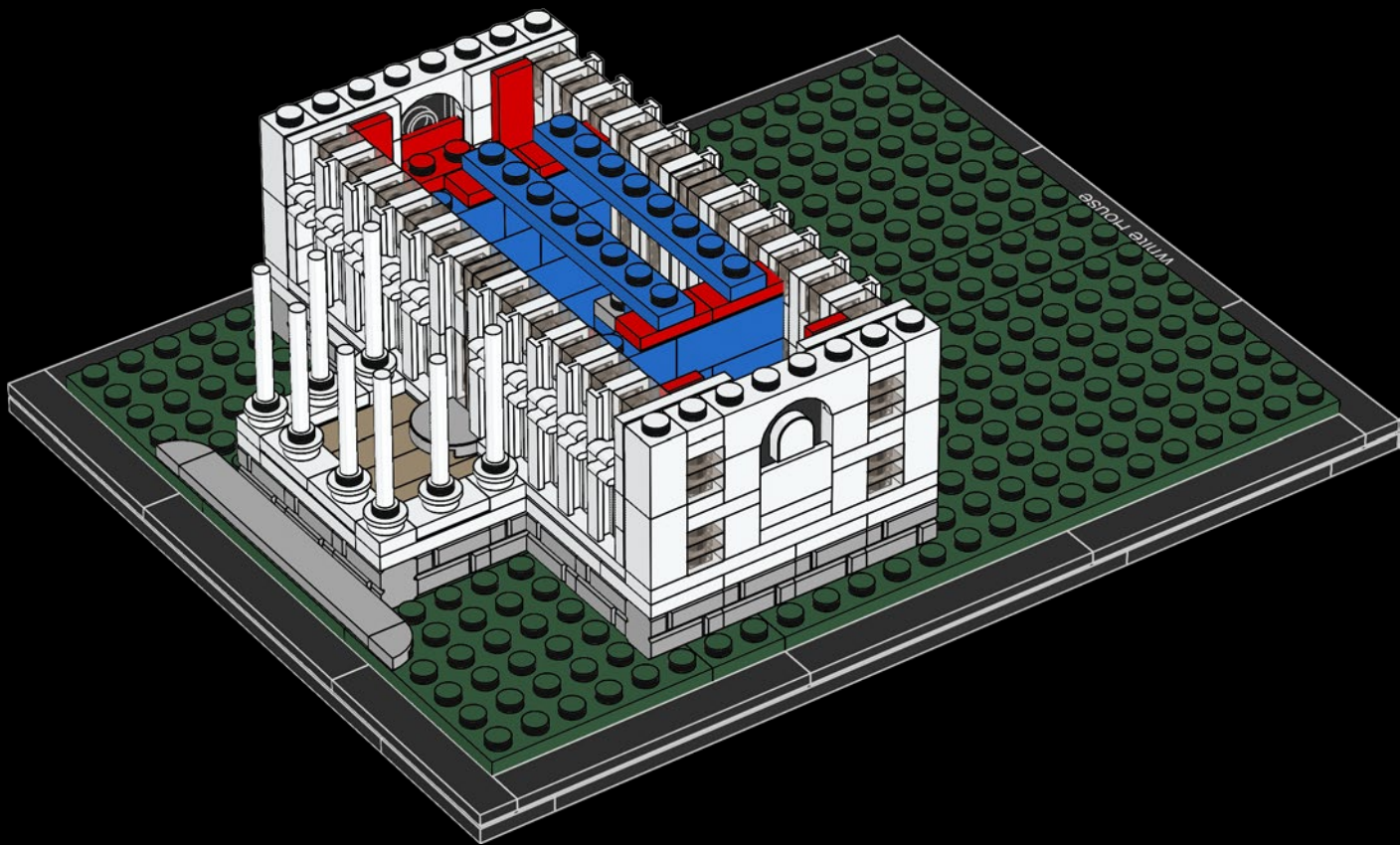

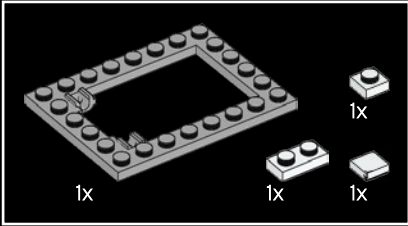
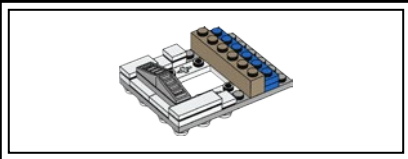

55

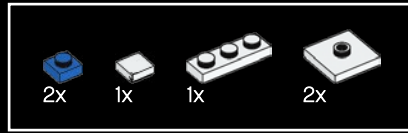
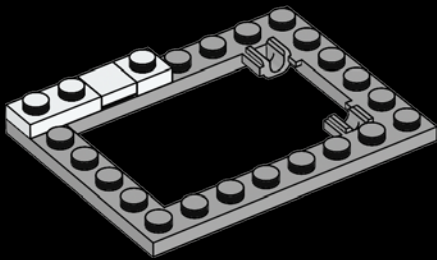

56

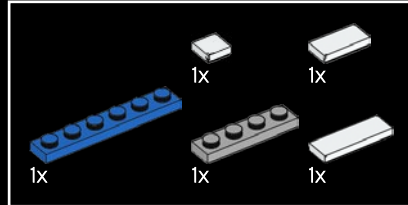
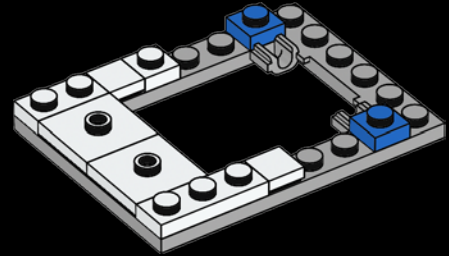

57

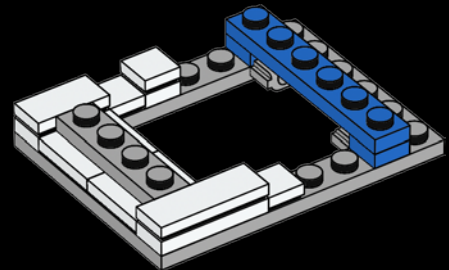

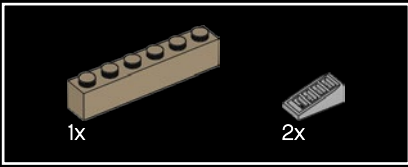

58

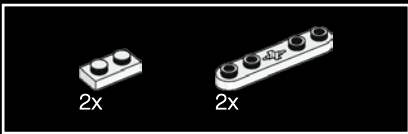
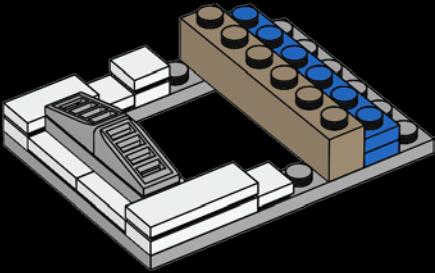

59

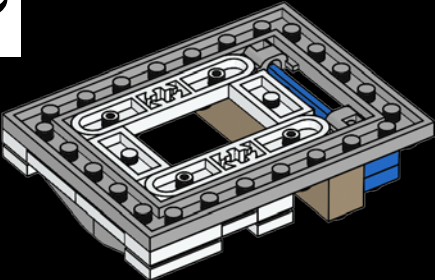
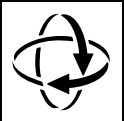

54



60

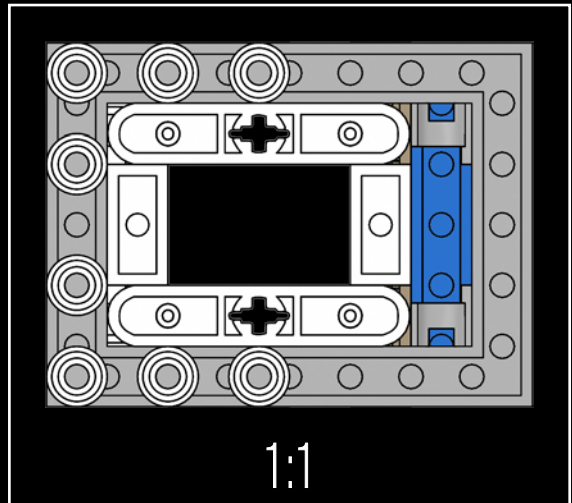
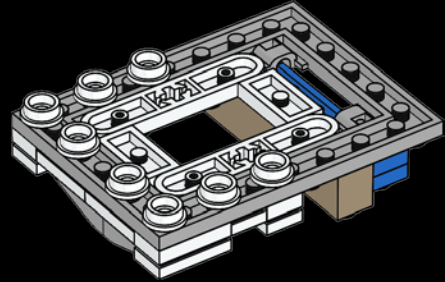

61

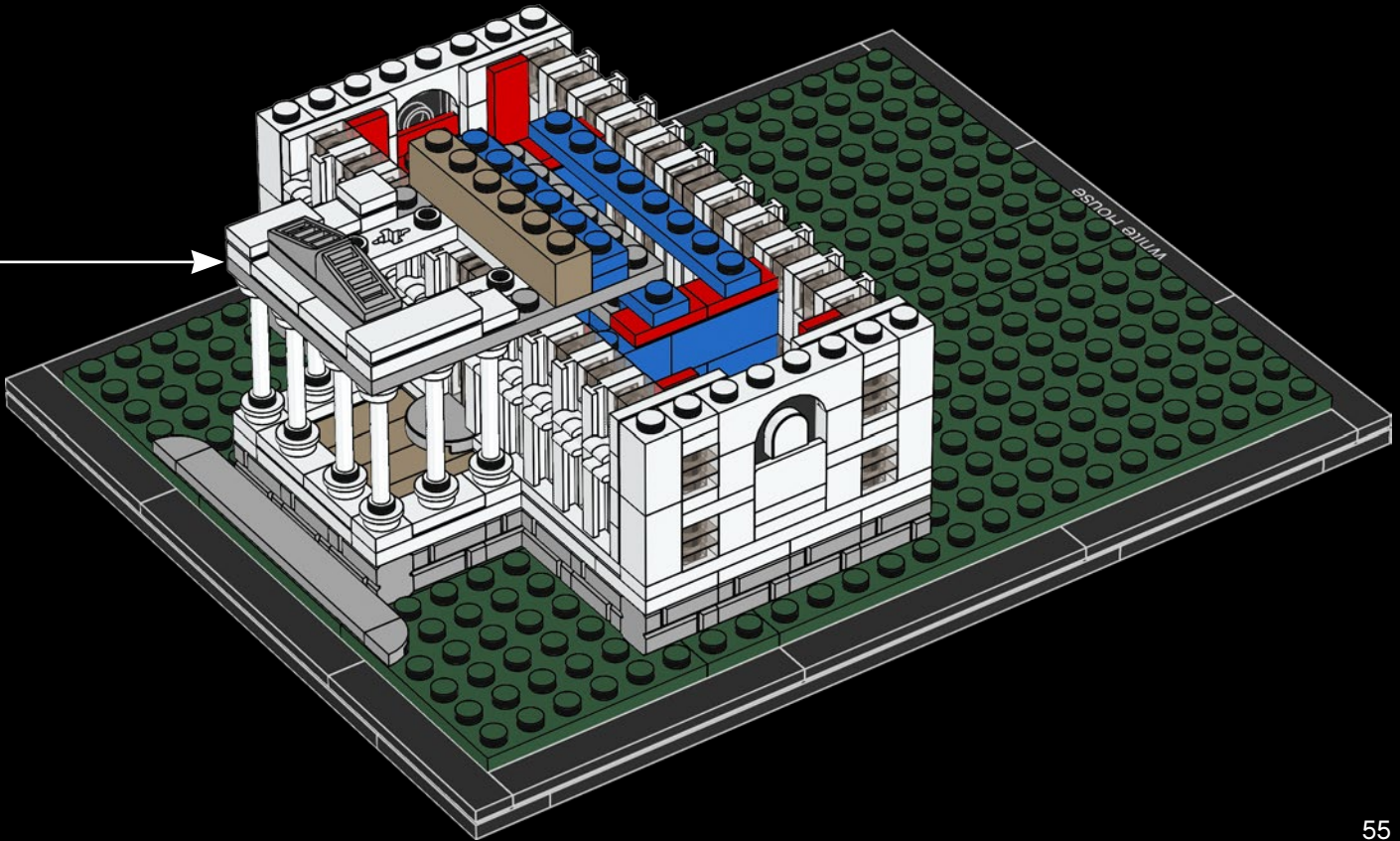

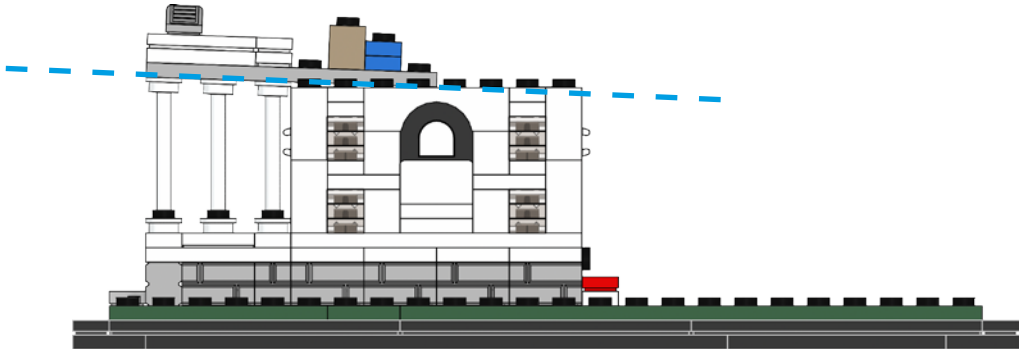
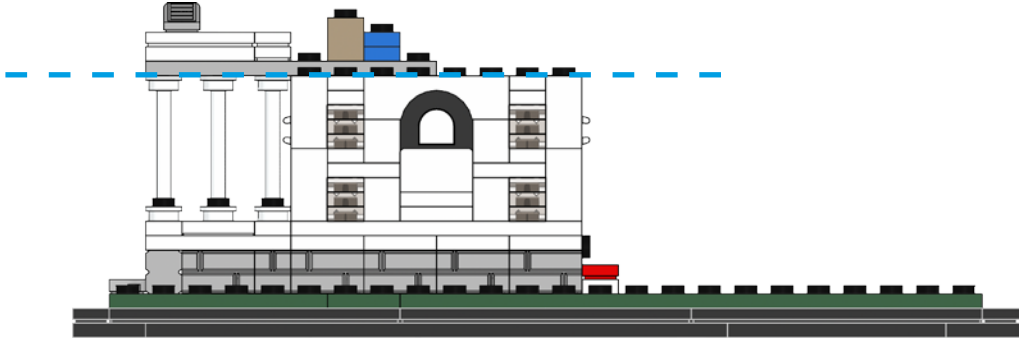

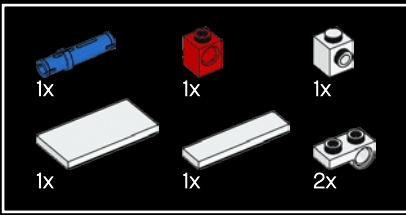

62

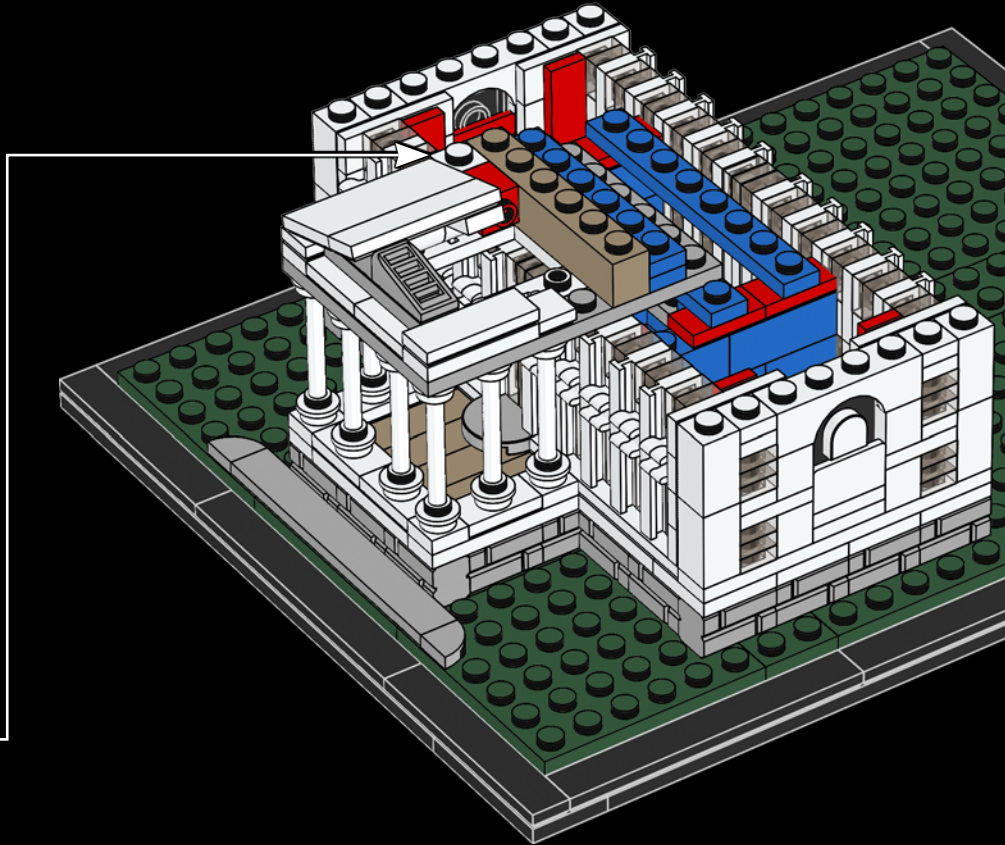
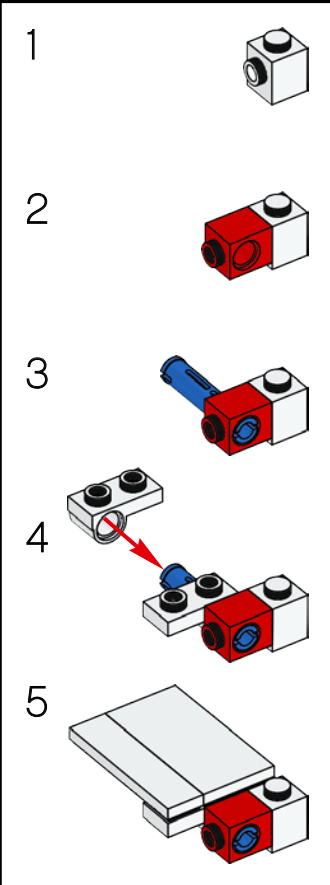

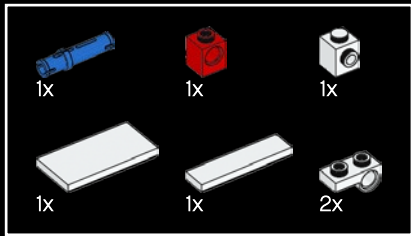

63

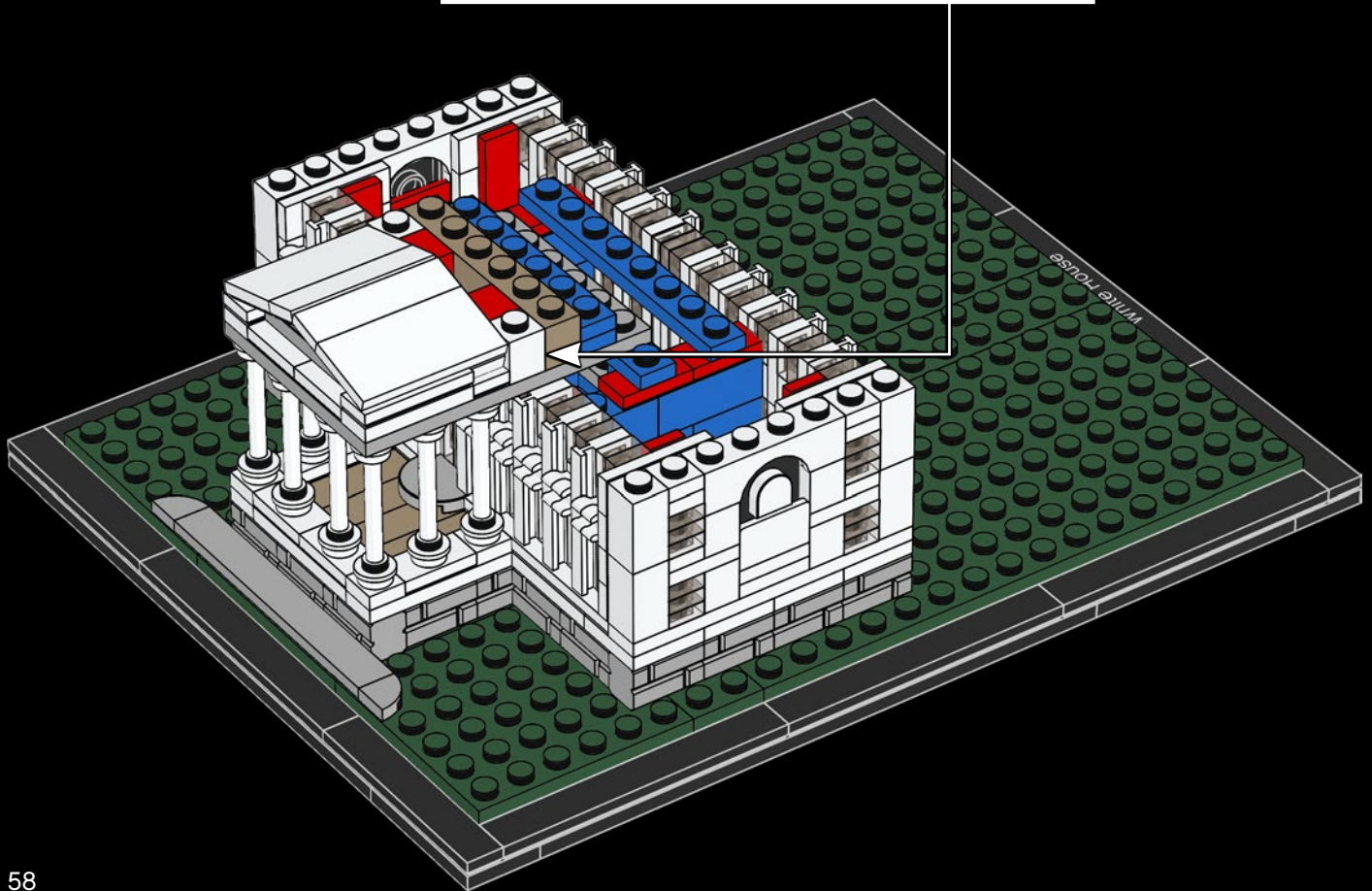
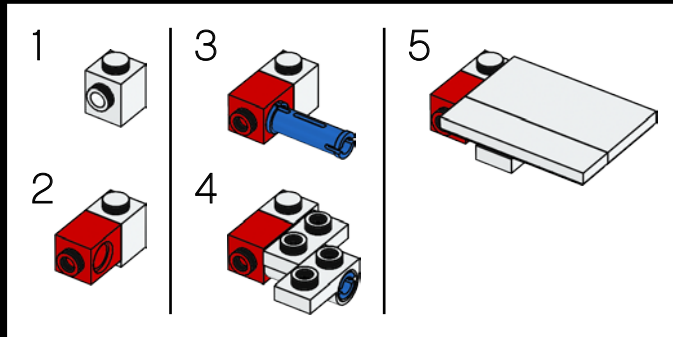

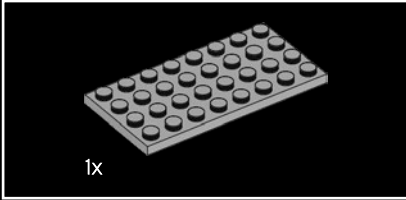
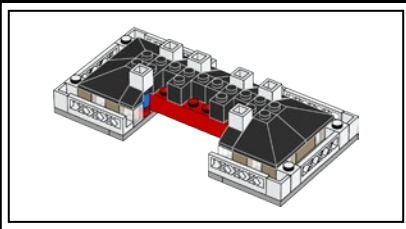

64

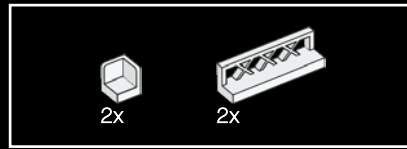
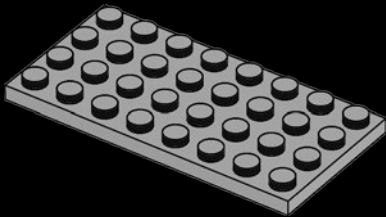

65

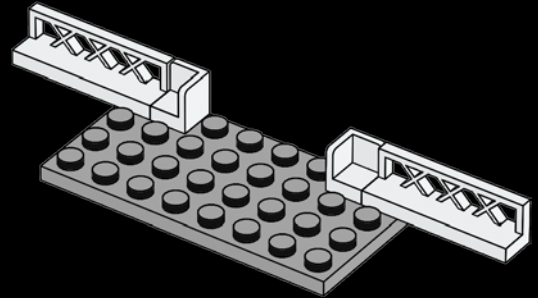

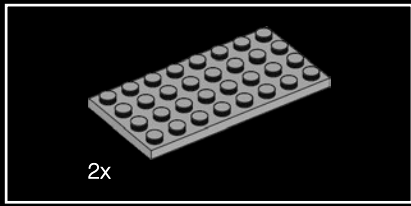

66

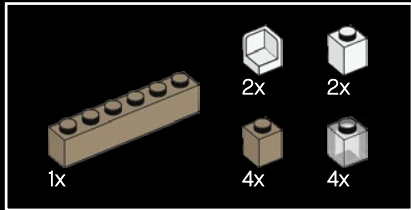
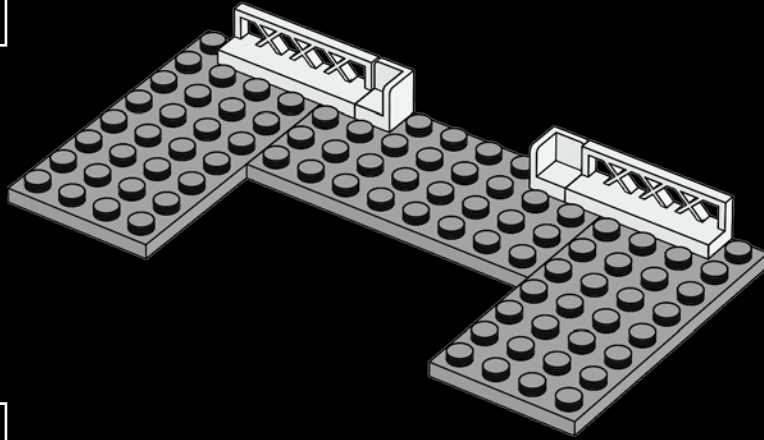

67

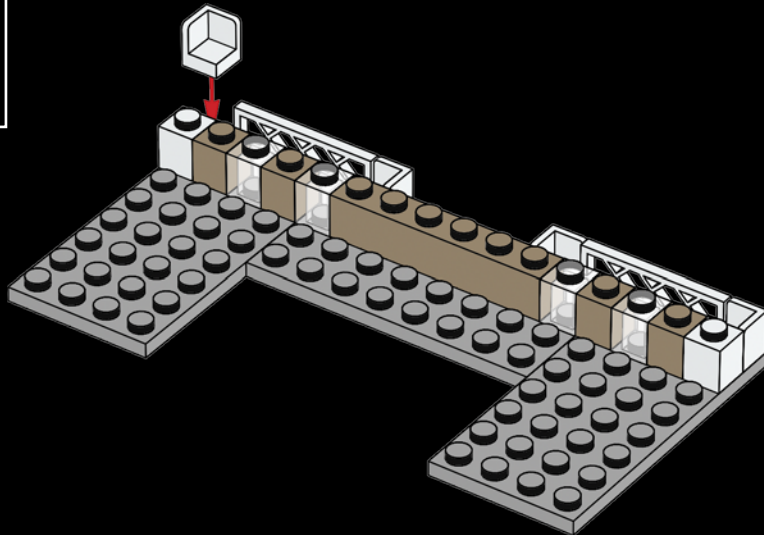

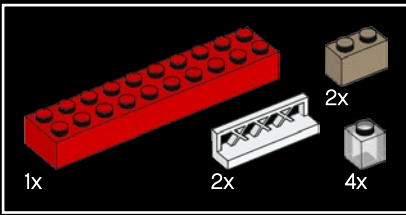

68

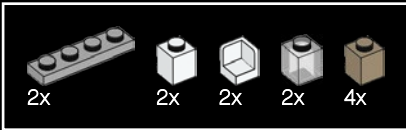
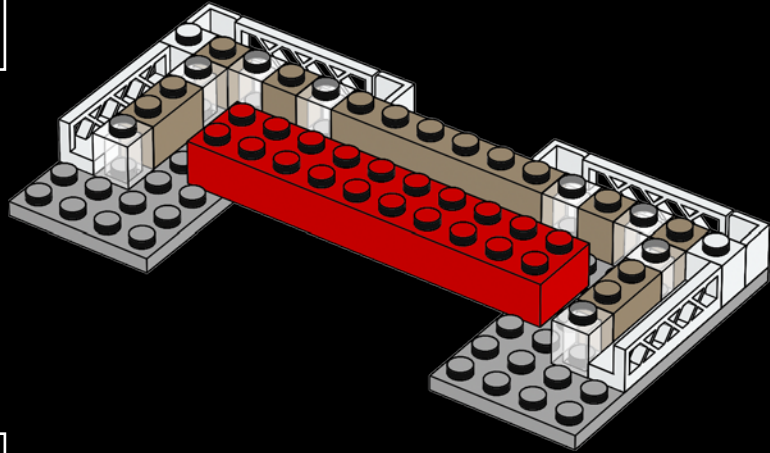

69

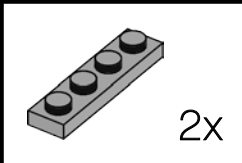
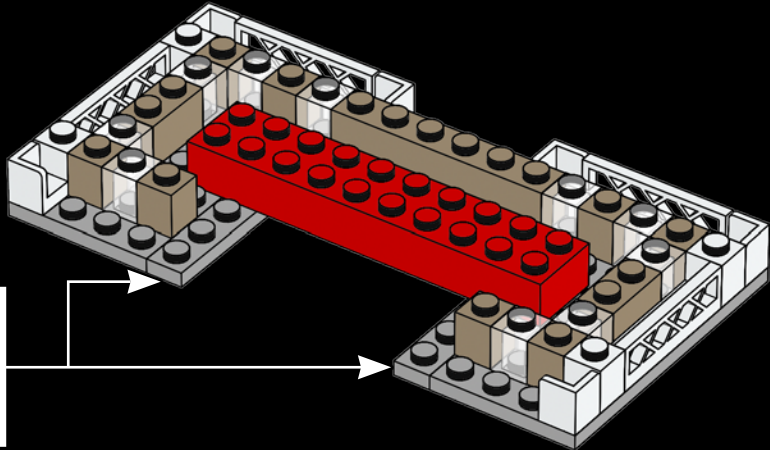

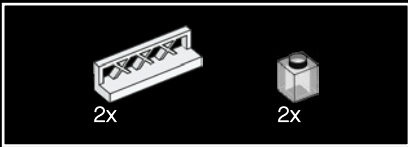

70

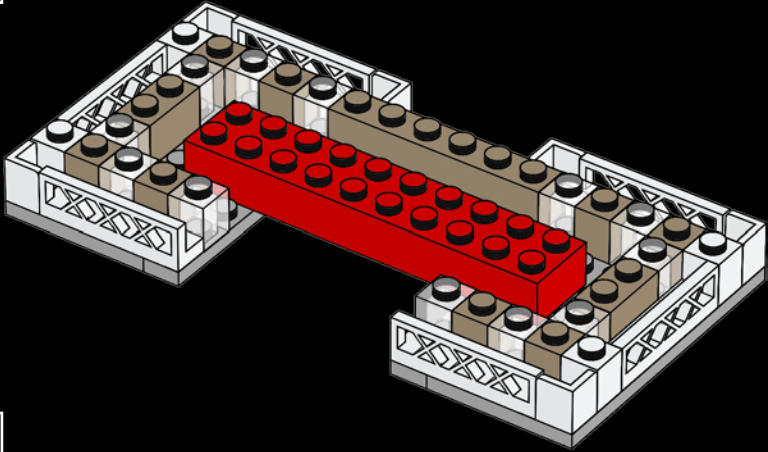

71

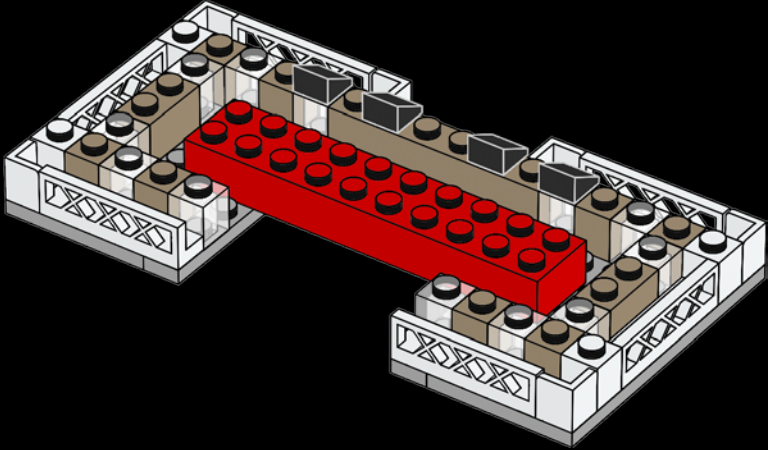

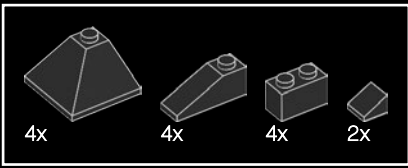

72

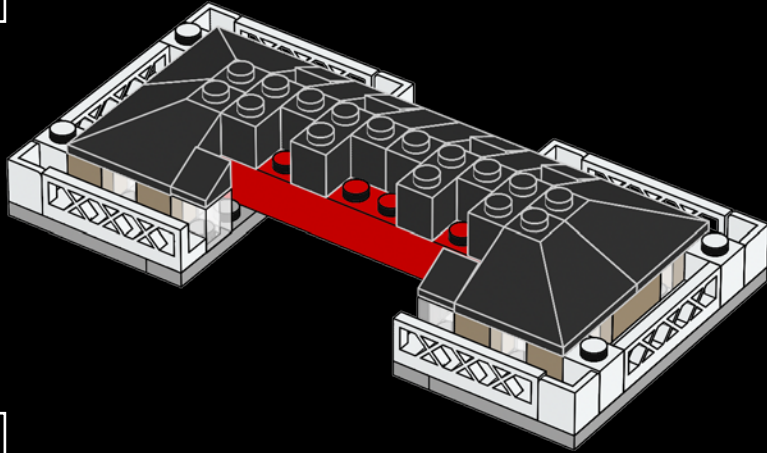

73

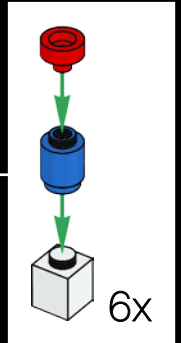
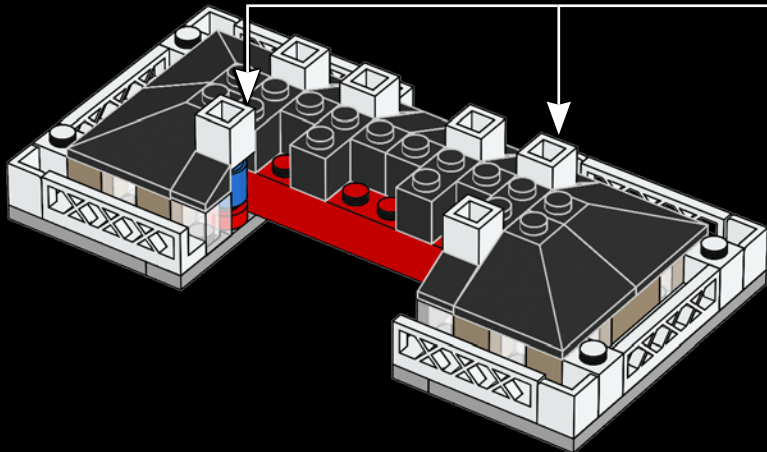

The White House has 6 floors - 2 basements,
2 public floors and 2 floors for the First Family

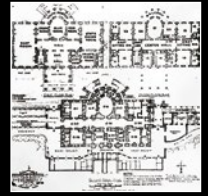

74

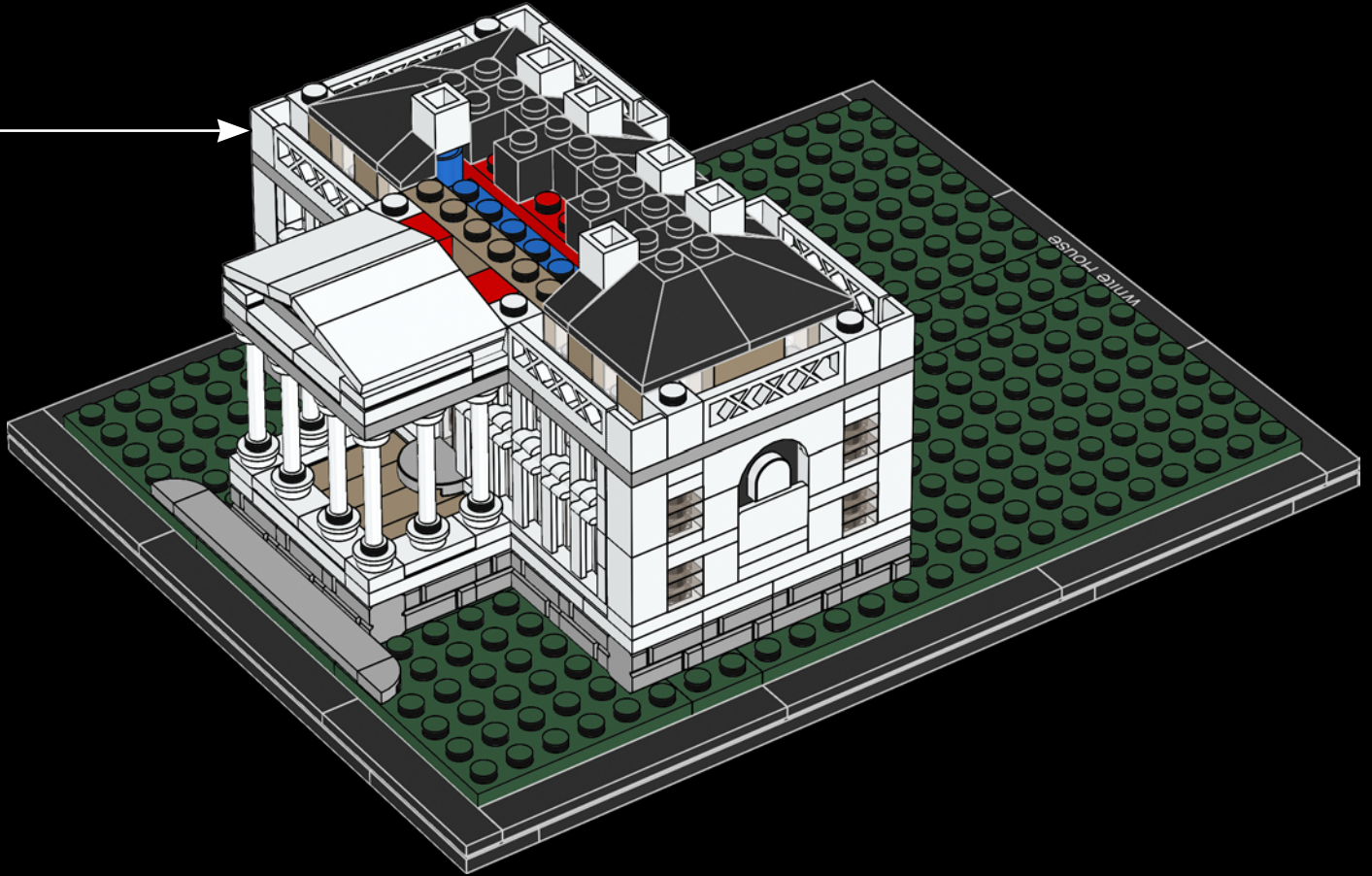

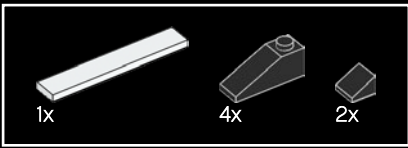

75

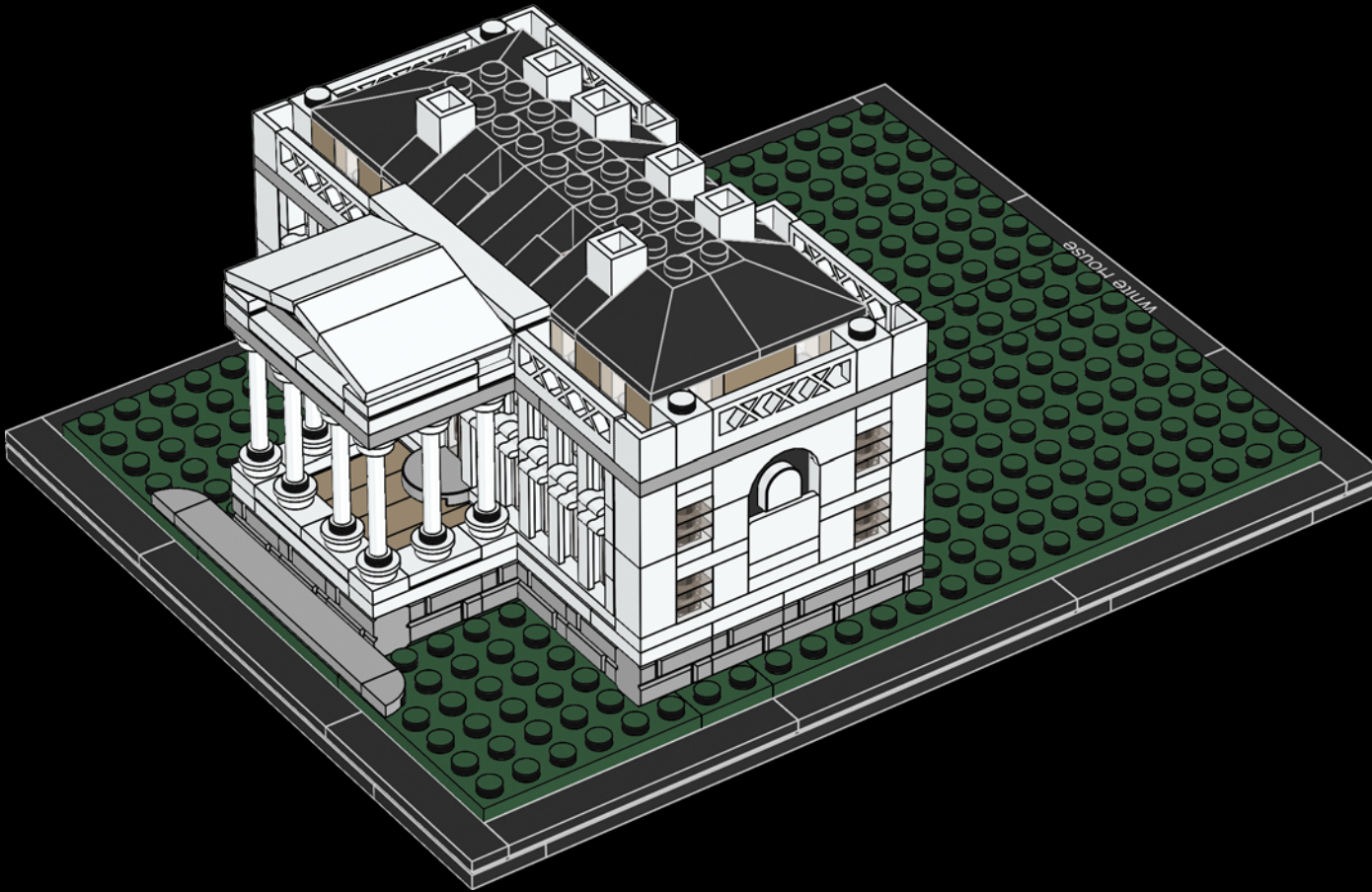

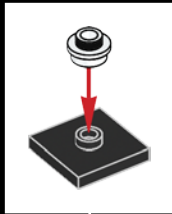
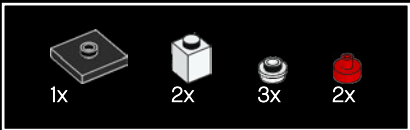

76

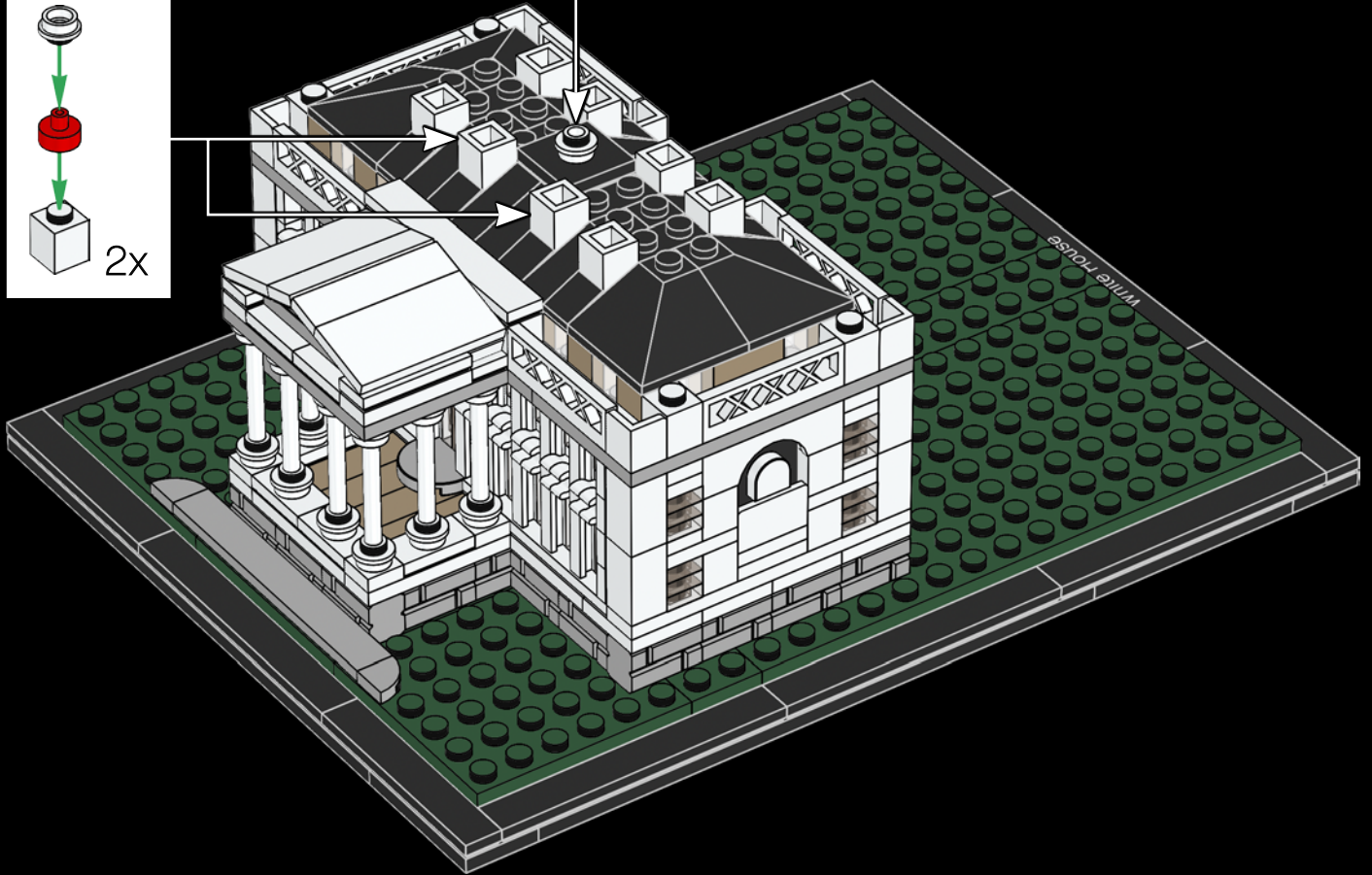
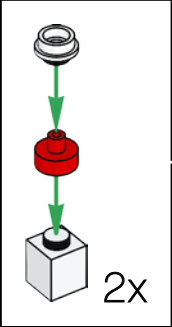

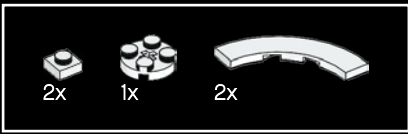

77

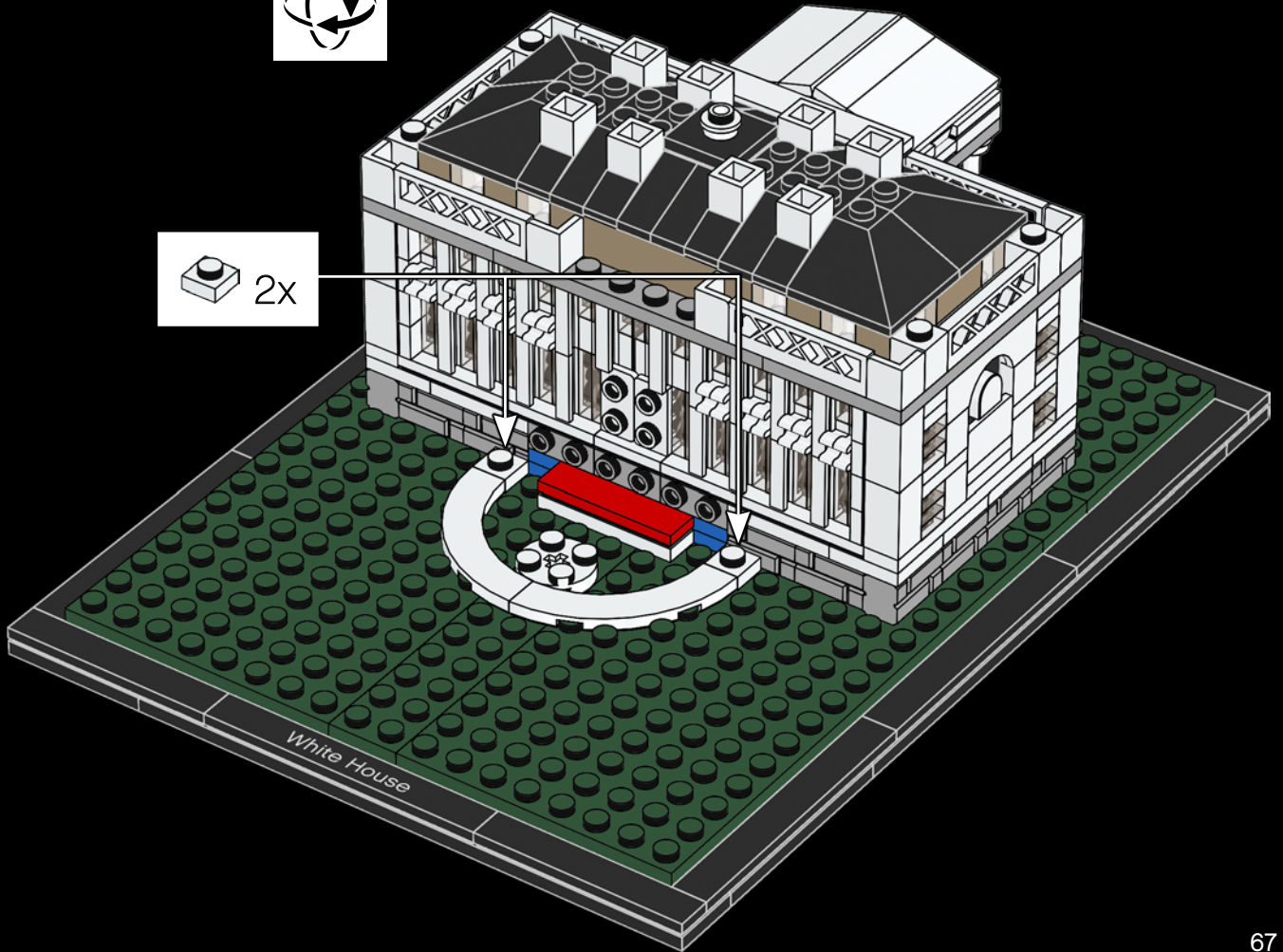

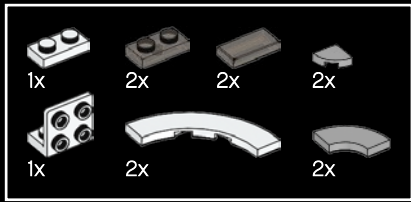

78

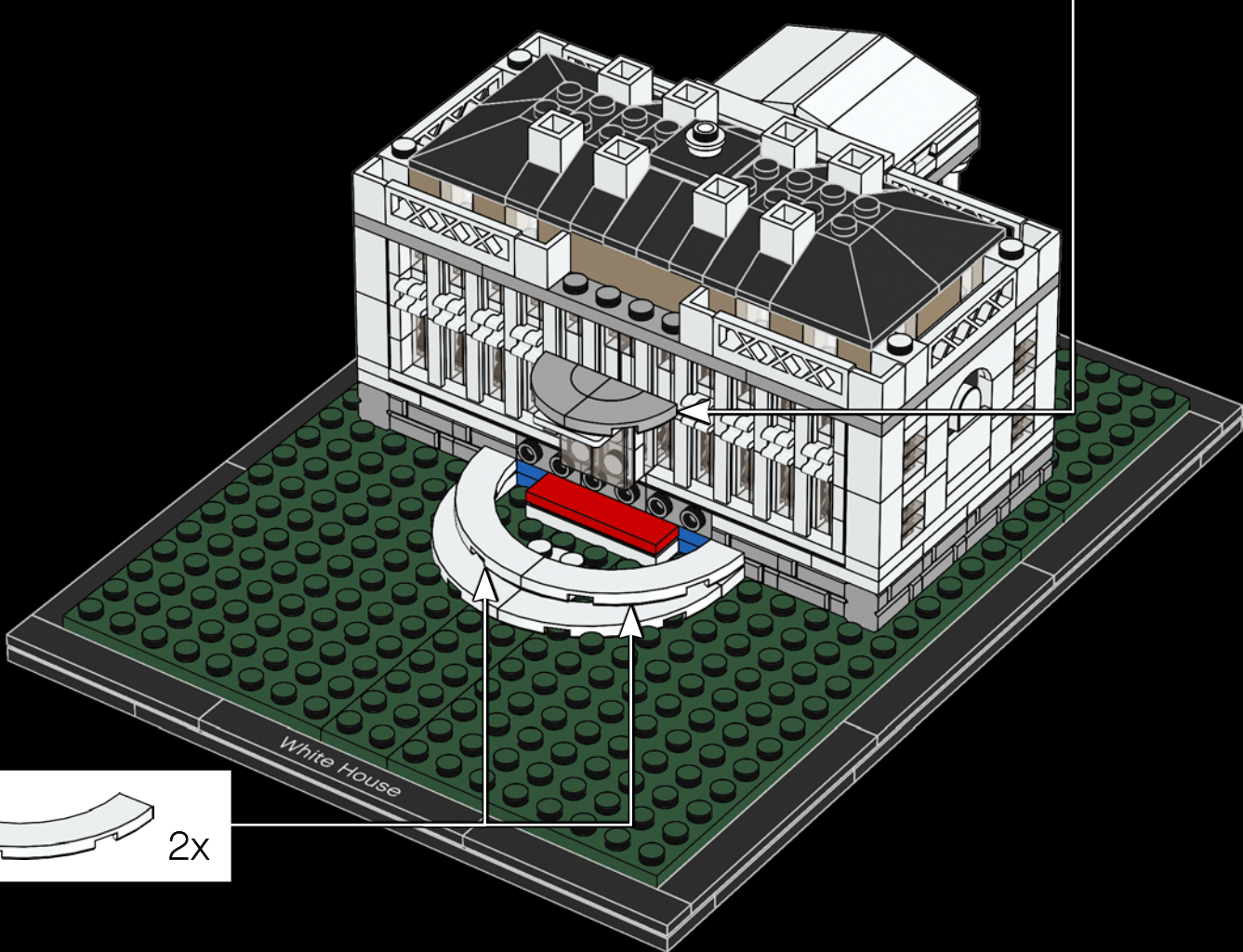
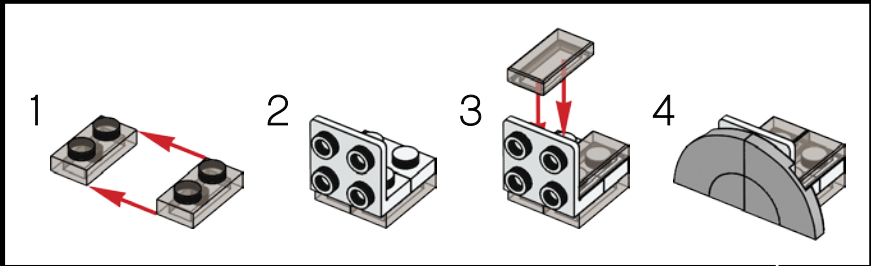

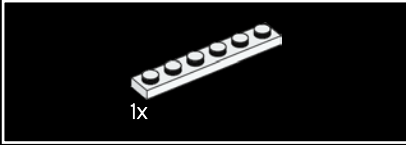
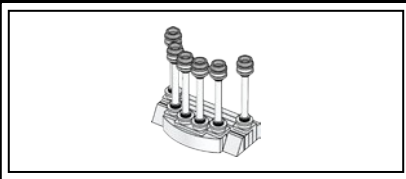

1x

79

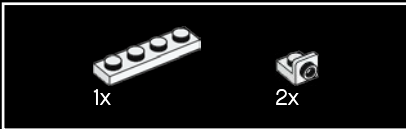

1x

2x

80

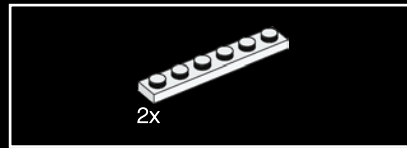
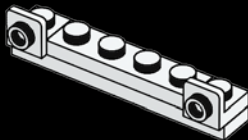

2x

81

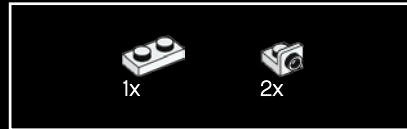
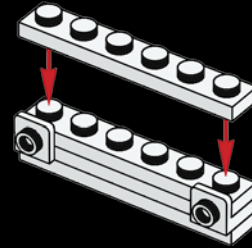

1x

2x

82

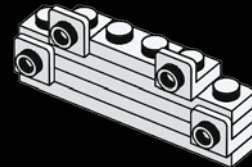



83

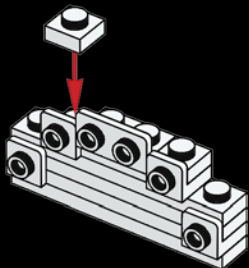

84

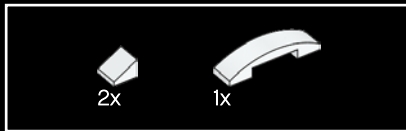
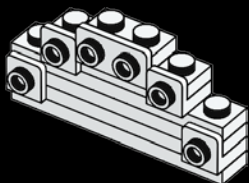

85

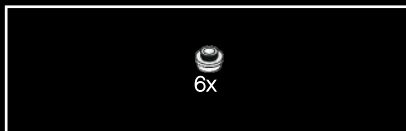
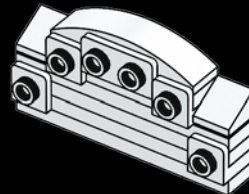

86

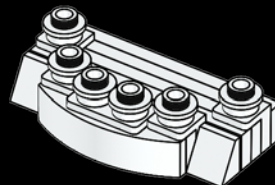



87

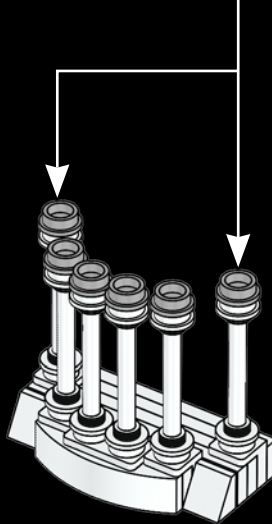
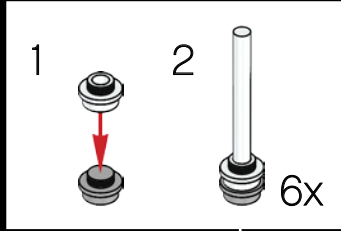

88

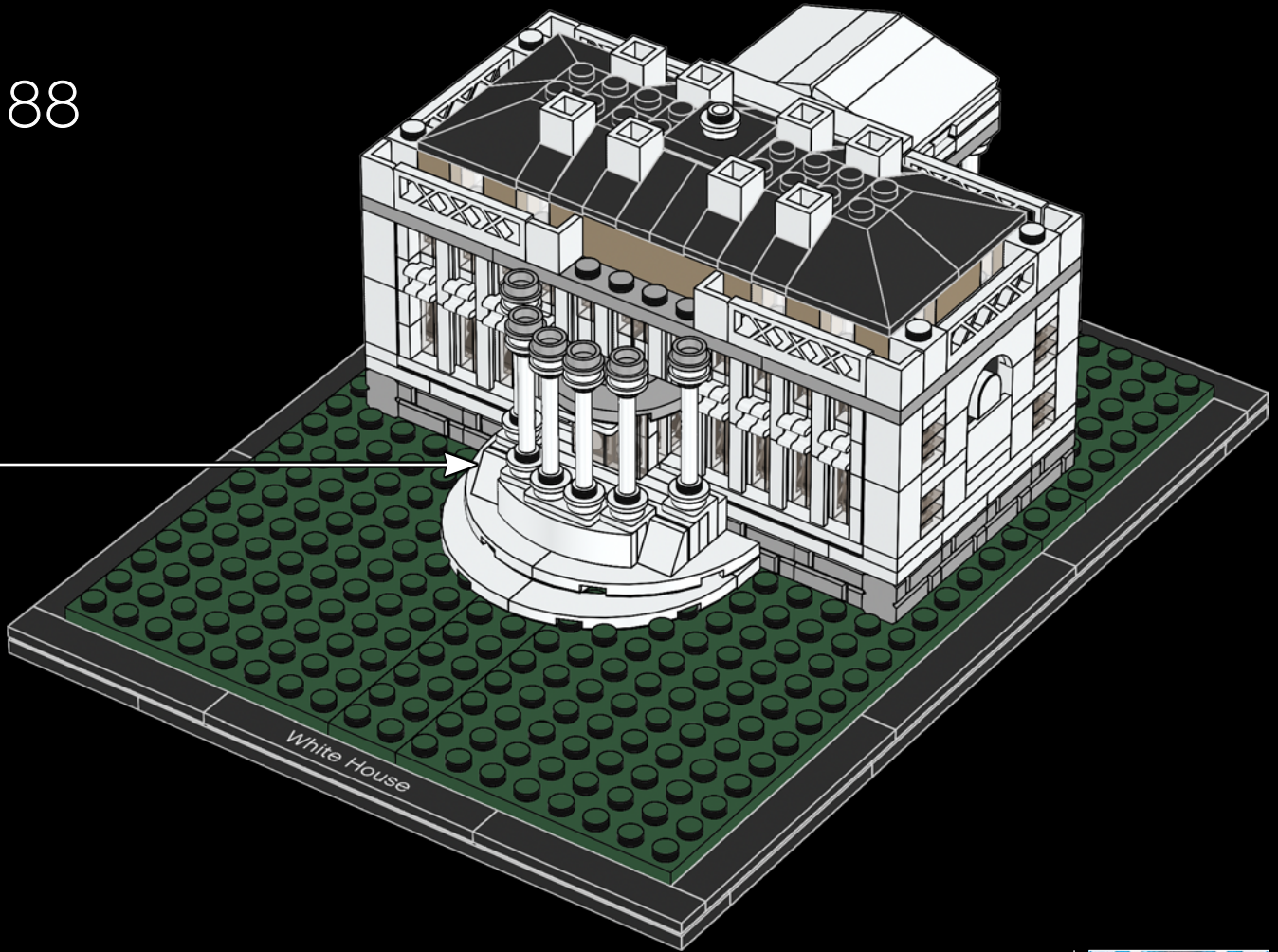

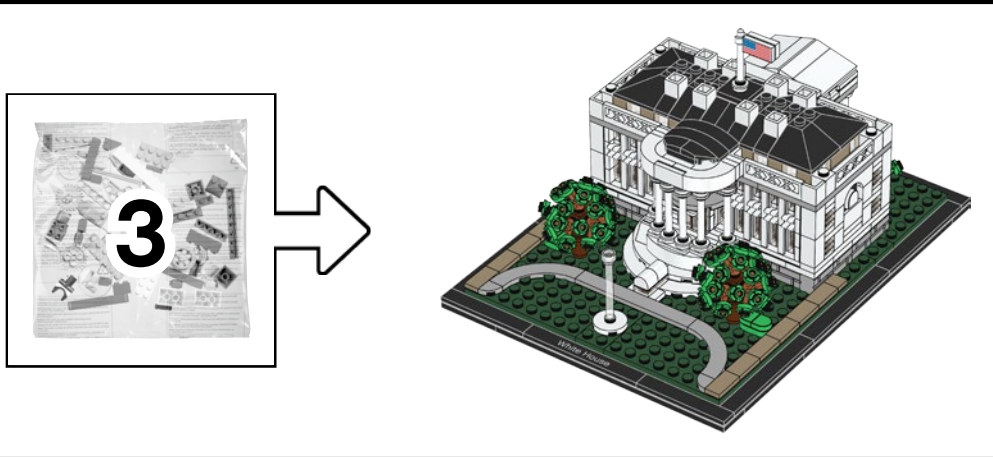

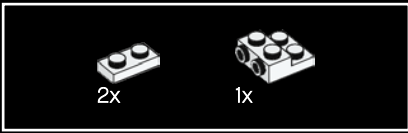

89

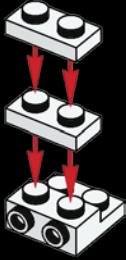

90

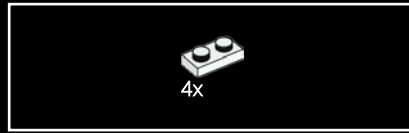
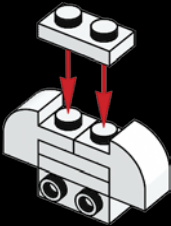

91

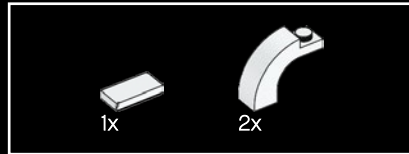
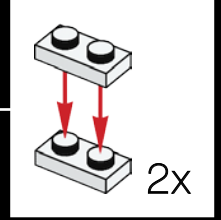
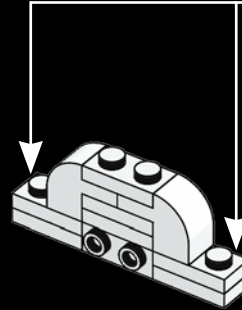

92

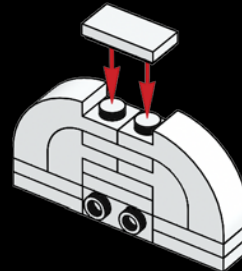

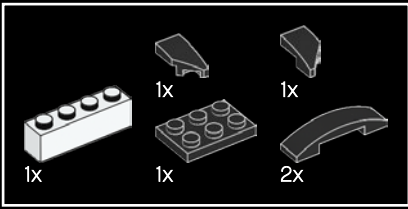

93

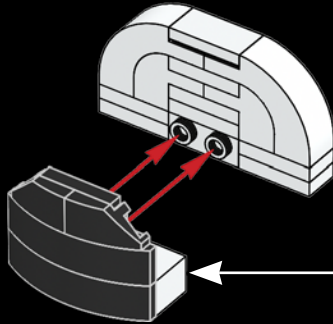
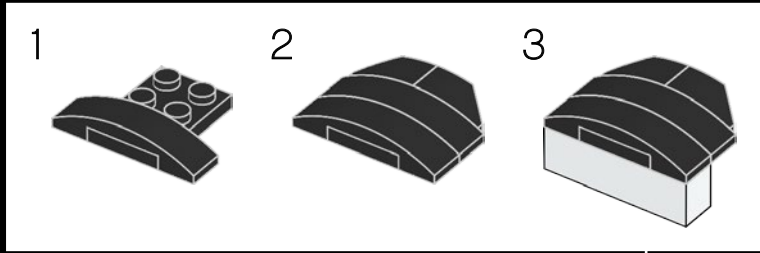

94

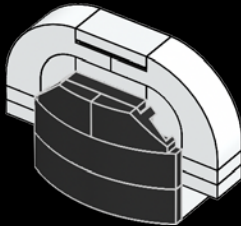

There are 132 rooms, 35 bathrooms and 6 levels
in the official Residence



95

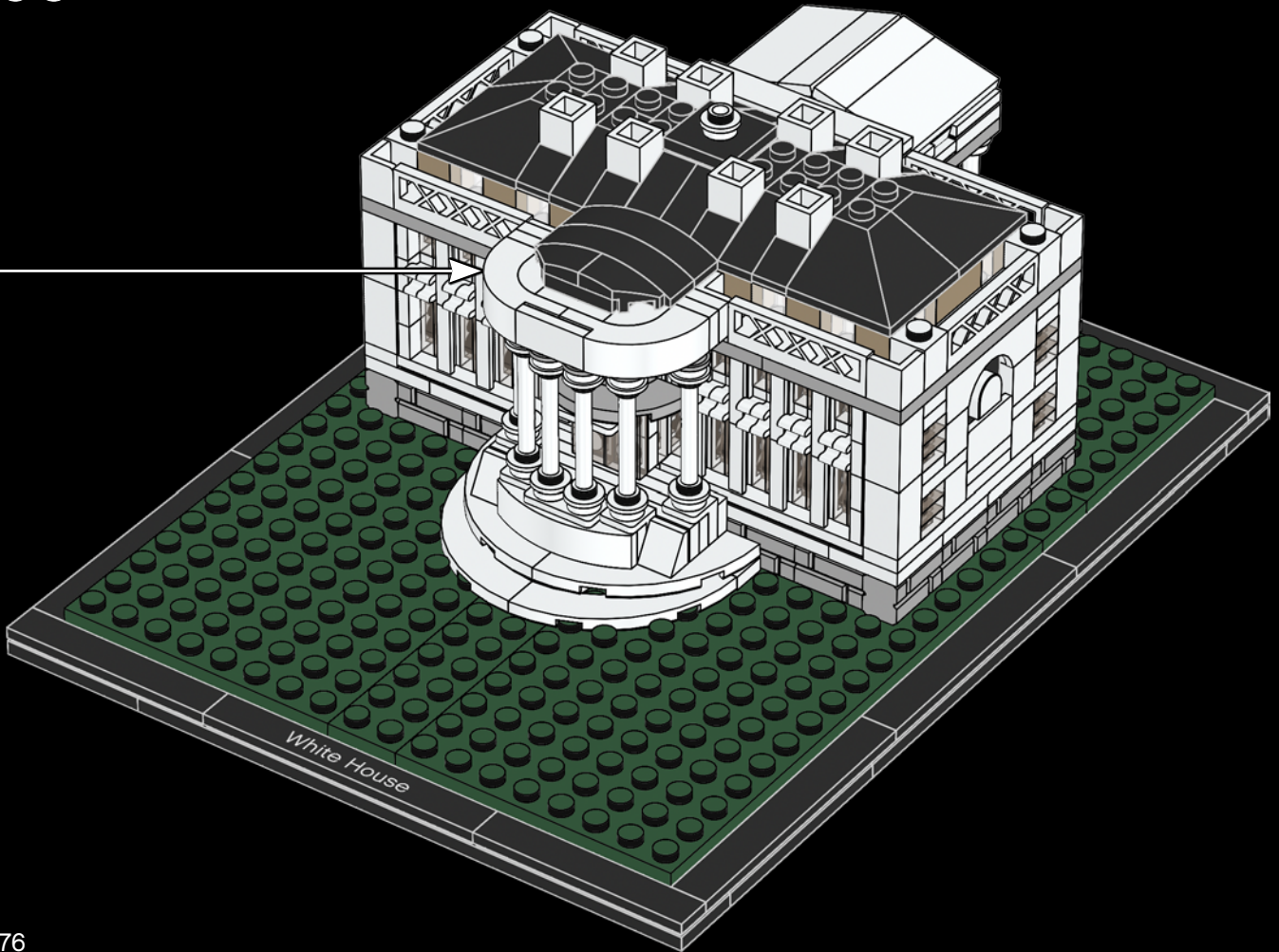

76

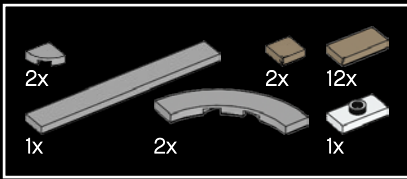

96

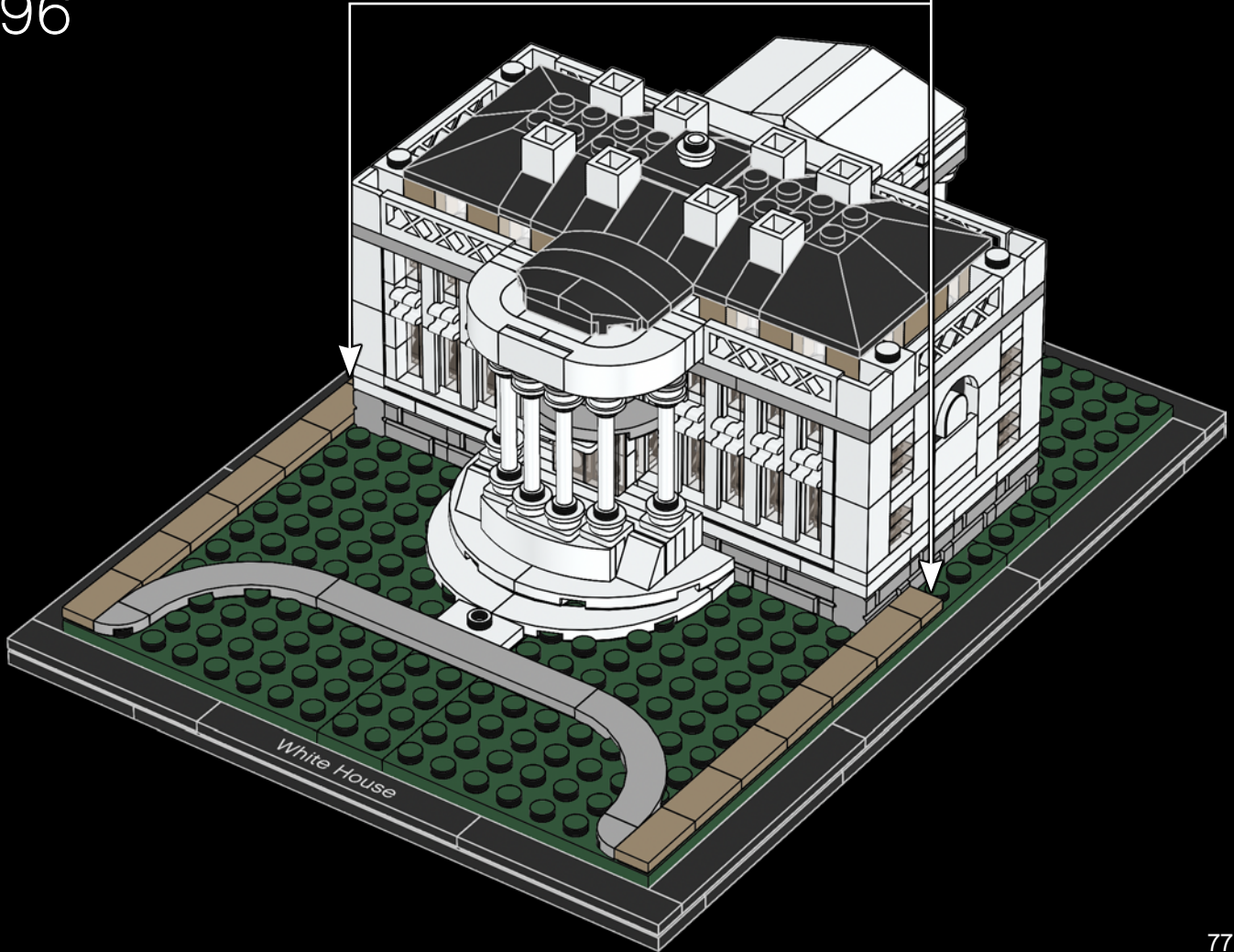
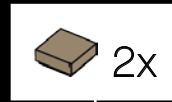



97

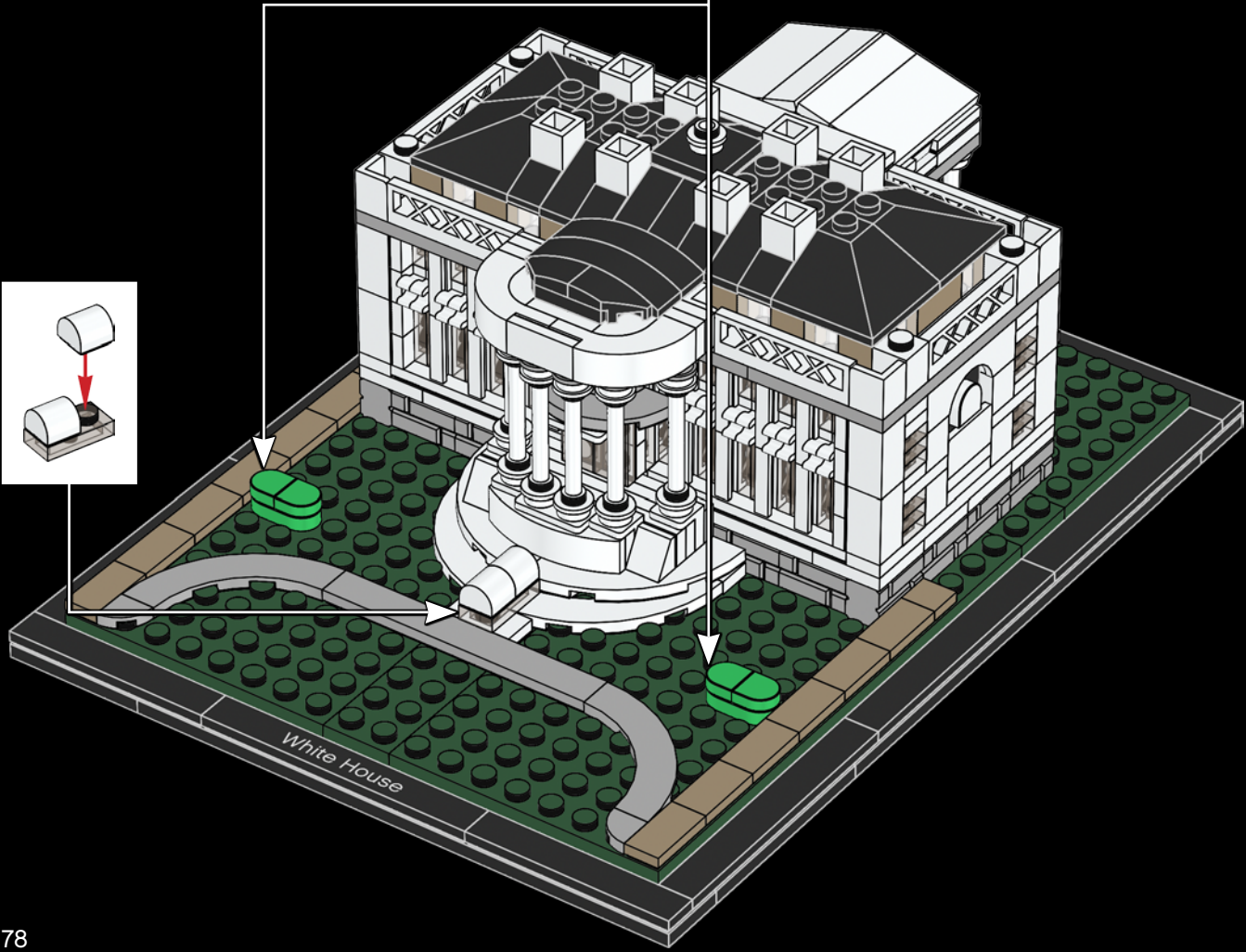
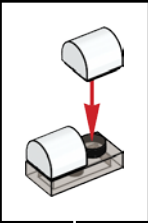
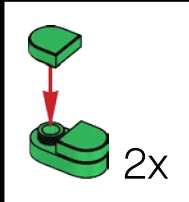

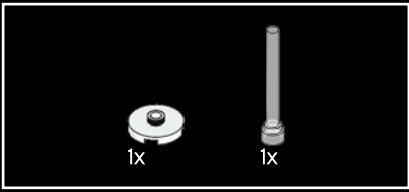

98

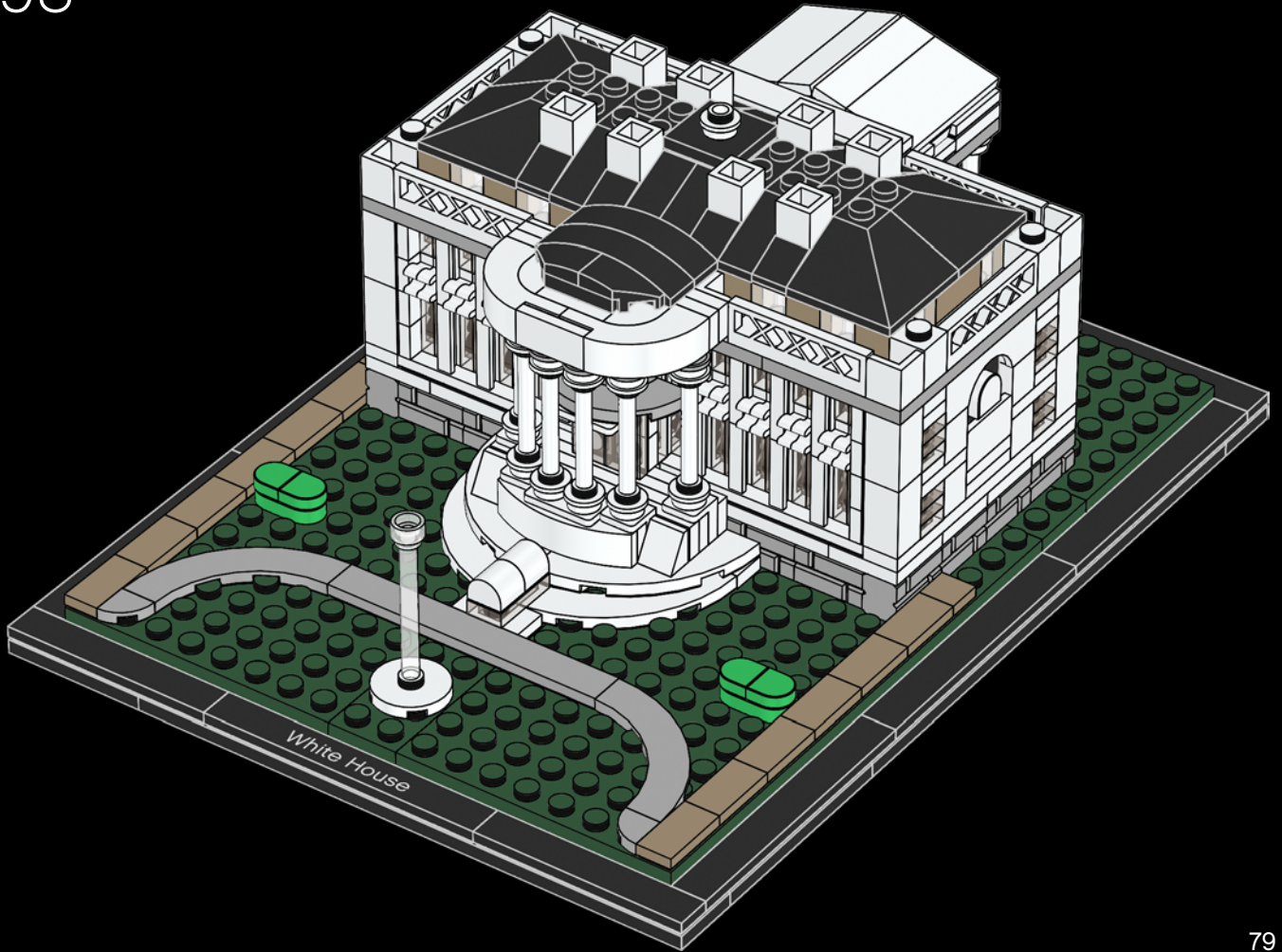

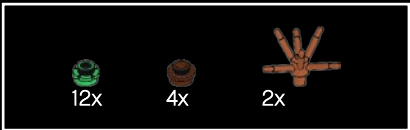

99

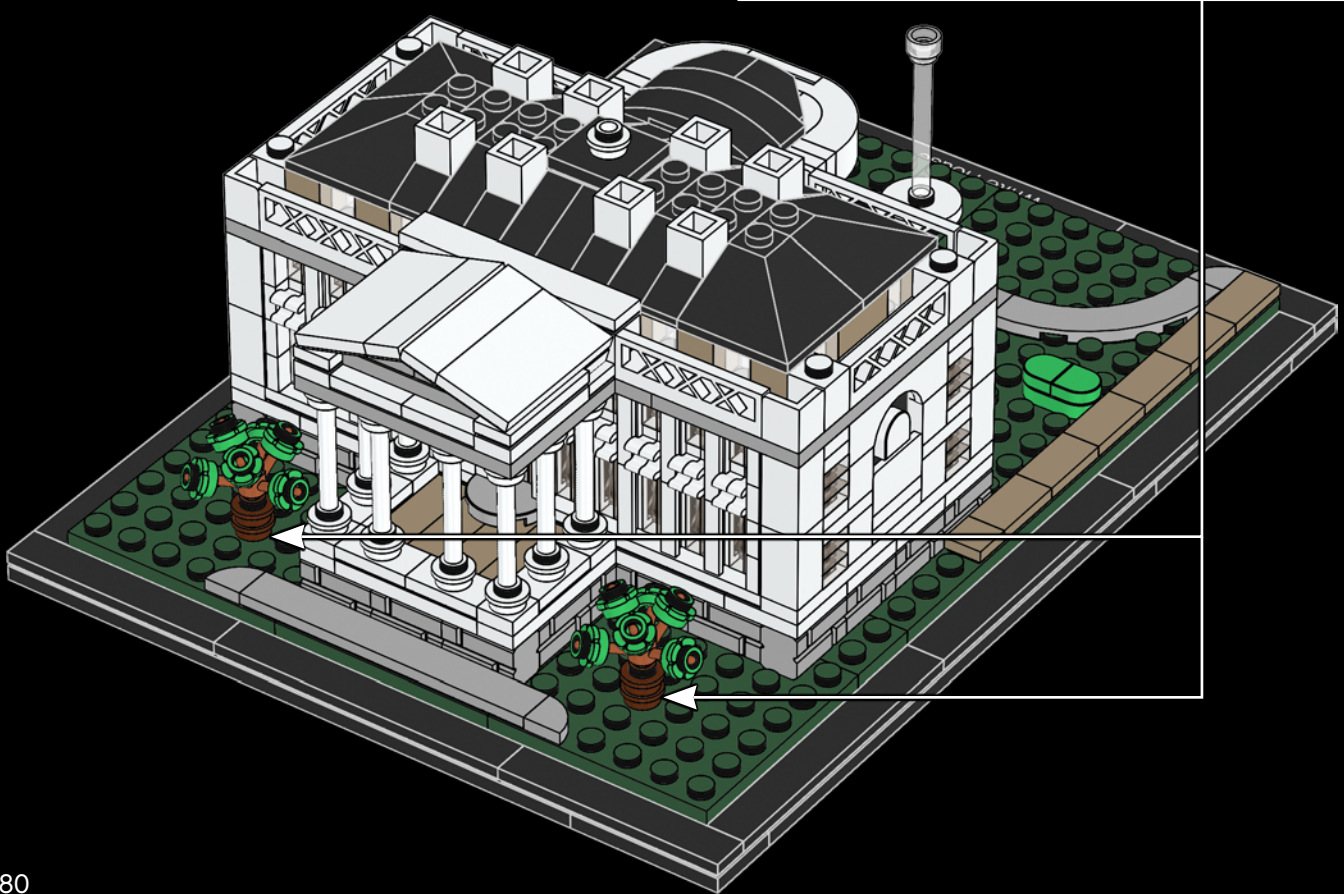

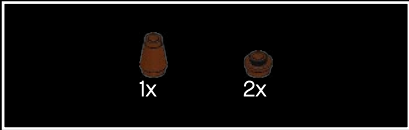

100



101



102

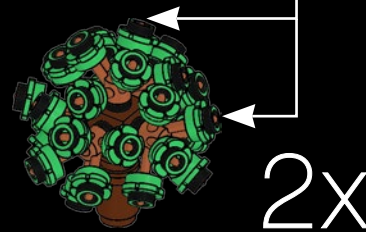
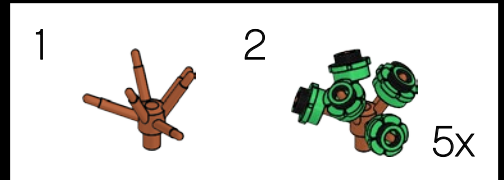

103

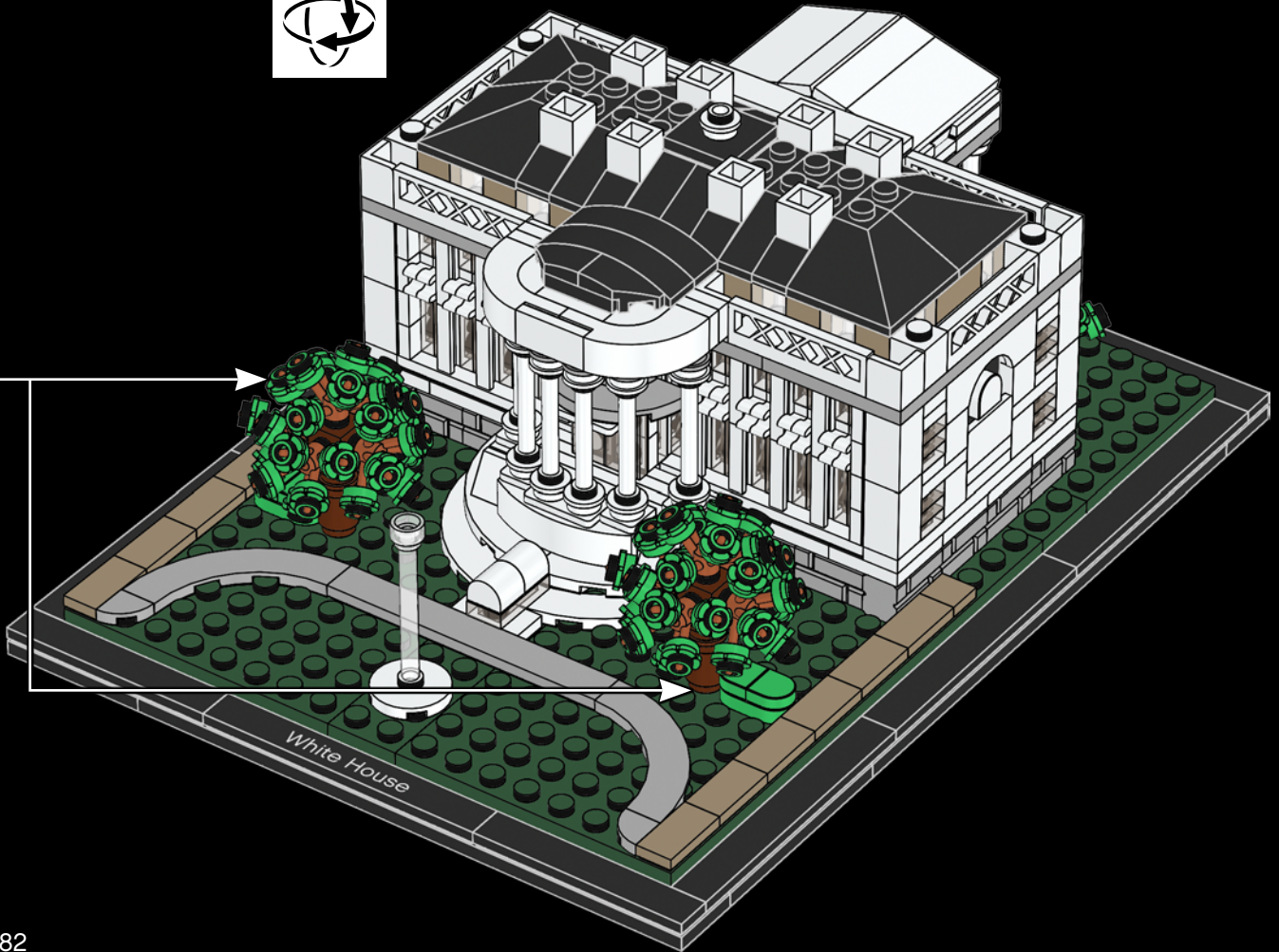

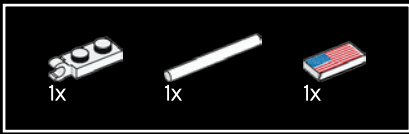

104

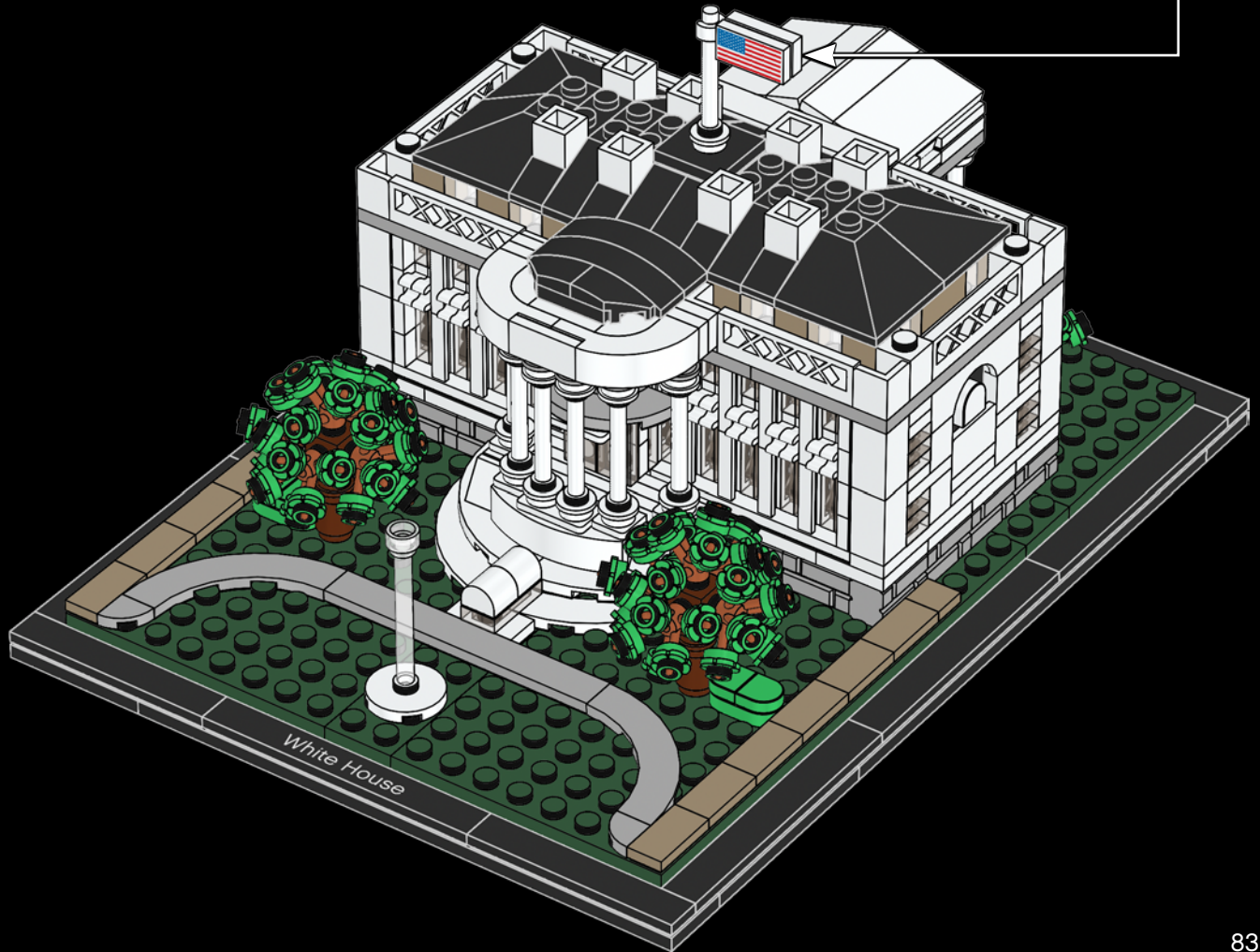
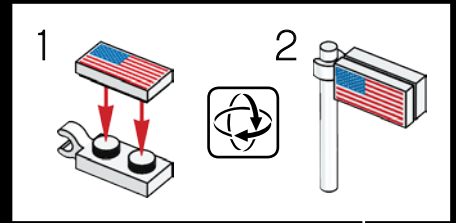



The East Wing

The original East Wing was completed in 1902 and served mainly as an entrance for formal visitors during large social gatherings. The building we see today was added in 1942, primarily to cover the construction of an underground shelter and emergency operations center for Franklin D Roosevelt. Traditionally the East Wing now serves as office space for the first lady and her staff.



The East Wing of the White House in 1992

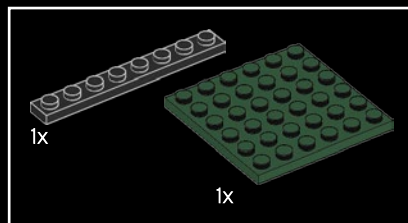
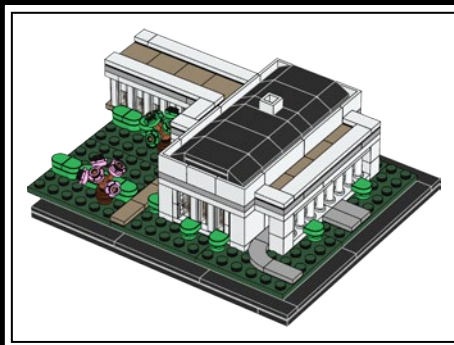
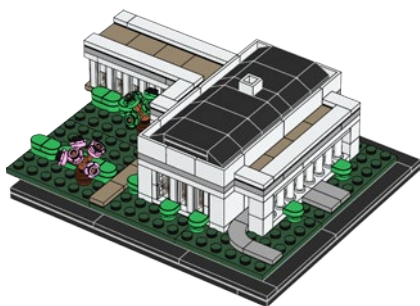
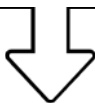
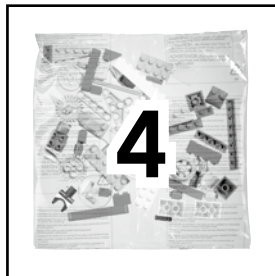

105

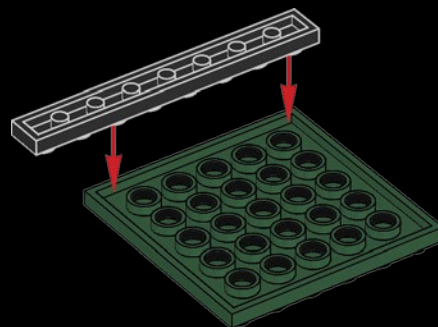

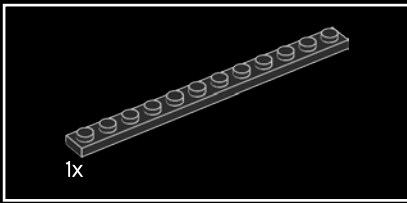

106

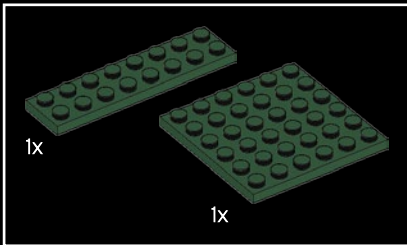
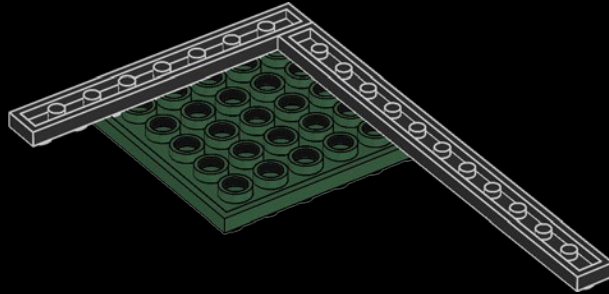

107

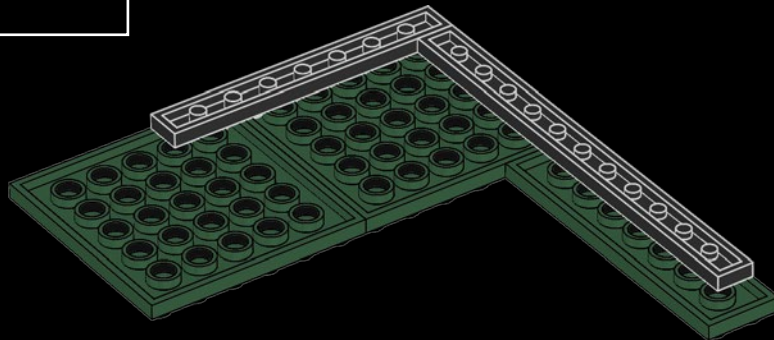

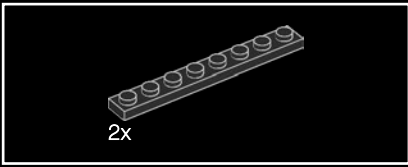

108

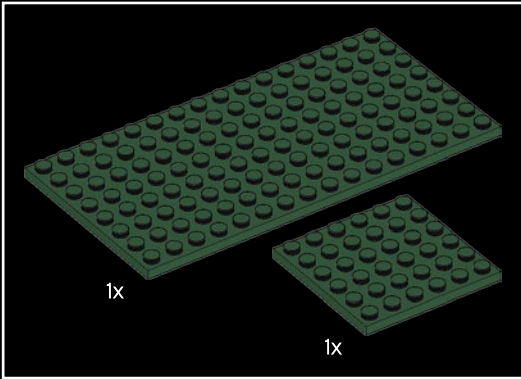
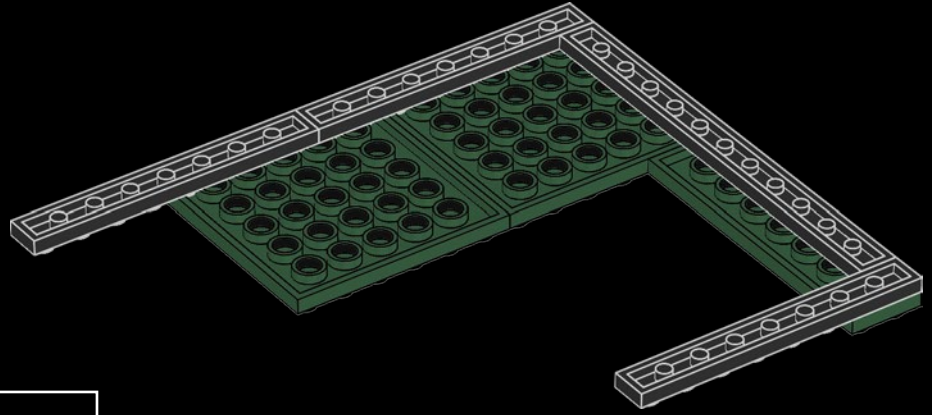

109

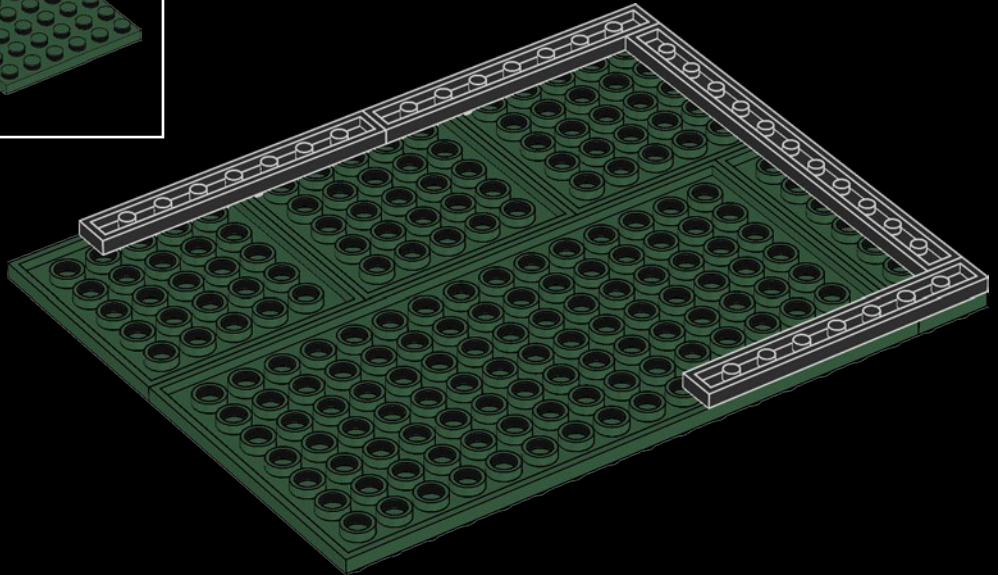

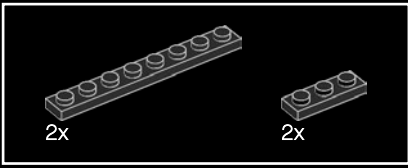

110

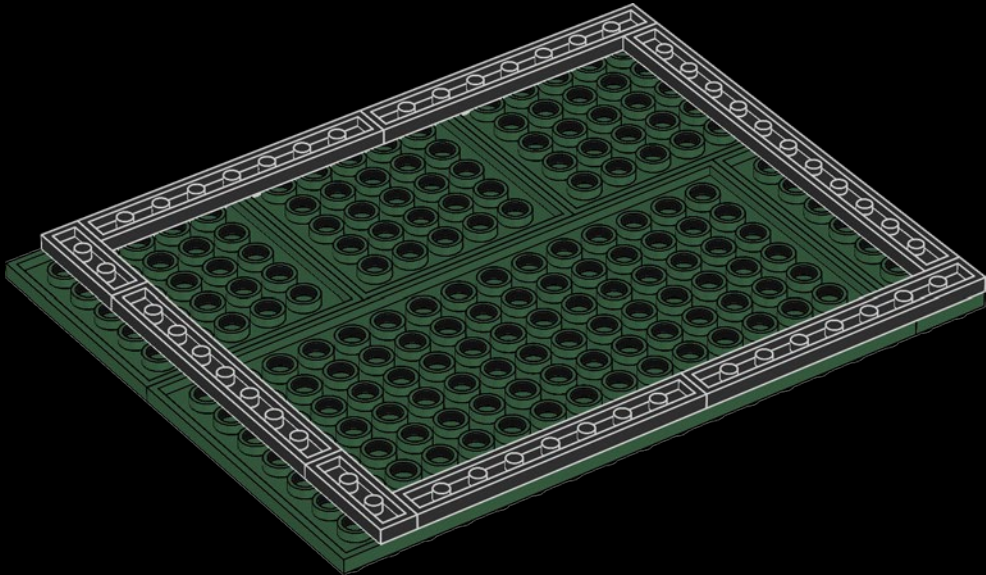

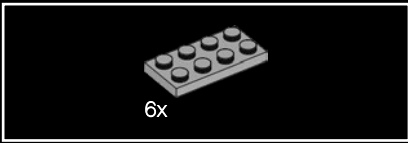

111

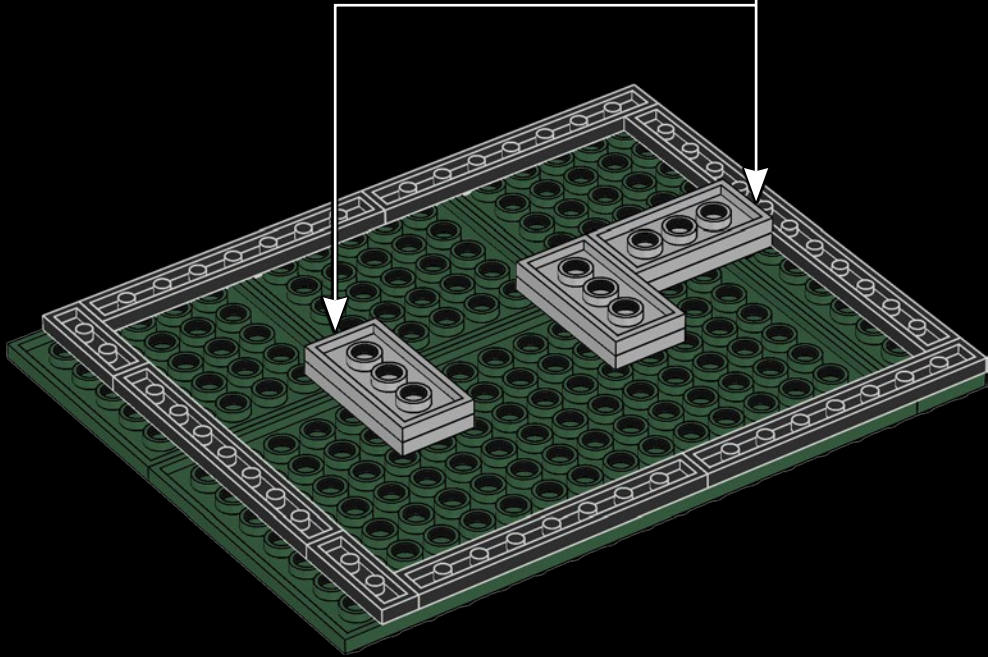
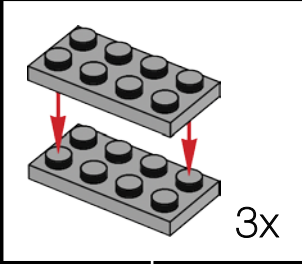

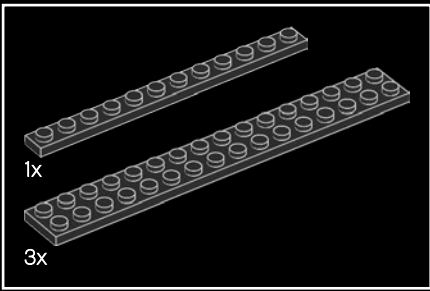

112

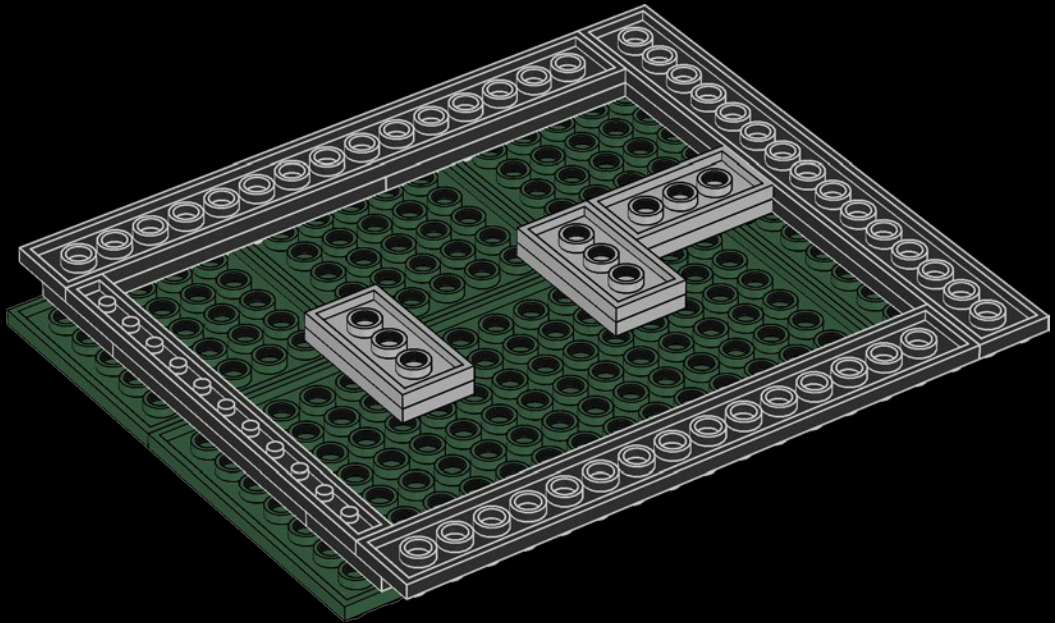

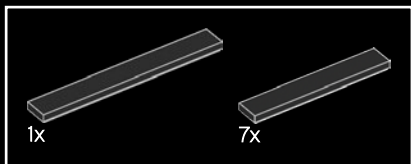

113

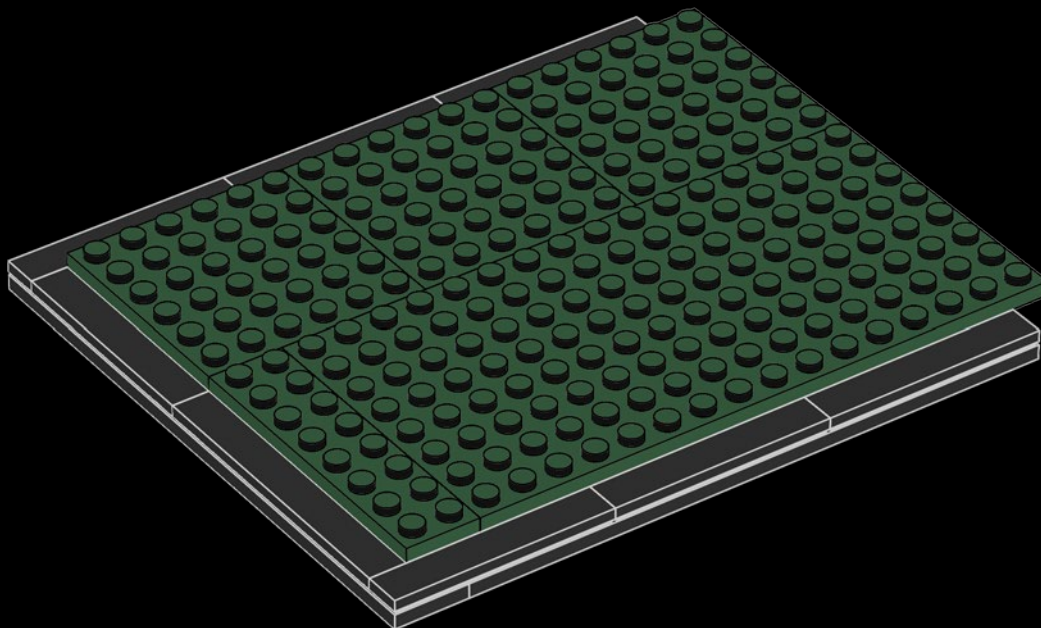

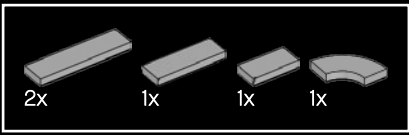

114

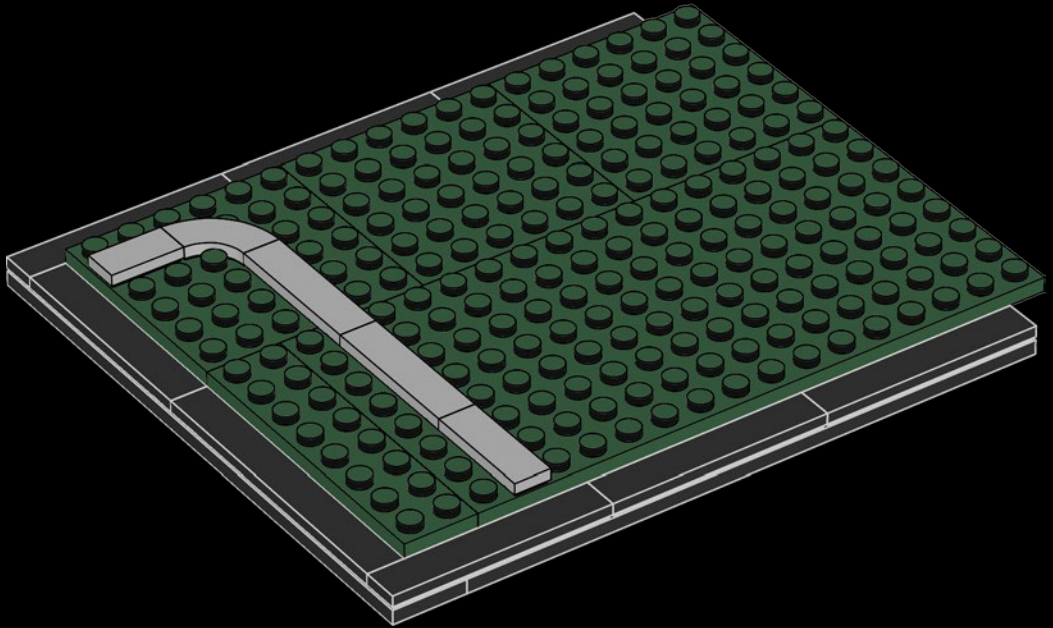

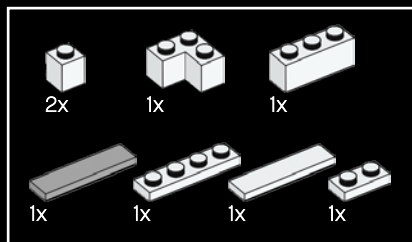

115

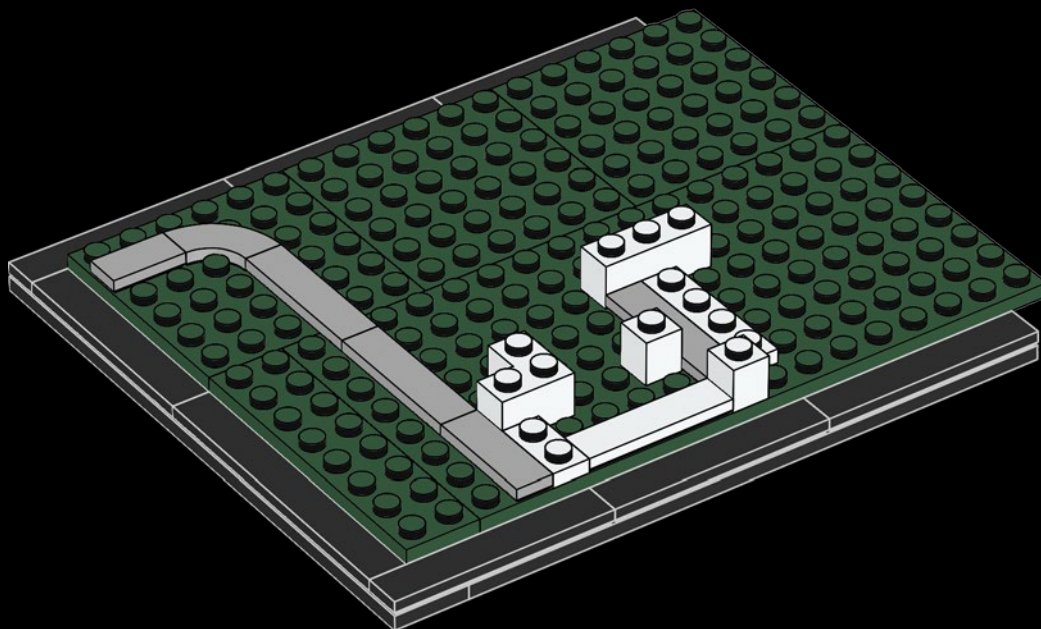

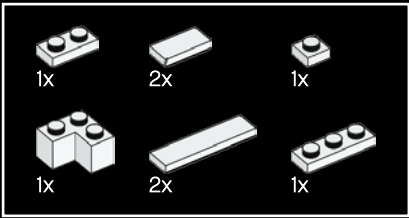

116

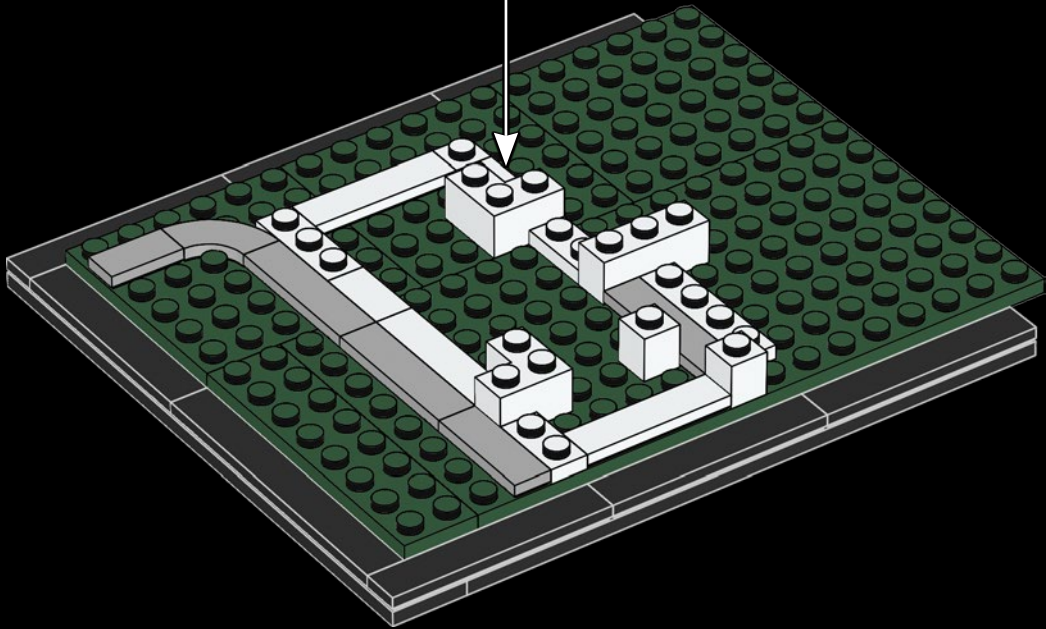
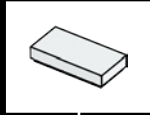

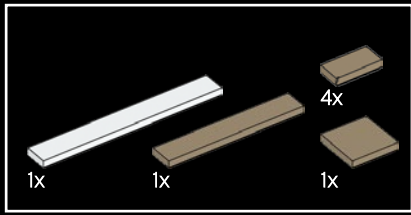

117

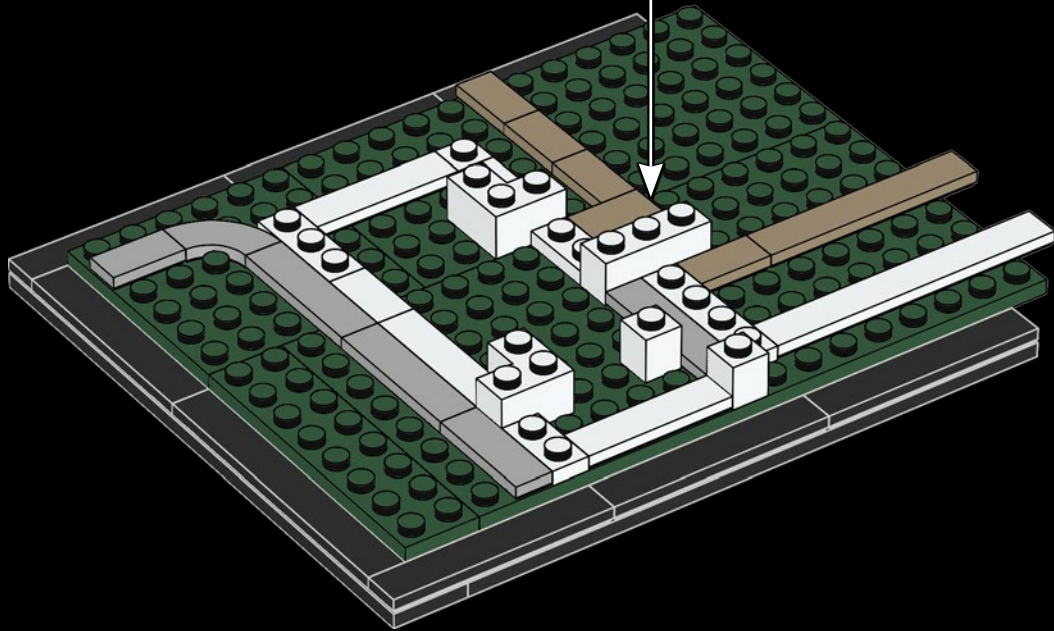
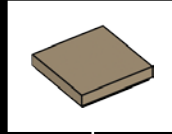



118

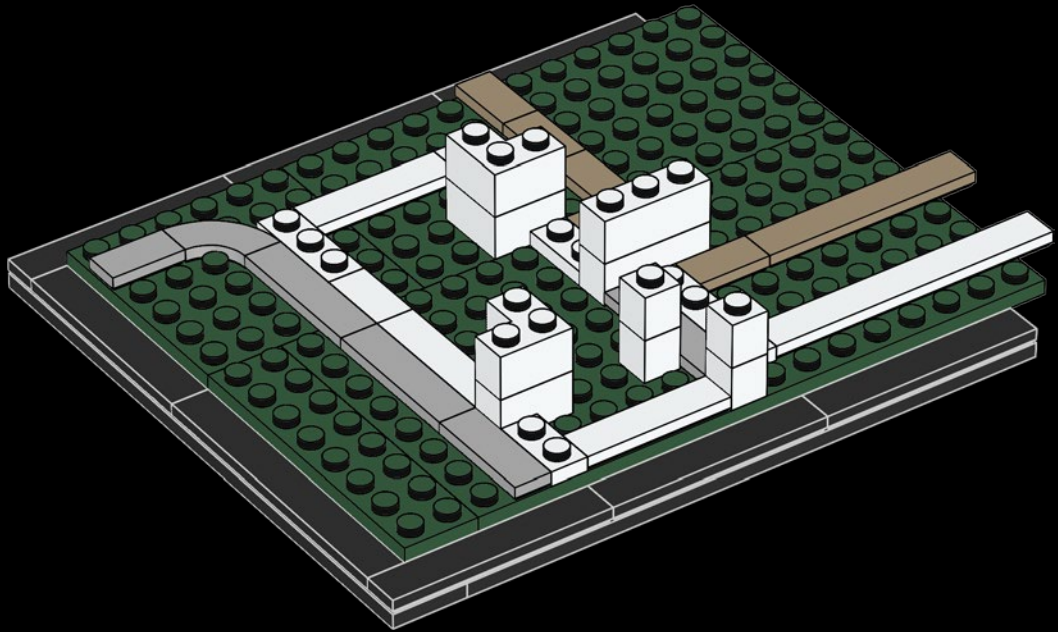

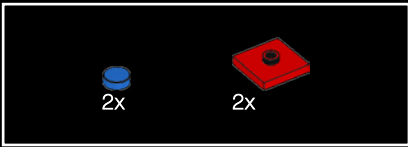

119

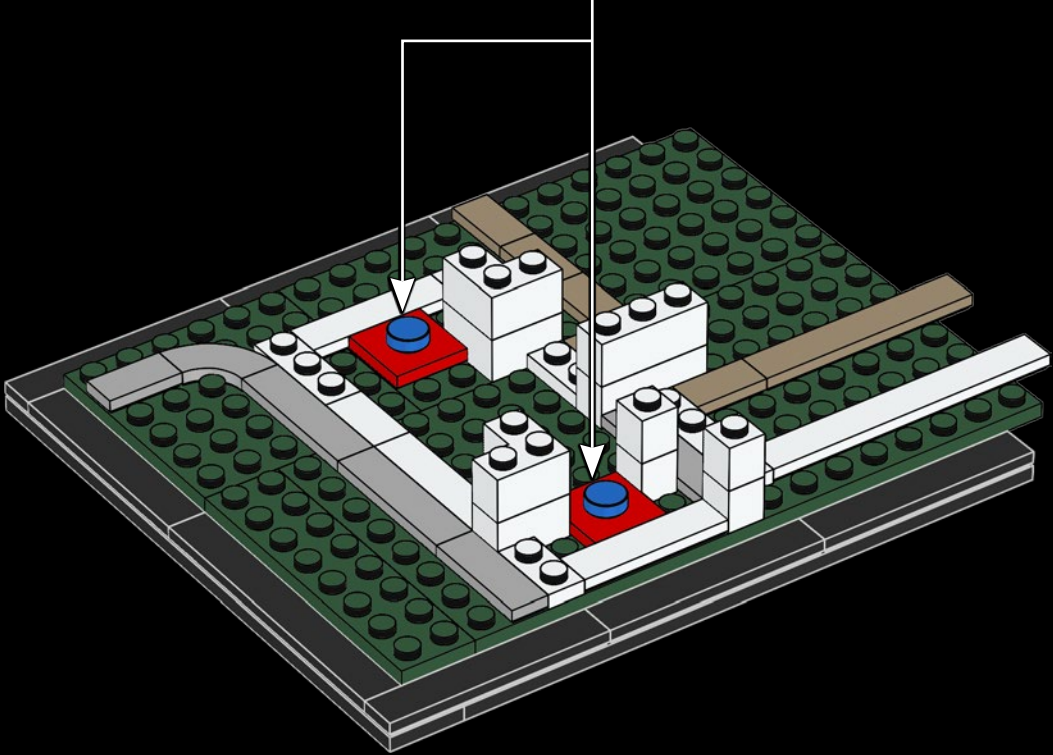
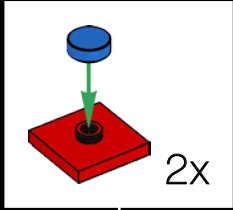



120

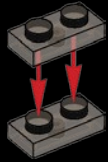

121

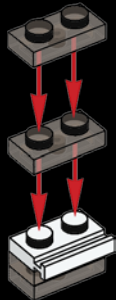

122

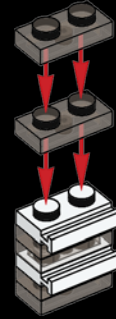

123



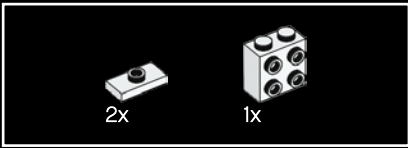

124

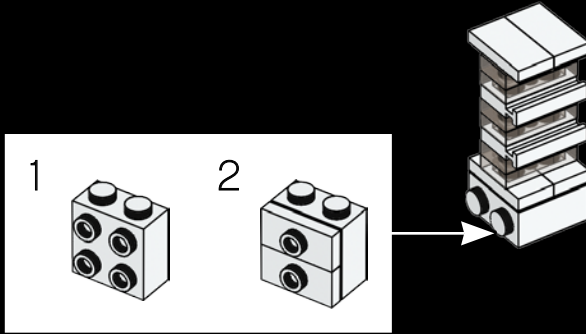

125

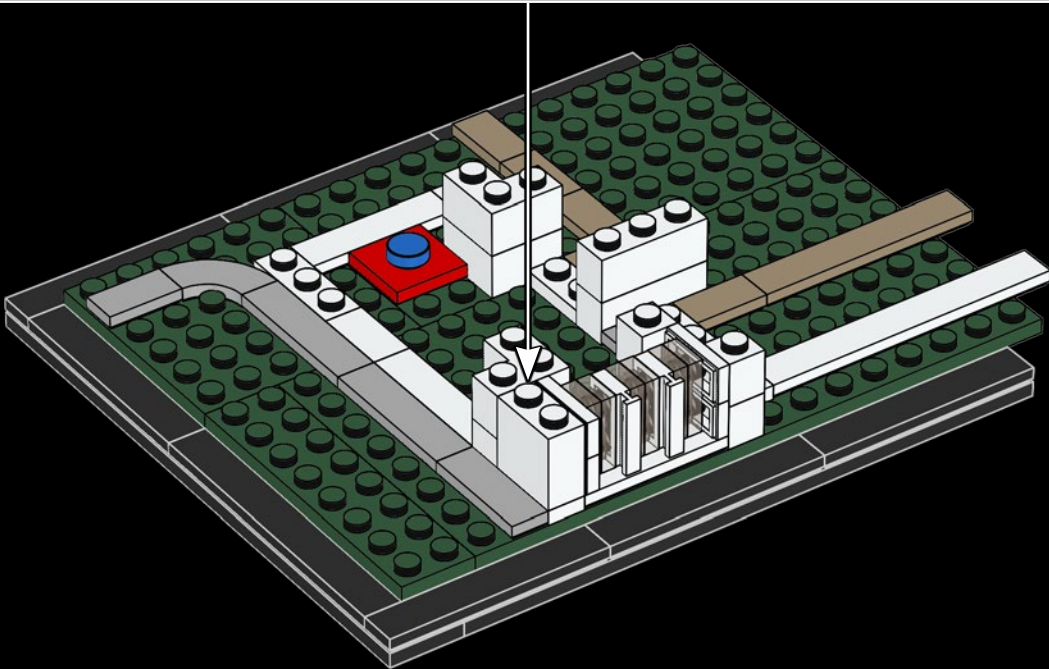

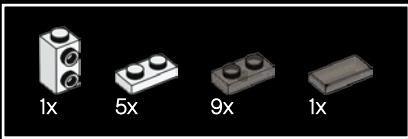

126

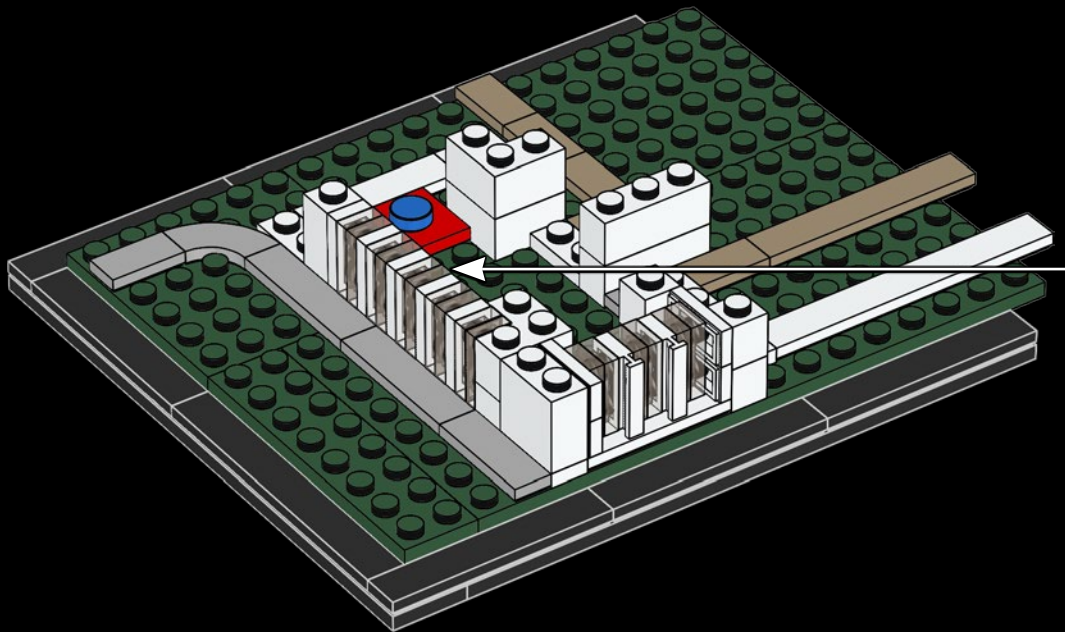
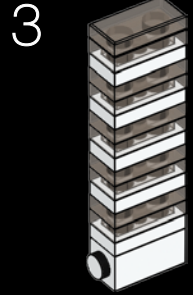
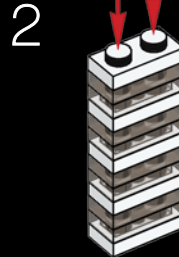
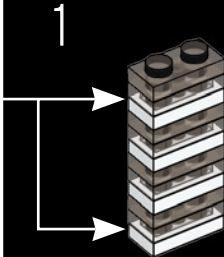
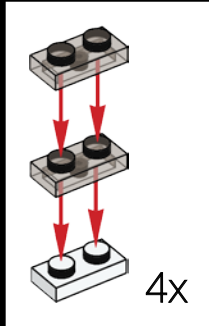



127

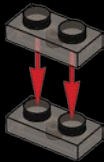

128

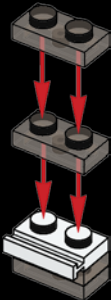

129



130



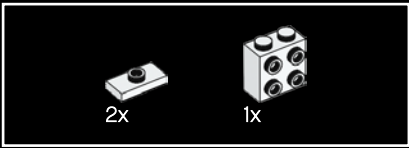

131

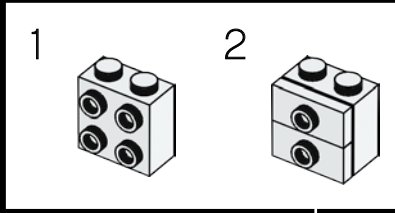

132

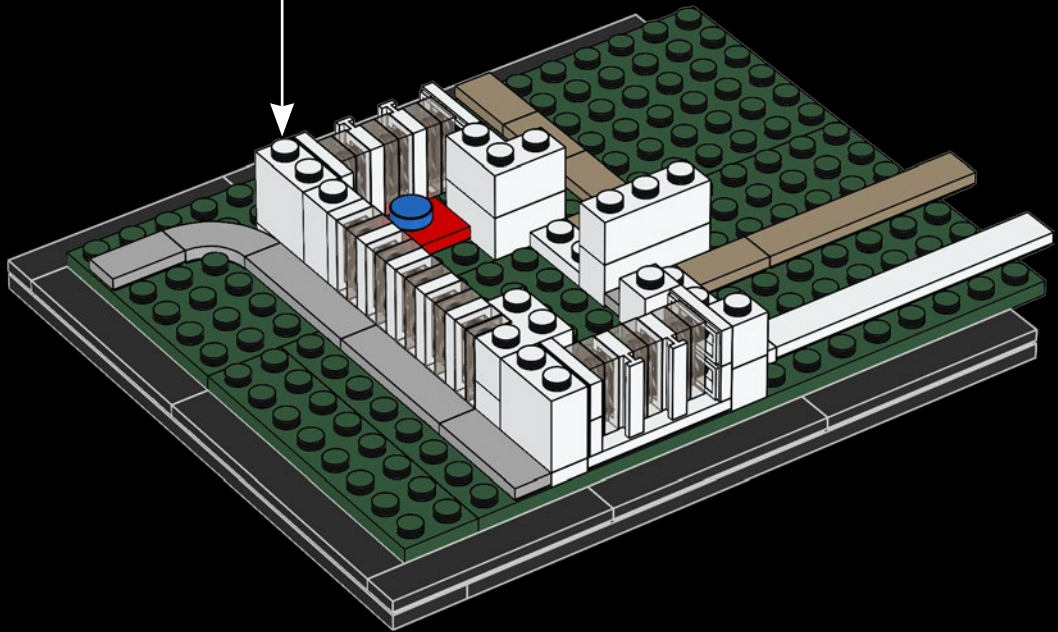

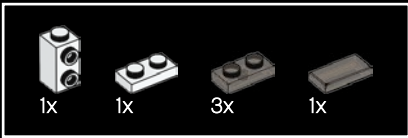

133

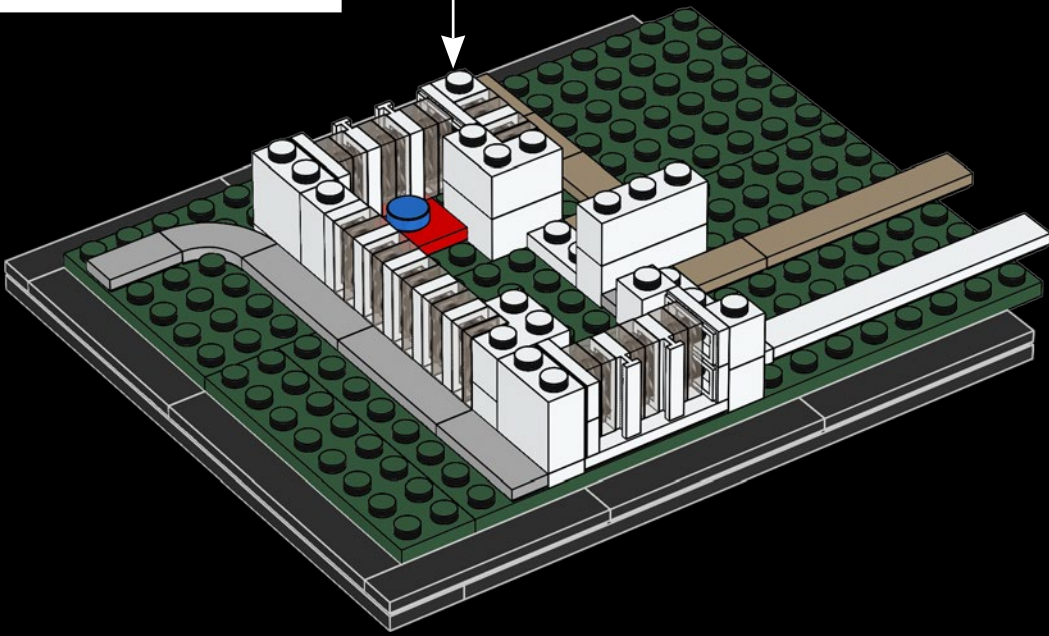
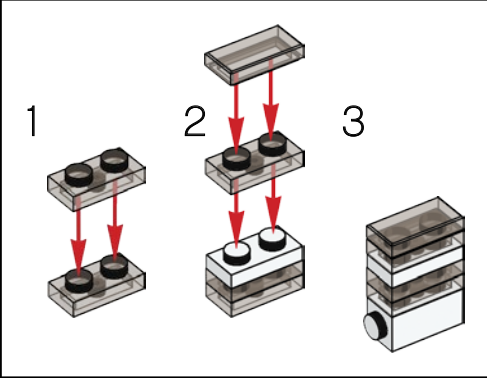

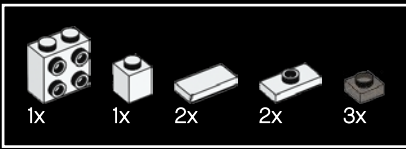

134

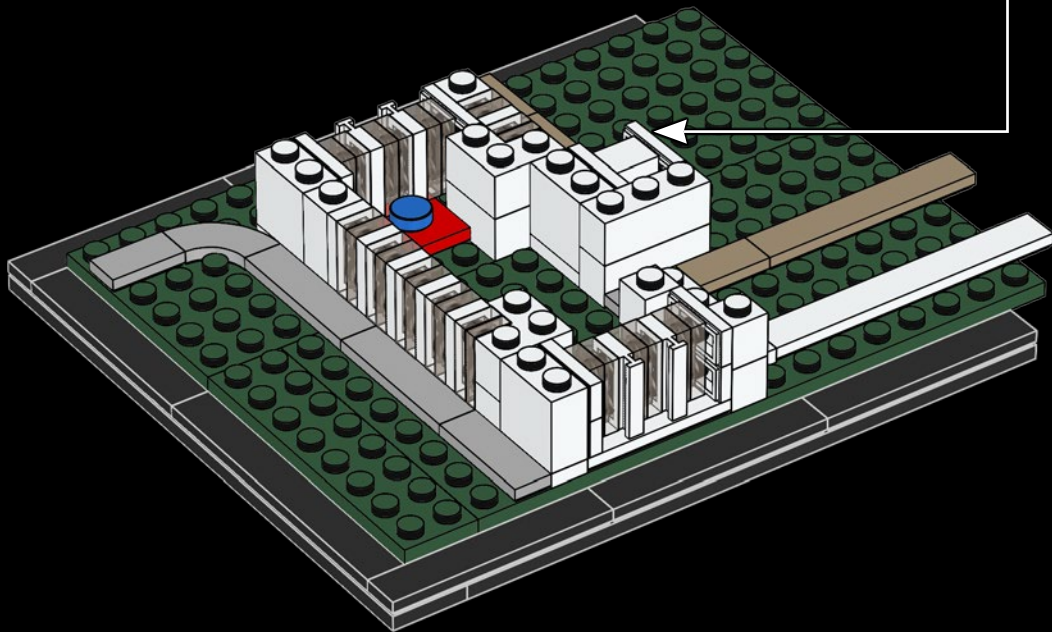
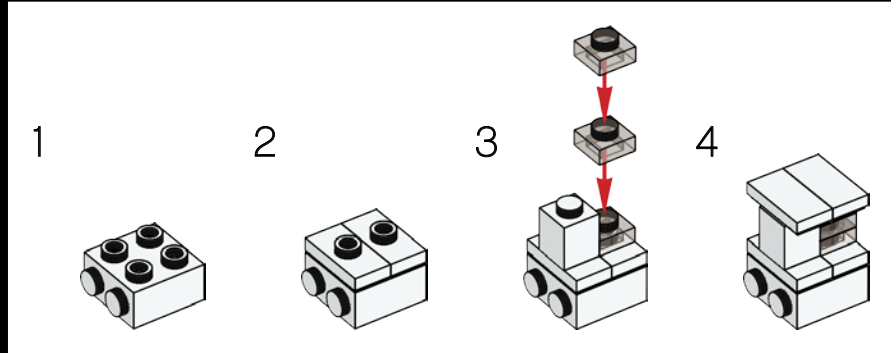

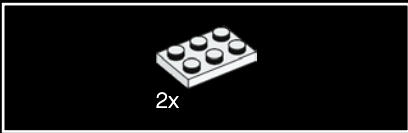

135

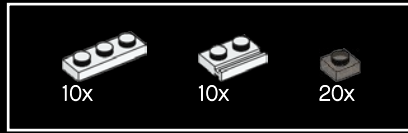
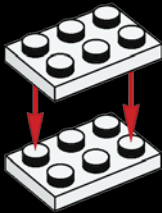

136

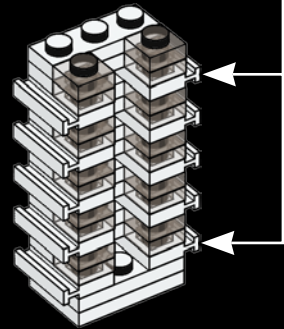
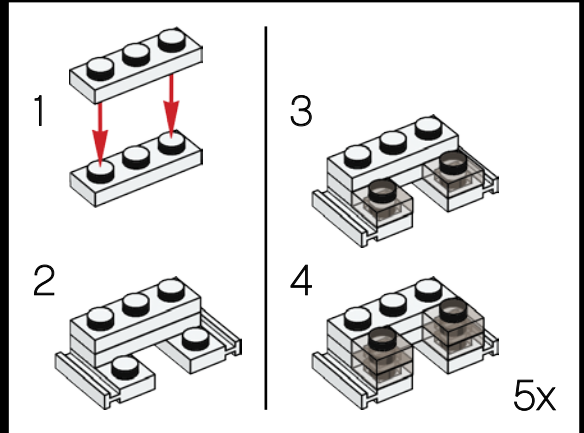

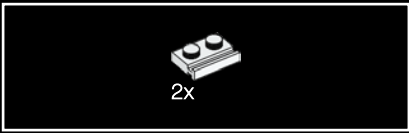

137

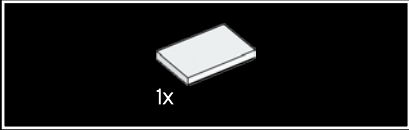
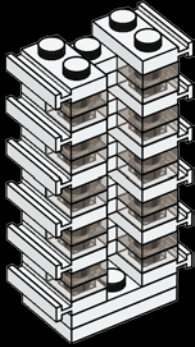

138

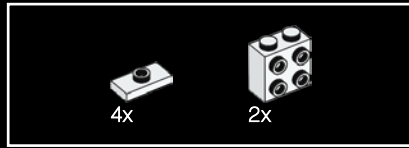
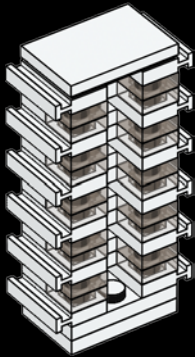

139

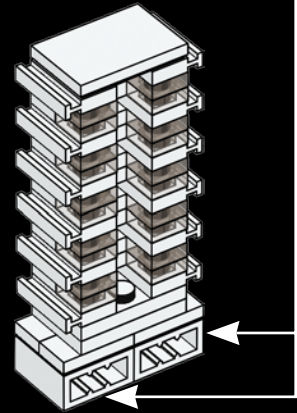
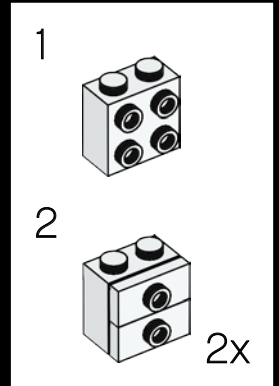

140

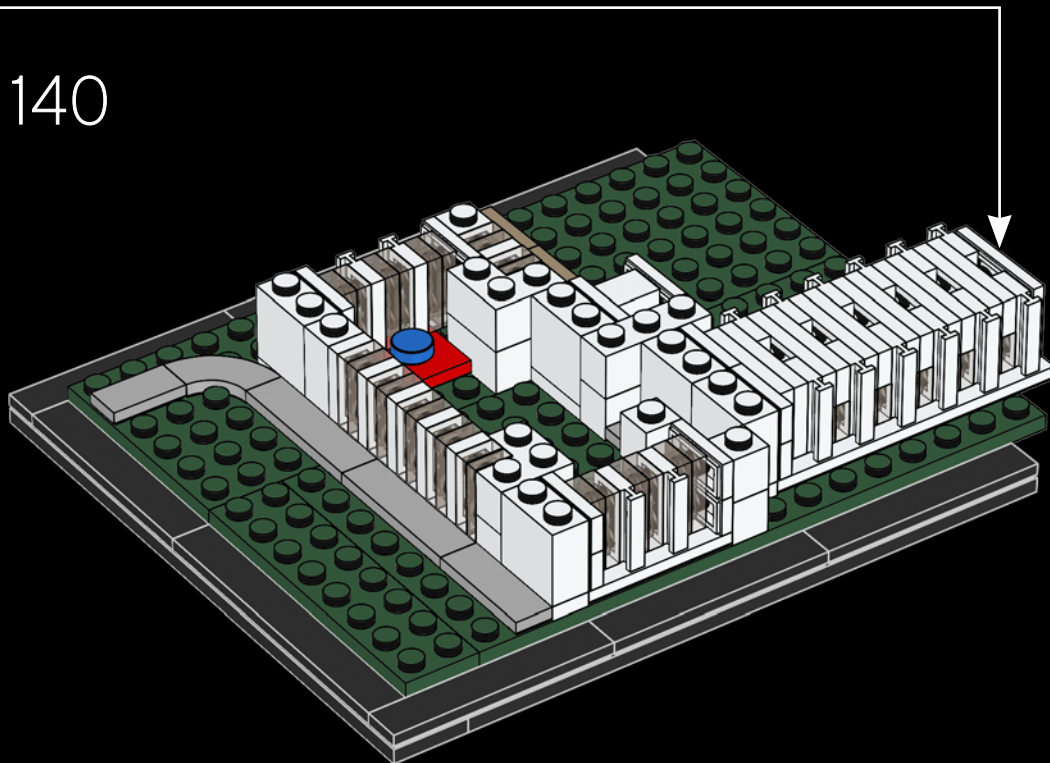

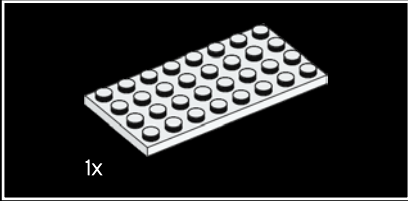
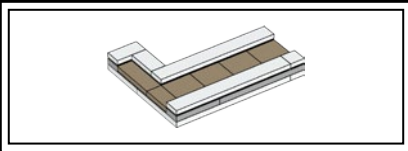

141

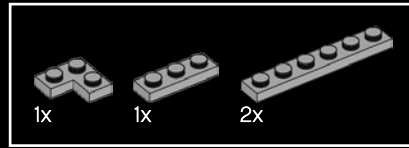
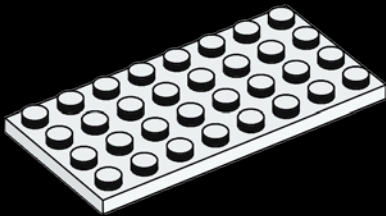

142

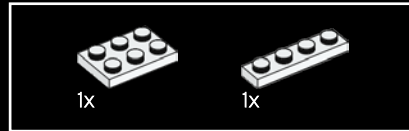
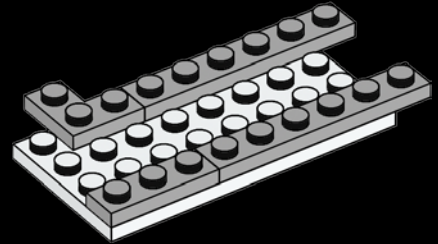

143

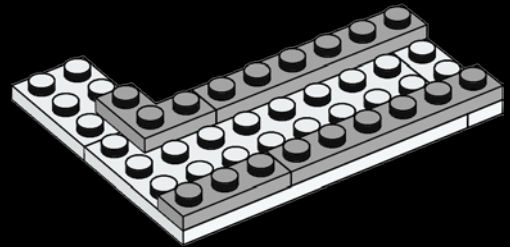

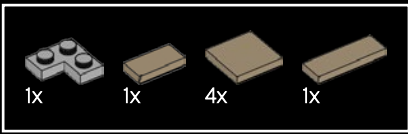

144

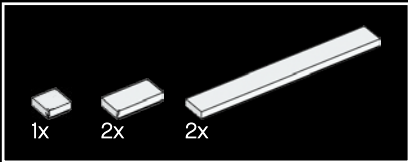
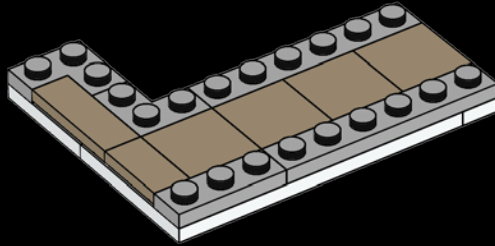

145

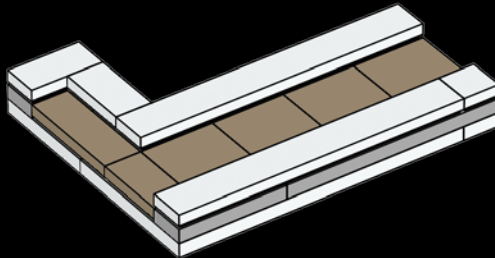

146

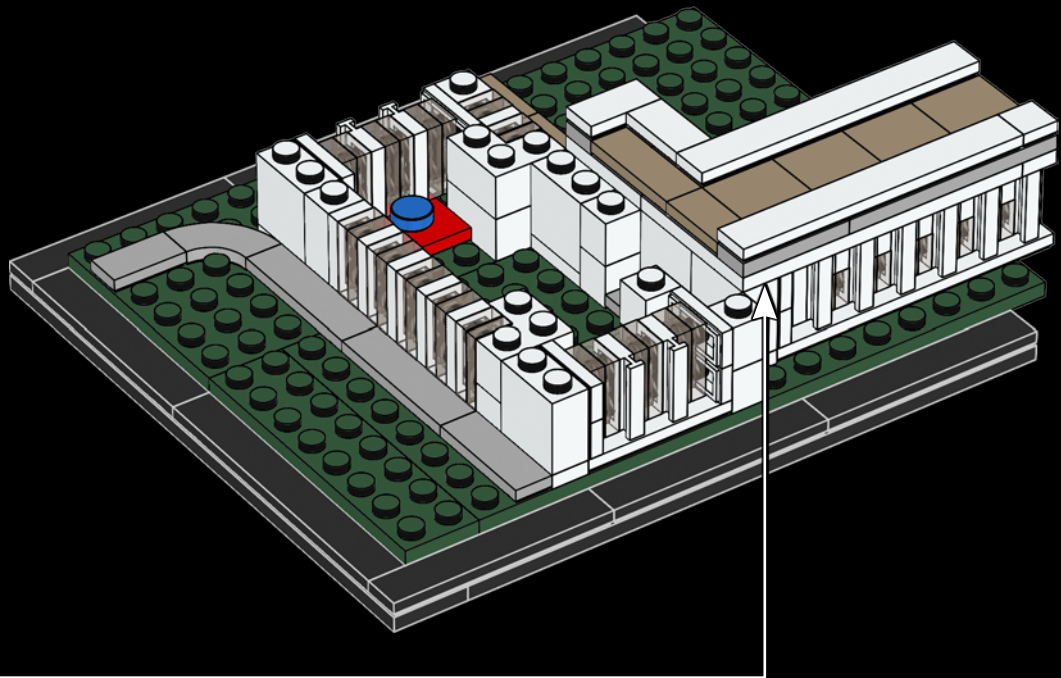

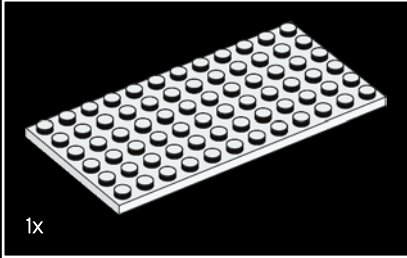
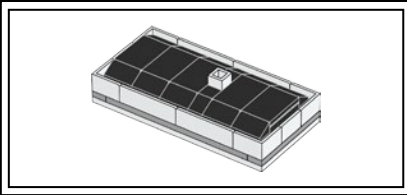

147

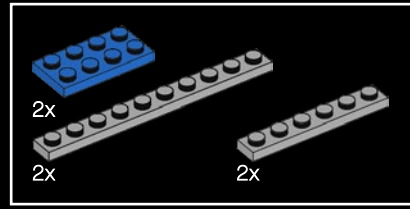
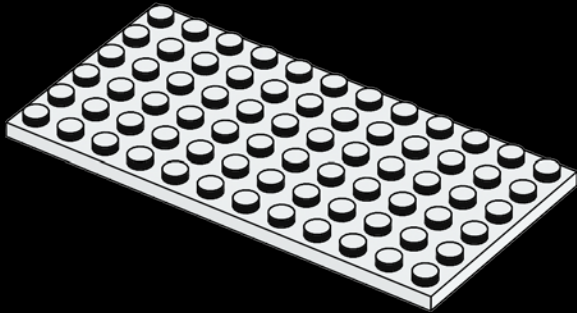

148

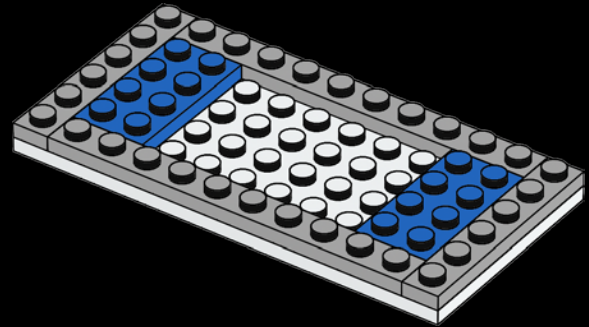

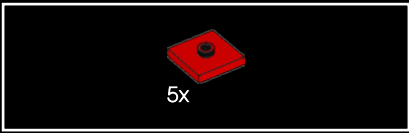

149

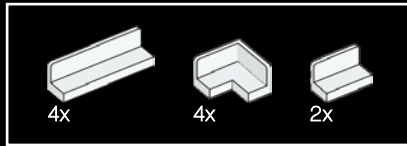
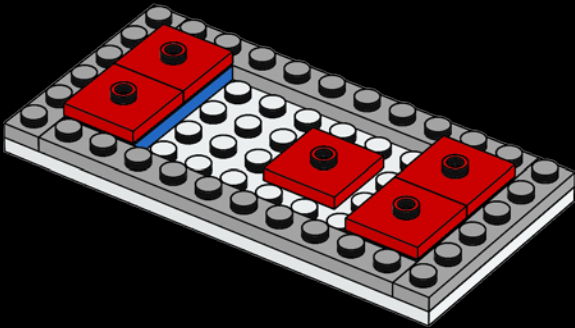

150

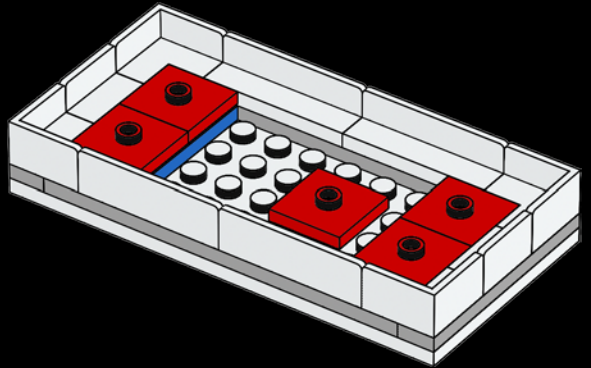



151

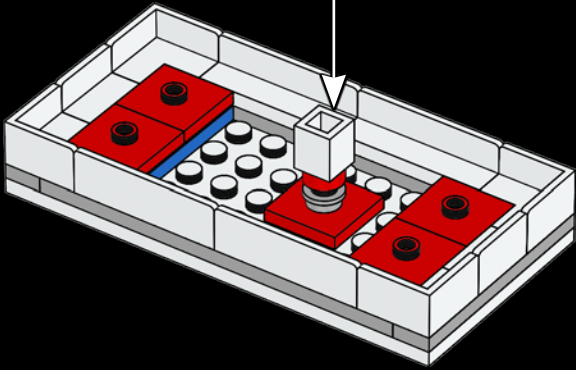
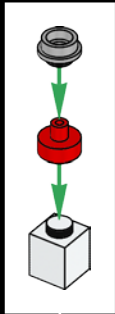

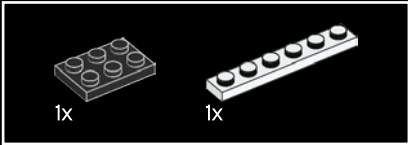
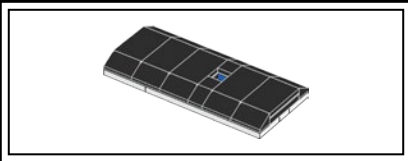

152

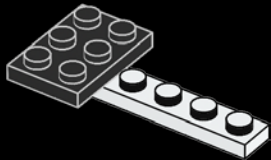

153

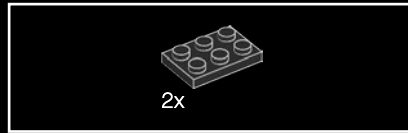
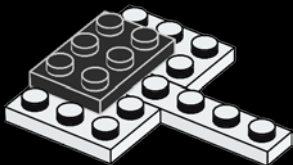

154

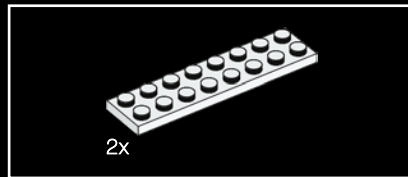
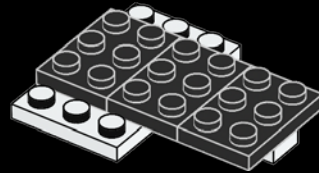

155

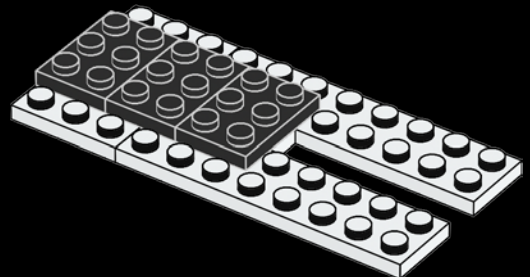

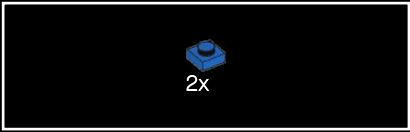

156

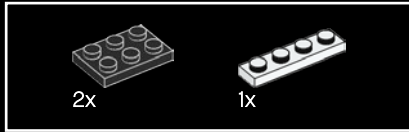
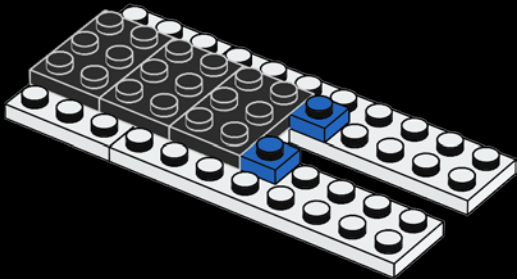

157

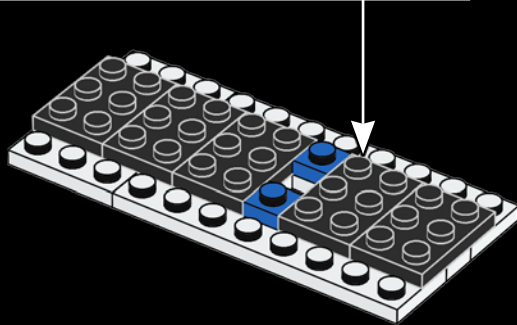
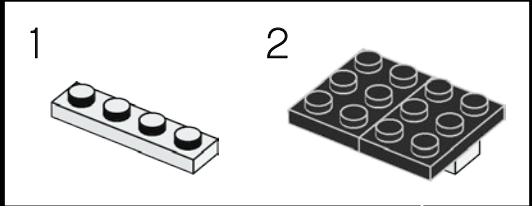

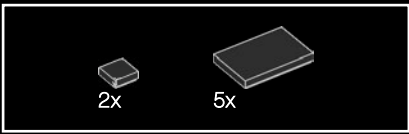

158

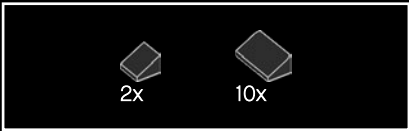
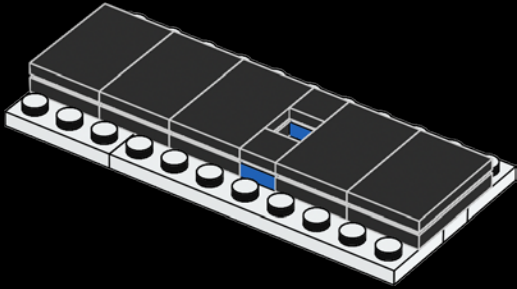

159

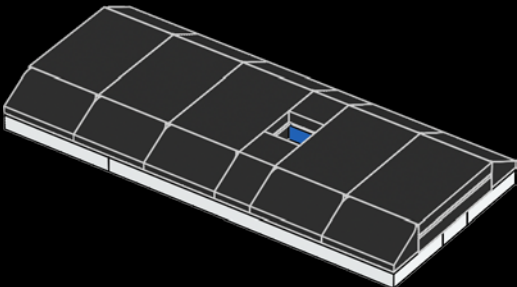

160

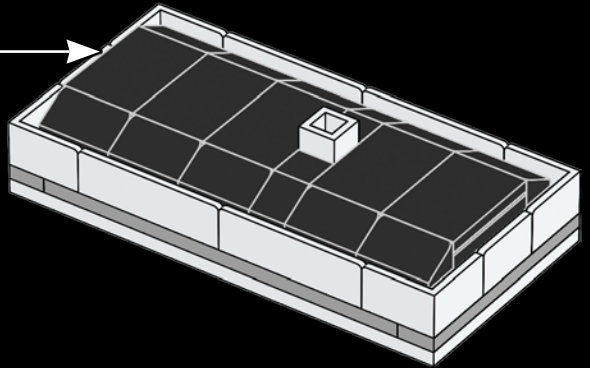

The White House requires 570 gallons (2157 liters) of paint to cover its outside surface



161

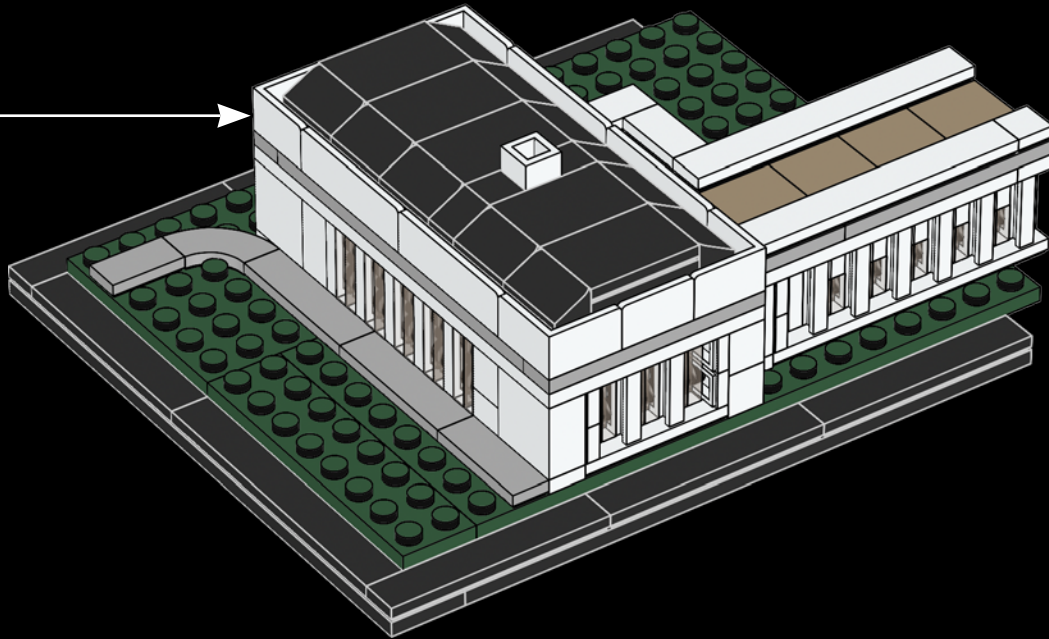



162

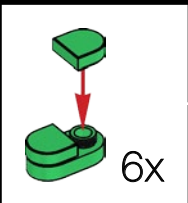
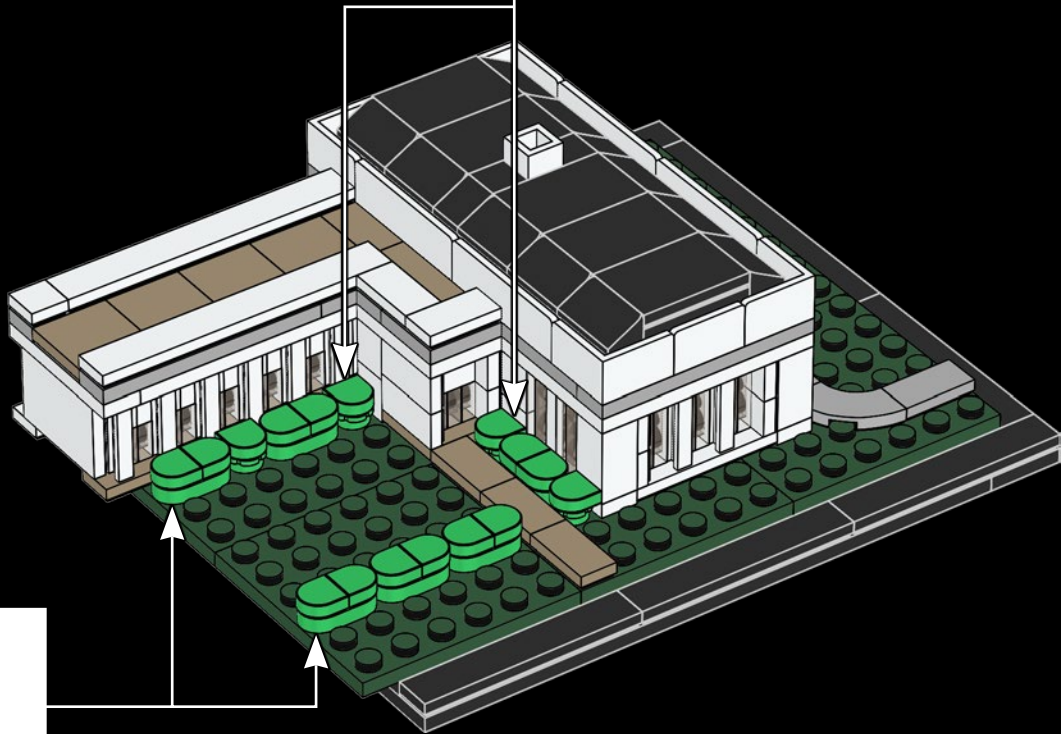
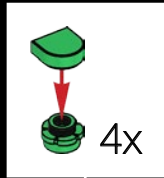



163

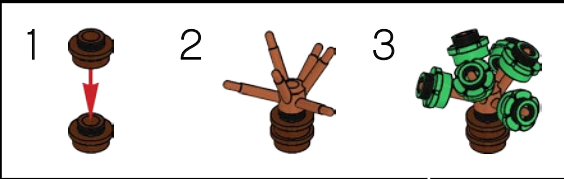

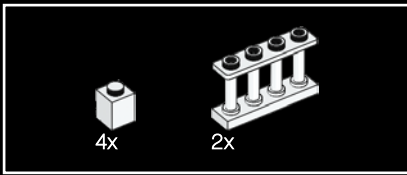

164

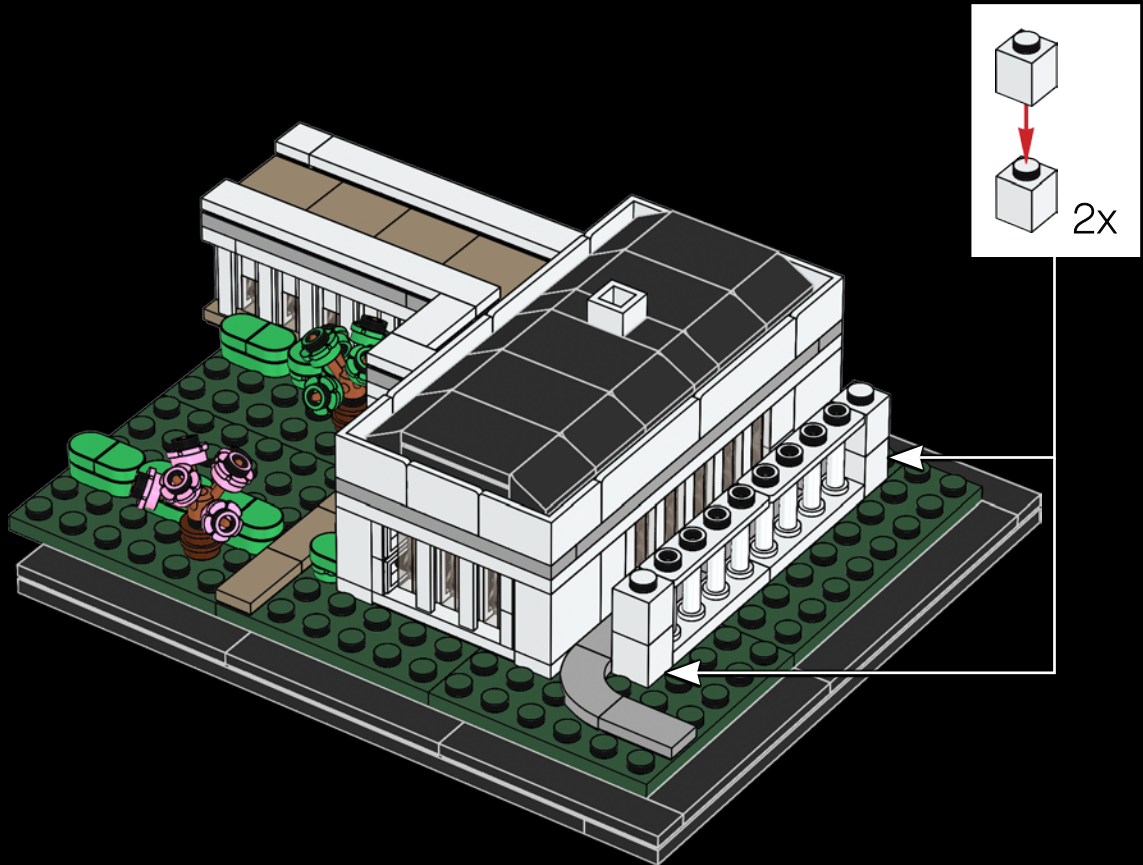

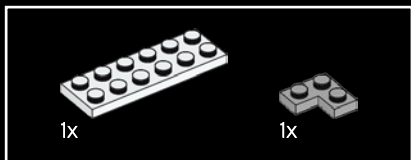

165

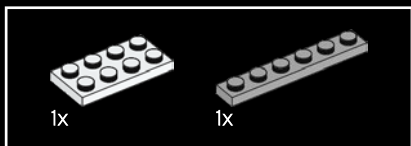
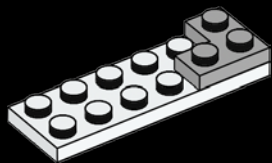

166

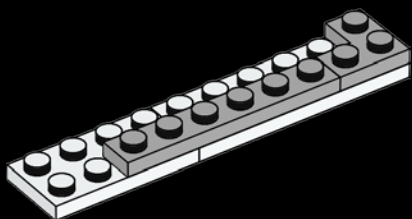

167

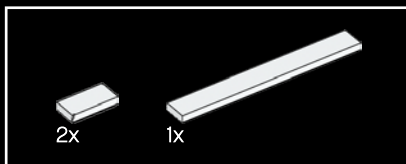
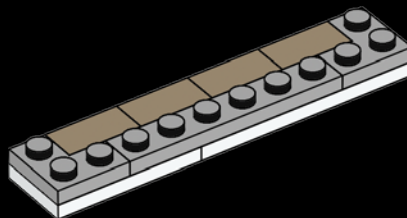

168

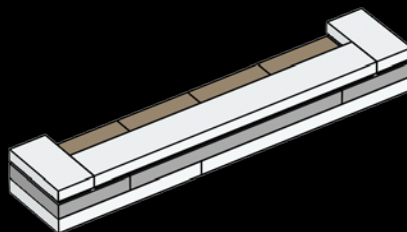

169

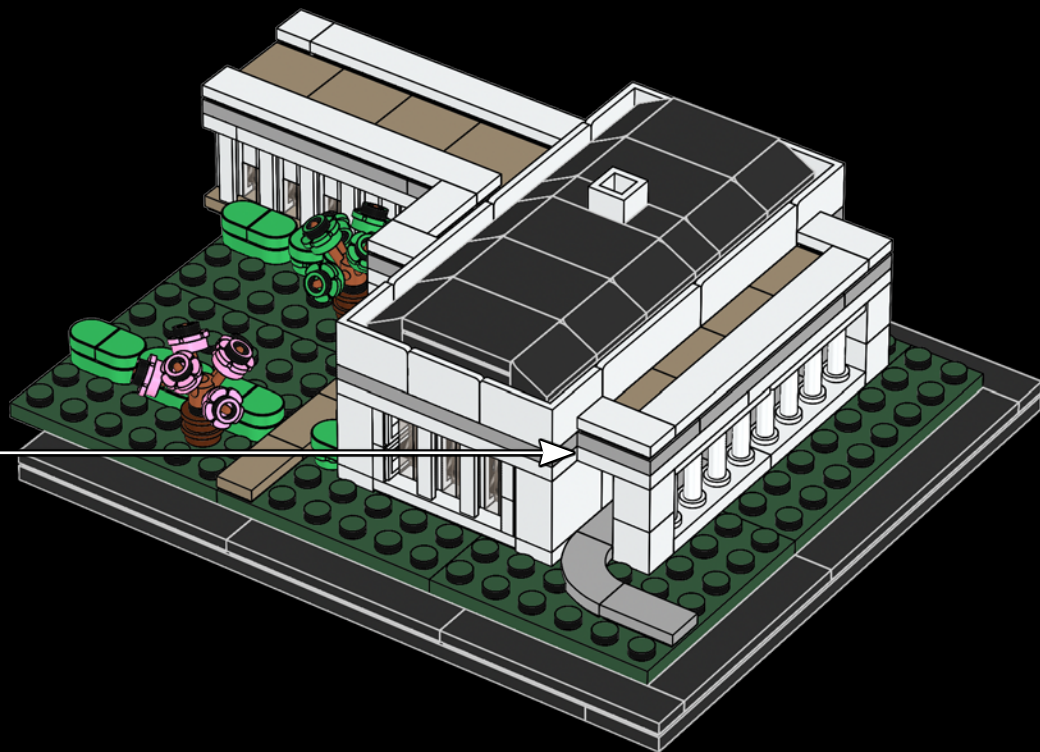

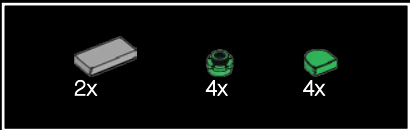

170

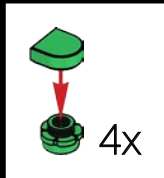
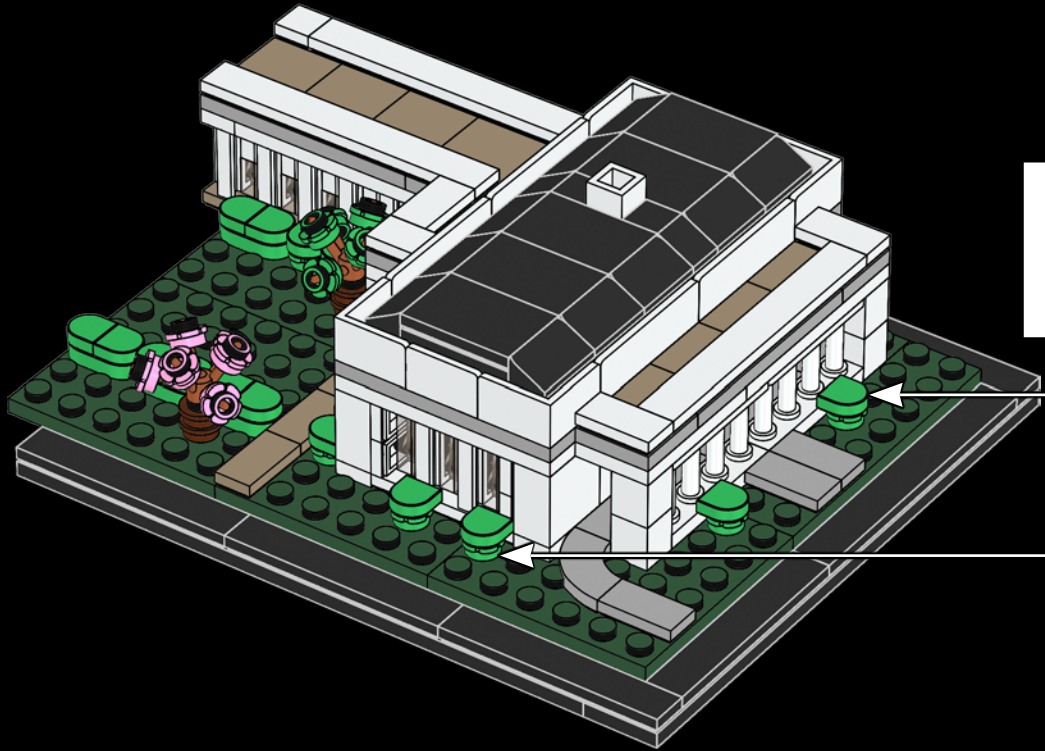

171

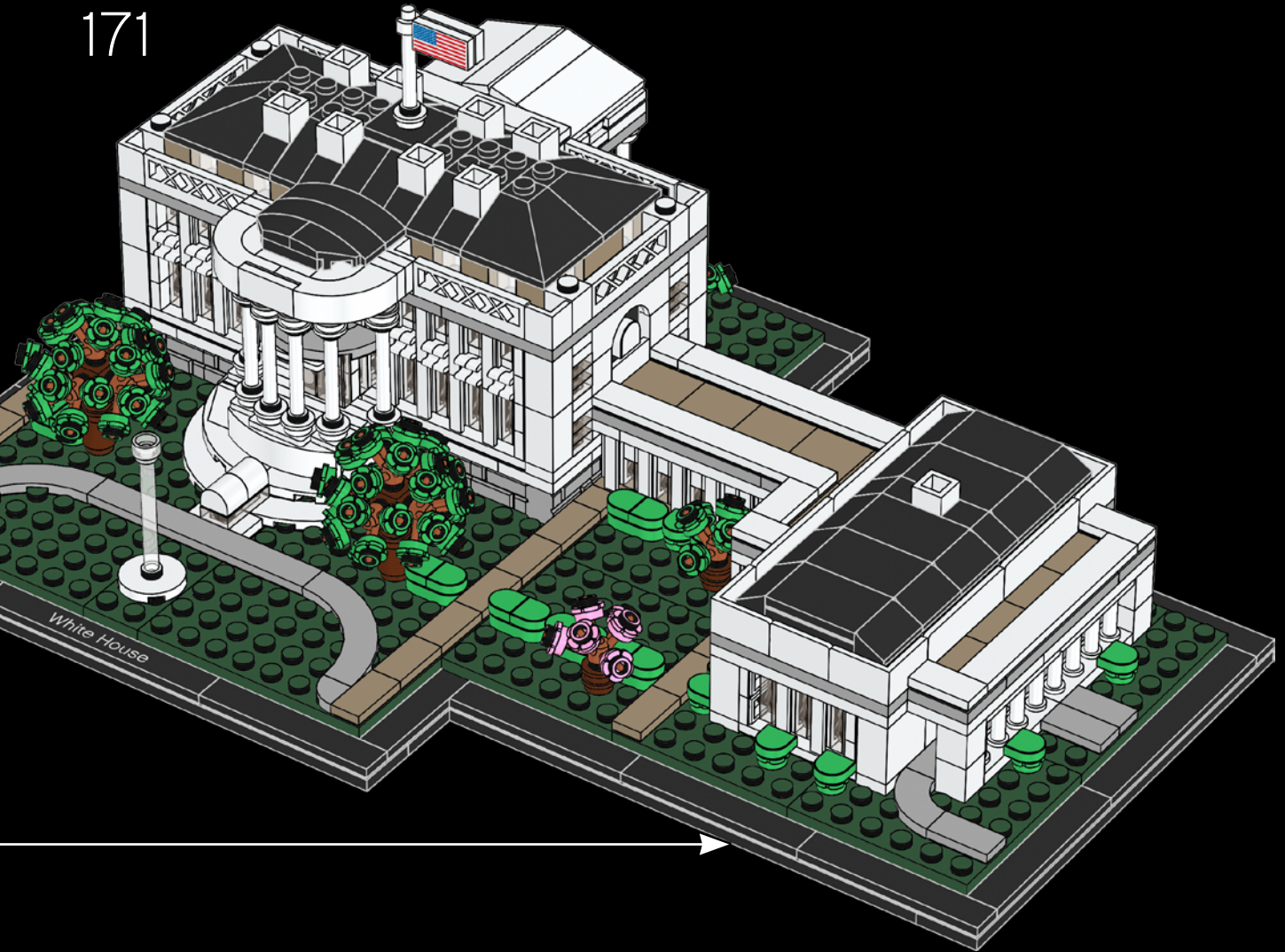

The West Wing



Windows of the Oval Office, the office of the US President, in the West Wing of the White House

It was Thomas Jefferson who first proposed adding one-story extensions east and west of the presidential mansion. A century later William Howard Taft officially moved the president's working room to the West Wing, creating the Oval Office we know today. It's from here the president addresses the American public on TV and where he confers with staff and visiting heads of state.



White House and the Executive Offices of the newly renovated West Wing. Feb. 8, 1938.



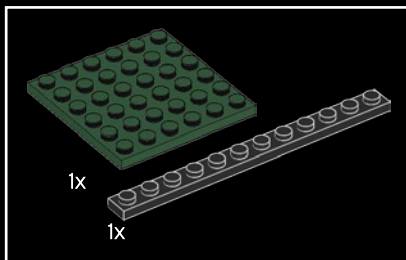
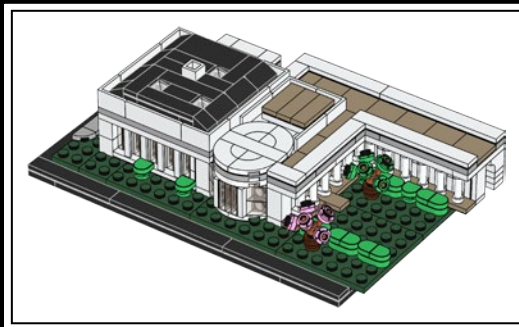
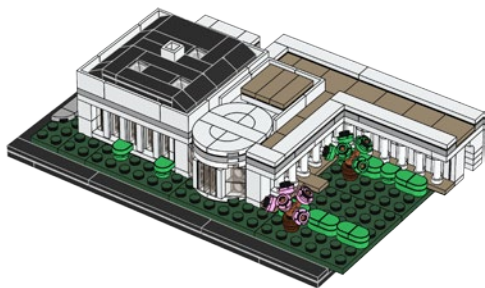
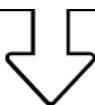

172

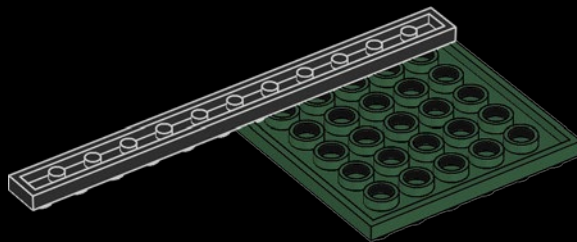

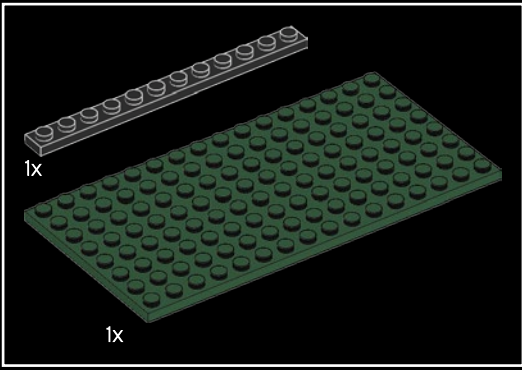

173

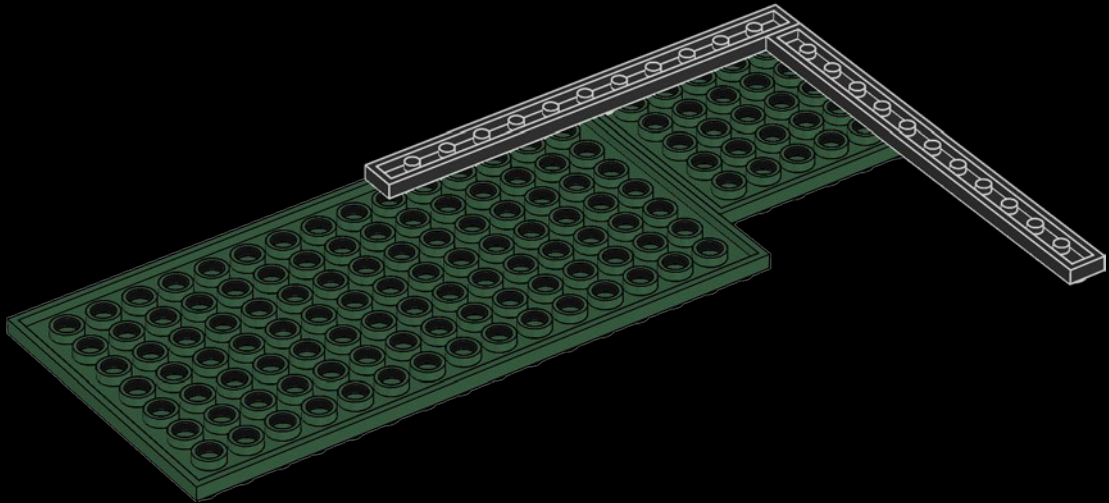

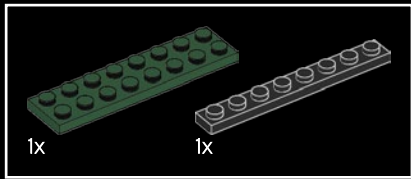

174

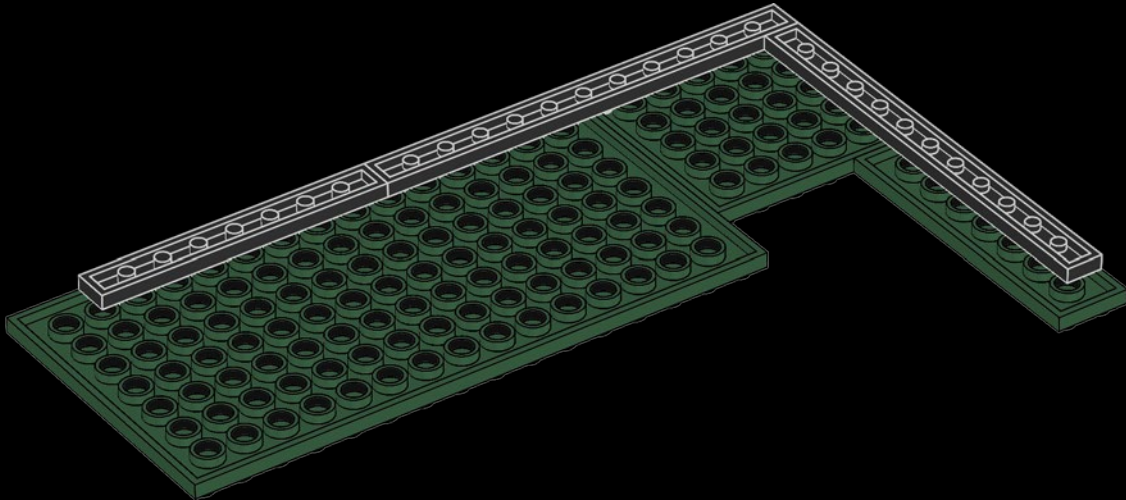

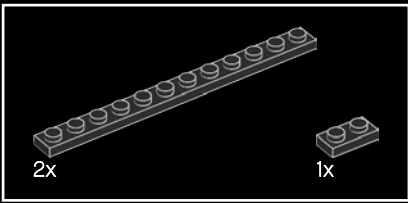

175

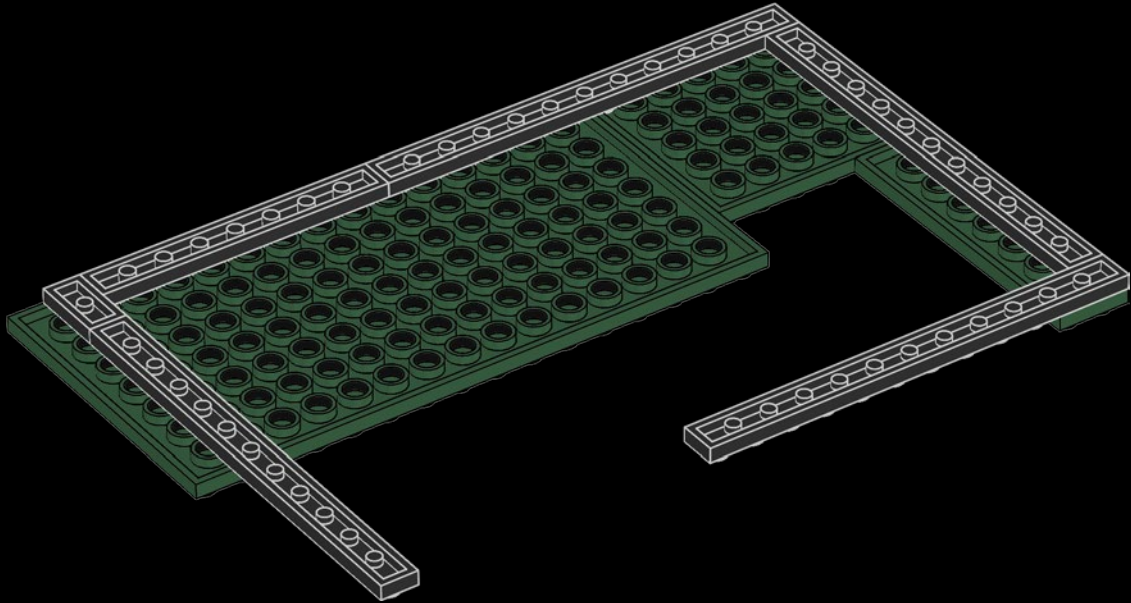

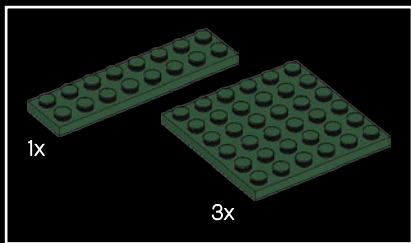

176

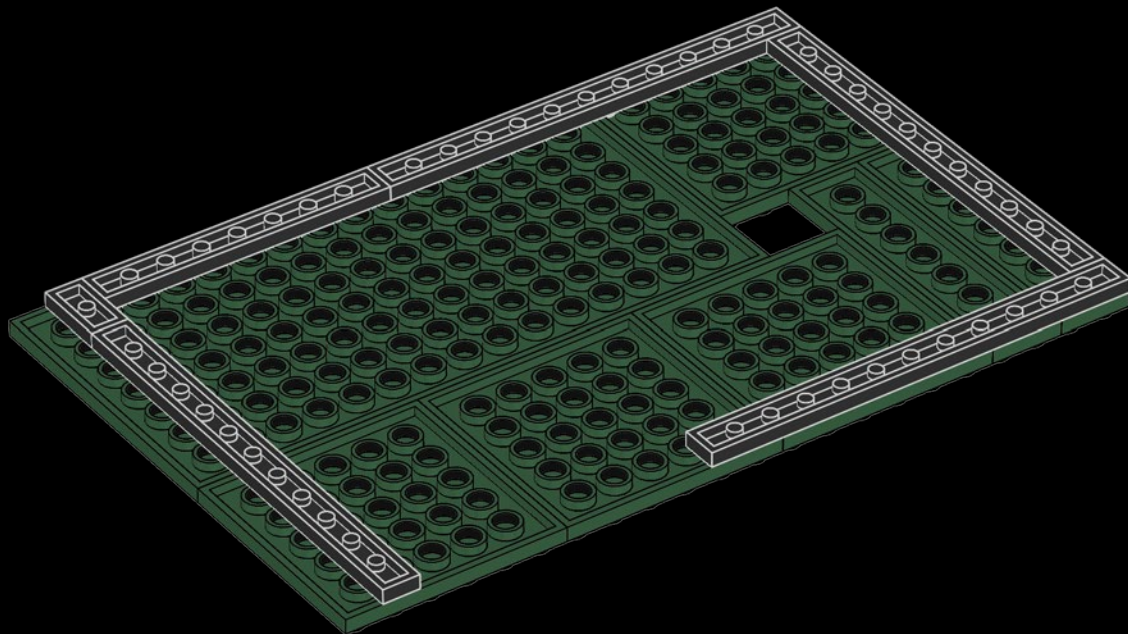

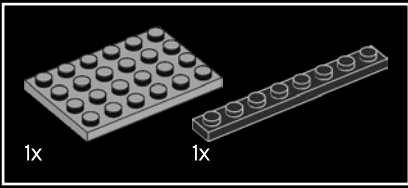

177

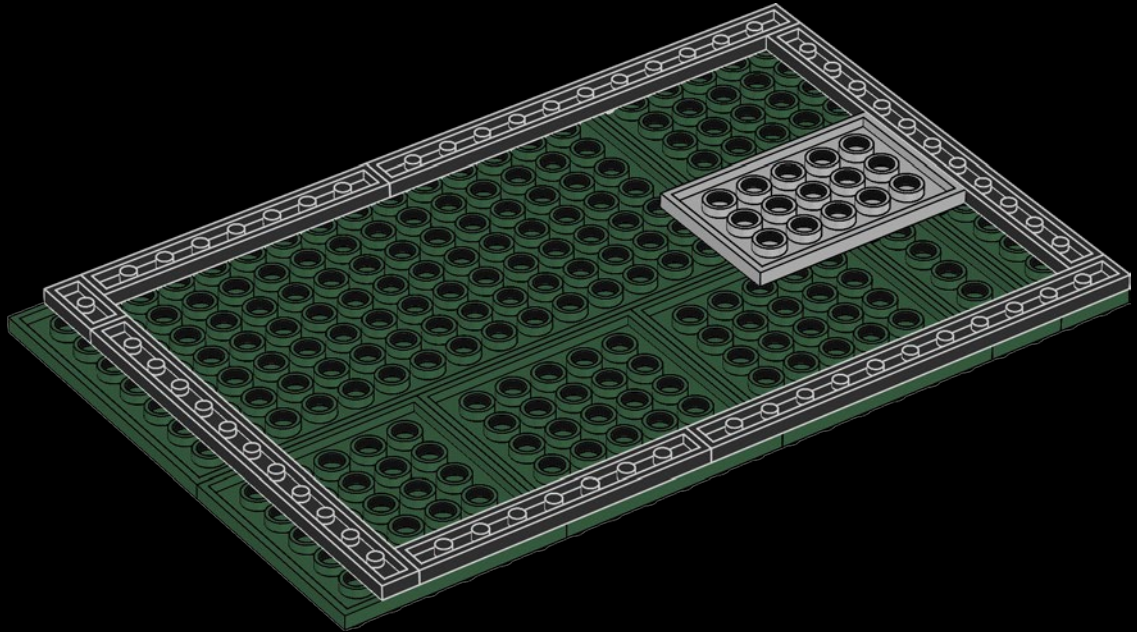

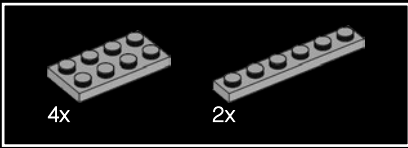

178

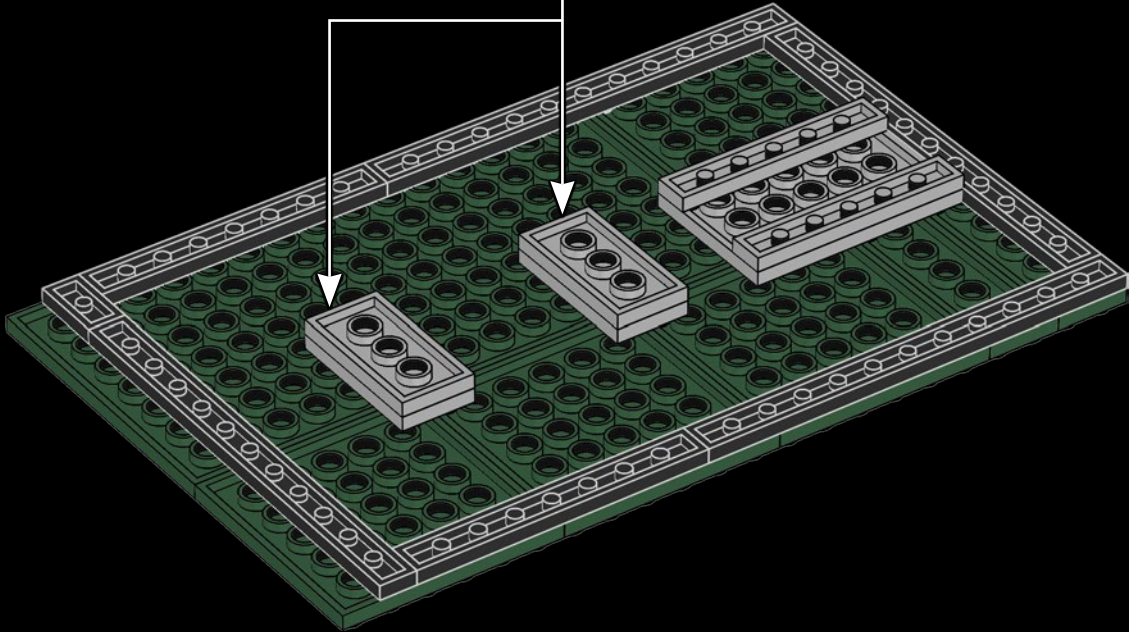
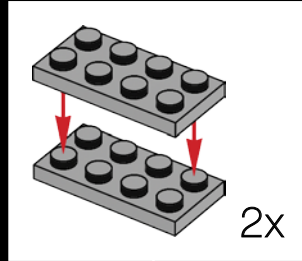

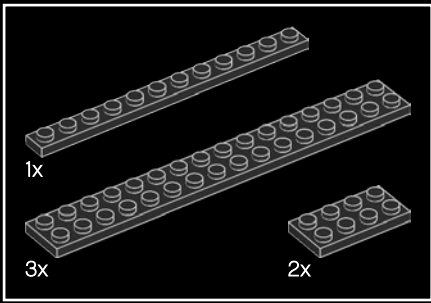

179

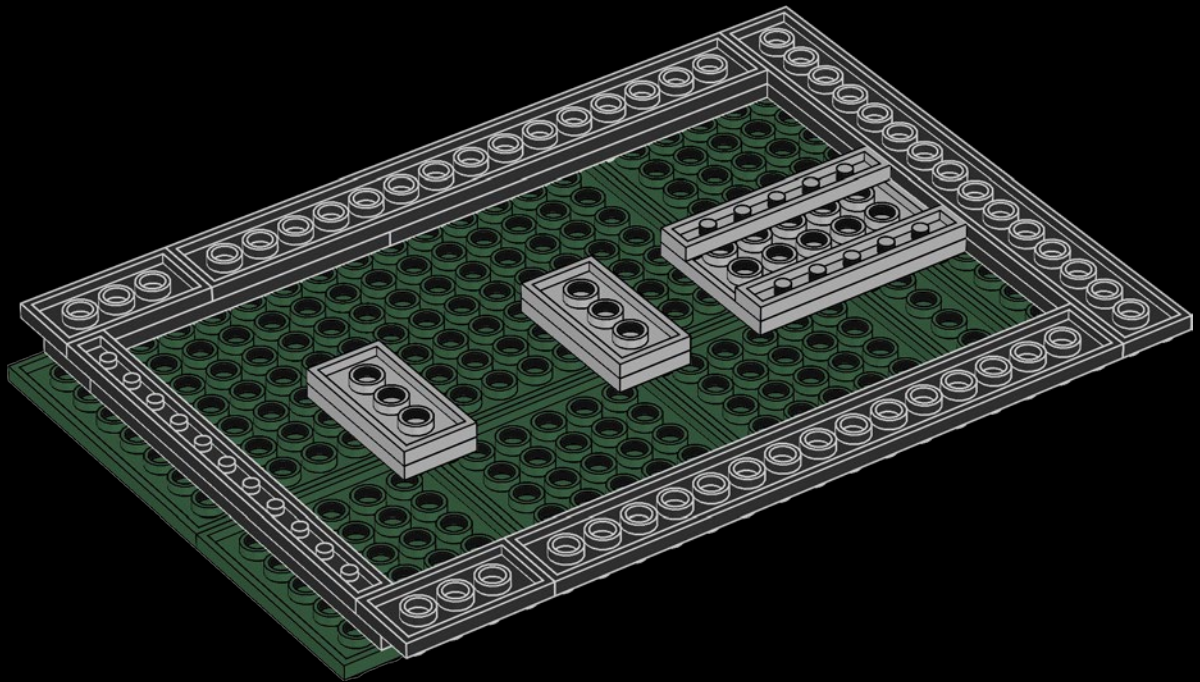

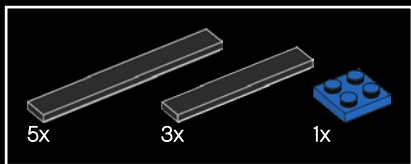

180

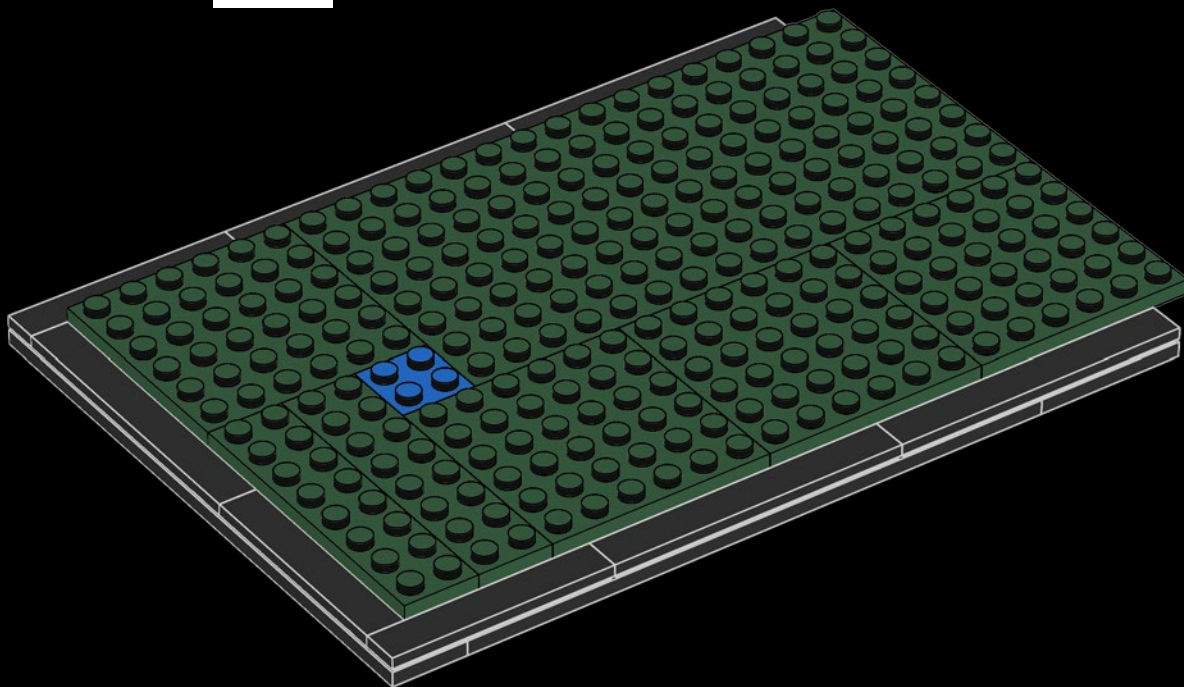

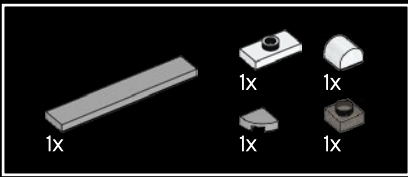

181

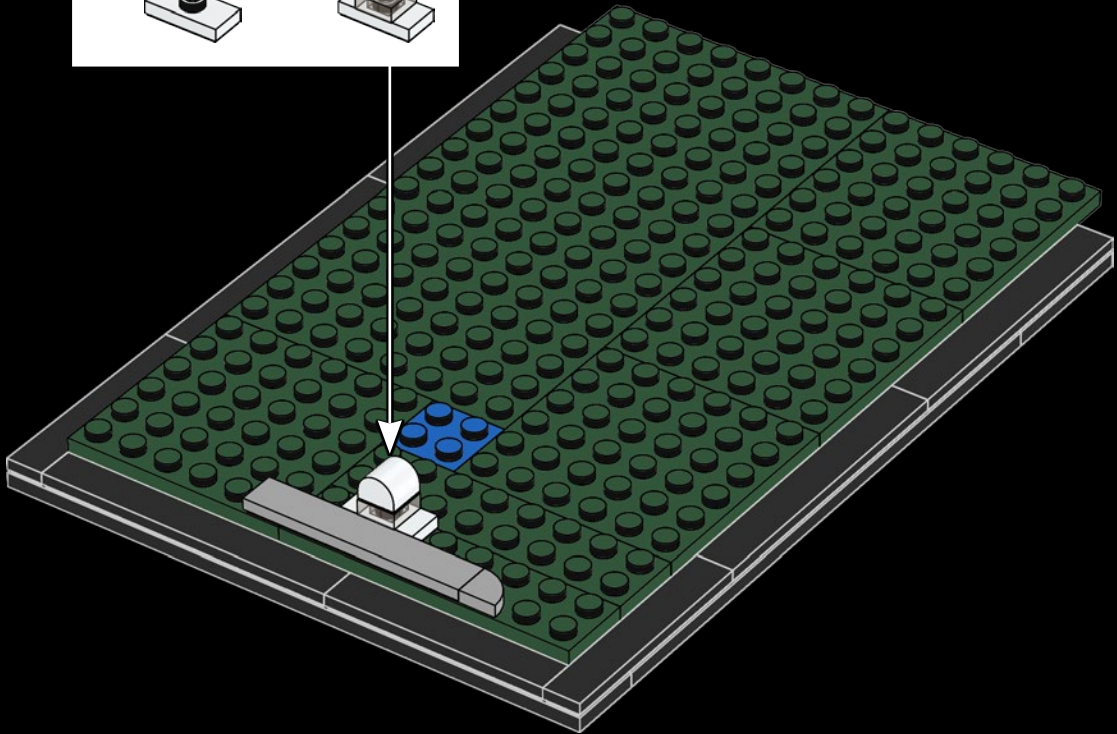
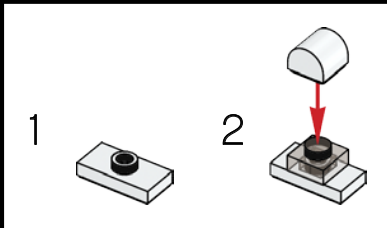

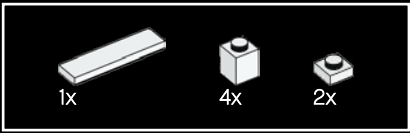

182

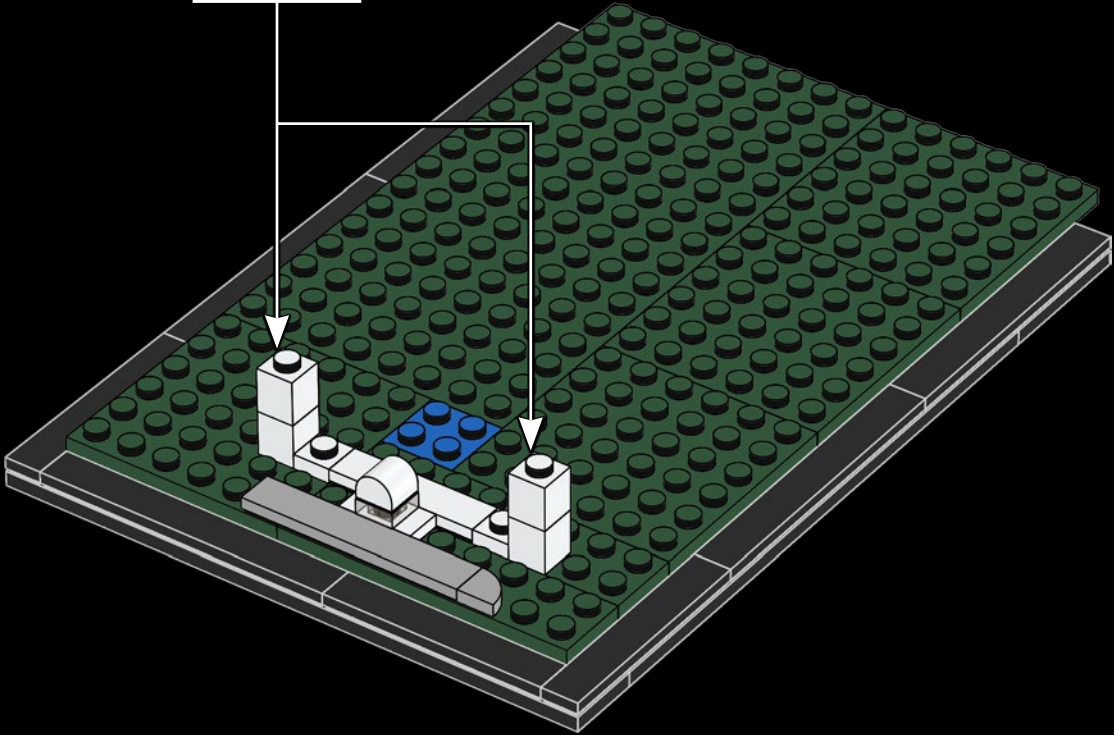
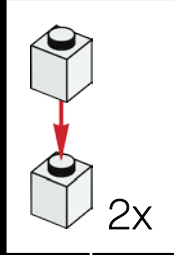

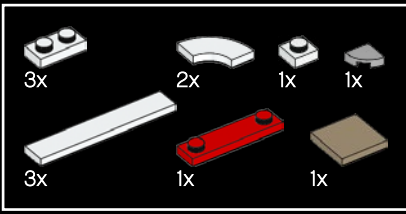

183

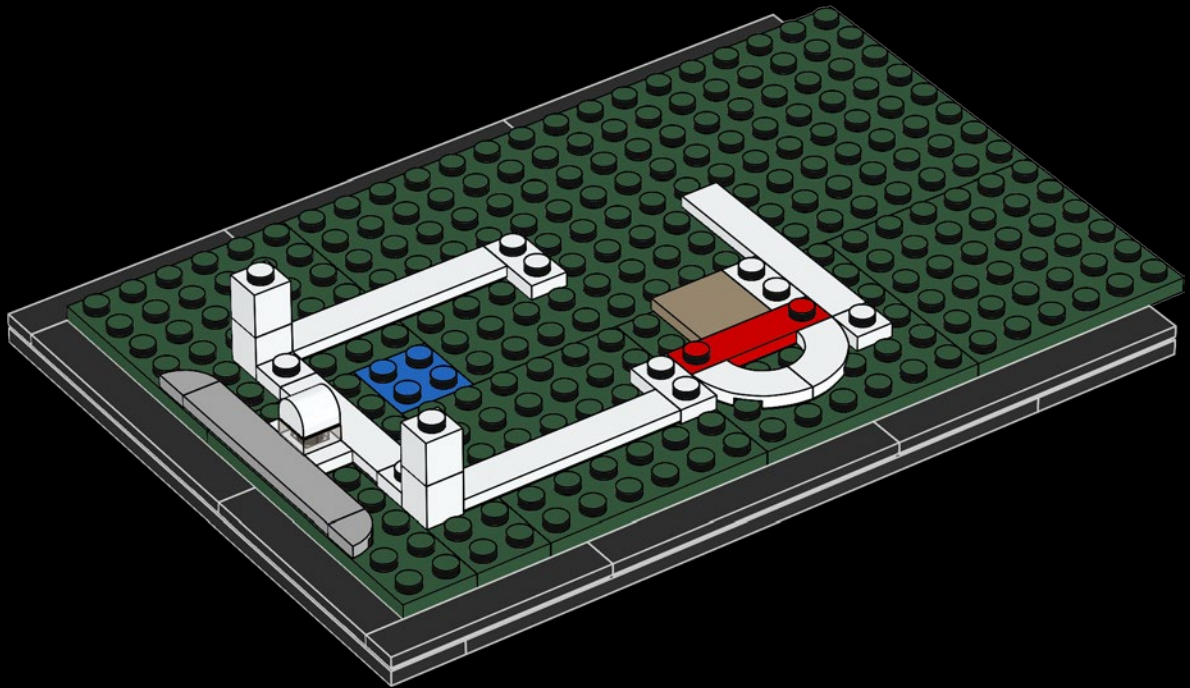

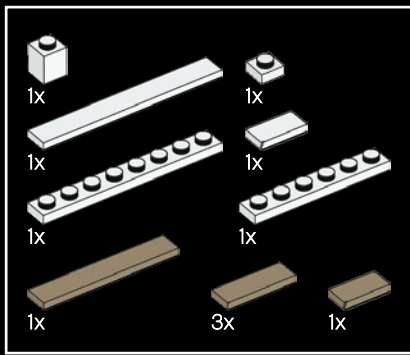

184

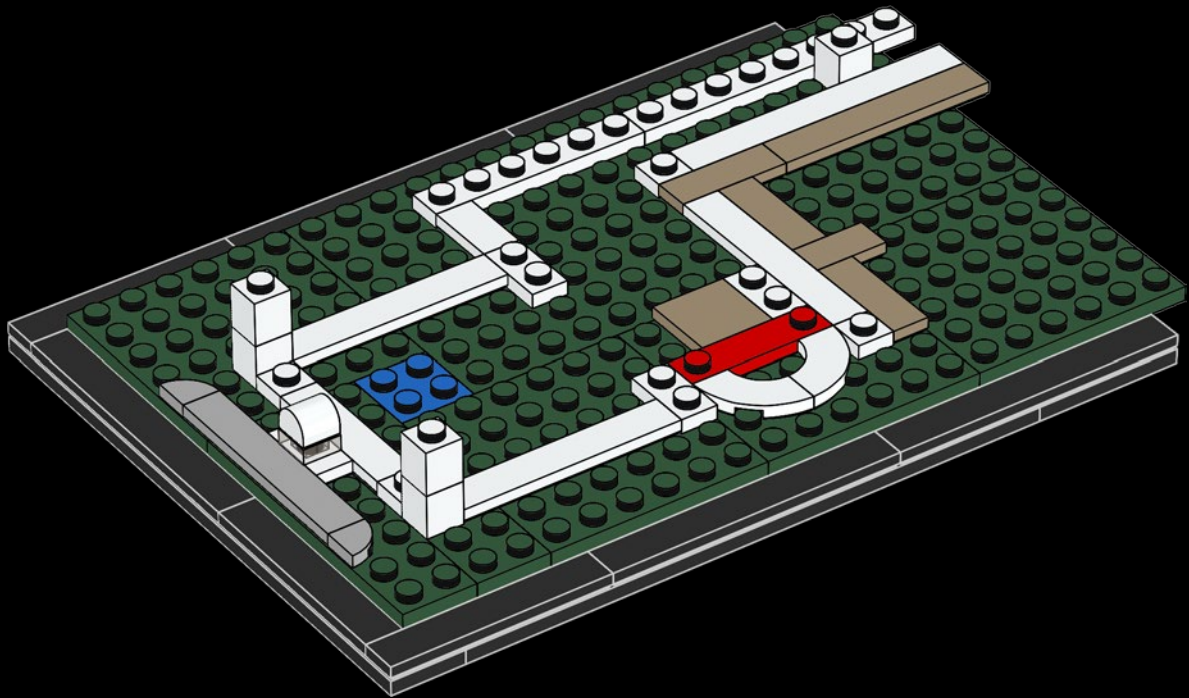



14x

185



7x

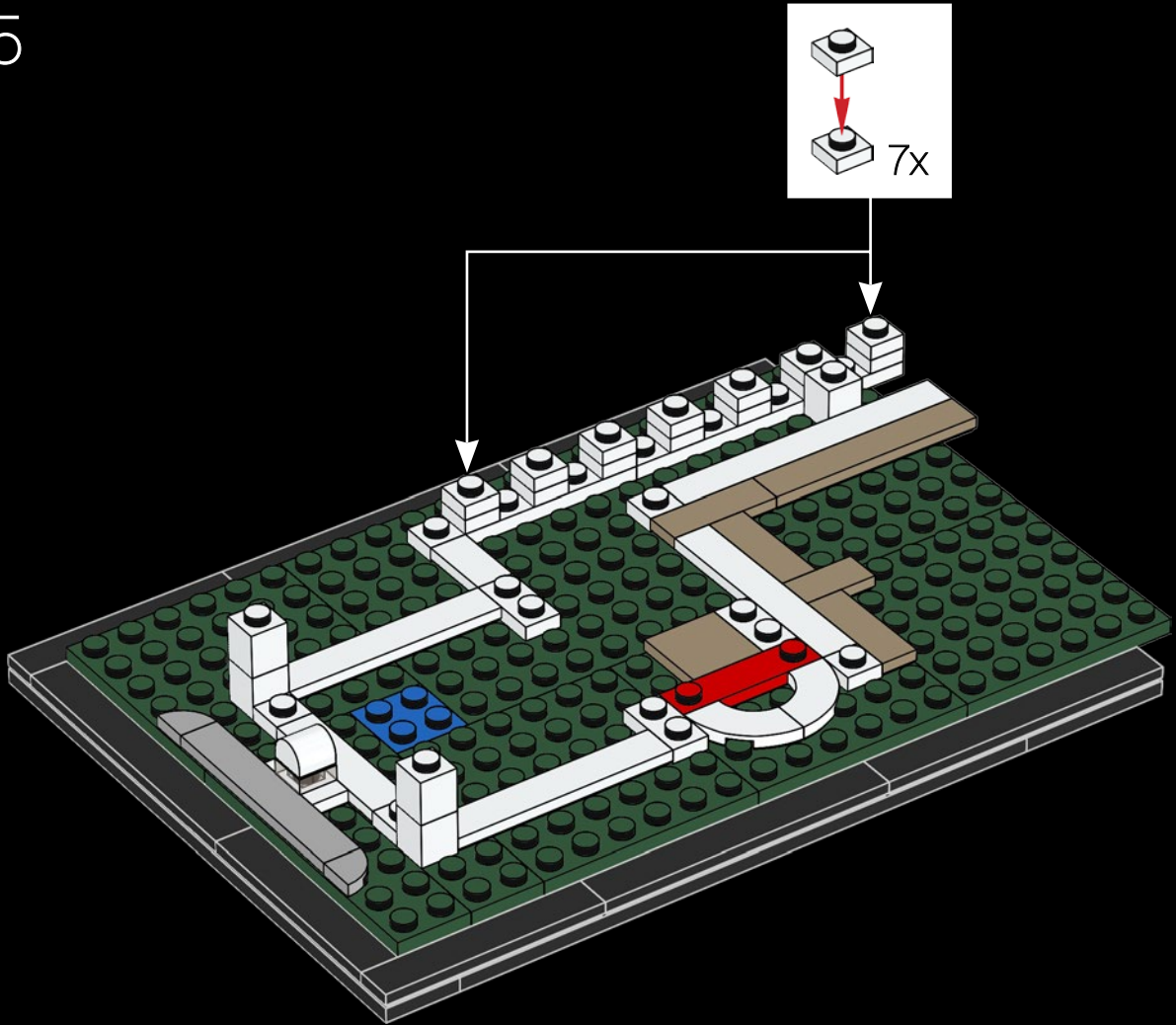



186

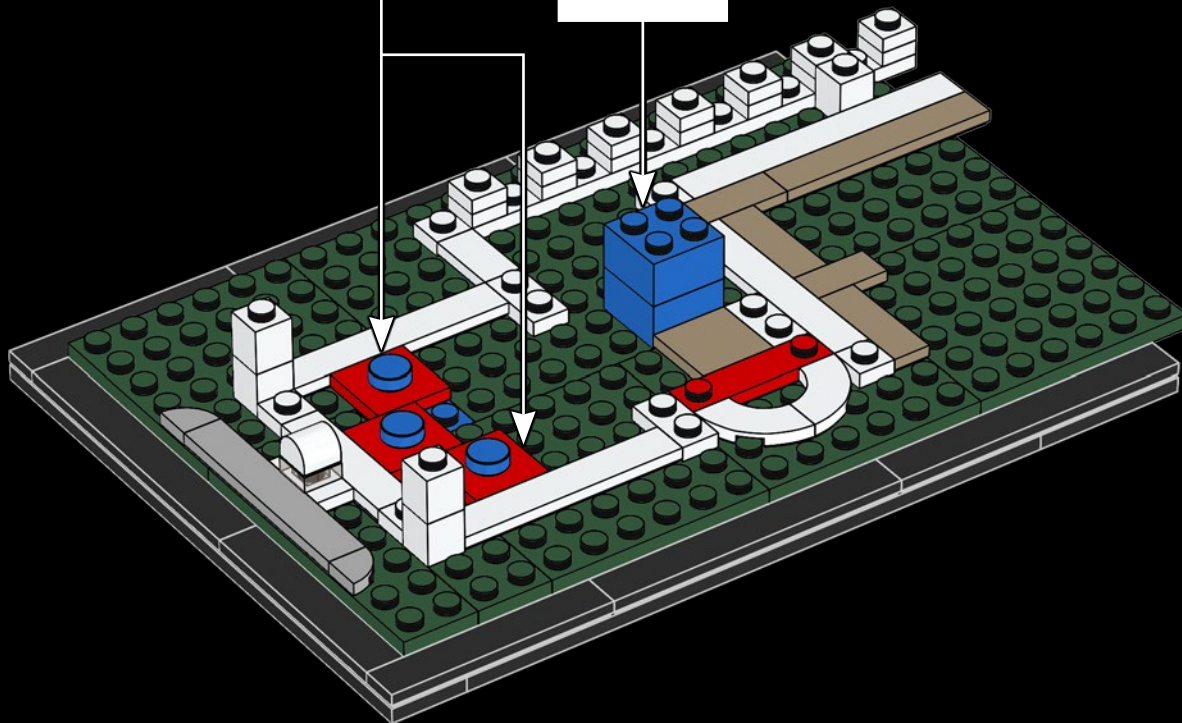
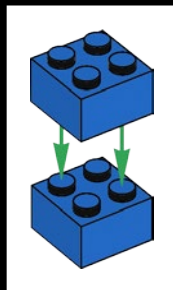
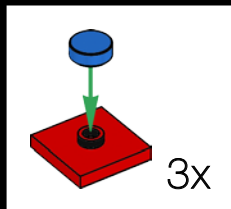



187

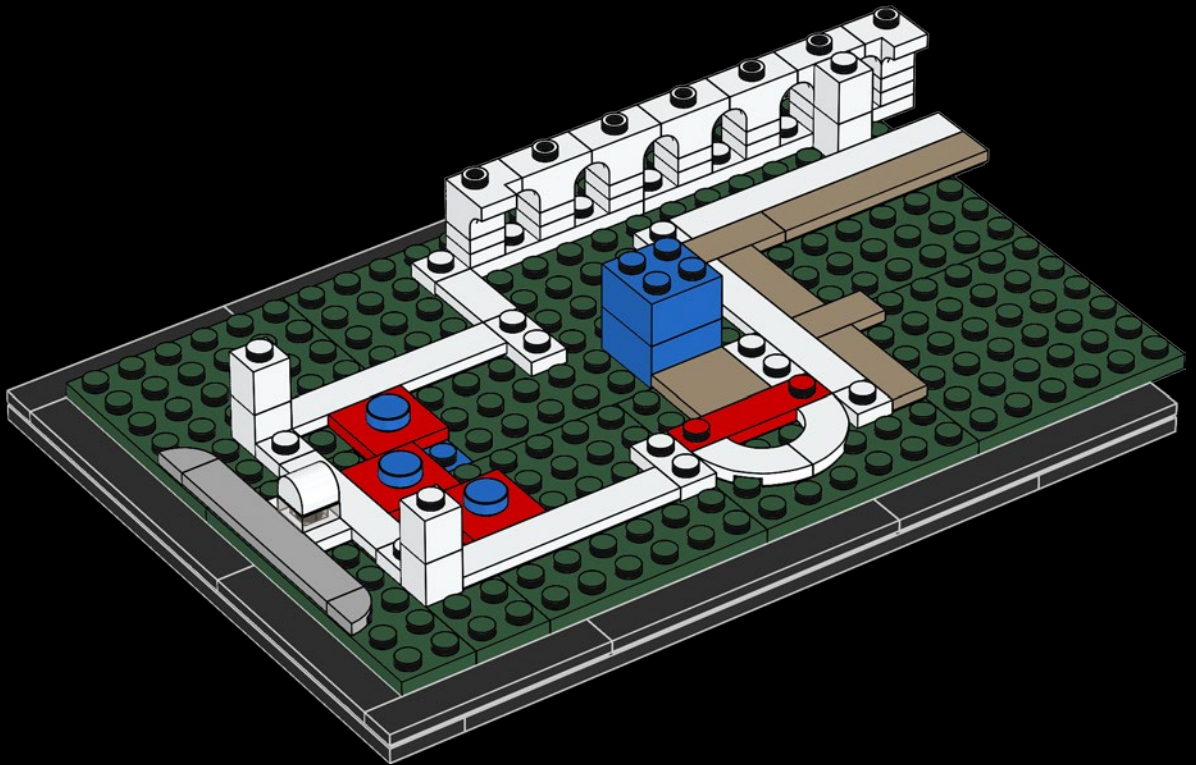



188

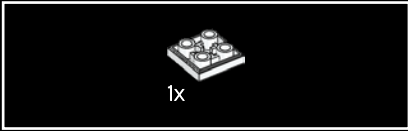
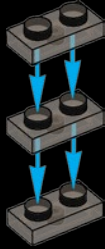

189

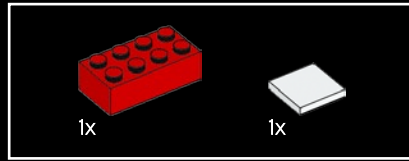
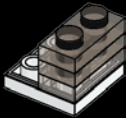

190

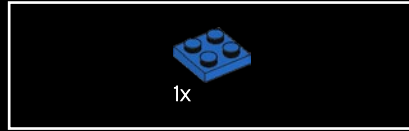
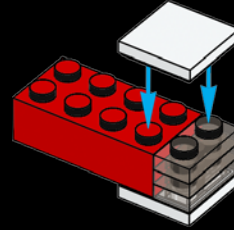

191

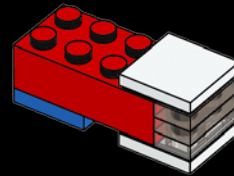

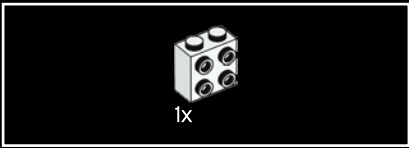

192

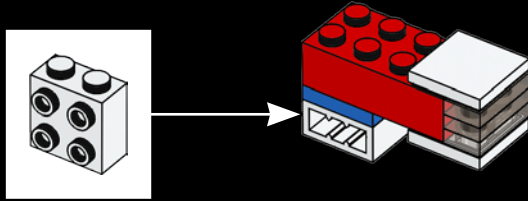

193

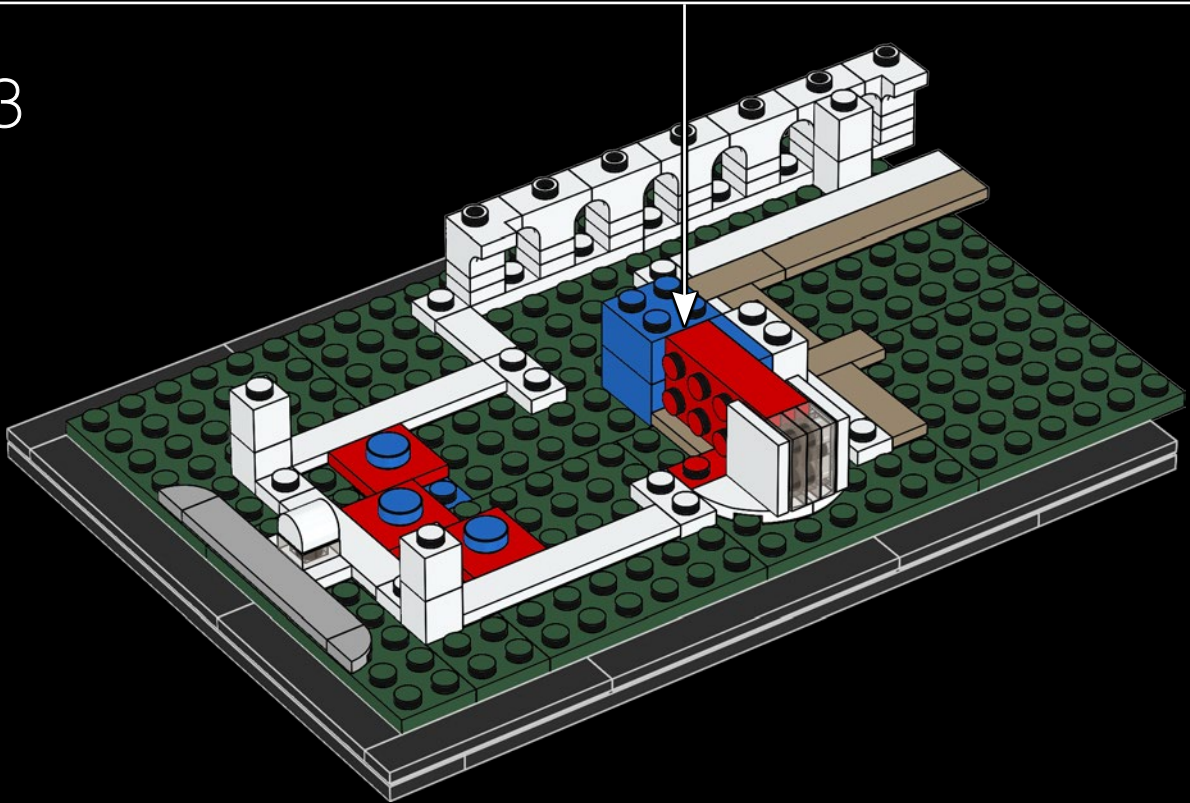



194

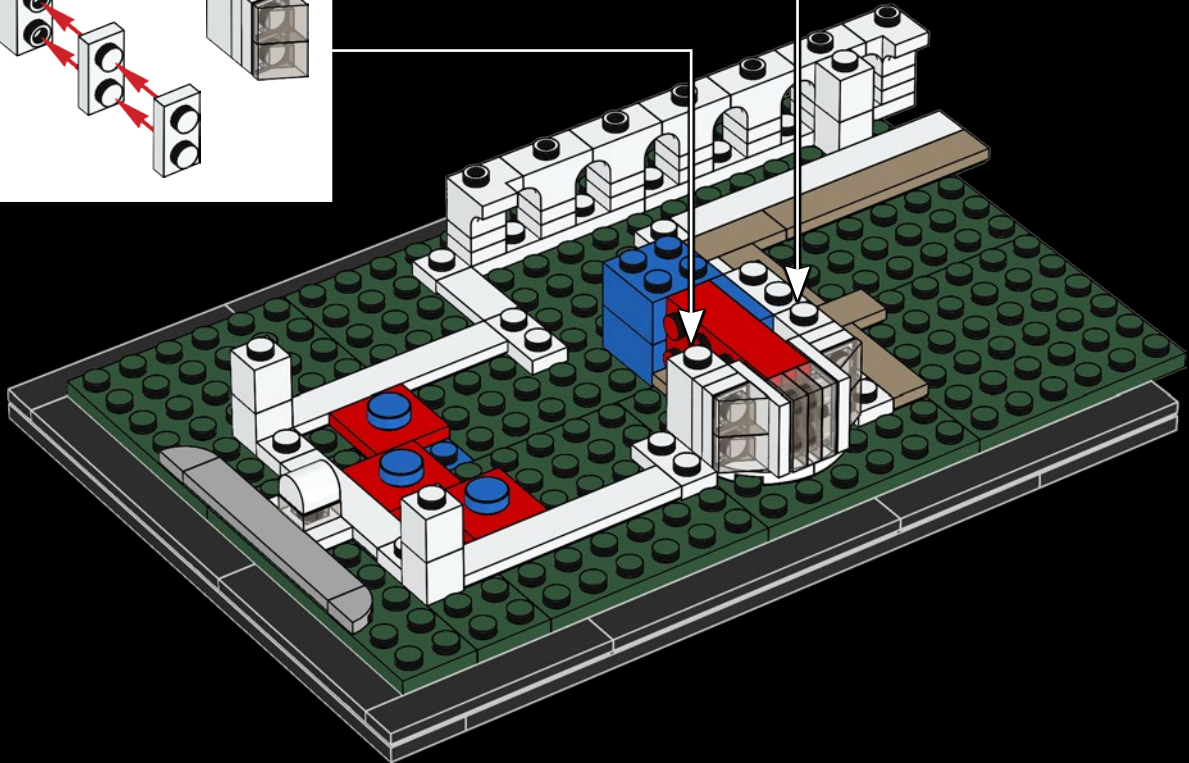
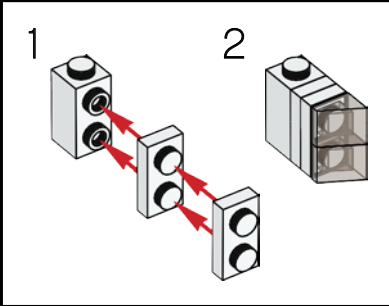
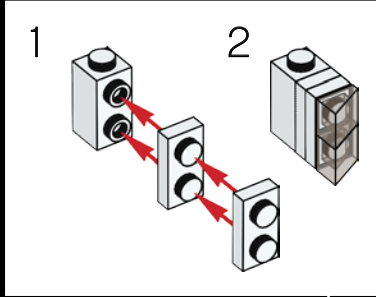

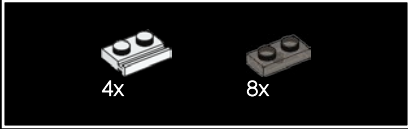

195

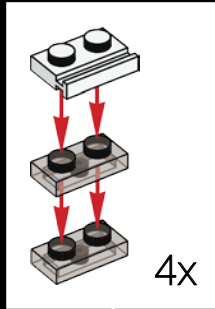

196



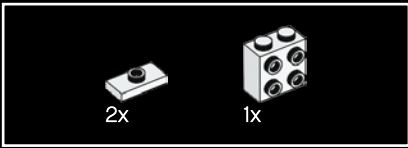

197

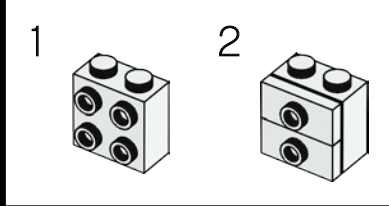

198

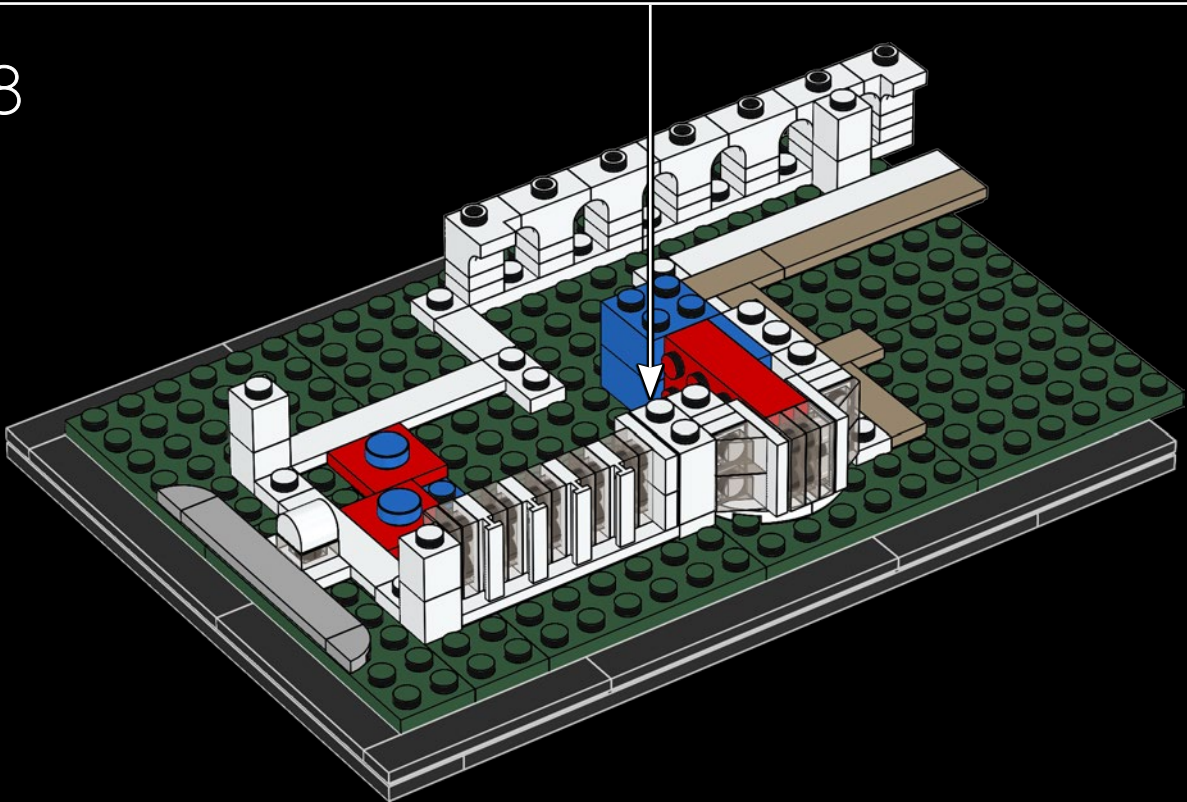

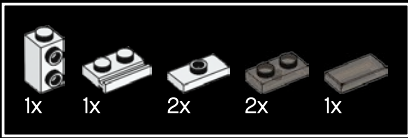

199

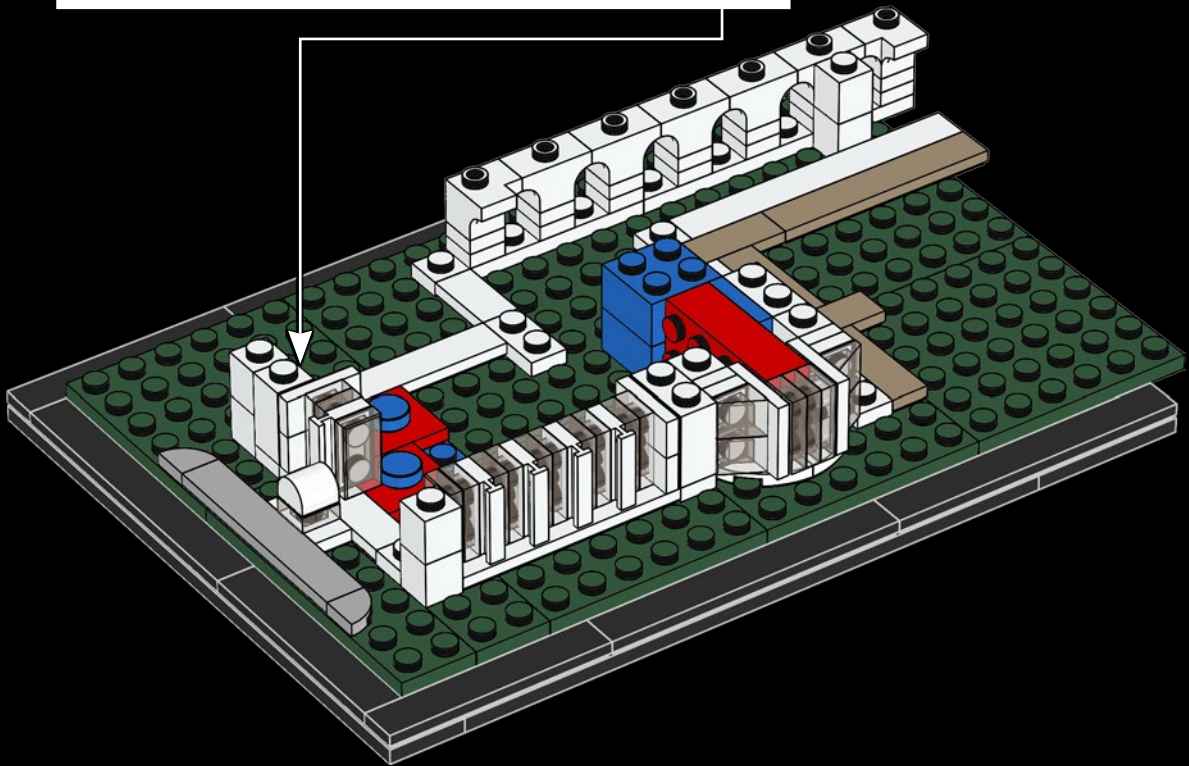
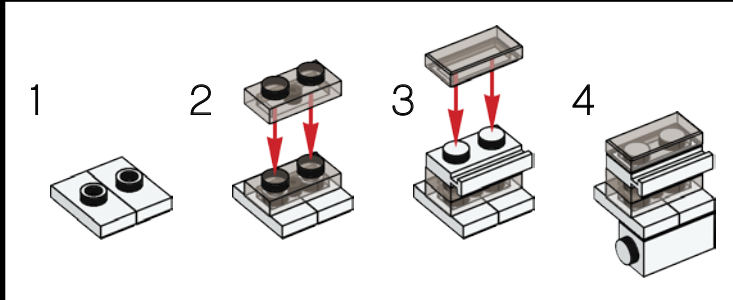

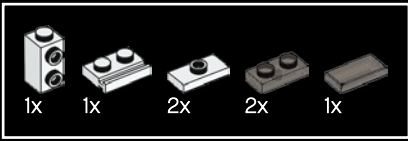

200

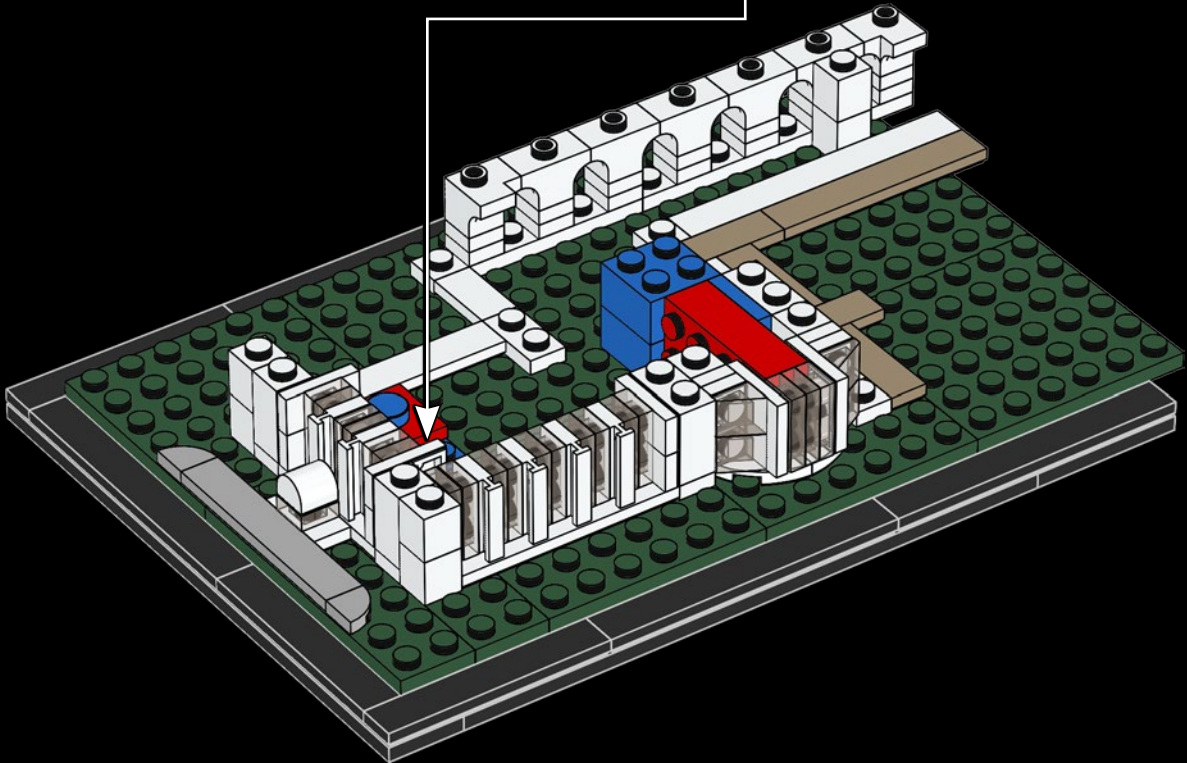
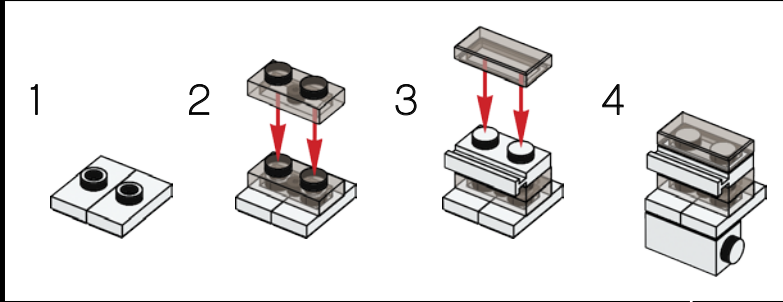



201

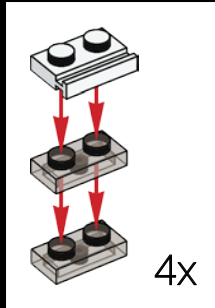

202



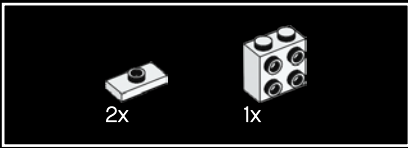

203

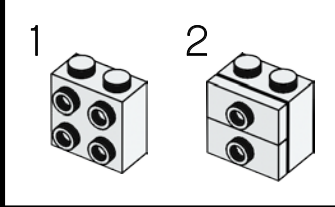

204

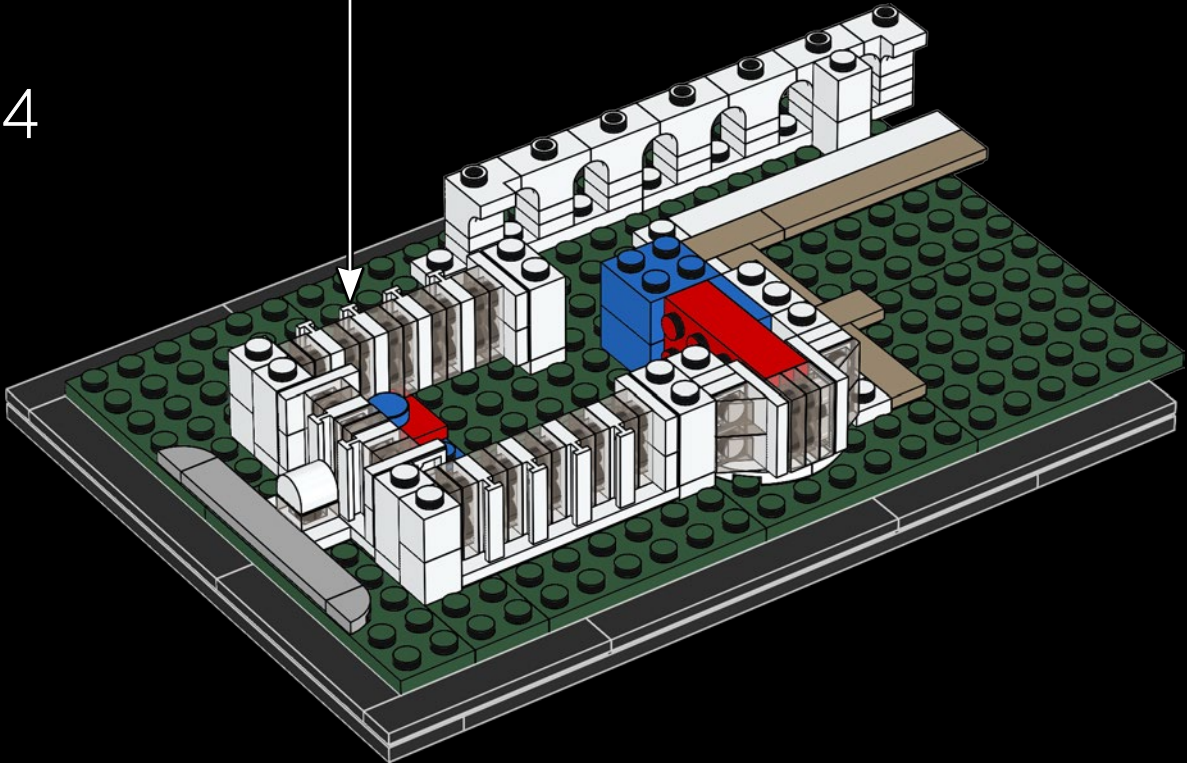

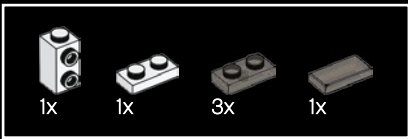

205

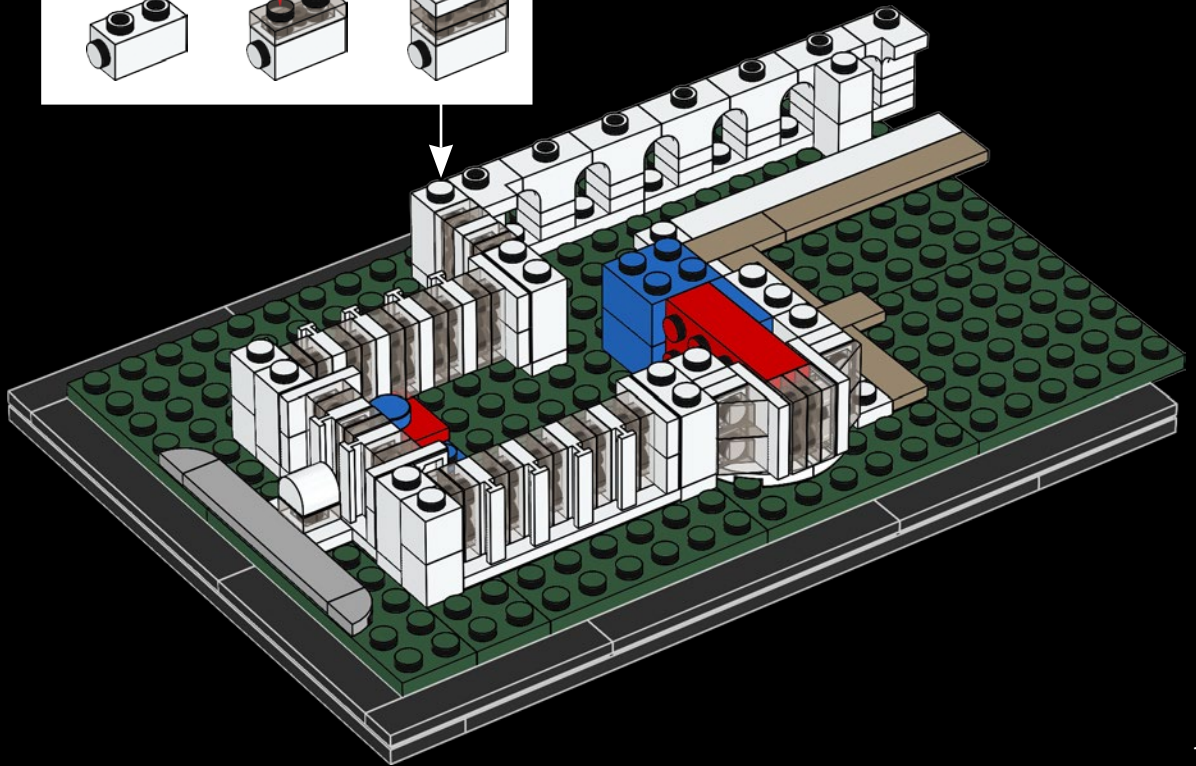
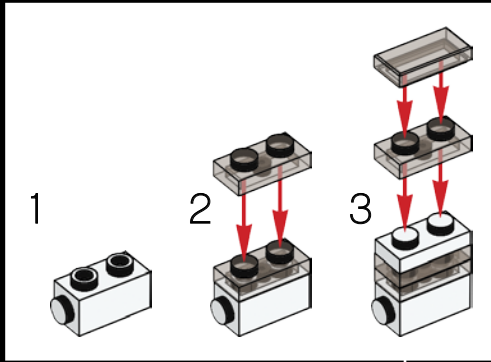



206

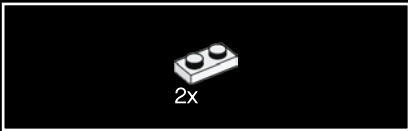
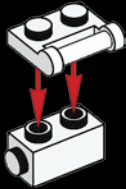

207

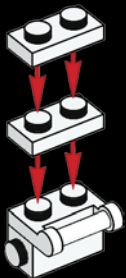

208

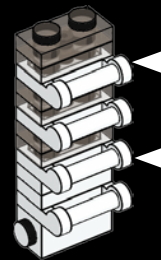
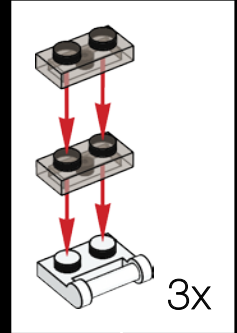

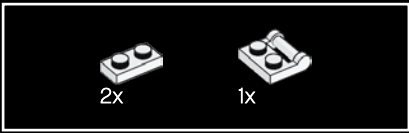

209

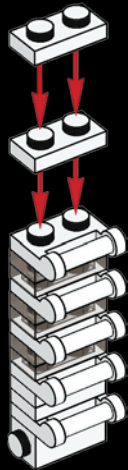

210



The White House receives approximately
6,000 visitors a day



211

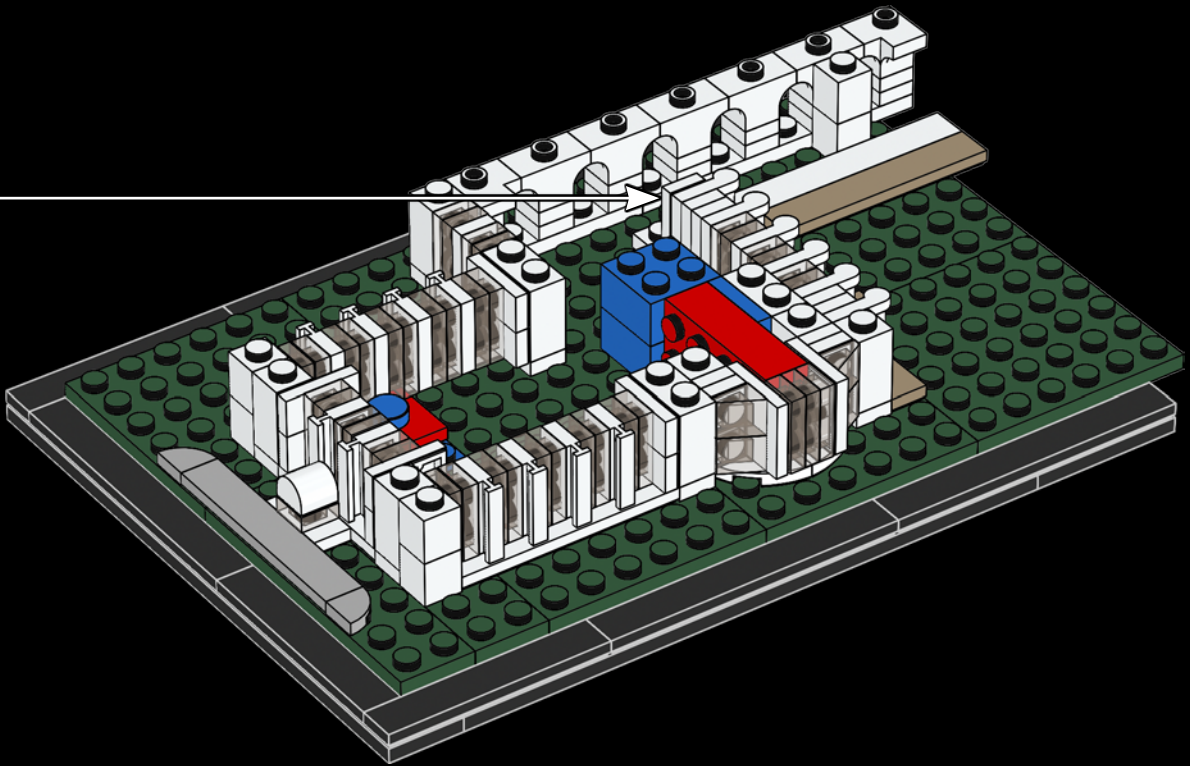

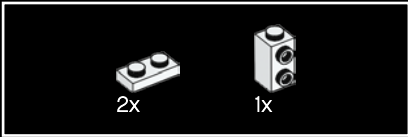
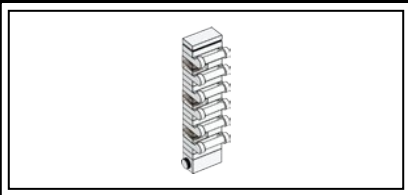

212

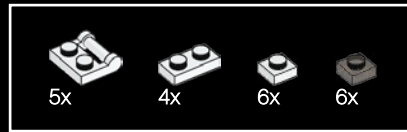
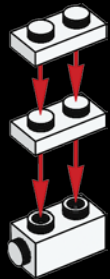

213

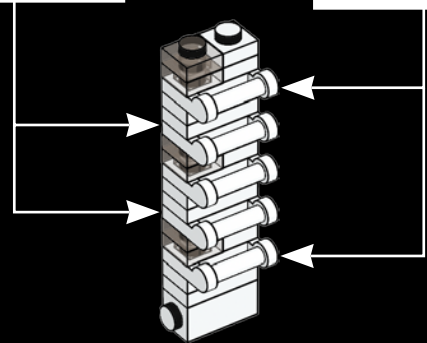
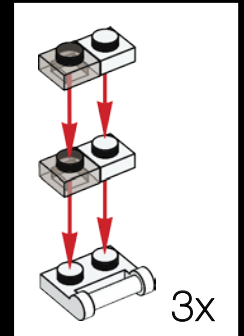
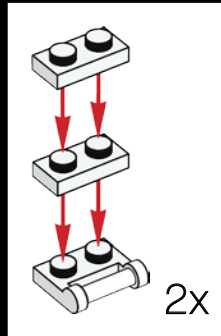

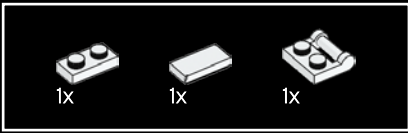

214

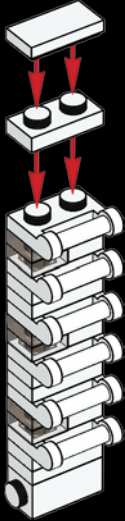

215

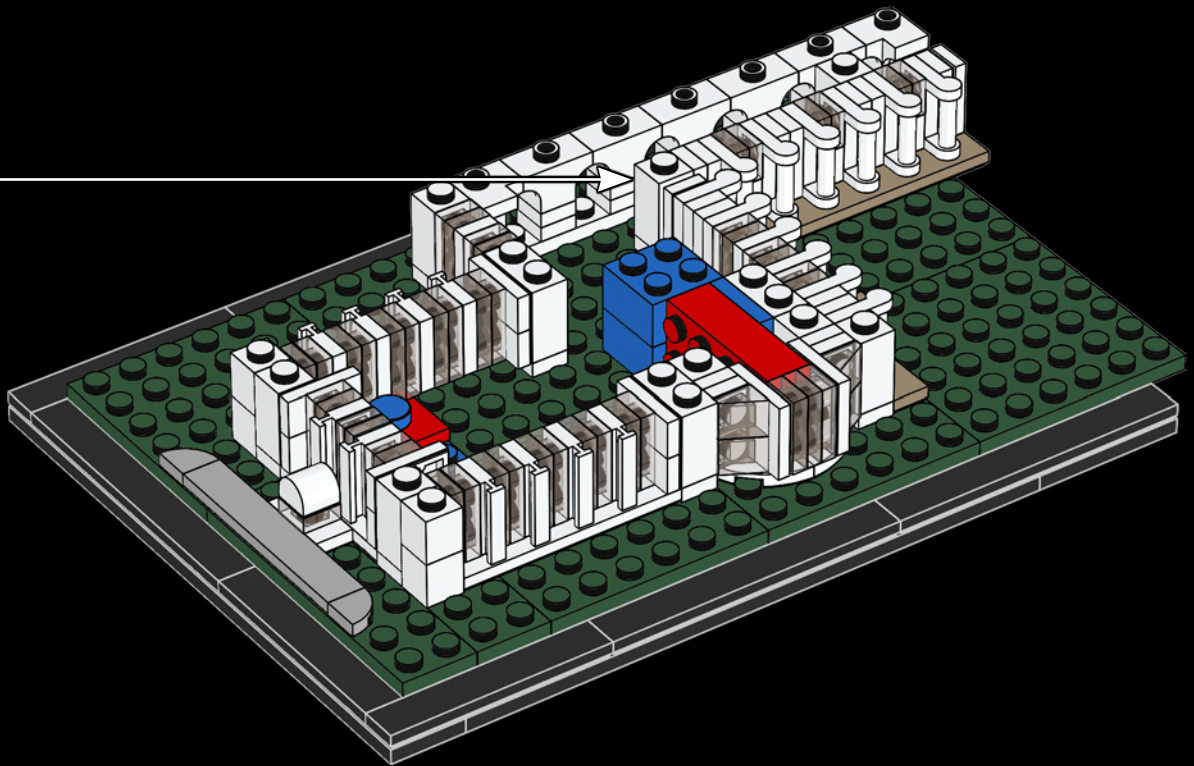

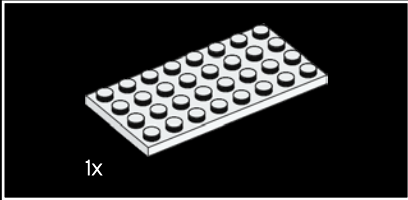
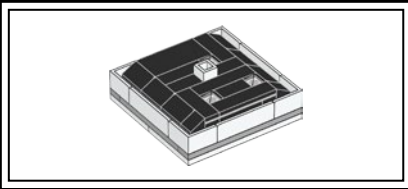

216

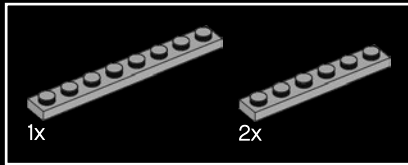
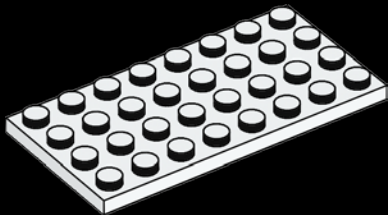

217

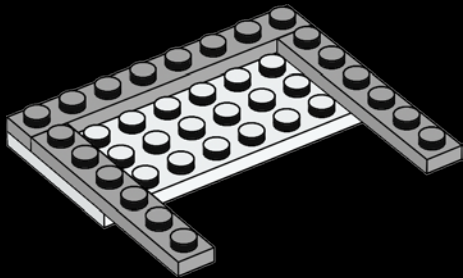

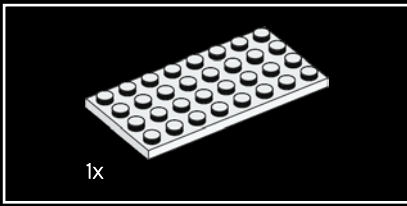

218

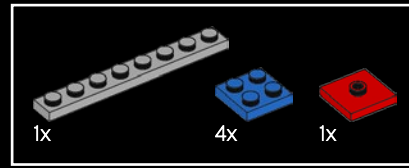
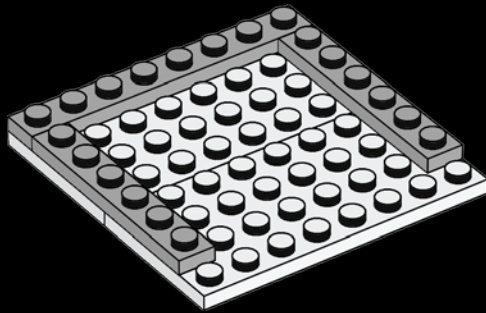

219

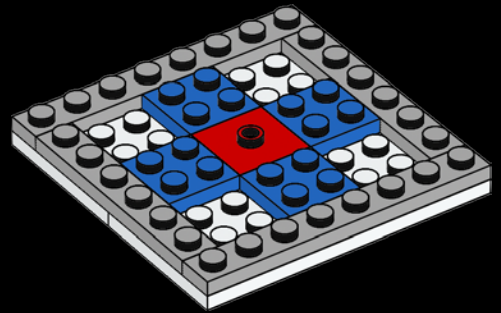

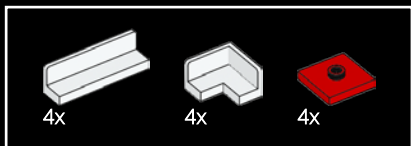

220

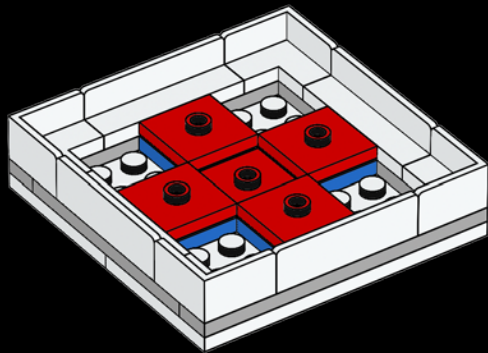

221

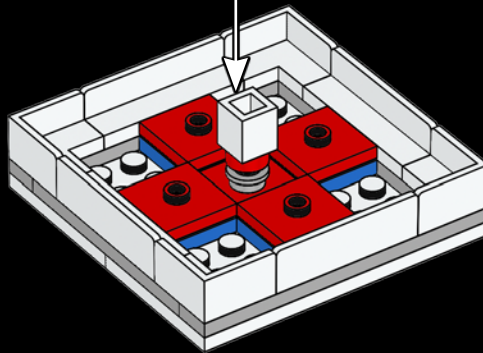
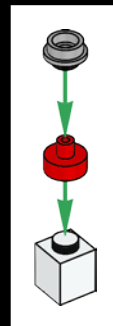

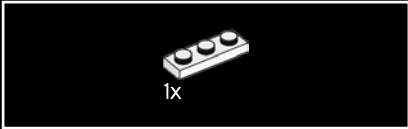
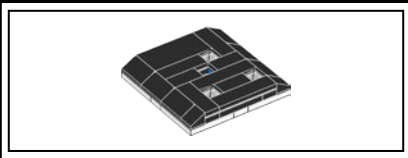

222

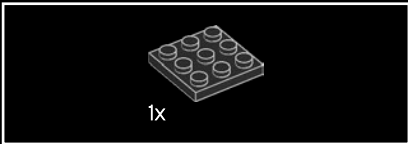

223

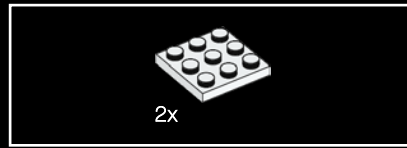
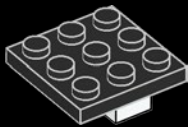

224

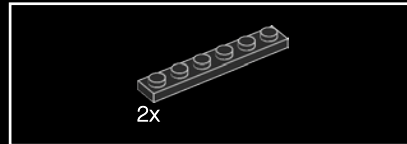
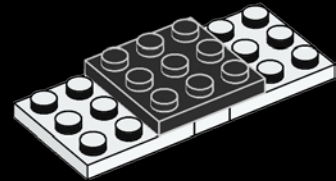

225

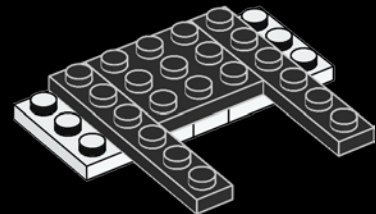

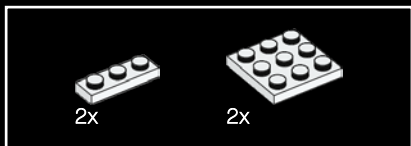

226

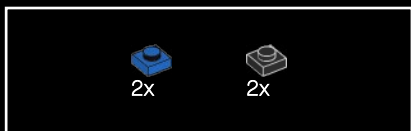
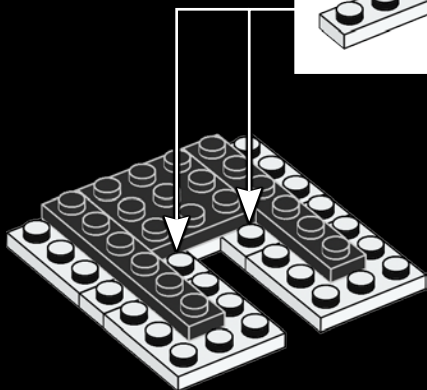
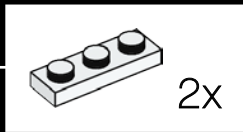

227

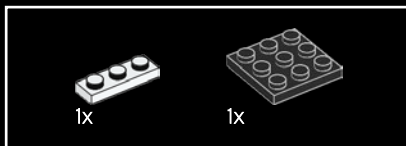
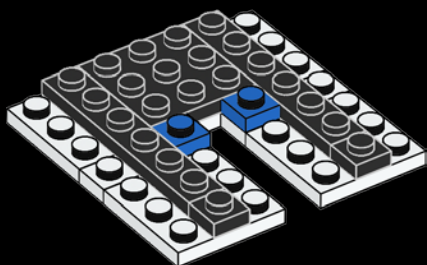

228

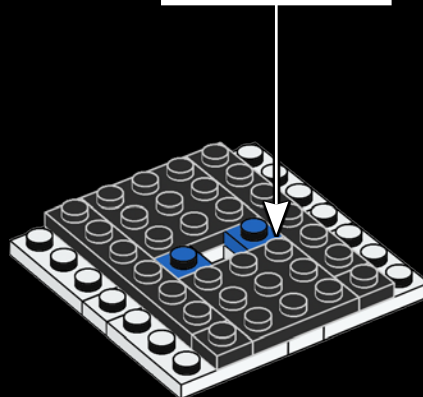
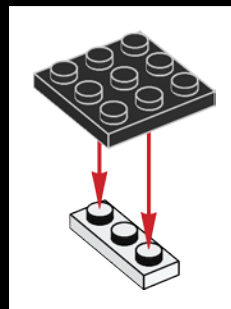

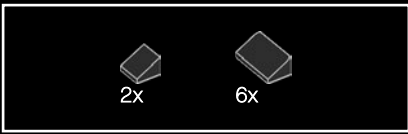

229

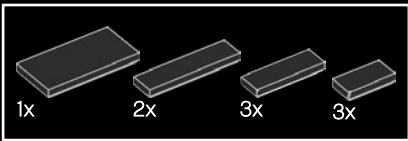
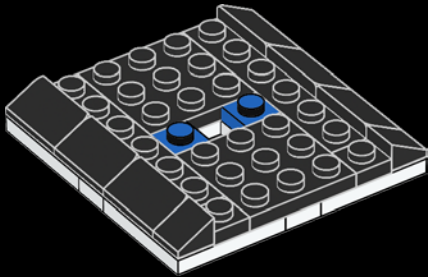

230

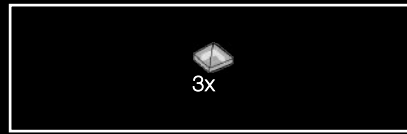
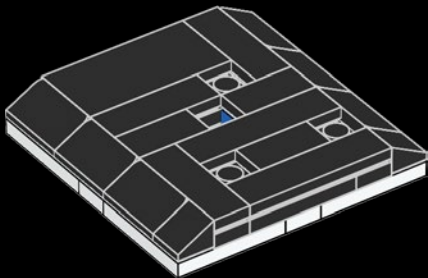

231

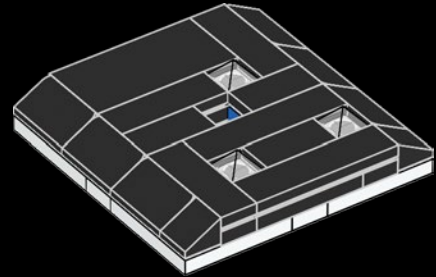

232

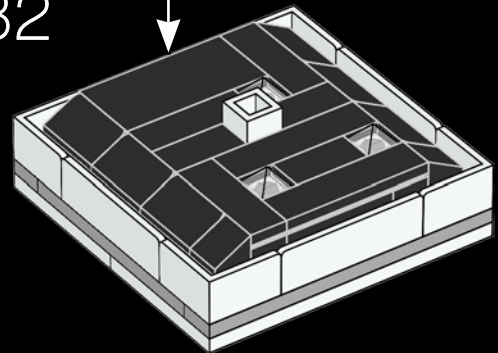

233

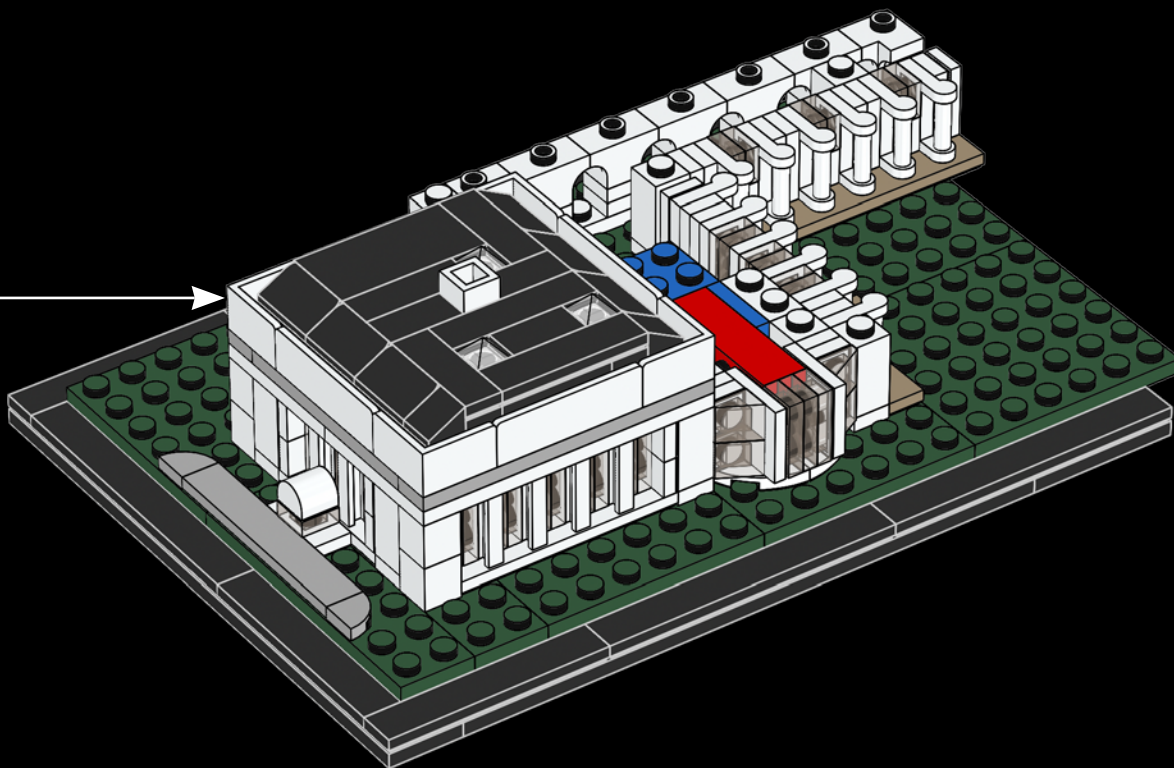

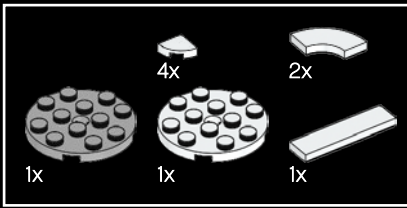

234

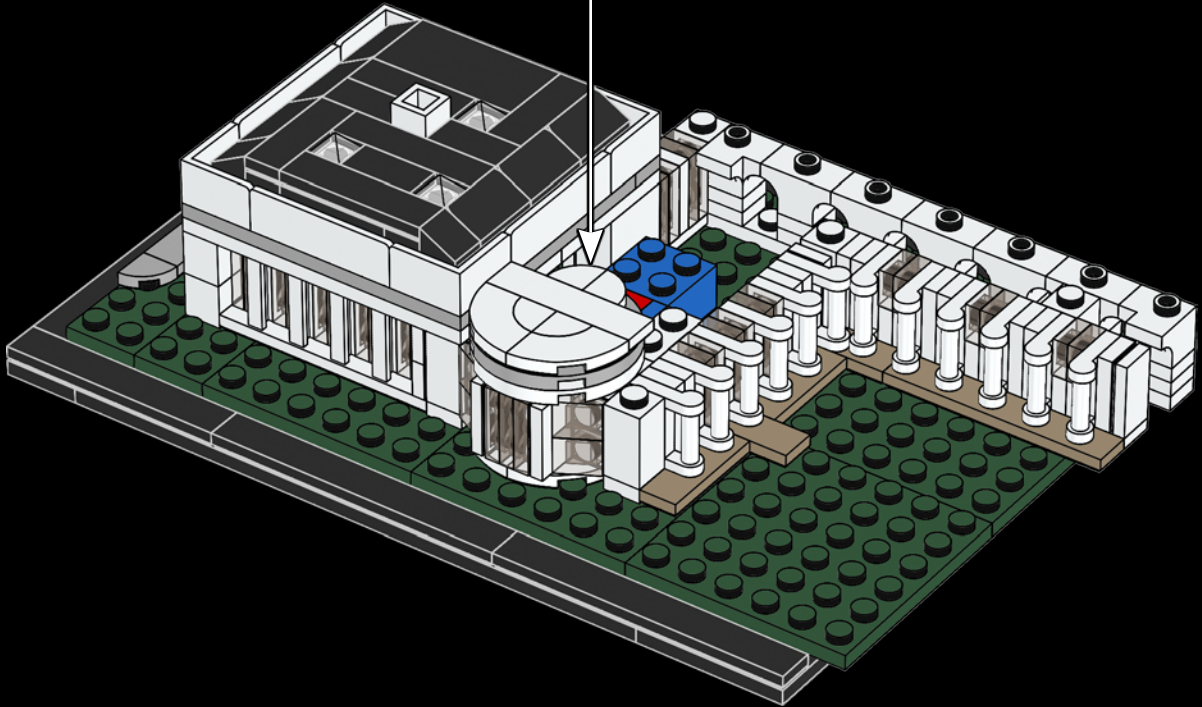
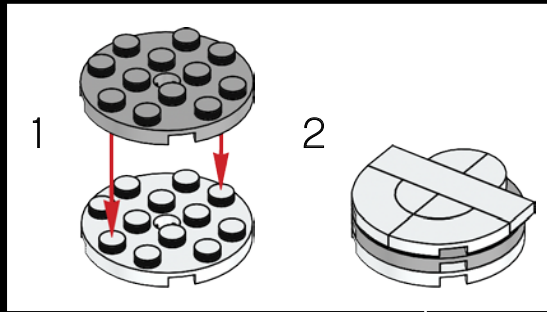

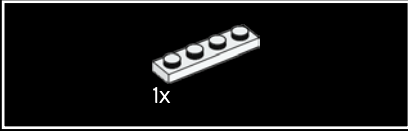
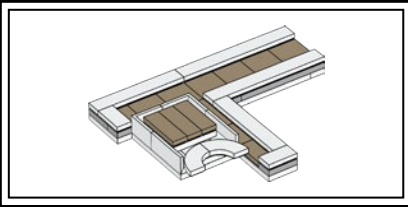

235

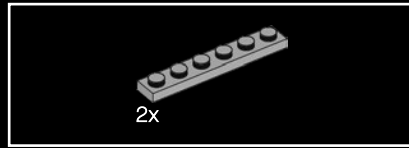

236

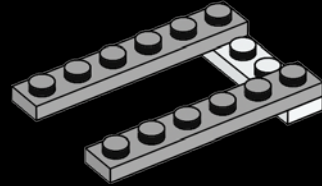

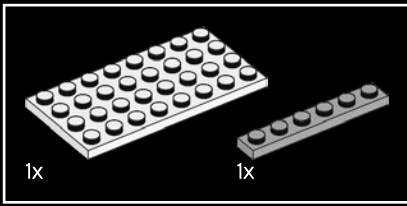

237

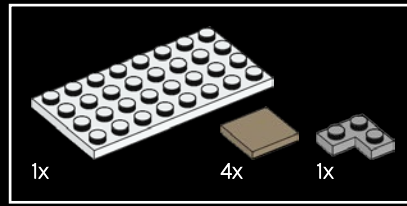
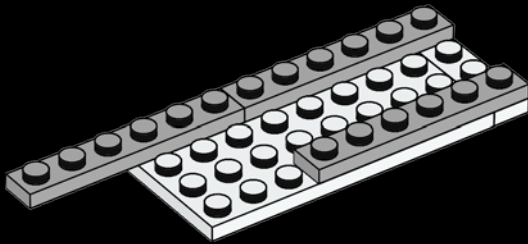

238

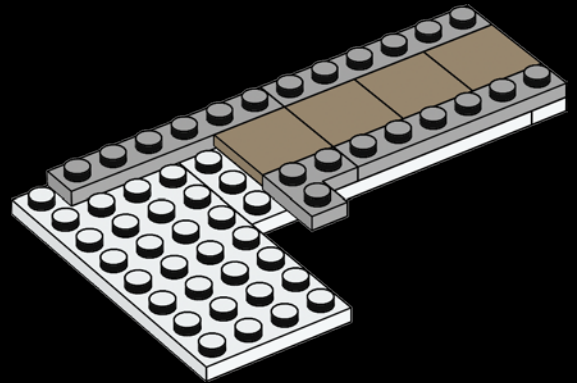

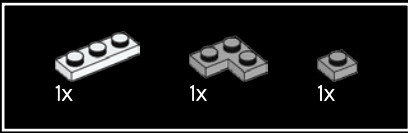

239

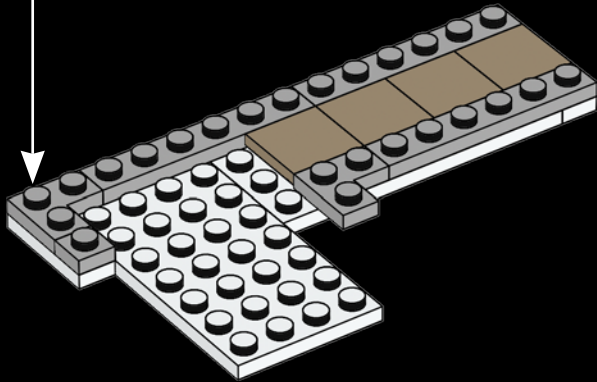
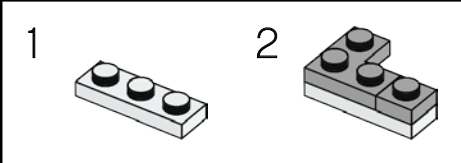

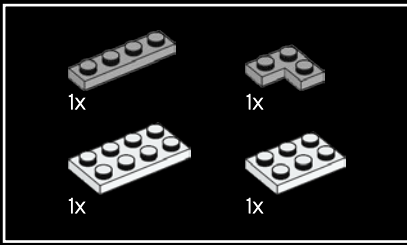

240

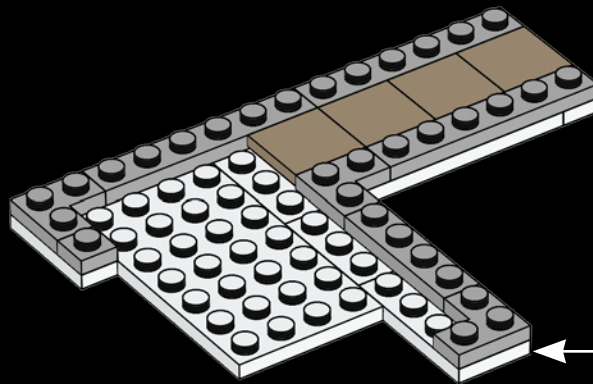
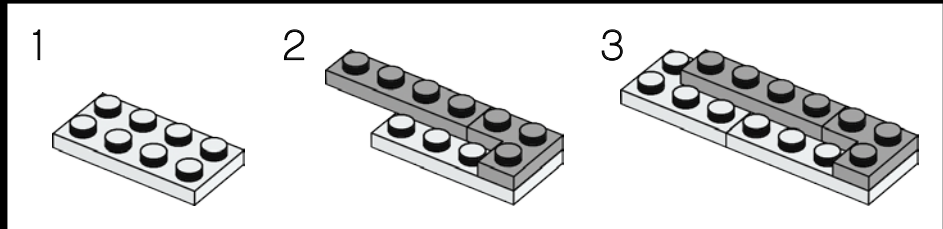

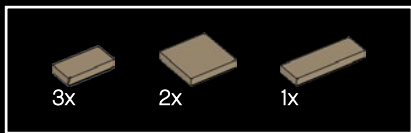

241

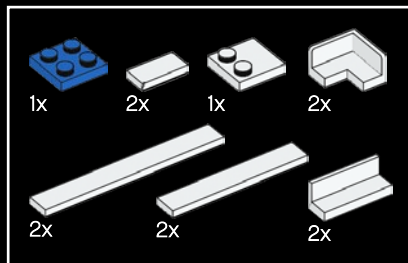
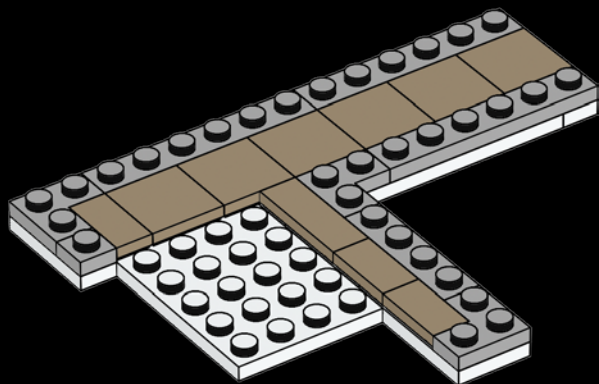

242

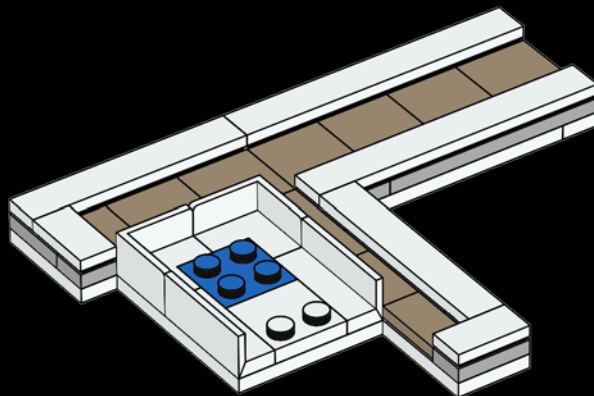

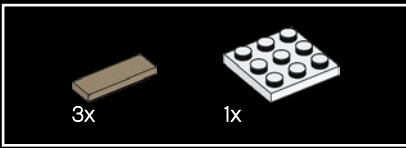

243

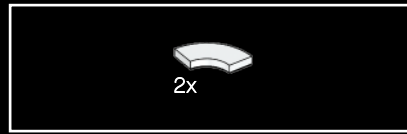
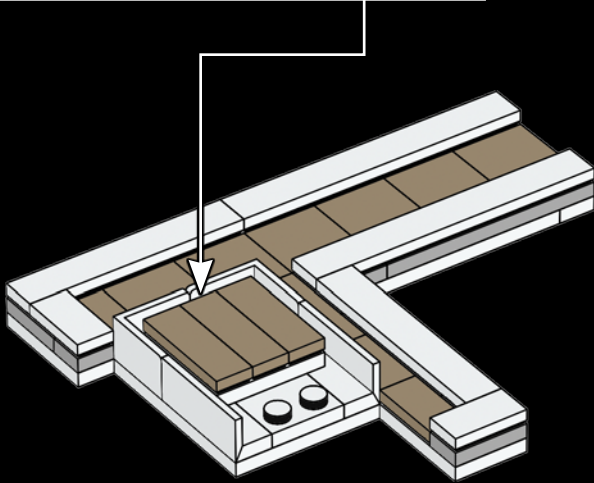
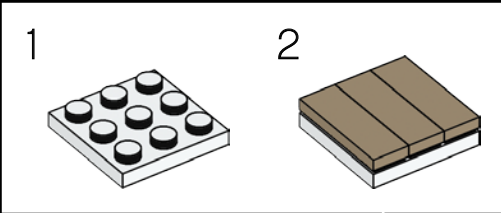

244

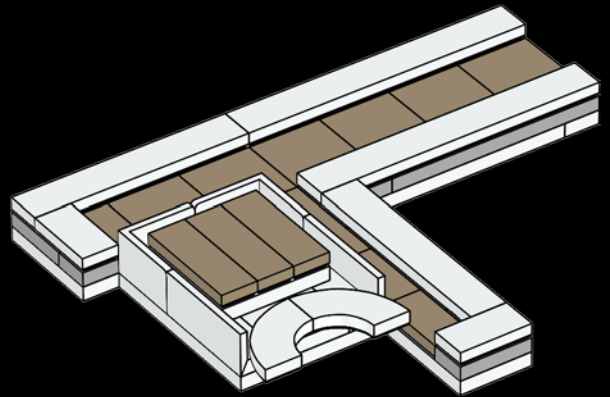

245

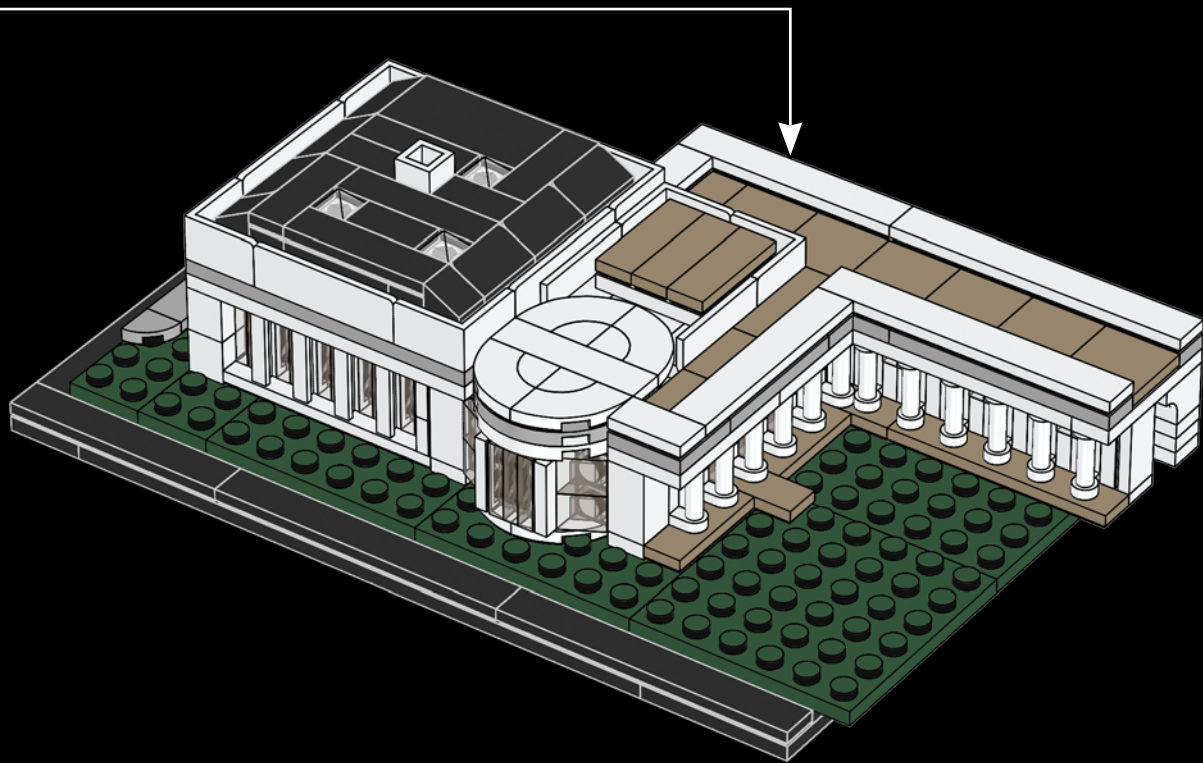

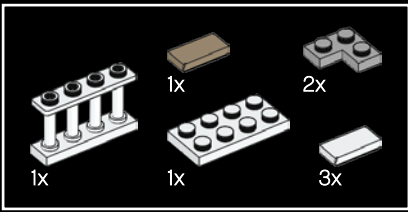

246

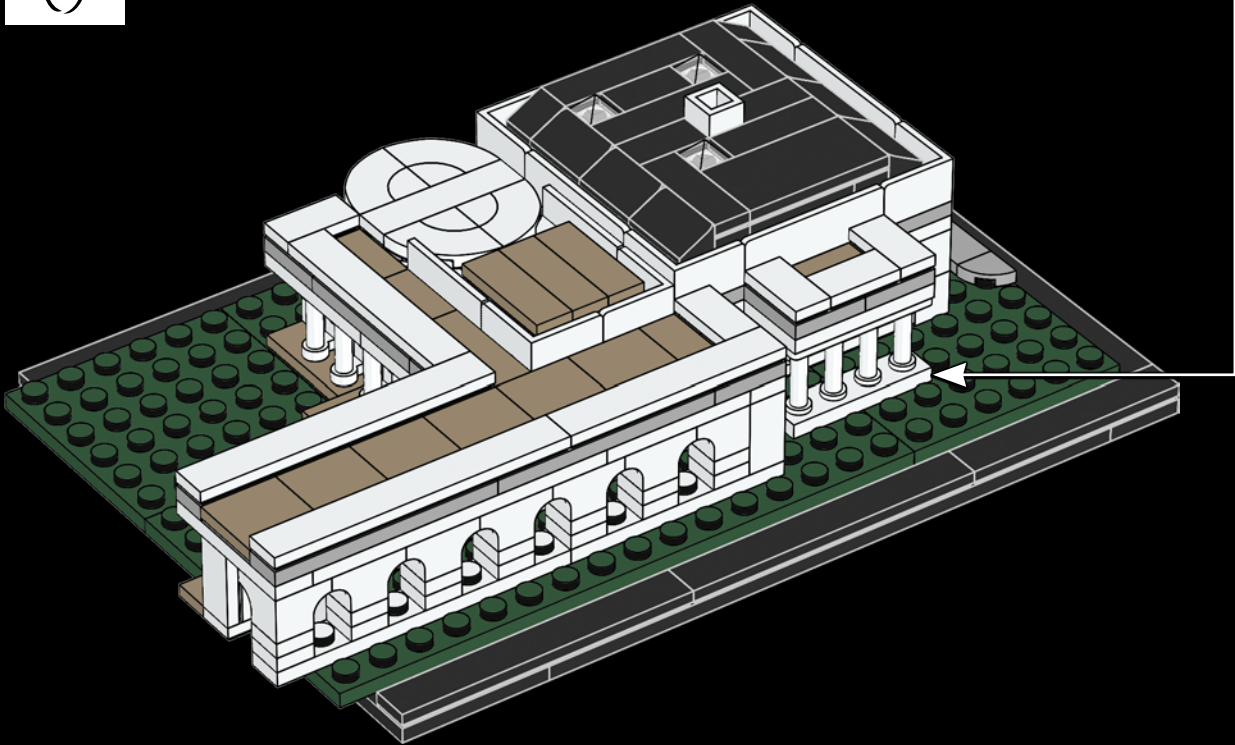
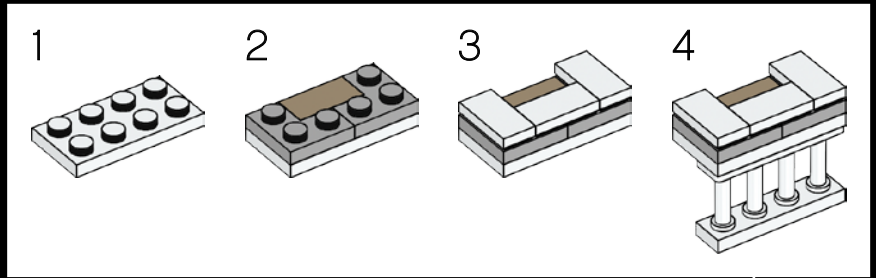
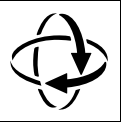



247

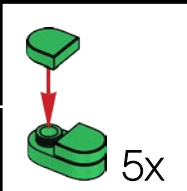
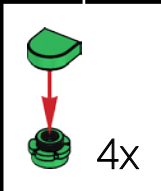
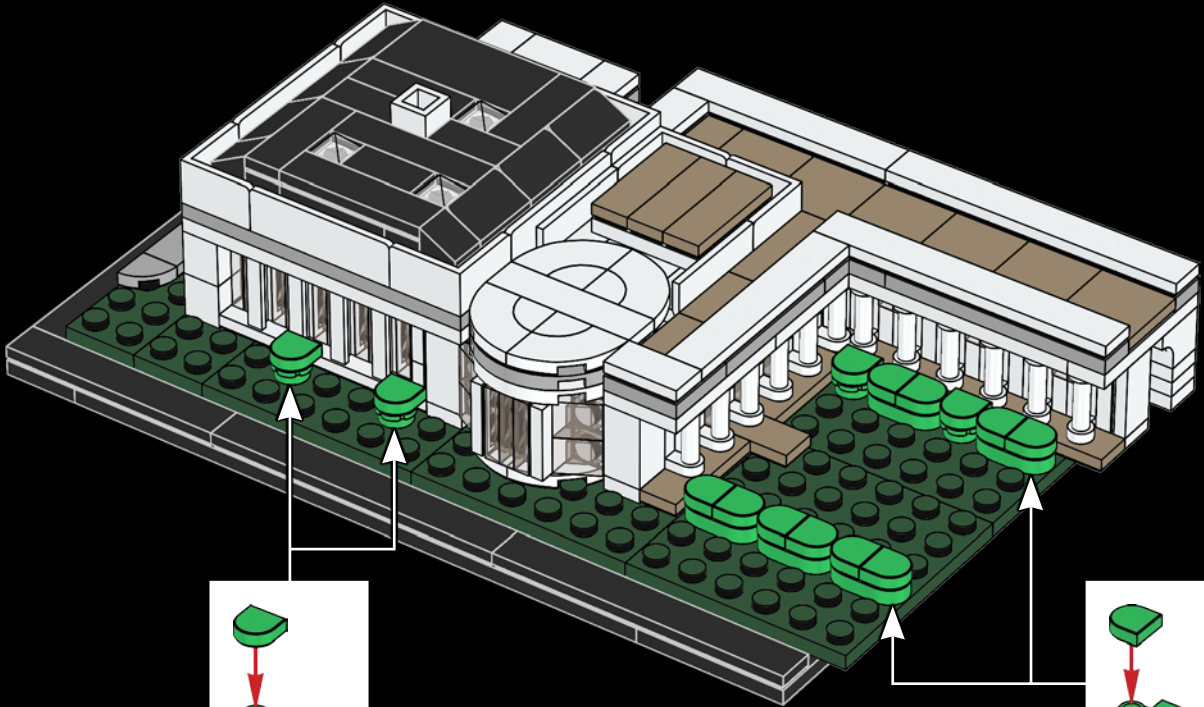
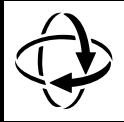



248

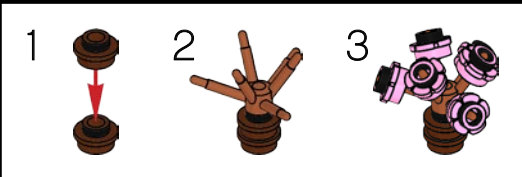
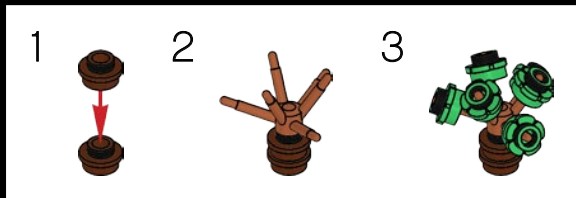

249



President Theodore Roosevelt officially gave the White House its current name in 1901

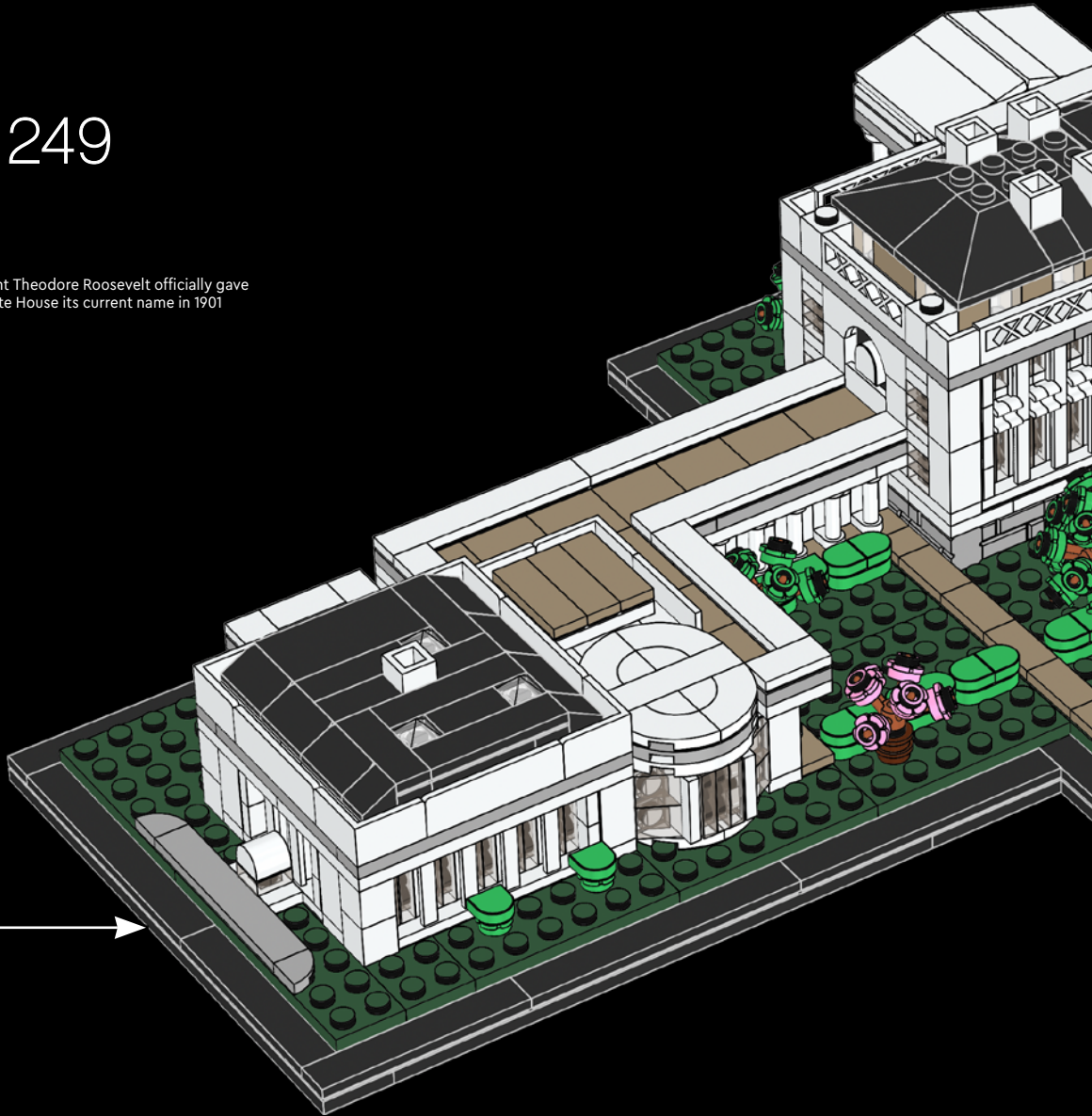



Celebrate the world of architecture and collect all the models

21045
Trafalgar Square



21042
Statue of Liberty



21046
Empire State Building



21028
New York City



21039
Shanghai



21043
San Francisco



21052
Dubai

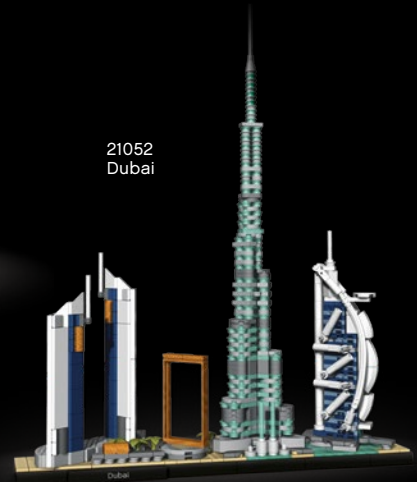

21044
Paris



21051
Tokyo



21034
London



The Transamerica Pyramid Building is a registered service mark of Transamerica Corporation and is being used with permission.

© Pyramide du Louvre, architecte I. M. Pei, musée du Louvre.

© TOKYO-SKYTREE

東京スカイツリー®/东京晴空塔®/TOKYO SKYTREE

© Jumeirah International LLC





LEGO® Architecture

The LEGO® Architecture series creatively captures the essence of many of the world's most iconic landmarks while giving you an enjoyable and engaging LEGO building experience.

Whether your interest is in travel, design, history or architecture, these sets are a physical memento of a great trip abroad, a famous building you know well, or a city you still dream of visiting.

Every LEGO Architecture set is designed to be displayed. Much more than just a photo, building and displaying your model on your desk, in the bookcase or on the shelf, lets you be transported every time you admire the view.

Follow us on



Adam Reed Tucker is the co-developer of the LEGO Architecture product line.

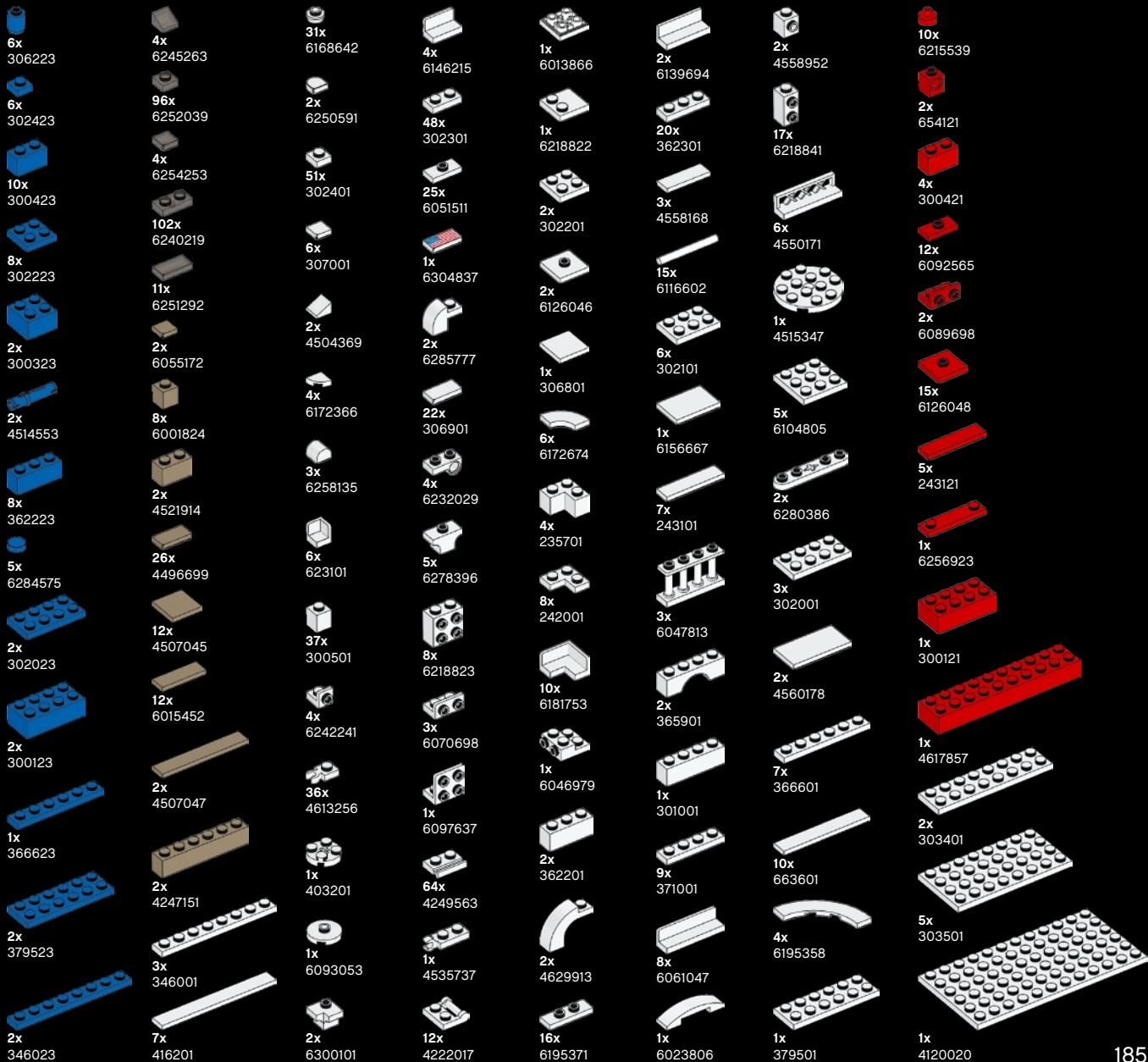



Customer Service
Kundenservice
Service Consommateurs
Servicio Al Consumidor

LEGO.com/service or dial



00800 5346 5555 :



1-800-422-5346 :





FEEDBACK AND WIN

FEEDBACK AND WIN

Your feedback will help shape the future development of this product series.

Please visit:

FEEDBACK UND GEWINNEN

Dein Feedback trägt zur Weiterentwicklung dieser Produktreihe bei.

Geh auf:

COMMENTEZ ET GAGNEZ

Vos commentaires nous aideront à concevoir les futurs produits de cette gamme.

Rendez-vous sur :

COMENTA Y GANA

Tu opinión nos ayudará a dar forma al desarrollo de esta serie de productos en el futuro.

Visita:

反馈有奖

您的反馈将有助于我们在今后改进本系列产品。

请访问：

[LEGO.com/productfeedback](https://www.lego.com/productfeedback)

By completing, you will automatically enter a drawing to win a LEGO® set.

Terms & Conditions apply.

Durch Ausfüllen nimmst du automatisch an der Verlosung eines LEGO® Preises teil.

Es gelten die Teilnahmebedingungen.

En envoyant vos commentaires, vous serez automatiquement inscrit(e) à un tirage au sort qui vous permettra de remporter un prix LEGO®.

Offre soumise à conditions.

Al contestar, participarás automáticamente en el sorteo y podrás ganar un set LEGO®.

Sujeto a Términos y Condiciones.

完成我们的反馈调查，即可自动进入抽奖环节，赢取乐高®套装。

适用《条款和条件》。

References

Text
www.whitehouse.gov
www.whitehousehistory.org

Images
@ Shutterstock

LEGO and the LEGO logo are trademarks of the LEGO Group.
©2020 The LEGO Group.



Follow LEGO® Architecture on





Architecture^o

