



Harry Potter



76399





Check for compatibility
Kompatibilität prüfen
Vérifier la compatibilité
Controlla la compatibilità
Comprueba tu compatibilidad
Verificar a compatibilidade
Ellenőrizd a kompatibilitást
Pārbaudīt saderību
检查兼容性

LEGO.com/devicecheck



LEGO® Building Instructions



Download on the
App Store



GET IT ON
Google Play



腾讯应用宝
安卓应用商店

Apple and the Apple logo are trademarks of Apple Inc.
Google Play and the Google Play logo are trademarks of Google LLC.
Tencent and the Tencent logo are trademarks of Tencent Inc.



16

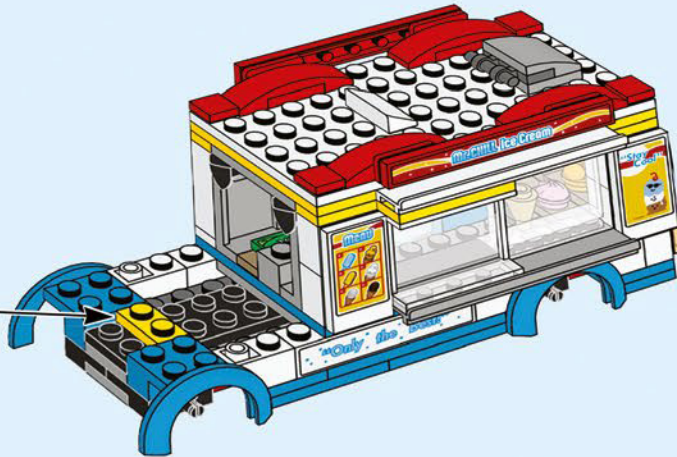

21

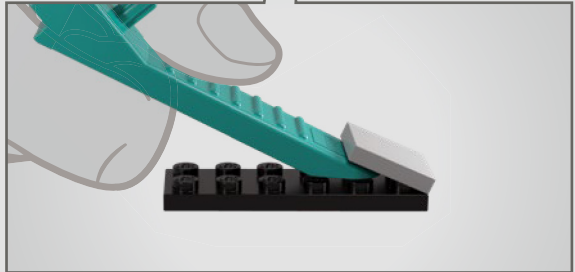
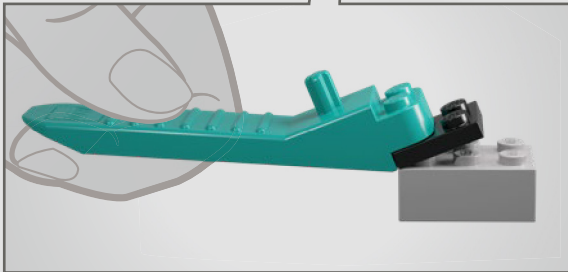
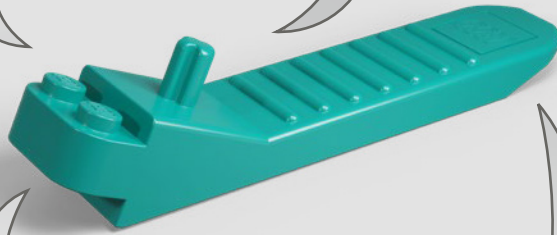
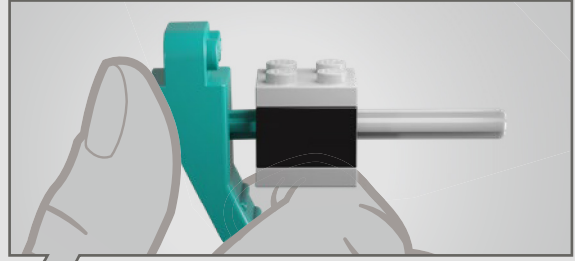
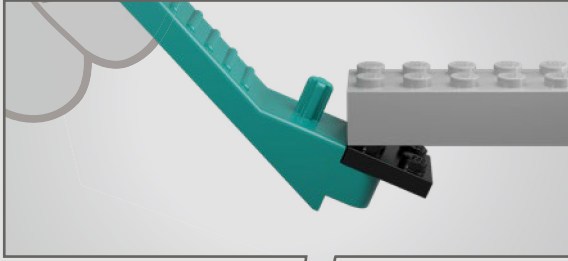



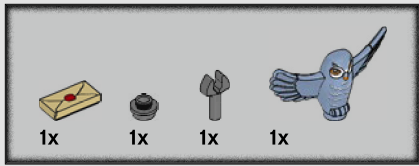

1

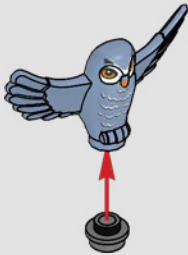

2

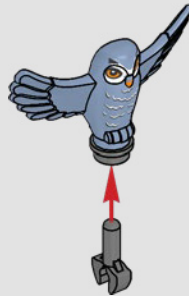

3



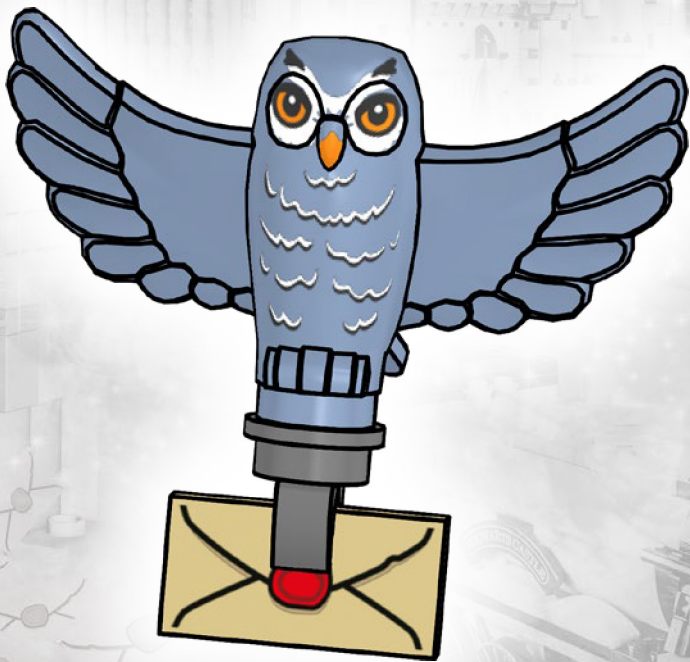

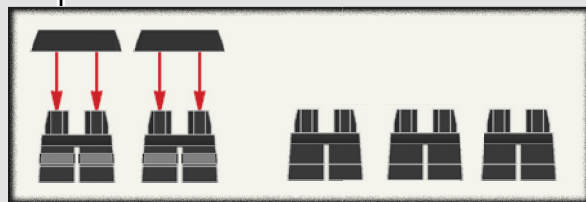
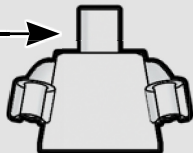
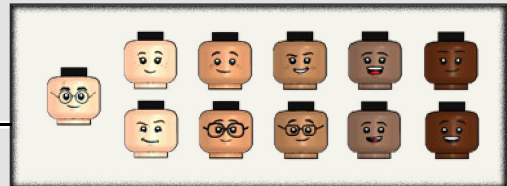

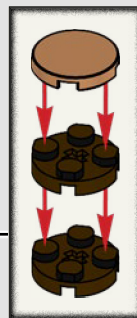
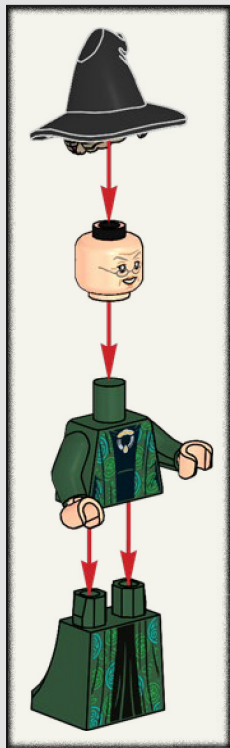

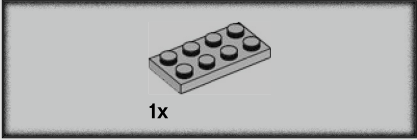
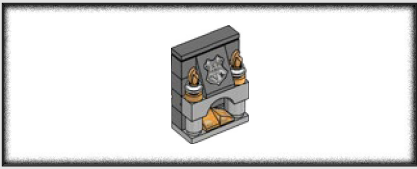

1

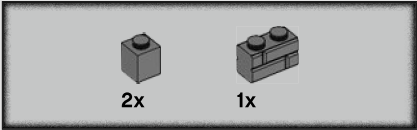
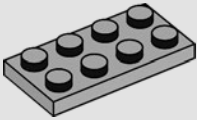

2

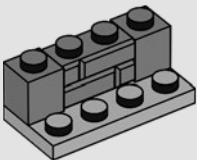

10



3

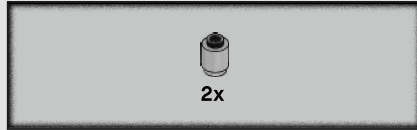
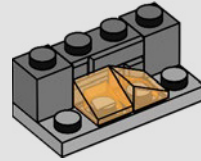

4

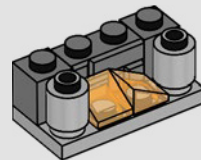

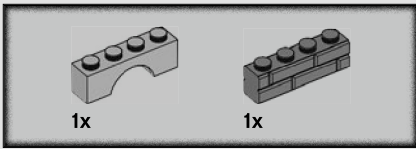

5

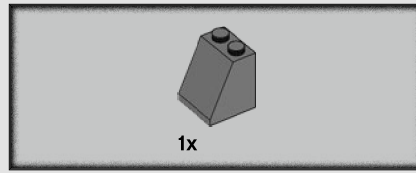
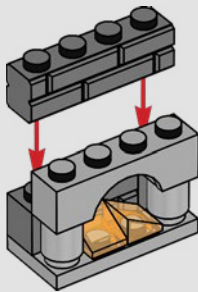

6

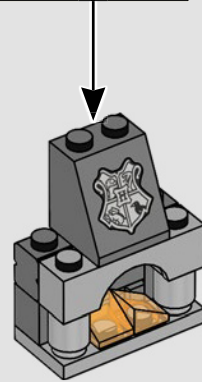
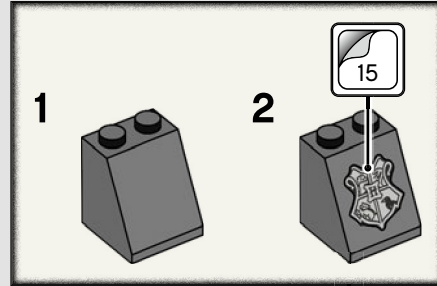

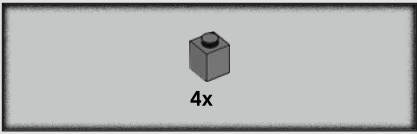

7

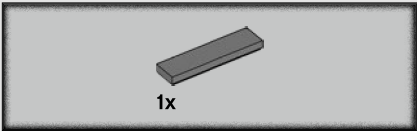
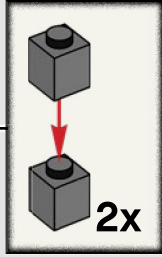
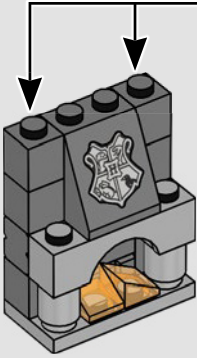

8

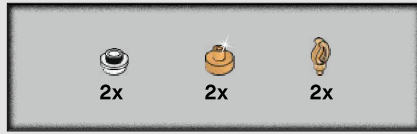
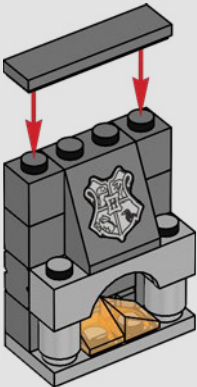

9

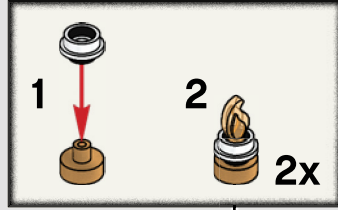

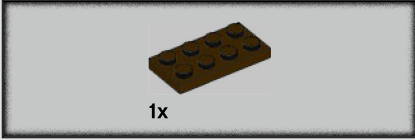
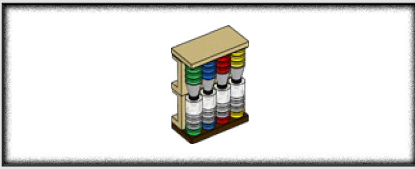

1

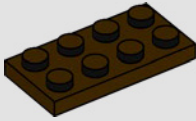

2

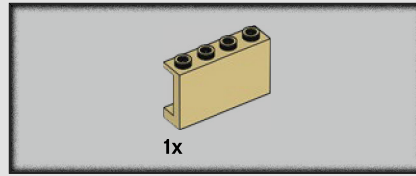
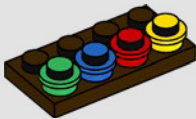

3

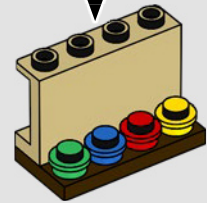
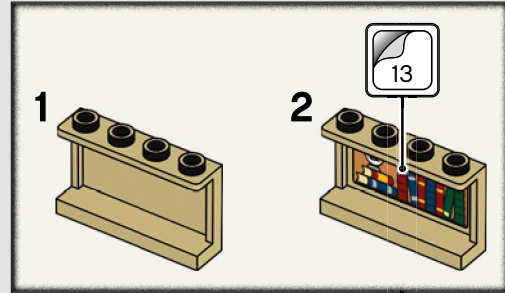

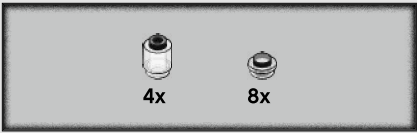

4

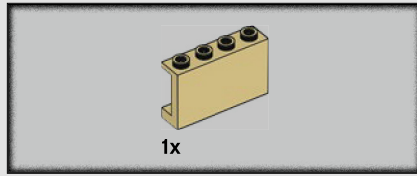
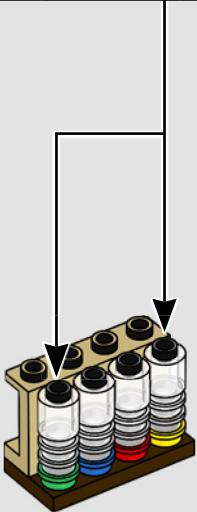
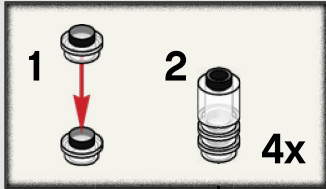

5

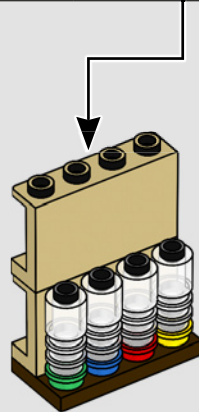
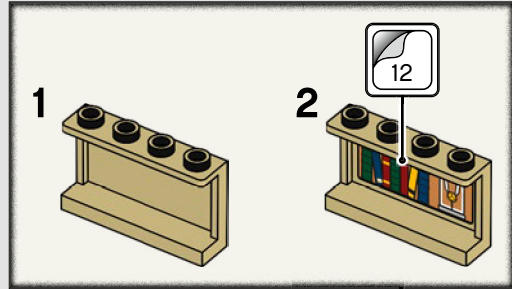



6

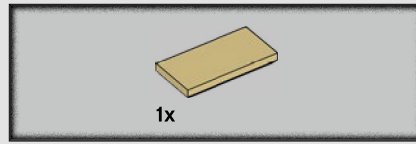
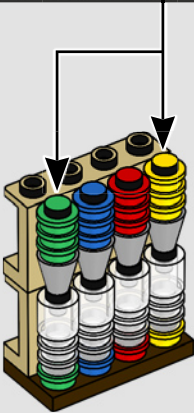
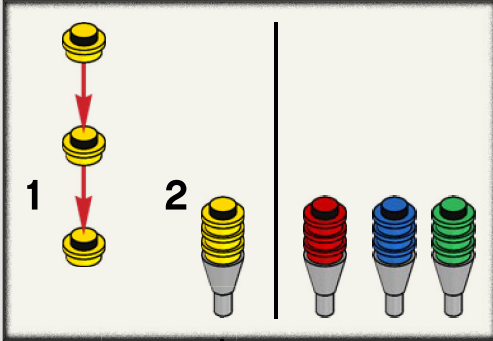

7



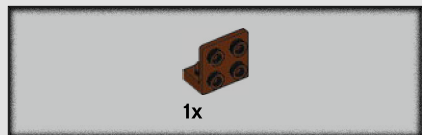

1

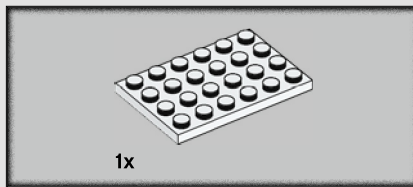

2

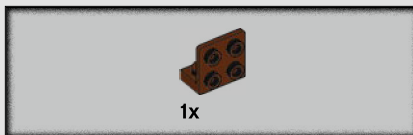
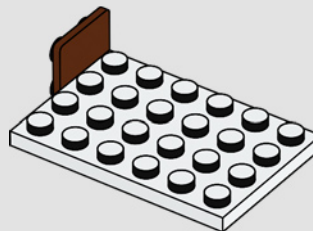

3

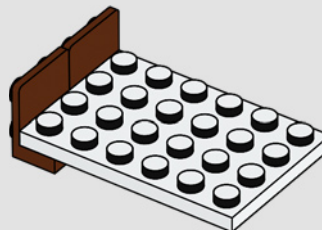

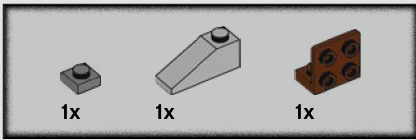

4

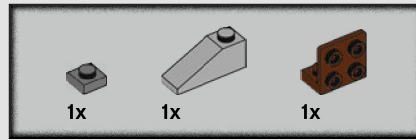
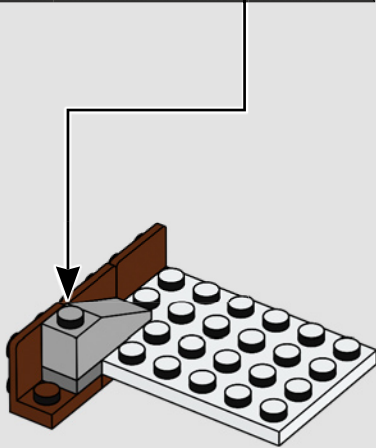
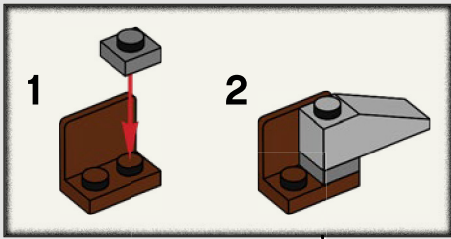

5

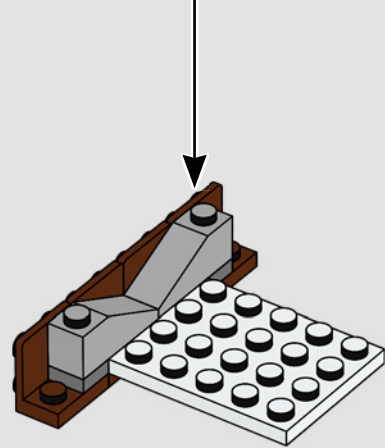
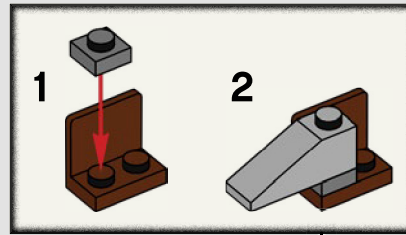

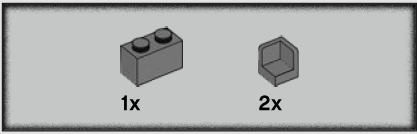

6

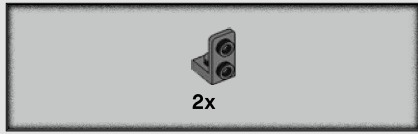
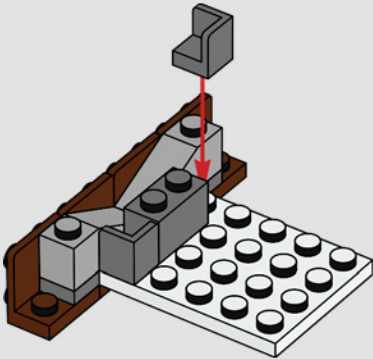

7

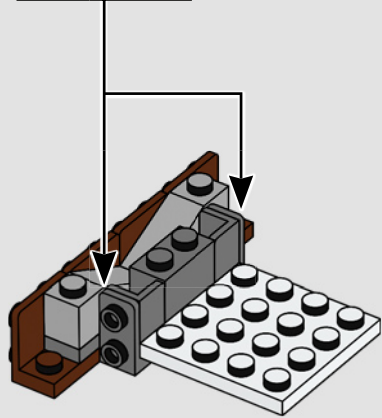
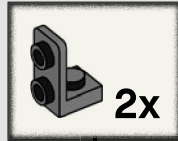

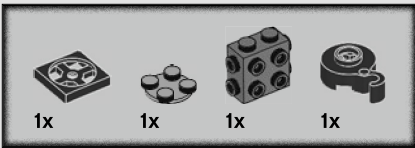

8

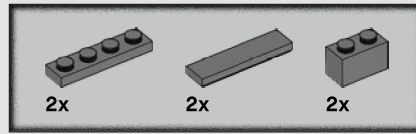
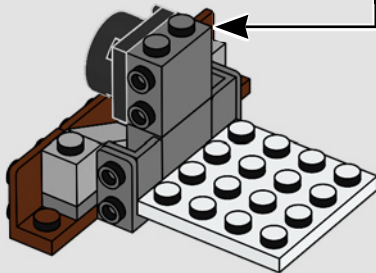
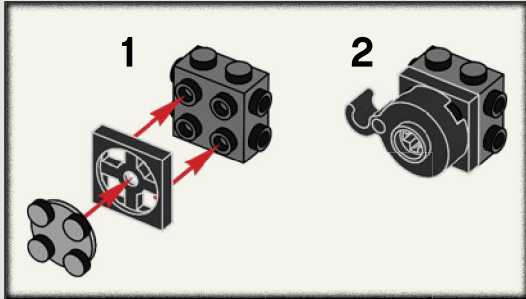

9

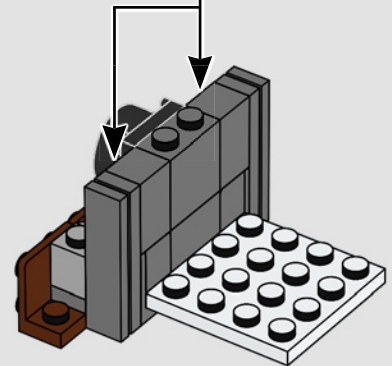
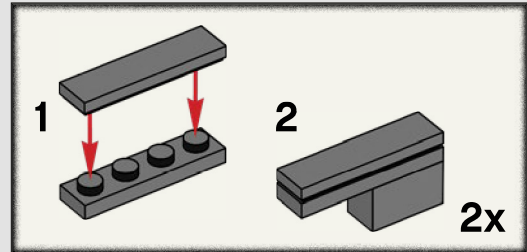

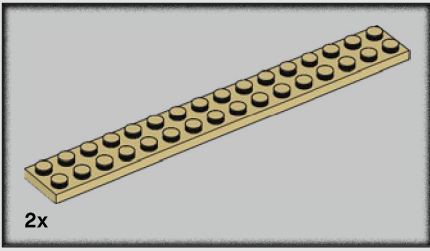

10

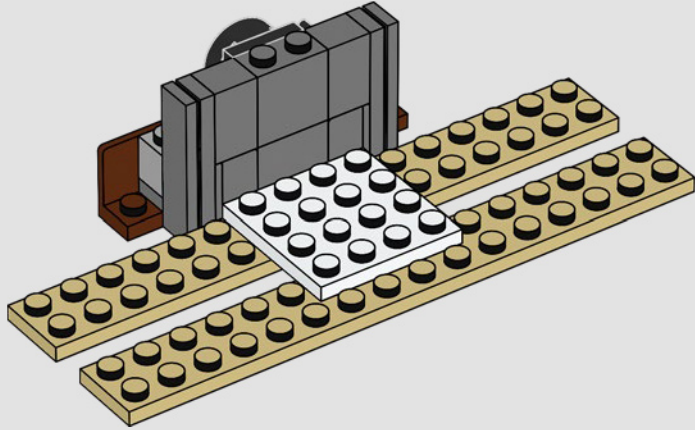

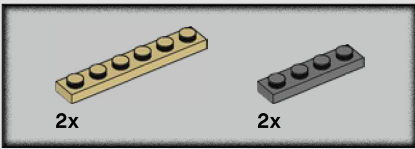

11

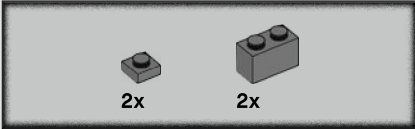
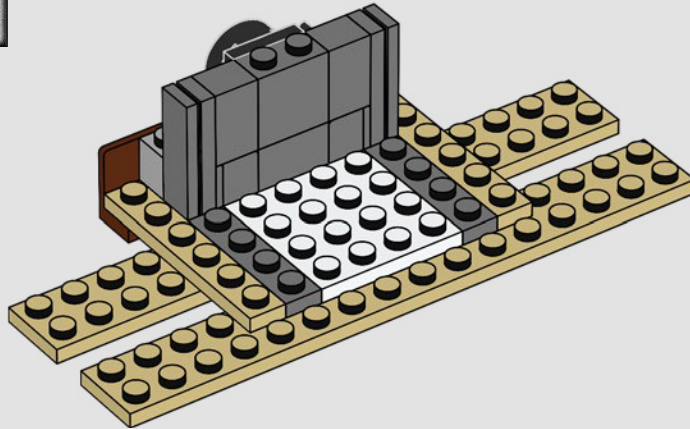

12

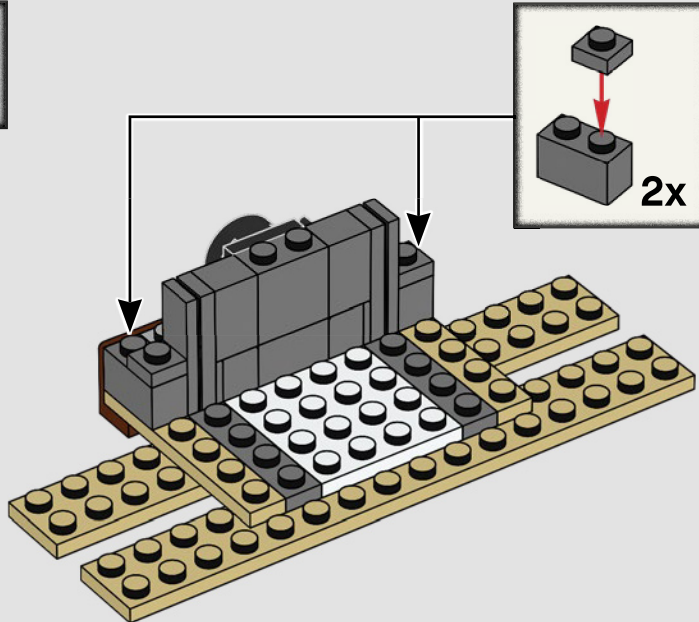

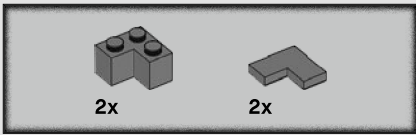

14

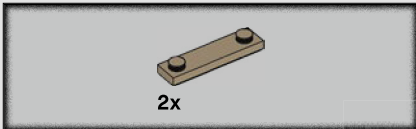
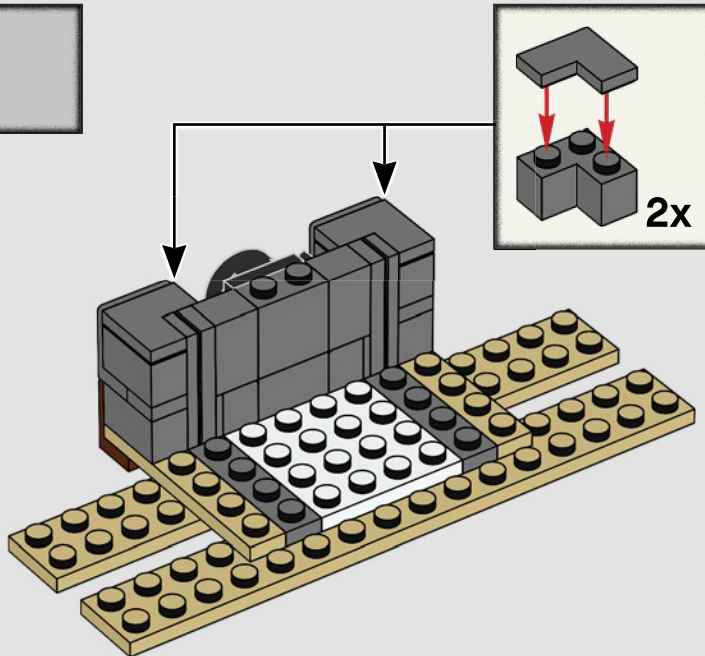

15

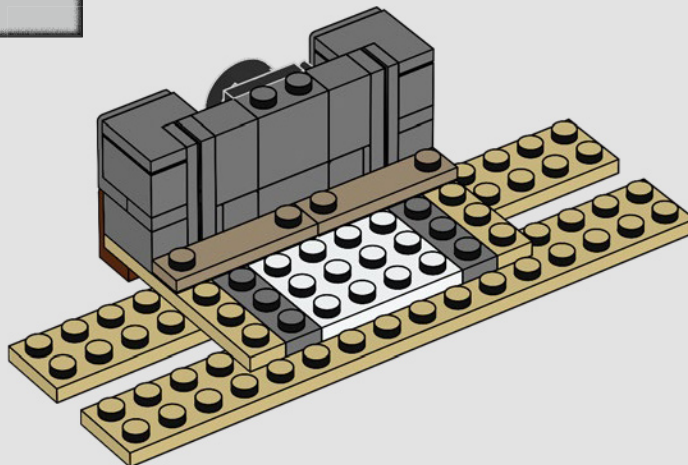

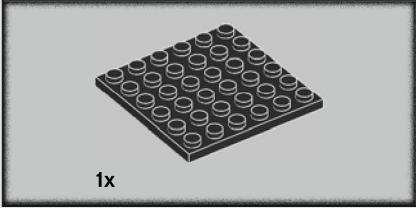
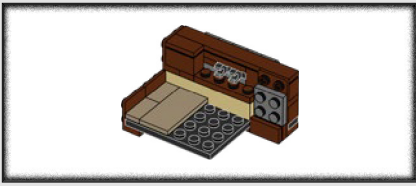

16

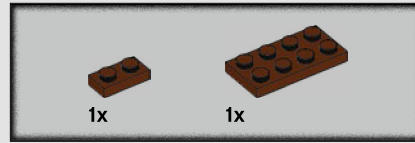
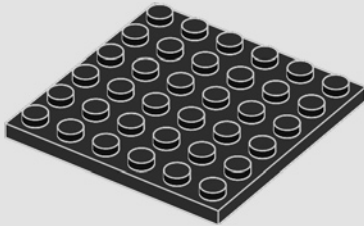

17

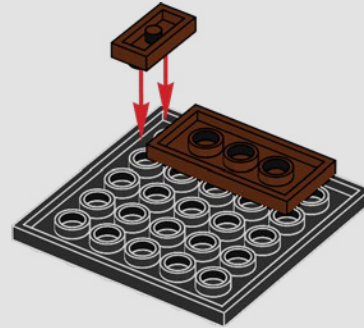
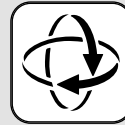



18

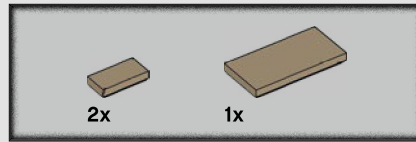
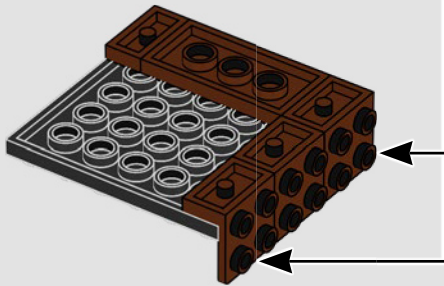

19

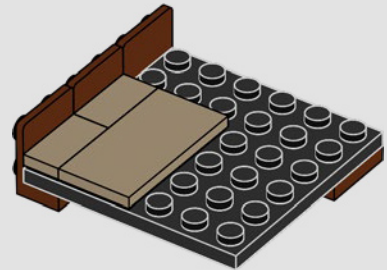
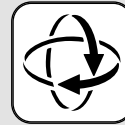

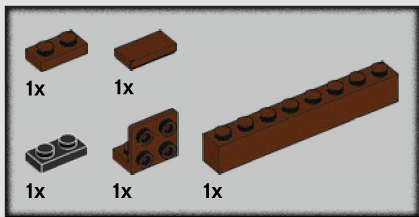

20

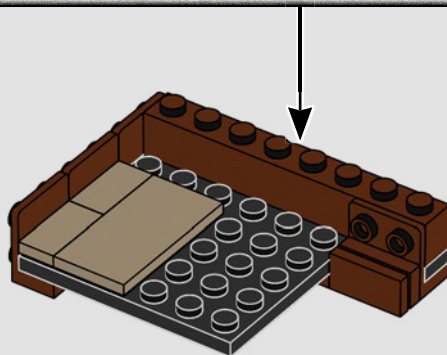
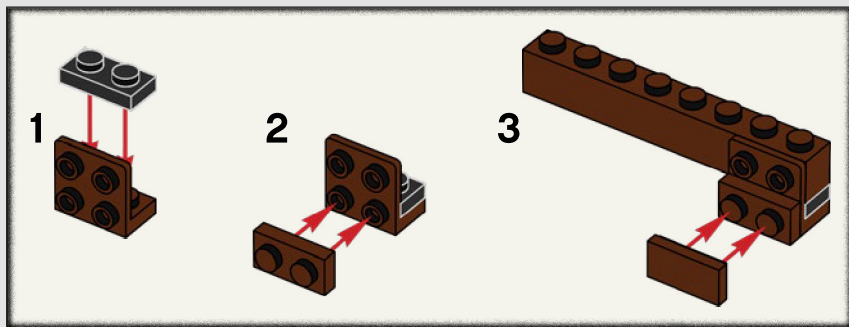

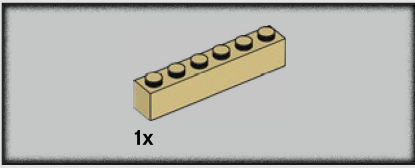

21

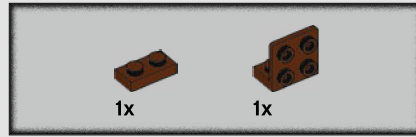
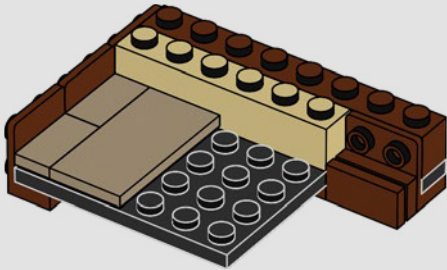

22

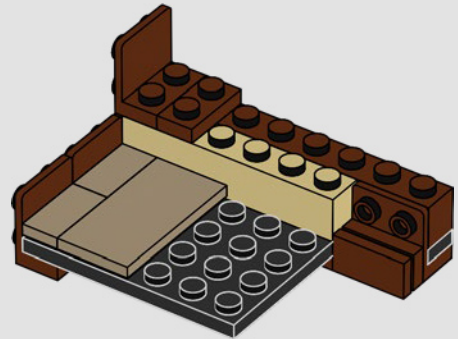

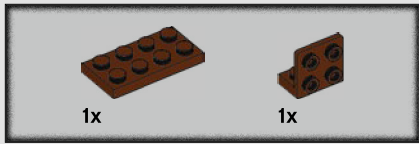

23

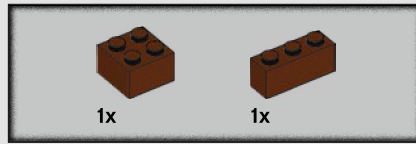
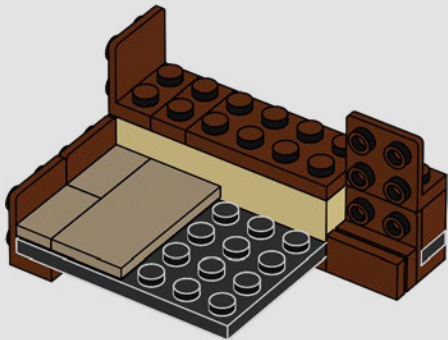

24

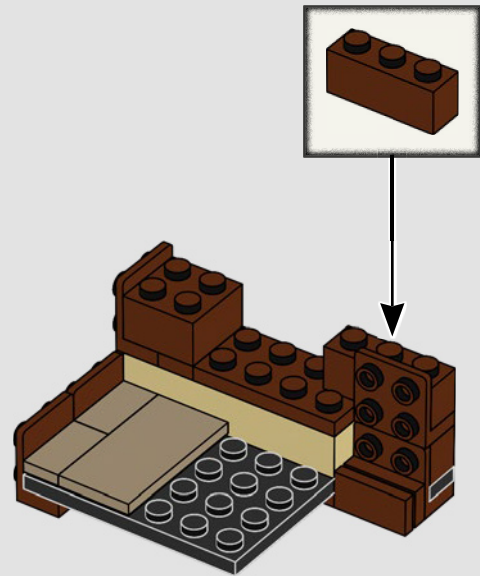

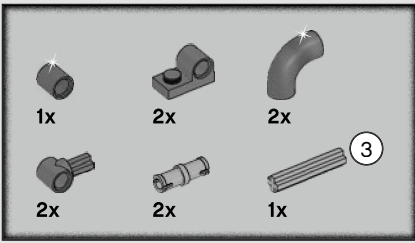

25

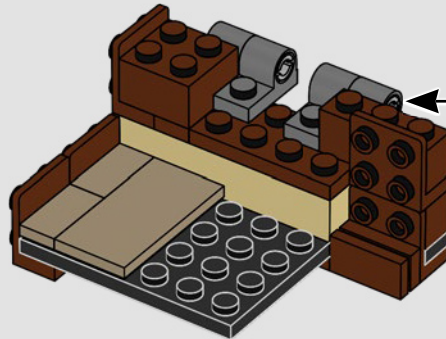
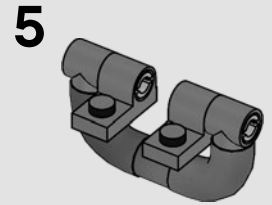
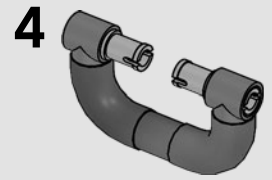
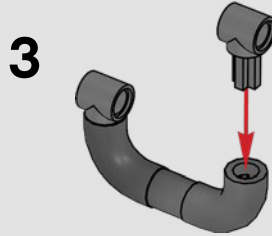
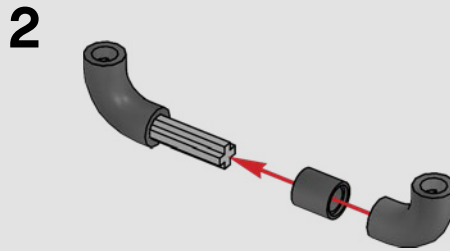
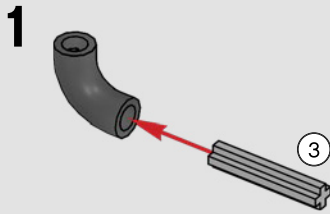

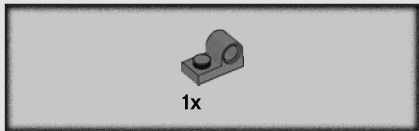

26

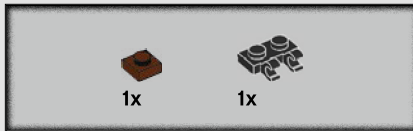
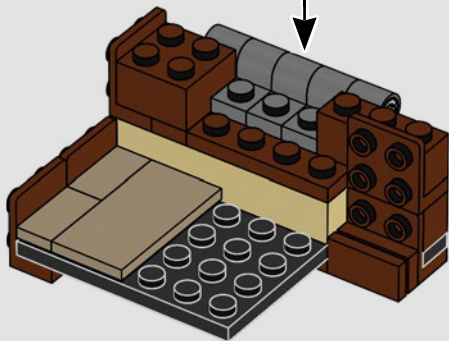

27

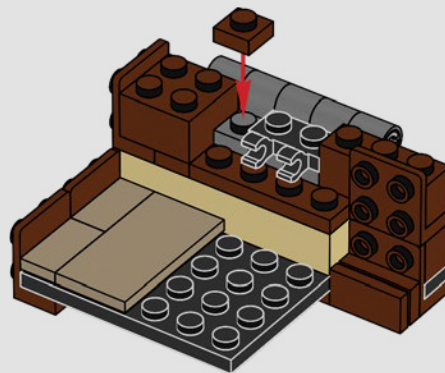

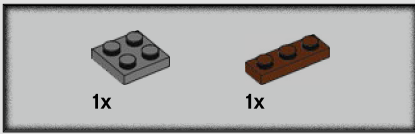

28

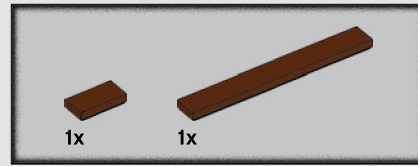
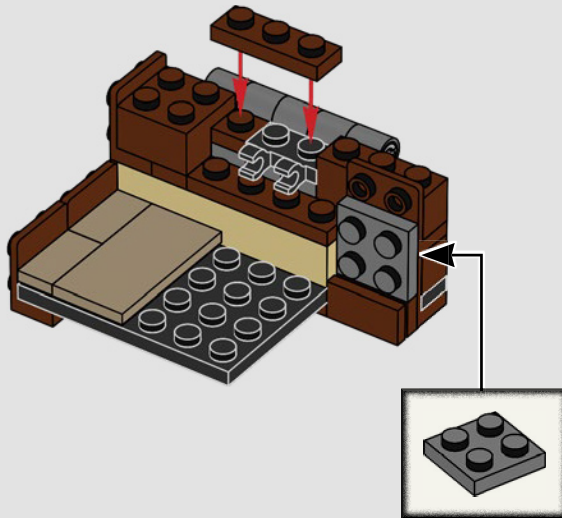

29

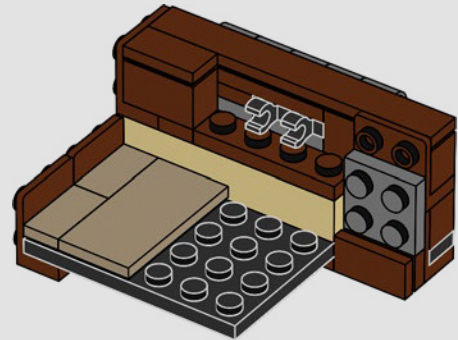

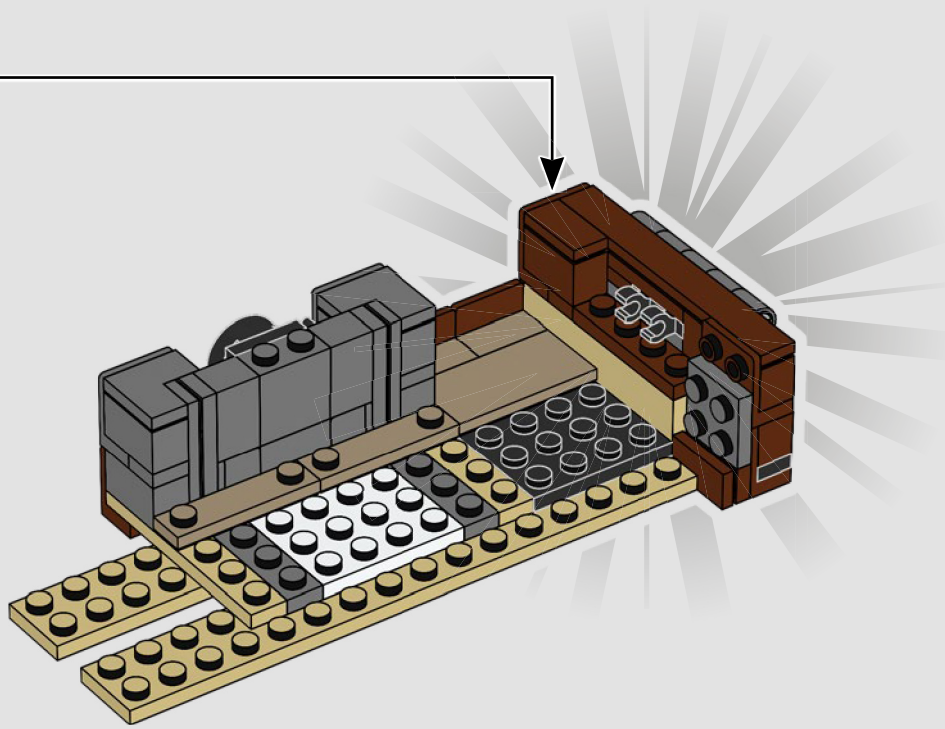

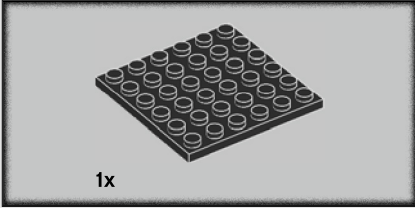
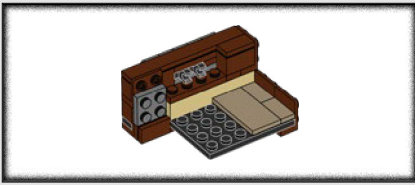

31

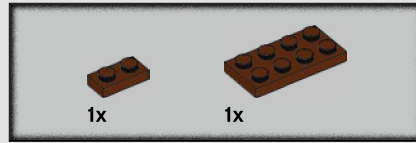
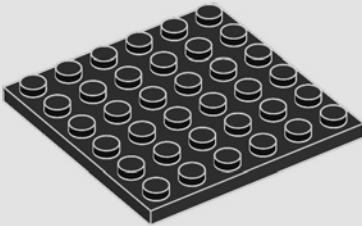

32

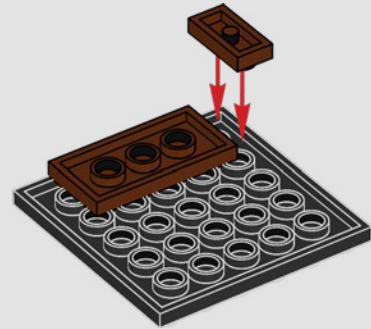
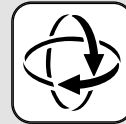

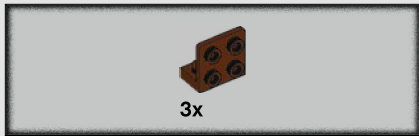

33

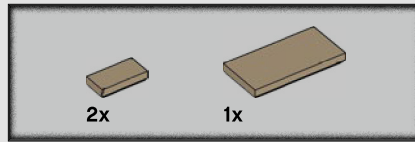
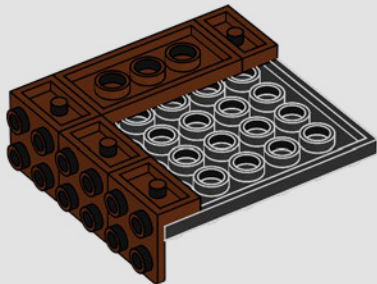

34

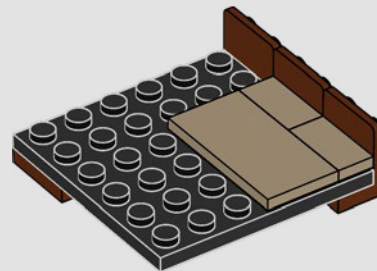
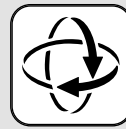

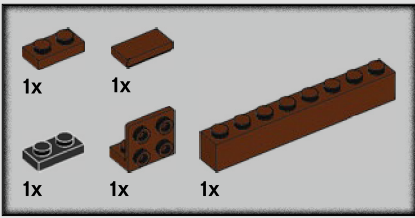

35

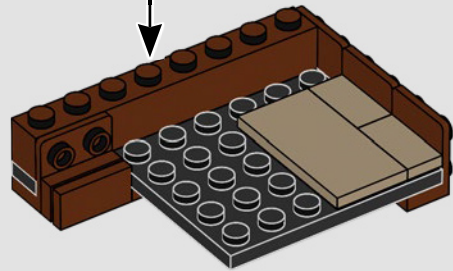
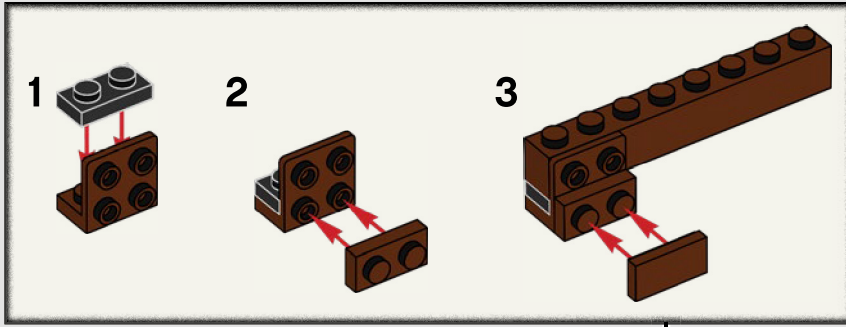

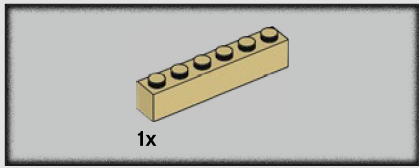

36

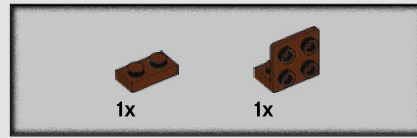
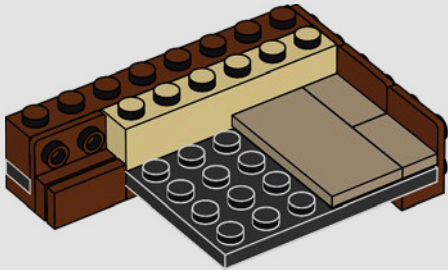

37

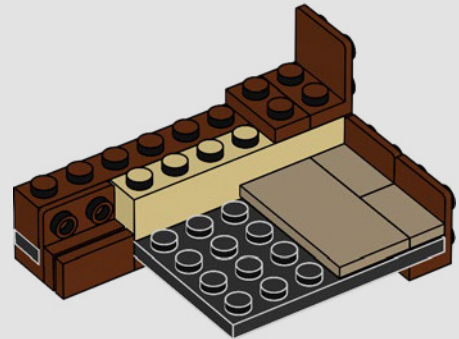

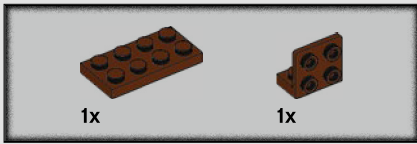

38

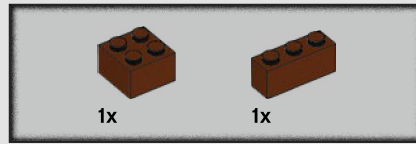
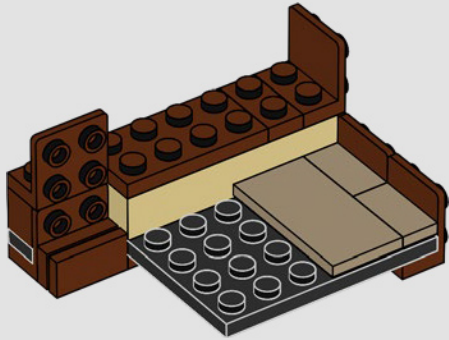

39

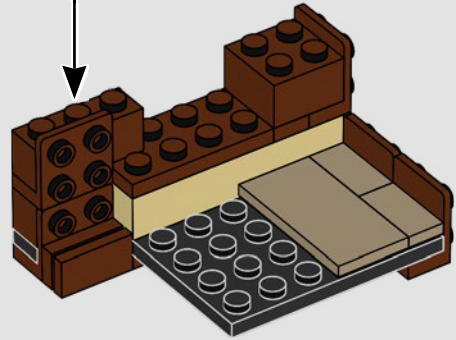
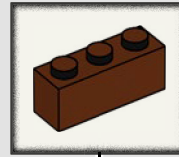

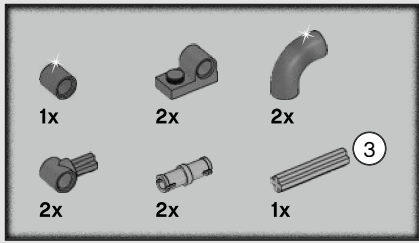

40

1

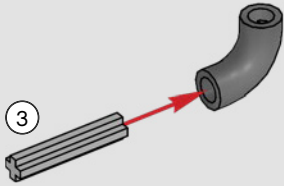

2

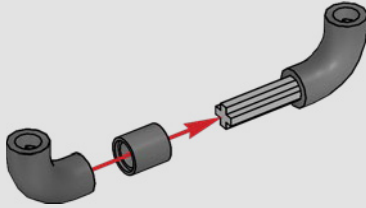

3

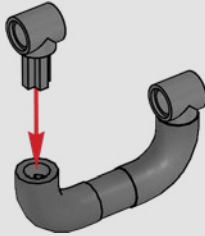

4

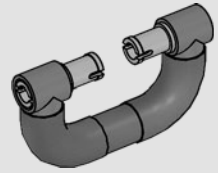

5

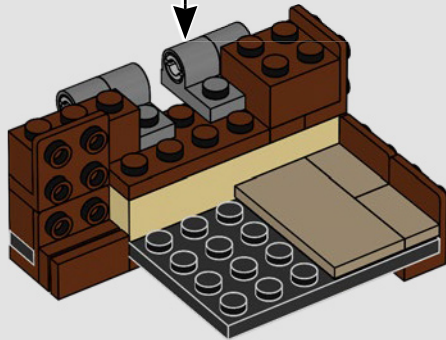
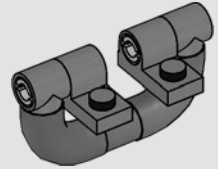

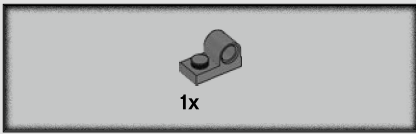

41

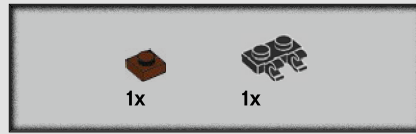
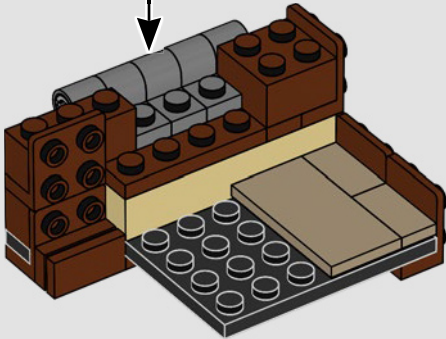
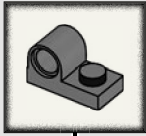

42

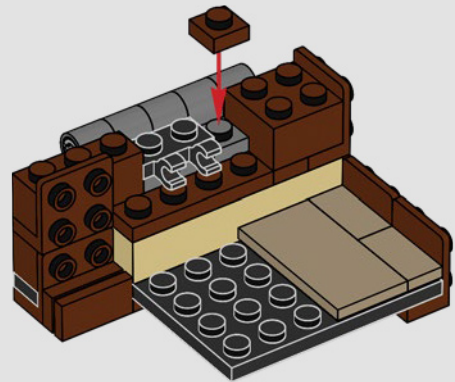

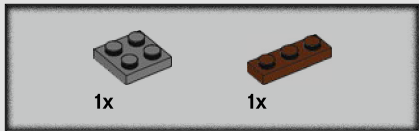

43

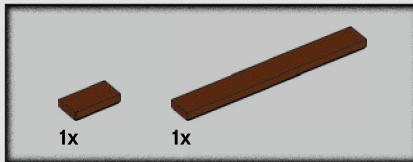
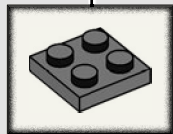
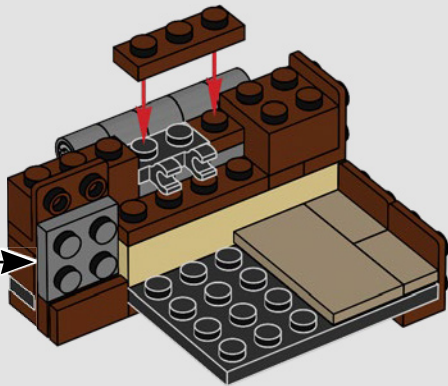

44

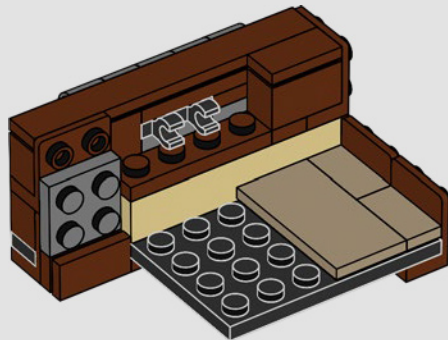

45

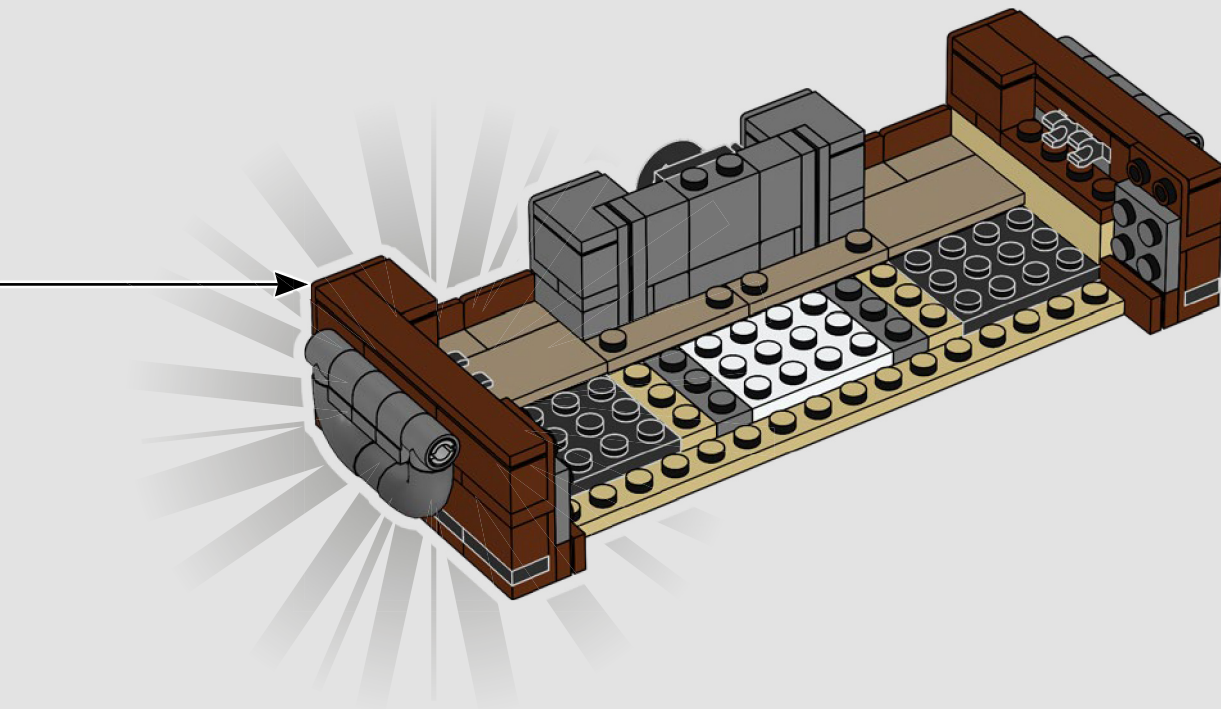

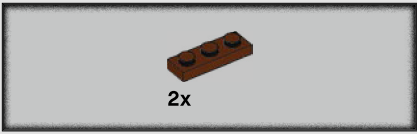

46

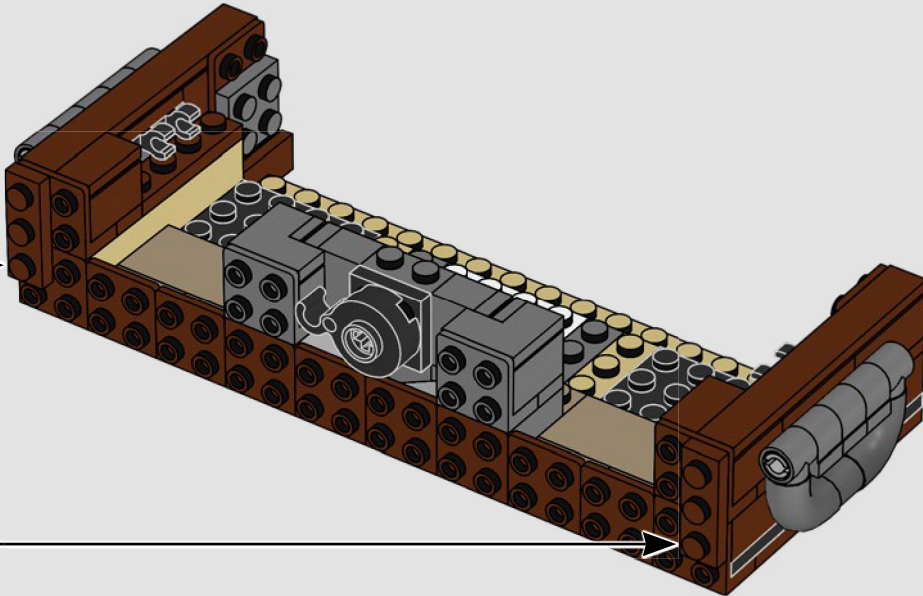

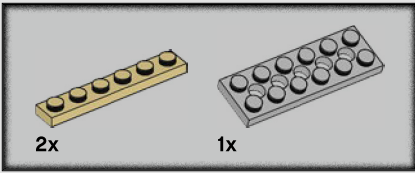

47

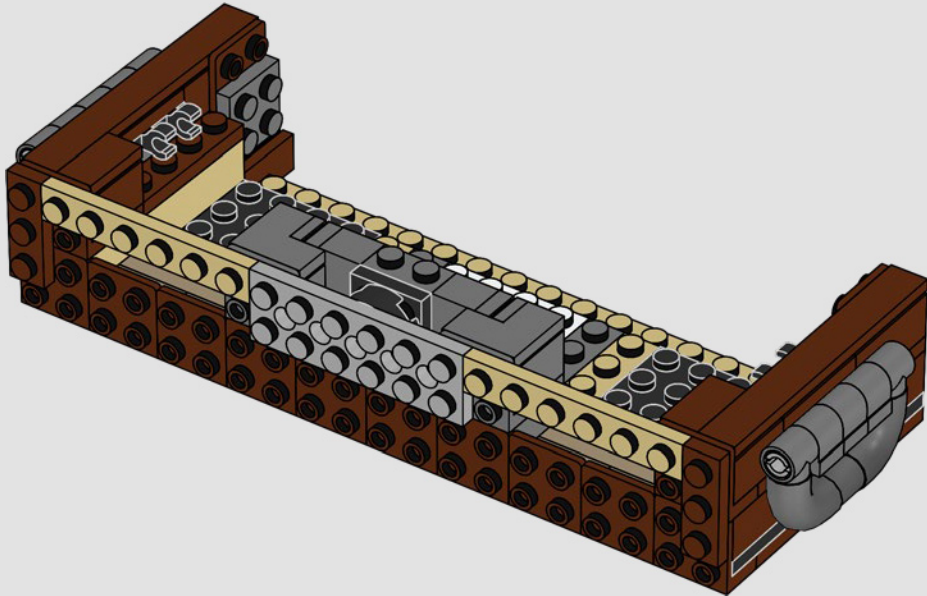

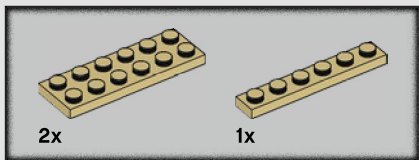

48

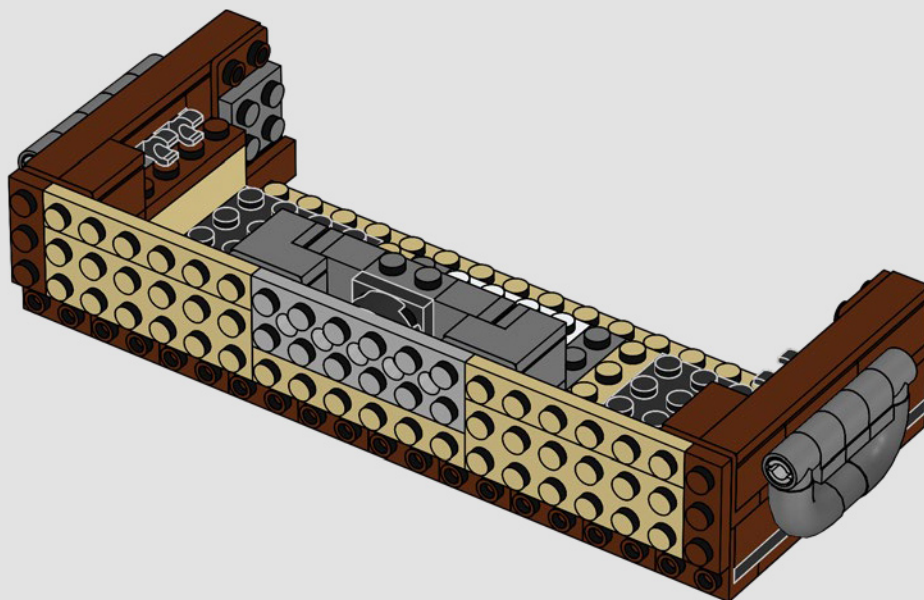

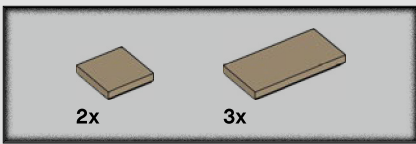

49

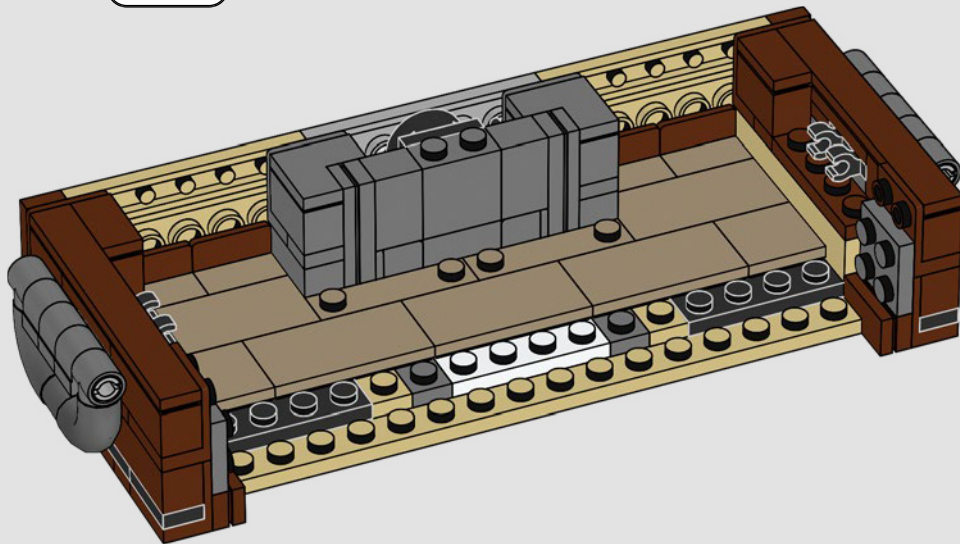

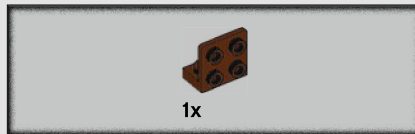
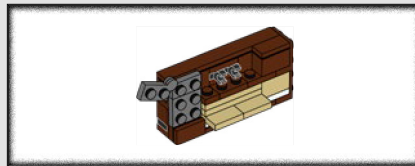
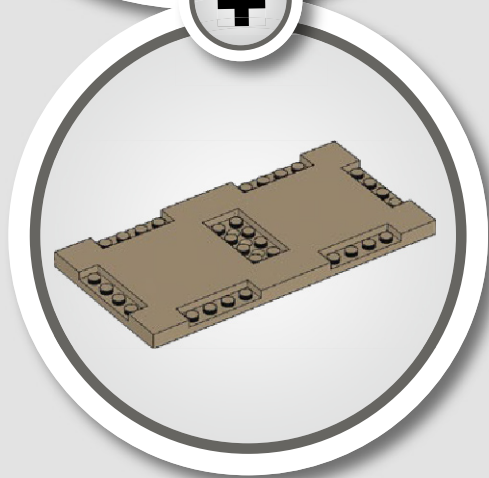

50

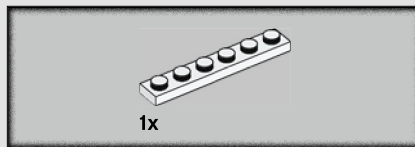

51

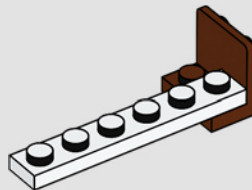

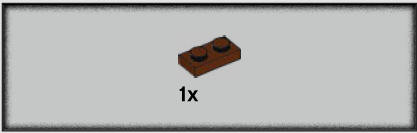

52

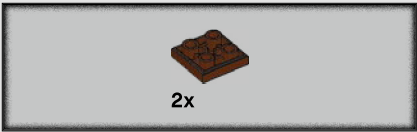
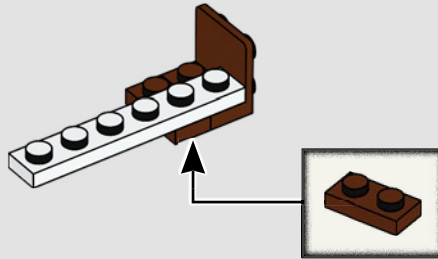

53

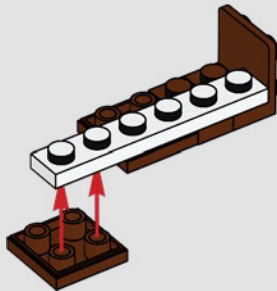

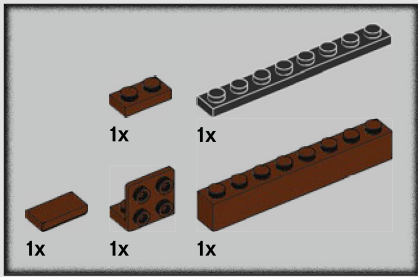

54

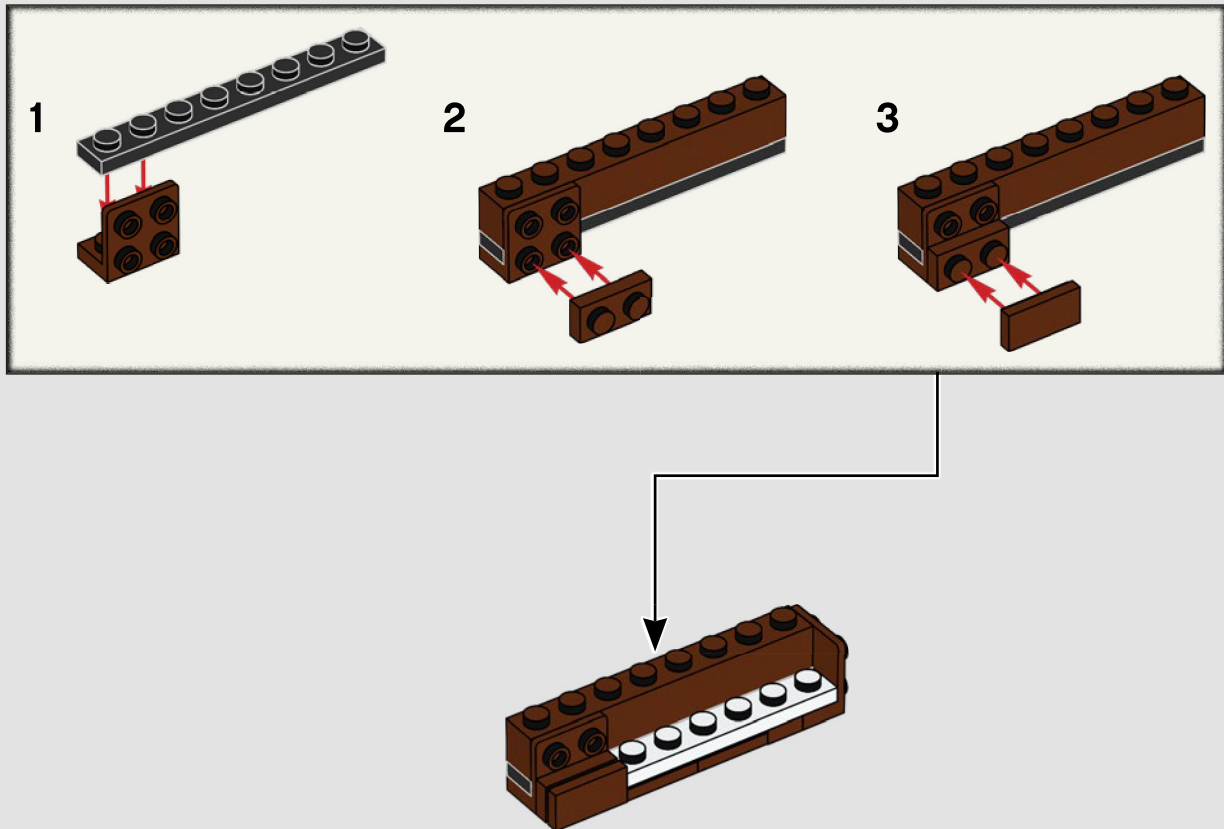

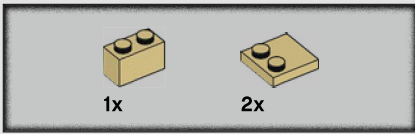

55

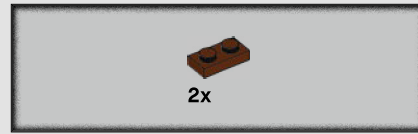
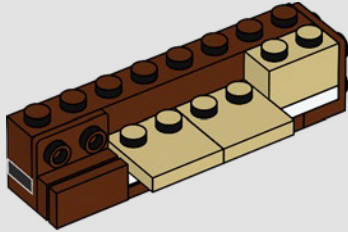

57

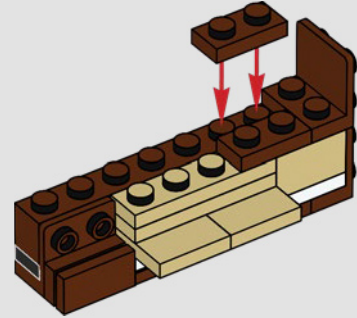

56

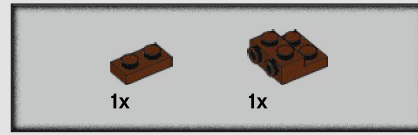
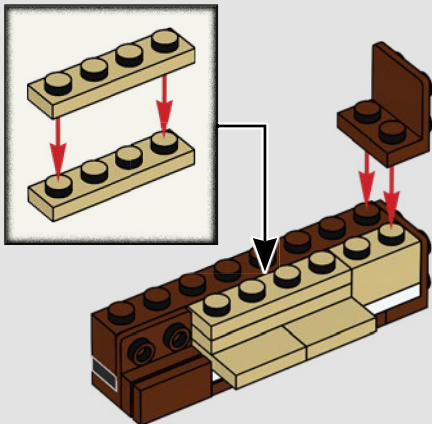

58

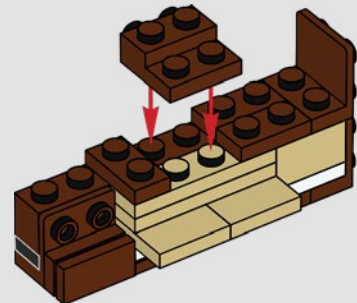

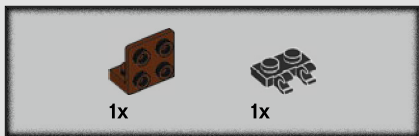

59

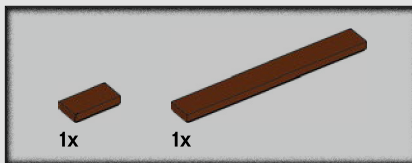
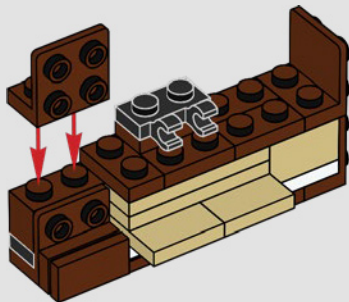

61

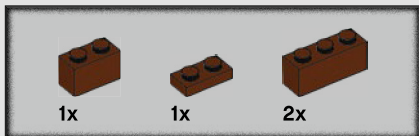
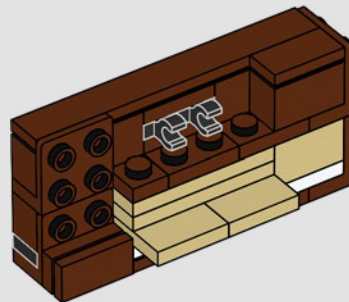

60

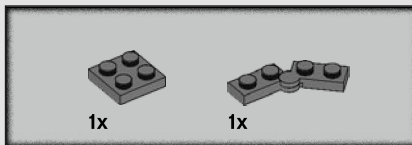
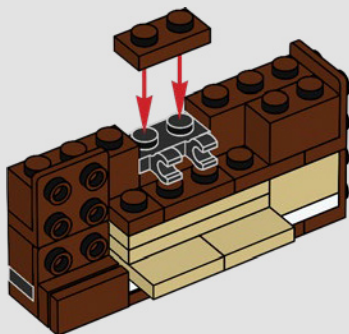

62

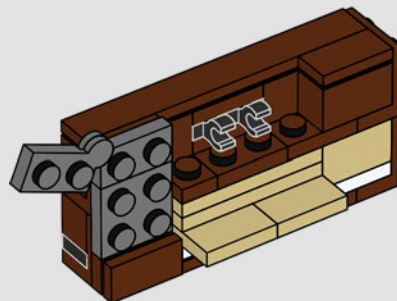

63

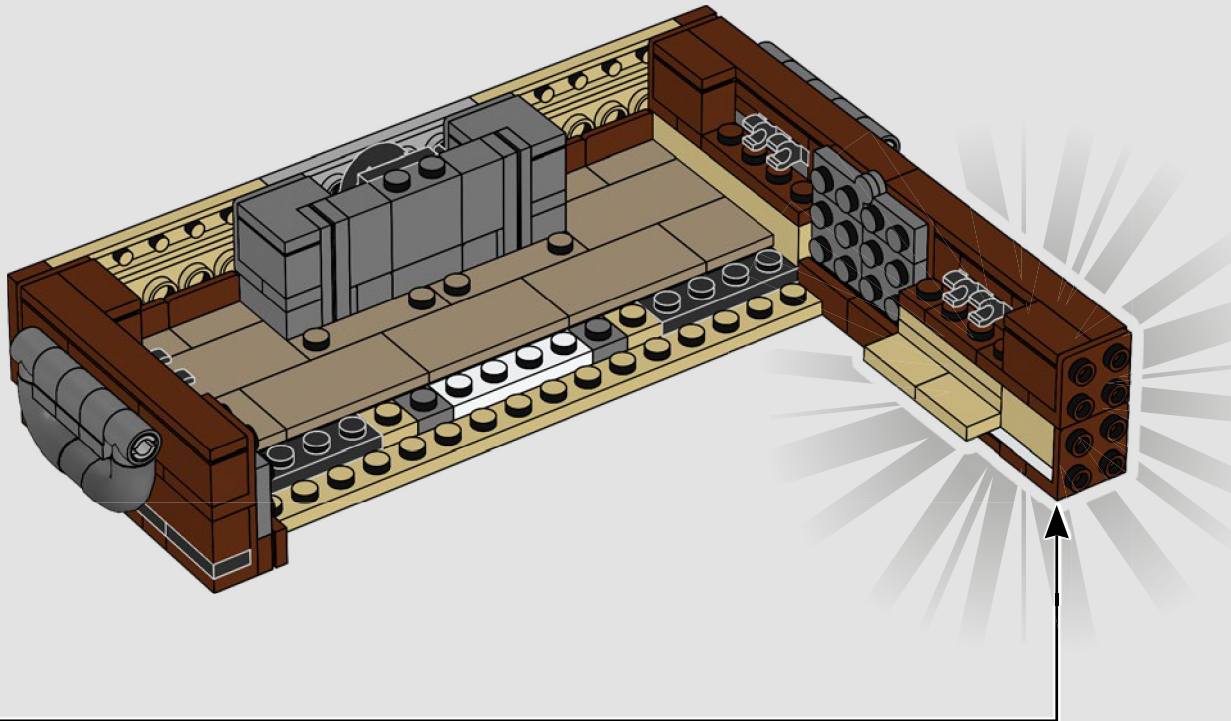

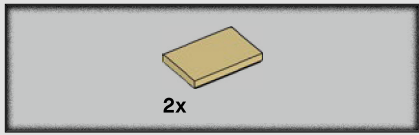

64

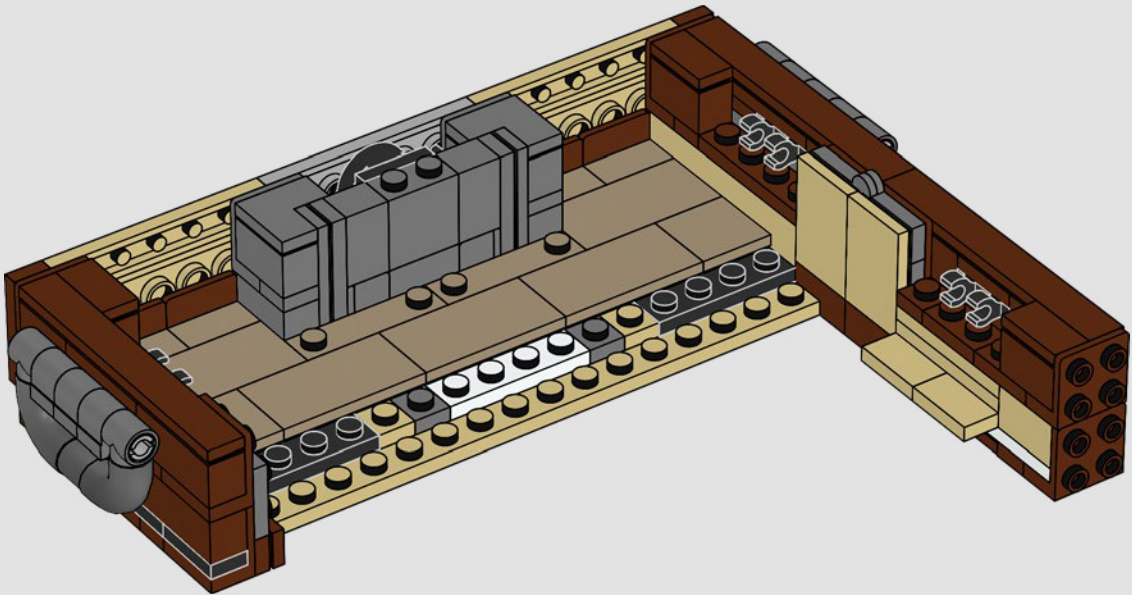

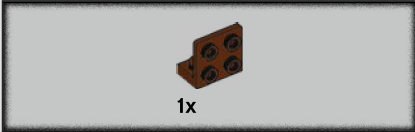
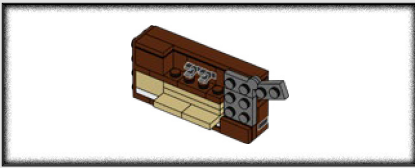

65

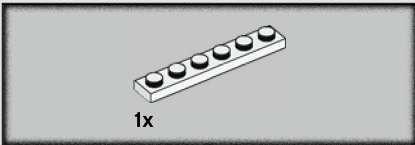

66

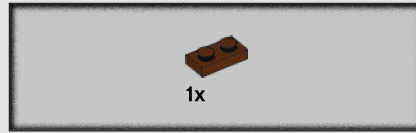
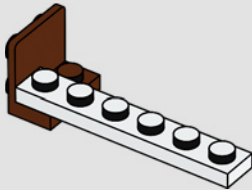

67

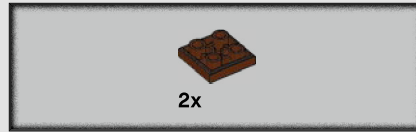
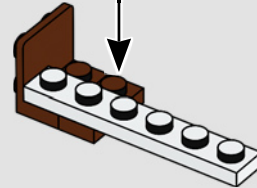

68

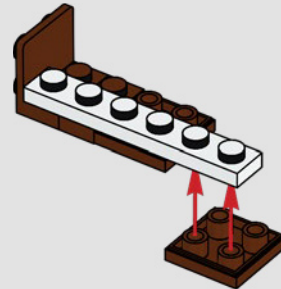

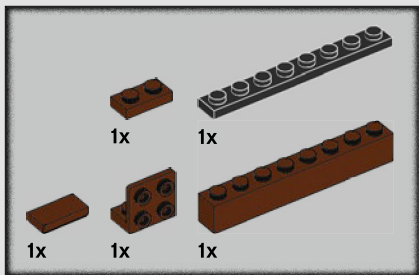

69

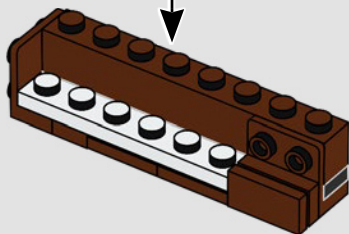
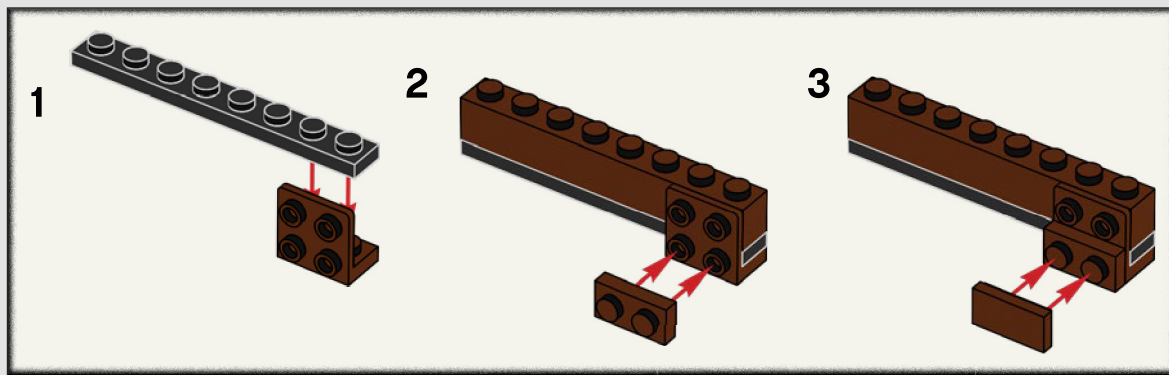

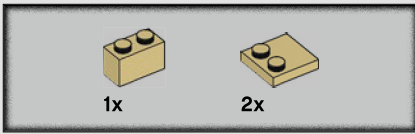

70

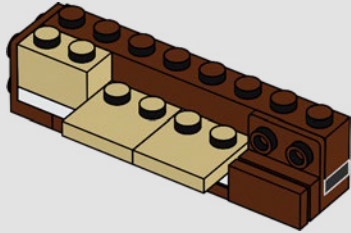

71

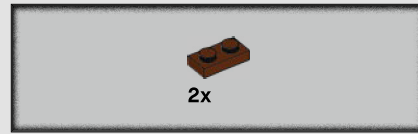
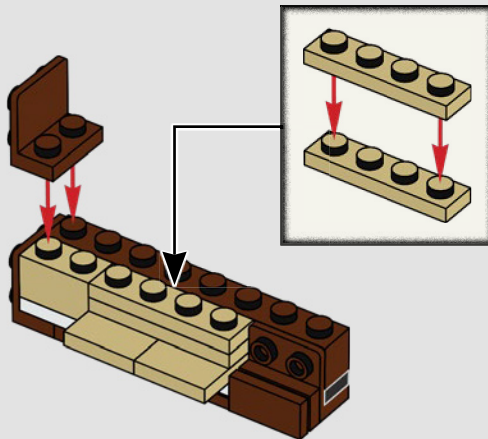

72

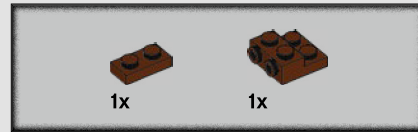
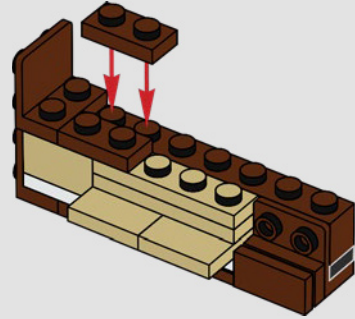

73

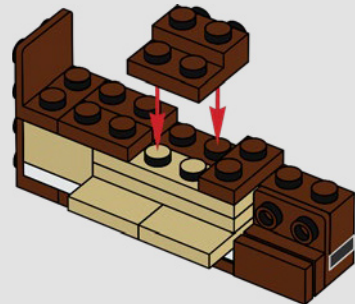

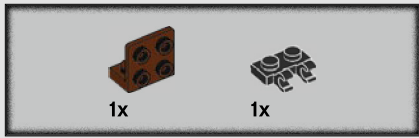

74

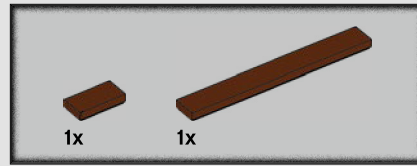
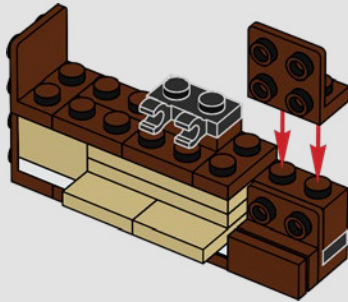

76

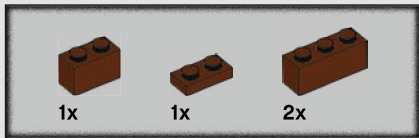
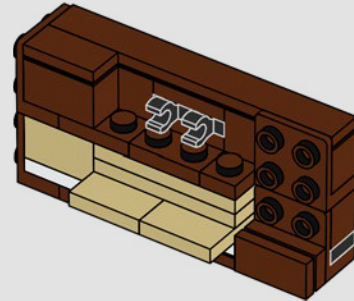

75

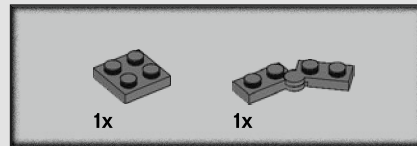
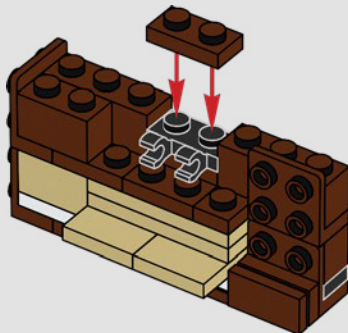

77

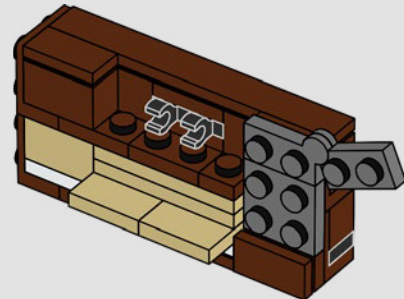

78

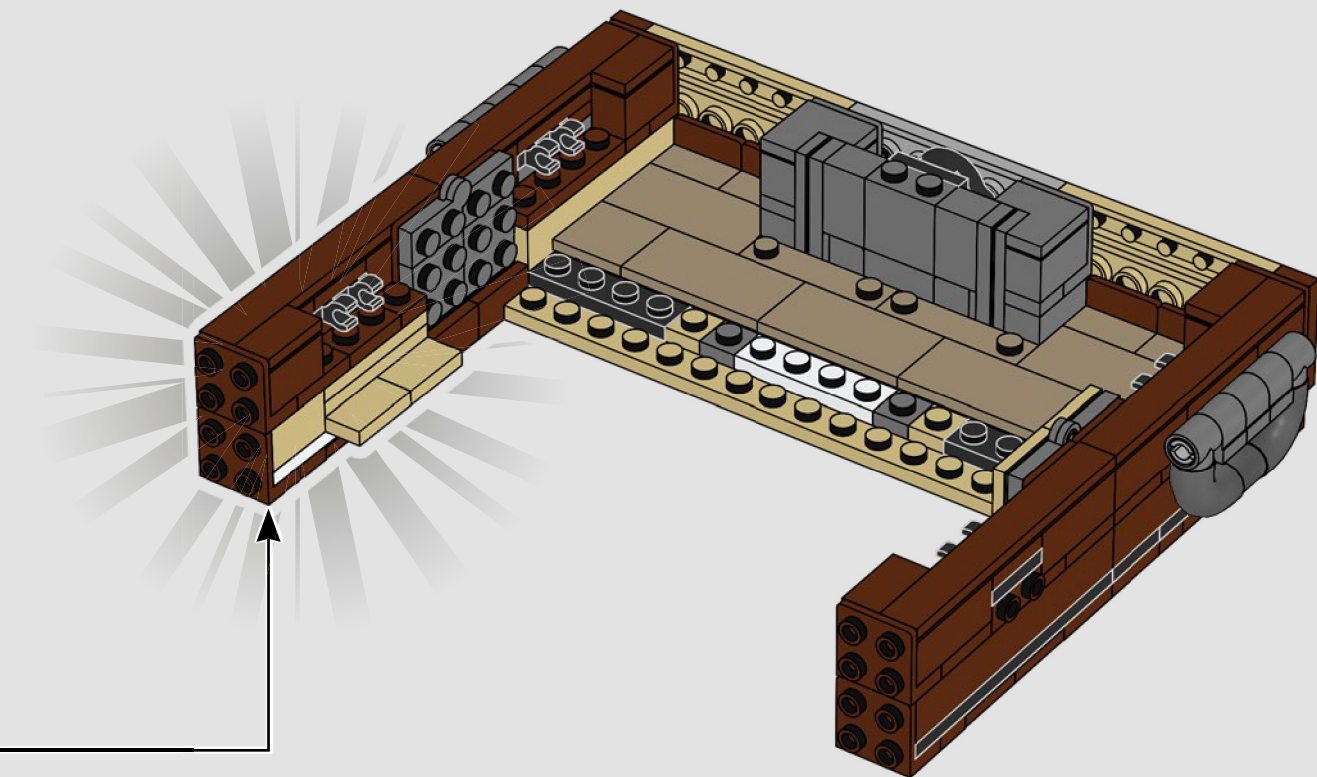

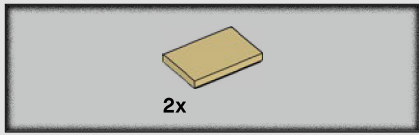

79

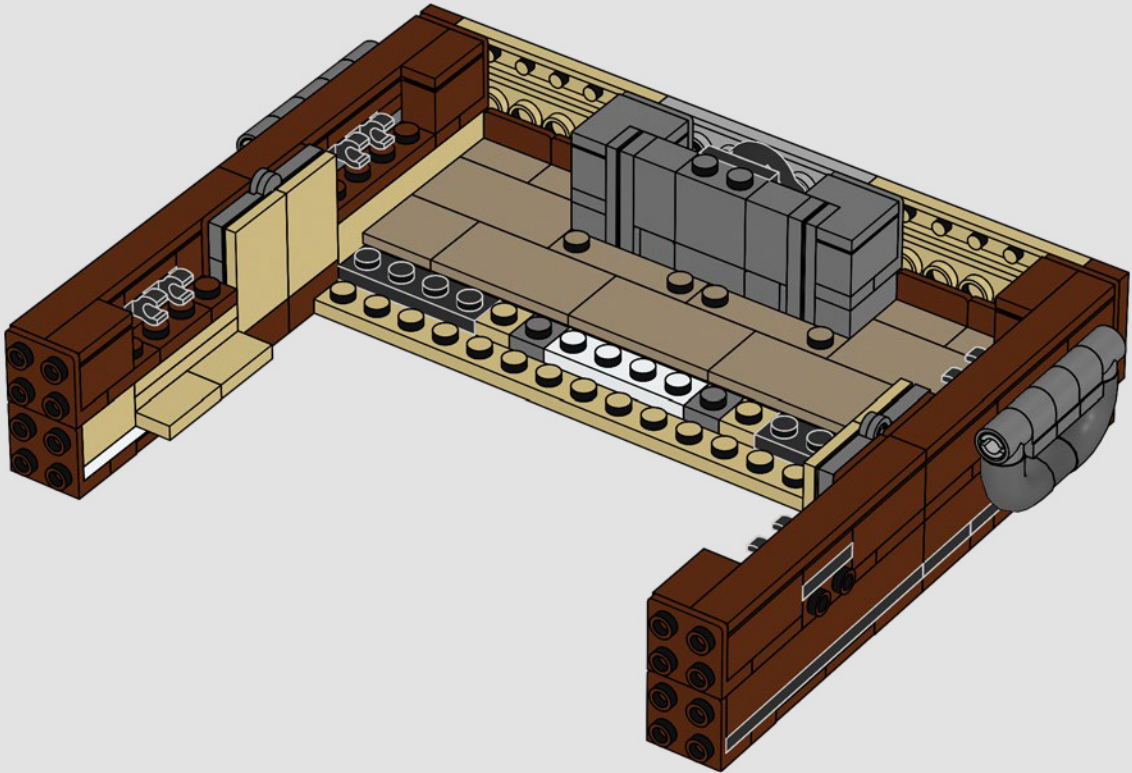

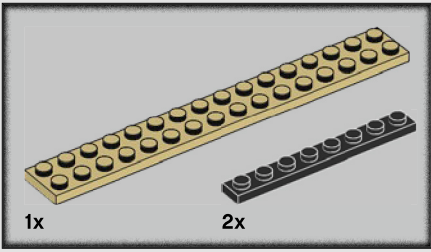

80

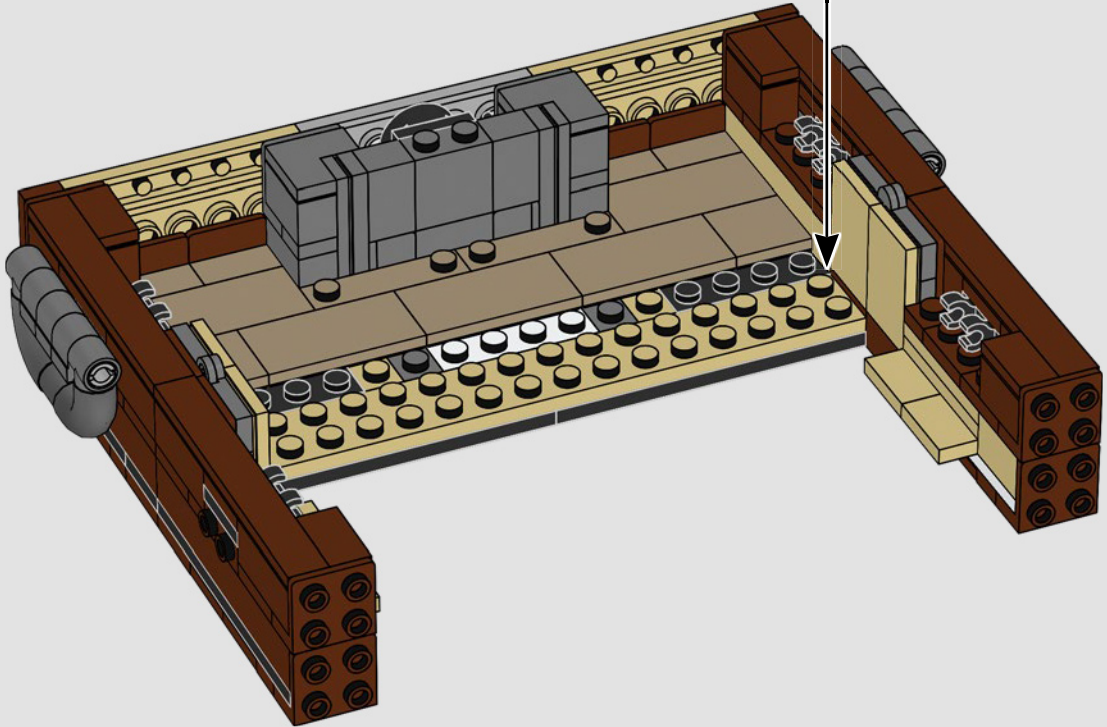
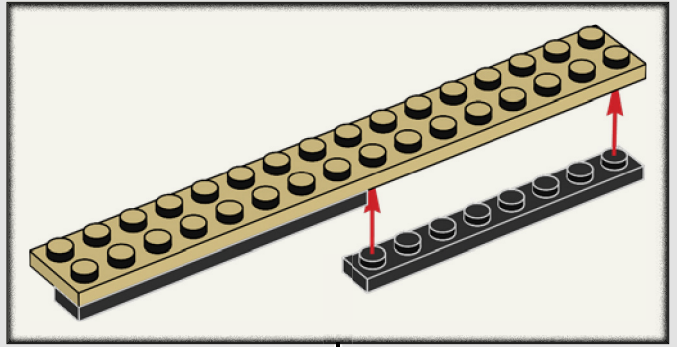

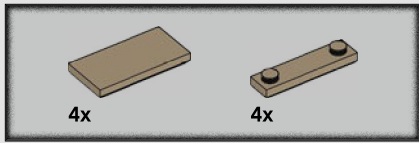

81

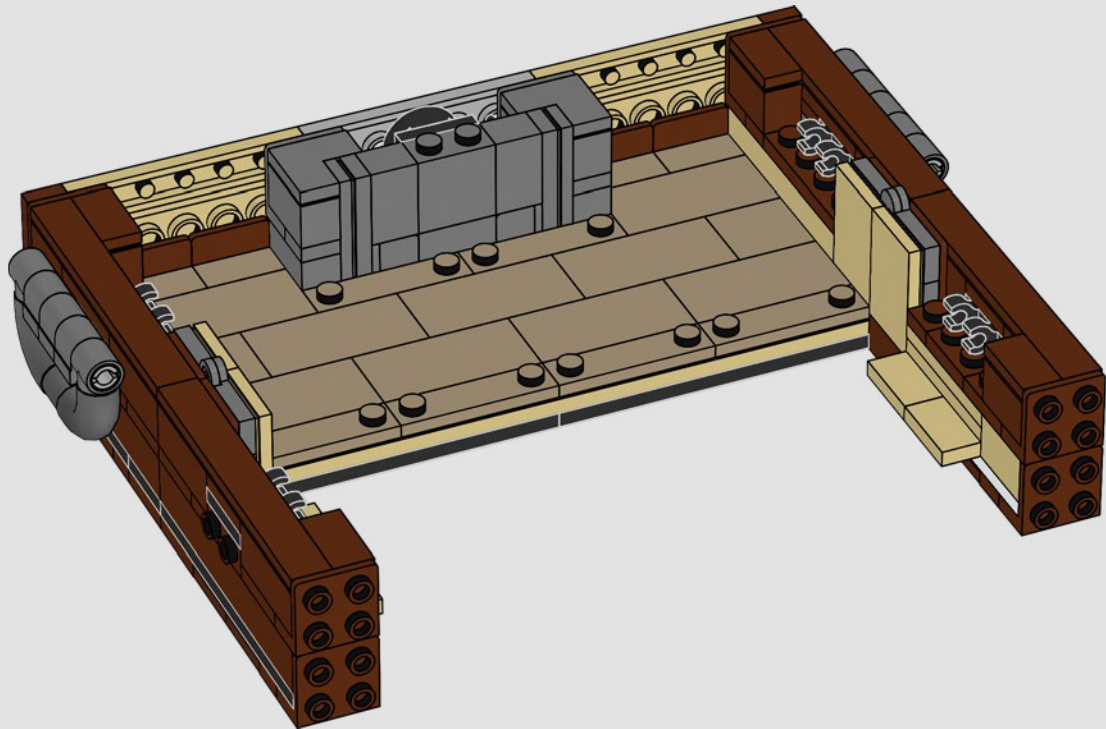

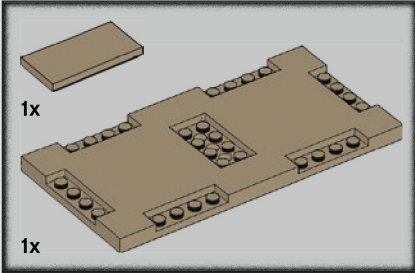
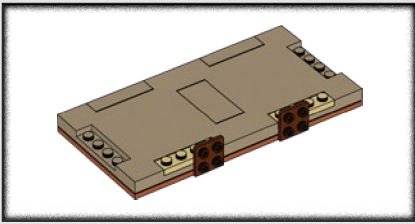

82

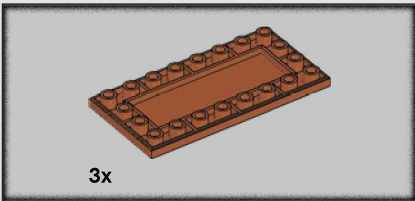
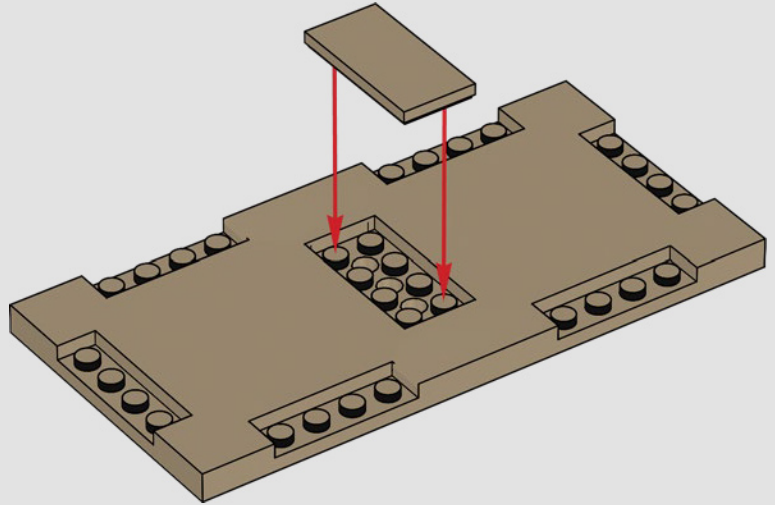

83

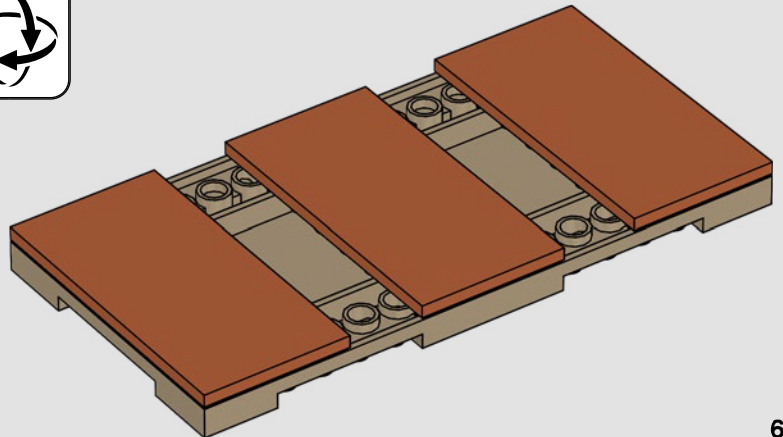
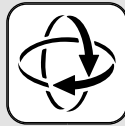

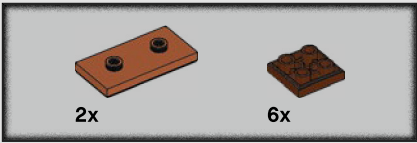

84

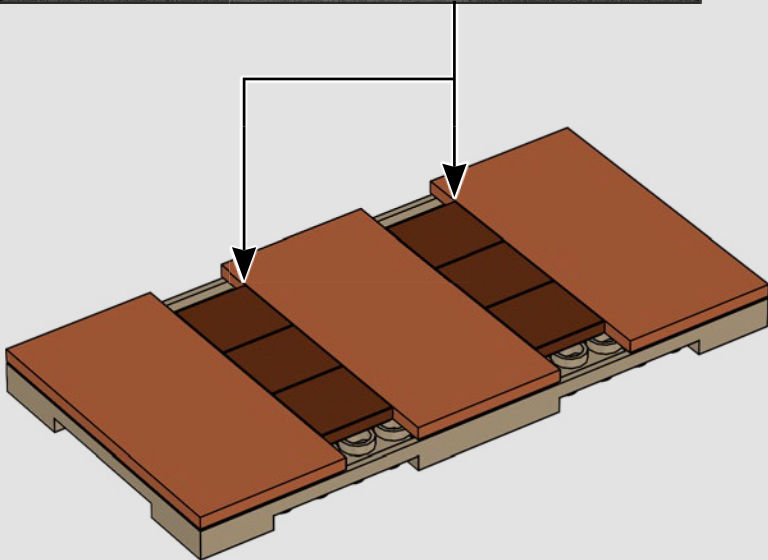
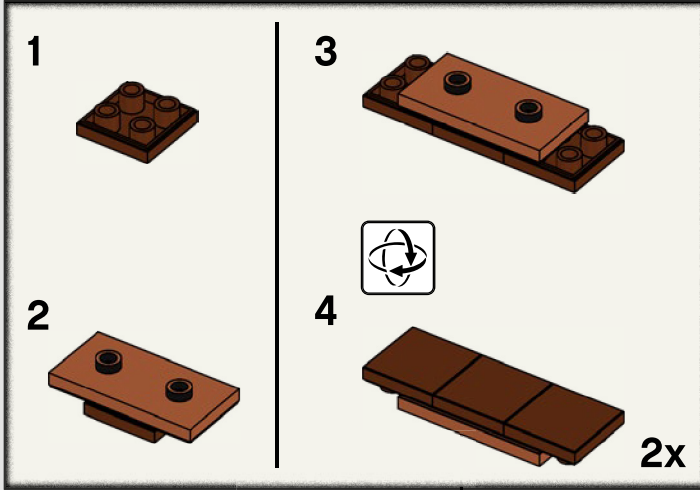

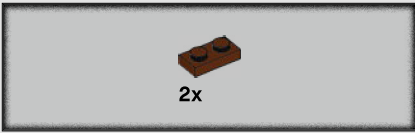

85

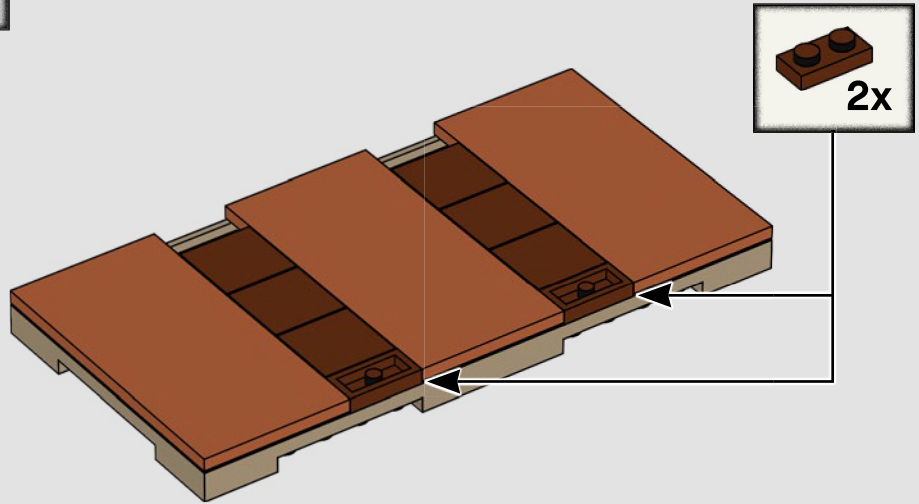

86

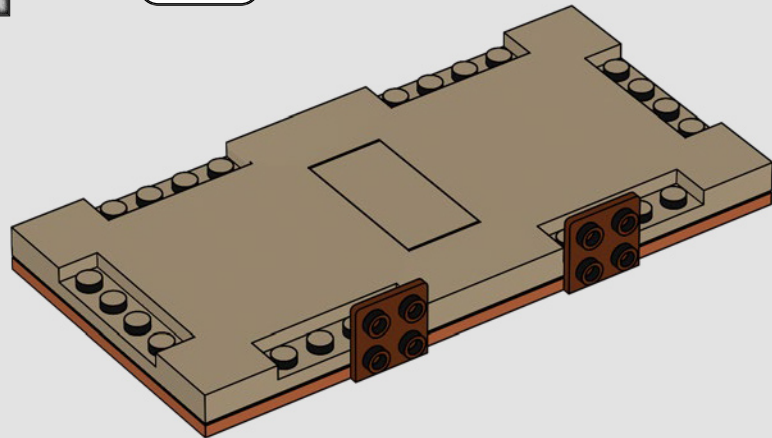
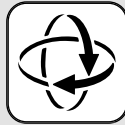

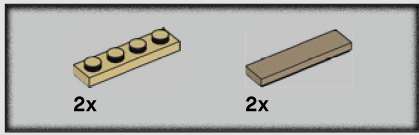

87

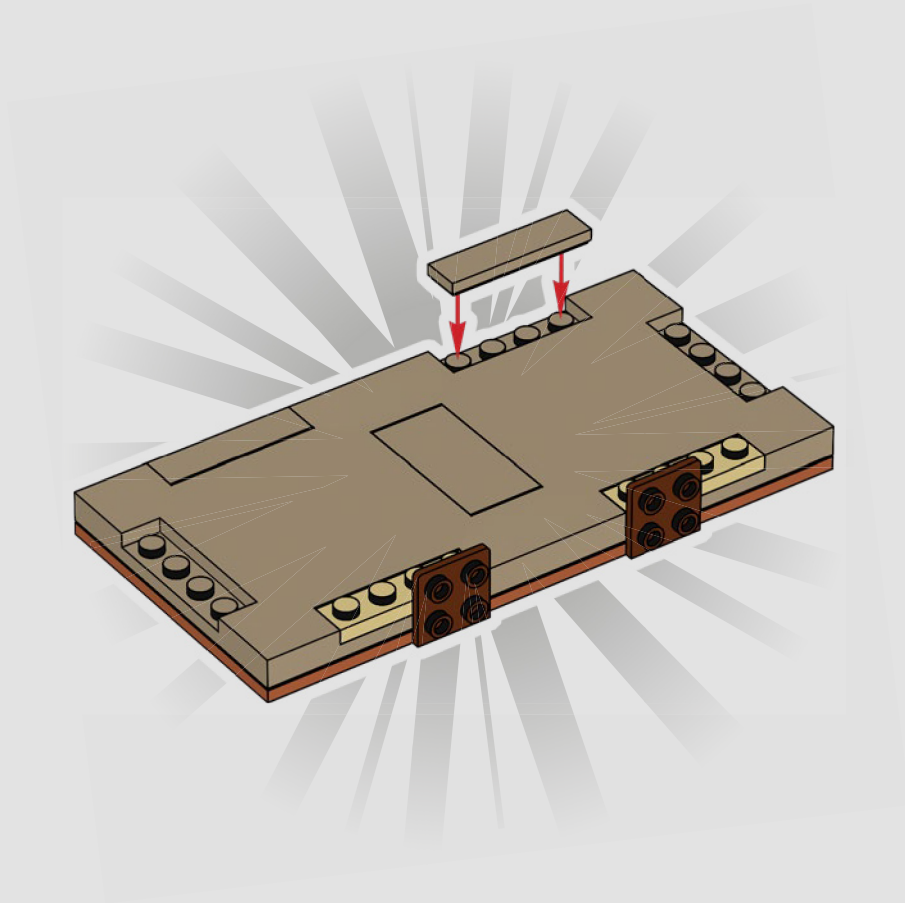

88

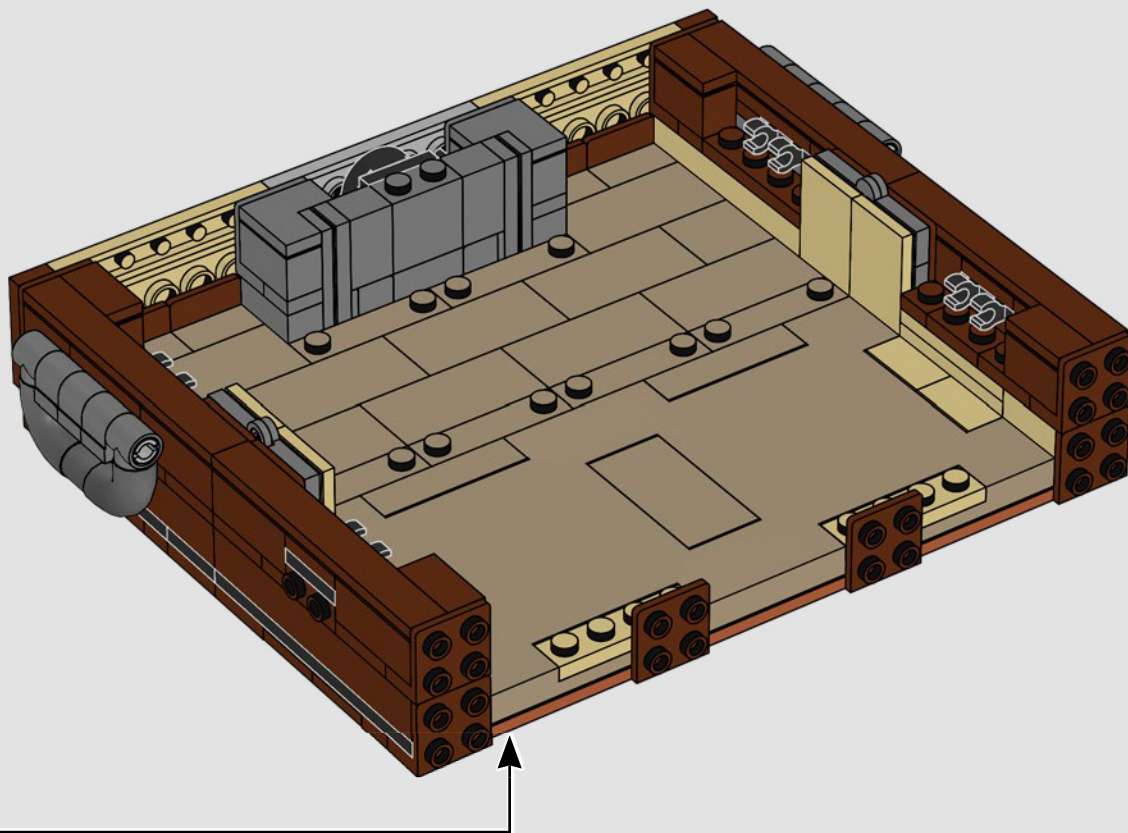

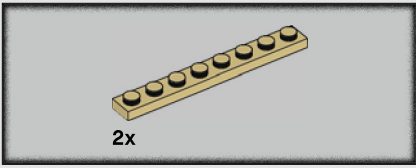

89

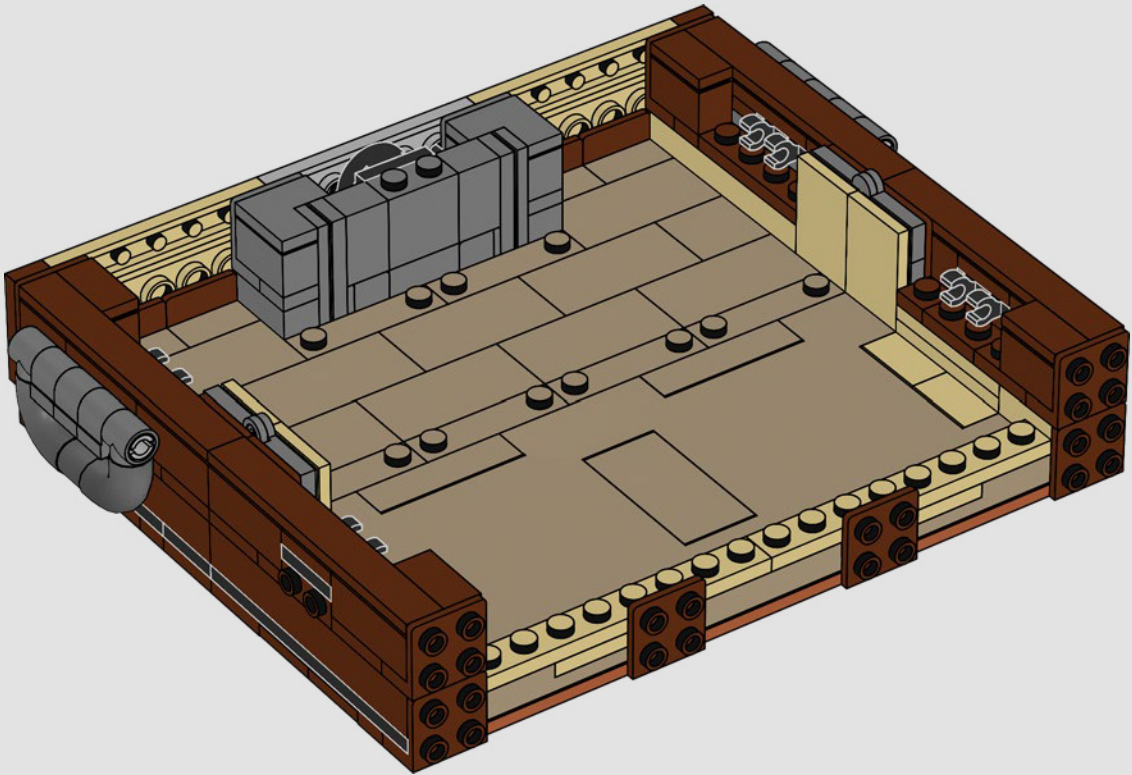

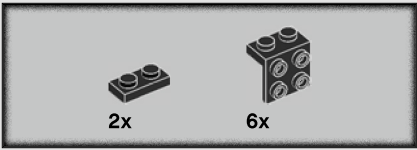

90

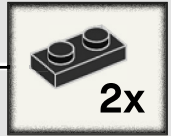
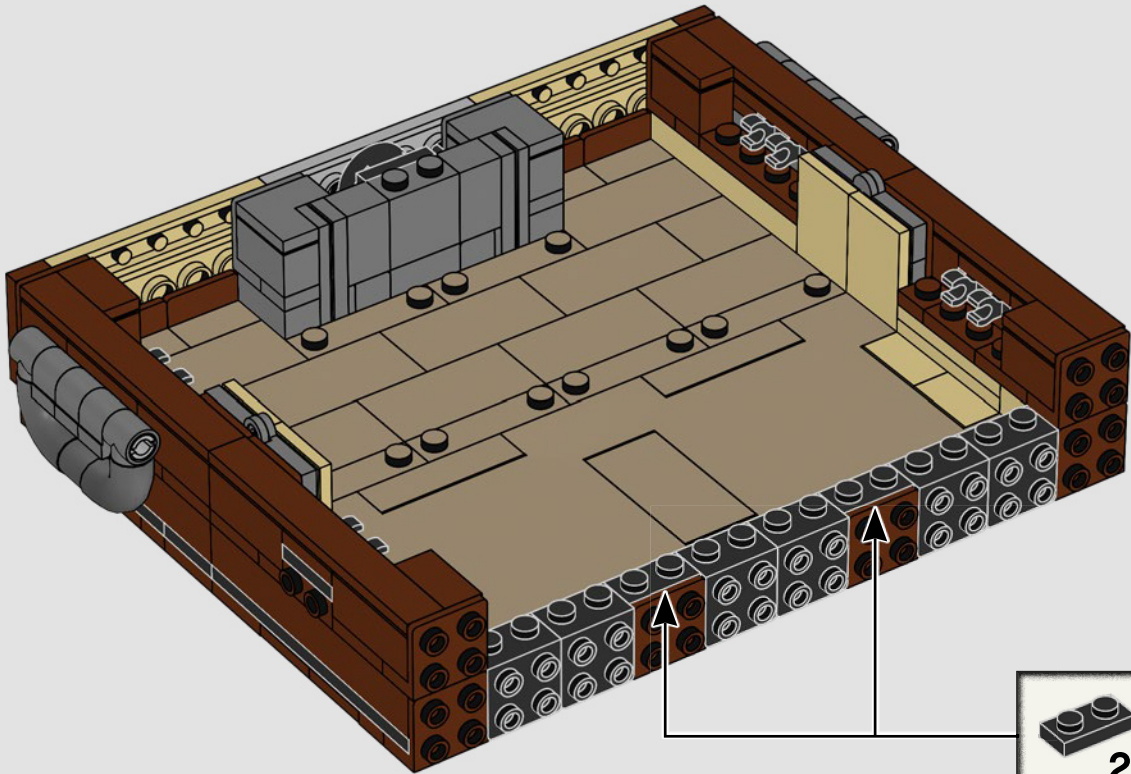

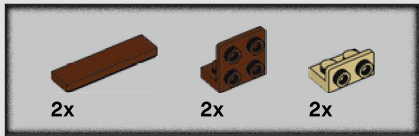

91

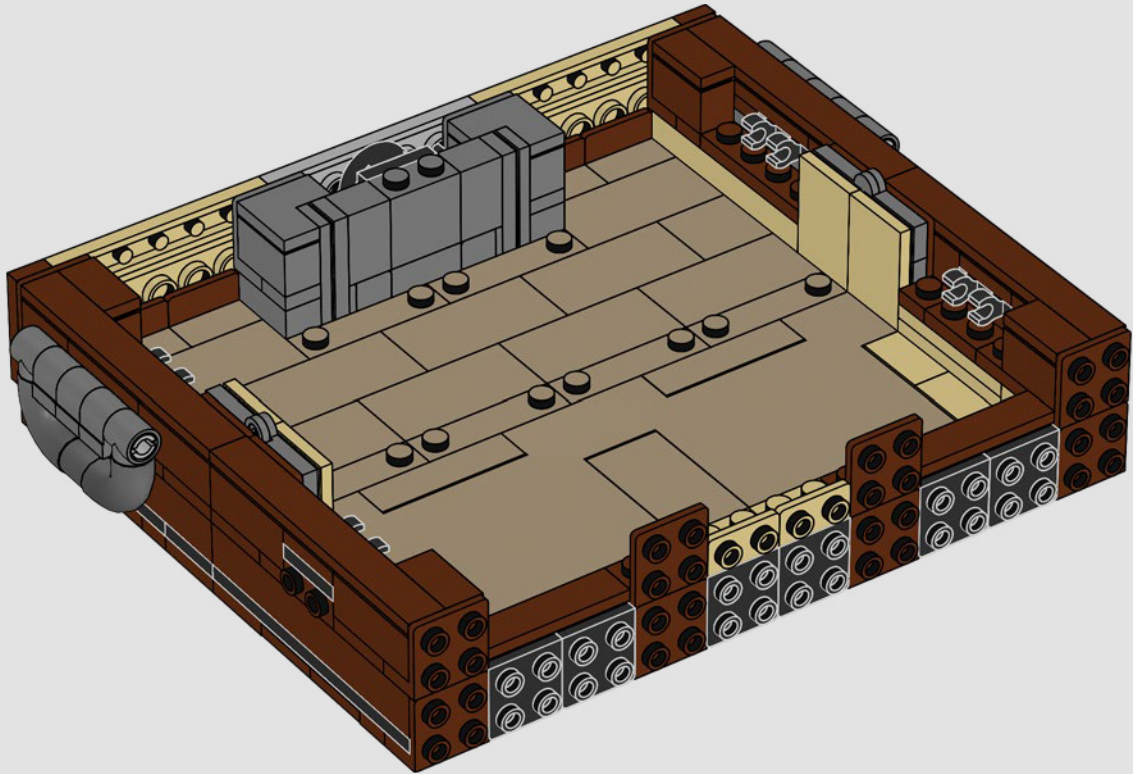

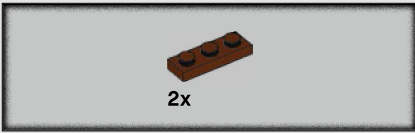

92

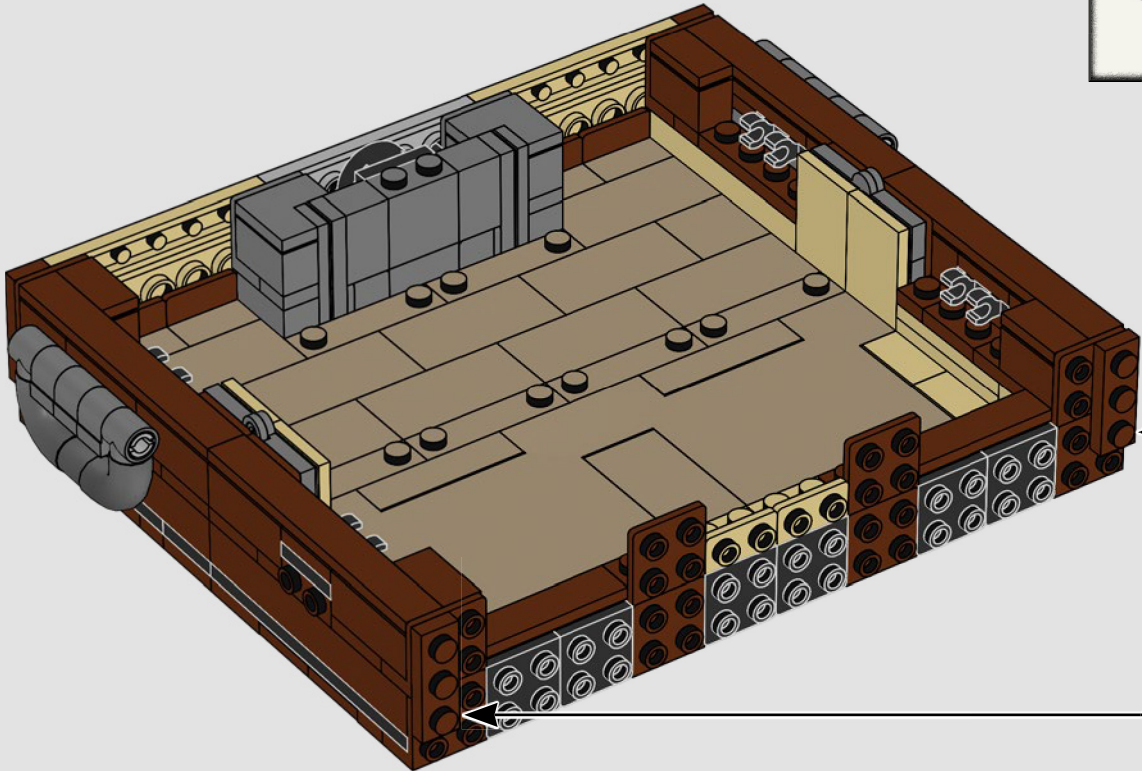
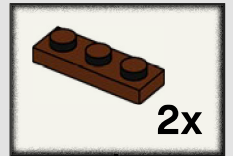

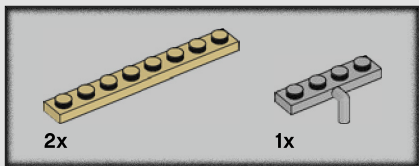

93

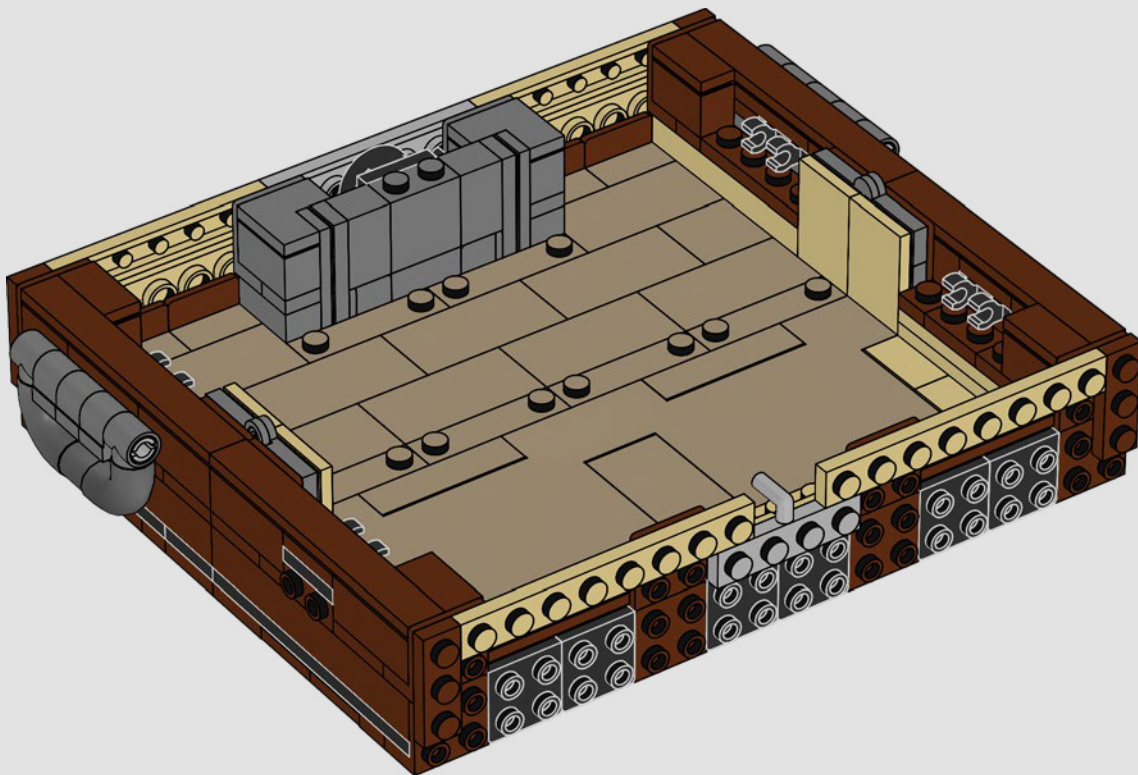

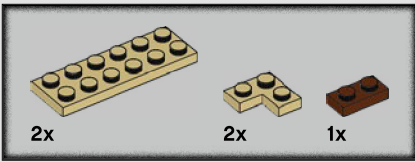

94

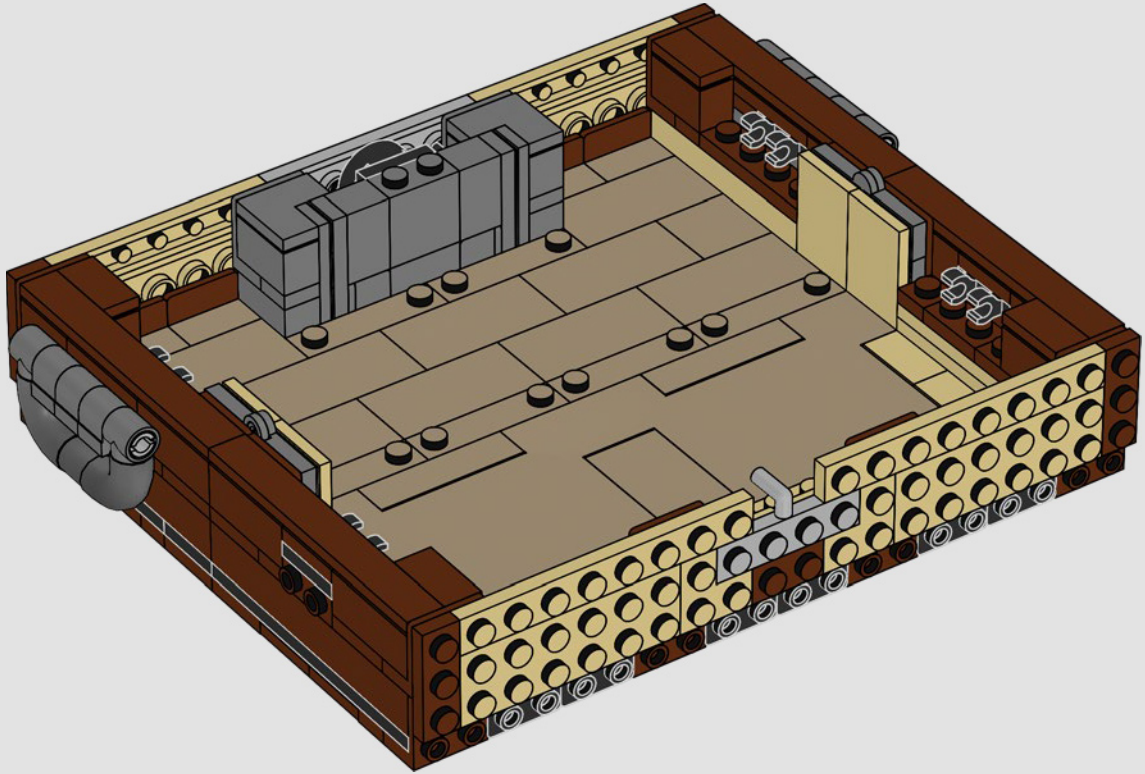



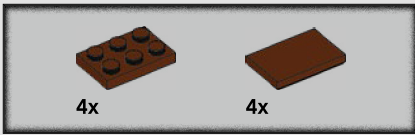

95

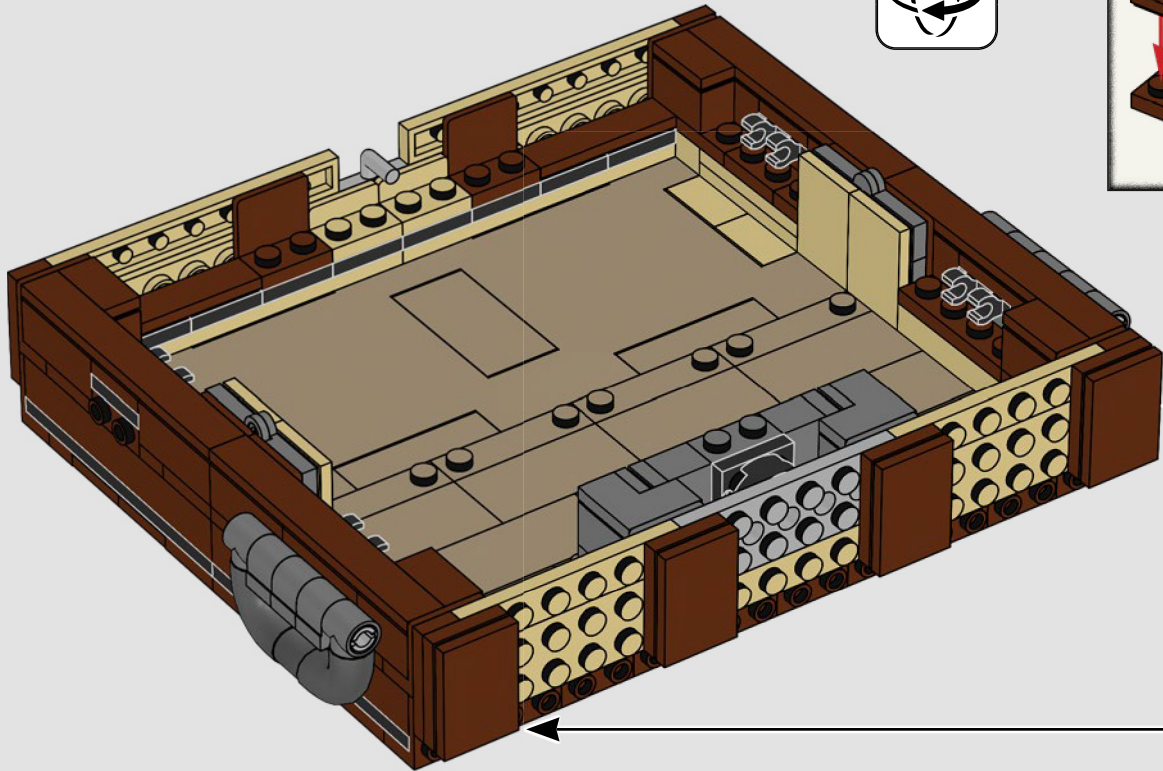
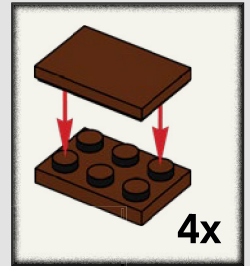
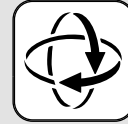

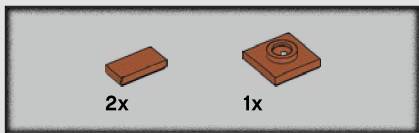

96

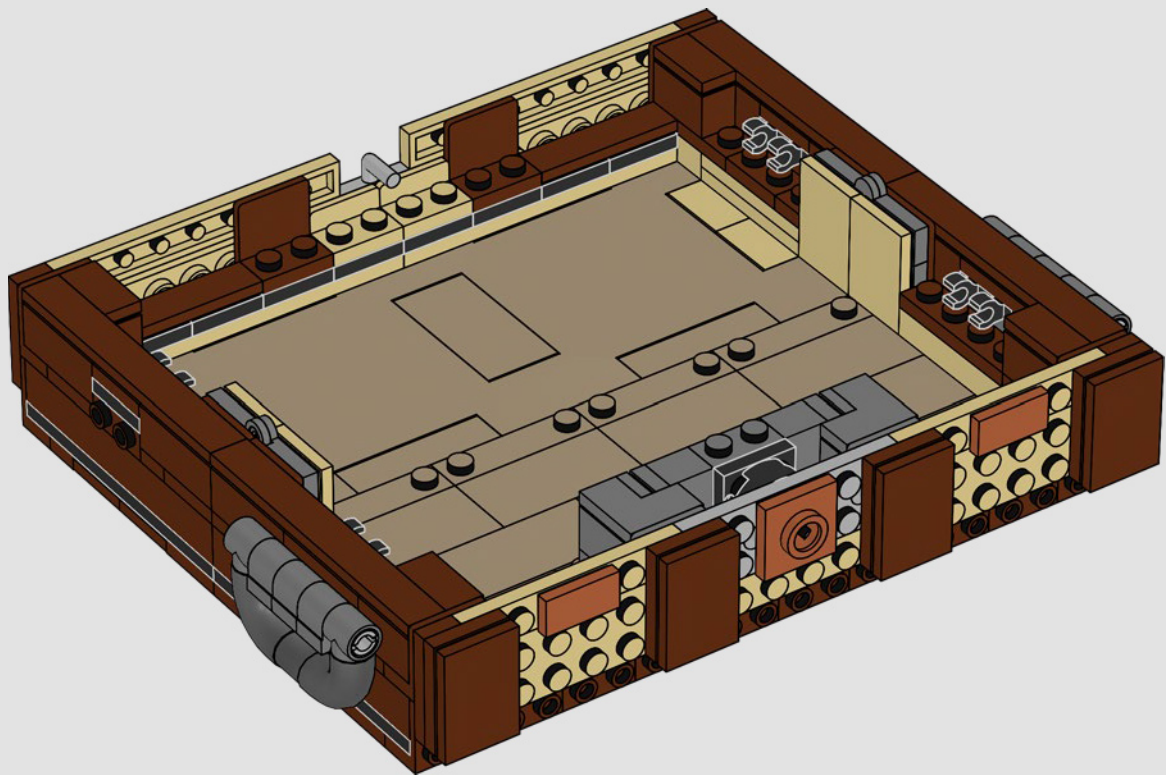

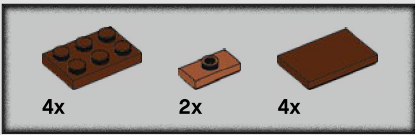

97

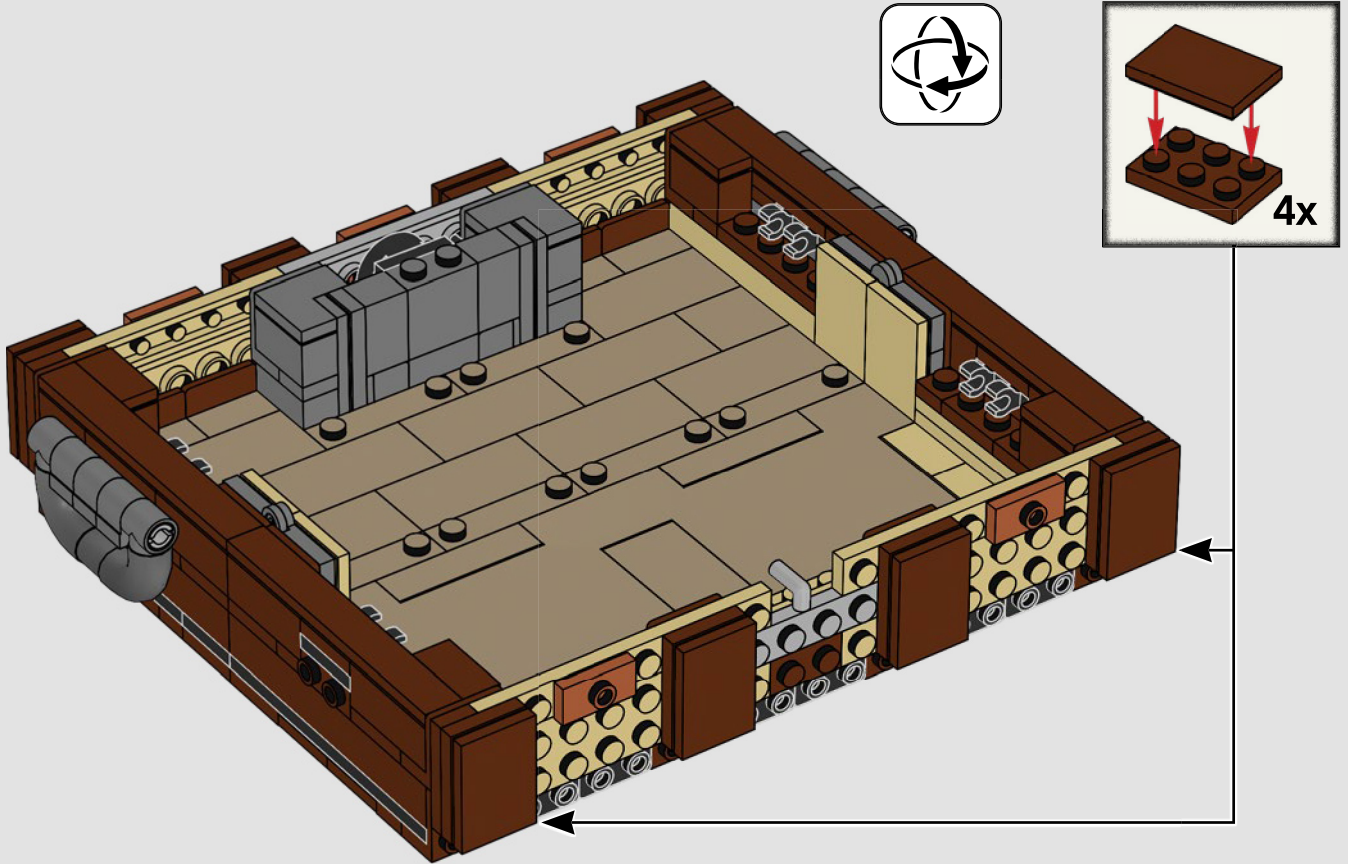

98

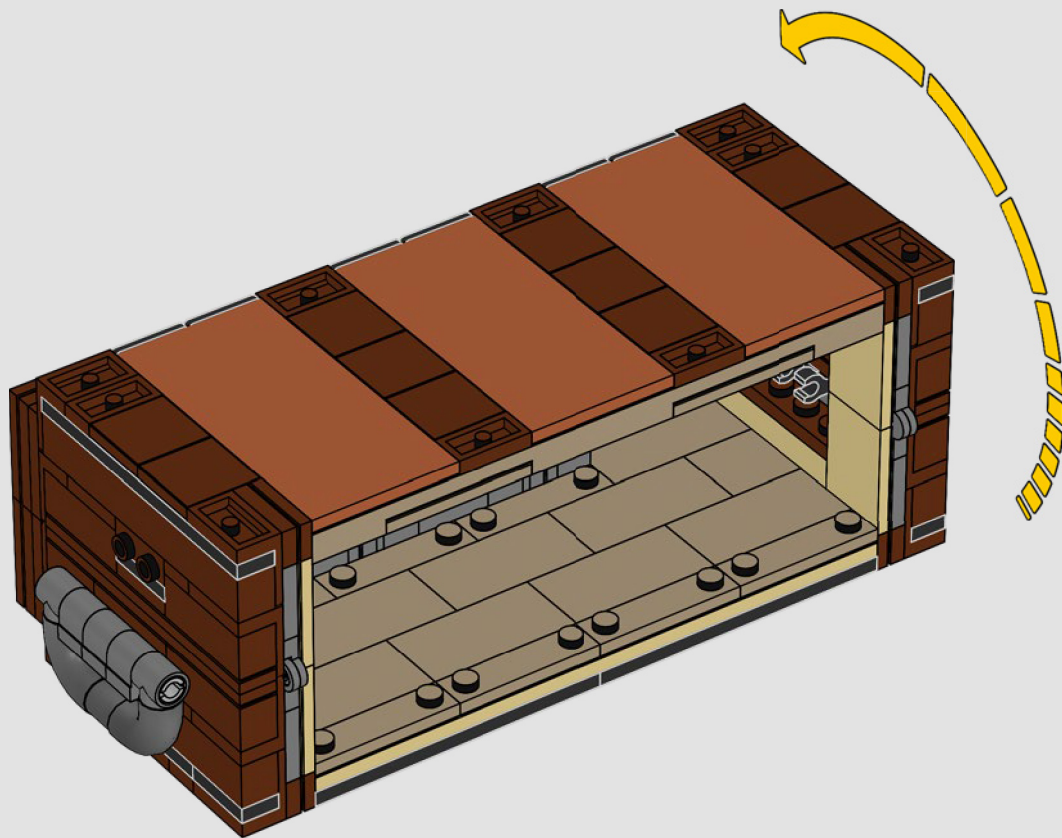

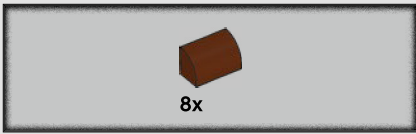

99

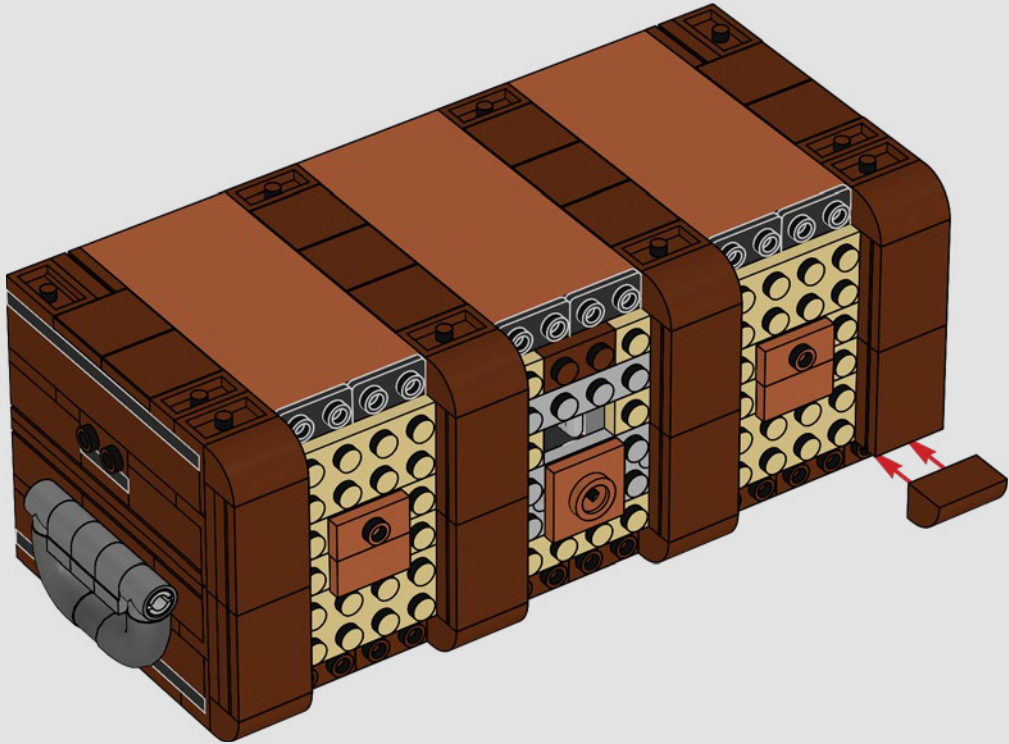

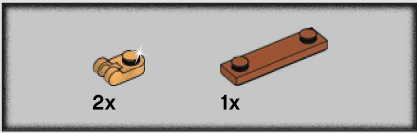

100

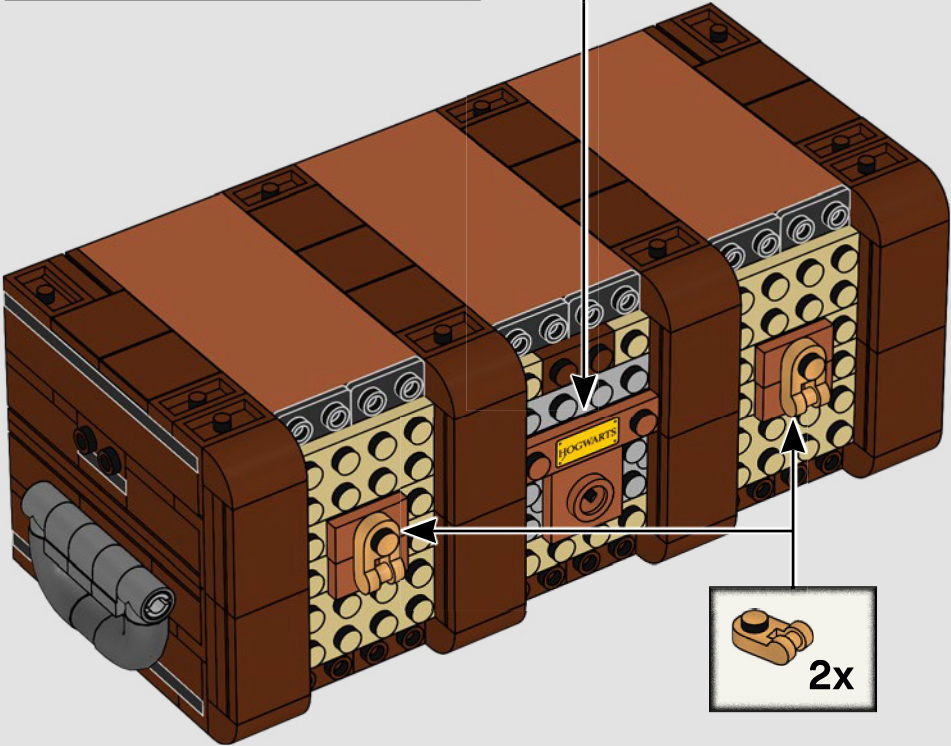
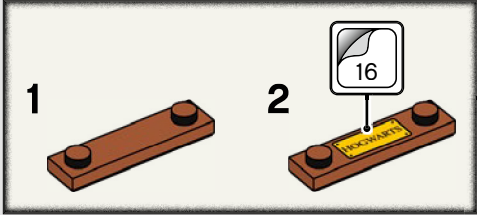

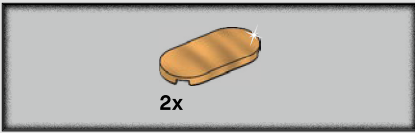

101

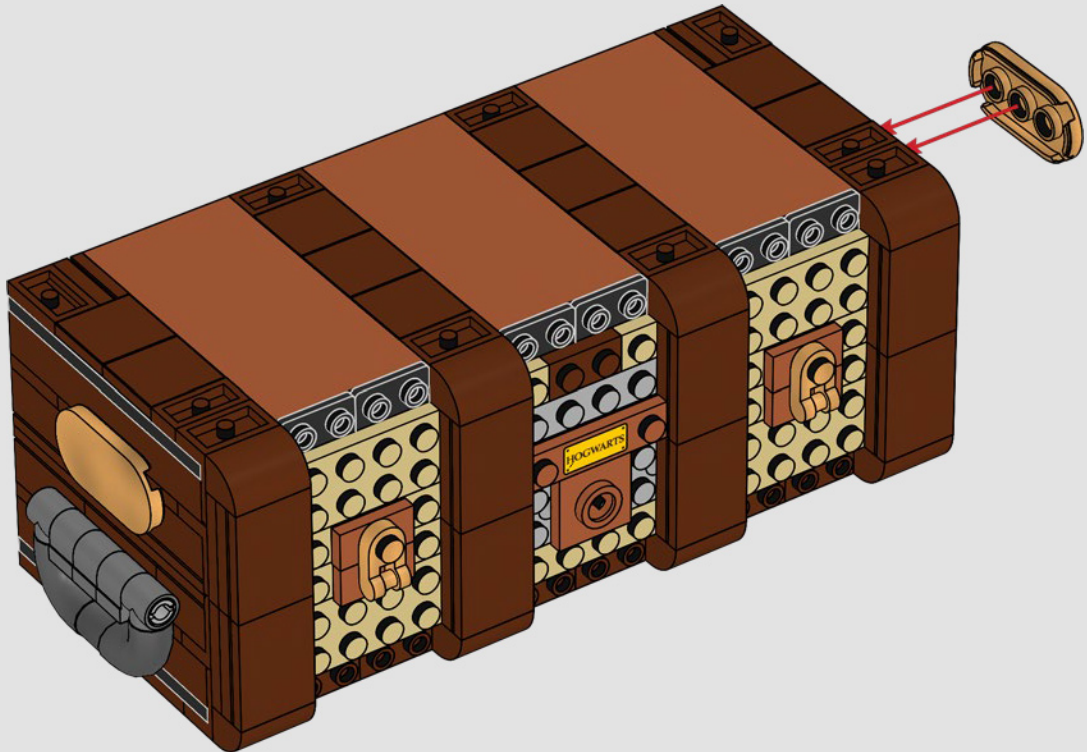

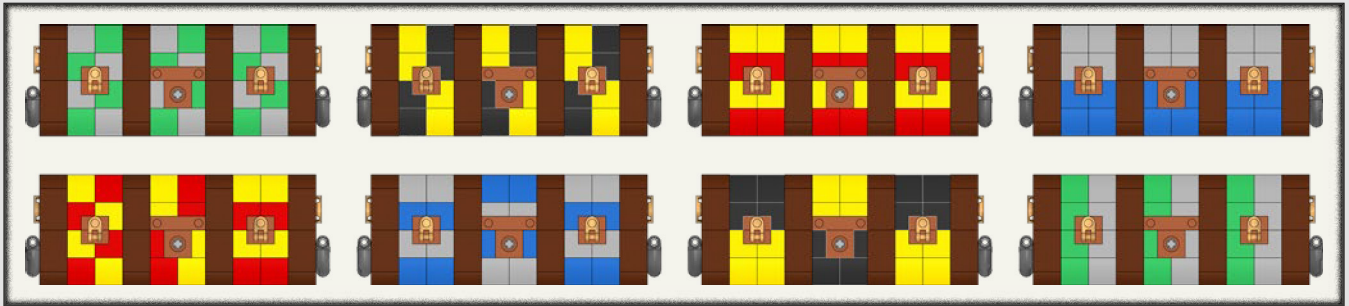
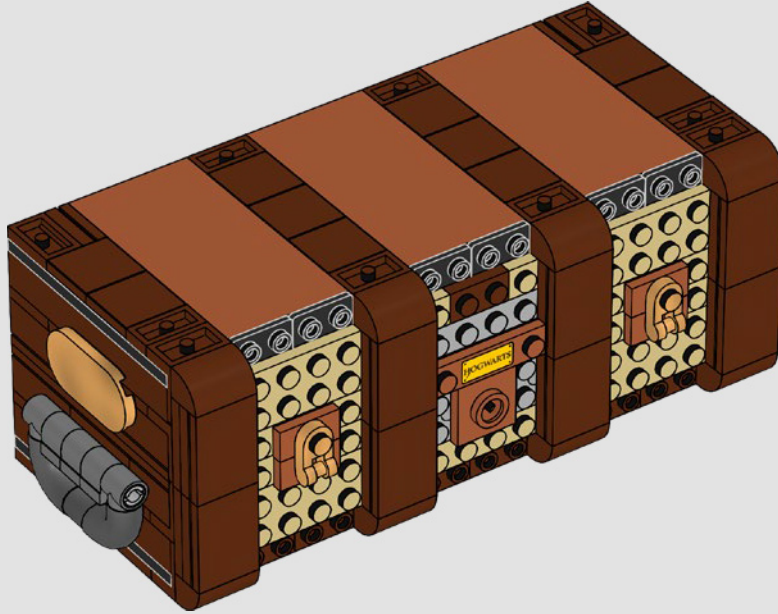

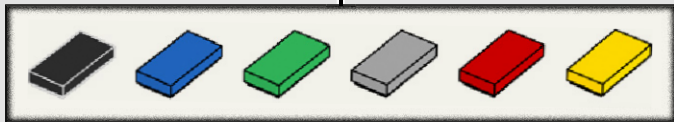
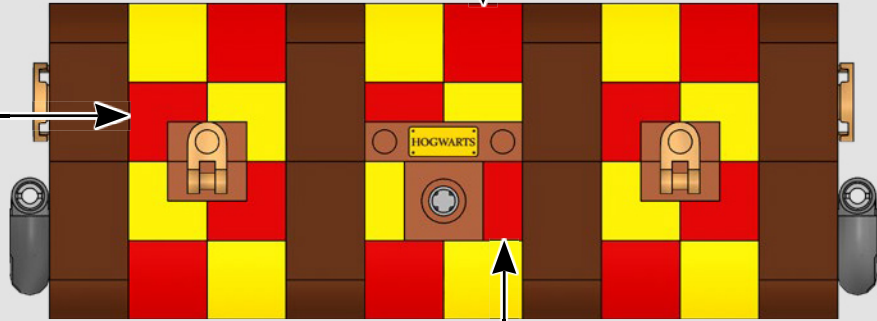
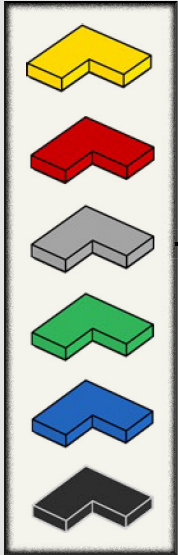
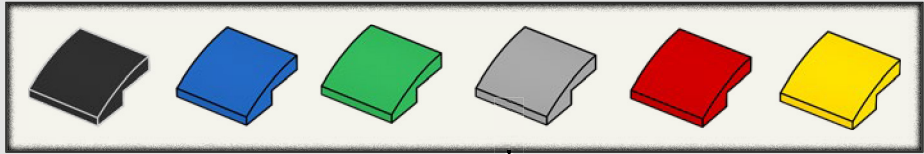

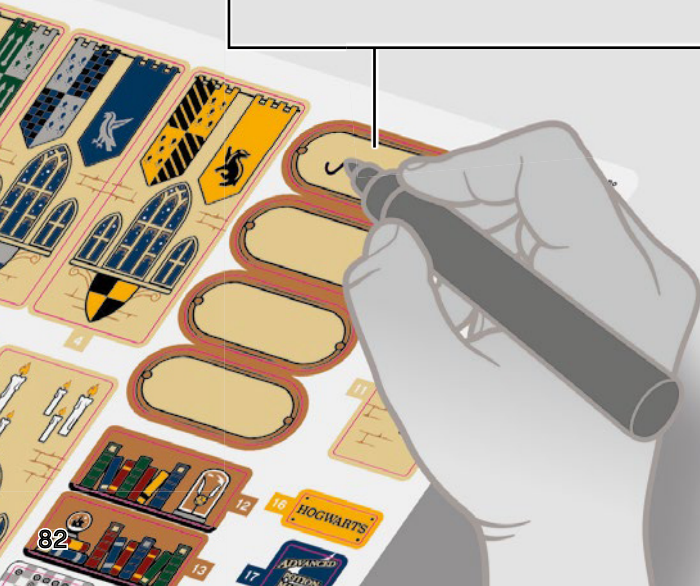
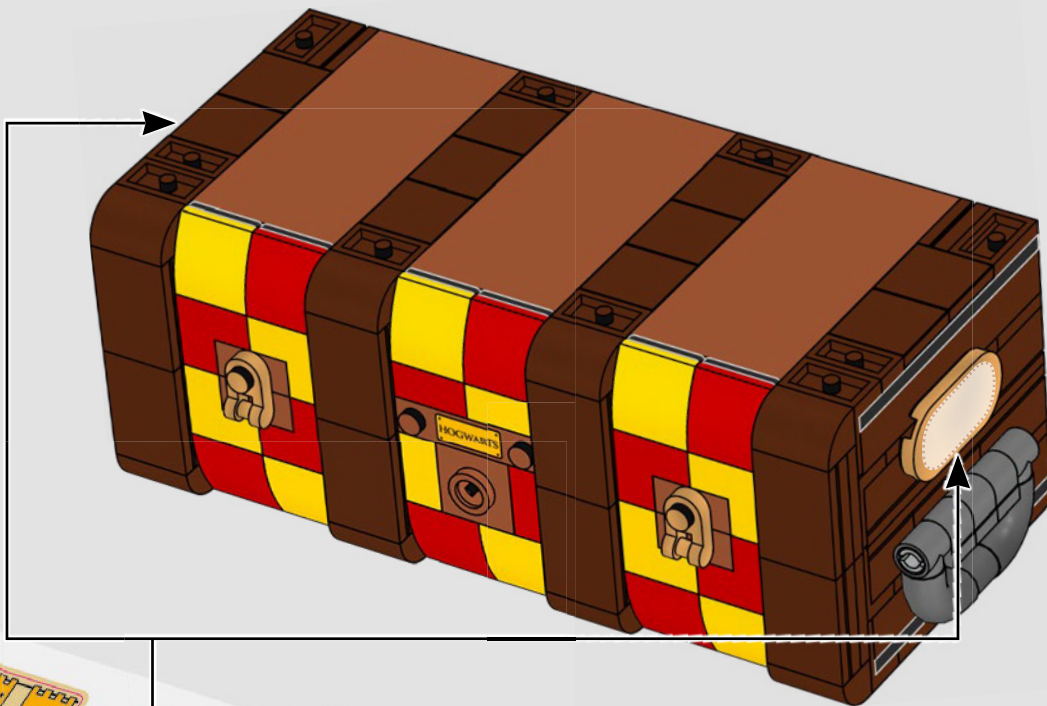

Permanent marker recommended for stickers. Adult supervision also recommended.

Für die Aufkleber werden Permanentmarker empfohlen. Kinder sollten von ihren Eltern beaufsichtigt werden.

Marqueur permanent recommandé pour les autocollants. La surveillance d'un adulte est aussi recommandée.

Pennarello indelebile consigliato per gli adesivi. Raccomandata anche la supervisione di un adulto.

Se recomienda escribir en las pegatinas con un rotulador permanente. También se recomienda la vigilancia de un adulto.

Recomenda-se o uso de marcador permanente para os autocolantes. Também se recomenda a supervisão de um adulto.

A matricákhoz az alkoholos filctollat javasoljuk. Egy felnőtt felügyeletét is javasoljuk.

Uz uzlīmēm ieteicams izmantot permanento marķieri. Ieteicams lietot pieaugušā uzraudzībā.

建议粘贴永久性标记。建议成人陪伴。

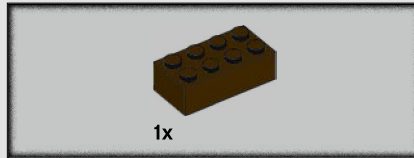

102

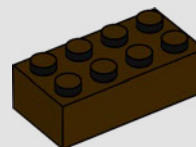

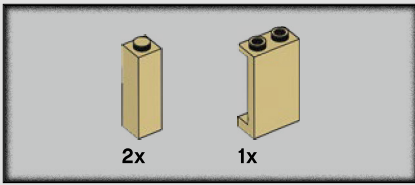

103

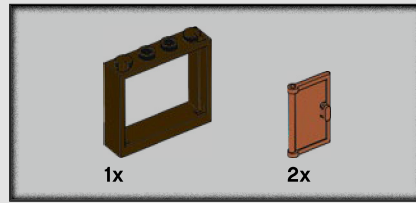
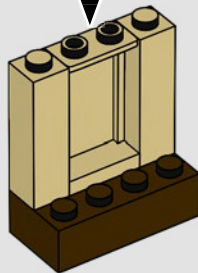
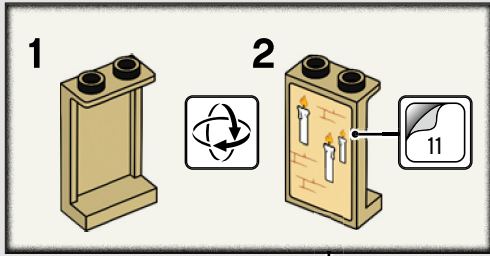

104

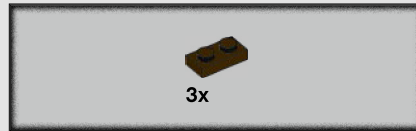
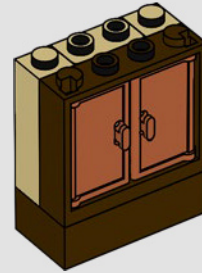
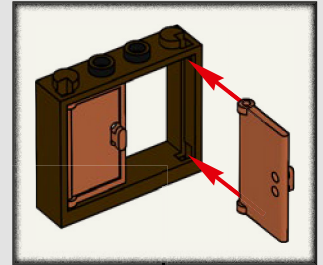

105

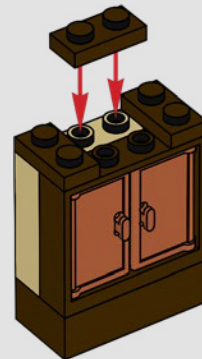



106

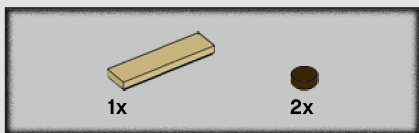
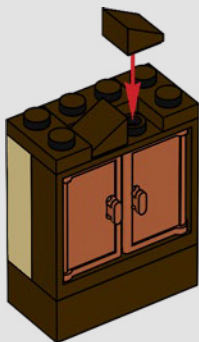

107



108

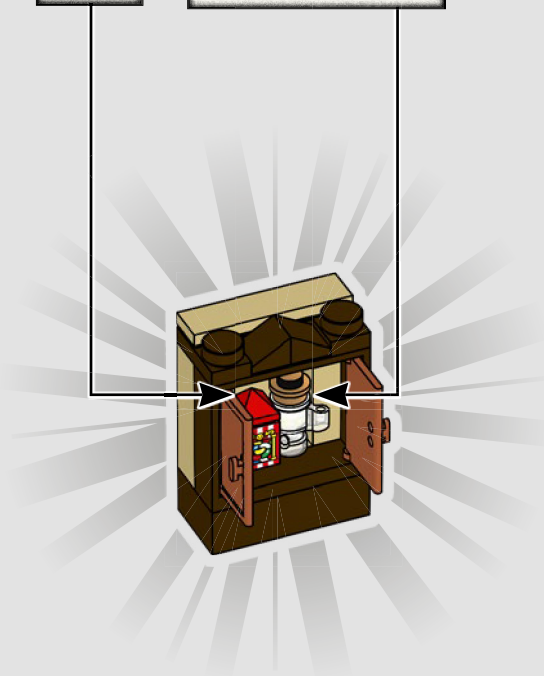
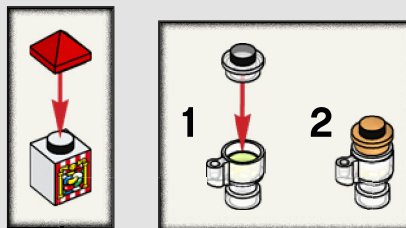

109

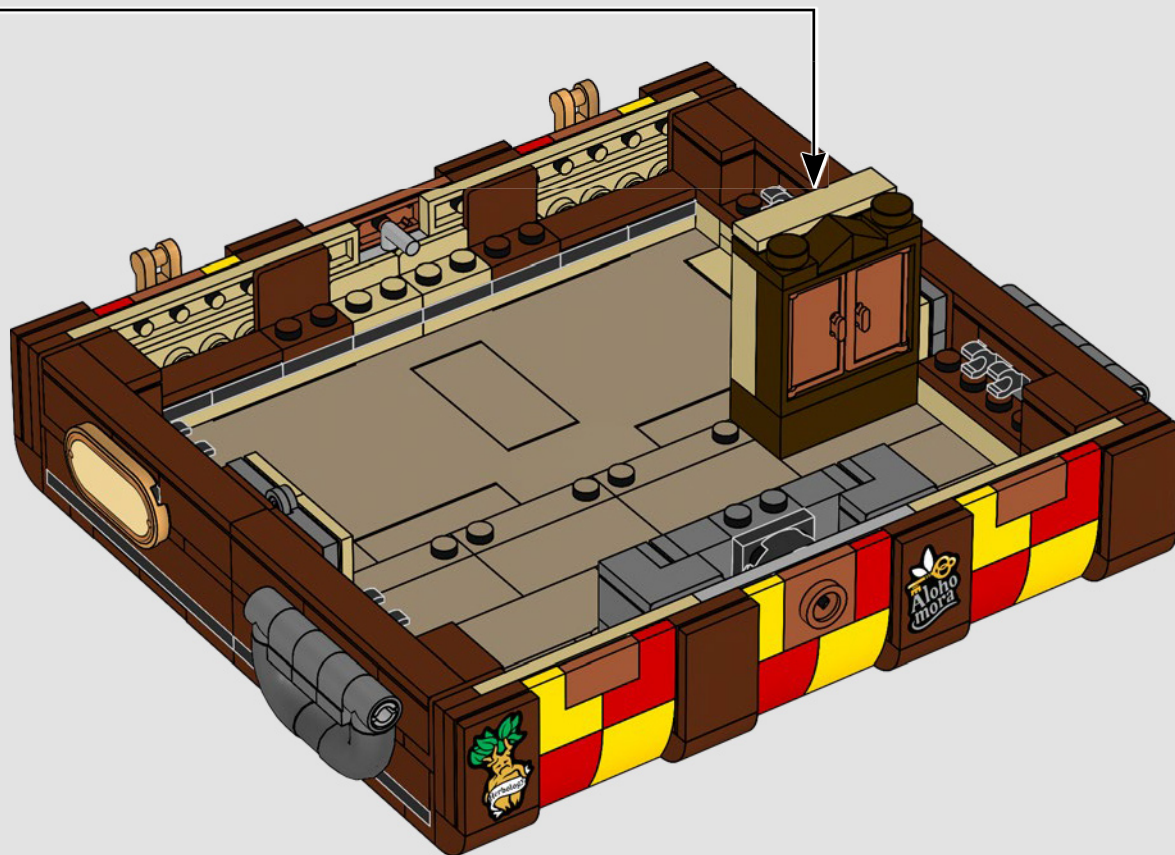

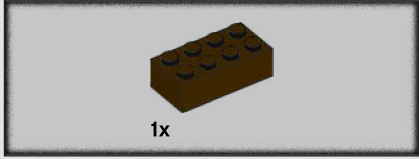

1x

110

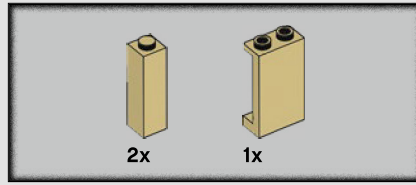
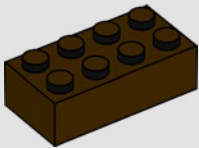

2x

1x

111

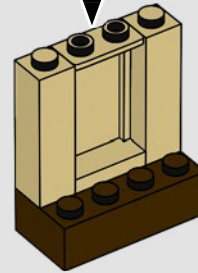
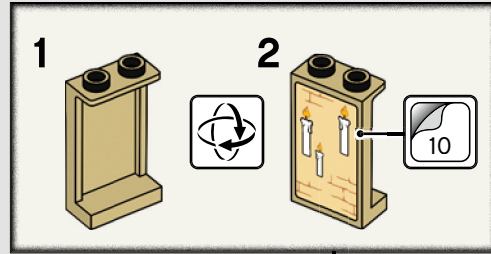

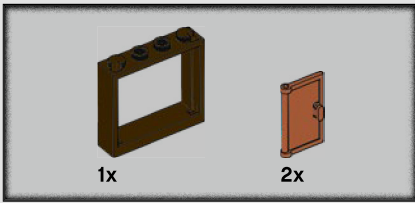

112

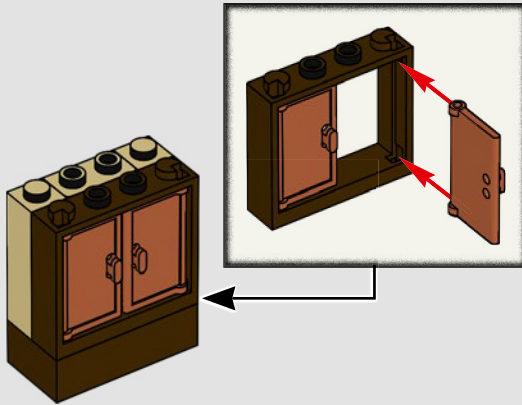

114

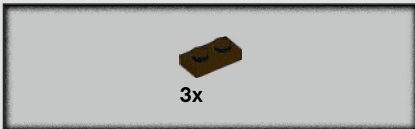
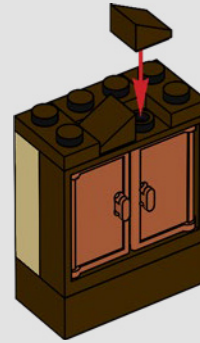

113

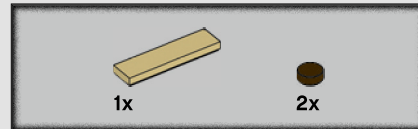
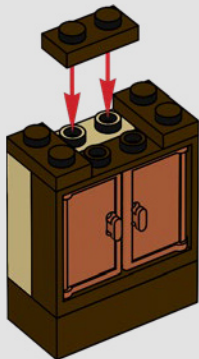

115



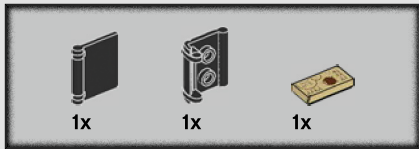

116

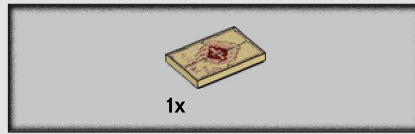
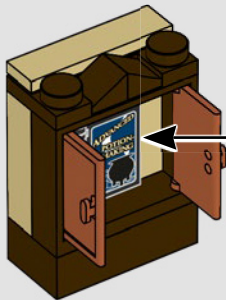
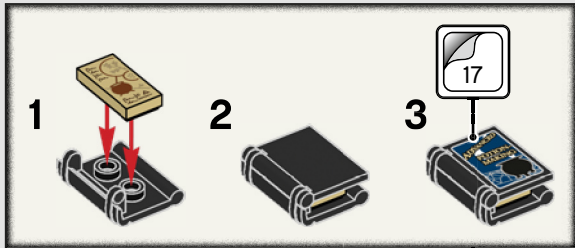

117

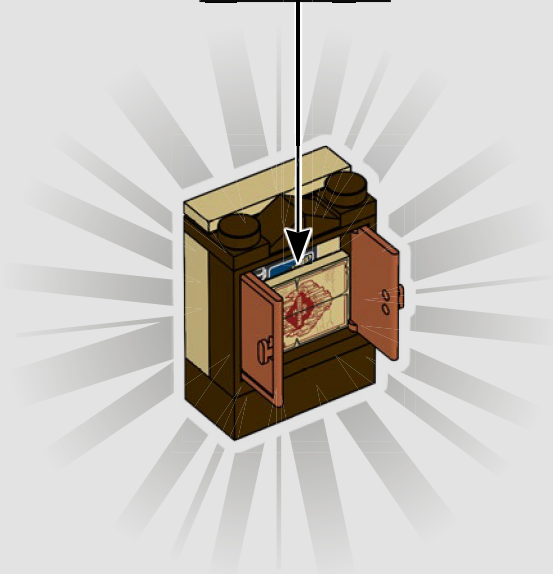

118

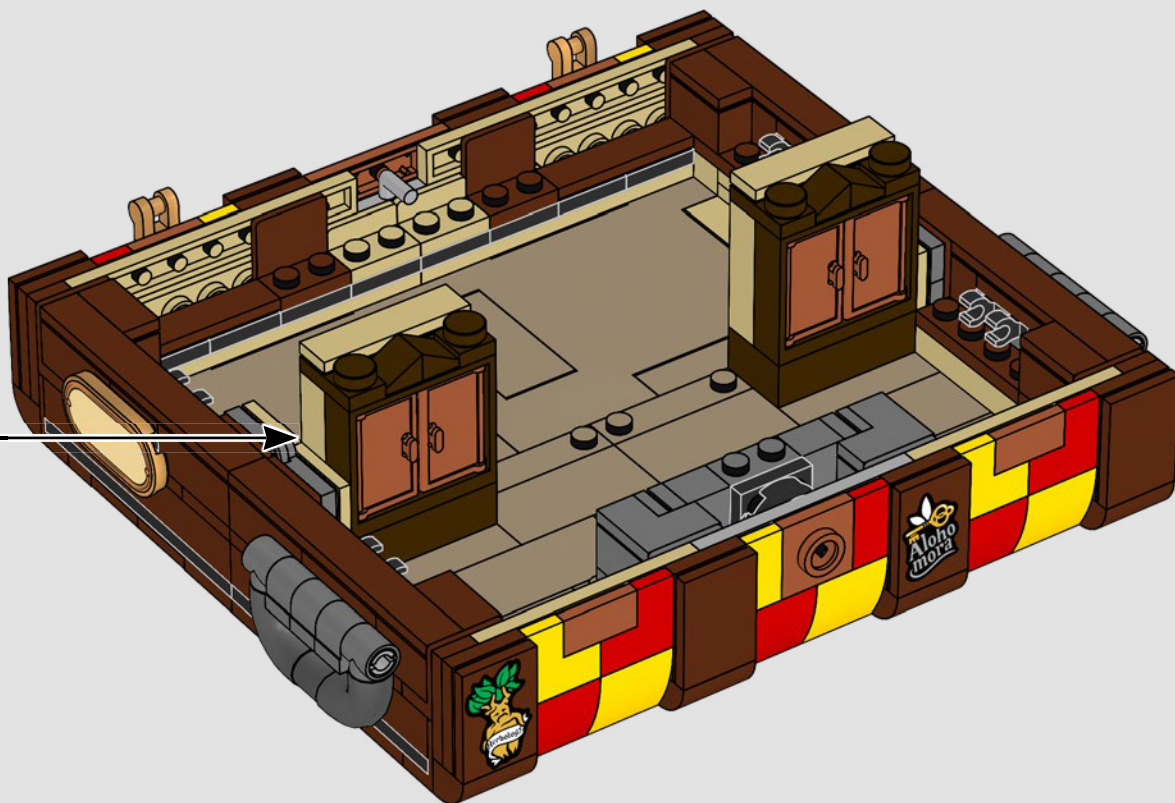



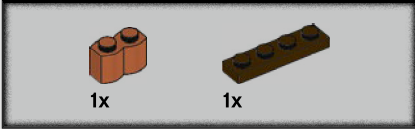

120

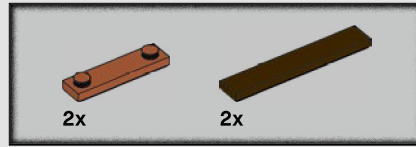
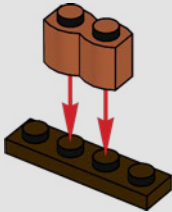

121

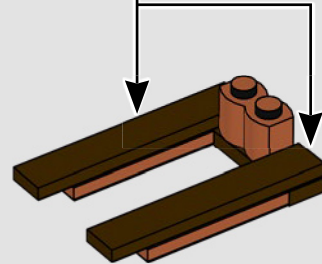
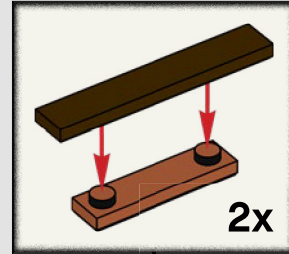

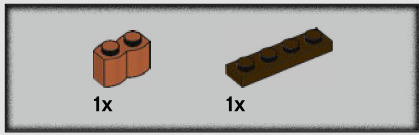

122

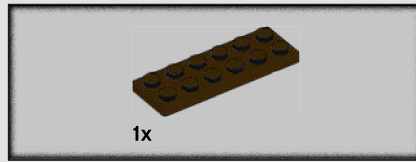
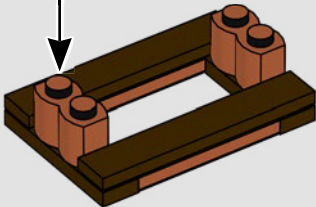
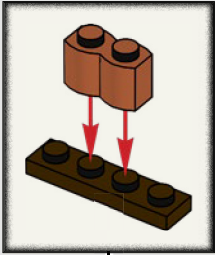

123

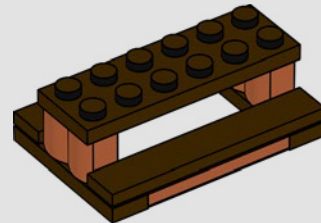

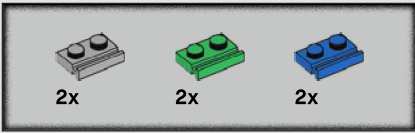

124

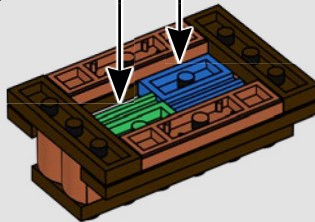
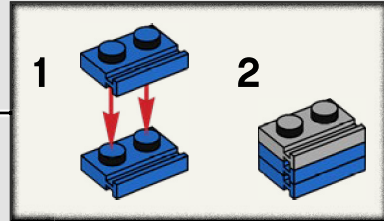
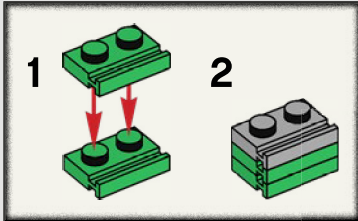

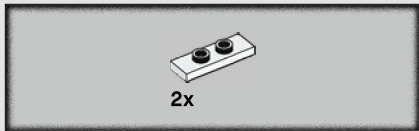

125

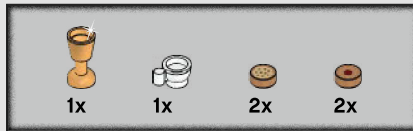
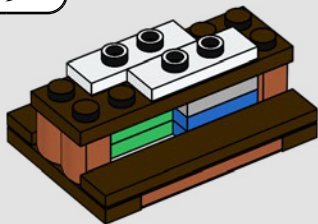

126



127

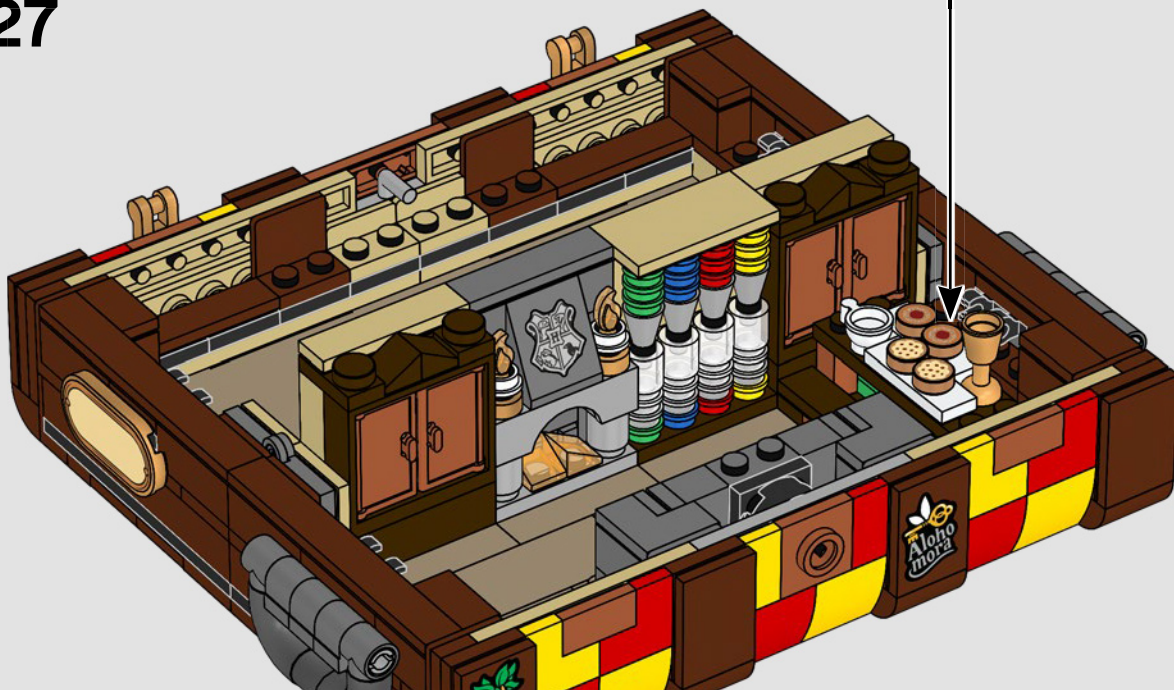

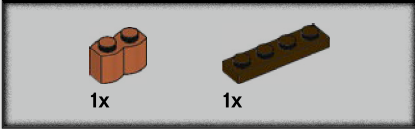

128

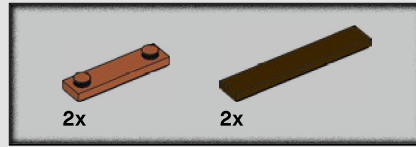
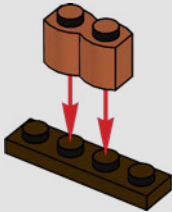

129

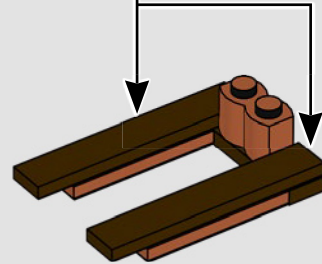
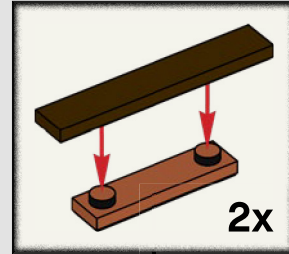

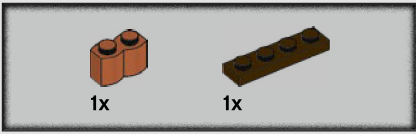

130

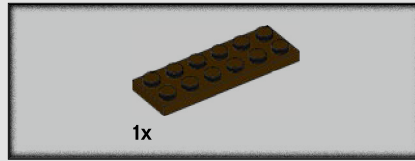
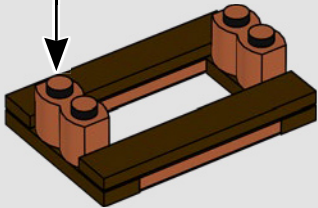
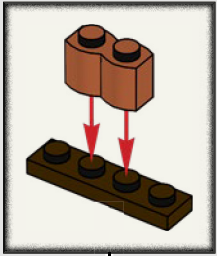

131

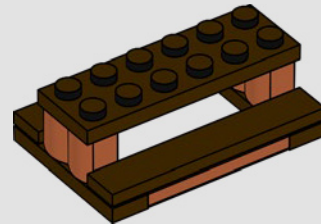

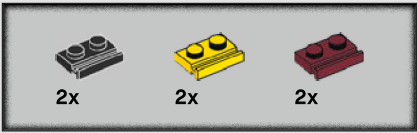

132

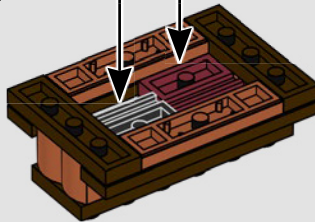
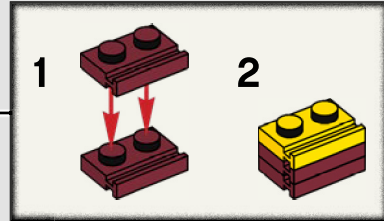
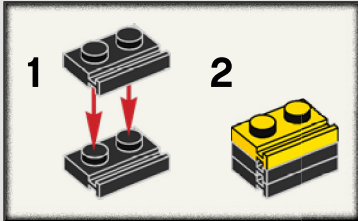

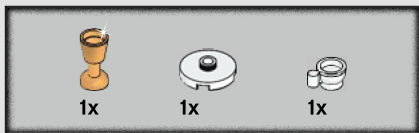

133

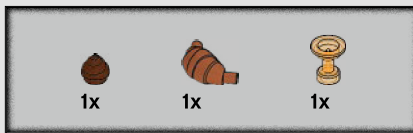
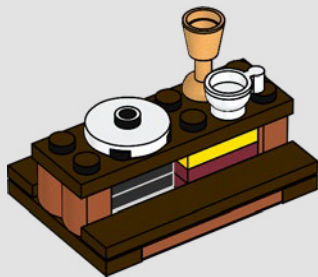
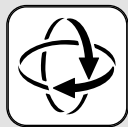

134

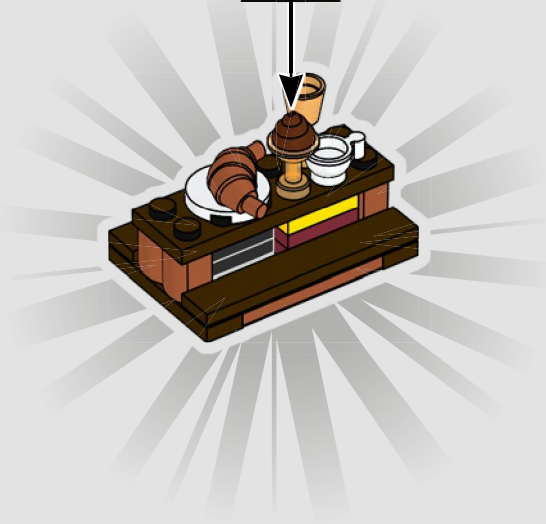
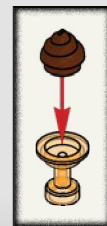

135



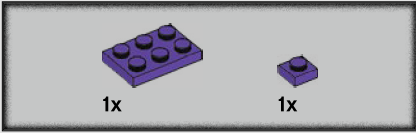
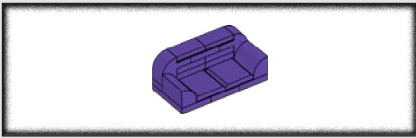

136

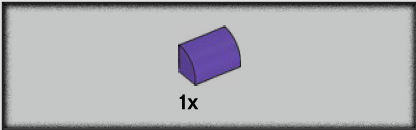
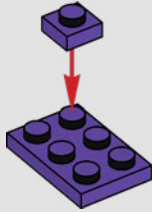

137

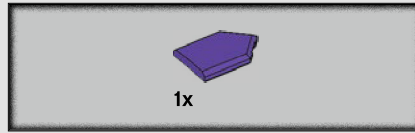
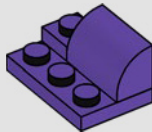

138

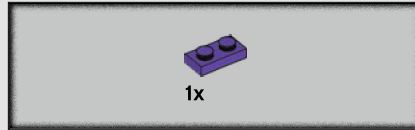
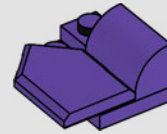

139

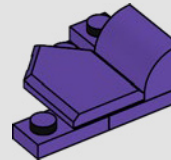

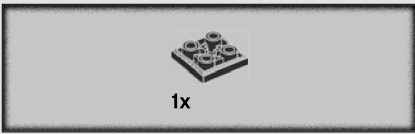

140

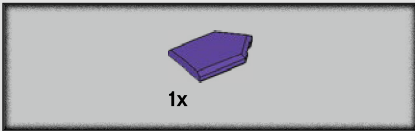
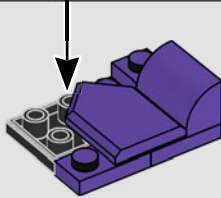
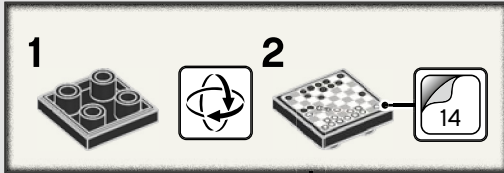

141

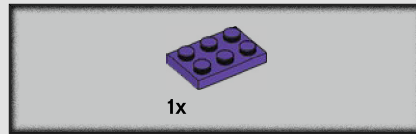
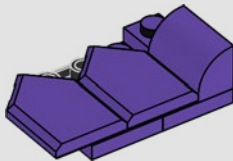

142

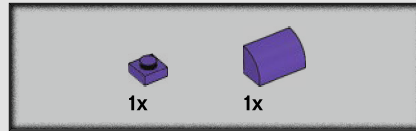
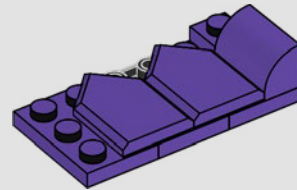

143

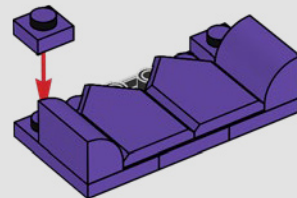

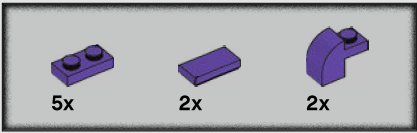

144

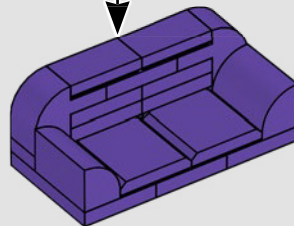
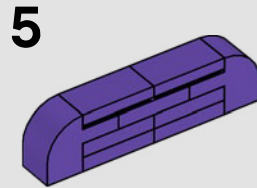
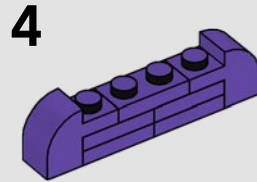
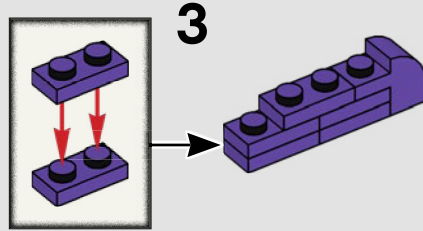
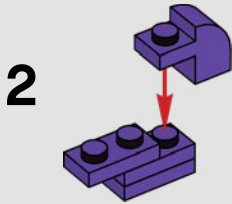
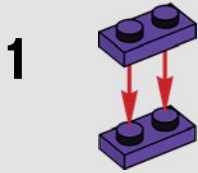

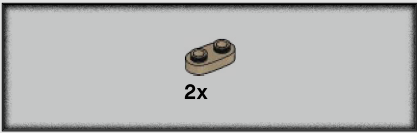

145

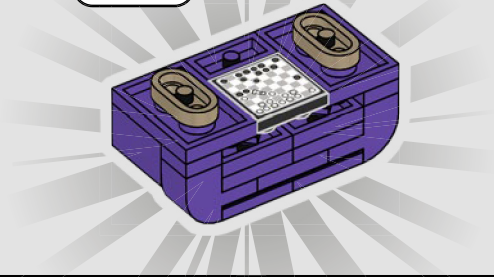

146



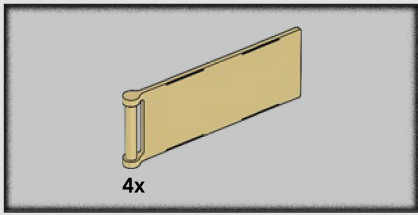

4x

147

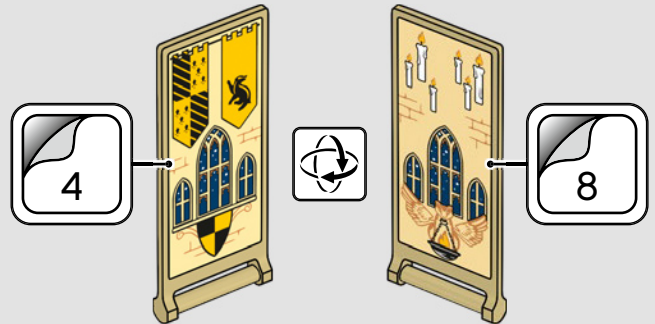
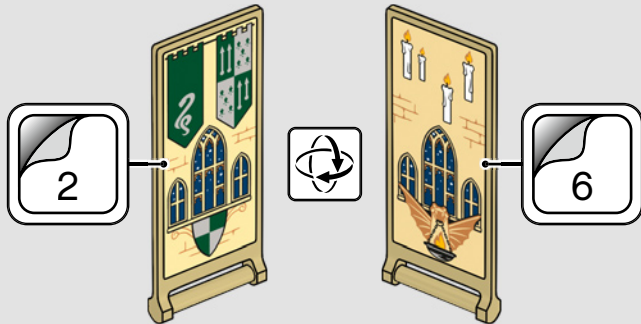
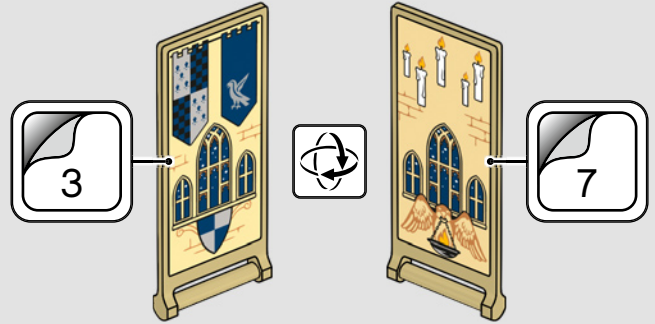
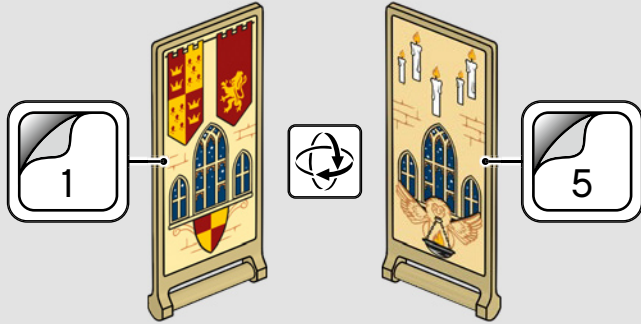

148

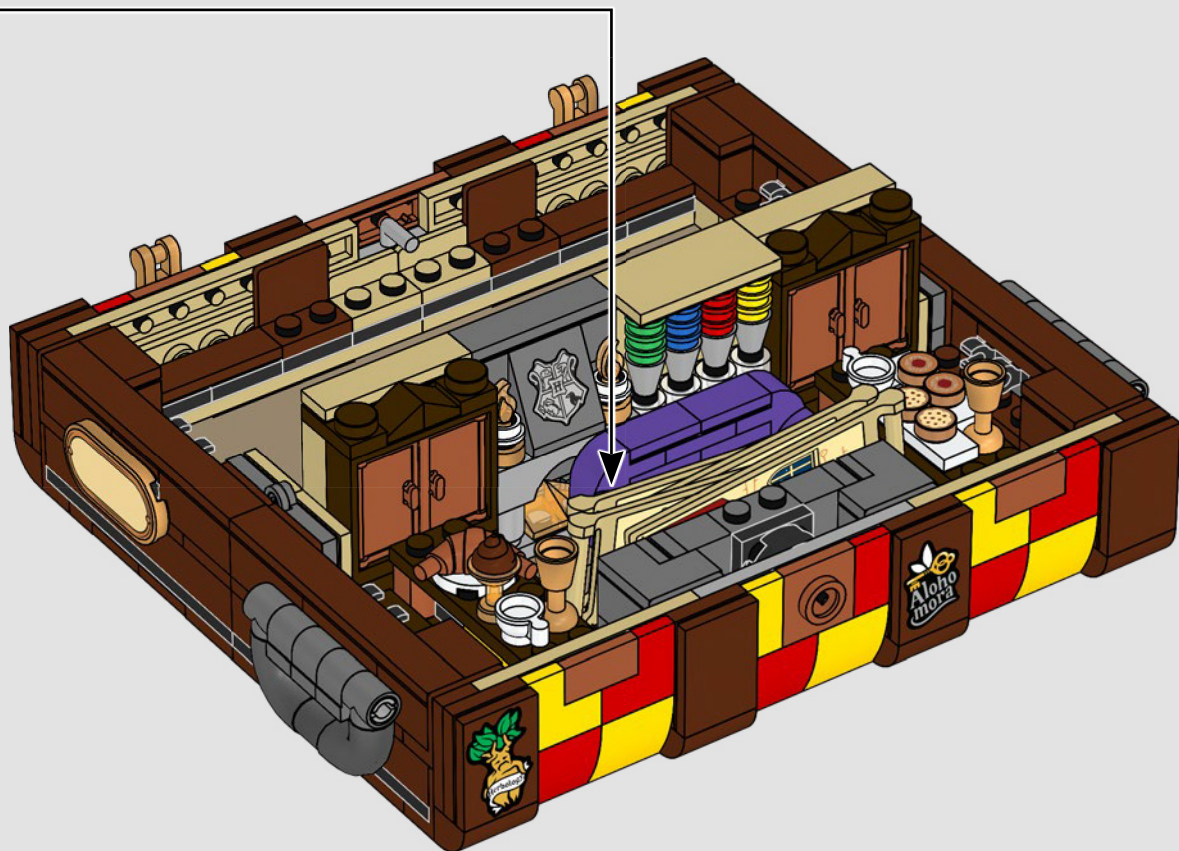

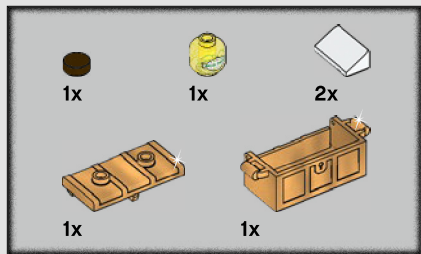

149

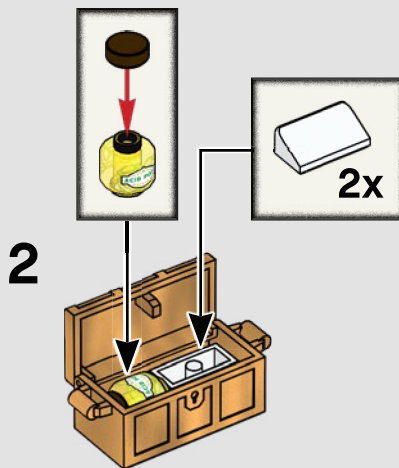
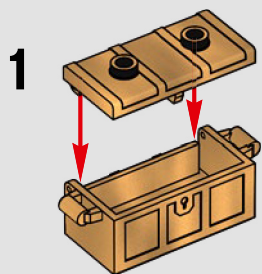

150

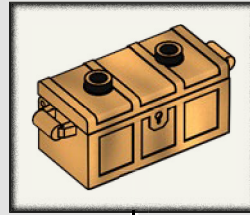



151

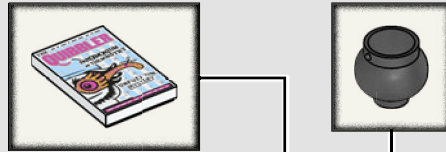

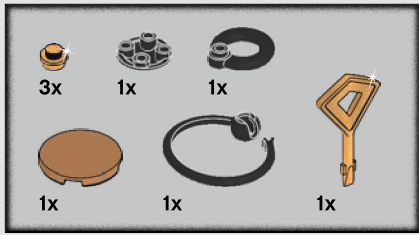

152

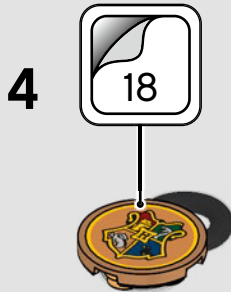



Build,
Rebuild,
Play



Alchemist's Store

阿拉霍洞开 (开锁咒)





The Sorting Ceremony



The Great Hall Welcoming Feast



The Common Room

Build, ReBuild, Play
 Bauen, umbauen, spielen
 Construis, reconstruis, joue
 Costruisci, ricostruisci, gioca
 Construye, reconstruye, juega

Constrói, Reconstrói, Brinca
 Építsd meg, alakítsd át, játssz vele!
 Bùve, pàrbùve, rotàlájies
 拼搭、重新拼搭、玩乐

The Sorting Ceremony

The Sorting Ceremony
Die Zuordnungszeremonie
La cérémonie de la Répartition
Cerimonia dello smistamento
La Ceremonia de Selección
A Cerimónia de Seleção
A beosztási ceremónia
Šķirošanas ceremonija
分院仪式





The Great Hall Welcoming Feast

The Great Hall Welcoming Feast
Empfangsfest in der Großen Halle
La fête de début d'année dans la Grande Salle
Banchetto di inizio anno nella Sala Grande
El banquete de bienvenida en el Gran Comedor
O Grande Salão Banquete de Início do Ano
Üdvözlő ünnepség a Nagyteremben
Sagaidišanas mielasts lielajā zālē
大礼堂欢迎宴会



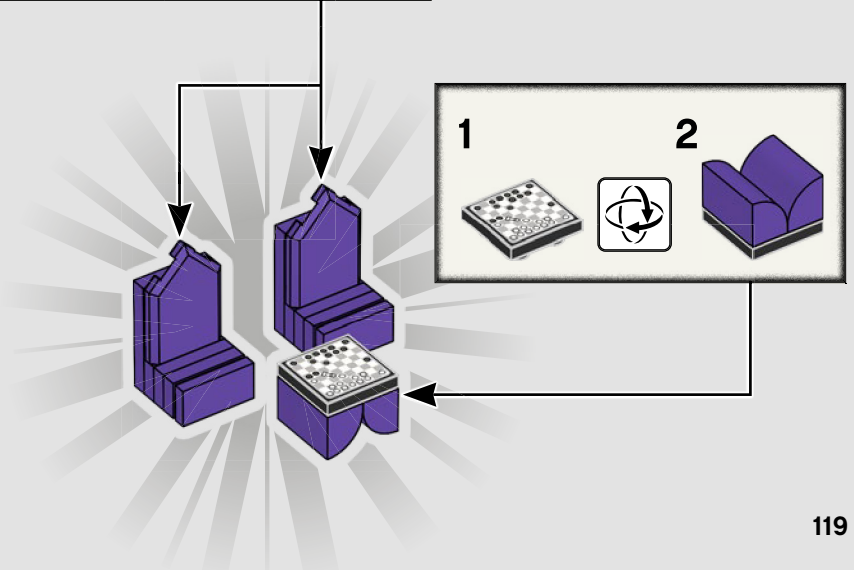
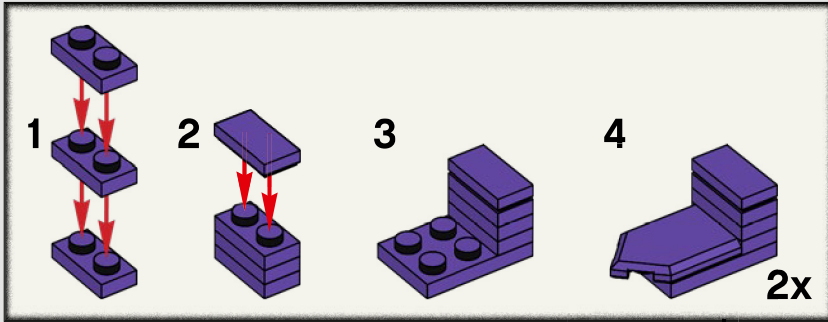
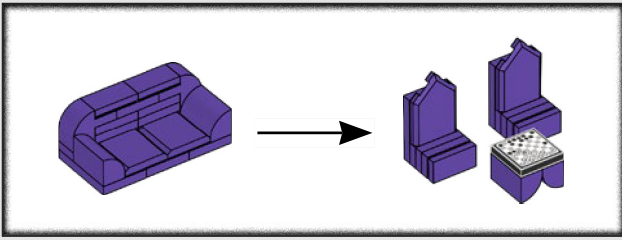

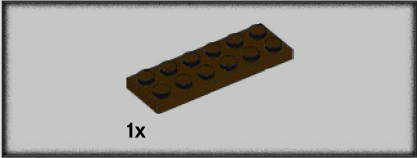
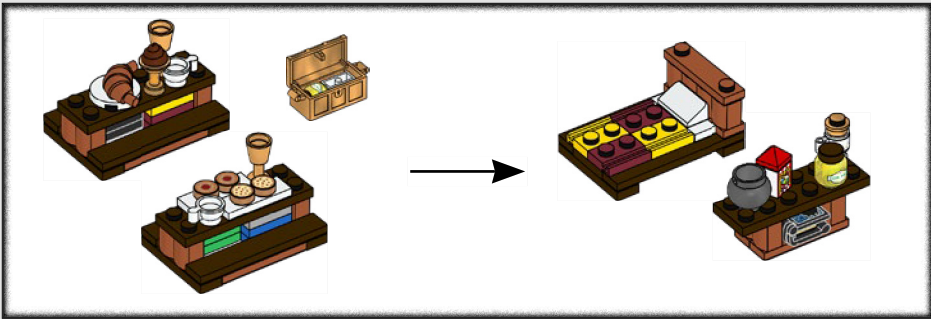

1

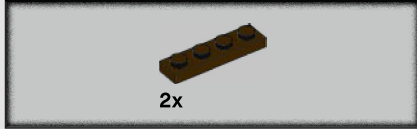
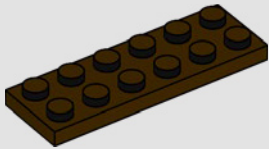

2

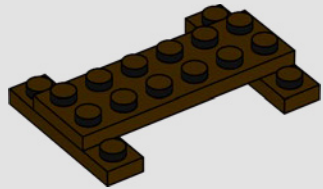

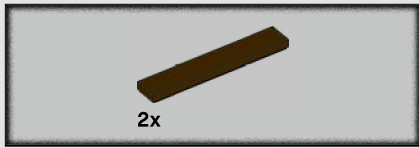

3

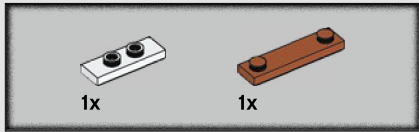
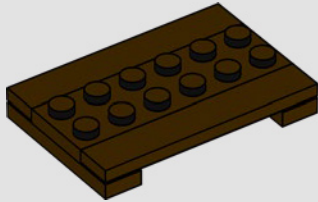

4

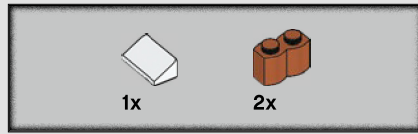
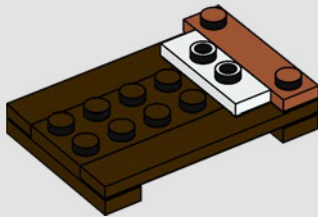

5

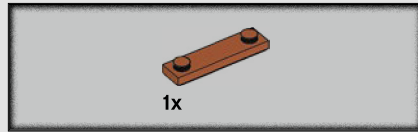
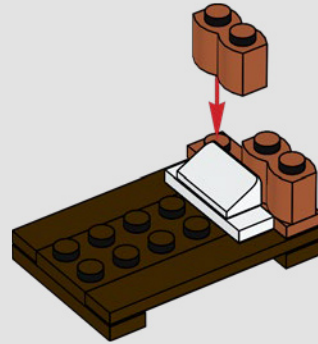

6

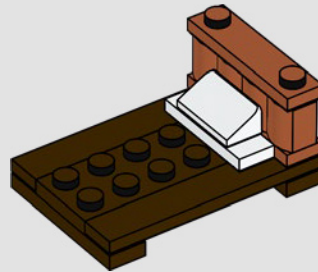

7

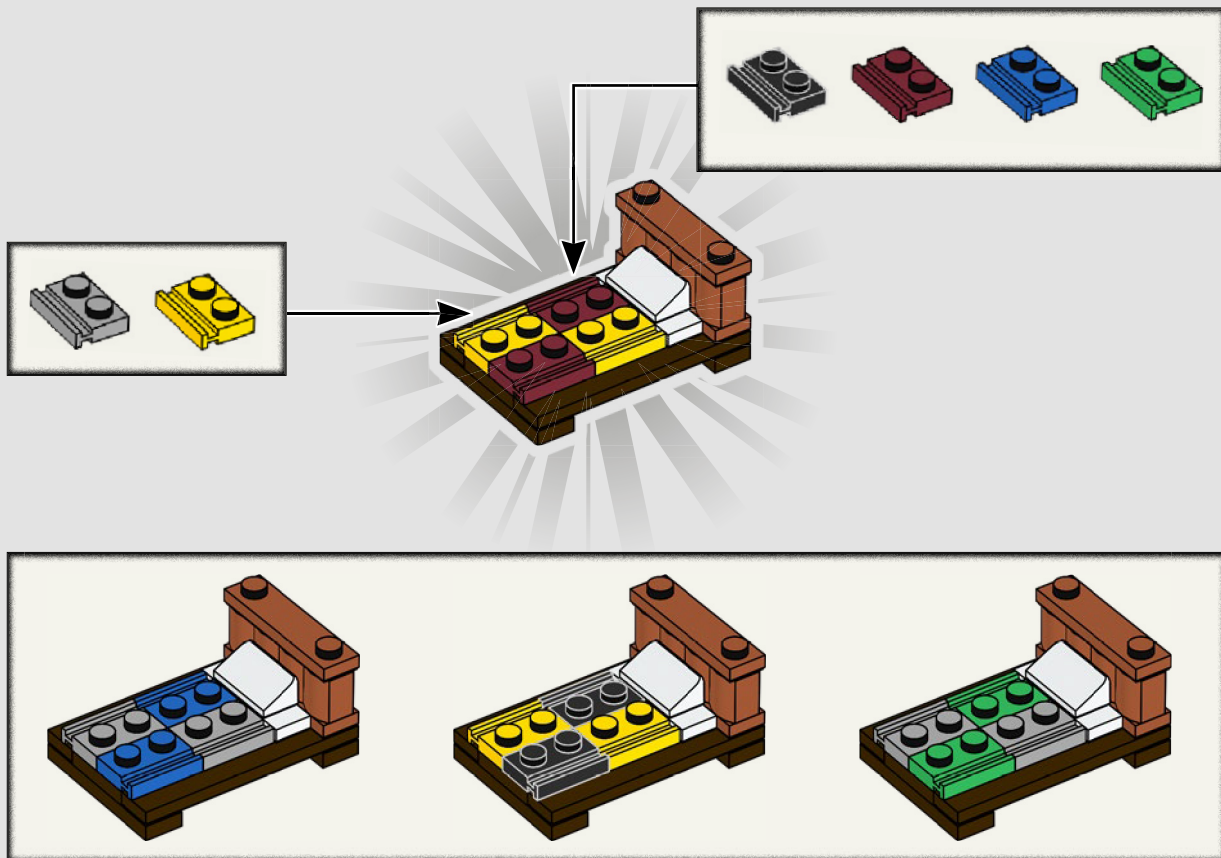

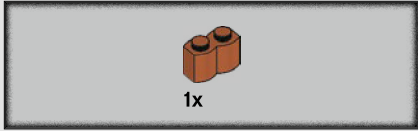

1

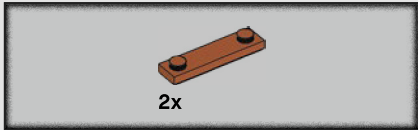
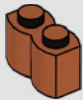

2

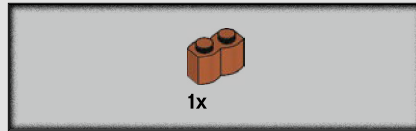
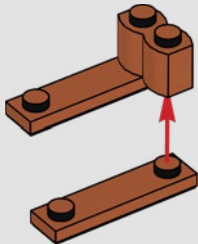

3

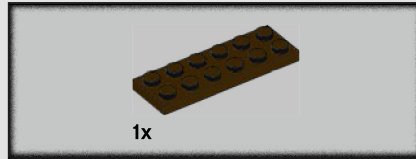
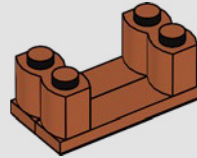

4

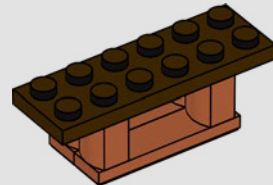

5

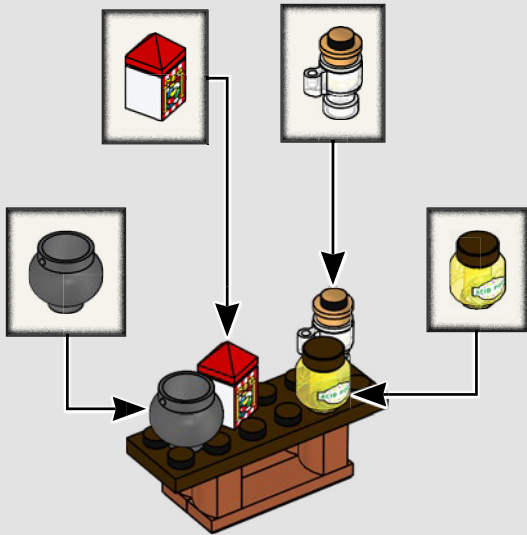

6

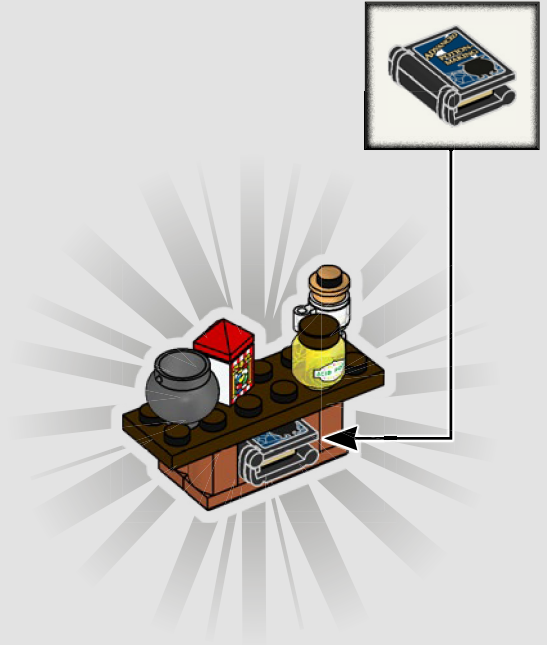



1x
6365025



8x
614121



3x
6350414



4x
306921



12x
6105976



8x
6078641



8x
6223655



19x
6240030



3x
6349957



3x
6350862



4x
6357747



2x
6323033



4x
6245265



1x
6254100

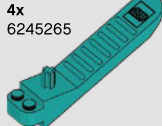

126



1x
6194444



8x
614123



1x
6358191



2x
306923



6x
6179330



6x
6116786



4x
6129747



1x
6329324



1x
6329324



1x
6331764



8x
4569058



2x
306928



6x
4272665



6x
6116259



4x
6374049



18x
4655695



4x
6143993



1x
6342521



6x
6245266



6x
4225142



1x
6174125



1x
6288690



8x
614124



4x
306924



8x
4141630



12x
6079007



8x
4141630



4x
366601



4x
366601



2x
303201



8x
6308099



4x
6231376



6x
4613192



6x
6264050



4x
6168642



4x
6235083



3x
6381953



8x
4547489



2x
6093053



8x
6195371



2x
6173095



2x
6381954



2x
6381954



2x
4211435



2x
4211395



2x
4211542



2x
4211542



2x
4211414



8x
4211568



6x
6102357



4x
6065824



4x
4211815



4x
4211412



8x
6167667



2x
4540203



8x
4211807



4x
4211488



2x
6173095



4x
6102774



2x
6055310



6x
4211053



8x
4211001



8x
4211001



1x
6381997



2x
6000311



4x
6308045



2x
6314192



8x
4211094



2x
4234534



4x
4211109



4x
6247784



4x
6247784



4x
6102774



4x
6055310



6x
4211053



3x
6315573



3x
6283610



1x
6356861



4x
6025235



4x
6336390



8x
6135014



10x
4211088



12x
6019987



1x
6231765



1x
6278155



12x
4211098



8x
4210719



3x
6270027



1x
4526110



8x
6310268



2x
6097072



6x
4107761



2x
6378747



2x
368026



1x
6370527



1x
6233922



2x
4278359



3x
4596914



2x
6378773



2x
306926



8x
302326



2x
6372272



12x
6117973



8x
6310268



2x
6097072



6x
4107761



2x
6378747



2x
368026



3x
6013867



6x
6053077



4x
6133722



1x
6326954



1x
6375725



1x
6375743



1x
6375740



1x
6375741



1x
6382407



2x
6375231



8x
346026



4x
395826



4x
395826



4x
395826



4x
395826



4x
395826



4x
395826



Customer Service
Kundenservice
Service Consommateurs
Servicio Al Consumidor
LEGO.com/service or dial

: 00800 5346 5555
: 1-800-422-5346

WIN

GO TO WWW.LEGO.COM/PRODUCTFEEDBACK AND
GIVE US YOUR SHORT **FEEDBACK** ABOUT THIS
LEGO® SET FOR A CHANCE TO WIN
A COOL LEGO PRIZE.

Terms & Conditions apply



LEGO.com/productfeedback

GEWINNE

Erzähle uns auf
www.LEGO.com/productfeedback

etwas über die Erfahrungen, die du mit
diesem LEGO® Set gemacht hast, und
sichere dir die Chance auf einen coolen
LEGO Preis!

Es gelten die Teilnahmebedingungen

GAGNE

Rends-toi sur
www.LEGO.com/productfeedback

et donne-nous quelques commentaires
sur ce produit LEGO® pour avoir une
chance de gagner un prix LEGO !

Voir Conditions Générales

GANA

Visita
www.LEGO.com/productfeedback

y envíanos tu opinión acerca de este
set LEGO®. ¡Participarás en el sorteo de
un premio LEGO!

Términos y Condiciones aplicables

获取奖品

登录
www.LEGO.com/productfeedback

给出关于此乐高®套装的简短反馈，
就有机会获得炫酷乐高奖品

《条款及条件》适用



LEGO and the LEGO logo are trademarks of the LEGO Group. ©2022 The LEGO Group.
WIZARDING WORLD characters, names and related indicia are © & ™ Warner Bros. Entertainment Inc.
WB SHIELD: © & ™ WBEL. Publishing Rights © JKR. (s22)

6409608