



40584





LEGO.com/sustainable-packaging



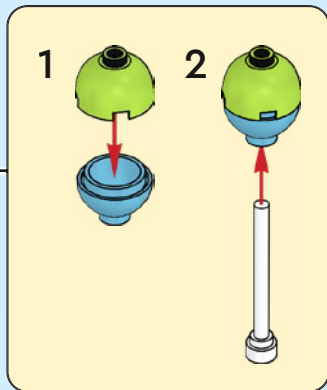
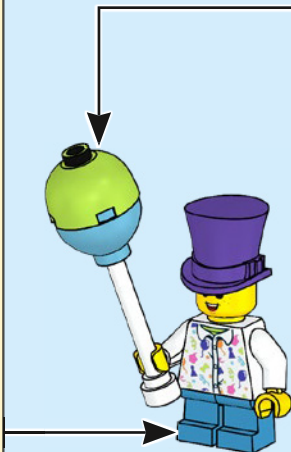



1

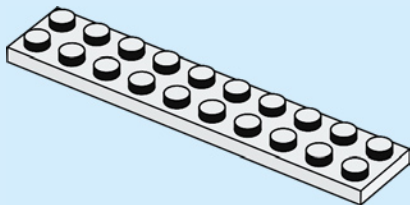
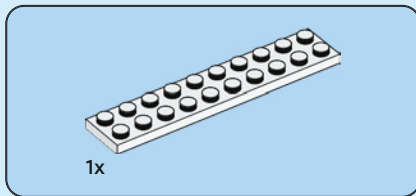

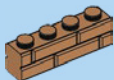

2x



2x

2

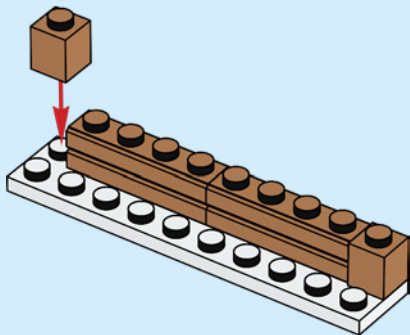

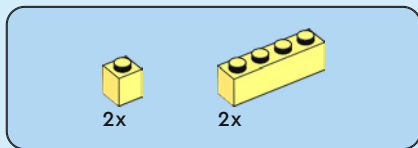

3

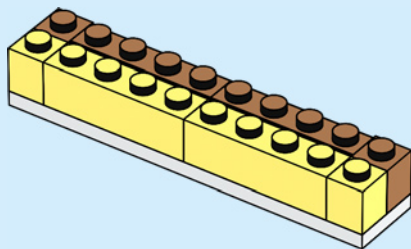



2x

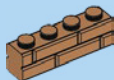

1x



2x

4

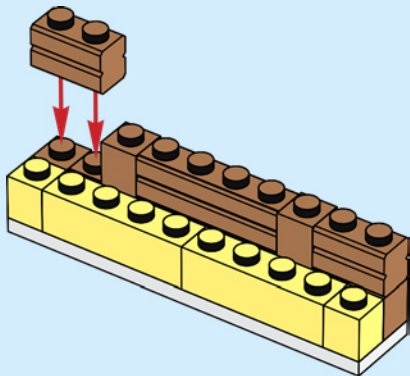

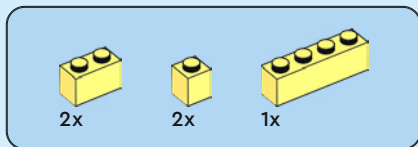

5

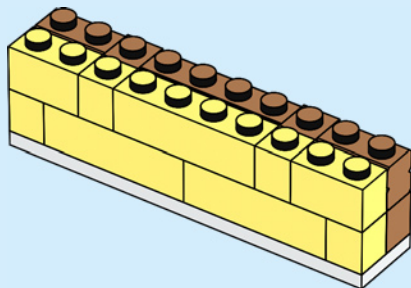

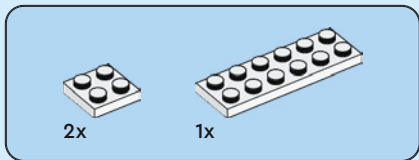

6

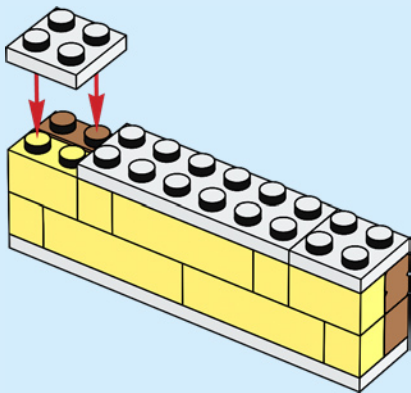

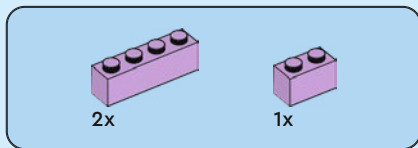

7

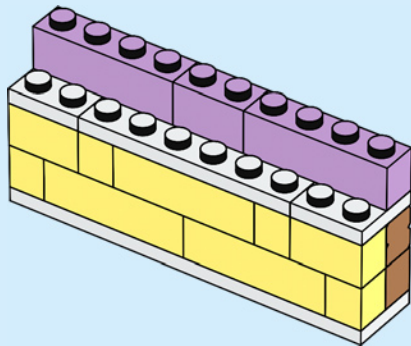

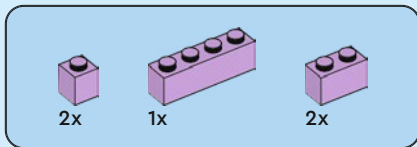

8

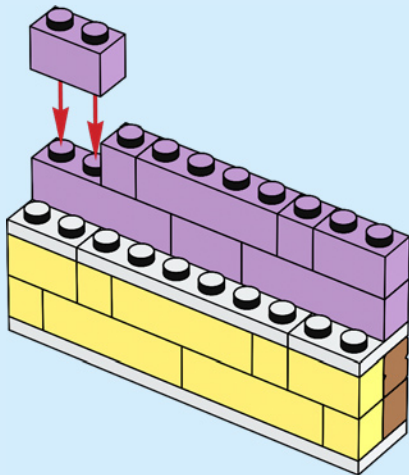

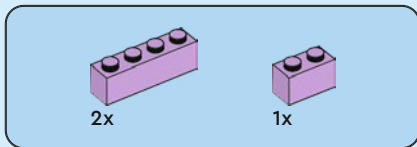

9

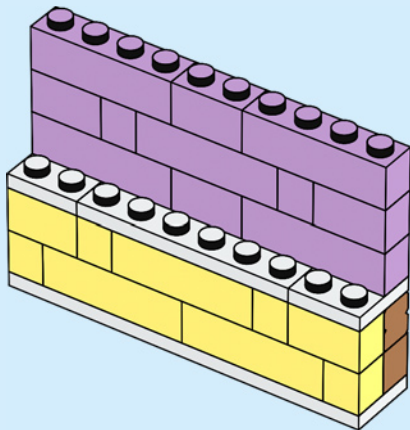

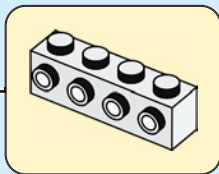
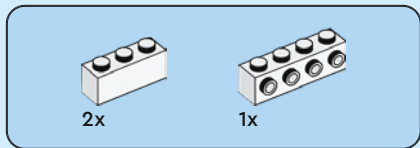

10

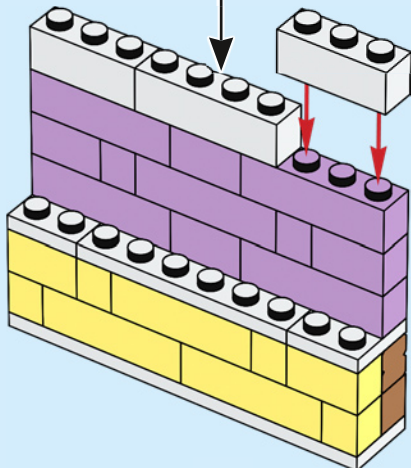

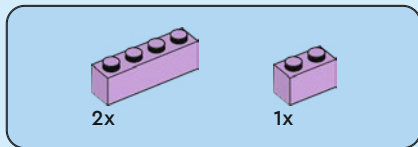

11

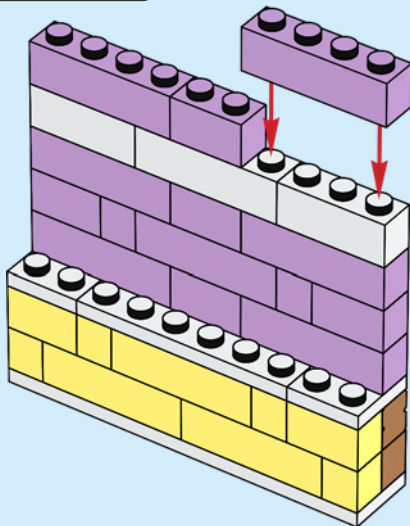

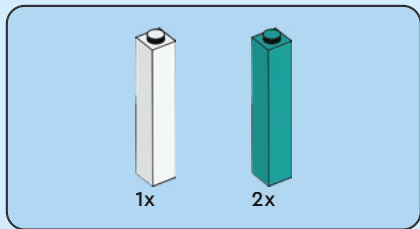

12

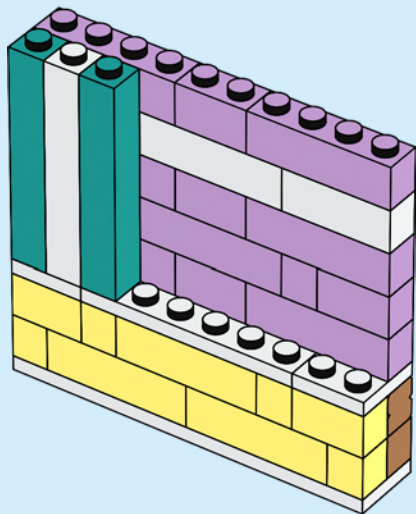



6x



6x

13

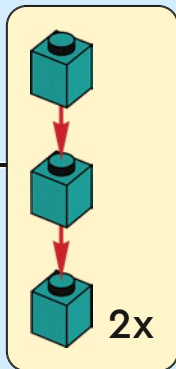
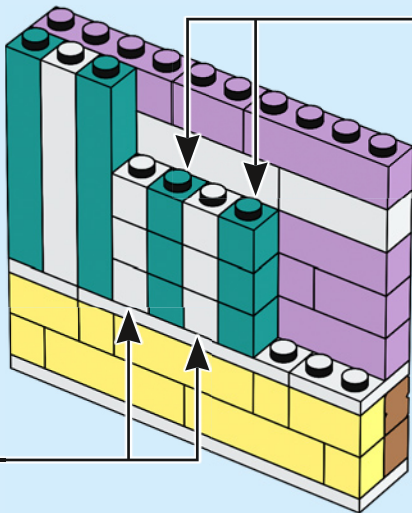
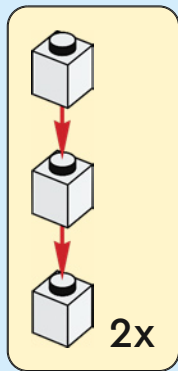

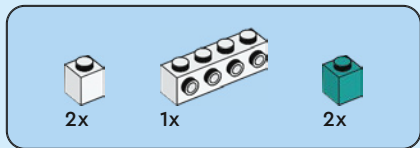

14

1

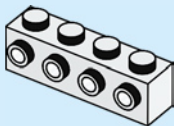

2

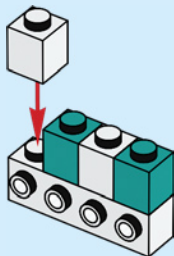

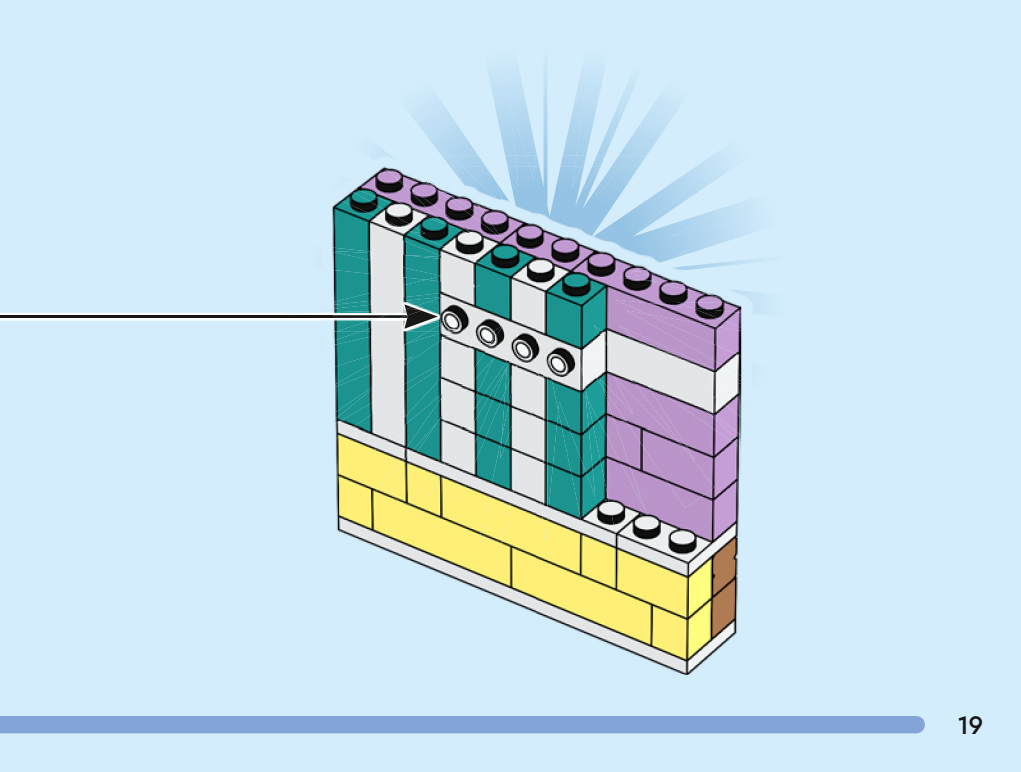

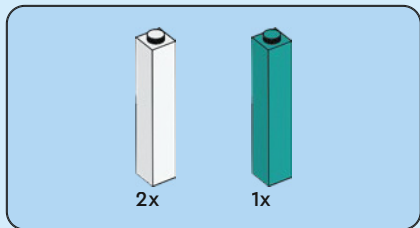

15

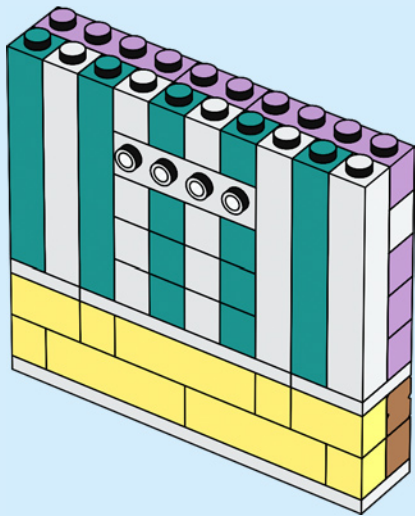

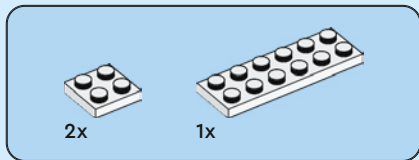

16

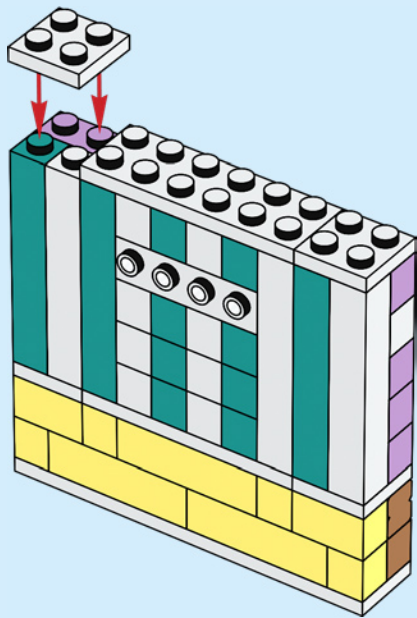

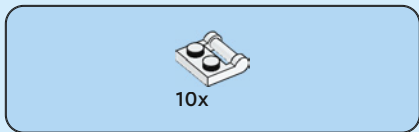

17

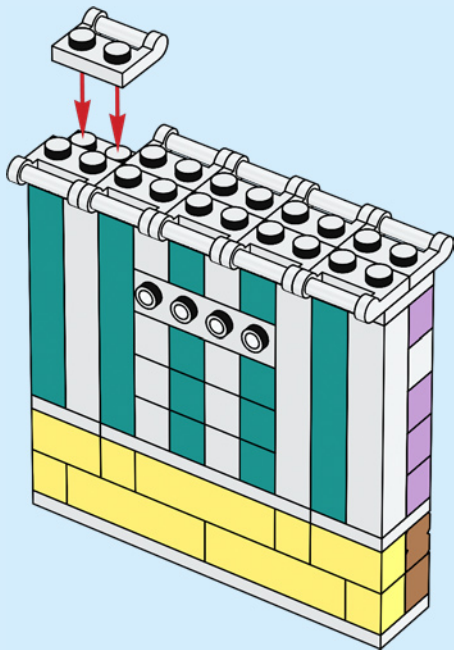

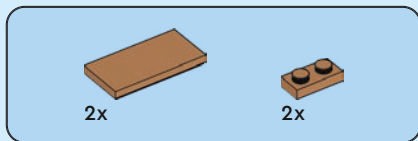

18

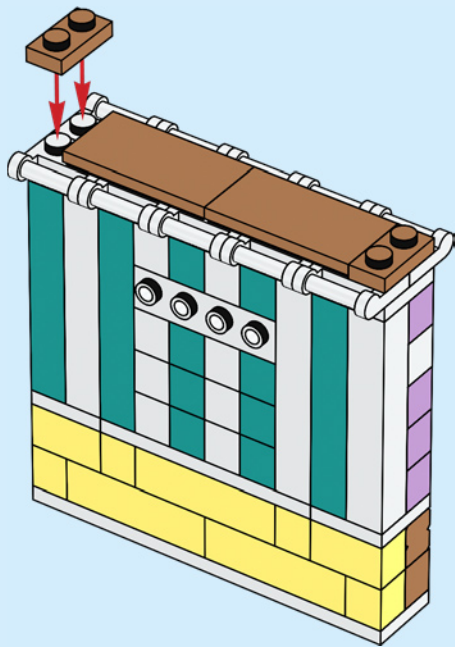

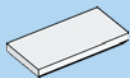

1x

19

1

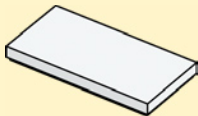

2

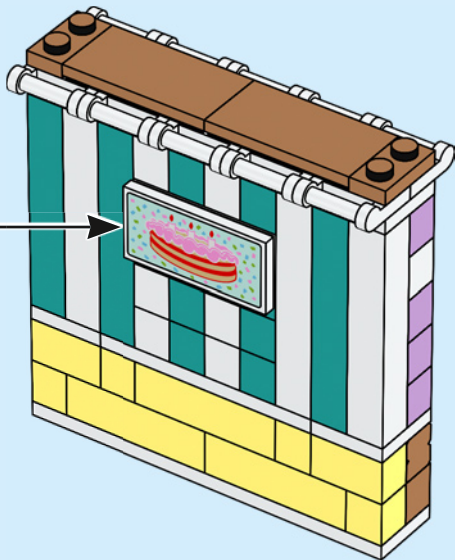
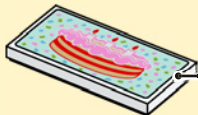



1x



1x



1x



1x



1x

20

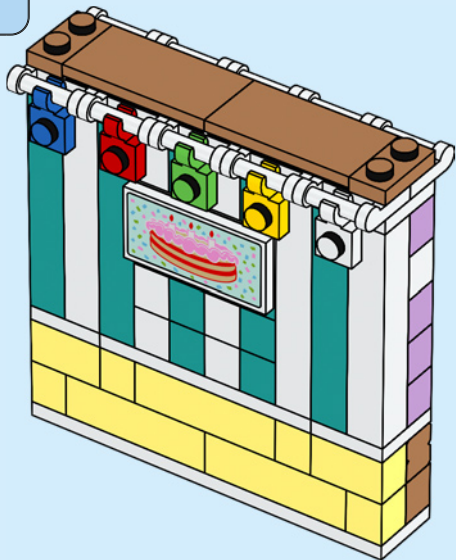

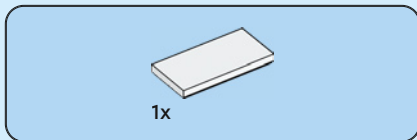

21

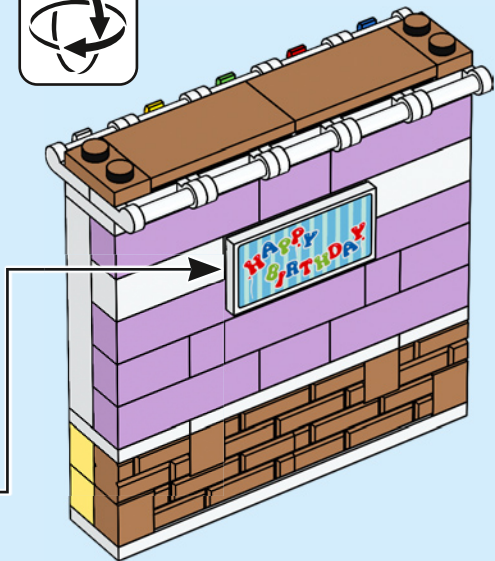
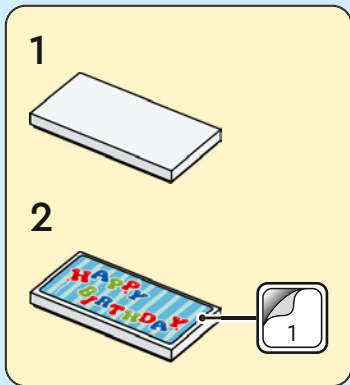



1x



1x



1x



1x



1x

22

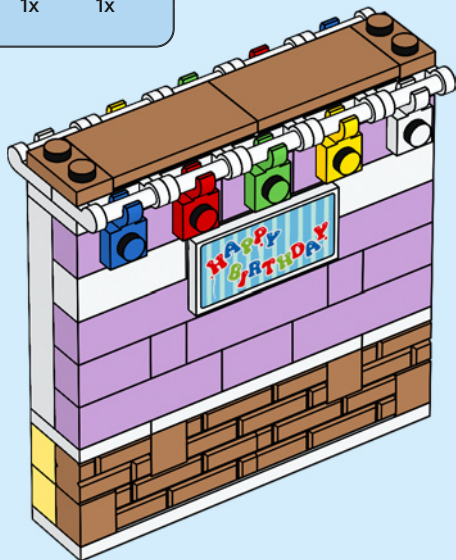

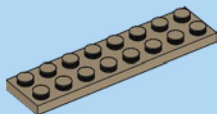
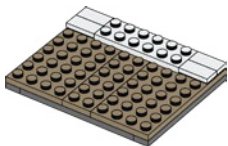

1x

23

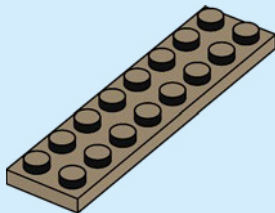

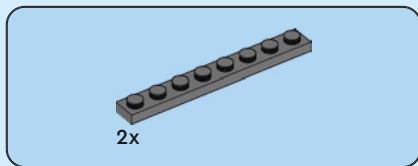

24

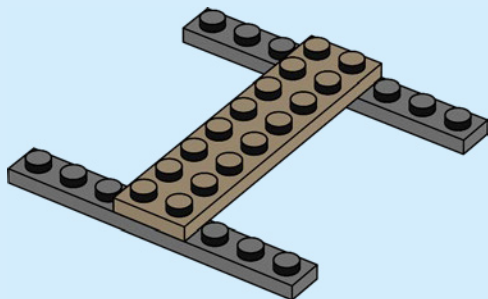

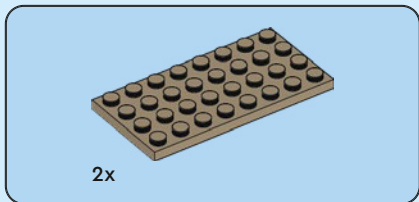

25

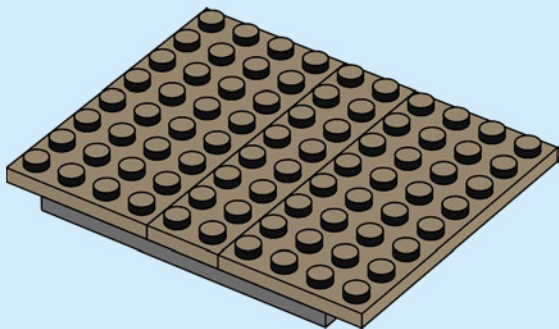

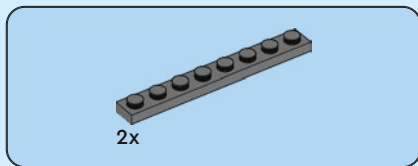

26

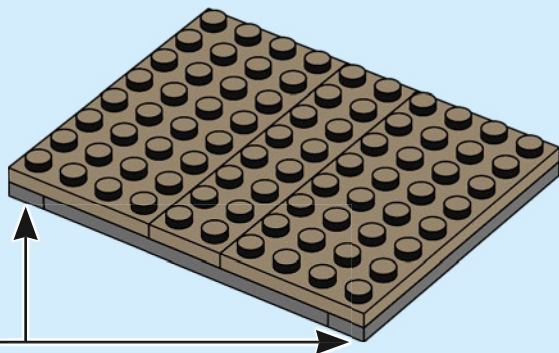
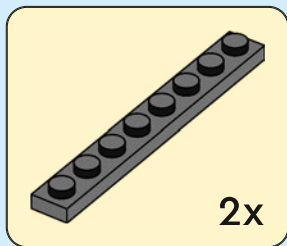

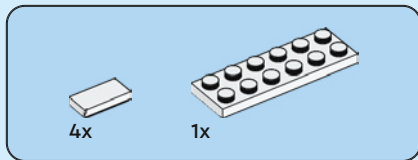

27

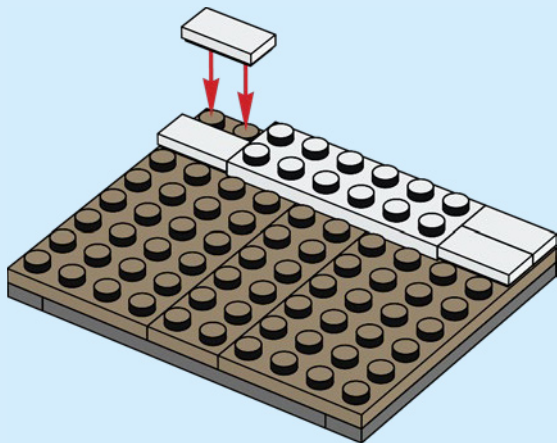

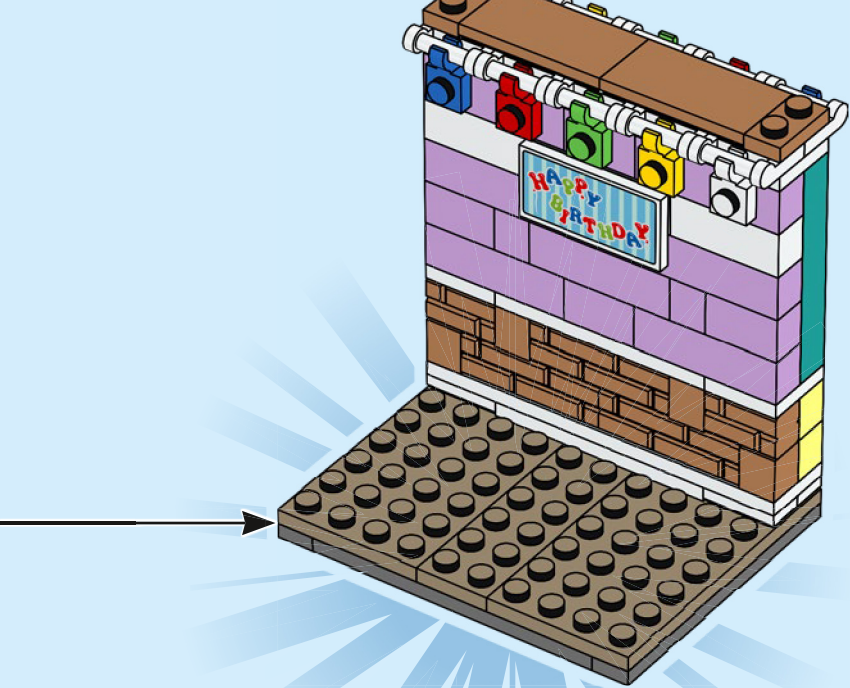

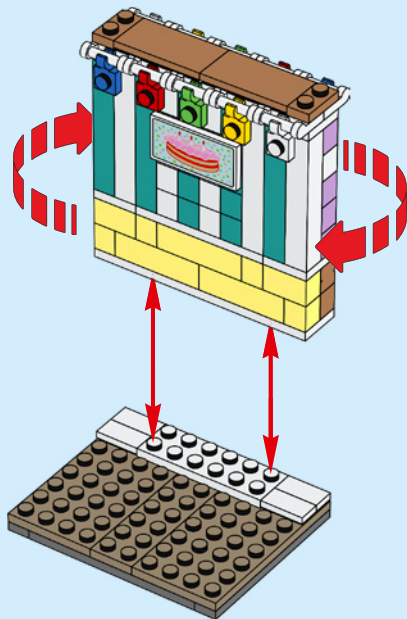



8x

28





2x

29



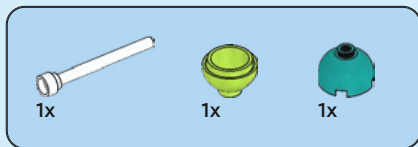

30

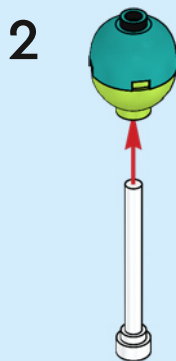
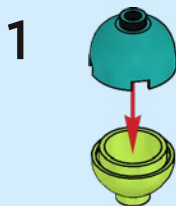





1x



2x



1x



2x

31

1

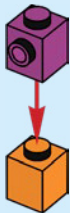

2



3

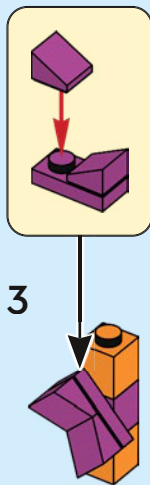



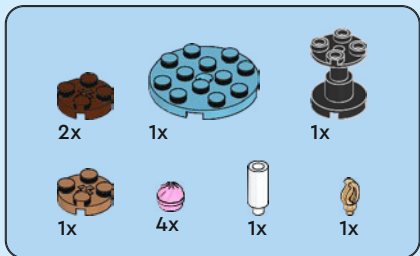
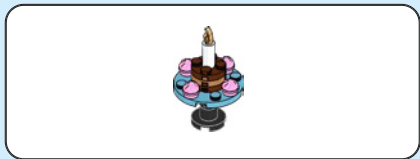

32

1

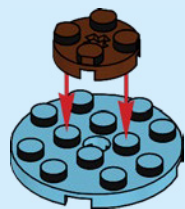

2

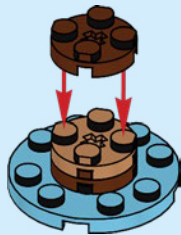

3

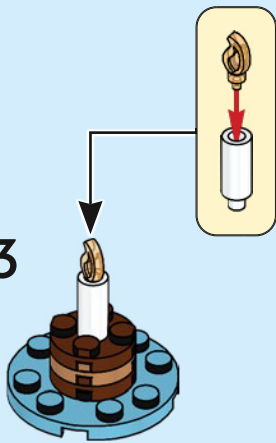

4

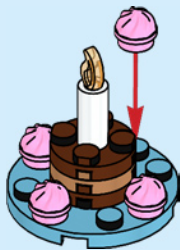

5







1x



2x



2x

33

1

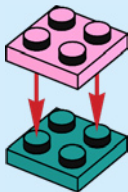

2

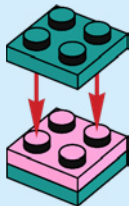

3

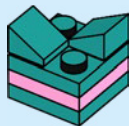





34

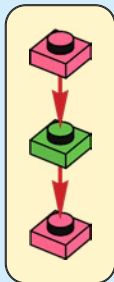
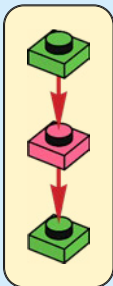







1x
6234807



8x
300501



3x
245301



2x
6347293



4x
306901



10x
4222017



4x
302201
50



2x
362201



1x
6294699



2x
4143254



2x
395701



2x
4560178



3x
379501

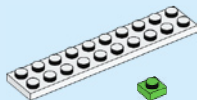

1x
383201



1x
4507055



2x
6335377



2x
6347291



1x
6105708



1x
6328341



2x
6347294



3x
6401817



2x
6347296



2x
4173805



8x
6213776



2x
6278172



3x
6378056



1x
6249559



2x
6249390



1x
6214557



1x
4279734



1x
6185108



2x
6177349



1x
6267189



1x
6103415



4x
4210998



4x
6060795



1x
6096589



1x
6283852



4x
6022084



2x
6022083



3x
6036232

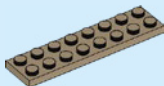

1x
4246957



2x
6006524



1x
6357747



1x
6167643



2x
4656783



2x
6218360



2x
4211159



3x
6055309



2x
4565394



2x
6218359



4x
6057986



1x
6194444



1x
6031019



1x
6132411



1x
6102828



2x
6097053



5x
6099352



7x
6097867



3x
6258091



1x
6106280



1x
6265728



[LEGO.com/service](https://www.LEGO.com/service)

YOU COULD

WIN



Scan this QR code or go to
LEGO.COM/PRODUCTFEEDBACK and give us
your short feedback about this LEGO® set
for a chance to win a cool LEGO prize.

Terms and Conditions apply*

DE: Du könntest GEWINNEN. Es gelten die Teilnahmebedingungen* **FR: Tu pourrais GAGNER.** Des conditions s'appliquent* **IT: Potresti VINCERE tu.** Termini e condizioni sono applicabili* **ES: Puedes GANAR.** Aplican términos y condiciones* **PT: Poderá GANHAR.** Aplicam-se termos e condições* **JA: プレゼント付き! 利用規約が適用されます*** **ZH: 轻松获奖. 条款和条件适用*** **KO: 상품의 주인이 되어보세요. 소정의 약관이 적용됩니다*** **RU: Вы можете ВЫИГРАТЬ.** Действуют положения и условия* **PL: Szansa na WYGRANĄ.** Obowiązują warunki korzystania* **CS: Máte šanci VYHRÁT.** Platí všeobecné smluvní podmínky* **SK: Máte šancu VYHRÁT.** Platia všeobecné zmluvné podmienky* **HU: TE IS NYERHETSZ.** Felhasználási feltételek érvényesek* **RO: Ai putea CÂȘTIGA.** Se aplică termenii și condiții* **BG: Можете да СПЕЧЕЛИТЕ.** Има определени правила и условия* **LV: Tu vari LAIMĒT.** Ir spēkā noteikumi un nosacījumi.* **ET: Sul on võimalus VÕITA.** Kehtivad tingimused* **LT: Jūs galite LAIMĖTI.** Taikomos sąlygos*

*[LEGO.com/productfeedback-terms](https://www.lego.com/productfeedback-terms)