

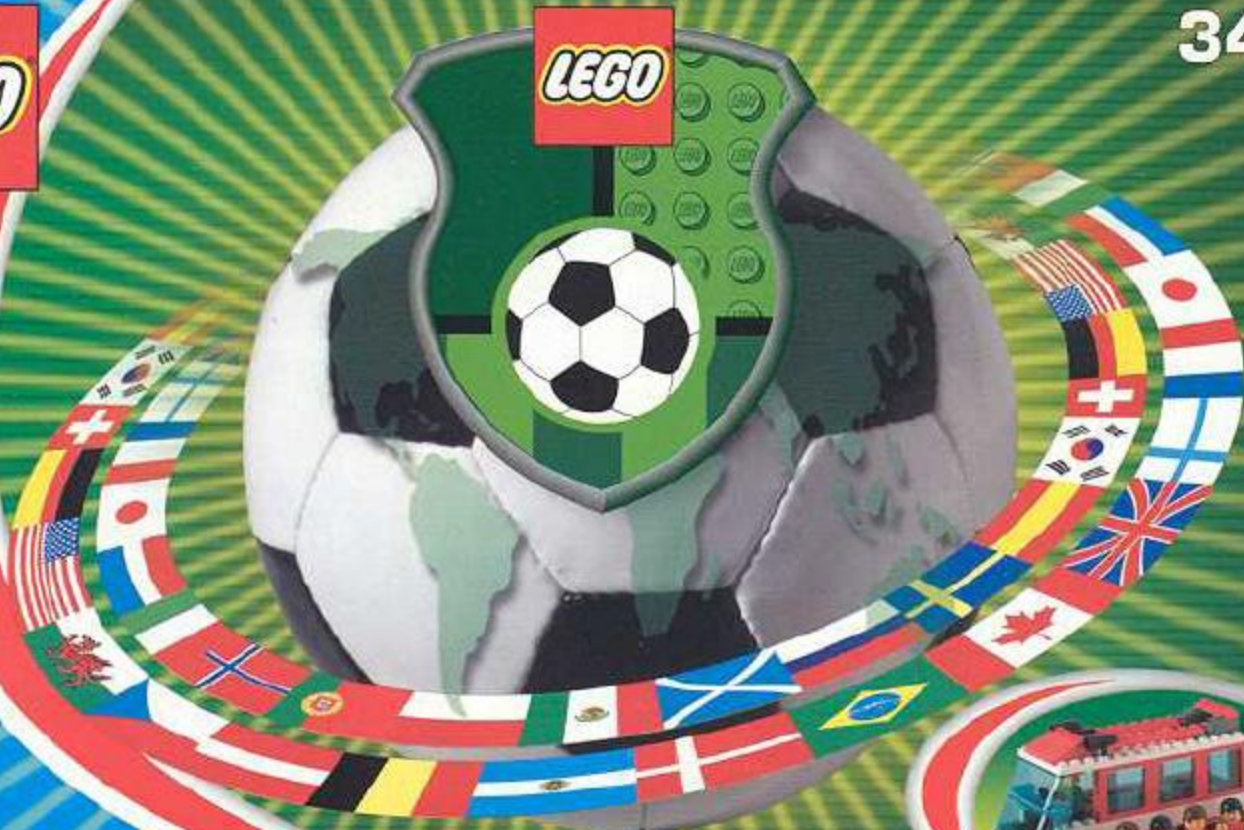

The LEGO logo is displayed in its characteristic white font with a black outline, set against a red square background.A smaller version of the LEGO logo is positioned on a red shield-shaped piece that is part of the soccer ball's construction.

3426



 **WARNING: CHOKING HAZARD.**
Toy contains small parts and a small ball.
Not for children under 3 years.

4177067





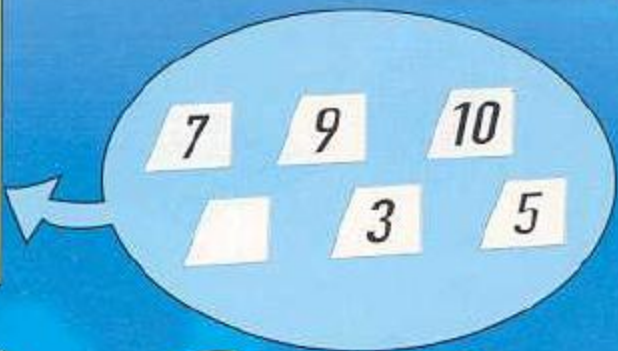
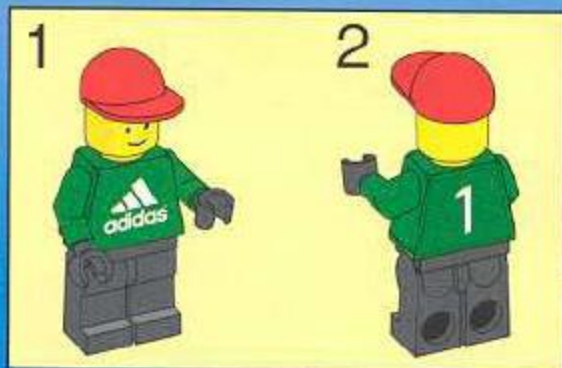
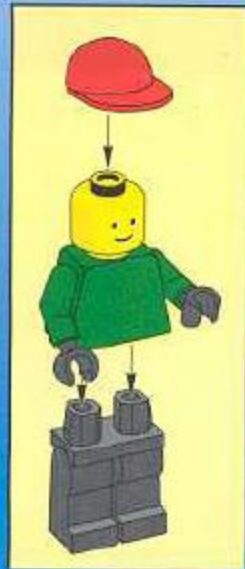

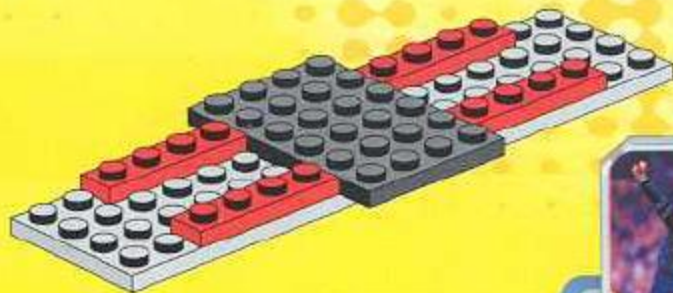
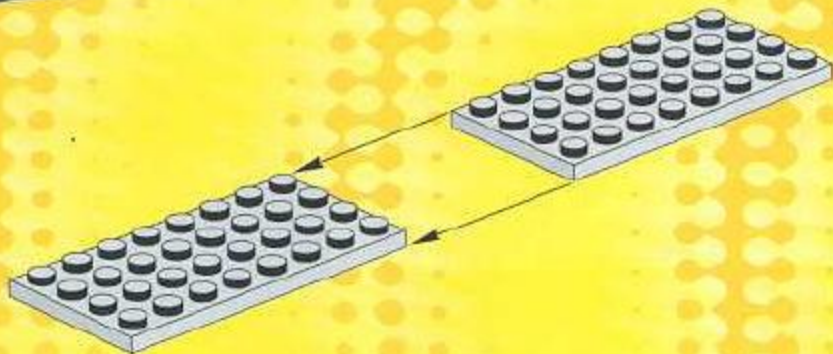

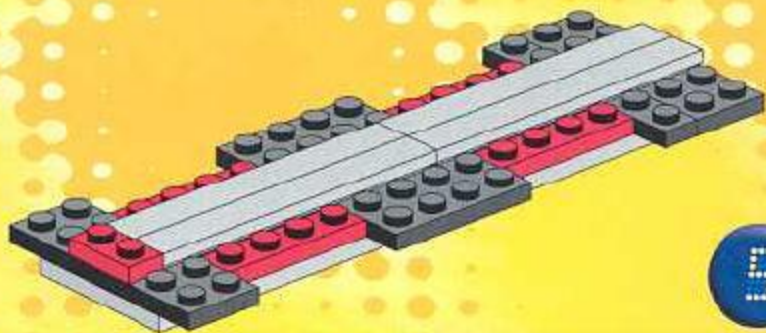
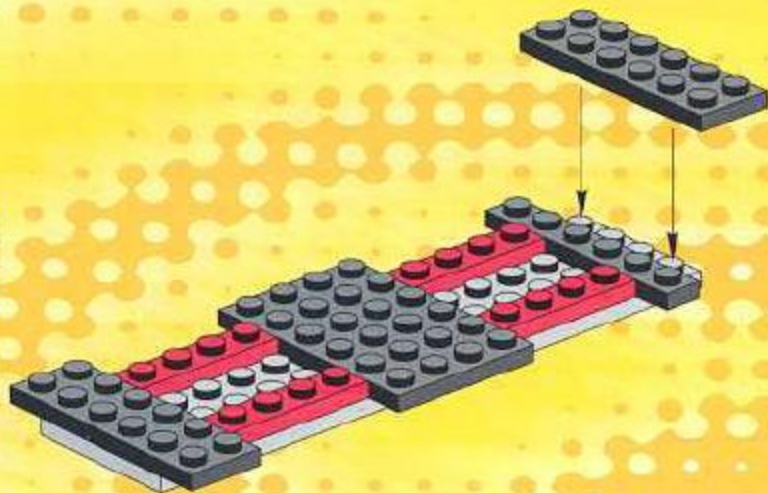

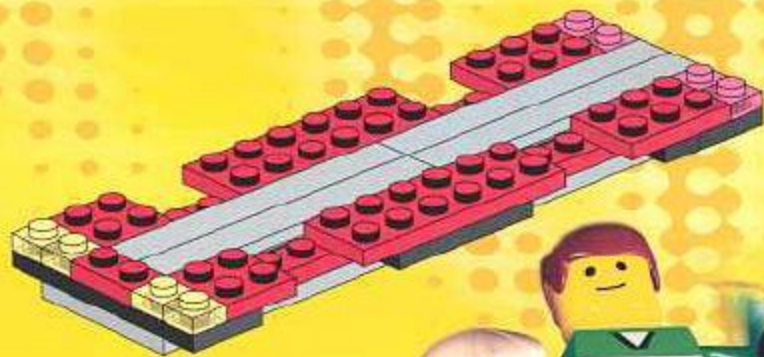
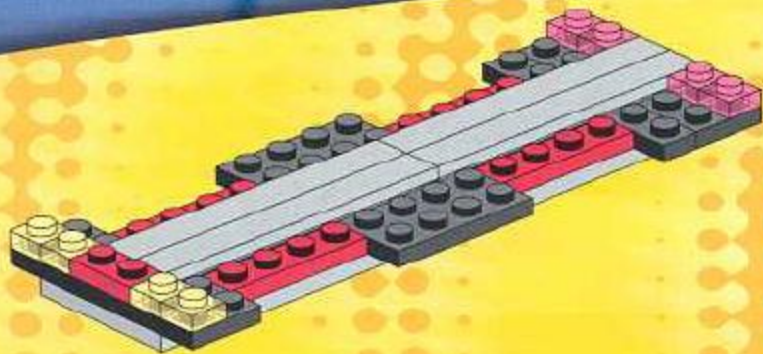

7

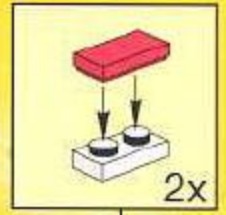
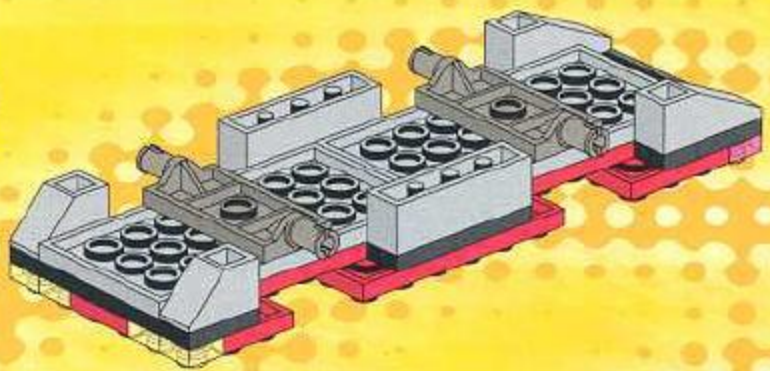

8

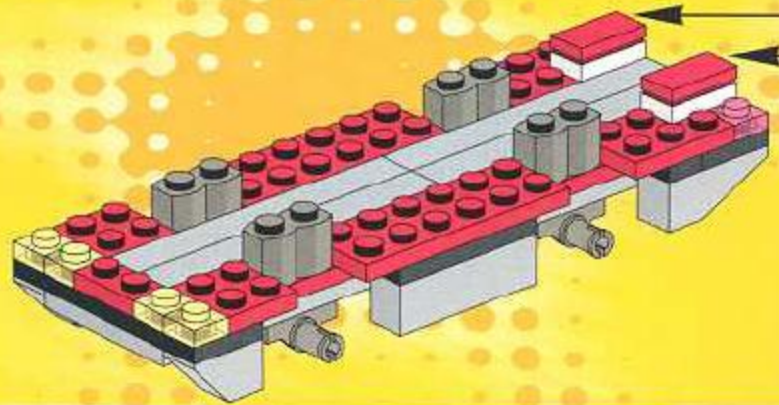

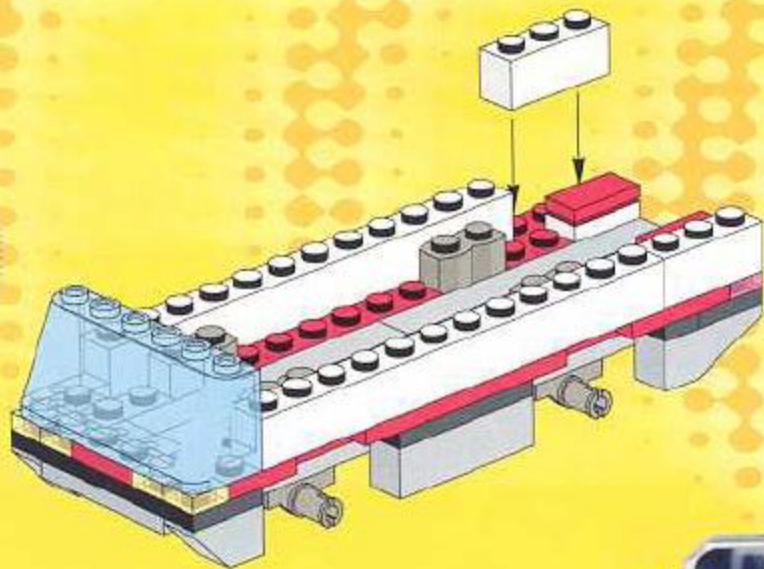

1

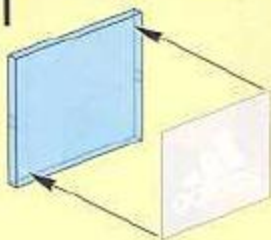

2



2x



10

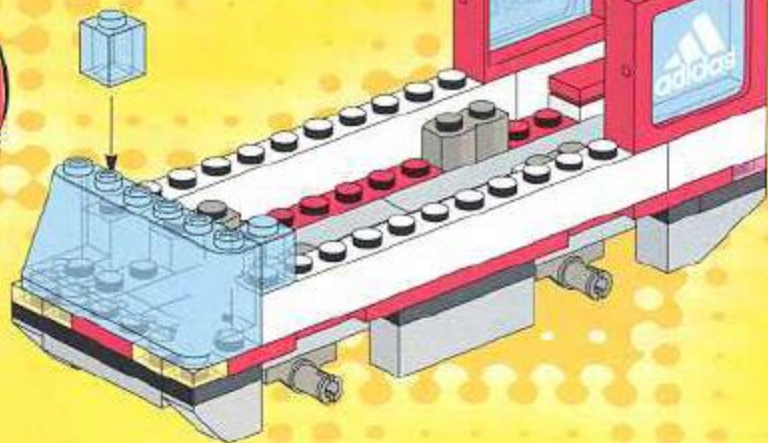

5

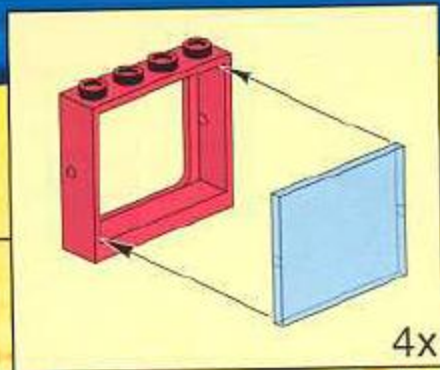
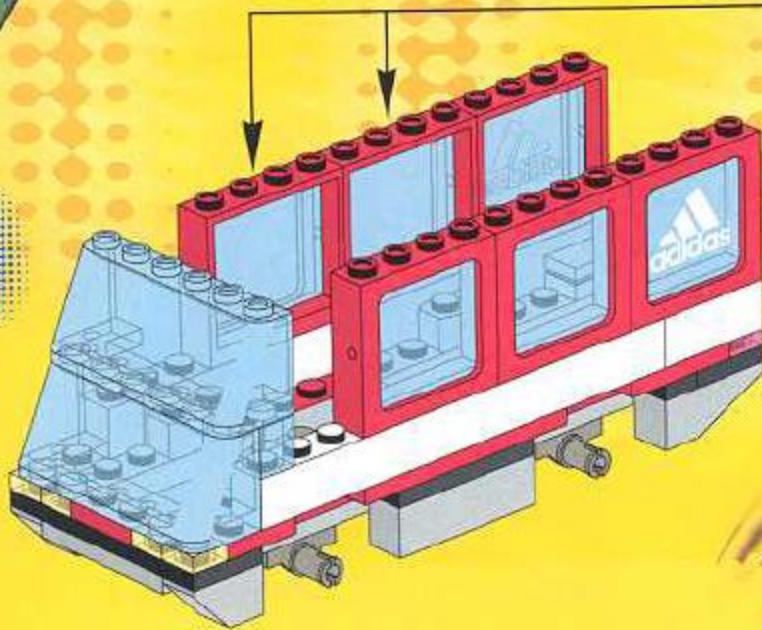

12

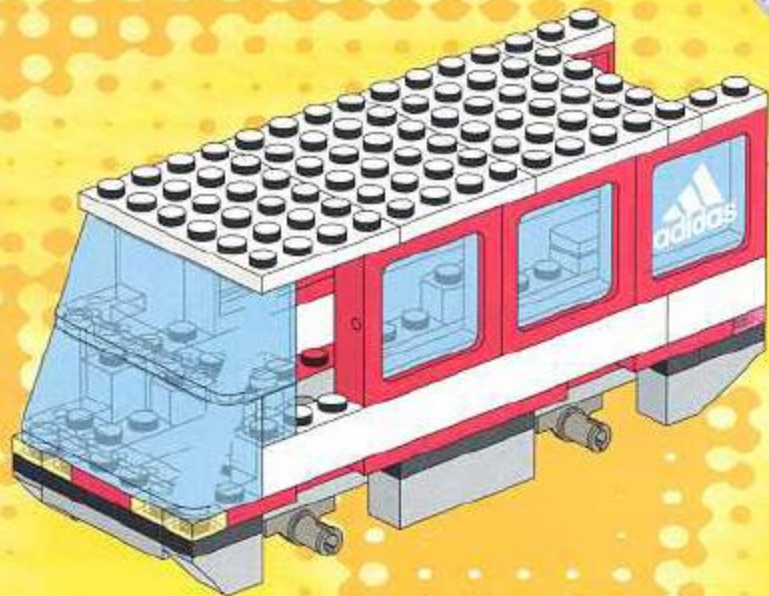

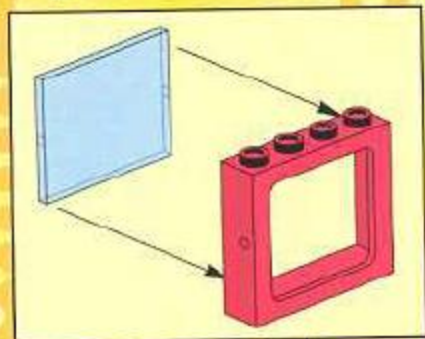
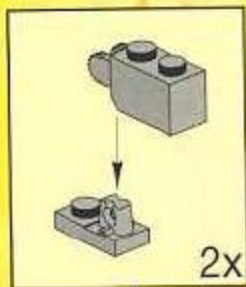

13

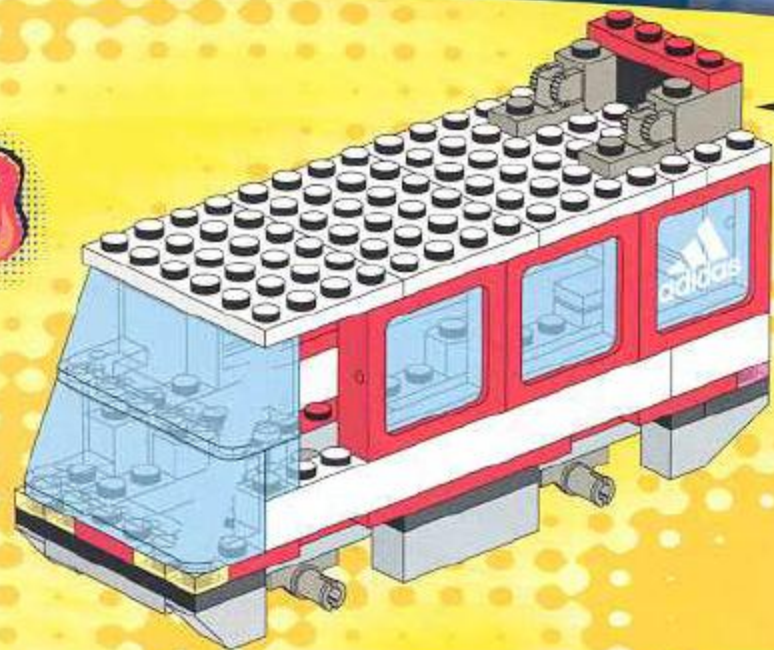

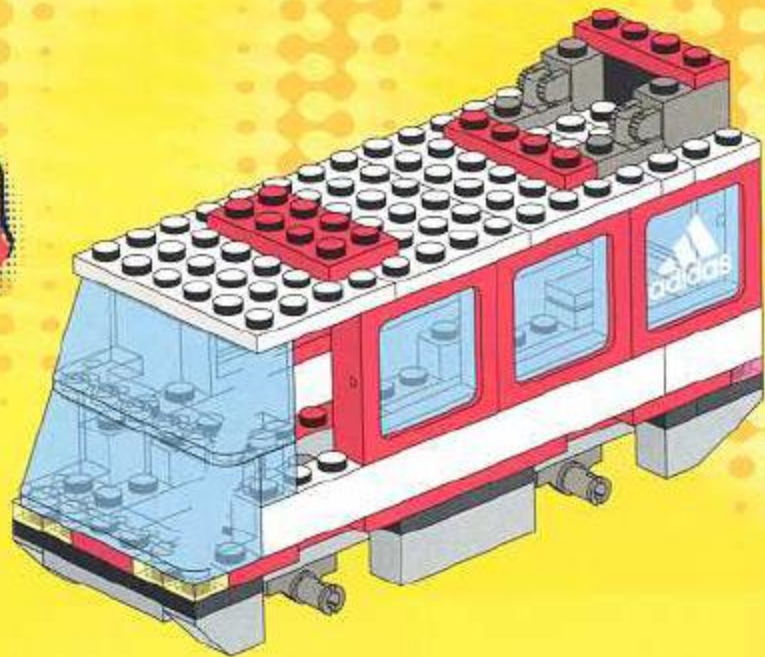

15

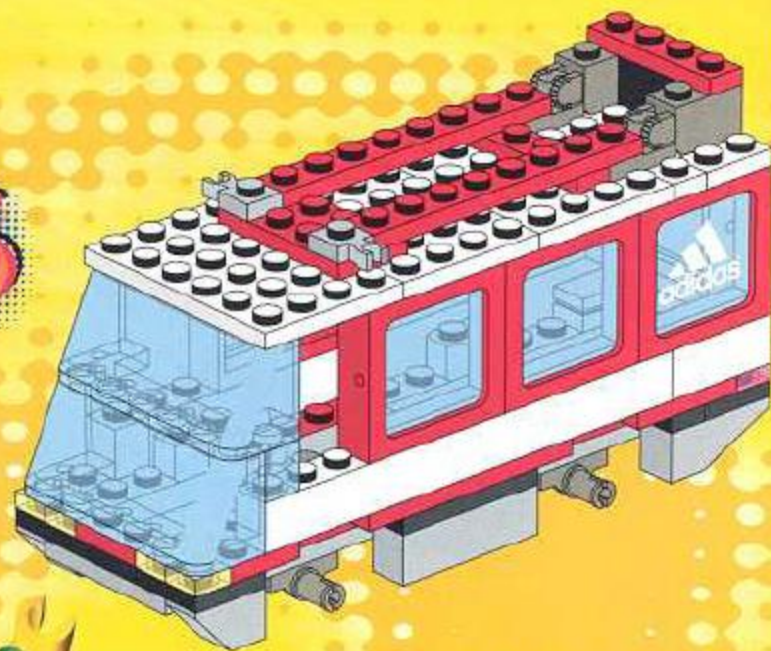

15



16

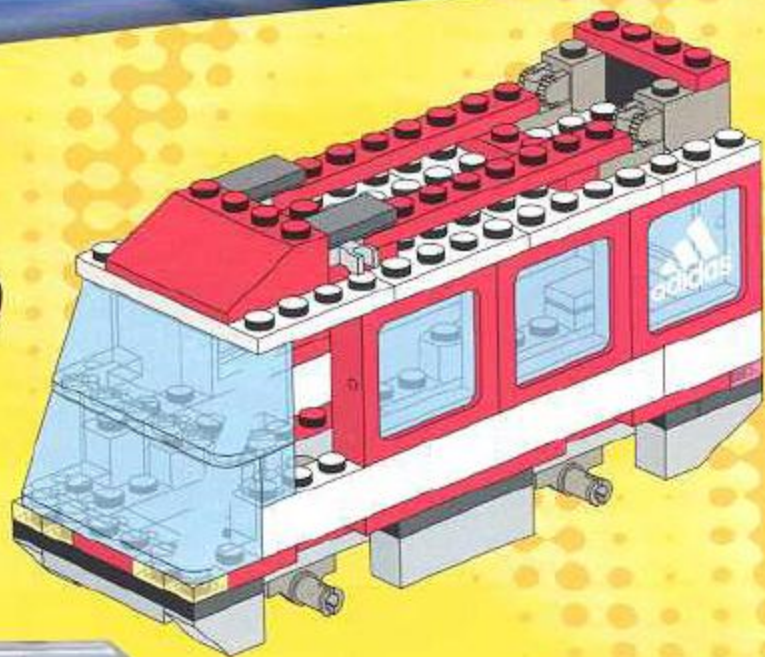

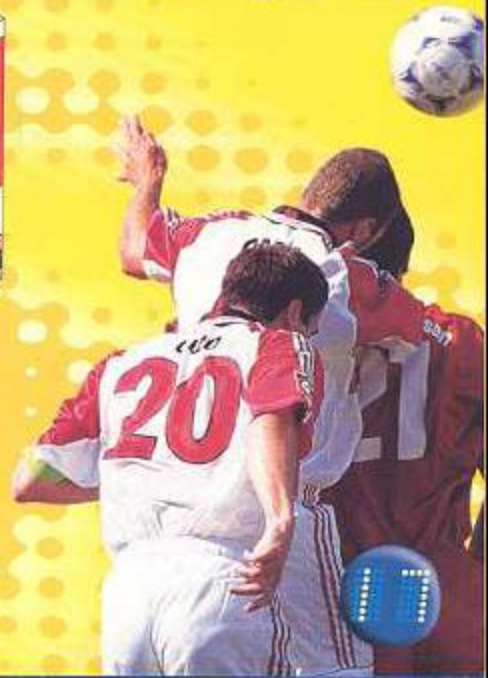



1

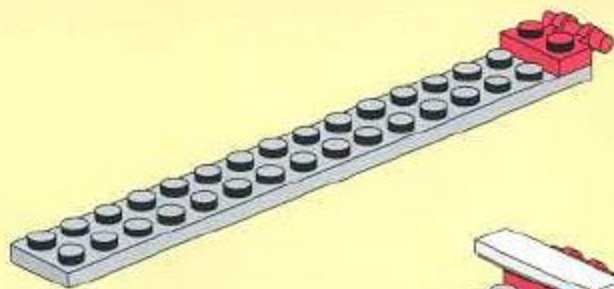

2

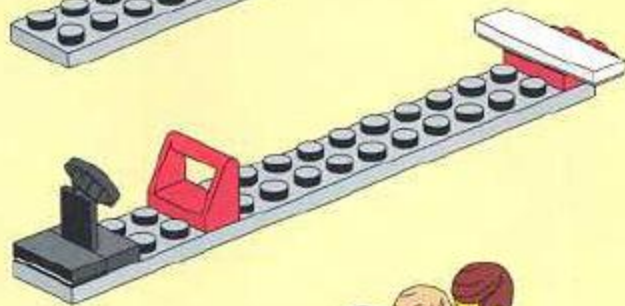

3

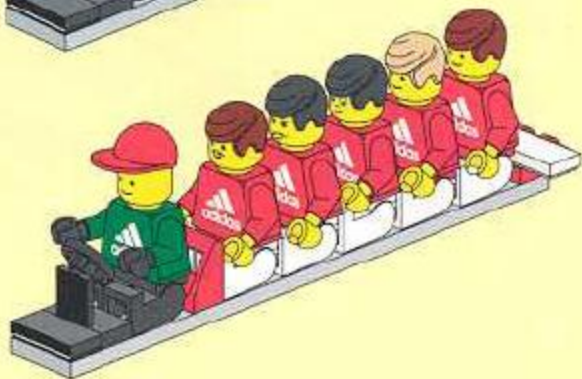

18

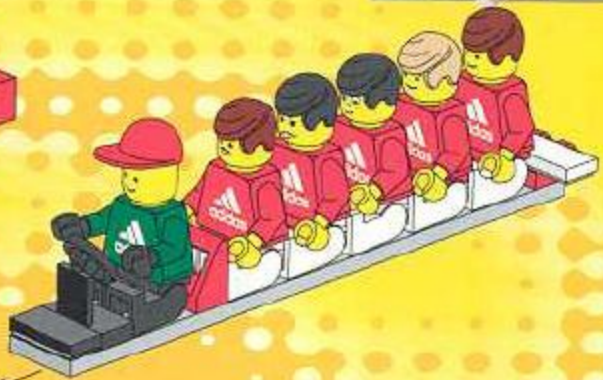

19



19



FOOTBALL MANIA

A LEGO minifigure with a yellow head and black hair, wearing a red suit and yellow shoes, is flying through space. The minifigure is holding a large white LEGO Technic piece. In the background, a rocket with a red nose cone and white body is flying, leaving a long, bright yellow and orange trail. A soccer ball is also visible in the scene.

GAME BOY ADVANCE



PlayStation 2

Nintendo® and Game Boy Advance™ are trademarks of Nintendo Co., Ltd.
PlayStation and the PlayStation logo are registered trademarks of Sony Computer Entertainment Inc.
LEGO and the LEGO logo are trademarks of The LEGO Group. © 2001 The LEGO Group.





3423



3424



3422



3421



3420



3425





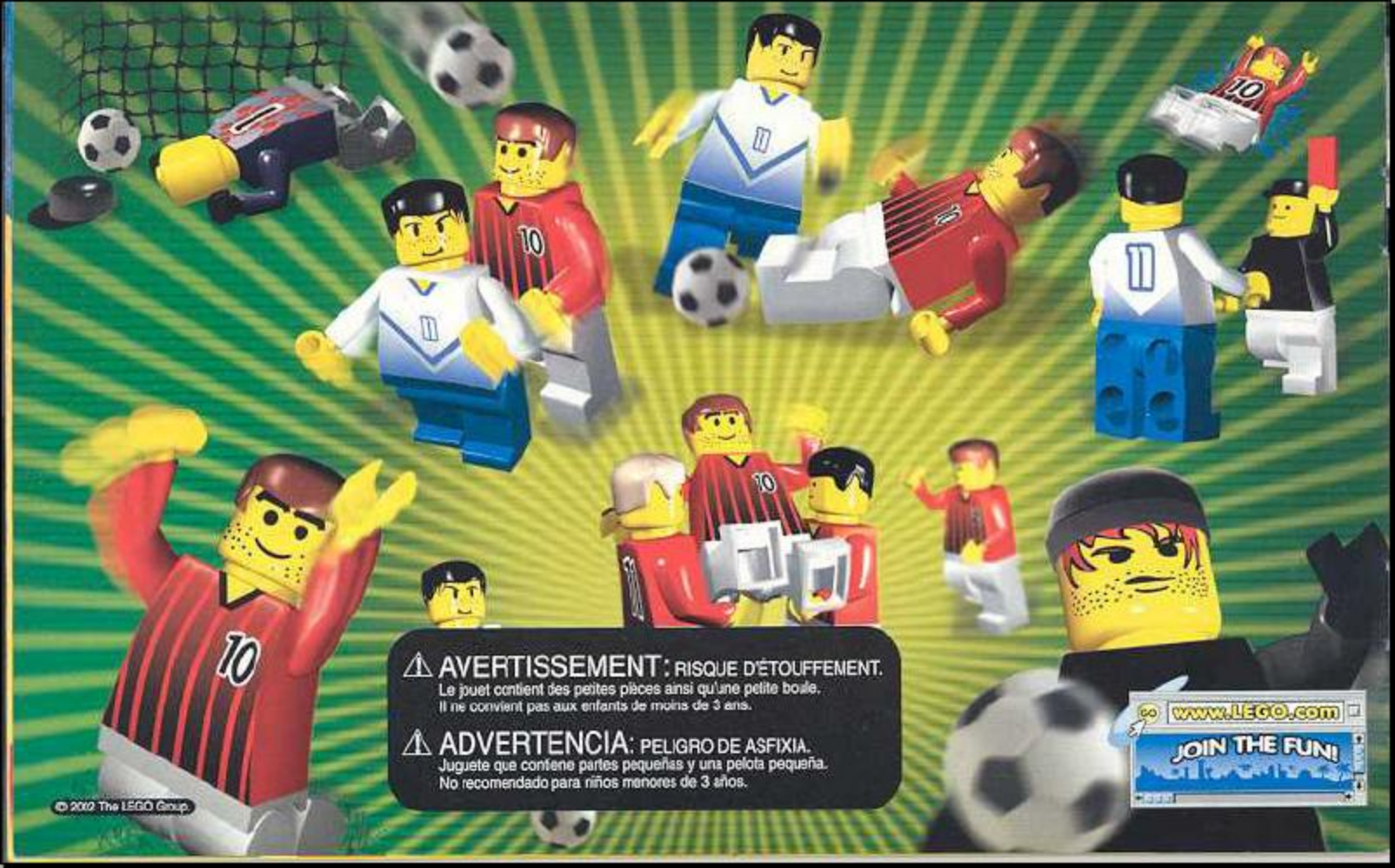

⚠️ AVERTISSEMENT : RISQUE D'ÉTOUFFEMENT.

Le jouet contient des petites pièces ainsi qu'une petite balle.
Il ne convient pas aux enfants de moins de 3 ans.

⚠️ ADVERTENCIA: PELIGRO DE ASFIXIA.

Juguete que contiene partes pequeñas y una pelota pequeña.
No recomendado para niños menores de 3 años.