



SCOOBY-DOO!

75902



[LEGO.com/scoobydoo](https://www.LEGO.com/scoobydoo)





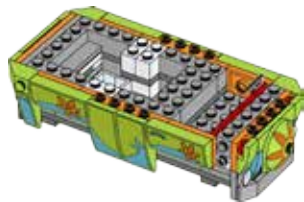

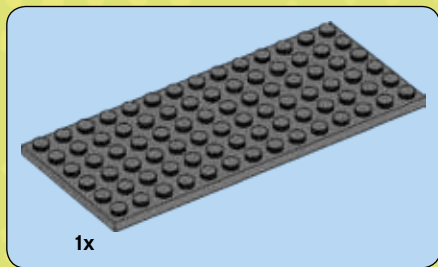

1

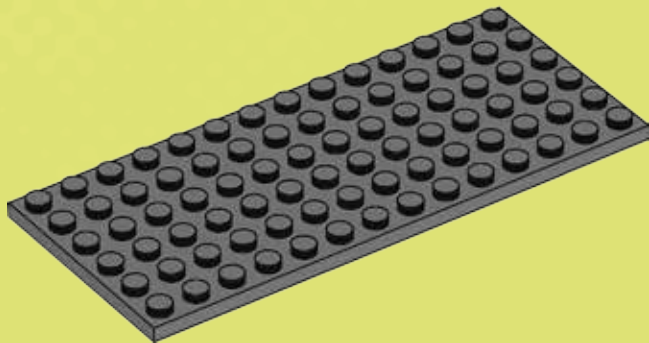



2

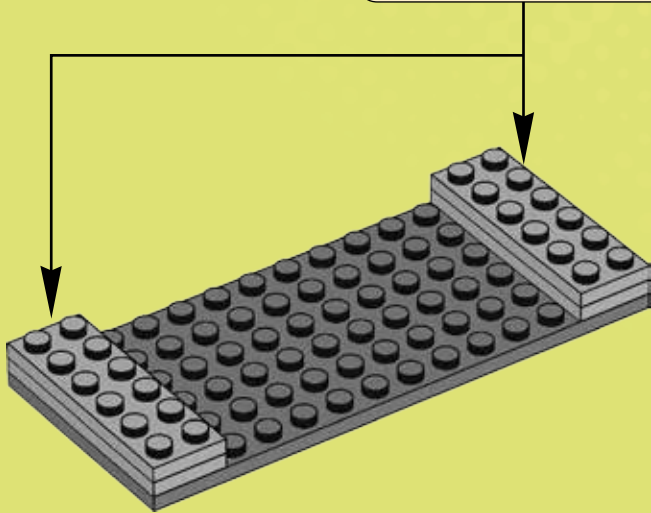
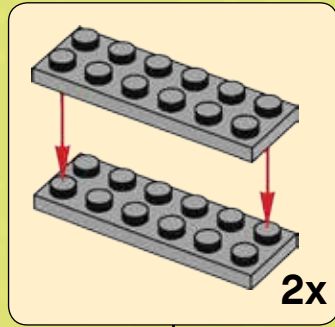



2x

3

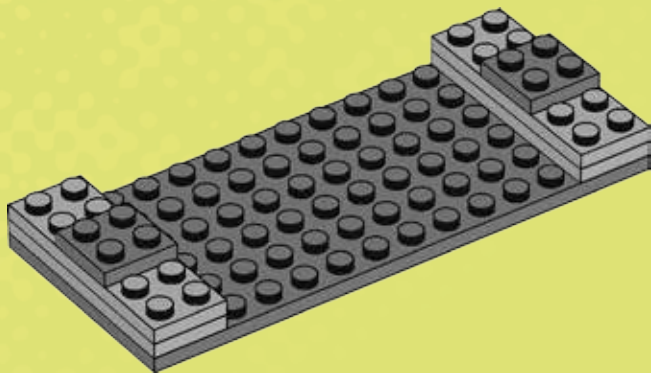



4x

4

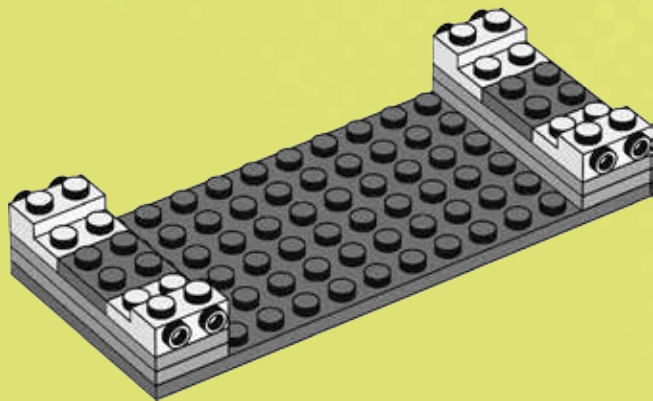



2x

5

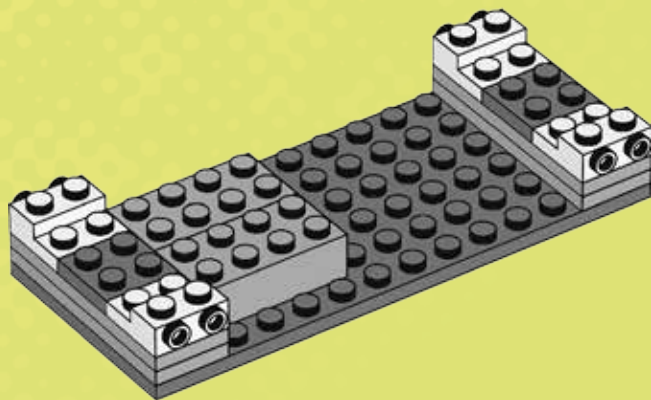

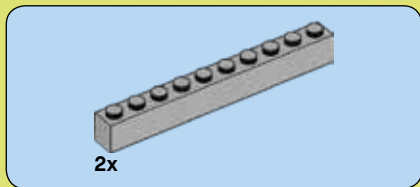

6

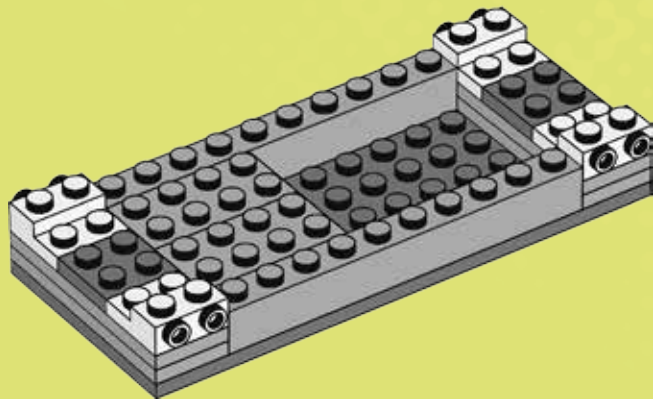



4x

7

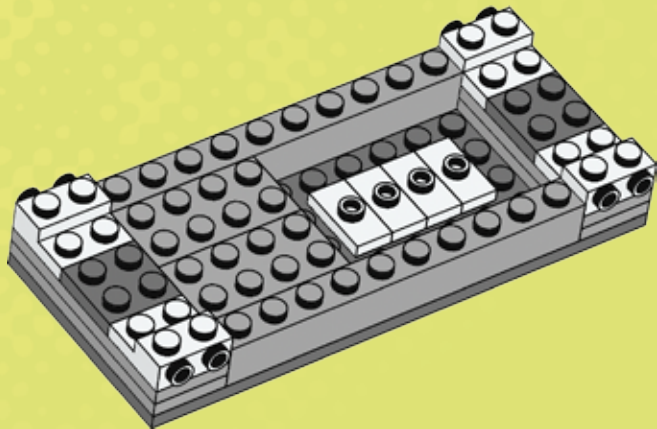



2x

8

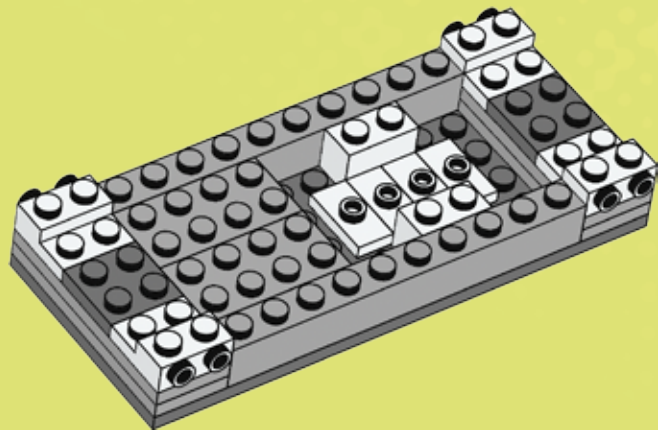



1x



2x

9

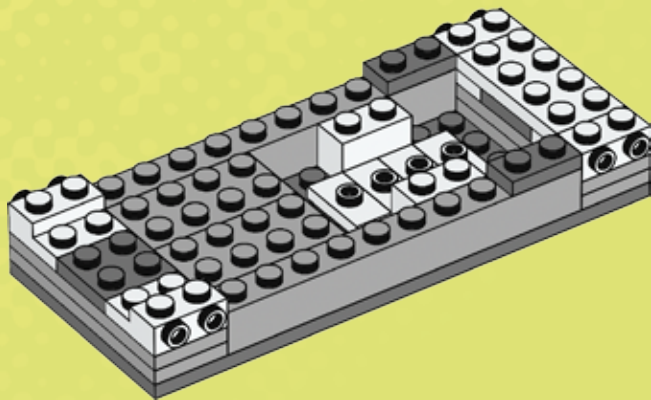



2x



2x

10

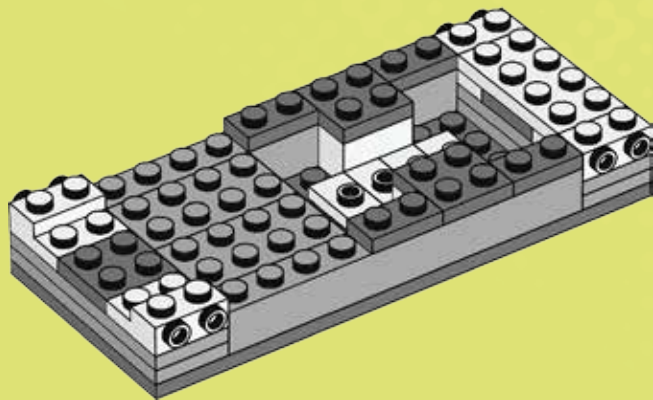



2x



1x

11

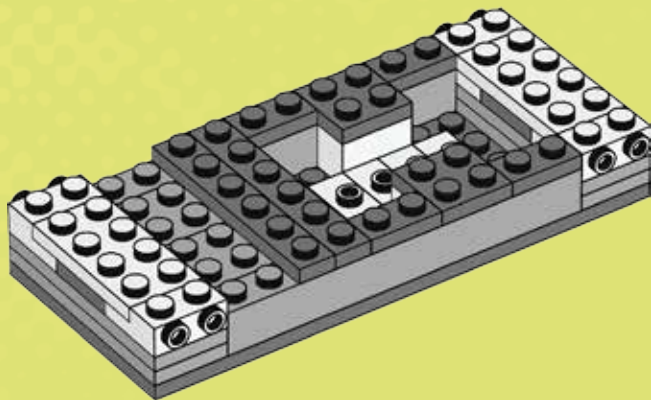

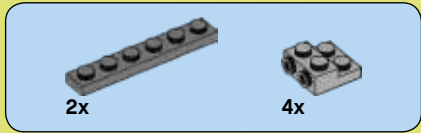

12

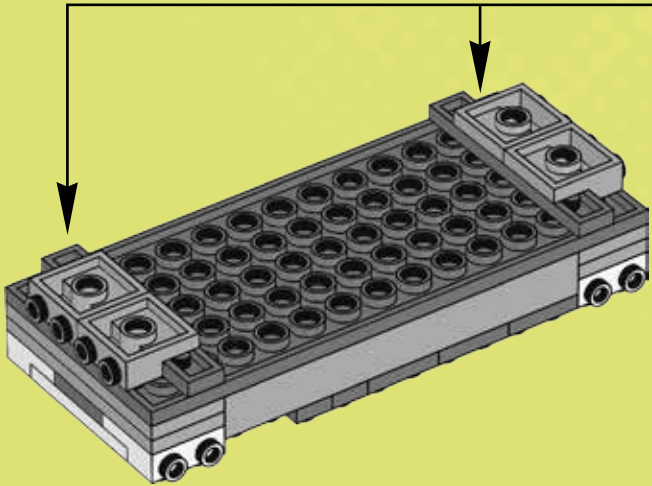
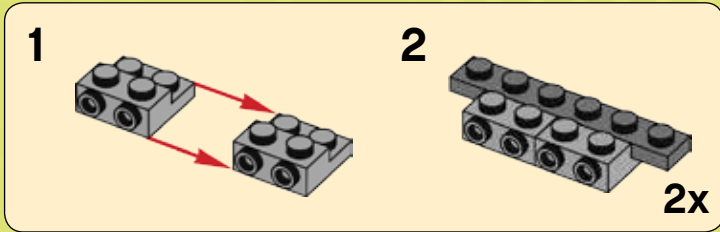



1x



1x

13

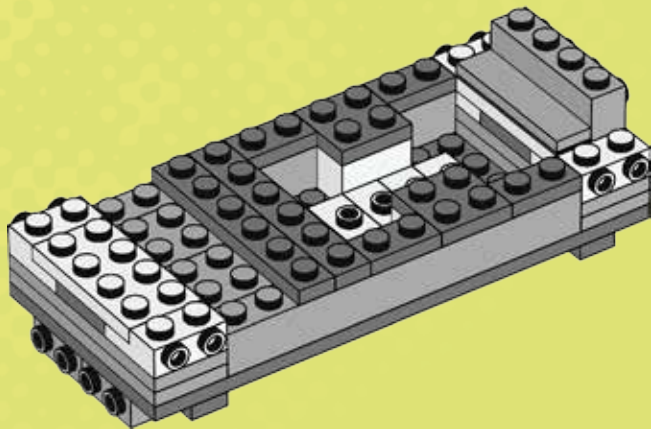



2x

14

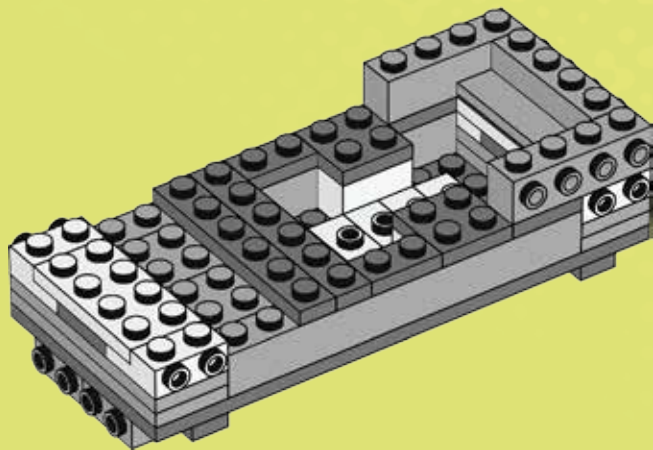



3x



2x

15

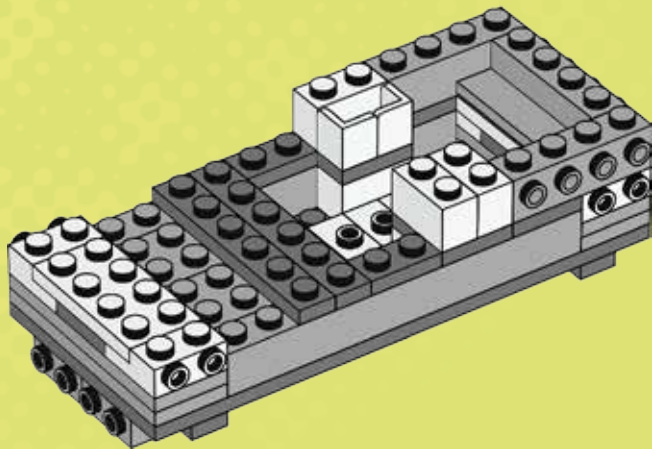



1x



2x

16

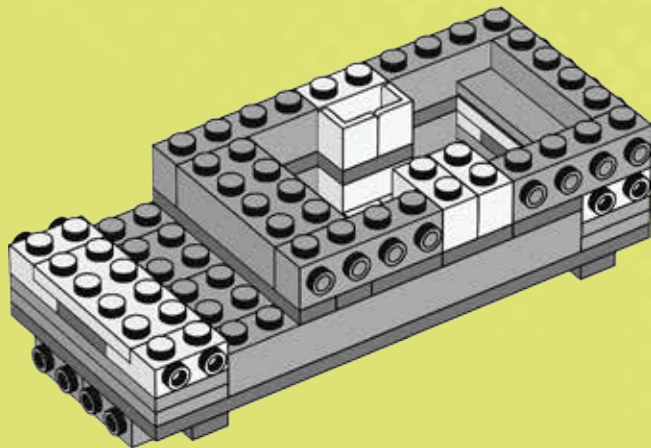



1x



1x

17

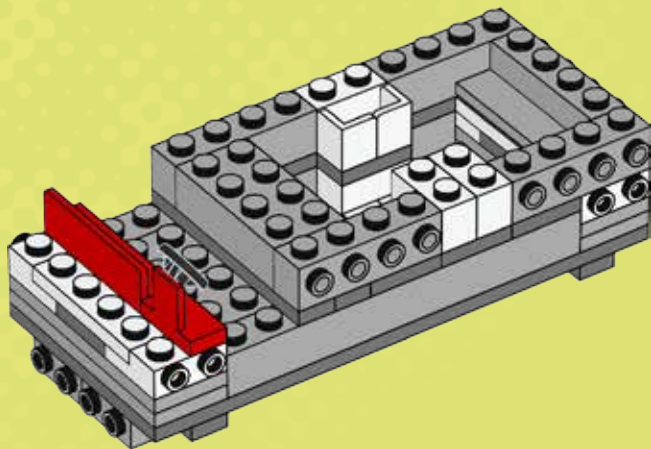



1x



2x

18

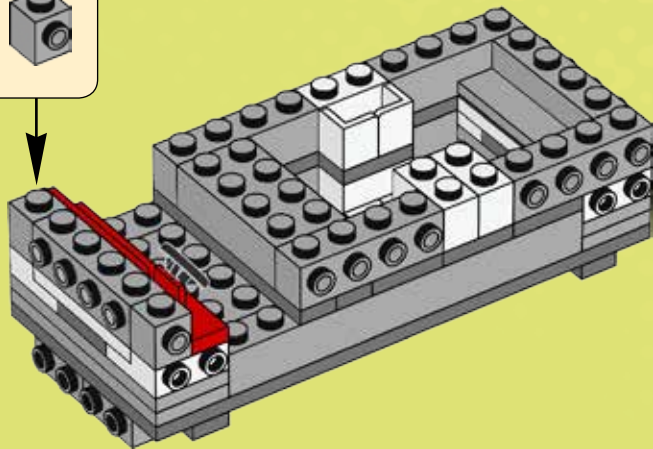

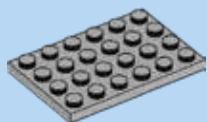

1x

1



1x

2

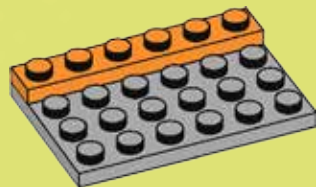

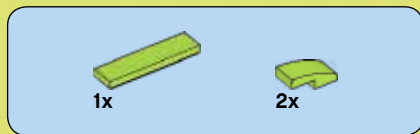

3



4

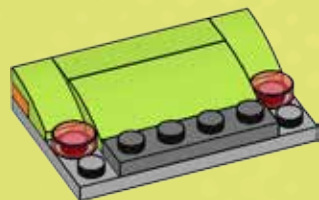



1x



2x

5

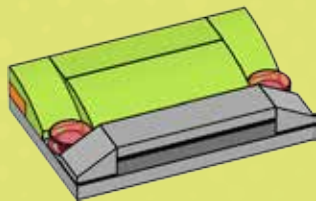

19

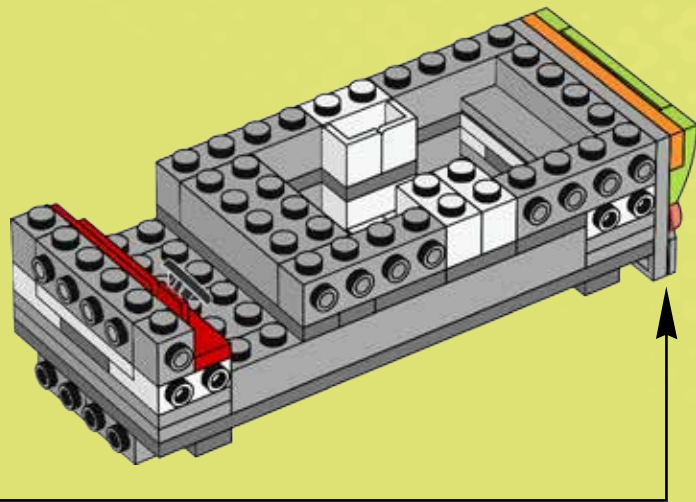

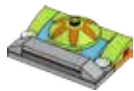

1x

1



4x



1x

2





1x



2x

3

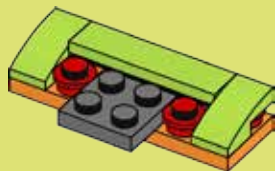

1x

4

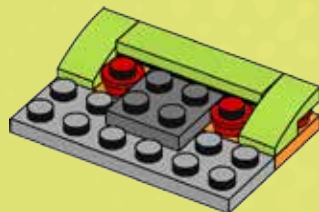



2x



2x

5



1x



1x



1x

6

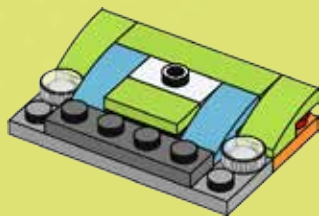

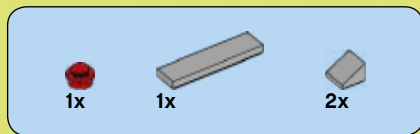

7

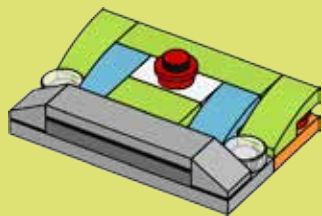

8

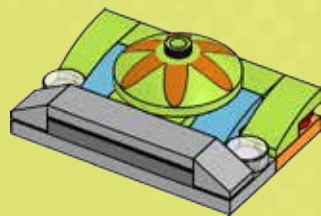

20

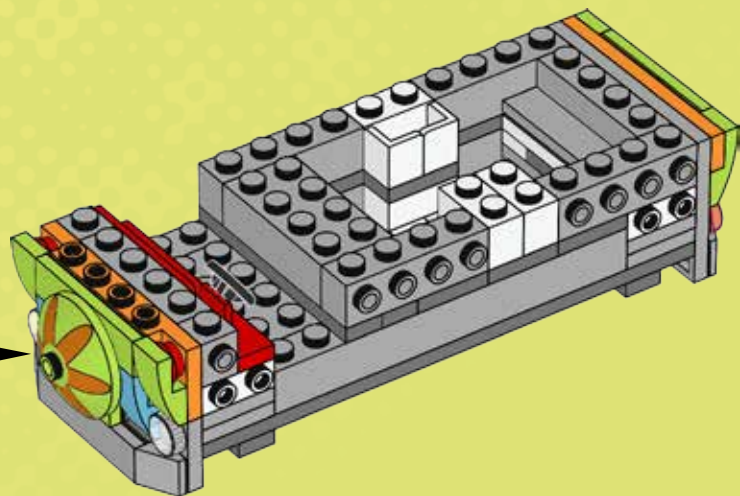

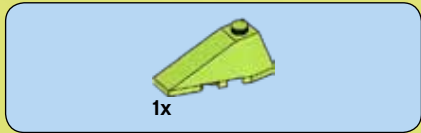

21

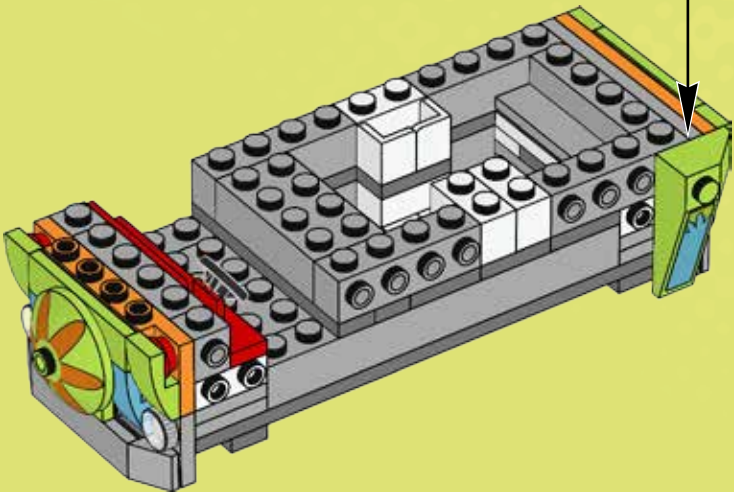
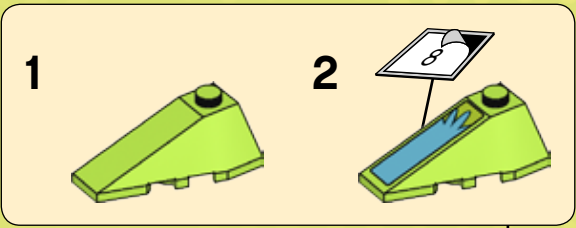

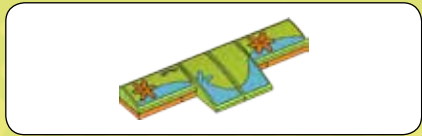

1

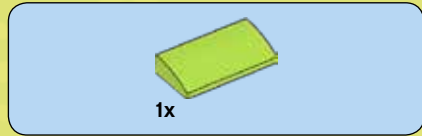

2

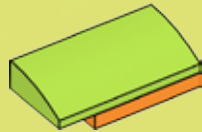



1x

3

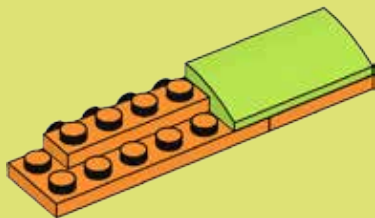

2x

4

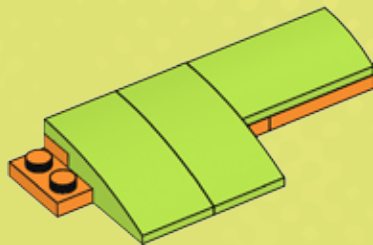



1x

5

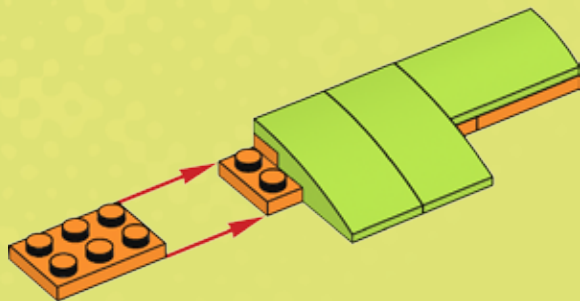

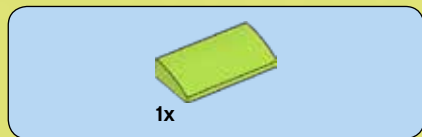

6

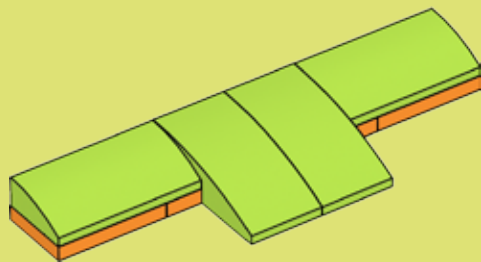

7

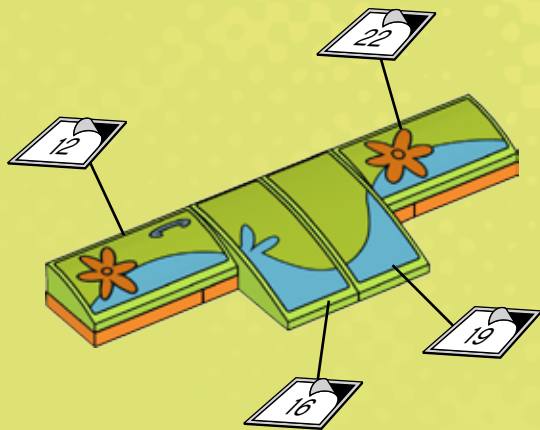

22

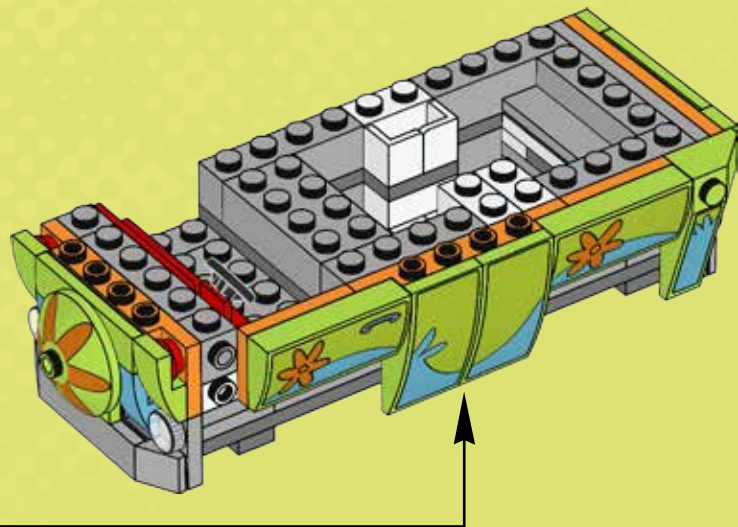



1x

23

1



2

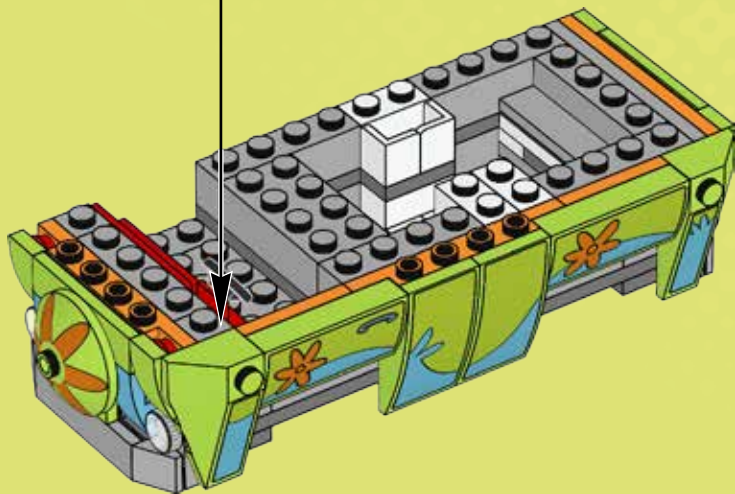



1x

24



1

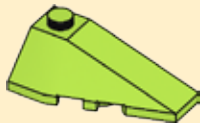

2

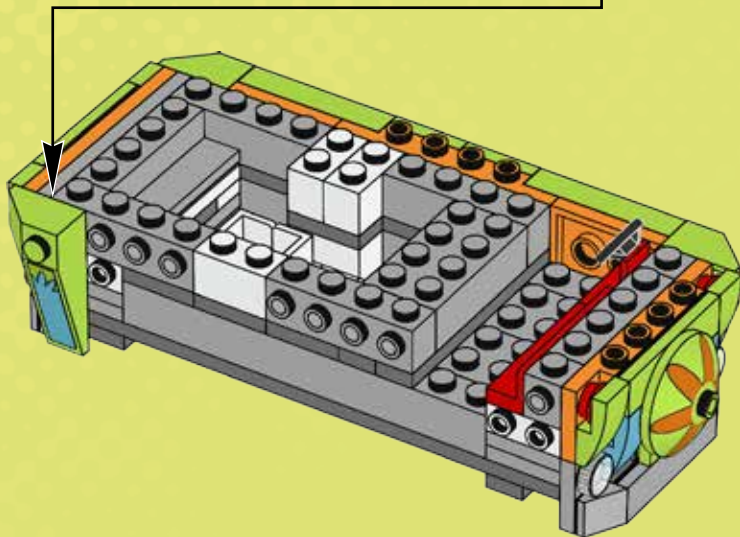

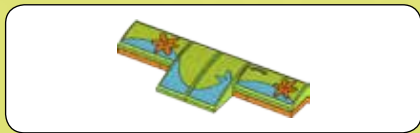

1

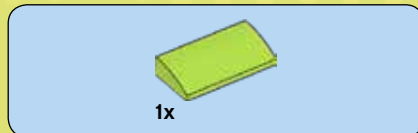

2





1x

3

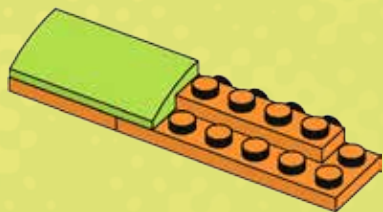

2x

4

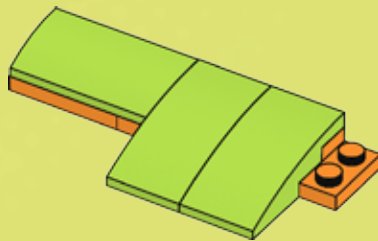



1x

5

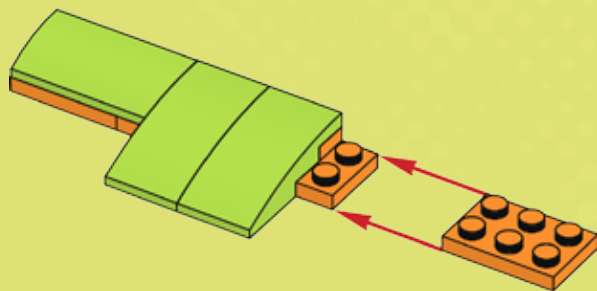

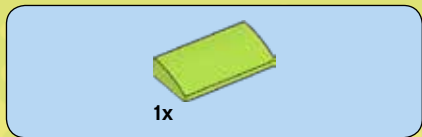

6

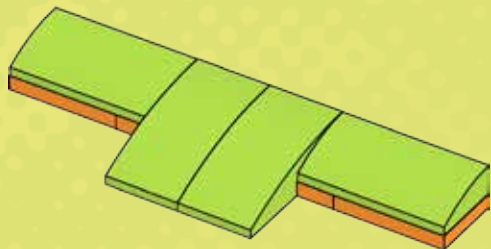

7

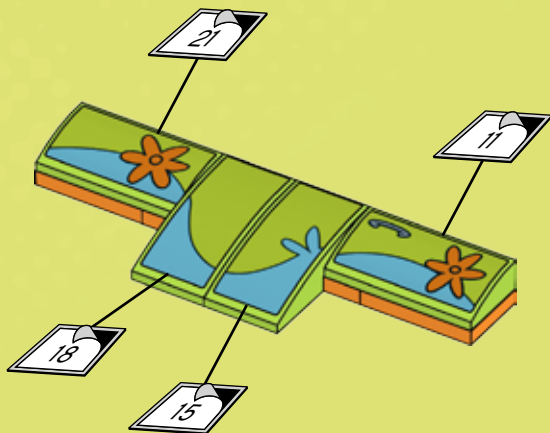

25

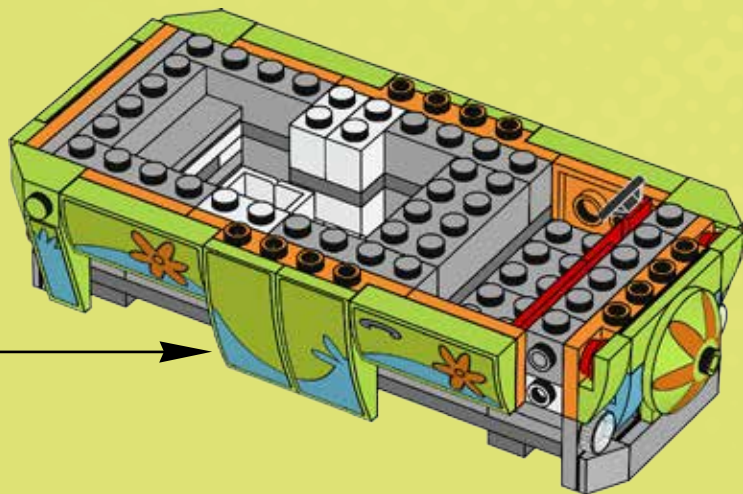

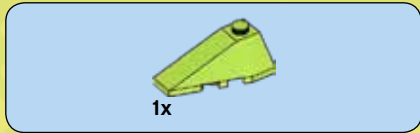

26

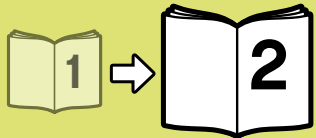
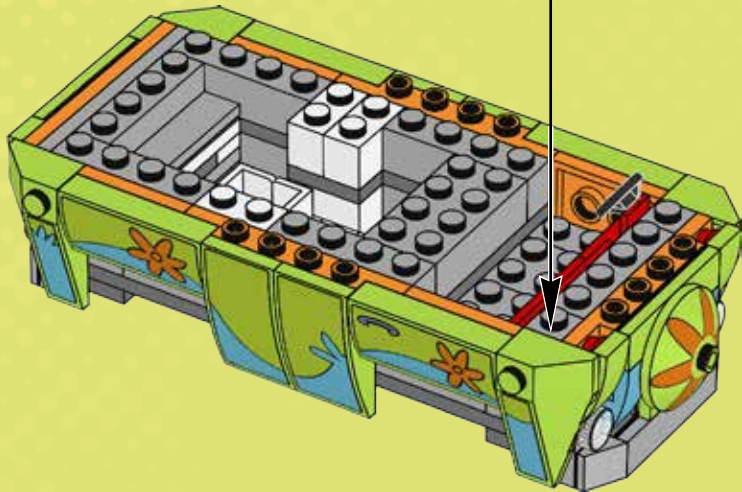
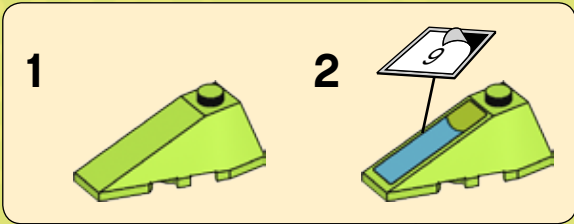



SCOOBY-DOO!

WE'VE GOT A MYSTERY TO SOLVE
WIR MÜSSEN EIN GEHEIMNIS LÜFTEN
NOUS AVONS UN MYSTÈRE À RESOLVER
TENEMOS UN MISTERIO QUE RESOLVER
TEMOS UM MISTERIO PARA RESOLVER
MÁIS VAN EGY MEGOLDÁSRA VÁRO REJTELKÜNK

75900



75901



75902



75903



75904



LEGO.COM/scoobydoo





*More spooky fun at
Noch mehr Gruselspaß auf
Plus d'amusement effrayant sur
Màs diversión tenebrosa en
Mais diversão arrepiante em
További rémisztő móka itt
LEGO.com/scoobydoo*

LEGO *SCOOBY-DOO!*

Apple, the Apple logo, iPad, iPhone and iPod touch are trademarks of Apple Inc.
Google Play is a trademark of Google Inc.

ANDROID APP ON
Google play

Available on the
App Store



LEGO

DC COMICS
**SUPER
HEROES**

76034

**SUPER
JUMPER**



76035



DC
COMICS™



BATMAN and all related characters and elements are trademarks of and © DC Comics.



WB SHIELD: TM & © Warner Bros. Entertainment Inc. (s15)



SCOOBY-DOO!

75902



[LEGO.com/scoobydoo](https://www.LEGO.com/scoobydoo)



2





2x

27

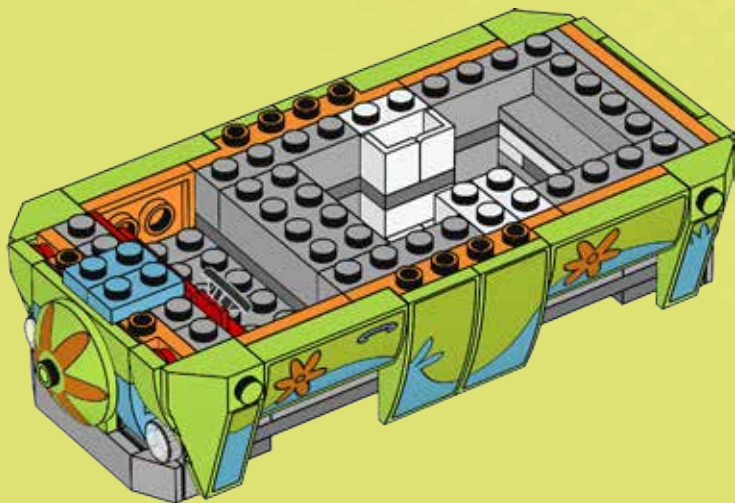



2x



2x

28

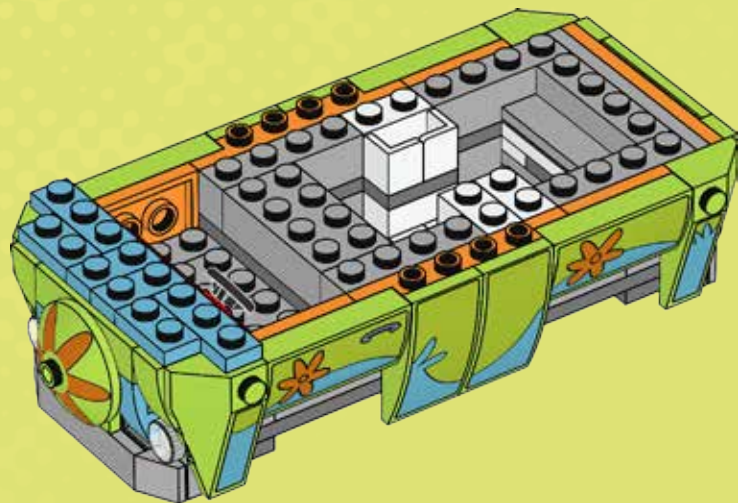

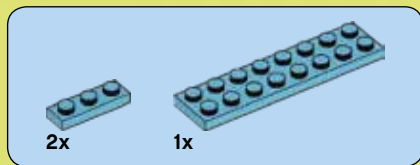

29

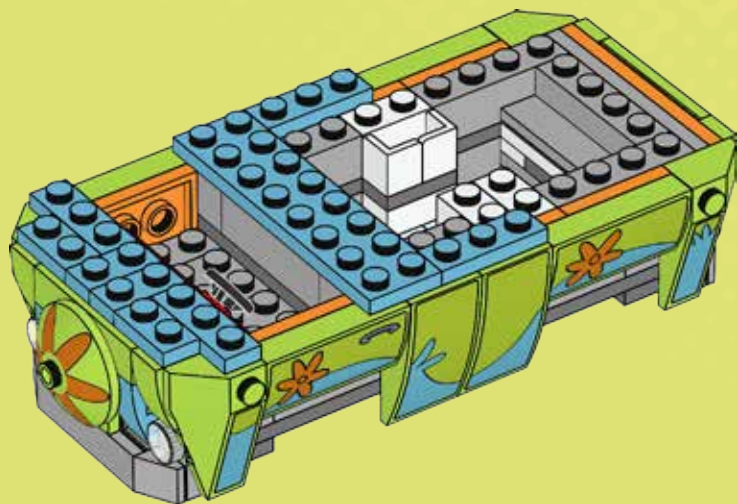



4x

30

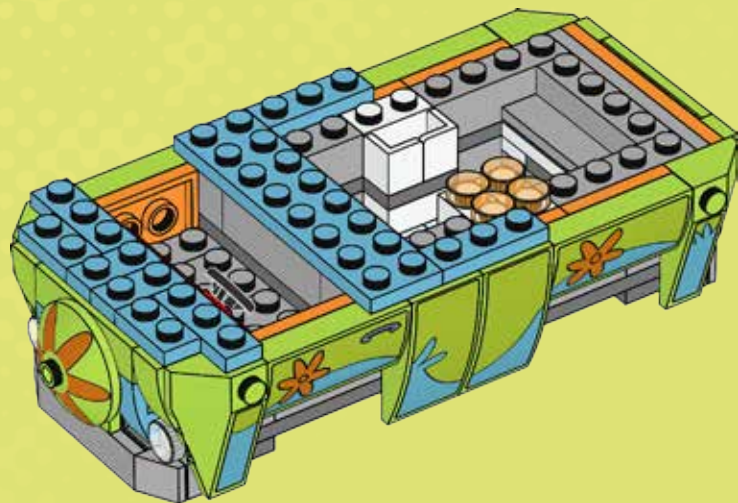



2x



1x

31

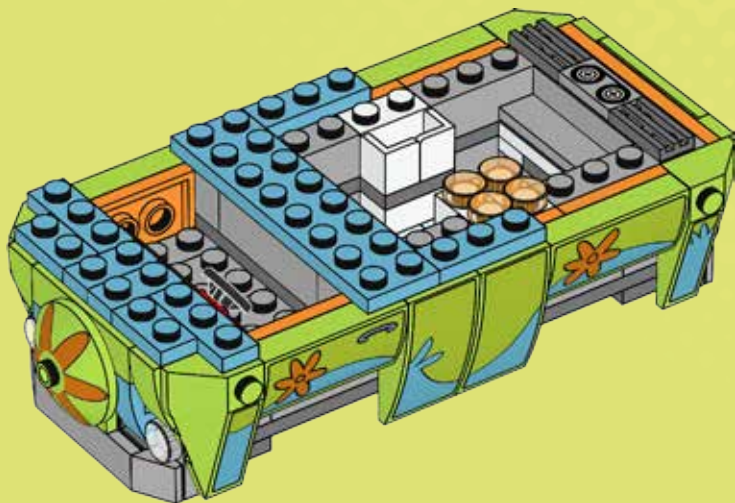

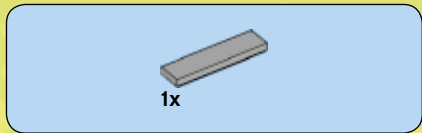

32

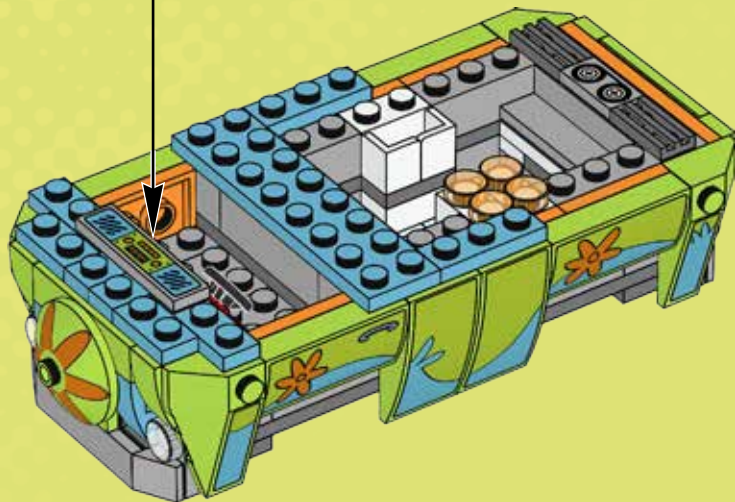
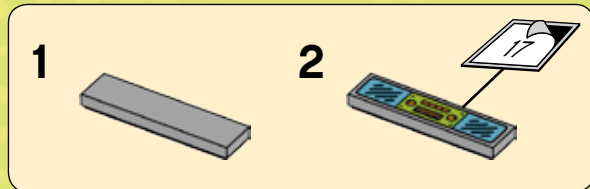



2x

33

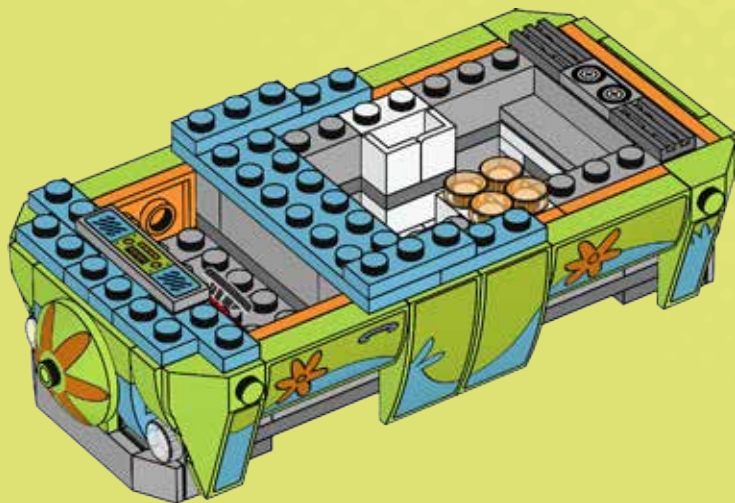



1x

1



1x

2

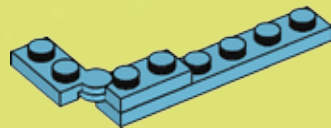



1x

3

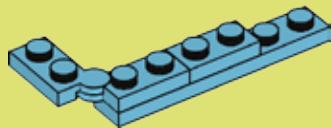

1x

4

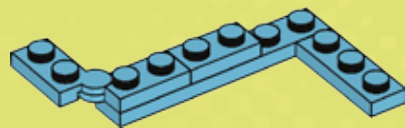



1x

5

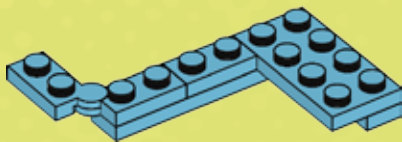

34

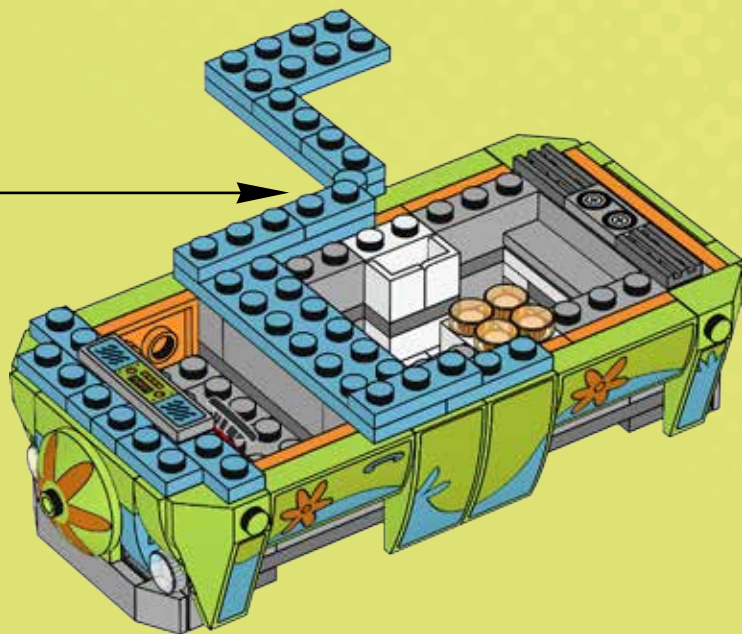



1x

1



1x

2

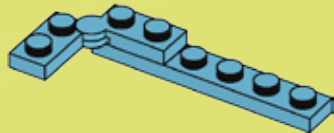



1x

3

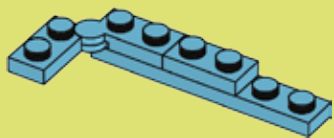

1x

4

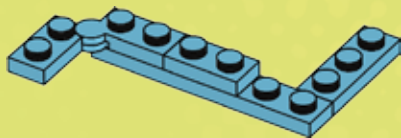



1x

5

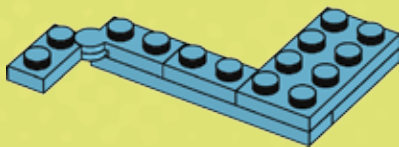

35

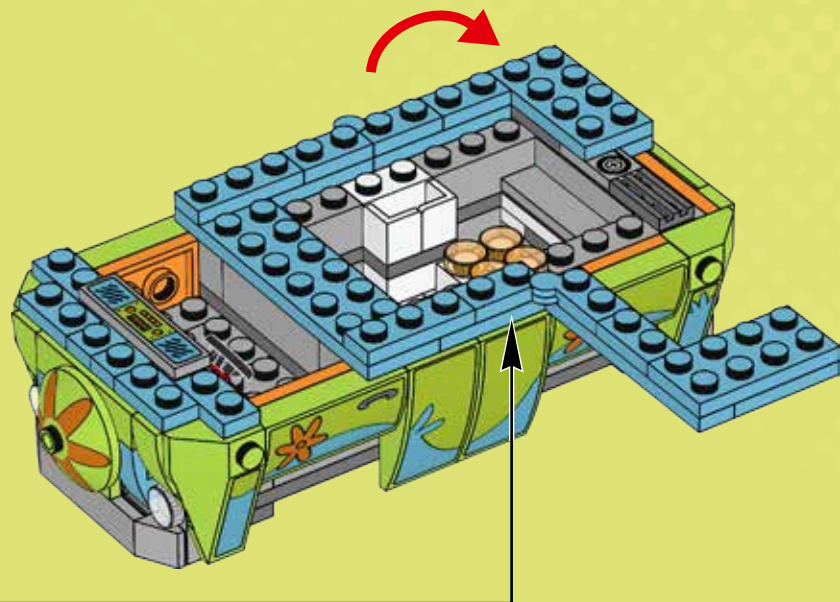

36

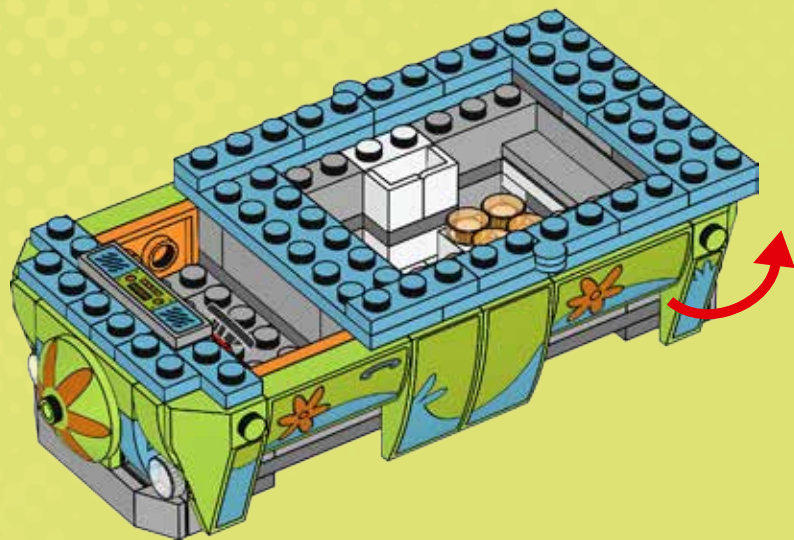



37

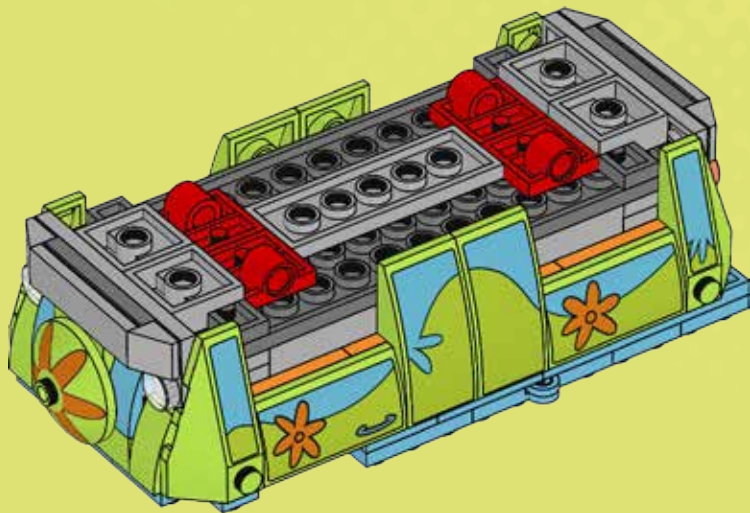
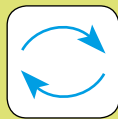

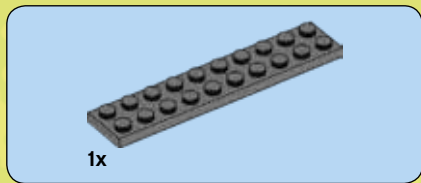

38

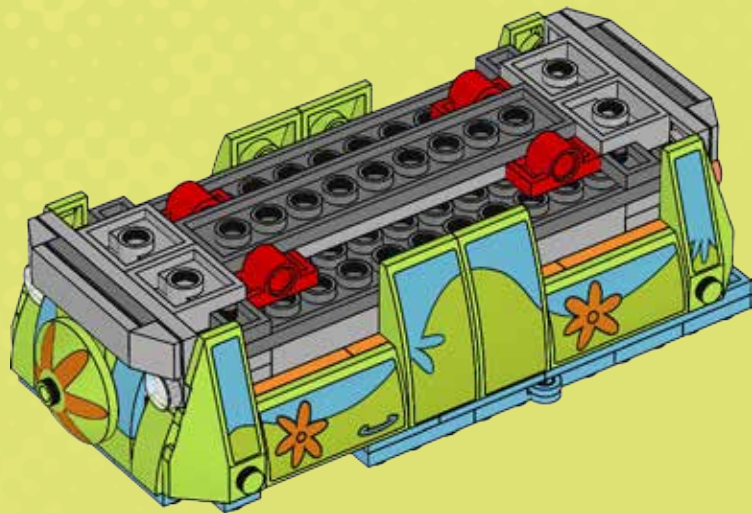



4x

39

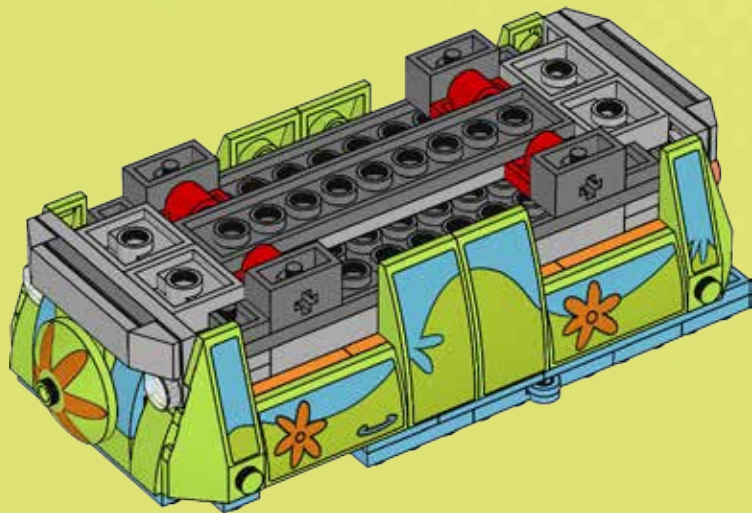



2x

40

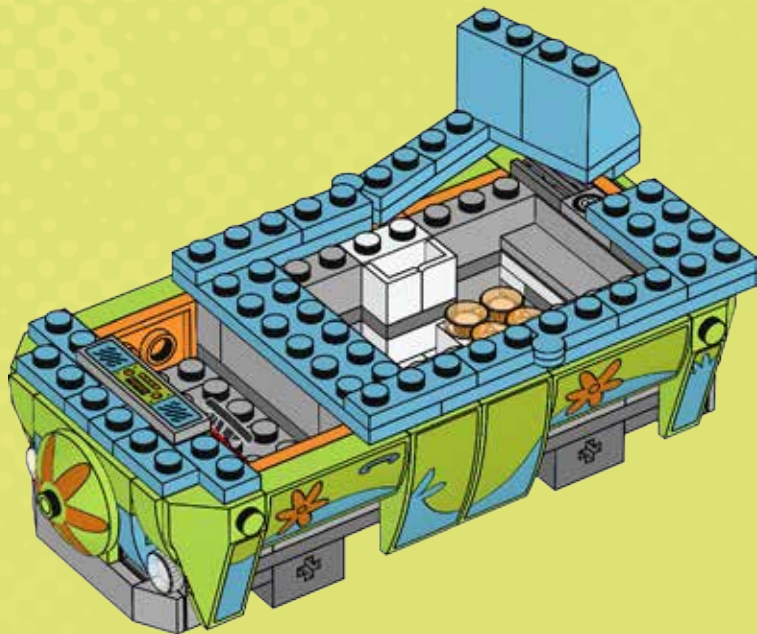
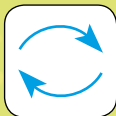



2x

41

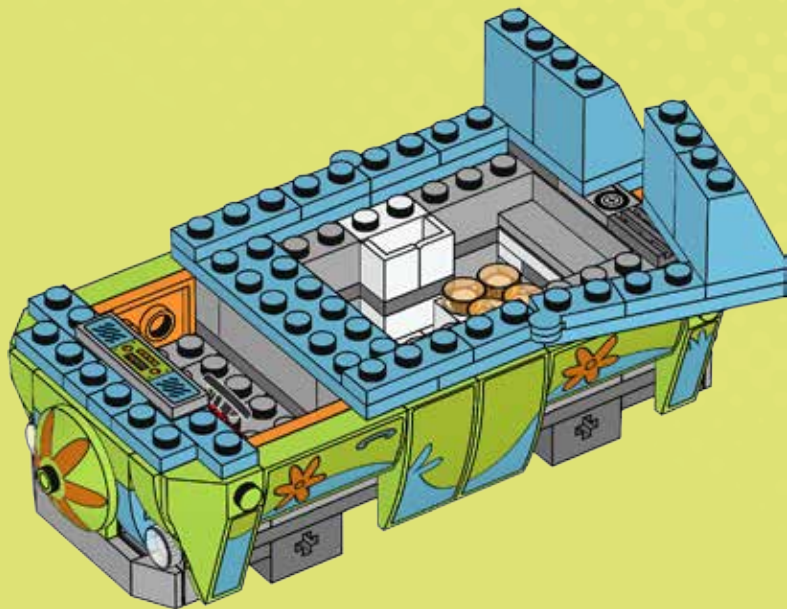



1x



1x



1x

42

1

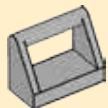

2

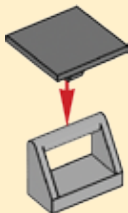

3

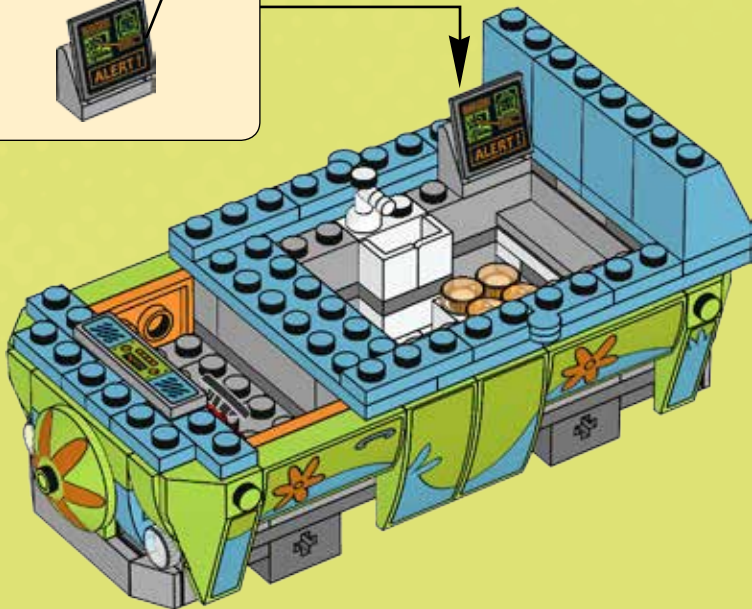



1x



1x

43

1

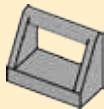

2

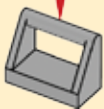

3

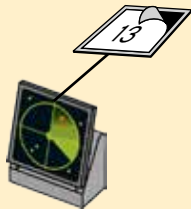



44

1



2



3

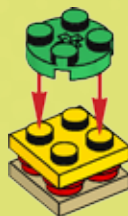

4



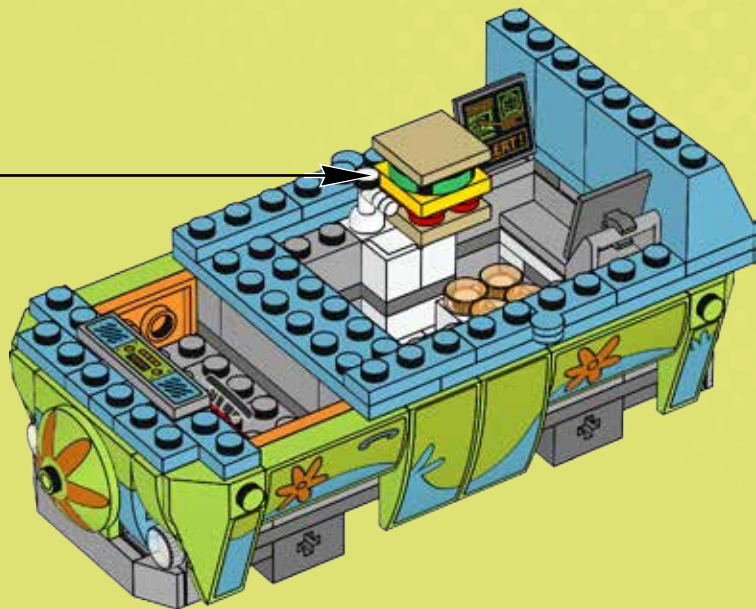

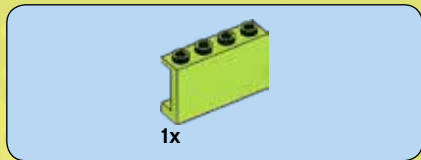

45

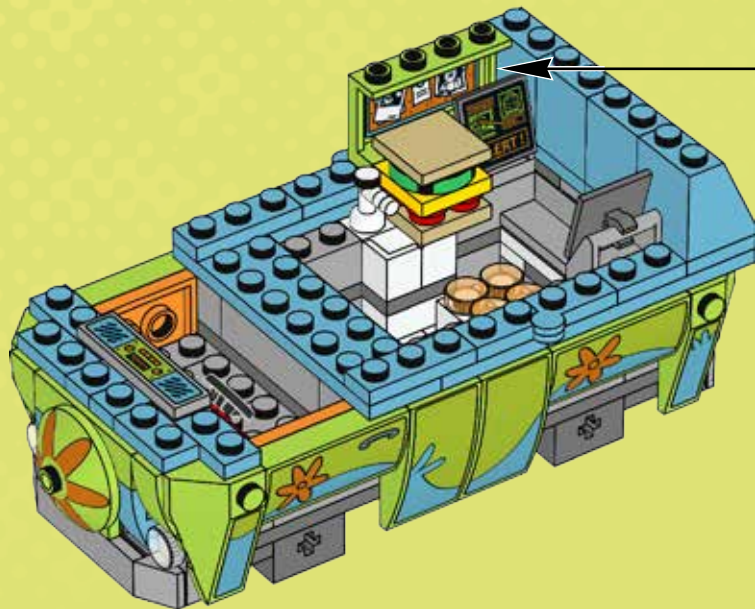
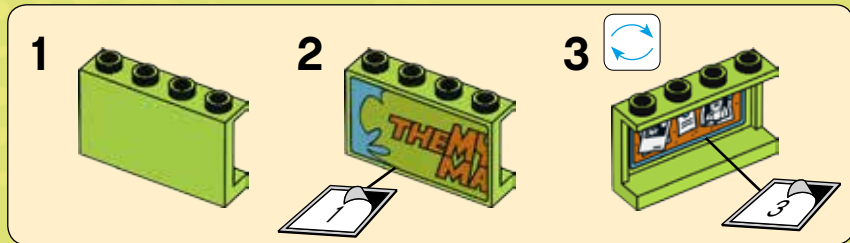

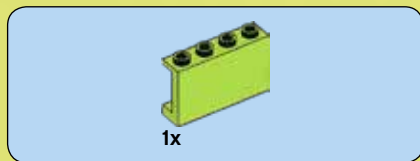

46

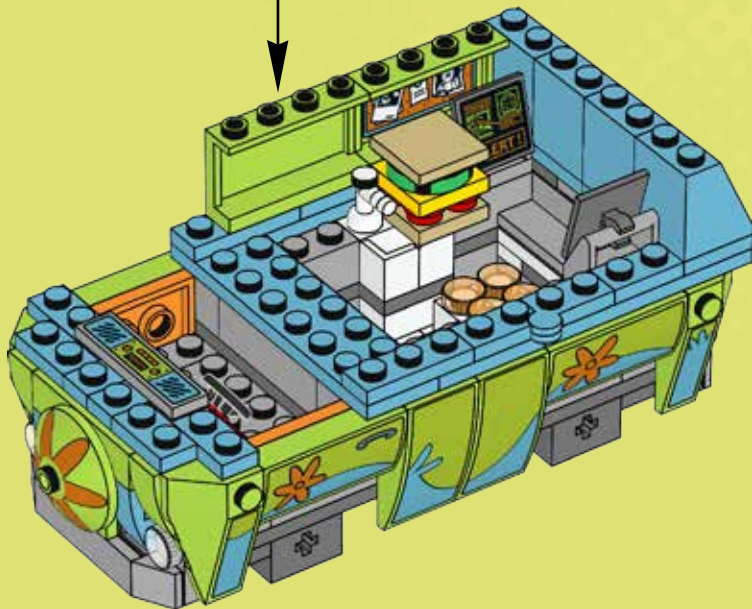
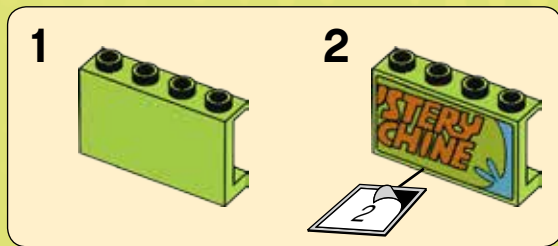



2x



1x



1x



1x

47

1



2

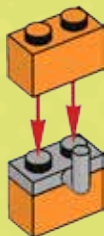

3



4



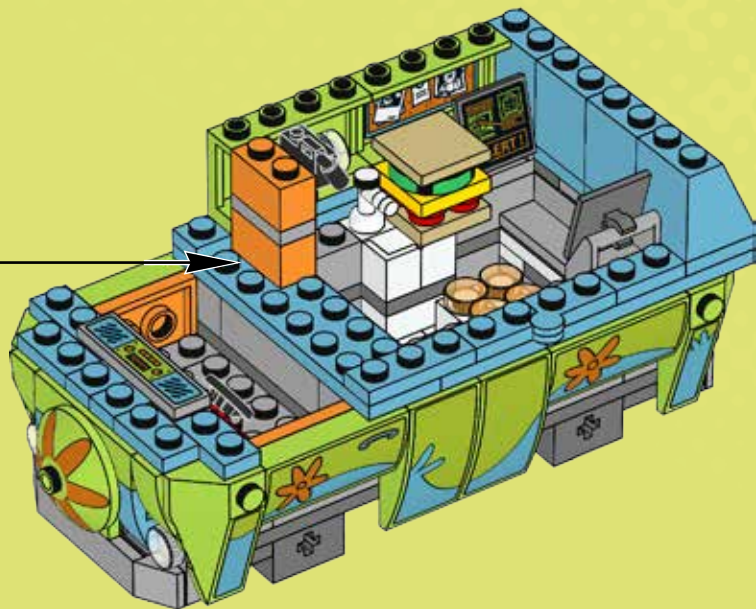



2x



1x



1x



1x

48

1



2

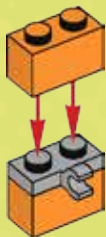

3

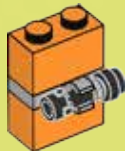

4



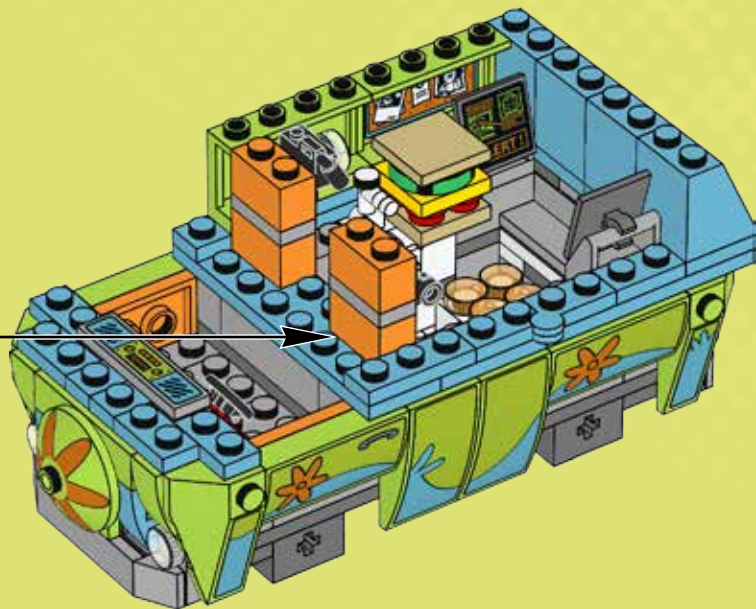

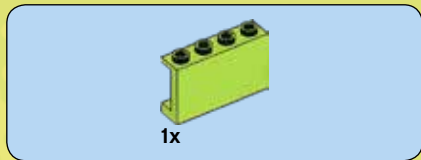

49

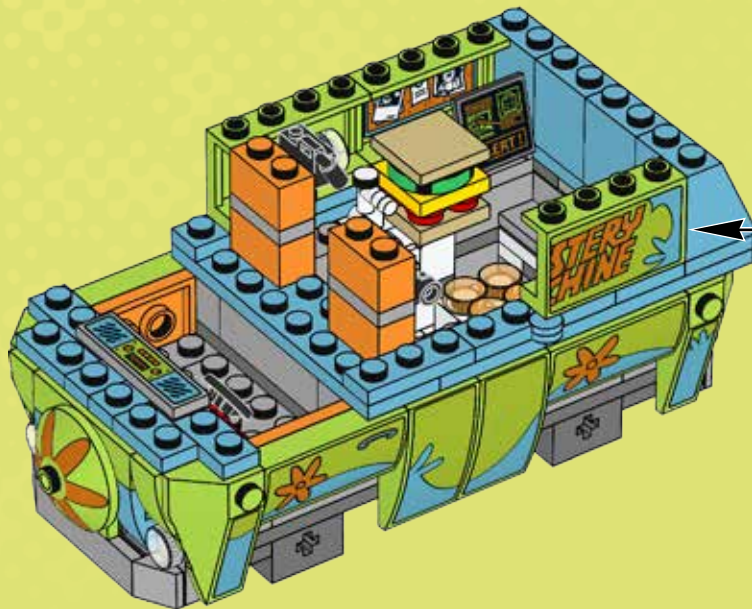

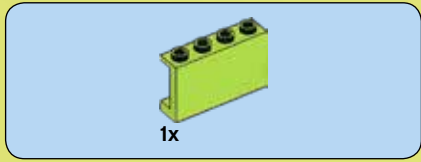

50

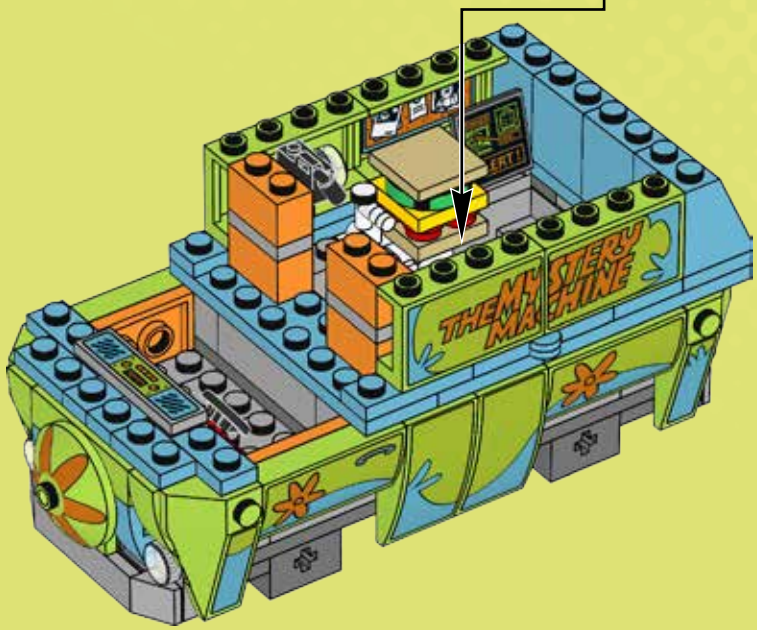
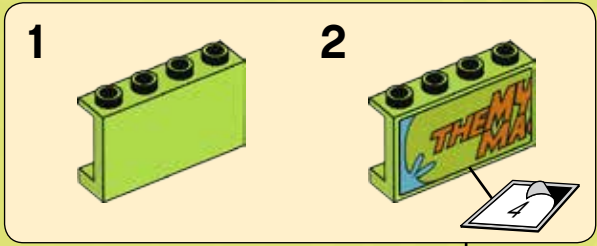



4x

51

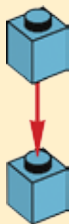

2x

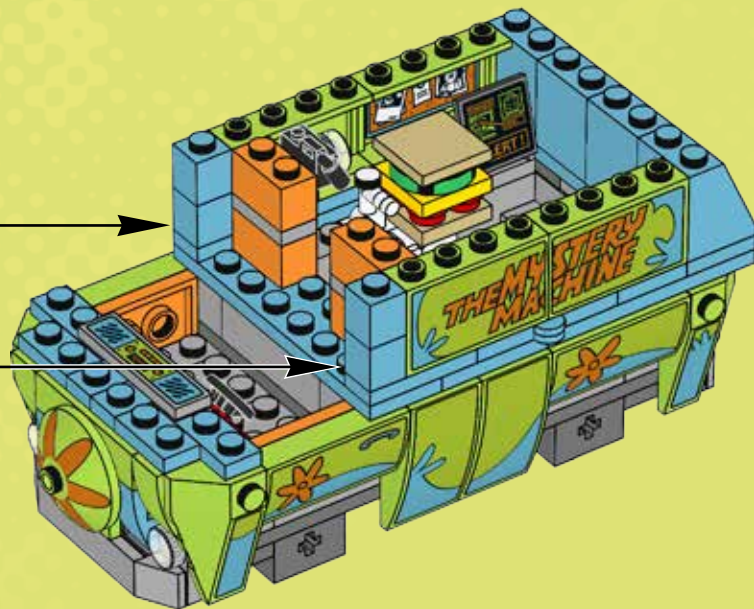

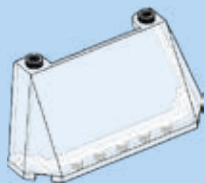

1x

52

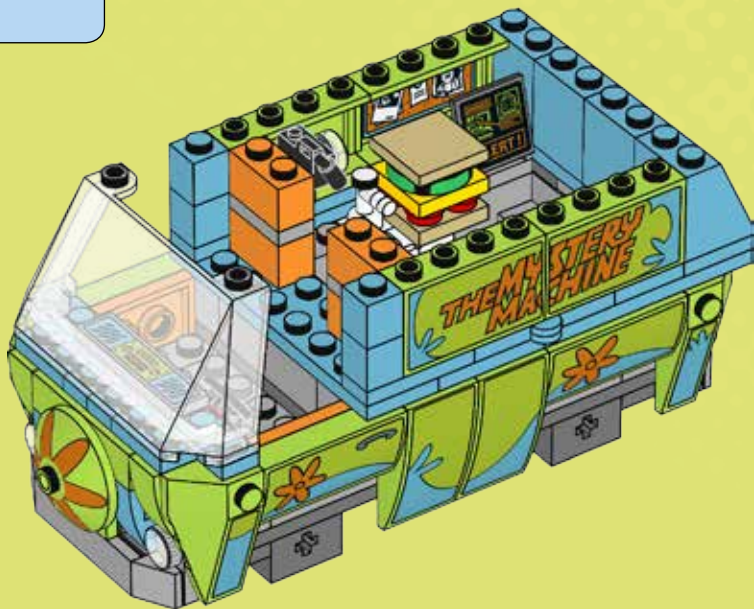



1x



2x

53

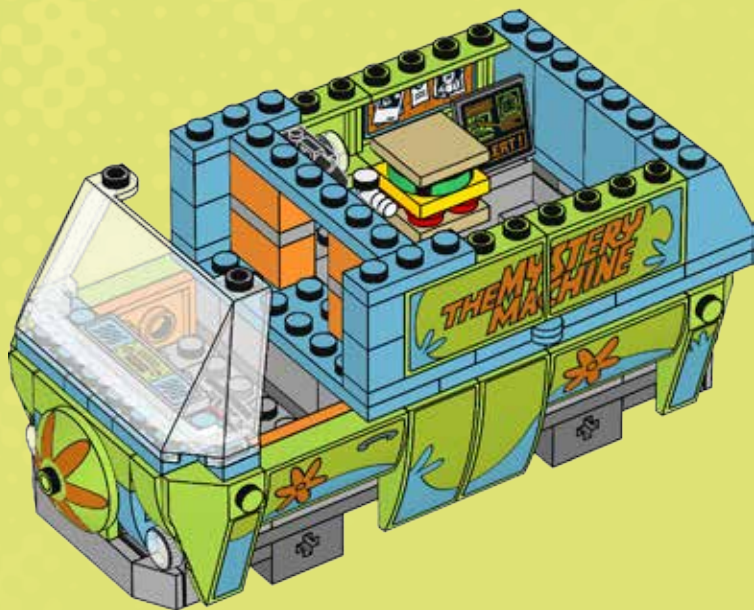



2x



1x

54





2x



1x

55

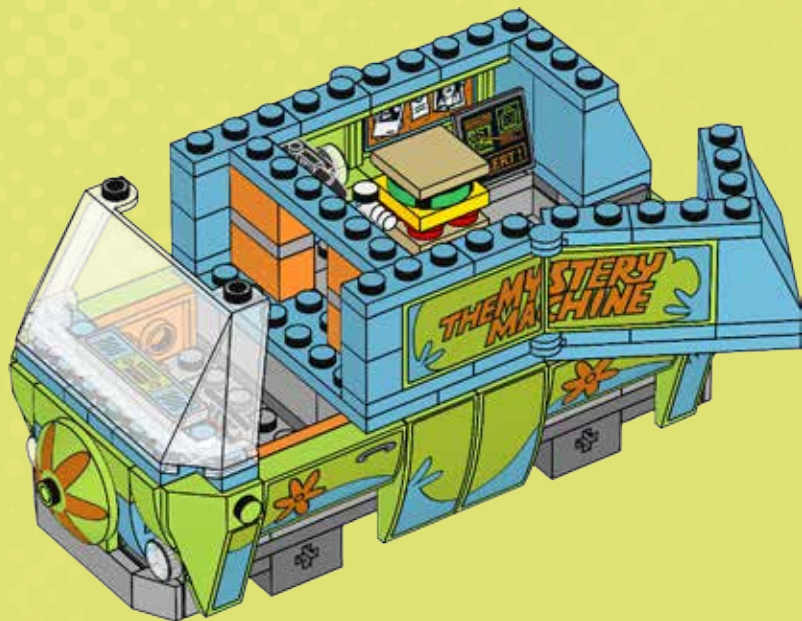



2x

56

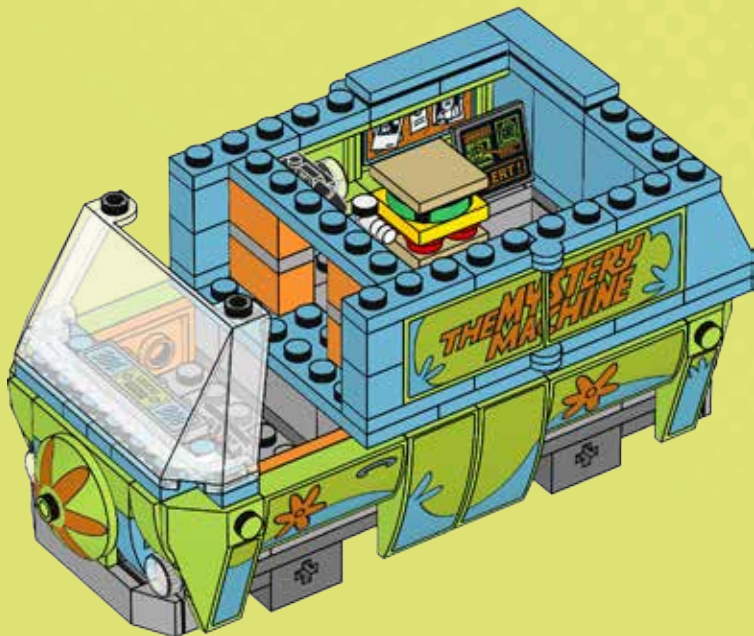



2x

57

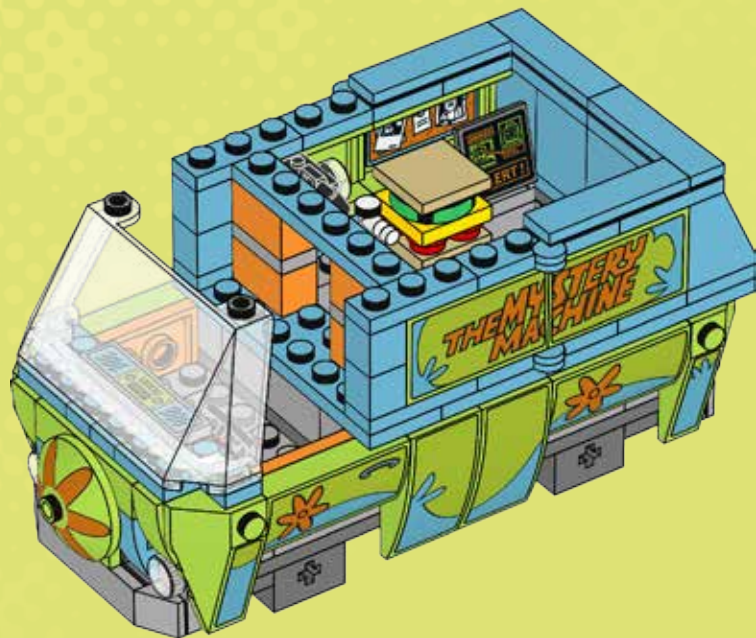



2x



2x

58

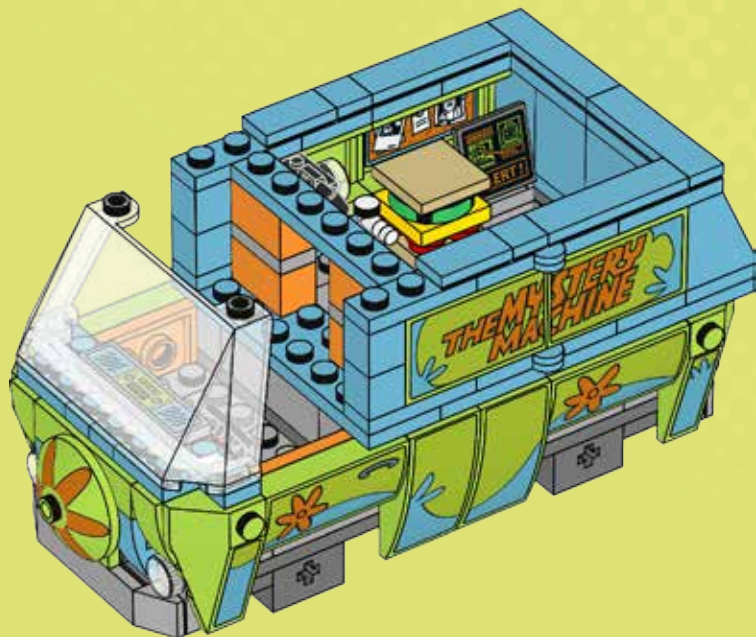



2x



2x

59

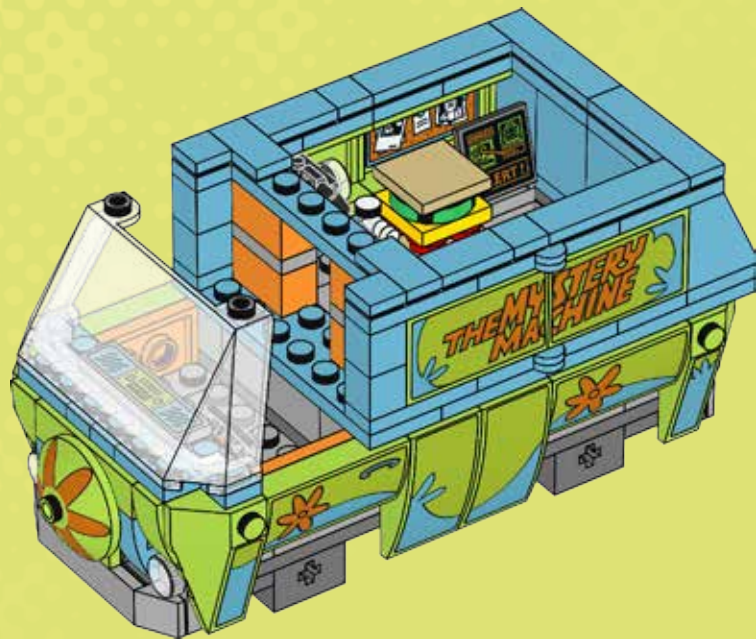



1x



1x

60

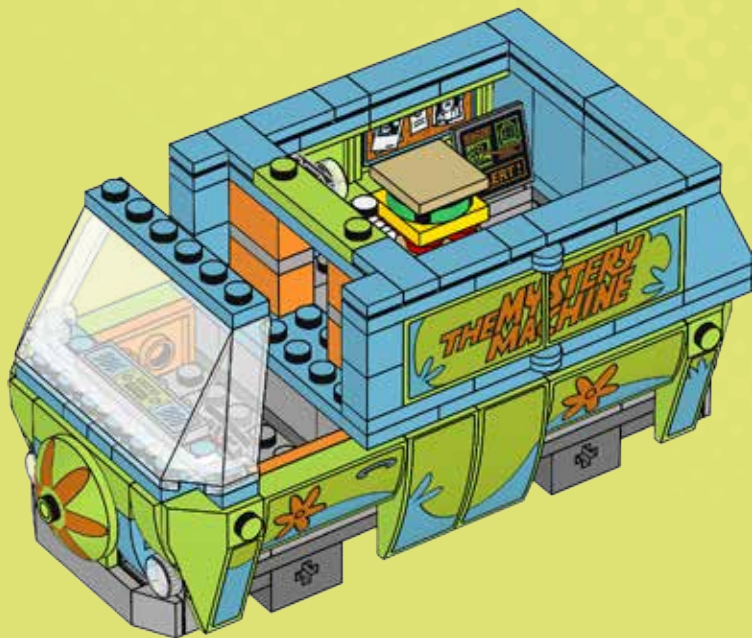



4x



1x



1x



1x



1x

61

1



2



3



4



4x

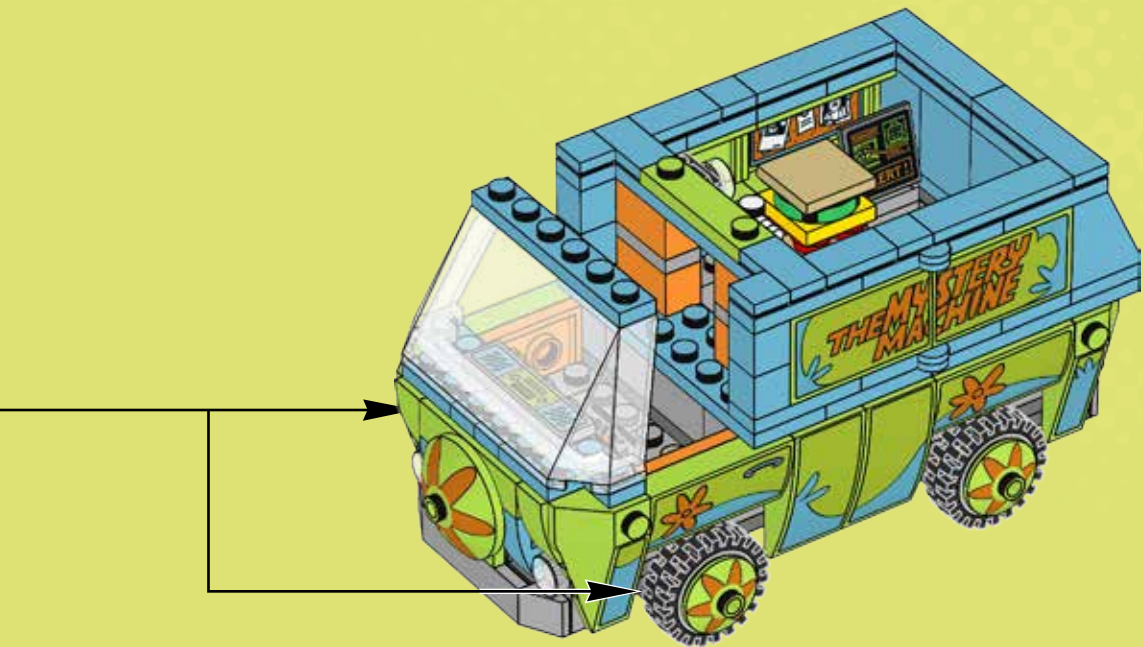

62

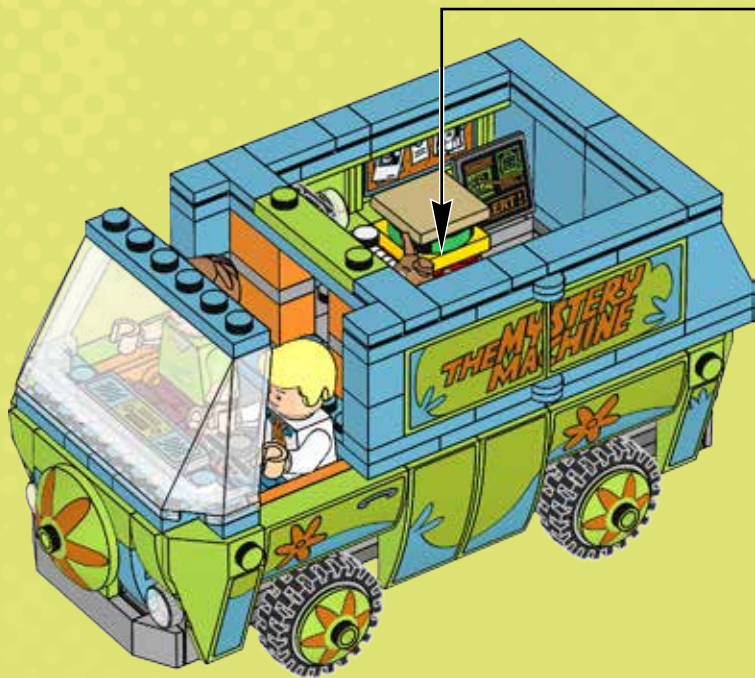

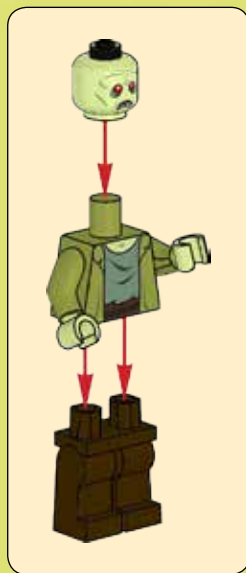

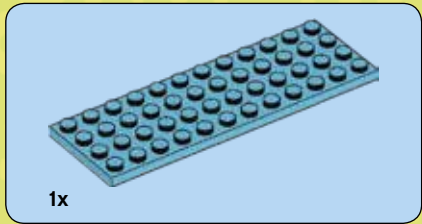
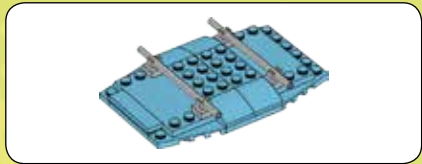

1

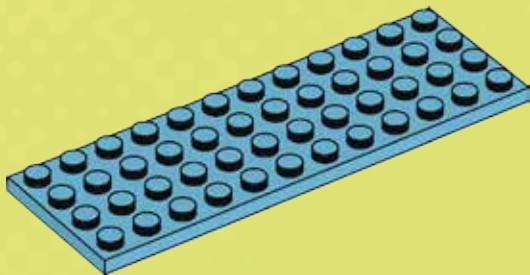

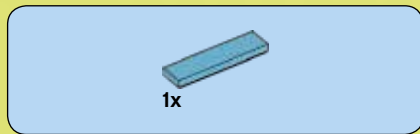

2

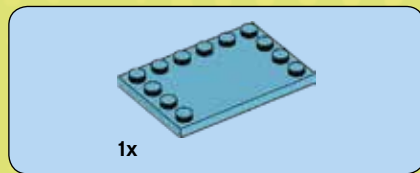
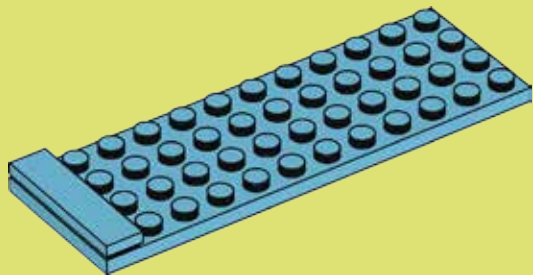

3

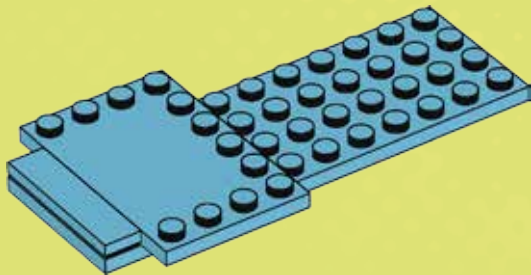

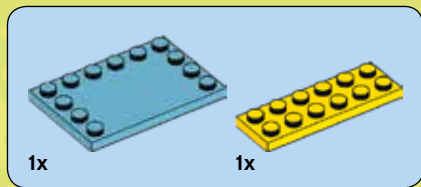

4

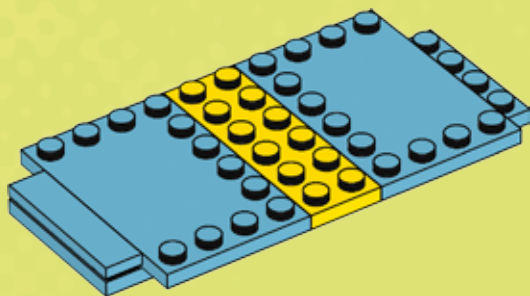

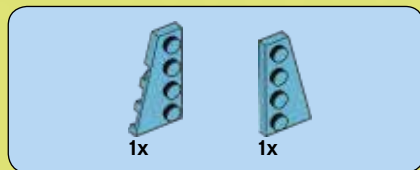

5

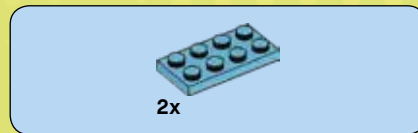
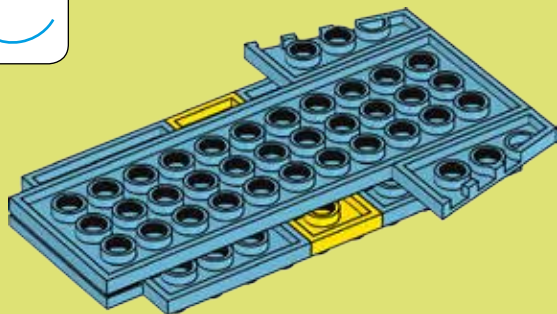
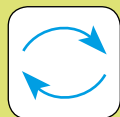

6

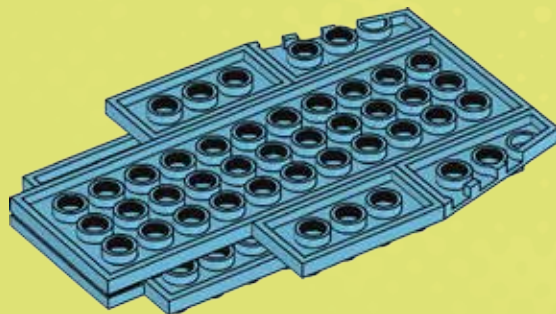



1x



1x

7

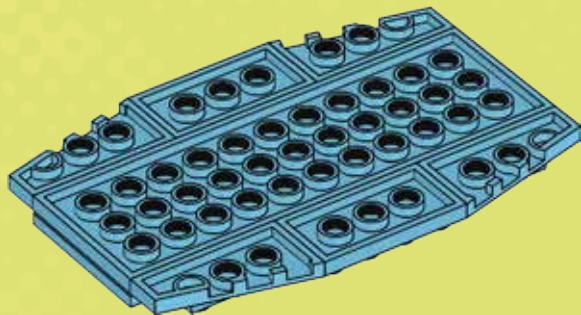



2x

8

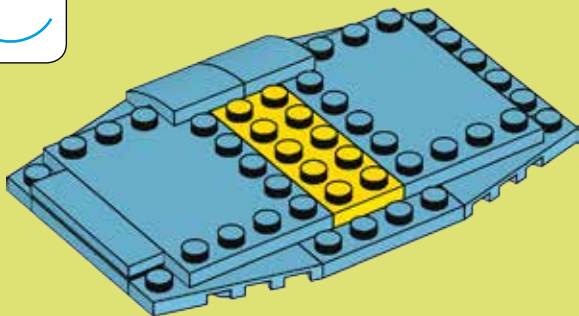

2x

9

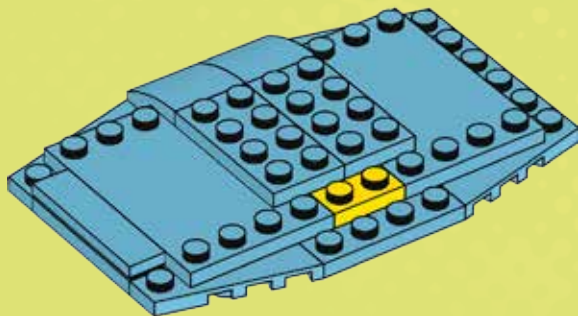



2x

10

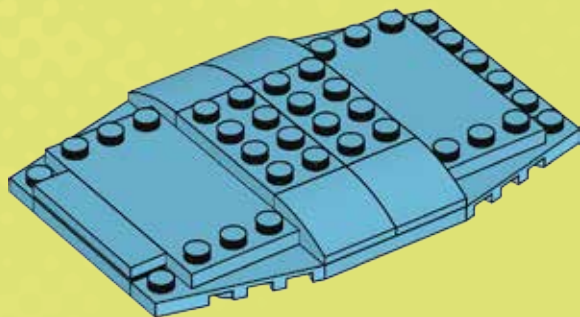



4x

11

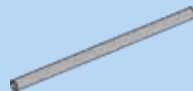
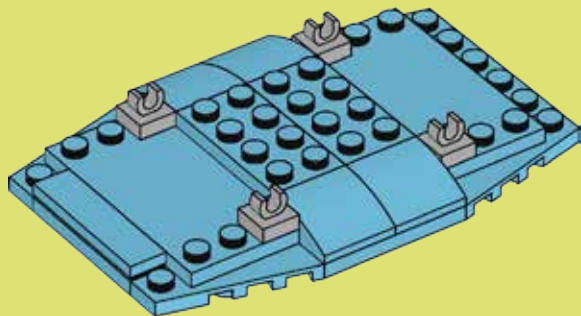

2x

12

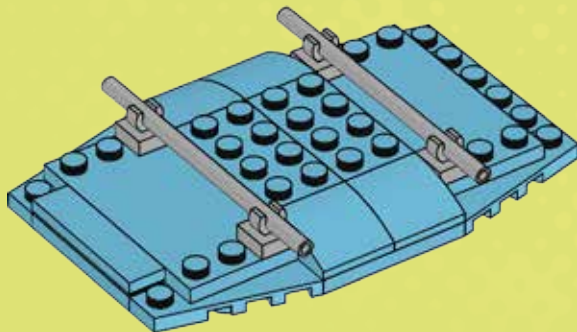

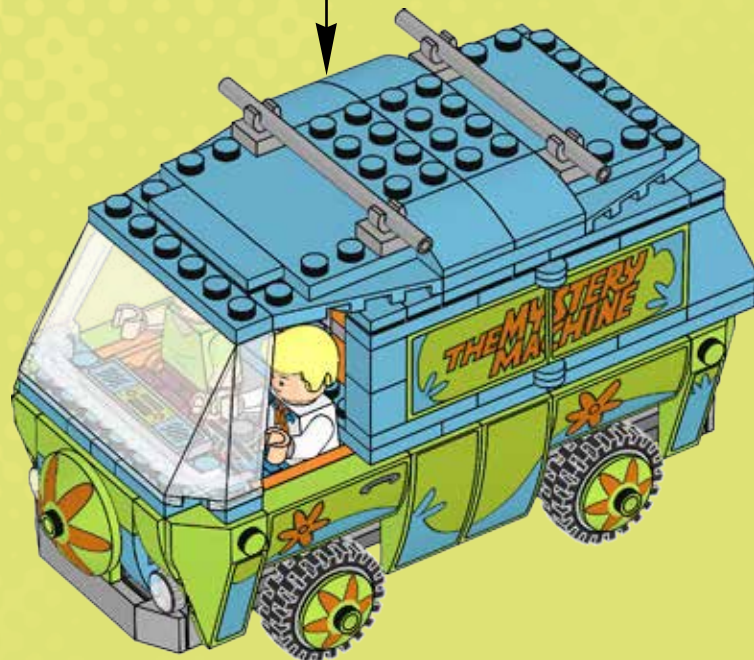



1

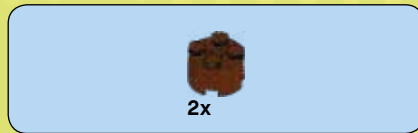

2





1x



1x

3

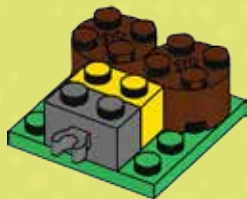

1x



1x

4





2x

5



1x

6





1x

7



2x

8





1x



2x



2x



1x



1x



1x

9

1



2

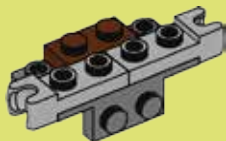

3

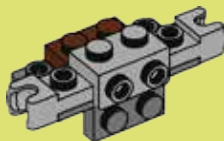

4

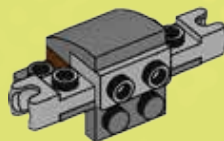

5

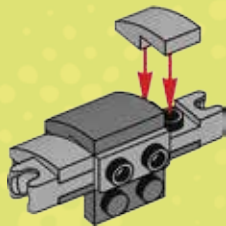

6

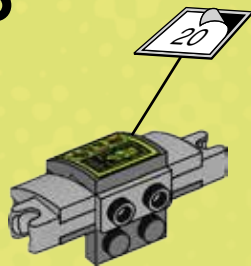



1x

10

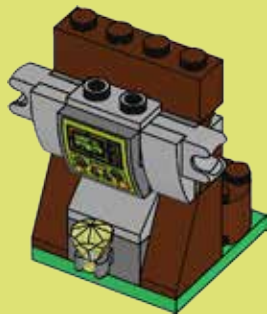

2x

11





12

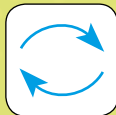



1x

13





2x



2x



2x



2x



2x



2x

14

1



2



3



4



2x

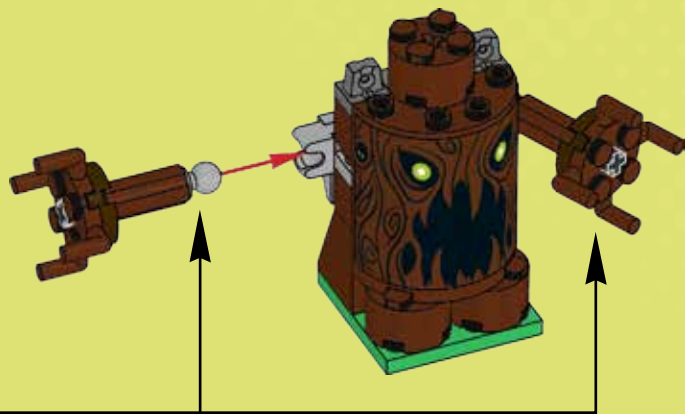



2x

15

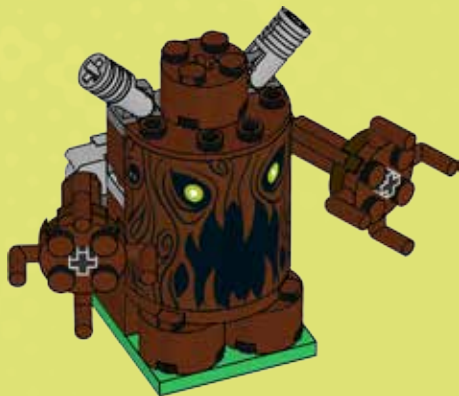

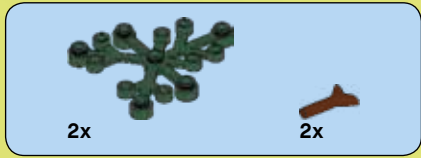

16

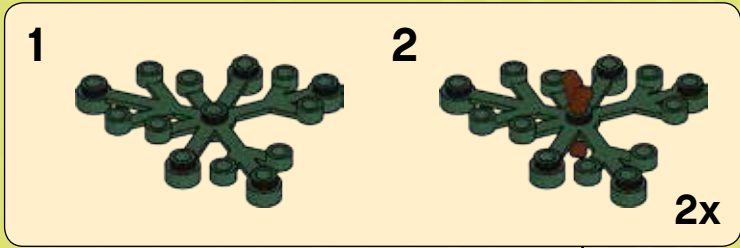

17



 5x 300401	 1x 4114084	 1x 4598897	 4x 4650498	 4x 6069006	 1x 6117683	 2x 4648118	 3x 4211385
 5x 6051511	 4x 6031821	 4x 4541455	 2x 4646864	 5x 6075049	 2x 4505066	 2x 4216581	 4x 4521921
 1x 6123040	 4x 6014616	 2x 4109810	 1x 4114505	 4x 6054531	 1x 4541496	 1x 6123724	 1x 4211410
 2x 302001	 9x 614121	 1x 6012466	 4x 4121739	 1x 4500125	 1x 4541496	 2x 6078605	 2x 6028813
 4x 6046979	 1x 6046379	 1x 4106552	 4x 4125278	 1x 6058127	 4x 4646865	 2x 4531751	 1x 4654046
 2x 623101	 1x 9552	 1x 403228	 1x 4173332	 2x 4164021	 3x 4211166	 2x 4558953	 4x 4211356
 1x 459901	 1x 300424	 1x 4243821	 3x 6078587	 4x 6123823	 2x 4211225	 6x 4211636	 1x 4211445
 1x 6122342	 1x 302224	 1x 6121738	 2x 6109831	 1x 6123822	 2x 4629736	 2x 4514192	 6x 4211452
 1x 4185177	 1x 379524		 2x 6109834	 4x 6109829	 1x 4211150	 2x 4211521	 1x 4211404



Customer Service

Kundenservice

Service Consommateurs

Servicio Al Consumidor

LEGO.com/service or dial



: 00800 5346 5555

: 1-800-422-5346

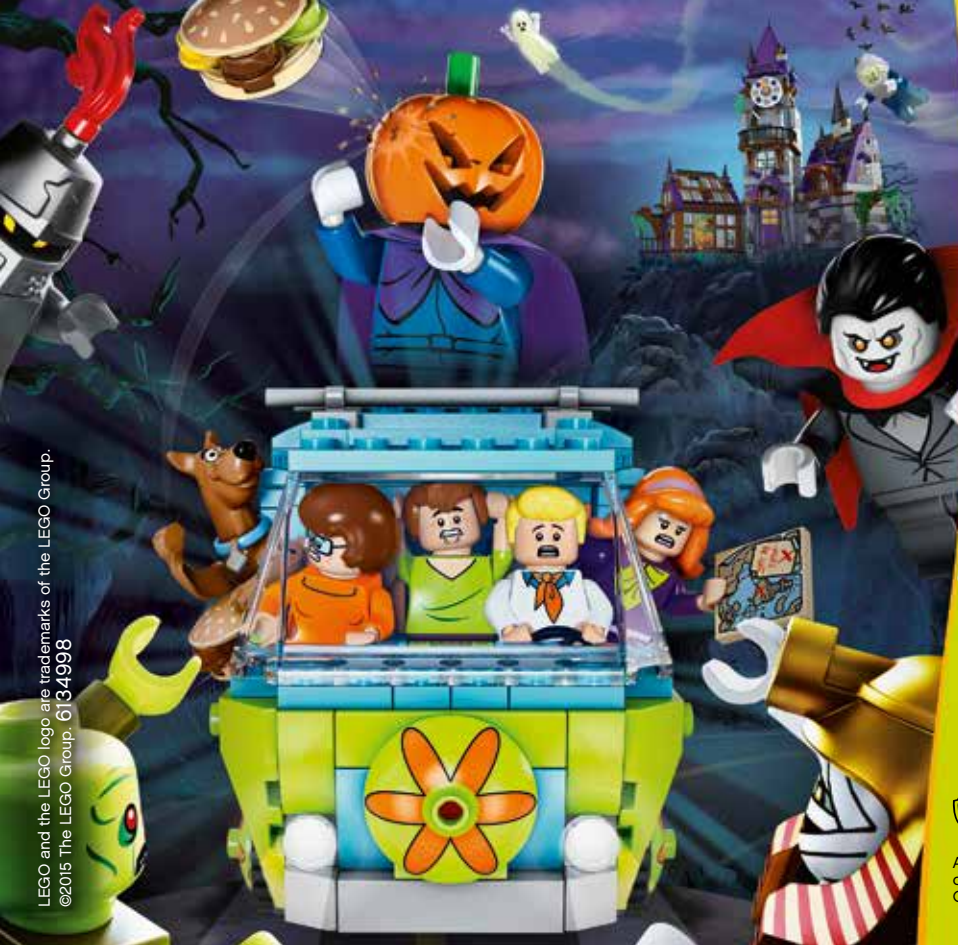

Download Zappar App Scan the page Play Activity!

Zappar App herunterladen
Seite scannen
Spielespaß erleben!

Téléchargez l'application Zappar
Scannez la page
Jouez à l'activité !

Descarga la app Zappar
Escanea la página
¡Juega!

Descarrega a app Zappar
Faz scan da página
Joga com muita ação!

Töltsd le a Zappar appot
Szkemeld be az oldalt
Indítsd a játékot!



TM & © Hanna-Barbera.
WB SHIELD: TM & © Warner Bros. Entertainment Inc.
(s15)

Apple, the Apple logo, iPad, iPhone and iPod touch are trademarks of Apple Inc.
Google Play is a trademark of Google Inc.